

FINEST QUALITY

Union Special[®]
LEWIS • COLUMBIA

**INDUSTRIAL
SEWING
MACHINES**

STYLES

39500 GG

39500 GH

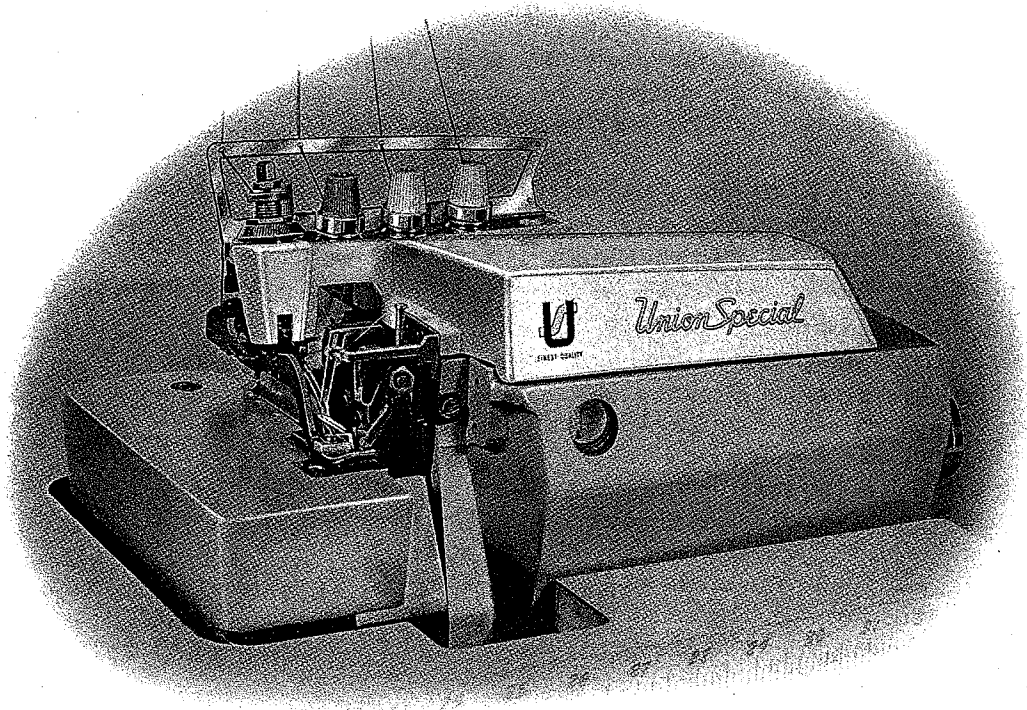

CLASS 39500

CATALOG

No.

103 GG

**HI-STYLED HIGH SPEED
TWO NEEDLE FOUR THREAD
DIFFERENTIAL FEED
SEAMING AND HEMMING MACHINES**

Union Special **MACHINE COMPANY**

CHICAGO

Aid Plant Layout! Boost Production!

PEDESTAL MOUNTED MACHINES

UNION SPECIAL'S pedestal mountings for sewing heads have offered a great many advantages to manufacturers ever since they were introduced as a revolutionary new type of mounting for feed-off-the-arm machines in Classes 35700 and 35800.

In the pedestal mounted type installation, the machine is completely isolated from the base and, where table boards are used, they are completely isolated from the pedestal and from the machine, which makes for smoother, quieter operation. In various cases, the motor may be mounted to the right or to the left under the machine handwheel. Mounting of the motor to the right provides maximum space under machine for the operator.

These new pedestals offer maximum flexibility, convenience, and adaptability to production lines, especially where variations in operation or garment styles are necessary from time to time. The foot treadles are adjustable laterally and the machine mounting bracket is adjustable vertically to suit the individual operator and to provide the most comfortable working position, thus reducing fatigue. The illustrations shown here are just a few of the many styles of machines that Union Special has to offer in the pedestal mounted type installation which manufacturers all over the world have found to be necessary equipment for increasing production.

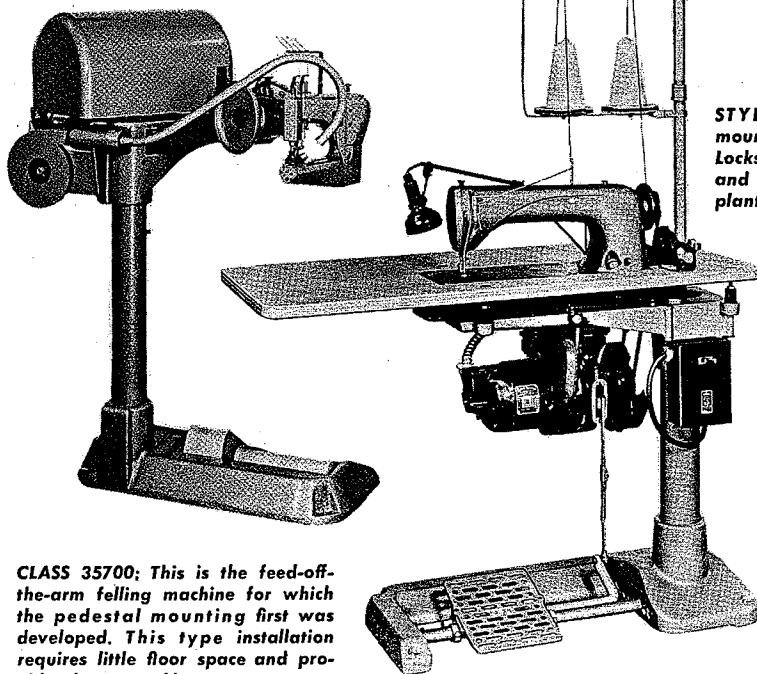

CLASS 35700; This is the feed-off-the-arm felling machine for which the pedestal mounting first was developed. This type installation requires little floor space and provides large working area.

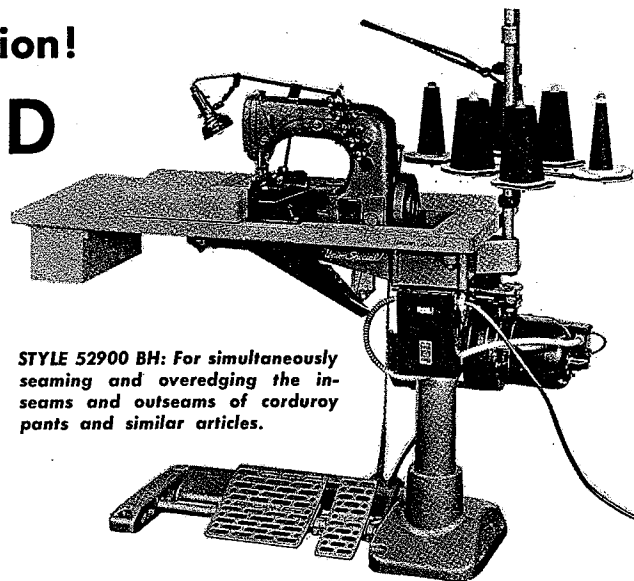

STYLE 52900 BH: For simultaneously seaming and overedging the in-seams and outseams of corduroy pants and similar articles.

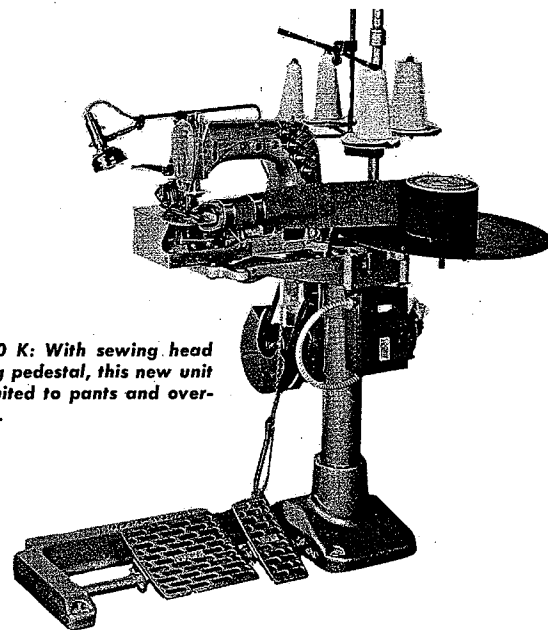

STYLE 54200 K: With sewing head overhanging pedestal, this new unit is ideally suited to pants and over-all banding.

STYLE 61400 A: The pedestal mounted, plain feed, single needle Lockstitch makes a most flexible and versatile unit for any sewing plant.

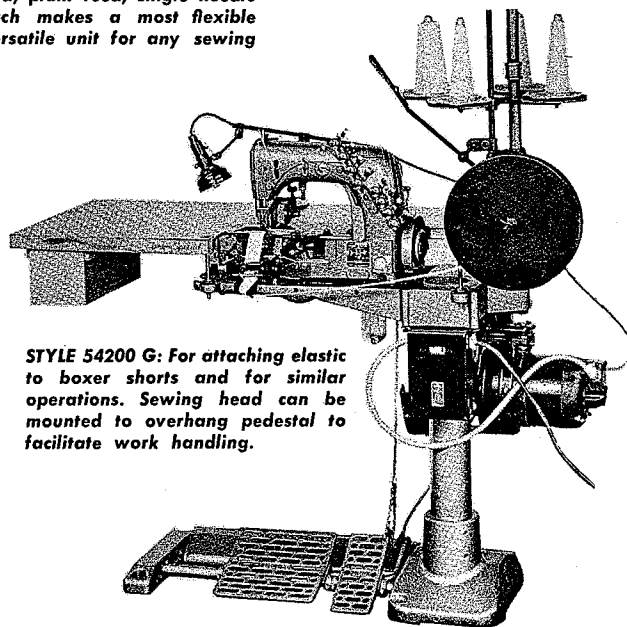

STYLE 54200 G: For attaching elastic to boxer shorts and for similar operations. Sewing head can be mounted to overhang pedestal to facilitate work handling.

Catalog No. 103 GG
(Supplement to Catalog No. 103 FA)

INSTRUCTIONS
FOR
ADJUSTING AND OPERATING

LIST OF PARTS

CLASS 39500

Styles

39500 GG

39500 GH

First Edition

Copyright 1967

By

Union Special Machine Co.
Rights Reserved in All Countries

Union Special
MACHINE COMPANY
INDUSTRIAL SEWING MACHINES
CHICAGO

Printed in U. S. A.

November, 1967

IDENTIFICATION OF MACHINES

Each Union Special machine is identified by a Style number on a name plate on the machine. Style numbers are classified as standard and special. Standard Style numbers have one or more letters suffixed, but never contain the letter "Z". Example: "Style 39500 GG". Special Style numbers contain the letter "Z". When only minor changes are made in a standard machine, a "Z" is suffixed to the standard Style number. Example: "Style 39500 GGZ".

Styles of machines similar in construction are grouped under a Class number which differs from the Style number in that it contains no letters. Example: "Class 39500".

APPLICATION OF CATALOG

This catalog is a supplement to Catalog No. 103 FA and should be used in conjunction therewith. Only those parts used on Styles 39500 GG and GH, but not on Style 39500 FP are illustrated and listed at the back of this catalog. On the page opposite the illustration will be found a listing of the parts with their part numbers, description and the number of pieces required. Numbers in the first column are reference numbers only, and merely indicate the position of that part in the illustration. Reference numbers should never be used in ordering parts. Always use the part number listed in the second column.

This catalog applies specifically to the standard Style of machine as listed herein. It can also be applied with discretion to some Special Styles of machines in Class 39500. References to directions, such as right, left, front, back, etc., are given from the operator's position while seated at the machine. Operating direction of handwheel is away from operator.

STYLE OF MACHINE

Hi-Styled High Speed, Two Curved Blade Needles, Two Loopers, Four Thread Overseaming Machines. Upper Looper Thread is Caught by Both Needles. Differential Feed, Trimming Mechanism with Spring Pressed Lower Knife, Automatic Lubricating System.

39500 GG Medium to heavy duty machine for decorative hemming of medium weight baby blankets and for similar operations on articles of medium weight woven materials. Hem is turned up with the roll extending to the right needle. Adjustable turned up hemming scroll on right side of presser foot. Seam Specification 514-EFe-1. Standard seam width approximately $17/64$ inch from left needle. Stitch range 6-15 per inch. Cam adjusted main and differential feeds. Maximum recommended speed 6500 R. P. M.

39500 GH Medium to heavy duty machine for seaming operations on coat linings, pockets, bathing suits, house dresses, children's wear, ladies undergarments, and similar garments of light to medium weight woven and knitted materials of cotton, wool, silk and synthetics. Seam specification 514-SSa-1. Standard seam width approximately $17/64$ inch from left needle. Stitch range 6-15 per inch. Cam adjusted main and differential feeds. Maximum recommended speed 6500 R. P. M.

OILING

CAUTION! Oil was drained from machine when shipped, so reservoir must be filled before beginning to operate. Oil capacity of Class 39500 is six ounces. A straight mineral oil of a Saybolt viscosity of 200 to 250 seconds at 100° Fahrenheit should be used.

OILING (Continued)

Machine is filled with oil at spring cap in top cover. Oil level is checked at sight gauge on front of machine. Red bulb on oil level indicator should show between gauge lines when machine is stationary.

Machine is automatically lubricated. No oiling is necessary, other than keeping main reservoir filled. Check oil daily before the morning start; add oil as required.

The oil drain plug screw is located at back of machine near bottom edge of base. It is a magnetic screw designed to accumulate possible foreign materials which may have entered the crank case. It should be removed and cleaned periodically.

NEEDLES

Each Union Special needle has both type and size number. The type number denotes the kind of shank, point, length, groove, finish and other details. The size number, stamped on the needle shank, denotes largest diameter of blade, measured in thousandths of an inch, midway between shank and eye. Collectively, type and size number represent the complete symbol which is given on the label of all needles packaged and sold by Union Special.

Class 39500 machines use a curved blade needle. The standard recommended needle for Styles 39500 GG and GH is Type 154 GAS. Below is the description and sizes available of the recommended needle.

<u>Type No.</u>	<u>Description and Sizes</u>
154 GAS	Round shank, round point, curved blade, standard length, single groove, struck groove, spotted, chromium plated and is available in sizes 022, 025, 027, 029, 032, 036, 040, 044, 049, 054.

To have needle orders promptly and accurately filled, an empty package, a sample needle, or the type and size number should be forwarded. Use description on label. A complete order would read: "1000 Needles, Type 154 GAS, Size 040".

Selection of proper needle size is determined by size of thread used. Thread should pass freely through needle eye in order to produce a good stitch formation.

Success in the operation of Union Special machines can be secured only by use of needles packaged under our brand name, *Union Special*, which is backed by a reputation for producing highest quality needles in materials and workmanship for more than three-quarters of a century.

CHANGING NEEDLES

Release pressure on presser foot by turning presser foot release bushing (AG, Fig. 1) and swing presser arm (U) out of position. Turn handwheel in operating direction until needles are at their lowest point of travel. Using hexagonal socket wrench No. 21388 AU, furnished with machine, loosen needle clamp nut about 1/4 turn. Again turn handwheel until needles are at high position. Withdraw needles.

To replace needles, leave needle holder at high position and with the flats to the left, insert needles in holder until they rest against stop pin. Keeping needles in this position, turn handwheel until holder is again at its low point of travel; then tighten nut. Return presser arm (U) to position; re-lock presser foot release bushing (AG)

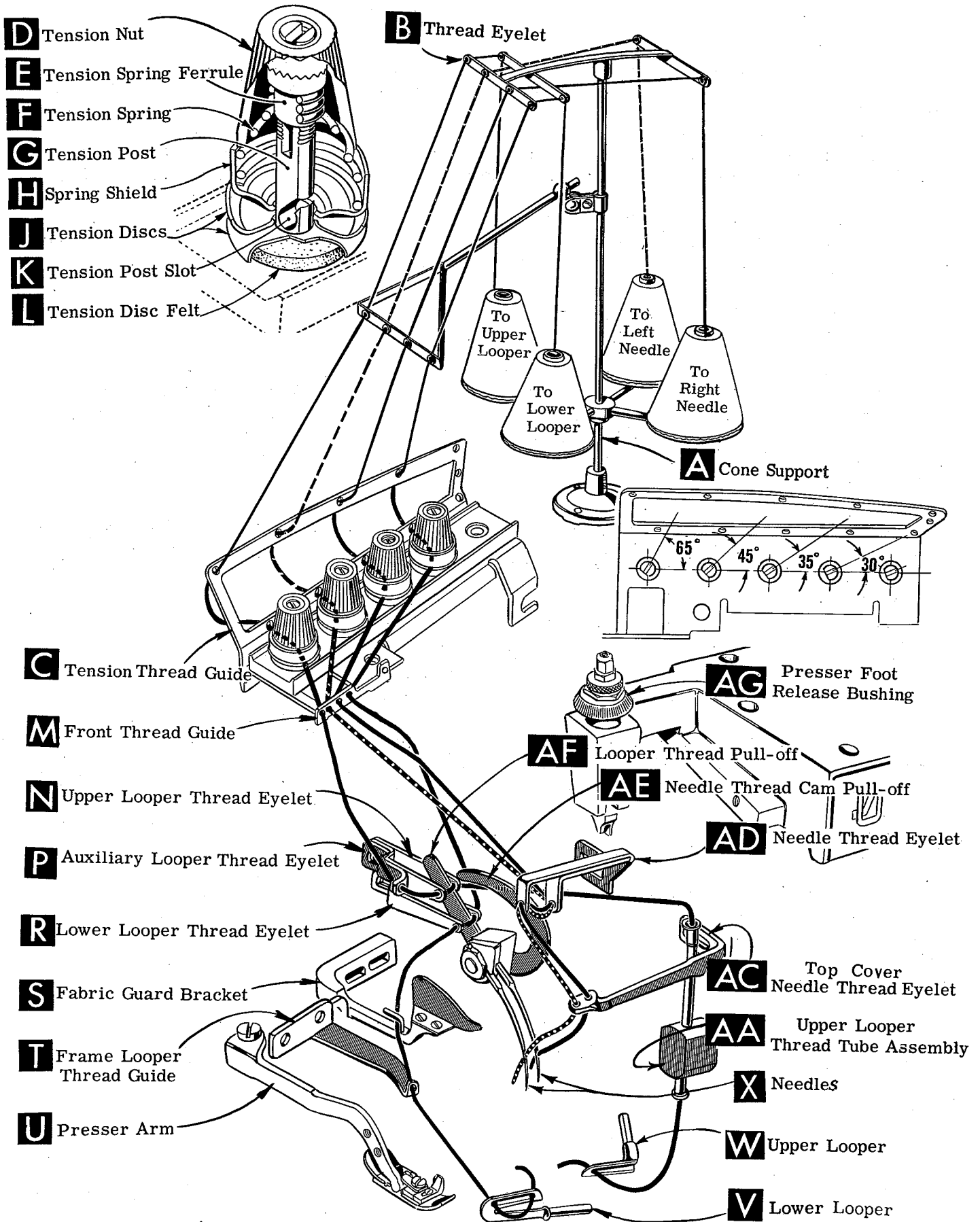

Fig. 1

THREAD STAND

After thread comes from cones on cone support (A, Fig. 1), the needle threads are threaded through the back bar of the thread eyelet (B), under the middle bar and through the center holes of the front bar. The looper threads come from the cones, through holes of the middle bar from back to front and then through the two outside holes of the front bar. Next it is threaded through the upper holes of tension thread guide (C) front to back and then through the lower holes from back to front. The threads continue between the tension discs (J), through tension post slot (K) in tension post (G) and on through front thread guide (M).

THREADING

Only parts involved in threading are shown in the threading diagram (Fig. 1). Parts are placed in their relative positions for clarity.

It will simplify the threading of these machines to follow the recommended sequence of threading lower looper first, upper looper second, and needles third.

Before beginning to thread, swing cloth plate open, turn handwheel in operating direction until needles (X) are in high position, release pressure on presser foot by turning presser foot release bushing (AG), and swing presser arm (U) out of position.

Be sure threads, as they come from the tension thread guide (C) are between tension discs (J) and in diagonal slots (K) in tension posts (G). The tension posts should be positioned so the tension post slot will be at the approximate angle for the different threads as indicated in Fig. 1.

TO THREAD LOWER LOOPER

Double end of thread and lead it through both eyes of lower looper thread eyelet (R, Fig. 1) from right to left. NOTE: thread must pass in front of looper thread pull-off (AF). Lead thread behind fabric guard (S) and through eyelet hole of frame looper thread guide (T). Turn handwheel in operating direction until heel of lower looper (V) is all the way to the left; then thread through both eyes from left to right. Left eye of lower looper can be threaded easily if tweezers are in left hand.

TO THREAD UPPER LOOPER

Turn handwheel until point of upper looper (W) is all the way left. Lead thread through auxiliary looper thread eyelet (P) from back to front, then through both eyes of upper looper thread eyelet (N) from left to right. NOTE: Thread must pass in front of looper thread pull-off (AF). After pulling up upper looper thread tube assembly (AA), lead thread under neck of top cover casting and down through thread tube assembly (AA). Pull thread out bottom of tube; push tube down, then insert thread through upper looper eye from front to back.

CAUTION! Be sure upper looper thread is under lower looper thread when passing from tube assembly to upper looper eye.

TO THREAD NEEDLES

Turn handwheel in operating direction until needles (X) are at their highest position. Insert both needle threads from right to left, through BOTH eyes of needle thread eyelet (AD), under neck of top cover casting and down through holes in top cover needle thread eyelet (AC). The right needle thread should be threaded in the right hole and the left needle thread through the left hole of the top cover needle thread eyelet. Thread needles from the front.

THREAD TENSION

The amount of tension on needle and looper threads is regulated by tension nuts (D, Fig. 1). Tension on threads should be only enough to secure proper stitch formation.

PRESSER FOOT PRESSURE

Sufficient presser foot pressure to feed work uniformly should be maintained. Should it be necessary to increase or decrease amount of pressure on presser foot, loosen lock nut (A, Fig. 2) and turn adjusting screw (B). Adjusting screw has a right hand thread so tightening increases pressure, loosening decreases pressure. When pressure adjusting screw (B) has been properly set, tighten lock nut (A). With presser foot resting on throat plate, position locking nut (C) so that its under surface is approximately 1/32 inch to 1/16 inch from the top surface of adjusting screw (B). Set cap (D) against locking nut (C).

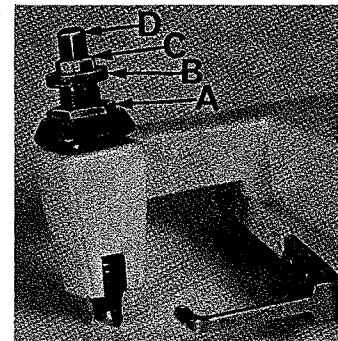

Fig. 2

FEED ECCENTRICS

Feed eccentrics used in machine Style 39500 GG have been selected to produce approximately 8 stitches per inch. On machine Style 39500 GH the feed eccentrics have been selected to produce approximately 10 stitches per inch. It will be noted that on Style 39500 GG that the part number of both the main and differential feed eccentric is No. 39540 B-8. On Style 39500 GH the part number of the main feed eccentric is No. 39540 B-12, while the part number of the differential feed eccentric is No. 39540 B-10. Minor numbers of the part symbol indicate approximately the number of stitches obtainable when using that eccentric. Unless otherwise specified, machines will be shipped with the above combination of eccentrics.

Generally speaking, differential (right hand) feed eccentric determines number of stitches produced. Main (left hand) feed eccentric is selected in relation to degree and direction of stretch of material being sewn, or type of operation.

Following stitch number feed eccentrics are available under No. 39540 B-4, -5, -6, -7, -8, -9, -10, -11, -12, -13, -14, -15, -16, -18, -20, -22, -24, -26, -28, -30, -32, -34, -36, -40, -50, -60, -70, -100. Only two eccentrics are supplied with each machine. Additional eccentrics may be ordered separately. To order, use No. 39540 B with a minor number suffixed to indicate number of stitches desired. Example: "39540 B-8".

ASSEMBLING AND ADJUSTING SEWING PARTS

Before assembling and adjusting sewing parts, remove cloth plate, fabric guard, chip guard, upper knife assembly, lower knife holder assembly. Then, follow this suggested sequence:

SETTING THE NEEDLE

With throat plate assembled in position, needles should center in the front end of needle slots. When needles are at high position, needle points should be set 31/64 inch above throat plate (Fig. 3). To align or set the height above the throat plate, move needle driving arm (A, Fig. 3) by loosening clamp screw (B). Remove throat plate, after needle has been set properly and clamp screw (B) has been tightened.

SETTING THE NEEDLE (Continued)

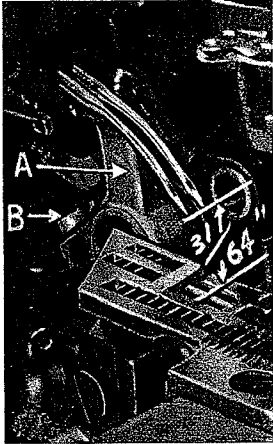

Fig. 3

If needle thread cam pull-off (A, Fig. 4) overlaps looper thread pull-off (B), separate by moving looper thread pull-off to back. When re-tightening looper pull-off screw, be sure to take up end play in needle driving arm.

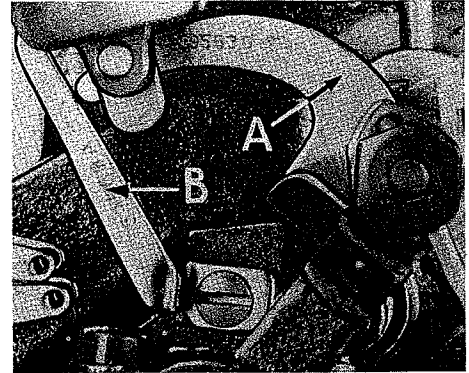

Fig. 4

At this point, insert lower looper (A, Fig. 5) into bar (B). With the lower looper at the left end of its stroke, set looper point $1/16$ inch from center of left needle (Fig. 5), using looper gauge No. 21225- $1/16$. Do not have lower looper deflecting needle. Tighten nut (C).

Now assemble differential (front) feed dog.

SETTING THE REAR NEEDLE GUARD

Set rear needle guard (A, Fig. 6) as high as possible, without interfering with either lower looper or movement of lower knife holder, but still in position to deflect needles forward $.002$ -. $.004$ inch. Screw (B) is used to set rear needle guard. Make sure there is no interference between rear needle guard and lower looper.

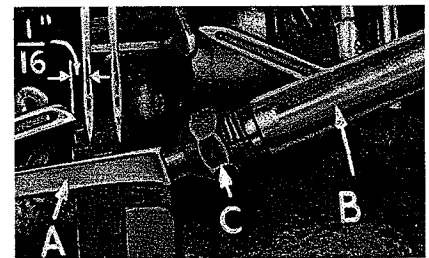

Fig. 5

SETTING THE LOWER LOOPER

Now, finish lower looper adjustment. As lower looper moves to the right, its point should be set into the scarf of the left needle (A, Fig. 7) until the needles spring forward from rear guard surface another $.002$ -. $.004$ inch.

SETTING THE FRONT NEEDLE GUARD

Assemble front needle guard (C, Fig. 6). When lower looper is springing needles off rear needle guard, set front needle guard as close as possible to needles without touching. Screw (D) is used to adjust and set front needle guard. After this setting, make sure there is no interference between needle guards and differential feed dog.

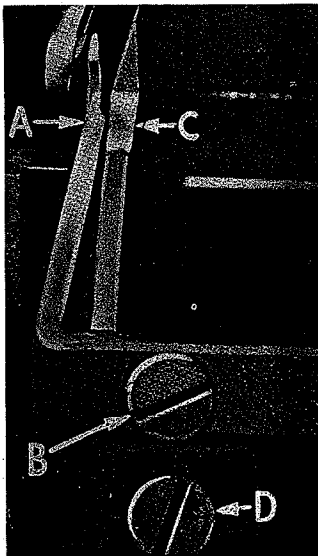

Fig. 6

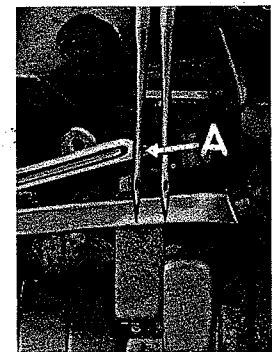

Fig. 7

SETTING THE UPPER LOOPER

Insert upper looper (A, Fig. 8) in its holder. Screw (B) holds upper looper in its holder, and permits it to be pushed in or out, or turned around its shank. Insert upper looper holder into upper looper shaft, if it is not already in place. Screw (C) on clamp holds the upper looper holder in the shaft. Locate upper looper in its holder so that the shank extends $1/8$ inch beyond holder.

SETTING THE UPPER LOOPER (Continued)

When the upper looper is at the right end of its stroke, upper looper holder should be set to position upper looper shank slightly back of vertical (Fig. 8).

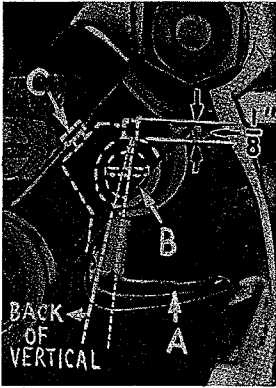

Fig. 8

By adjusting looper holder in or out of upper looper shaft and by turning the looper around its shank, set upper looper point to cross lower looper to the left of the lower looper eye with .002 to .004 clearance (Fig. 9).

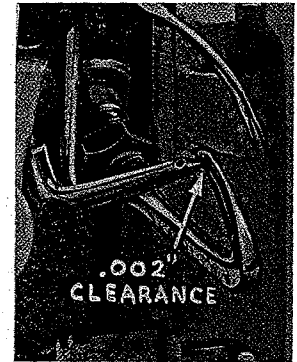

Fig. 9

Next, turn the handwheel until upper looper is at the left end of its travel. Check dimensions of upper looper point with respect to the left needle and throat plate (Fig. 10). If resetting is necessary, do it by moving the upper looper holder (A, Fig. 10). Figure 10 represents the correct dimensional setting.

Dimension $39/64$ inch is increased by turning upper looper holder counterclockwise looking from left end of machine. Dimension $3/16$ inch is increased by pulling upper looper holder to the left, out of the upper looper shaft. After these changes are made, it may be necessary to turn the upper looper around its shank slightly to maintain the condition shown in Fig. 9.

Check setting to avoid interference between upper looper and needle on needle downstroke. If needle rubs the back of upper looper, pull looper out of its holder slightly and rotate looper a short distance counter-clockwise, looking from left end of machine. Reset to maintain dimensions of Figs. 9 and 10.

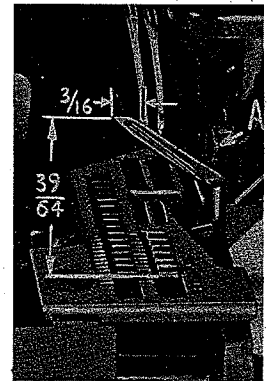

Fig. 10

SETTING THE FEED DOGS

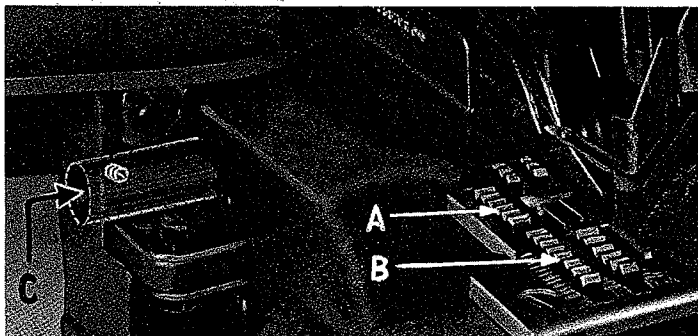

Fig. 11

Assemble the main and differential feed dogs (A, B, Fig. 11). Main and differential feed dogs should be leveled with respect to the throat plate by rotating feed tilting adjusting pin (C). This pin raises or lowers the back end of the feed bar.

The feed dogs should be set level at the time the teeth first appear above the throat plate. Screw (D) locks feed tilting adjusting pin in place. With the feed dogs at their highest point of travel, the top of the teeth on the main and differential feed dogs (A, B) should be $3/64$ inch above the throat plate. The chaining feed dog is made as on integral part of the main feed dog.

SETTING THE LOWER KNIFE

Replace lower knife holder assembly. Lower knife (A, Fig. 12) should be set with cutting edge flush with throat plate surface. Adjustments are made with hexagonal head screw which holds lower knife. Lower knife is spring pressed against upper knife, so no lateral adjustment is necessary when width of trim is changed.

SETTING THE LOWER KNIFE (Continued)

Lower knife may be secured in any position by tightening screw (B) and locking nut (C) against support bracket. Because screw (B) also serves as latch pin for the cloth plate latch spring, it should always be locked with nut (C) even when screw is not tightened against lower knife holder.

SETTING THE UPPER KNIFE

Replace upper knife assembly. Clamp upper knife (D, Fig. 12) in position, setting nut (E) to hold clamp (F) in its most clockwise position against upper knife. Upper knife chain guard (J) should be positioned so that the guarding section is approximately 1/64 inch behind the cutting edge and in contact with the top surface of the upper knife.

At the bottom of its stroke, front cutting edge of upper knife should extend not less than 1/64 inch below cutting edge of lower knife.

After upper knife has been set for the proper width of trim, screw (G) must be tightened to lock the upper knife holding block (H) in place. This will simplify resetting when upper knife is replaced.

SETTING THE STITCH LENGTH

Length of stitch is determined by the combination of feed eccentrics used. Outer (left) eccentric (A, Fig. 13) actuates main (rear) feed dog; while the inner (right) eccentric (B) actuates the differential (front) feed dog.

In assembling the feed eccentrics, be sure hubs are facing each other. Be careful not to damage shaft or key. Tighten nut (C) securely.

To change feed eccentrics, remove nut (C) and washer (D) from end of shaft (E). Turn handwheel in operating direction until key slot in eccentric is toward the front. Using hooked eccentric extractor (F), supplied with machine, reach behind eccentrics as shown and withdraw eccentrics. It may be necessary to move handwheel back and forth slightly during extraction.

If eccentrics are unusually tight fitting, in addition to removing nut (C) and washer (D) (Fig. 14) from shaft (E), it may be helpful to remove nut (G) and feed driving connection (H). Then continue as originally suggested.

SETTING THE PRESSER FOOT

Assemble the presser foot to presser arm. With needle in high position, swing presser arm into sewing position and set the presser foot to align needle holes (front and back) and flat on throat plate. The front edge of needle hole in presser foot must be aligned with front edge of needle holes in throat plate.

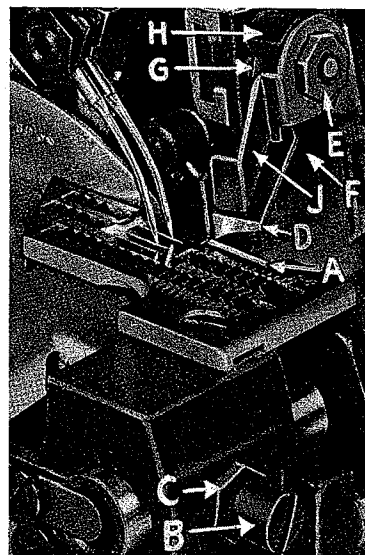

Fig. 12

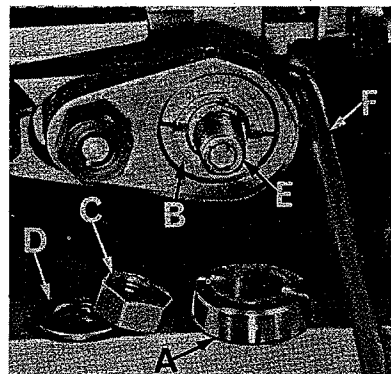

Fig. 13

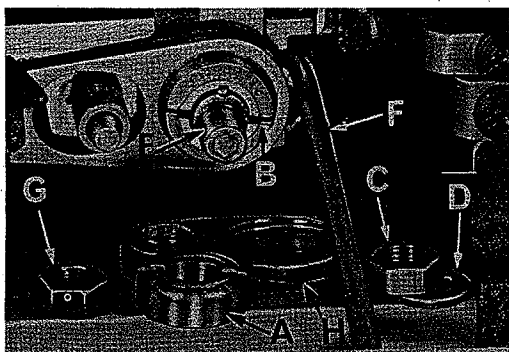

Fig. 14

SETTING THE PRESSER FOOT (Continued)

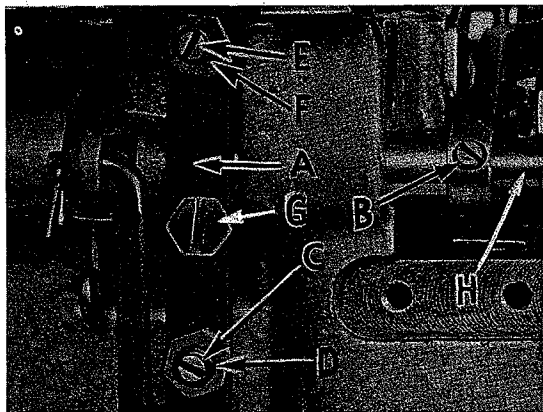

Fig. 15

It is also important that the bottom of the presser foot be flat on the throat plate. If necessary, presser foot can be realigned with throat plate slots by shifting the foot lifter lever shaft (H, Fig. 15). To move the shaft, loosen collar screws (B, Fig. 15) and clamp screw (G) and then shift the foot lifter lever shaft to the left or right as required. Retighten collar screws and clamp screw.

The foot lifter lever arm (A, Fig. 15) and the collar (B) secure the shaft. Be sure the presser arm does not bind and rise when presser foot release bushing is unlocked.

Adjust lifter lever stop screw (C) so that presser foot can be raised no higher than upper looper will permit: then lock the nut (D). There should be from 1/16 to 1/8 inch free motion of foot lifter lever before the presser foot begins to rise. This adjustment should be made with screw (E) and locked with nut (F). Re-assemble the chip guard, fabric guard and cloth plate. To make assembly of chip guard easy, turn handwheel until upper knife assembly reaches its highest position.

STARTING TO OPERATE

Be sure machine is threaded according to threading diagram (Fig. 1). With thread tensions light, set looper thread eyelets (N & R) about horizontal and in the middle of their front to back locations. Operate machine slowly, without presser foot in place, to make sure that chain forms and moves off the tongue freely. Swing presser foot into position, insert material, and sew slowly.

NEEDLE THREAD CONTROL

While sewing on material, check needle thread control as follows: Usually all needle thread is drawn on needle down stroke. At top of needle stroke, thread should be just tight enough to feed chain off stitch tongue. Stitch tends to pull down slightly if excessive thread is pulled on the up stroke. With needle at bottom of stroke, position needle thread eyelet (AD, Fig. 1) so that needle cam pull-off (AE) just contacts needle thread.

LOWER LOOPER THREAD CONTROL

With material under presser foot, set lower looper thread eyelet (R, Fig. 1) back far enough so thread is a little slack when looper thread pull-off (AF) reaches its most rearward position. Looper thread pull-off (AF) is set about 1/8 inch distance behind needle thread cam pull-off (AE). Frame looper thread guide (T) should be set with its eyelet approximately 1/8 inch to the right of lower looper (V) heel eyelet at the time lower looper is at extreme left end of its travel.

While sewing on material, check drawing off of looper thread as follows: A portion of lower looper thread should be drawn through the tension before lower looper thread comes off upper looper. To increase amount of thread drawn through the tension while lower looper thread is on upper looper, move lower looper thread eyelet (R) down, keeping the same amount of pull-off action.

UPPER LOOPER THREAD CONTROL

Before proceeding to adjust upper looper thread eyelet (N, Fig. 1) balance all four tensions to give a normal appearing stitch. Moderate change in these tensions will not markedly effect the purl.

During needle down stroke, forward stroke of looper thread pull-off (AF) will draw upper thread through the tension. When normal amount of looper thread is drawn, upper looper thread will have almost all slack taken up as looper thread pull-off reaches its most rearward position.

POSITIONING THE PURL

To move the purl more under the edge, both looper thread eyelets (N and R, Fig. 1) should be raised keeping the same amount of pull-off. Usually, it is better to have slightly more pull-off on upper thread than on lower thread.

If it becomes necessary to move looper thread pull-off (AF), be sure to take up all end play in needle drive shaft before tightening. If upper looper is located so that it is higher over throat plate than recommended in (Fig. 10), the purl will tend to form near top edge. If upper looper is too low, the purl will form nearer bottom edge.

THREAD TENSIONS

The needle thread tension required is a function of needle thread and material being sewn. In general, lower looper thread tension should be set as high as possible without causing needle thread to be pulled down. Upper looper thread tension should be increased as long as the elasticity of the chain increases, or until the purl is pulled too far over the top. Keep tensions as light as possible and use eyelets and take-ups to get the proper stitch.

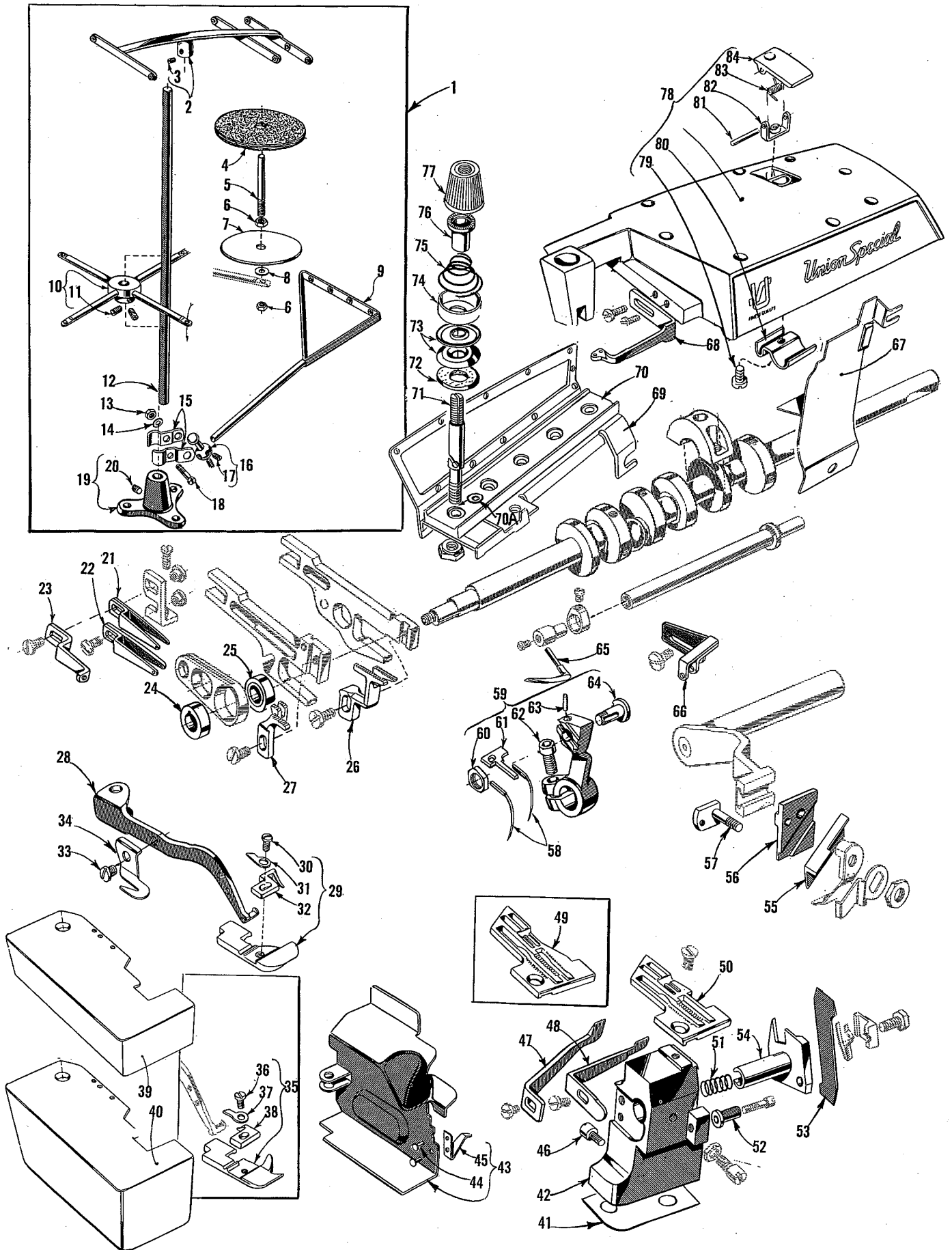

The parts illustrated on pages 14 and 16, and described on this page and page 17 represent the parts that are used on Styles 39500 GG and GH, but not used on Style 39500 FP.

Unless otherwise specified in the description, the parts are used on all the machine styles covered in this catalog. Those parts shown in phantom views and bearing no reference numbers are common to Styles 39500 FP, GG and GH.

Use Catalog No. 103 FA (Style 39500 FP) for all parts not illustrated or described in this catalog.

Reference numbers that are inside a bracket or box on the picture plates and have indented descriptions, indicate they are components of a complete part or assembly.

Ref. No.	Part No.	Description	Amt. Req.
1	21101 H-4	Thread Stand, complete-----	1
2	21114 H-4	Eyelet Support -----	1
3	22651 CD-4	Screw, for eyelet support -----	1
4	21104 V	Pad, for thread cone -----	4
5	21114 W	Spool Pin-----	4
6	258 A	Nut, for spool pin -----	8
7	21114	Spool Seat Disc -----	4
8	652-16	Washer, for spool seat disc -----	4
9	21114 S-4	Lead Eyelet -----	1
10	21114 D-4	Spool Seat Support -----	1
11	22651 CD-5	Screw, for spool seat support -----	2
12	21104 B-20	Thread Stand Rod -----	1
13	21104 H	Nut, for lead eyelet ball split socket -----	1
14	652-16	Washer, for lead eyelet ball split socket-----	1
15	21114 U	Lead Eyelet Ball Split Socket -----	2
16	21114 T	Lead Eyelet Socket Ball -----	1
17	22651 CD-4	Screw, for lead eyelet socket ball-----	2
18	22810	Screw, for lead eyelet ball split socket-----	1
19	21114 A	Thread Stand Base -----	1
20	22651 CD-4	Screw, for thread stand base -----	1
21	39568 T	Upper Looper Thread Eyelet -----	1
22	39568 S	Lower Looper Thread Eyelet -----	1
23	39568 U	Auxiliary Looper Thread Eyelet -----	1
24	39540 B-8	Main Feed Driving Eccentric, for Style 39500 GG-----	1
	39540 B-12	Main Feed Driving Eccentric, for Style 39500 GH-----	1
25	39540 B-8	Differential Feed Driving Eccentric, for Style 39500 GG -----	1
	39540 B-10	Differential Feed Driving Eccentric, for Style 39500 GH -----	1
26	39526 W	Differential Feed Dog, marked "AT", 12 teeth per inch, for Style 39500 GG -----	1
	39526 Z	Differential Feed Dog, marked "AU", 22 teeth per inch, for Style 39500 GH -----	1
27	39505 W	Main Feed Dog, marked "W", 12 teeth per inch, for Style 39500 GG -----	1
	39505 Z	Main Feed Dog, marked "AC", 22 teeth per inch, for Style 39500 GH -----	1
28	39556 E	Presser Arm, for Style 39500 GG -----	1
	39556 F	Presser Arm, for Style 39500 GH -----	1
29	39520 AG	Presser Foot, for Style 39500 GG -----	1
30	22768 B	Screw, for hinge spring and stitch tongue -----	1
31	39530	Hinge Spring -----	1
32	39597 AG	Stitch Tongue, marked "EM" -----	1
33	22704	Screw, chain cutting knife -----	1
34	39556 K	Chain Cutting Knife, marked "J"-----	1
35	39520 W	Presser Foot, for Style 39500 GH-----	1
36	22768 B	Screw, for hinge spring and stitch tongue -----	1
37	39530	Hinge Spring -----	1
38	39597 W	Stitch Tongue, marked "EF" -----	1
39 to 84		See following page	

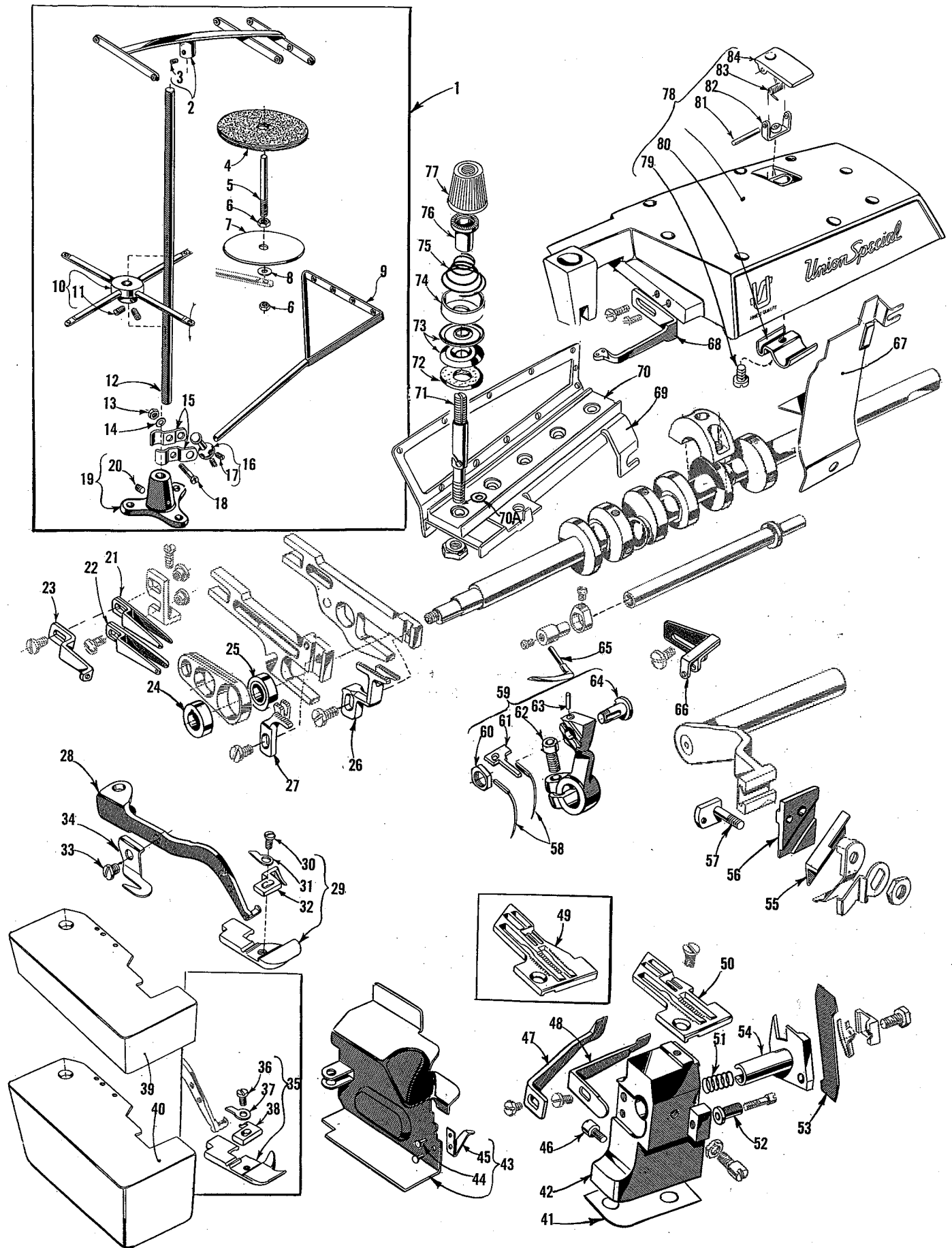

Ref. No.	Part No.	Description	Amt. Req.
1 to 38		See preceding page	
39	39501 DC	Cloth Plate, for semi or fully submerged installation --	1
40	39501 EC	Cloth Plate, for non-submerged installation -----	1
41	39580 E	Shim, .028 inch, for throat plate and lower knife support bracket -----	1
42	39580 AE	Throat Plate and Lower Knife Support Bracket -----	1
43	39582 GG	Side Cover -----	1
44	39582 J	Rivet -----	2
45	39582 H	Spring -----	1
46	22585 G	Latch Screw, for side cover -----	1
47	39525 M	Needle Guard, front -----	1
48	39525 G	Needle Guard, rear -----	1
49	39524 AG	Throat Plate, for Style 39500 GG -----	1
50	39524 Z	Throat Plate, marked "AU", for Style 39500 GH -----	1
51	39550 P	Knife Holder Spring, for Style 39500 GG -----	1
	39550 E	Knife Holder Spring, for Style 39500 GH -----	1
52	39550 R	Lower Knife Holder Locating Stud, for Style 39500 GG -	1
	39550 C	Lower Knife Holder Locating Stud, for Style 39500 GH -	1
53	39549 J	Lower Knife -----	1
54	39550 U	Lower Knife Holder -----	1
55	39570 J	Upper Knife -----	1
56	39572 A	Upper Knife Holder Block, for Style 39500 GG -----	1
	39572	Upper Knife Holder Block, for Style 39550 GH -----	1
57	39571 C	Upper Knife Clamp Stud, for Style 39500 GG -----	1
	39571 D	Upper Knife Clamp Stud, for Style 39500 GH -----	1
58	154 GAS	Needle -----	2
59	39552 T	Needle Driving Arm -----	1
60	14077	Nut, for needle clamp stud -----	1
61	39551 G	Needle Spacer -----	1
62	22596 E	Clamp Screw -----	1
63	50-774 Blk.	Pin -----	1
64	39551 F	Needle Clamp Stud -----	1
65	39508 C	Upper Looper -----	1
66	39563 U	Needle Thread Eyelet -----	1
67	39578 U	Chip Guard -----	1
68	39563 W	Top Cover Needle Thread Eyelet -----	1
69	39592 AG-5	Tension Post Mounting Bracket -----	1
70	39592 AN	Tension Post Bar -----	1
70A	8372 A	Washer, for tension post -----	4
71	39592 AL	Tension Post -----	4
72	39592 AF	Tension Disc Felt -----	4
73	39592 AD	Tension Disc -----	8
74	39592 AJ	Spring Shield -----	4
75	39592 AE-4	Looper Thread Tension Spring -----	2
	39592 AE-8	Needle Thread Tension Spring -----	2
76	39592 AK	Tension Spring Ferrule -----	4
77	39592 Z	Left Needle Thread Tension Nut, yellow -----	1
	39592 AA	Right Needle Thread Tension Nut, green -----	1
	39592 AB	Upper Looper Thread Tension Nut, blue -----	1
	39592 AC	Lower Looper Thread Tension Nut, red -----	1
78	39582 AK	Top Cover -----	1
79	22562 A	Screw, for oil guard -----	1
80	39582 W	Oil Guard -----	1
81	51-103 Blk.	Hinge Pin -----	1
82	39582 AG	Hinge Bracket -----	1
83	39582 V	Spring -----	1
84	39582 AF	Oil Filler Cover -----	1



FINEST QUALITY

Union Special®

LEWIS and COLUMBIA

INDUSTRIAL SEWING MACHINES



SALES OFFICES AND REPRESENTATIVES

†Handle Union Special and Columbia only.

‡Handle Lewis and Columbia only.

All others handle Union Special, Lewis and Columbia with certain exceptions.

UNITED STATES

ALABAMA, BIRMINGHAM, 732-84th Street, South, Lloyd D. Baldwin, Tel. 833-9904.

ALABAMA, MONTGOMERY 7, 1959 Amelia Drive, Garnet H. Hamlet, Tel. 265-0942, P.O. Box 7203, Larry Crisler, Tel. 265-0942.

ARKANSAS, LITTLE ROCK, P.O. Box 1783, James T. Taylor, Tel. (501) FR 2-2356.

CALIFORNIA, LA PUENTE, 1527 Channelwood Drive, Bill Bayless, Tel. 330-3043.

★CALIFORNIA, LOS ANGELES 21, 1100 E. Pico Blvd., Paul M. Mason, Mgr., Tel. Madison 5-5828.

CALIFORNIA, SAN FRANCISCO 7, 1275 Mission St., Robert J. Yaitl, Tel. Underhill 1-1580.

‡CALIFORNIA, SAN FRANCISCO 3, Apparel City Sewing Machine Co., 1155 Mission St., Tel. MArket 1-6660.

COLORADO, ARVADA, Casey's Sewing Machine Service, 5719 Reed St., Tel. 424-6630.

CONNECTICUT, DANBURY, 22 Barnum Road, Robert W. Gaines, Tel. 746-3652.

FLORIDA, MIAMI, 2519 N.W. 2nd Ave., Trimco Sewing Equipment, Inc., Tel. 633-1138.

FLORIDA, PLANT CITY, 506 N. Gordon St., James C. Morgan, Tel. 752-1829.

★GEORGIA, ATLANTA, 2120 Plasters Bridge Road, N.E., Merritt M. Ambrose, Mgr., Tel. 875-9237.

GEORGIA, COMMERCE, Lakeview Drive, J. Tom Hanley, Tel. 335-4061.

GEORGIA, DECATUR, 1713 Coventry Road, Joe V. Parker, Tel. 377-5559.

GEORGIA, DUBLIN, 1615 Knox St., John W. Jones, Tel. 272-4663.

GEORGIA, GAINESVILLE, RFD #1, John Bradberry, Tel. Cumming, Ga. 887-4732.

GEORGIA, WINDER, 805 Pinkney, B. D. Smith, Tel. 867-3208.

★ILLINOIS, CHICAGO 10, 400 N. Franklin St., Orville A. Ullrick, Mgr., Tel. 644-6920.

KANSAS, PRAIRIE VILLAGE, 7351 Rosewood, Cleo C. Smith, Tel. HE 2-1705.

KENTUCKY, LOUISVILLE 7, P.O. Box 7261, Raymond E. Hinton, Tel. 587-0042.

LOUISIANA, METAIRIE, 707 Trudeau Drive, Charles Wickersham, Tel. 729-4115.

MARYLAND, BALTIMORE 15, P.O. Box 2505, Ralph B. Foster, Tel. 727-8499.

‡MARYLAND, BALTIMORE 1, J. Dashew, Inc., 417 W Baltimore St., Tel. LExington 9-1838.

†★MASSACHUSETTS, BOSTON 11, 179 Lincoln St., William E. Palm, Mgr., Tel. Liberty 2-0147.

†MASSACHUSETTS, CANTON, York St., RFD, Roy T. Pedersen, Tel. 828-1412.

†MASSACHUSETTS, TAUNTON, P.O. Box #2 Raynham, Walter P. Godek, Tel. VanDyke 2-6149.

MICHIGAN, DETROIT, John Joyce, Tel. 584-4210.

MINNESOTA, MINNEAPOLIS, 2800 Texas Ave., St. Louis Park 26, Minn., Leonard W. Koehler, Tel. 644-6236.

MISSISSIPPI, JACKSON 3, 327 Eastview St., Jamie A. Boyette, Tel. Fleetwood 5-1976, 1717 Capitol Ave., Larry Lancaster, Tel. 354-3080.

MISSISSIPPI, TUPELO, 606 Racove Drive, Bill Haywood, Tel. VI 2-5848.

‡MISSOURI, KANSAS CITY 5, Textile Machinery Co., 915 Broadway, Tel. Victor 2-9558.

MISSOURI, ST. LOUIS 34, 9860 Guthrie Ave., Carl E. McLoughlin, Tel. Chestnut 1-2368, 3940 Shenandoah St., Jerry Hicks.

†NEW HAMPSHIRE, NASHUA, P.O. Box 257, Herman E. Haberman Jr., Tel. Tuxedo 2-9698.

†NEW JERSEY, NORTH ARLINGTON, 32M Garden Terrace, Joseph Leglisci, Tel. 991-8211.

†NEW JERSEY, RUTHERFORD, 246 Sylvan St., Richard W. Whitson, Tel. Geneva 8-2178.

NEW JERSEY, WEST BERLIN, P.O. Box 26, Frank A. Neff, Tel. 767-4350.

NEW YORK, LATHAM, 57 Sylvan Ave., Clarence A. Wheeler, Tel. State 5-6371.

★NEW YORK, NEW YORK 1, 370 7th Ave., (Penn Terminal Bldg.), Clarence L. Rosenquist, Mgr., Tel. Chickering 4-8800.

NEW YORK, ROCHESTER, 14 Strathmore Circle, James Halbohm, Tel. LI 4-1882.

†NEW YORK, ROCHESTER 9, A. J. Adams Co., 1051 Culver Rd., Tel. BUtter 8-7250.

NEW YORK, UNIONDALE, 873 Henry St., Anthony Candell, Tel. Ivanhoe 3-7477.

NORTH CAROLINA, GREENSBORO, P.O. Box 226, William D. Harrod, Tel. 299-9367, 4216 Pennydale Dr., Harold E. Miller, Tel. 292-0734.

OHIO, CLEVELAND, 4914 Pearl Road, Cut & Sew Equipment Co., Tel. 661-5901.

OHIO, COLUMBUS, P.O. Box 874, Larry Kelsen, Tel. AXminster 1-1222.

OKLAHOMA, OKLAHOMA CITY 19, 2226 Southwest 53rd St., G. B. Wiley, Tel. 685-2836.

PENNSYLVANIA, ALLENTOWN, P.O. Box 542, Luther D. Cassell, Tel. 797-2111.

PENNSYLVANIA, BETHLEHEM, 1212 Camac St., Ed Deegan, Tel. 868-8204.

PENNSYLVANIA, BERWICK, 1013 E. 16th St., Donald McFadden, Tel. 752-2442.

PENNSYLVANIA, CLARKS SUMMIT, 428 West Grove Ave., John J. Laffer, Tel. JUNiper 7-2820.

★PENNSYLVANIA, PHILADELPHIA 24, 4234 Macalester Ave., Ben W. Merz, Mgr., Tel. Gladstone 5-9800.

†PENNSYLVANIA, NEW ALEXANDRIA, (Pittsburgh) P.O. Box 285, W. Dale Spear, Tel. (Pittsburgh) 563-3589.

PENNSYLVANIA, REAMSTOWN, P.O. Box 176, David M. Bender, Tel. 267-6109.

PENNSYLVANIA, YORK, P.O. Box 884, Harding T. Powell, 854-8040, also A. C. Davis.

SOUTH CAROLINA, COLUMBIA, P.O. Box 4246, Virllyn R. Crisler, Tel. Sunset 7-0863, P.O. Box 4112, J. W. Carter, Tel. 254-4255.

SOUTH CAROLINA, GREENVILLE, 25 Sir Abbot St., Orville W. Gregory, Tel. Cedar 9-5539, Lewis Village, Apt 9-E, John Lawrence, Tel. 235-2213.

TENNESSEE, KNOXVILLE 19, 3905 Greenleaf Ave., Horace E. Clifard, Tel. 588-1865.

TENNESSEE, MEMPHIS 17, 4695 Dunn Rd., Richard J. Lindhorst, Tel. Mutual 5-6750.

TENNESSEE, NASHVILLE 12, 1602 South Observatory Drive, William J. Brauch, Tel. Cypress 2-5123, 2517 Woodberry Drive, F. M. Blunkall, Tel. 883-3352.

★TEXAS, DALLAS 19, 4200 Hines Blvd., P.O. Box 6727 J. H. Muir, Mgr., Tel. Lakeside 6-8369.

TEXAS, CARROLLTON, 1404 Fannidella, John D. Troeger, Tel. CH 2-5309.

TEXAS, EL PASO, P.O. Box 9573, Edward E. Smith, Tel. 598-2928.

TEXAS, SAN ANTONIO, Jerry Gregory, P.O. Box 13126, Tel. DI 2-5924.

UTAH, SALT LAKE CITY, 1215 E. 13th South St., Larry F. Rosvall, Tel. IN 7-6931.

VIRGINIA, LYNCHBURG, P.O. Box 1075, Tom Traylor, Tel. 845-8901, also Gerald Morrison.

WASHINGTON, SEATTLE, 858 South 148th, Louis Spencer, Tel. MA 4-8083.

CANADA

Union Special Machine Co. of Canada, Ltd.

BRITISH COLUMBIA, N. BURNABY 2, James Murray, 1522 Madison Ave., Tel. MU 3-3917.

MANITOBA, WINNIPEG 2, Frank Thierman, Rm. 201, White Bldg., 70 Arthur St., Tel. Whitehall 3-4933.

★ONTARIO, TORONTO 2B, Peter Fowler, Mgr.-Rep., 355 King St. West, Tel. Empire 6-2939.

★QUEBEC, MONTREAL 10, John Caschetto, Mgr.-Rep., 40 Molieres St., Tel. 276-2575.

**FINEST
QUALITY
WORK**

**HIGHEST
PRODUCTION
RATES**

**LOWEST
MAINTENANCE
COSTS**

Sales Agents For UNION SPECIAL Machines;
Also Agent for (L) LEWIS and (C) COLUMBIA where marked.

AFRICA

(TEXTILE & BAG MAKING MACHINES) Berzack Bros., Ltd. REPUBLIC OF SOUTH AFRICA—JOHANNESBURG 135/7 Pritchard St. CAPE TOWN—78 Darling St. DURBAN—72/74 Commercial Road. PORT ELIZABETH—277 Main Street. RHODESIA, BULAWAYO—133 Fife St. SALISBURY—102 Sinioa St. (L)
(BAG CLOSING MACHINES) South African Scale Co. Pty., Ltd. REPUBLIC OF SOUTH AFRICA—JOHANNESBURG—32 Von Brandis St. BLOMFONTEIN—53 Zastra St. CAPE TOWN—Wales and Bree Sts. DURBAN—22 Aliwal St. EAST LONDON—38 Argyle St., LADYSMITH, Natal—355 Murchison. PORT ELIZABETH—Box 611. Also at PIETERMARITZBURG, PRETORIA, VEREINGING and WORCESTER. RHODESIA, BULAWAYO—2 Leander House, Rhodes Street. SALISBURY—95 Victoria Street, ZAMBIA—KITHWE-Biantyre Road.
ALGERIA, ALGIERS—Etab. Sayog, 8 Rue Altairac.
ETHIOPIA, ASMARA—S.A. Calderoni Africa, Avenue P. Asfaha Woosen (L & C)
IVORY COAST-ABIDJAN—Ets. Jean Abile-Gal, Box 1798. (L & C)
KENYA, NAIROBI—Transcandia, Ltd., College House, Koinange St. (P.O. Box 5933) (L & C) (Also Uganda, Tanganyika and Zanzibar)
MALAGASY REPUBLIC—TANANARIVE—Soc. Ind. Ef Com. De L'Emyne, Boite Postale 1078, 17 Rue Clemenceau (L & C)
MAURITIUS, PORT LOUIS—(Bag Closing & Bag Making Machines) Hall, Geneva, Langlois, Ltd., 42 Sir William Newton St.
MOROCCO, CASABLANCA—R. Geissmann & Fils, Rue El Idrisi Es Sakali (L)
NIGERIA, APAPA, LAGOS—Sunflag Knitting Mills (Nigeria) Ltd. 9 Warehouse Road. (L & C)
SUDAN, KHARTOUM—Franco Pinto (Sudan) Ltd., P.O. Box 305. (L & C)
TUNISIA, TUNIS—Comptoir Industriel & Manager, 8 Rue du 18 Janvier 1952 (L)

ASIA

CAMBODIA, PHOM-PENH—Denis Freres, 219 P.B. Sisowath, P.O. Box 48. (L & C)
HONG KONG—G. R. Coleman Co. (Hong Kong) Ltd., Rm. 305, Wing Ting Building, 7-13 Wellington St.
INDIA, CALCUTTA—Parrot Sewing Machine (P.) Ltd. 9/1 Sovaram Bysack St. (L & C)
JAPAN, OSAKA—Kondo Sewing Machine Co. 163. Umegoe-cho Kita-ku. (L) Branch—Tokyo 6-3 Ginza, Choo-Ku. Also at: Ashikaga, Fukai, Nagoya, Niigata, and Okayama.
KOREA, SEOUL—Uebersee-Handel A.G., Rm. 604, Bando Bldg. 180 1-ka Ulchiro; Chung-Ku, Inf. P.O. Box 1268. (L)
LAOS, VIETIANE—Denis Freres, P.O. Box 133. (C & L)
PAKISTAN, (WEST) KARACHI—Universal Trading Corp., 29 Zeeat Mansion, McLeod Road. (EAST) (Bag closing and bag making machines) Thomas C. Keay, Ltd., 15 Baltic Street, Dundee, Scotland.
REPUBLIC OF CHINA, TAIWAN, TAIPEI—G. R. Coleman Co. (Taiwan) Ltd., 16 Nan Yang St. (L & C)
THAILAND, BANGKOK—Yip In Tsai & Co., Ltd., P.O. Box 23. (L & C)
VIETNAM, SAIGON—S.A. Pour Le Riz et L'Indutrie (Sar) 147, Trinh Minn-The (B. P. 444) (C & L)

AUSTRALIA

SOLE DISTRIBUTORS: Capron, Carter Pty., Ltd., 86 Liverpool Street, SYDNEY. Branches at: BRISBANE—454 Brunswick St., Valley, N.I. MELBOURNE—154 A'Beckett St. AGENTS: SOUTH AUSTRALIA—ADELAIDE—William Charlifk Ltd., London Road, Mile End. WESTERN AUSTRALIA—PERTH—Thomson's Pty. Ltd., 789 Hay St. TASMANIA—LAUNCESTON—Sew Knit Pty. Ltd., 72-74 George St. (L & C)

EUROPE

AUSTRIA, VIENNA—Firma Naeschuster, Mariahilferstr. 51.
BELGIUM, BRUSSELS—Union Special Machine Corporation of America, 90 Rue de la Caserne, Gustave Thierie, Mgr. (C)
DENMARK, COPENHAGEN—Rothenborg Specialmaskiner for Sy-Industrien A/S, Nikolaj Plads 23. Offices at: AALBORG, HERNING, KOLDING, ODENSE, RISSKOV-AARHUS AND SILKEBORG. (L & C)
FINLAND, HELSINKI-LAUTTASAARI—Suomen Konelike O/Y, Valtuuniekatu 13. Branches at TAMPERE-Pientepöytäkat. TURKU, Helsinginkatu 7-B. (L & C)
FRANCE, PARIS—Cie. des Machines Union Special de France, 91 Ave. de la Republique—Thos. de Semlyen, Directeur. Branches at: ROUBAIX (NORD)—50 Ave. J. Lebas. LYON, VILLEURBANNE (RHONE) 58 rue Alexandre Bouffin. TOULOUSE (HAUTE GARONNE) 12, Bd. Montplaisir.
GERMANY, STUTTGART—Union Special Maschinenfabrik G.m.b.H., Schwabstr. 33—A. W. Krieger, Managing Director. Th. M. Baanstra, Director of Sales, BRANCHES AT: BERLIN, BIELEFELD, EBINGEN, FRANKFURT, HAMBURG, KOLN, MUNCHEN, OCHTRUP.
GREAT BRITAIN—(Textile Machinery)—ENGLAND—OADB Y (NR. LEICESTER)—Union Special Machine Company, Ltd., Mandervell Road, Industrial Estate. Mr. A. B. Fitzpatrick, Manager. LONDON—108 City Road (H. O. Hall, Manager). SALES OFFICES: BRISTOL, L. J. Heard, 19 The Rides. KINGWOOD, SCOTLAND, MILNGAVIE (GLASGOW)—Derrick R. Robinson, 48 Clackbar Avenue. SUB-AGENTS: LONDON, W. 1—G. Johnson & Son (Sewing Machinery), Ltd., 58 Great Titchfield Street. MANCHESTER 19—S. A. Smith, (Manchester) Ltd., Park Grove Works, Levenshulme. NORTHERN IRELAND—BELFAST 15, Aktel Ltd. 186 Cavahill Road. SCOTLAND, GLASGOW S.E.—Allardice & Co., 9 Stevenson Street. (C) (Bag Closing and Bag Making Machines) SCOTLAND, DUNDEE—Thomas C. Keay, Ltd., 15 Baltic Street—Agent for entire British Isles.
GREECE, ATHENS—Georgis Yannakouras-Dimoulis, 30 Petraki St. (L & C)
ICELAND, REYKJAVIK—Magnus Thorgerisson, Skolvordustig 1a (L & C).
IRELAND, DUBLIN—(Textile Machines) W. Blythman, 224 Parnell Street (L & C) (Bag Closing and Bag Making Machines) Thomas C. Keay, Ltd., 15 Baltic St., Dundee, Scotland.
ITALY, MILANO—Giovanni Conti & Nipoti, Via Varese 18. (L & C)
MALTA, VALLETTA—A. C. Wisniayser & Co., Ltd., 62 Old Bakery Street. (L & C)
THE NETHERLANDS, AMSTERDAM—N. V. Machinehandel C. & H. Verbeek, Kloveniersburgwal 77. Offices at: ARNHEM, ENSCHEDE, GRONINGEN, ROTTERDAM, SITTARD, TILBURG. (L & C)
NORWAY, MANGLERUD—Jac. Jacobsen A/S, Enebakkeveien 117, BERGEN—Bjornsonstg 24. (C)
PORTUGAL, OPORTO—Rost & Janus, Succs. Lda., Rua Barao de Forrester 914. (L)
SPAIN, BARCELONA—Rapida, S.A., Via Layetana 37 (L)
SWEDEN, BORAS—Rud. Nyström & Co., A/B, Lilla Brannergatan 6. Branches at OREBRO-Slodgatan 37-39, MALMO, S. Forstadsatan 16. Sub-Agent STOCKHOLM, 4/B Forsberg & Kato, Tomtebgatan 38.
SWITZERLAND, URDORF (ZH)—Bourquin & Cie., Vogelaustr. (Postfach). (L-Button Sewer)

LATIN AMERICA

Union Special International, Inc.
ARGENTINA, BUENOS AIRES—IROMAC S.A.C., Division Pamaco Costura, S.A., San Jose 350. (Union Special Machine Company), (L & C)
BRAZIL, SAO PAULO—Pancostura S.A.—Industria e Comercio, Rua Aurora 59A-71. Branches at PORTO ALEGRE—Rua Voluntarios da Patria 533; RECIFE—Rua Princesa Isabel 105; RIO DE JANEIRO—Rua Alexandre Mackenzie 117. (C & L)
CHILE, SANTIAGO—Lowenstein & Stewart, S.A.C., Calle Santa Domingo 1140. (L & C)
COLOMBIA, BOGOTA—Macalzado, Ltda., Carrera 30 #12-99. Branches at BARRANQUILLA—Carrera 45-B #34-54. BUCARAMANGA—Calle 34 #17-45. CALI—Carrera 7 #13-33/35. MANIZALES—E. Breslauer, Carrera 22 #18.44. MEDELLIN—Carrera 51, 36-18. PERELRA—Cra. 8—#22-77. (L & C)
COSTA RICA, SAN JOSE—Enrique Rodrigues S., P.O. Box 1949. (L & C)
DOMINICAN REPUBLIC, SANTA DOMINGO—Roberto Dominquez, G., Calle Dr. Pedro Urena 19. (L & C)

ECUADOR, GUAYAQUIL—Distribuidora Richard O. Custer, S.A., Malecon Simon Bolivar #2308. Branch at QUITO—Avenida Patria 768. (L & C)
EL SALVADOR, SAN SALVADOR—Vairo Hermanos, Colonia Vairo. (L)
GUATEMALA, GUATEMALA—Compania Agro Comercial, S.A., 8a Avenida Sur Zona 1. (L & C)
HONDURAS, SAN PEDRO SULA—Jacobso E. Handel, P.O. Box 559 (L & C)
MEXICO, MONTERREY, N.L.—Talleres Perez Zozaya, S.A. de C.V., Cuahuemac Norte 335. Branches at: GUADALAJARA, JAL.—Hidalgo 45 y 47; MEXICO, D.F.—Distribuidora Union Especial, S.A. de C.V., Ave., Pina Suarez 99-a (Apartado 28070); SAN LUIS POTOSI, S.L.P.—J. de los Reyes 80. (L)
NICARAGUA, MANAGUA—Casa Hentgen, 3 A Calle N.O. #303. (L)
PANAMA, PANAMA—Agencias Hagus, S.A., Ave. 7A Espana #45.
PERU, LIMA, Breña—United Agencies, S.A. (Peru) Av. Alfonso Ugarte 1445-1447. (L & C)
PUERTO RICO, SAN JUAN—Abarca Warehouse Corp., P.O. Box 2352. (L & C)
SURINAM, PARAMARIBO—Kirpalani's, Ltd., 17-27 Maagden St. (L & C)
URUGUAY, MONTEVIDEO—Storer & Cia., S.A., Uruguayo, Mercedes 1312. (L)
VENEZUELA, CARACAS—H. Blohm, S.A., Dr. Paul A. Chorro 29.

NEAR EAST

CYPRUS, NICOSIA—Christodoulides Bros. & Co., 94 Tri-couppis St. (L)
IRAN, TEHRAN—Sava Trading Corp., Ave. Bozariemehri 881. Seray Saadiyeh. (L & C)
IRAQ, BAGHDAD—Sons of O. O. Agopian (IRAQ), P.O. Box 2021, Alwyah. (L & C)
ISREAL, TEL AVIV—L. Taub, Ltd., 15 Lilienblom St. (L)
JORDAN—Bandar & Aractingi, B.P. 1144—Damas, Syria (L & C)
LEBANON, BEIRUT—Sons of O. O. Agopian, P.O. 1165. (L & C)
SYRIA, DAMAS—Bandar & Aractingi, B.P. 1144. (L & C)
TURKEY, ISTANBUL—M. Benmayor, Mahmutpasa Abut Efendi Han Nr. 46-47. (L & C)
U.A.R., CAIRO—Mitr Import & Export Co., 6 Rue Adly—Tech. Sub-Agent—A. Kavaldjian. S.A.R.L., 200 Sharia Shuhra. (L & C)

NEW ZEALAND

SOLE DISTRIBUTOR: H. A. Tuck & Co., Ltd., 171 Albert St. AUCLAND. BRANCH AT: WELLINGTON, Lees Bldg., Nelson St. (L) Also—New Caledonia, Cook Islands, Ellice Islands, Gilbert Islands, New Hebrides, Samoa (American), Tahiti, and Tonga. SUB-AGENTS: Glendernid, Ltd., CHRIST-CHURCH—90 Orbell St. DUNEDIN—192-196 Castle St., P.O. Box 40. (C) FIJI SUVA—Karl R. Fleischman, P.O. Box 602. (L) SAMOA (WESTERN), APIA—S. C. Percival, P.O. Box 204. (L)

PACIFIC ISLANDS

HAWAII, HONOLULU—(Textile Machines) Territorial Sales Co., 508 Aikinson Drive. (L) (Bag Closing and Bag Making Machines) H. S. Gray Co., 759 Puuloa Rd.
PHILIPPINE ISLANDS, MAKATI, RIZAL—Atkins, Kraft & Co., Inc., 313 Malugay Street, (Buendia Extension). Branch at CEBU. (L & C)

WEST INDIES FEDERATION, JAMAICA

Union Special International, Inc.
JAMAICA, KINGSTON—Morris E. Parkin, 96 King St. (L)
TRINIDAD, PORT OF SPAIN—Ackrill & Co., 17 Henry St. (L & C) Also—BARBADOS, GRENADA, TOBAGO.

Additional Sales Agents for (L) LEWIS and (C) COLUMBIA Machines

1-66

AUSTRIA IV, VIENNA—Franz Koerpert & Sohne, K.G., Wiedner Hauptstrasse 36. (C)
BELGIUM, BRUSSELS—N. V. Machinehandel C & H Verbeek, Kruidtuinlaan 57a, Buyl Bldg. (L)
FRANCE, PARIS—Societe G. Arnon & Cie., 14 Rue Commines (L)—Aspe-Dumont & Cie., 13 Rue de la Fontaine-Au-Roi. (C)
GERMANY, KREFELD—Herbert Jannsen, Alte Linnerstr. 104 (C. tie mach.)
GREAT BRITAIN—ENGLAND, LONDON, E.C.2—Eastman Machine Company, Ltd., 128-132 Curtain Road. CROYDON, 89 Beddington Lane. LEEDS—60 Merriion Street. MANCHESTER, 105-107A Corporation Street. SCOTLAND, GLASGOW S2—11 Drumreoch Place, Torgylen. NORTHERN IRELAND, BELFAST 14—W. F. Maxwell, 50 Glenbryn Park. REPUBLIC OF IRELAND, DUBLIN—Wm. Blythman, Ltd., 223/4 Parnell Street. (L)
ISRAEL, TEL AVIV—Israel Sewing Machine Co., 22 Yehudo Halevy St. (C)

MEXICO, MEXICO, D.F.—Casa Diaz de Maquinas de Caser, Av. Republic Del Salvador 89-93 (C)
MOROCCO, CASABLANCA—Durkopp Coudrex, 25 Rue Bascu-nana. (C)
NORWAY, OSLO—J. A. Johansen A/S, Torvgatan 10. (L)
REPUBLIC OF SOUTH AFRICA, JOHANNESBURG—African Sewing Machine Company (Pty.) Ltd., 118 President Street. Branches at: CAPE TOWN—110 Plain St.; DURBAN—9 Nieuw Miester Lane (C)

RHODESIA, FEDERATION OF RHODESIA & NYASALAND, BULAWAYO—African Sewing Machine Company (Rhodesia) (Pvt.) Ltd., 2 Leonidas House, 138 Rhodes Ave.
SPAIN, BARCELONA—Arbis S/A, Gerona 63. (C)
SWEDEN, BORAS—Husqvarna, Industrismaskiner A/B—Katrinedalsgatan 13. Branches: GÖTEBORG—Stigbergsgliden 1 MALMO—Isak Sjöktaregatan 9—OREBRO—Stortorget 19—STOCKHOLM—Brunngatan 6-8. Agents—ULRICEHAM—Firma Hjalmar Svensson, Tingshusgatan. (C)
SWEDEN, BORAS—A/B, A. C. Gustafson, Skolgatan 30, Branches: MALMO—Sevedsgatan 14. STOCKHOLM—Kungs-gatan 18 Ulriceham-Höjdgatan 20. Sub-Agent—GÖTEBORG—Symmaskinsverkstaden special, Kungshöjsgatan 7. (L)
SWITZERLAND, ZÜRICH—Fritz Zellweger & Sohne, Sel-naustr. 27. (L. except Button Sewer) Guttinger A.G., Sihlstrasse 37. (C)
URUGUAY, MONTEVIDEO—C. Brandes & Cia., S.A., Calle Rincan 658-60. (C)



Union Special[®]
INDUSTRIAL SEWING MACHINES

UNION SPECIAL maintains sales and service facilities throughout the world. These offices will aid you in the selection of the right sewing equipment for your particular operation. Union Special representatives and service men are factory trained and are able to serve your needs promptly and efficiently. Whatever your location, there is a Union Special Representative to serve you. Check with him today.

ATLANTA, GA.

BOSTON, MASS.

CHICAGO, ILL.

DALLAS, TEXAS

LOS ANGELES, CAL.

NEW YORK, N. Y.

PHILADELPHIA, PA.

MONTREAL, QUEBEC

BRUSSELS, BELGIUM

LEICESTER, ENGLAND

LONDON, ENGLAND

PARIS, FRANCE

STUTT GART, GERMANY

Representatives and distributors in all important industrial cities throughout the world.

Union Special
MACHINE COMPANY