

**SINGER**  
**246-13**

Form 20804  
(456)  
Printed in U.S.A.

**LIST**  
OF  
**PARTS**

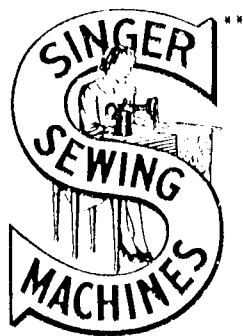

**SINGER™**

MACHINE No. 246-13

THE SINGER MANUFACTURING COMPANY

## INSTRUCTIONS FOR OILING

To ensure easy running and prevent unnecessary wear of the parts which are in movable contact, the machine requires oiling and when in continuous use, the oil gauge should be checked daily. The oil level should be maintained at the midpoint of the gauge.

To oil the machine, apply "TYPE A" OIL, sold by Singer Sewing Machine Company, to the oil filler cup on top of the machine, as instructed in Form 20741.

## I N D E X

	Page
Accessories .....	42
Belt Guard (Adjustable) .....	42
Chip Chute .....	42
Foot Lifter Parts .....	42
Machine Base .....	42
Machine No. 246-13 .....	7
Numerical List of Parts .....	45
Sets of Fittings Complete .....	15
Thread Unwinders .....	43

## INSTRUCTIONS FOR ORDERING

In ordering from this list, use ONLY the part NUMBER in the FIRST column.

The number stamped on a Sewing Machine Part is in every case the number of the single part only.

Every combination of parts sent out as such has its specific number, which, although not stamped on the parts, must be used when ordering the combination.

Each number always indicates the SAME PART in whatever list it appears, or for whatever machine.

The letters after some of the numbers indicate the style of finish only, as follows:

- A—Hardened, Polished, Nickel Plated and Buffed
- B—Polished, Nickel Plated and Buffed
- C—Hardened Only
- D—Polished Only
- E—Soft, Not Polished
- F—Hardened and Polished
- G—Bright Rumbled and Nickel Plated
- H—Blued
- J—Nickel Plated Only
- K—Hardened and Nickel Plated
- L—Brass Plated
- M—Oxidized
- N—Now Color-Code No. 2
- P—Now Color-Code No. 1
- R—Phosphate Coating Formed on Surface of Iron or Steel
- S—Cadmium Plated
- T—Copper Plated
- U—Zinc Plated
- V—Silver Plated
- W—Polished and Nickel Plated
- X—Black Oxide for Iron and Steel
- Y—Black Nickel Plated Only
- Z—Chromium Plated
- A.A—Buffed and Chromium Plated
- A.B—Hardened, Polished, Buffed and Chromium Plated
- A.C—Now Color-Code No. 3
- A.E—Hardened, Bright Rumbled and Nickel Plated
- A.F—Hardened, Bright Rumbled, Nickel Plated, Bright Rumbled and Chromium Plated
- A.G—Alumilite (Plain)
- A.H—Alumilite (Dyed) Color Must be Stated
- A.J—Polished, Nickel Plated and Chromium Plated
- A.K—Hardened, Polished, Nickel Plated and Chromium Plated
- A.L—Heat Treated for Toughness
- A.L.D—Heat Treated for Toughness and Polished
- A.L.X—Heat Treated for Toughness and Black Oxide
- A.M—Now Color-Code No. 9
- A.N—Now Color-Code No. 13

## INSTRUCTIONS FOR ORDERING

- A.P.P—Now Color-Code No. 4
  - A.R—Now Color-Code No. 5
  - A.S—Black Moulded Phenolic
  - A.T—Beige Moulded Phenolic
  - A.U—Brown Moulded Phenolic
  - A.V—Now Color-Code No. 12
  - A.W—Hardened then Flame Coated with Tungsten Carbide
  - A.X—Now Color-Code No. 17
  - B.A—Chrome Nickel Satin Finish
  - B.B—Hardened and Chrome Nickel, Satin Finished
  - C.R—Hardened and Phosphate Coating Formed on Surface of Steel
  - F.J—Hardened, Polished and Nickel Plated
  - P.P—Now Color-Code No. 6
  - T.A—Hardened, Polished, Copper and Nickel Plated and Buffed
  - T.B—Copper and Nickel Plated and Polished
  - T.J—Copper and Nickel Plated Only
  - T.K—Hardened, Copper and Nickel Plated
  - T.L—Copper and Brass Plated
  - T.M—Copper Plated and Oxidized
  - X.C—Hardened and Black Oxide for Iron and Steel
  - Z.A—Hardened, Polished Nickel Plated, Buffed and Chromium Plated
  - Z.B—Polished, Nickel Plated, Buffed and Chromium Plated
  - Z.C—Hardened and Chromium Plated
  - Z.D—Polished and Chromium Plated
  - Z.G—Bright Rumbled, Nickel Plated, Bright Rumbled and Chromium Plated
  - Z.J—Nickel and Chromium Plated
  - Z.T—Copper and Chromium Plated
- These letters MUST BE USED when they appear in the list; and AFTER the number as in the list.

In this series:

1 to 1500, 50001 to 51500 and 140001 to 142,000 are screw numbers  
1501 to 1800 and 51500 to 51800 are nut numbers  
1801 to 2000 and 51801 to 52000 are roller numbers  
2001 to 50000 and 52001 to 140000 and 142001 to 190000 are Sewing Machine Parts, 190001 and upward are numbers of Electrical Parts.

The figures in the second column refer only to the plates, illustrating the parts, and are NOT TO BE USED in ordering.

Parts marked with an asterisk (\*) are furnished only when repairs are made at the factory.

For color codes, see next page.

### INSTRUCTIONS FOR ORDERING

#### PAINT FINISHES USED ON PARTS

Code No.

- 1—Bright Black Japan—No. 520
- 2—Dull Black Japan—No. 132
- 3—Brown Baking Enamel—No. 516
- 4—Gray Rink-L-Rite Enamel
- 5—Beige Rink-L-Rite Enamel
- 6—Black Rink-L-Rite Enamel
- 7—Light Green Synthetic Baking Enamel
- 8—Dark Green Synthetic Baking Enamel
- 9—Dark Beige Synthetic Baking Enamel
- 10—Light Beige Synthetic Baking Enamel
- 11—Oyster White Synthetic Baking Enamel
- 12—Black Synthetic Baking Enamel
- 13—Bright Cherry Red Synthetic Baking Enamel
- 14—Light Ivory Synthetic Baking Enamel
- 15—Peacock Blue Synthetic Baking Enamel
- 16—Bright Yellow Synthetic Baking Enamel
- 17—Gray Dipping Synthetic Baking Enamel
- 18—Deep Brown Lacquer (Air Dry)
- 19—Dark Brown Lacquer (Air Dry)
- 20—Dark Brown Synthetic Baking Enamel
- 21—Aluminum Lacquer (Air Dry)
- 22—Dark Gray Synthetic Baking Enamel

### LIST OF PARTS COMPLETE

FOR

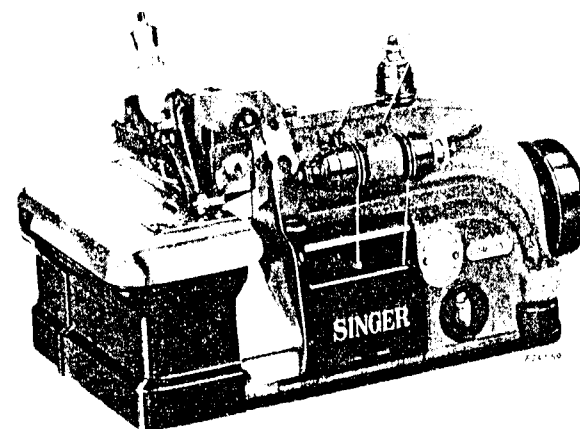

### MACHINE No. 246-13

FOR TRIMMING AND OVEREDGING LIGHT AND MEDIUM WEIGHT FABRICS, ONE NEEDLE, TWO LOOPERS. MAKES A THREE THREAD TIGHT STITCH, GATHERING FEED. TRIMMER. BIGHT FROM 1/16" TO 1/4" FROM NEEDLE. MATERIAL UP TO 3/16" IN THICKNESS CAN BE STITCHED. SPEED UP TO 5500 DEPENDING ON MATERIALS USED AND OPERATIONS PERFORMED.

No.	Plate	Name
164001	24815	Chip Guard
12091	24815	Chip Guard Screw (lower)
140509J	24815	Chip Guard Screw (upper)
164002	24815	Cloth Plate Extension
1324J	24815	Cloth Plate Extension Screw (2)
51642J	24815	Cloth Plate Extension Screw Nut
701679	24815	Cloth Plate Extension Screw Nut Lock Washer
164205	24815	Cloth Plate Lock Spring
51642J	24815	Cloth Plate Lock Spring Nut
701679	24815	Cloth Plate Lock Spring Nut Lock Washer
1250AL	24815	Cloth Plate Lock Spring Screw Stud
164104	24815	Cloth Plate Plunger
164105	24815	Cloth Plate Plunger Spring
624AL	24815	Cloth Plate Plunger Set Screw
164106	24815	Cloth Plate Position Collar with two 624AL
624AL	24815	Cloth Plate Position Collar Set Screw (2)
164593	24815	Cloth Plate
164594	24815	Cloth Plate with Extension complete, Nos. 164002, 164205, 164593 and two each 1324J, 51642J and 701679
164003	24827	Feed Bar Hinge Pin (eccentric)
1389C	24827	Feed Bar Hinge Pin Set Screw
164004	24827	Feed Bar Slide Block (back) (2)
1628C	24827	Feed Bar Slide Block (back) Nut
17022	24827	Feed Bar Slide Block (back) Nut Washer

No.	Plate	Name
164005	24827	Feed Bar Slide Block (front)
164687	24827	Feed (back) Bar with 164010
164017	24827	Feed (back) Bar Connection
164008	24827	Feed (back) Bar Connection Bearing
164009	24827	Feed (back) Bar Connection Hinge Screw Stud
1671C	24827	Feed (back) Bar Connection Hinge Screw Stud Nut
164010	24827	Feed (back) Bar Connection Hinge Screw Stud Position Pin
164011	24832	Feed (back) Dog Section (left)
164012	24832	Feed (back) Dog Section (right)
1100AL	24832	Feed (back) Dog Section (right) Screw
164013	24832	Feed (back) Dog complete, for 164178, Nos. 1100AL, 164011 and 164012
1454F	24832	Feed (back) Dog Screw
164020	24827	Feed (back) Eccentric
	NOTE:	Feed (back) Eccentric No. 164020 is furnished in 6 to 16, 18, 20, 22, 24, 28, 32 and 36 stitches to the inch unless otherwise stated, No. 164020 (14 stitches to the inch) is supplied regularly.
164006	24827	Feed (front) Bar with 164010
164007	24827	Feed (front) Bar Connection
164018	24827	Feed (front) Bar Connection Bearing
164009	24827	Feed (front) Bar Connection Hinge Screw Stud
1671C	24827	Feed (front) Bar Connection Hinge Screw Stud Nut
164010	24827	Feed (front) Bar Connection Hinge Screw Stud Position Pin
164208	.....	Feed (back) and (front) Bars complete, Nos. 164005, 164006, 164007, 164008, 164017, 164018, 164687 and two each 1671C, 164004 and 164009
164019	24832	Feed (front) Dog, 19 teeth (20 teeth to the inch)
1454F	24832	Feed (front) Dog Screw
164020	24827	Feed (front) Eccentric
	NOTE:	Feed (front) Eccentric No. 164020 is furnished in 6 to 16, 18, 20, 22, 24, 28, 32 and 36 stitches to the inch unless otherwise stated, No. 164020 (14 stitches to the inch) is supplied regularly.
164520	24827	Feed Eccentric Cover
164399	24827	Feed Eccentric Cover Bracket with 164023
157C	24827	Feed Eccentric Cover Bracket Screw
629K	24827	Feed Eccentric Cover Hinge Screw
164401	24827	Feed Eccentric Cover Latch Spring
227J	24827	Feed Eccentric Cover Latch Spring Screw (2)
164023	24827	Feed Eccentric Oil Wick
164521	24827	Feed Eccentric Cover complete, for use with eccentrics of 4 stitches and above, Nos. 629K, 164399, 164401, 164520 and two 227J
164025	24812	Feed Lifting and Knife (movable) Lever Eccentric
164455	24828	Finger Guard
164456	24828	Finger Guard Adaptor
1259AL	24829	Finger Guard Adaptor Screw
1423J	24828	Finger Guard Screw
164550	24828	Knife (movable) <i>zipper</i>
164027	24828	Knife (movable) Clamp
140050C	24828	Knife (movable) Clamp Screw
164028	24828	Knife (movable) Guard (lower)
164458	24828	Knife (movable) Guard (upper)
164029	24828	Knife (movable) Holder
198J	24828	Knife (movable) Holder Screw
164030	24828	Knife (movable) Holder Screw Bearing
164714	24828	Knife (movable) Lever with 620AL
164715	.....	Knife (movable) Lever 164714 with 132583, 164035, 164136 and 164153
164032	24828	Knife (movable) Lever Bearing
50421AL	24828	Knife (movable) Lever Bearing Set Screw (long)

No.	Plate	Name
624AL	24828	Knife (movable) Lever Bearing Set Screw (short)
164373APP	24829	Knife (movable) Lever Cover and Presser Bar (upright) Housing with 1259AL
50073J	24829	Knife (movable) Lever Cover and Presser Bar (upright) Housing Screw (2)
164374	.....	Knife (movable) Lever Cover and Presser Bar (upright) Housing complete, Nos. 50060K, 164137, 164138, 164139, 164142, 164143, 164144, 164194 and 164373APP
164180	24828	Knife (movable) Lever Guide
164181	24828	Knife (movable) Lever Guide Holder with two 140239AL
164210	24828	Knife (movable) Lever Guide Holder 164181 with 197J, 164177, 164180 and 164182
164182	24828	Knife (movable) Lever Guide Holder Thread Tube
50421AL	24828	Knife (movable) Lever Guide Holder Thread Tube Set Screw (frame end)
140239AL	24828	Knife (movable) Lever Guide Holder Thread Tube Set Screw (holder end)
197J	24828	Knife (movable) Lever Guide Screw
132583	24828	Knife (movable) Lever Hinge Pin with 132584
132584	24828	Knife (movable) Lever Hinge Pin Oil Wick
620AL	24828	Knife (movable) Lever Hinge Pin Set Screw
164034	24828	Knife (movable) Lever Hinge Stud
164035	.....	Knife (movable) Lever Hinge Stud 164034 with 164036 and 164269
164036	24828	Knife (movable) Lever Hinge Stud Oil Wick (long)
164269	.....	Knife (movable) Lever Hinge Stud Oil Wick (short)
50421AL	24828	Knife (movable) Lever Hinge Stud Set Screw (back)
1143AL	24828	Knife (movable) Lever Hinge Stud Set Screw (top)
164552	24828	Knife (stationary) (2) <i>to check L</i>
164554	24828	Knife (stationary) Clamping Stud
164523	24828	Knife (stationary) Clamping Stud Nut
164524	24828	Knife (stationary) Holder
164590	24828	Knife (stationary) Holder Adjusting Stud
190E	24828	Knife (stationary) Holder Adjusting Stud Cap Screw
3954I	24828	Knife (stationary) Holder Adjusting Stud Cap Screw Washer
164042	24828	Knife (stationary) Holder Sleeve
140088R	24828	Knife (stationary) Holder Sleeve Screw
59456	24828	Knife (stationary) Holder Sleeve Screw Washer
164043	24828	Knife (stationary) Holder Spring
164525	24828	Knife (stationary) Holder Spring Stud
164462	24828	Lint Stripper with 735AL
735AL	24828	Lint Stripper Screw
164045	24830	Looper (left hand)
164046	24830	Looper (left hand) Carrier with 460AL, 50379F and 164202
164660	24830	Looper (left hand) Carrier Holder with 1083C, 140393AL and 140596AL
164661	.....	Looper (left hand) Carrier Holder 164660 with 1324C, 59456 and 164046
1083C	24830	Looper (left hand) Carrier Holder Clamping Screw
140596AL	.....	Looper (left hand) Carrier Holder Set Screw (left)
140393AL	24830	Looper (left hand) Carrier Holder Set Screw (right)
1324C	24830	Looper (left hand) Carrier Screw
460AL	24830	Looper (left hand) Carrier Screw Set Screw
59456	24830	Looper (left hand) Carrier Screw Washer
164048	24830	Looper (left hand) Driving Shaft
164049	24830	Looper (left hand) Driving Shaft Bushing (back)
140394E	24830	Looper (left hand) Driving Shaft Bushing (back) Cap Screw
164293	24830	Looper (left hand) Driving Shaft Bushing (back) Cap Screw Washer (fiber)
164050	24830	Looper (left hand) Driving Shaft Bushing (front)

No.	Plate	Name
164051	24830	Looper (left hand) Driving Shaft Crank with 1083C
164215	.....	Looper (left hand) Driving Shaft Crank 164051 with 164052
1083C	24830	Looper (left hand) Driving Shaft Crank Clamping Screw
164052	24812	Looper (left hand) Driving Shaft Crank Connection with two each 171AL and 140159AL
171AL	24812	Looper (left hand) Driving Shaft Crank Connection Cap (lower) Screw (2)
140159AL	24812	Looper (left hand) Driving Shaft Crank Connection Cap (upper) Screw (2)
164067	24830	Looper (left hand) Driving Shaft Crank Key
1324C	24830	Looper (left hand) Driving Shaft Crank Key Screw
45057	24830	Looper (left hand) Driving Shaft Crank Key Screw Washer
164053	24830	Looper (left hand) Driving Shaft Crank Thrust Bearing
50379F	24830	Looper (left hand) Set Screw
164202	24830	Looper (left hand) Stop Pin
164054	24832	Looper (left hand) Thread Tube
853AL	24832	Looper (left hand) Thread Tube Set Screw
164055	24830	Looper (right hand)
164056	24830	Looper (right hand) Carrier with 50370AL
164057	24830	Looper (right hand) Carrier Connection
164595	24830	Looper (right hand) Carrier Connection Guide Bar with 51015F, 164596 and 168215
164596	24830	Looper (right hand) Carrier Connection Guide Bar Oil Pad
168215	.....	Looper (right hand) Carrier Connection Guide Bar Oil Wick
51015E	24830	Looper (right hand) Carrier Connection Guide Bar Plug Screw
164597	24830	Looper (right hand) Carrier Connection Guide Bar Bracket with two 462AL
914C	24830	Looper (right hand) Carrier Connection Guide Bar Bracket Screw (left)
1057AL	24830	Looper (right hand) Carrier Connection Guide Bar Bracket Screw (right)
462AL	24830	Looper (right hand) Carrier Connection Guide Bar Set Screw (2)
164061	24830	Looper (right hand) Carrier Connection Hinge Stud with 1019AL
1443J	24830	Looper (right hand) Carrier Connection Hinge Stud Cap Screw
164397	24830	Looper (right hand) Carrier Connection Hinge Stud Adjusting Pin
1019AL	24830	Looper (right hand) Carrier Connection Hinge Stud Adjusting Pin Set Screw
132565	24830	Looper (right hand) Carrier Hinge Pin
50370AL	24830	Looper (right hand) Carrier Hinge Pin Set Screw
164062	24830	Looper (right hand) Driving Lever with 1083C and two 140596AL
164598	.....	Looper (right hand) Driving Lever 164062 with 1443J, 1700J, 132565, 164056, 164057, 164061, 164068, 164397, 164595 and 164597
1083C	24830	Looper (right hand) Driving Lever Clamping Screw
140596AL	24830	Looper (right hand) Driving Lever Set Screw (2)
164063	24830	Looper (right hand) Driving Shaft
164049	24830	Looper (right hand) Driving Shaft Bushing (back)
140394E	24830	Looper (right hand) Driving Shaft Bushing (back) Cap Screw
164293	24830	Looper (right hand) Driving Shaft Bushing (back) Cap Screw Washer (fiber)
164599	24830	Looper (right hand) Driving Shaft Bushing (front)
164066	24830	Looper (right hand) Driving Shaft Crank with 1083C
164216	.....	Looper (right hand) Driving Shaft Crank 164066 with 164052

No.	Plate	Name
1083C	24830	Looper (right hand) Driving Shaft Crank Clamping Screw
164052	24812	Looper (right hand) Driving Shaft Crank Connection with two each 171AL and 140159AL
171AL	24812	Looper (right hand) Driving Shaft Crank Connection Cap (lower) Screw (2)
140159AL	24812	Looper (right hand) Driving Shaft Crank Connection Cap (upper) Screw (2)
164067	24830	Looper (right hand) Driving Shaft Crank Key
1324C	24830	Looper (right hand) Driving Shaft Crank Key Screw
45057	24830	Looper (right hand) Driving Shaft Crank Key Screw Washer
164053	24830	Looper (right hand) Driving Shaft Crank Thrust Bearing
164068	24830	Looper (right hand) Locking Screw Stud
1700J	24830	Looper (right hand) Locking Screw Stud Nut
164219	24830	Looper (right hand) Position Collar with 904AL
904AL	24830	Looper (right hand) Position Collar Set Screw
*164072APP	.....	Machine Frame
*164526	.....	Machine Frame complete, Nos. 140396L, 164072APP, 164077, 164528 and three 140395F
164074	24813	Machine Frame Bottom Cover
164075	24813	Machine Frame Bottom Cover Gasket
914C	24813	Machine Frame Bottom Cover Screw (13)
*164527	.....	Machine Frame Bracket
*164528	.....	Machine Frame Bracket 164527 with 164207 and two 187E
164207	24831	Machine Frame Bracket Key
187E	24831	Machine Frame Bracket Key Screw (2)
140396L	24831	Machine Frame Bracket Screw (large)
164077	24831	Machine Frame Bracket Screw (large) Washer (fiber)
164229	24831	Machine Frame Bracket Screw (large) Washer (felt)
140395F	24831	Machine Frame Bracket Screw (small) (3)
164515	24813	Machine Frame Cover (back)
50571J	24813	Machine Frame Cover (back) Screw (long) (2)
914J	24813	Machine Frame Cover (back) Screw (short)
164516	24813	Machine Frame Cover (back) 164515 with 1637K and 140278C
164081	24831	Machine Frame Oil Lead
140088R	24831	Machine Frame Oil Lead Screw
1698J	24831	Machine Frame Oil Lead Screw Nut
164082	24831	Machine Frame Oil Plug Bracket
1036AL	24831	Machine Frame Oil Plug Bracket Set Screw
164083	24831	Machine Frame Oil Screen
206J	24831	Machine Frame Oil Screen Screw (3)
164603	24831	Machine Frame Oil Splash Guard (internal)
164605	24831	Machine Frame Oil Splash Guard (internal) Oil Pad
164606	24831	Machine Frame Oil Splash Guard (internal) Oil Pad Fastener
164604	24831	Machine Frame Oil Splash Guard (internal) complete, Nos. 164603, 164605 and 164606
164085	24829	Machine Frame Oil Splash Guard (top)
51023W	24829	Machine Frame Oil Splash Guard (top) Screw (2)
164722	24831	Machine Frame Oil Tube with 164602
50421AL	24831	Machine Frame Oil Tube Set Screw
164602	24831	Machine Frame Oil Tube Wick
164089	24812	Machine Frame Rotary Shaft
164090	.....	Machine Frame Rotary Shaft 164089 with 164097, 164215, 164216, 164217 and two each 164093 and 164232
139026	24812	Machine Frame Rotary Shaft Ball Bearing
164092	24812	Machine Frame Rotary Shaft Ball Bearing Housing
51369C	24812	Machine Frame Rotary Shaft Ball Bearing Housing Screw (3)
164093	24812	Machine Frame Rotary Shaft Ball Sleeve (two pieces) (2)

*Compare to # 1641959 oil*

No.	Plate	Name
164232	24812	Machine Frame Rotary Shaft Ball Sleeve Guide (2)
164600	24812	Machine Frame Rotary Shaft Bushing (front)
1036AL	24812	Machine Frame Rotary Shaft Bushing (front) Set Screw
164095	24812	Machine Frame Rotary Shaft Bushing (intermediate)
51332C	24812	Machine Frame Rotary Shaft Bushing (intermediate) Set Screw
164096	24812	Machine Frame Rotary Shaft Counterbalance with 1036AL
1036AL	24812	Machine Frame Rotary Shaft Counterbalance Set Screw
164097	24812	Machine Frame Rotary Shaft Key
51649C	24812	Machine Frame Rotary Shaft Nut
131056	24812	Machine Frame Rotary Shaft Nut Washer
164098	24812	Machine Frame Rotary Shaft Oil Return and Ball Bearing Grease Retainer
164099	24812	Machine Frame Rotary Shaft Screw Stud
164100	24812	Machine Frame Rotary Shaft Thrust Bearing
164101APP	24772	Machine Frame Top Cover
164214	.....	Machine Frame Top Cover 164101APP with 330J, 164103 and two 164418
164102	24772	Machine Frame Top Cover Gasket
164103	24772	Machine Frame Top Cover Oil Lead
330J	24772	Machine Frame Top Cover Oil Lead Screw
51369J	24772	Machine Frame Top Cover Screw (3)
164231	24812	Machine Pulley (round and "V" belt) with two 148A1
164071	24812	Machine Pulley Cap
140416X	24812	Machine Pulley Cap Screw
448AL	24812	Machine Pulley Set Screw (2)
164109	24829	Needle Clamp
51720C	24829	Needle Clamping Nut
164110	24829	Needle Driving Shaft with 164118
164275	.....	Needle Driving Shaft 164110 with 51720C, 164109 and 164117
164111	24829	Needle Driving Shaft Bushing
164112	24829	Needle Driving Shaft Bushing Cap
164113	24829	Needle Driving Shaft Bushing Oil Lead
452AL	24829	Needle Driving Shaft Bushing Oil Lead Hole Plug Screw
164114	24829	Needle Driving Shaft Crank with 1083C and two 140596AL
164115	24829	Needle Driving Shaft Crank Ball
1083C	24829	Needle Driving Shaft Crank Clamping Screw
164217	24812	Needle Driving Shaft Crank Connection with 164115 and two each 157AL and 171AL
157AL	24812	Needle Driving Shaft Crank Connection Cap (lower) Screw (2)
171AL	24812	Needle Driving Shaft Crank Connection Cap (upper) Screw (2)
140596AL	24829	Needle Driving Shaft Crank Set Screw (2)
164117	24829	Needle Holder
164118	24829	Needle Stop Pin
164119	24812	Oil Agitator
164120	24831	Oil Cooler, Nos. two 164125
164121	24831	Oil Cooler Cover
4123	24831	Oil Cooler Cover 164121 with 164135
4122	24831	Oil Cooler Cover Gasket
145J	24831	Oil Cooler Cover Screw
64124	24831	Oil Cooler Gasket
64125	24831	Oil Cooler Oil Pipe (outlet, left)
164125	24831	Oil Cooler Oil Pipe (outlet, right)
164126	24831	Oil Cooler Oil Tube with 138269 and 164128
164127	24831	Oil Cooler Oil Tube Coupling
51630	24831	Oil Cooler Oil Tube Lock Nut
138269	24831	Oil Cooler Oil Tube Sleeve
164128	24831	Oil Cooler Oil Tube Wick

No.	Plate	Name
51139J	24831	Oil Cooler Screw (long) (2)
1324J	24831	Oil Cooler Screw (short)
164135	24831	Oil Cup for filling machine
164607	24828	Oil Deflector
164131	24831	Oil Sight Gauge Background Disc
164132	24831	Oil Sight Gauge Background Disc Gasket
164133	24831	Oil Sight Gauge Window
164132	24831	Oil Sight Gauge Window Gasket
164134	24831	Oil Sight Gauge Window Retainer
164132	24831	Oil Sight Gauge Window Retainer Gasket
1485J	24831	Oil Sight Gauge Window Retainer Screw (2)
164136	24828	Presser Bar Bracket
164137	24829	Presser Bar Lifting Bracket with 462AL, 624AL and 51846
51846	24829	Presser Bar Lifting Bracket Roller and Stud
624AL	24829	Presser Bar Lifting Bracket Set Screw (long)
462AL	24829	Presser Bar Lifting Bracket Set Screw (short)
164138	24829	Presser Bar Lifting Lever
164139	24829	Presser Bar Lifting Lever Spring
140228C	24813	Presser Bar Lifting Lever Stop Screw
1637K	24813	Presser Bar Lifting Lever Stop Screw Nut
164350	24828	Presser Bar (swing-out)
164141	24828	Presser Bar (swing-out) Lifting Screw Stud
1700J	24828	Presser Bar (swing-out) Lifting Screw Stud Nut
164142	24829	Presser Bar (swing-out) Opening Lever
50060K	24829	Presser Bar (swing-out) Opening Lever Hinge Screw
140510C	24828	Presser Bar (swing-out) Pivot Screw
164351	24828	Presser Bar (swing-out) Pivot Screw Lock Washer
51362AL	24828	Presser Bar (swing-out) Pivot Screw Lock Washer Screw
164143	24829	Presser Bar (upright)
164144	24829	Presser Bar (upright) Spring
164416	.....	Presser Bar (upright) Spring (heavy)
164145	24832	Presser Foot Body
164220	24832	Presser Foot Chain Cutter Friction Plate
164221	24832	Presser Foot Chain Cutter Knife
51306E	24832	Presser Foot Chain Cutter Knife Screw
164146	24832	Presser Foot Chaining-off Finger
164147	24832	Presser Foot Clamping Plate
50225J	24832	Presser Foot Clamping Plate Screw
164149	24832	Presser Foot Guide
50169J	24832	Presser Foot Guide Screw
164150	24832	Presser Foot complete, Nos. 50169J, 50225J, 51306E, 164145, 164146, 164147, 164149, 164220 and 164221
164194	24829	Pressure Regulating Thumb Screw
2102	24772	Tension (heavy) Disc (4)
164155	24772	Tension (heavy) Regulating Thumb Nut (2)
50133C	24772	Tension (heavy) Screw Stud (2)
164156	.....	Tension (heavy) Screw Stud 50133C and 164155 (2)
164161	24772	Tension (heavy) Spring (2)
59537	24772	Tension (heavy) Spring Bushing (2)
164158	24772	Tension (heavy) Spring Cover (2)
164162	24772	Tension (heavy) complete, Nos. 59537, 164156, 164158, 164161 and two 2102 (2)
2102	24772	Tension (light) Disc (2)
164155	24772	Tension (light) Regulating Thumb Nut
50133C	24772	Tension (light) Screw Stud
164156	.....	Tension (light) Screw Stud 50133C with 164155
164157	24772	Tension (light) Spring
59537	24772	Tension (light) Spring Bushing
164158	24772	Tension (light) Spring Cover
164160	24772	Tension (light) complete, Nos. 59537, 164156, 164157, 164158 and two 2102
164285	24772	Tension (looper thread) Thread Guide (left)
164286	24772	Tension (looper thread) Thread Guide (right)



No.	Plate	Name
164159	24772	Tension (needle thread) Thread Guide
164418	24772	Tension Thread Eyelet (2)
164091	24830	Thread (looper, right hand) Stripper and Take up with 164555
164163	24761	Thread (looper, right hand) Stripper and Take up Eyelet (adjustable)
1443J	24761	Thread (looper, right hand) Stripper and Take up Eyelet (adjustable) Screw
164555	.....	Thread (looper, right hand) Stripper and Take up Guide Wire
187E	24830	Thread (looper, right hand) Stripper and Take up Screw
17022	24830	Thread (looper, right hand) Stripper and Take up Screw Washer
164164	24761	Thread (looper, right hand) Thread Eyelet (movable)
1423J	24761	Thread (looper, right hand) Thread Eyelet Screw
164165	24761	Thread (looper, right hand) Thread Eyelet (stationary)
1607J	24761	Thread (looper, right hand) Thread Eyelet (stationary) Nut
164166	24761	Thread (looper, right hand) Tube
624AL	24761	Thread (looper, right hand) Tube Set Screw
164167	24761	Thread (looper) Plate with 624AL
164168	24761	Thread (looper) Plate Cover
164206	.....	Thread (looper) Plate Cover 164168 with 164169 and 164170
164169	24761	Thread (looper) Plate Cover Hinge
164170	24761	Thread (looper) Plate Cover Hinge Pin
164171	24761	Thread (looper) Plate Cover Spring (2)
332J	24761	Thread (looper) Plate Cover Spring Screw (2)
896AL	24761	Thread (looper) Plate Screw (2)
164173	24761	Thread (looper) Plate Thread Bushing
50318W	24761	Thread (looper) Plate Thread Bushing Screw
164174	.....	Thread (looper) Plate complete, Nos. 1423J, 1443J, 1607J, 50318W, 164163, 164164, 164165, 164166, 164167, 164173, 164206 and two each 332J and 164171
164175	24830	Thread (looper) Take-up (left)
164176	24830	Thread (looper) Take-up Plate
190E	24830	Thread (looper) Take-up Screw (lower)
1443J	24830	Thread (looper) Take-up Screw (upper)
164151	24828	Thread (needle) Controller
164153	24828	Thread (needle) Controller Lever
1443J	24828	Thread (needle) Controller Screw (2)
164177	24828	Thread Eyelet (needle thread)
140239AL	24828	Thread Eyelet (needle thread) Set Screw
164178	24832	Throat Plate
164591	24832	Throat Plate Guide with 853AL
1454E	24832	Throat Plate Guide Screw
1094F	24832	Throat Plate Screw (2)

SET OF FITTINGS COMPLETE No. 164270  
FOR RAYON, GLOVE SILK AND LIGHTWEIGHT MATERIALS  
FOR THREE-THREAD TIGHT STITCH  
FOR 1/8 INCH BIGHT

No.	Plate	Name
NOTE: This machine is regularly fitted with Set No. 164270, unless other Fittings are specified on order.		
164011	24833	Feed (back) Dog Section (left)
164012	24833	Feed (back) Dog Section (right)
1100AL	24833	Feed (back) Dog Section (right) Screw
164013	24833	Feed (back) Dog complete, Nos. 1100AL, 164011 and 164012
164019	24833	Feed (front) Dog
164550	24833	Knife (movable)
164055	24833	Looper (right)
164350	24833	Presser Bar (swing-out)
164145	24833	Presser Foot Body
164220	24833	Presser Foot Chain Cutter Friction Plate
164221	24833	Presser Foot Chain Cutter Knife
51306F	24833	Presser Foot Chain Cutter Knife Screw
164146	24833	Presser Foot Chaining-off Finger
164147	24833	Presser Foot Clamping Plate
50225J	24833	Presser Foot Clamping Plate Screw
164149	24833	Presser Foot Guide
50169J	24833	Presser Foot Guide Screw
164150	24833	Presser Foot with Chain Cutter complete, Nos. 50169J, 50225J, 51306F, 164145, 164146, 164147, 164149, 164220 and 164221
164175	24833	Thread (looper) Take-up
164091	24833	Thread (looper, right hand) Stripper and Take up
164151	24833	Thread (needle) Controller
164178	24833	Throat Plate
164591	24833	Throat Plate Guide with 853AL
164270	24833	Set of Fittings complete, Nos. 164013, 164019, 164055, 164091, 164150, 164151, 164175, 164178, 164350, 164550 and 164591

SET OF FITTINGS COMPLETE No. 164266  
FOR LINGERIE, CREPE DE CHINE, SILK AND RAYON  
FOR THREE-THREAD TIGHT STITCH  
FOR 3/32 INCH BIGHT

No.	Plate	Name
164254	24834	Feed (back) Dog Section (left)
164255	24834	Feed (back) Dog Section (right)
1100AL	24834	Feed (back) Dog Section (right) Screw
164256	24834	Feed (back) Dog complete, Nos. 1100AL, 164254 and 164255
164257	24834	Feed (front) Dog
164258	24834	Presser Bar (swing-out)
164259	24834	Presser Foot Body
164260	24834	Presser Foot Chain Cutter Friction Plate
164261	24834	Presser Foot Chain Cutter Knife
51306E	24834	Presser Foot Chain Cutter Knife Screw
164262	24834	Presser Foot Chaining-off Finger
164263	24834	Presser Foot Clamping Plate
50225J	24834	Presser Foot Clamping Plate Screw
164264	24834	Presser Foot with Chain Cutter complete, Nos. 50225J, 51306E, 164259, 164260, 164261, 164262 and 164263
164265	24834	Throat Plate
164612	24834	Throat Plate Guide with 853AL
164266	24834	Set of Fittings complete, Nos. 164256, 164257, 164258, 164264, 164265 and 164612
NOTE: When using Set of Fittings complete No. 164266, the following parts which are not included in this Set of Fittings, are necessary, if machine has previously been fitted other than regular (see Set of Fittings No. 164270).		
164550	24834	Knife (movable)
164055	24834	Looper (right hand)
164175	24834	Thread (looper, left hand) Take-up
164091	24834	Thread (looper, right hand) Take-up
164151	24834	Thread (needle) Controller

**SINGER** Needles should be used  
in **SINGER** Machines  
These Needles and their Containers  
are marked with the  
Company's Trade Mark "SIMANCO.\*\*" 1

Needles in Containers marked  
"FOR SINGER MACHINES"  
are NOT **SINGER** made needles. 2

SET OF FITTINGS COMPLETE No. 164271  
FOR RAYON, GLOVE SILK AND LIGHTWEIGHT MATERIALS  
FOR THREE-THREAD TIGHT STITCH  
FOR 3/32 INCH BIGHT

No.	Plate	Name
NOTE: No. 164271 Set of Fittings complete is numbered only for identifying purposes in the factory. It is not necessary for Agencies to order this number when converting a machine in the field, unless machine has been fitted other than regular, as part number 164267, Throat Plate, in place of part number 164178 is only part required.		
164267	24835	Throat Plate
NOTE: When using Set of Fittings complete No. 164271, the following parts which are not included in this Set of Fittings, are necessary, if machine has previously been fitted other than regular (see Set of Fittings complete No. 164270)		
164011	24835	Feed (back) Dog Section (left)
164012	24835	Feed (back) Dog Section (right)
1100AL	24835	Feed (back) Dog Section (right) Screw
164013	24835	Feed (back) Dog complete, Nos. 1100AL, 164011 and 164012
164019	24835	Feed (front) Dog
164550	24835	Knife (movable)
164055	24835	Looper (right Hand)
164350	24835	Presser Bar (swing-out)
164145	24835	Presser Foot Body
164220	24835	Presser Foot Chain Cutter Friction Plate
164221	24835	Presser Foot Chain Cutter Knife
51306E	24835	Presser Foot Chain Cutter Knife Screw
164146	24835	Presser Foot Chaining-off Finger
164147	24835	Presser Foot Clamping Plate
50225J	24835	Presser Foot Clamping Plate Screw
164149	24835	Presser Foot Guide
50169J	24835	Presser Foot Guide Screw
164150	24835	Presser Foot with Chain Cutter complete, Nos. 50169J, 50225J, 51306E, 164145, 164146, 164147, 164149, 164220 and 164221
164175	24835	Thread (looper) Take-up
164091	24835	Thread (looper, right hand) Stripper and Take-up
164151	24835	Thread (needle) Controller
164591	24835	Throat Plate Guide with 853AL

SET OF FITTINGS COMPLETE No. 164272  
FOR LIGHT AND MEDIUM SWEATER MATERIALS  
FOR THREE-THREAD TIGHT STITCH  
FOR 3/32 INCH BIGHT

No.	Plate	Name
164222	24836	Feed (back) Dog Section (left)
164223	24836	Feed (back) Dog Section (right)
1100AL	24836	Feed (back) Dog Section (right) Screw
164224	24836	Feed (back) Dog complete, Nos. 1100AL, 164222, and 164223
164225	24836	Feed (front) Dog
164556	24836	Knife (movable, serrated)
164145	24836	Presser Foot Body
164220	24836	Presser Foot Chain Cutter Friction Plate
164221	24836	Presser Foot Chain Cutter Knife
51306E	24836	Presser Foot Chain Cutter Knife Screw
164146	24836	Presser Foot Chaining off Finger
164147	24836	Presser Foot Clamping Plate
50225J	24836	Presser Foot Clamping Plate Screw
164360	24836	Presser Foot Guide
50169J	24836	Presser Foot Guide Screw
164362	24836	Presser Foot with Chain Cutter complete, Nos. 50169J, 50225J, 51306E, 164145, 164146, 164147, 164220, 164221 and 164360
164226	24836	Throat Plate
164272	24836	Set of Fittings complete, Nos. 164224, 164225, 164226, 164362 and 164556
NOTE: When using Set of Fittings complete No. 164272 the following parts which are not included in this Set of Fittings, are necessary, if machine has previously been fitted other than regular (see Set of Fittings No. 164270)		
164055	24836	Looper (right hand)
164350	24836	Presser Bar (swing out)
164175	24836	Thread (looper) Take up
164091	24836	Thread (looper, right hand) Stripper and Take up
164151	24836	Thread (needle) Controller
164591	24836	Throat Plate Guide with 853AL

SET OF FITTINGS COMPLETE No. 164273  
FOR LIGHT AND MEDIUM SWEATER MATERIALS  
FOR THREE-THREAD TIGHT STITCH  
FOR 1/8 INCH BIGHT

No.	Plate	Name
164222	24837	Feed (back) Dog Section (left)
164223	24837	Feed (back) Dog Section (right)
1100AL	24837	Feed (back) Dog Section (right) Screw
164224	24837	Feed (back) Dog complete, Nos. 1100AL, 164222 and 164223
164225	24837	Feed (front) Dog
164556	24837	Knife (movable, serrated)
164145	24837	Presser Foot Body
164220	24837	Presser Foot Chain Cutter Friction Plate
164221	24837	Presser Foot Chain Cutter Knife
51306E	24837	Presser Foot Chain Cutter Knife Screw
164146	24837	Presser Foot Chaining off Finger
164147	24837	Presser Foot Clamping Plate
50225J	24837	Presser Foot Clamping Plate Screw
164360	24837	Presser Foot Guide
50169J	24837	Presser Foot Guide Screw
164362	24837	Presser Foot with Chain Cutter complete, Nos. 50169J, 50225J, 51306E, 164145, 164146, 164147, 164220, 164221 and 164360
164227	24837	Throat Plate
164273	24837	Set of Fittings complete, Nos. 164224, 164225, 164227, 164362 and 164556
NOTE: When using Set of Fittings complete No. 164273 the following parts which are not included in this Set of Fittings, are necessary, if machine has previously been fitted other than regular (see Set of Fittings No. 164270)		
164055	24837	Looper (right hand)
164350	24837	Presser Bar (swing out)
164175	24837	Thread (looper) Take up
164091	24837	Thread (looper, right hand) Stripper and Take up
164151	24837	Thread (needle) Controller
164591	24837	Throat Plate Guide with 853AL

SET OF FITTINGS COMPLETE No. 164274  
FOR LIGHT AND MEDIUM SWEATER MATERIALS  
FOR THREE-THREAD TIGHT STITCH  
FOR 5/32 INCH BIGHT

No.	Plate	Name
164222	24838	Feed (back) Dog Section (left)
164223	24838	Feed (back) Dog Section (right)
1100AL	24838	Feed (back) Dog Section (right) Screw
164224	24838	Feed (back) Dog complete, Nos. 1100AL, 164222 and 164223
164225	24838	Feed (front) Dog
164556	24838	Knife (movable, serrated)
164145	24838	Presser Foot Body
164220	24838	Presser Foot Chain Cutter Friction Plate
164221	24838	Presser Foot Chain Cutter Knife
51306E	24838	Presser Foot Chain Cutter Knife Screw
164146	24838	Presser Foot Chaining off Finger
164147	24838	Presser Foot Clamping Plate
50225J	24838	Presser Foot Clamping Plate Screw
164360	24838	Presser Foot Guide
50169J	24838	Presser Foot Guide Screw
164362	24838	Presser Foot with Chain Cutter complete, Nos. 50169J, 50225J, 51306E, 164145, 164146, 164147, 164220, 164221, and 164360
164228	24838	Throat Plate
164274	24838	Set of Fittings complete, Nos. 164224, 164225, 164228, 164362 and 164556
NOTE: When using Set of Fittings complete No. 164274 the following Parts which are not included in this Set of Fittings, are necessary, if machine has previously been fitted other than regular (see Set of Fittings No. 164270)		
164055	24838	Looper (right Hand)
164350	24838	Presser Bar (swing out)
164175	24838	Thread (looper) Take-up
164091	24838	Thread (looper, right hand) Stripper and Take up
164151	24838	Thread (needle) Controller
164591	24838	Throat Plate Guide with 853AL

SET OF FITTINGS COMPLETE No. 164344  
FOR INSERTING ELASTIC, 1/8 INCH TO 3/16 INCH AND FOR  
STITCHING THROUGH TAPE 3/16 INCH WIDE  
FOR RAYON AND LIGHT AND MEDIUM WEIGHT SWEATER MATERIALS  
FOR THREE-THREAD PURL-ON-EDGE STITCH

No.	Plate	Name
164337	24839	Guide for elastic and tape
51614J	24839	Guide Nut
164338	24839	Presser Foot Body
164339	24839	Presser Foot Chaining-off Finger
164340	24839	Presser Foot Clamping Plate
50225J	24839	Presser Foot Clamping Plate Screw
164341	24839	Presser Foot Guide (adjustable) for Stitching through tape 3/16" wide
164342	24839	Presser Foot Guide (adjustable) for use when inserting elastic 1/8" to 3/16" wide
50169J	24839	Presser Foot Guide (adjustable) Screw
164343	24839	Presser Foot complete, Nos. 50169J, 50225J, 164338, 164339, 164340, 164341 and 164342
164344	24839	Set of Fittings complete Nos. 51614J, 164337 and 164343
NOTE: When using Set of Fittings complete No. 164344 the following Parts which are not included in this Set of Fittings, are necessary, if machine has previously been fitted other than regular (see Set of Fittings No. 164270).		
164011	24839	Feed (back) Dog Section (left)
164012	24839	Feed (back) Dog Section (right)
1100AL	24839	Feed (back) Dog Section (right) Screw
164013	24839	Feed (back) Dog complete, Nos. 1100AL, 164011 and 164012
164019	24839	Feed (front) Dog
164550	24839	Knife (movable)
164055	24839	Looper (right Hand)
164350	24839	Presser Bar (swing-out)
164175	24839	Thread (looper) Take-up (left)
164091	24839	Thread (looper) Take-up (right)
164178	24839	Throat Plate
164591	24839	Throat Plate Guide with 853AL

SET OF FITTINGS COMPLETE, No. 164388  
 FOR SWEATER MATERIALS  
 FOR TWO-THREAD STITCH  
 FOR 1/8 INCH BIGHT

No.	Plate	Name
164222	24840	Feed (back) Dog Section (left)
164223	24840	Feed (back) Dog Section (right)
1100AL	24840	Feed (back) Dog Section (right) Screw
164224	24840	Feed (back) Dog complete, Nos. 1100AL, 164222 and 164223
164225	24840	Feed (front) Dog
164556	24840	Knife (movable, serrated)
164145	24840	Presser Foot Body
164220	24840	Presser Foot Chain Cutter Friction Plate
164221	24840	Presser Foot Chain Cutter Knife
51306E	24840	Presser Foot Chain Cutter Knife Screw
164146	24840	Presser Foot Chaining-off Finger
164147	24840	Presser Foot Clamping Plate
50225J	24840	Presser Foot Clamping Plate Screw
164360	24840	Presser Foot Guide
50169J	24840	Presser Foot Guide Screw
164362	24840	Presser Foot with Chain Cutter complete, Nos. 50169J, 50225J, 51306E, 164145, 164146, 164147, 164220, 164221 and 164360
164252	24840	Spreader
164381	24840	Thread (needle) Controller
164227	24840	Throat Plate
164388	24840	Set of Fittings complete, Nos. 164224, 164225, 164227, 164252, 164362, 164381 and 164556
NOTE: When using Set of Fittings complete No. 164388 the following parts which are not included in this Set of Fittings, are necessary, if machine has previously been fitted other than regular (see Set of Fittings No. 164270)		
164350	24840	Presser Bar (swing out)
164091	24840	Thread (looper) Stripper and Take up
164175	24840	Thread (looper) Take up
164591	24840	Throat Plate Guide with 853AL

SET OF FITTINGS COMPLETE No. 164389  
 FOR FOUNDATION GARMENTS  
 FOR TWO-THREAD STITCH

No.	Plate	Name
164322	24841	Feed (back) Dog Section (left)
164323	24841	Feed (back) Dog Section (right)
1100AL	24841	Feed (back) Dog Section (right) Screw
164324	24841	Feed (back) Dog complete, Nos. 1100AL, 164322 and 164323
164325	24841	Feed (front) Dog
164258	24841	Presser Bar (swing-out)
164259	24841	Presser Foot Body
164260	24841	Presser Foot Chain Cutter Friction Plate
164261	24841	Presser Foot Chain Cutter Knife
51306E	24841	Presser Foot Chain Cutter Knife Screw
164262	24841	Presser Foot Chaining off Finger
164263	24841	Presser Foot Clamping Plate
50225J	24841	Presser Foot Clamping Plate Screw
164264	24841	Presser Foot complete, Nos. 50225J, 51306E, 164259, 164260, 164261, 164262 and 164263
164252	24841	Spreader
164290	24841	Throat Plate
164612	24841	Throat Plate Guide with 853AL
164389	24841	Set of Fittings complete, Nos. 164252, 164258, 164264, 164290, 164324, 164325 and 164612
NOTE: When using Set of Fittings complete No. 164389 the following Parts which are not included in this Set of Fittings, are necessary, if machine has previously been fitted other than regular (see Set of Fittings No. 164270)		
164550	24841	Knife (movable)
164091	24841	Thread (looper) Stripper and Take-up
164175	24841	Thread (looper) Take up
164151	24841	Thread (needle) Controller

SET OF FITTINGS COMPLETE No. 164390  
FOR FOUNDATION GARMENTS  
FOR THREE-THREAD STITCH

No.	Plate	Name
164322	24842	Feed (back) Dog Section (left)
164323	24842	Feed (back) Dog Section (right)
1100AL	24842	Feed (back) Dog Section (right) Screw
164324	24842	Feed (back) Dog complete, Nos. 1100AL, 164322 and 164323
164325	24842	Feed (front) Dog
164258	24842	Presser Bar (swing-out)
164259	24842	Presser Foot Body
164260	24842	Presser Foot Chain Cutter Friction Plate
164261	24842	Presser Foot Chain Cutter Knife
51306E	24842	Presser Foot Chain Cutter Knife Screw
164262	24842	Presser Foot Chaining off Finger
164263	24842	Presser Foot Clamping Plate
50225J	24842	Presser Foot Clamping Plate Screw
164264	24842	Presser Foot with Chain Cutter Complete, Nos. 50225J, 51306E, 164259, 164260, 164261, 164262 and 164263
164290	24842	Throat Plate
164612	24842	Throat Plate Guide with 853AL
164390	24842	Set of Fittings complete, Nos. 164258, 164264, 164290, 164324, 164325 and 164612

NOTE: When using Set of Fittings complete No. 164390 the following parts which are not included in this Set of Fittings, are necessary, if machine has previously been fitted other than regular (see Set of Fittings No. 164270)

164550	24842	Knife (movable)
164055	24842	Looper (right hand)
164175	24842	Thread (looper) Take-up
164091	24842	Thread (looper, right hand) Stripper and Take-up
164151	24842	Thread (needle) Controller

SET OF FITTINGS COMPLETE, No. 164395  
FOR TRIMMING AND FOLDING THE EDGE AND OVEREDGING CURTAINS  
FOR TWO-THREAD STITCH

No.	Plate	Name
164530	24843	Guide (swing-out)
164297	24843	Guide (swing-out) Arm
164298	24843	Guide (swing-out) Arm Holder
50267R	24843	Guide (swing-out) Arm Holder Screw (2)
164541	24843	Guide (swing-out) Arm Lock Spring
1423J	24843	Guide (swing-out) Arm Lock Spring Screw
1550J	24843	Guide (swing-out) Arm Lock Spring Screw Nut
164502	24843	Guide (swing-out) Extension (lower)
164299	24843	Guide (swing-out) Extension (upper)
197J	24843	Guide (swing-out) Extension Screw
164503		Guide (swing-out) with Extensions complete, Nos. 197J, 164299, 164502 and 164530
1425J	24843	Guide (swing-out) Hinge Screw
42436	24843	Guide (swing-out) Hinge Screw Washer
1443J	24843	Guide (swing-out) Screw (2)
164311	24843	Guide (swing-out) with Arm and Holder complete, Nos. 14231, 1425J, 1550J, 42436, 164297, 164298, 164503, 164541 and two 1443J
164145	24843	Presser Foot Body
164220	24843	Presser Foot Chain Cutter Friction Plate
164221	24843	Presser Foot Chain Cutter Knife
51306E	24843	Presser Foot Chain Cutter Knife Screw
164392	24843	Presser Foot Chaining off Finger
164147	24843	Presser Foot Clamping Plate
50225J	24843	Presser Foot Clamping Plate Screw
164149	24843	Presser Foot Guide
50169J	24843	Presser Foot Guide Screw
164393	24843	Presser Foot with Chain Cutter complete, Nos. 50169J, 50225J, 51306E, 164145, 164147, 164149, 164220, 164221 and 164392
164252	24843	Spreader
164404	24843	Tension (looper thread) Spring
164662	24843	Throat Plate with 164663
164663	24843	Throat Plate Thread Finger
164395	24843	Set of Fittings complete, Nos. 164252, 164311, 164393, 164404, 164662 and two 50267R

NOTE: When using Set of Fittings complete No. 164395 the following parts which are not included in this Set of Fittings, are necessary, if machine has previously been fitted other than regular (see Set of Fittings No. 164270).

164011	24843	Feed (back) Dog Section (left)
164012	24843	Feed (back) Dog Section (right)
1100AL	24843	Feed (back) Dog Section (right) Screw
164013	24843	Feed (back) Dog complete, Nos. 1100AL, 164011, and 164012
164019	24843	Feed (front) Dog
164550	24843	Knife (movable)
164350	24843	Presser Bar (swing out)
164091	24843	Thread (looper) Stripper and Take-up
164175	24843	Thread (looper) Take-up
164151	24843	Thread (needle) Controller
164591	24843	Throat Plate Guide with 853AL

SET OF FITTINGS COMPLETE No. 164431  
FOR PLASTIC MATERIALS  
FOR THREE-THREAD STITCH

No.	Plate	Name
164279	24844	Feed Dog Section (left)
164280	24844	Feed Dog Section (right)
1100AL	24844	Feed Dog Section (right) Screw
164281	24844	Feed Dog complete, Nos. 1100AL, 164279 and 164280
164258	24844	Presser Bar (swing-out)
164282	24844	Presser Foot Chaining-off Finger
164263	24844	Presser Foot Clamping Plate
50225J	24844	Presser Foot Clamping Plate Screw
164429	24844	Presser Foot Plate
140180J	24844	Presser Foot Screw
164430	24844	Presser Foot complete, Nos. 50225J, 164263, 164282, and 164429
164290	24844	Throat Plate
164612	24844	Throat Plate Guide with 853AI
164431	24844	Set of Fittings complete, Nos. 140180J, 164258, 164281, 164290, 164430 and 164612

NOTE: When using Set of Fittings complete No. 164431 the following parts which are not included in this Set of Fittings, are necessary, if machine has previously been fitted other than regular (see Set of Fittings No. 164270)

164550	24844	Knife (movable)
164055	24844	Looper (right Hand)
164175	24844	Thread (looper) Take-up
164091	24844	Thread (looper, right hand) Stripper and Take up
164151	24844	Thread (needle) Controller

SET OF FITTINGS COMPLETE No. 164435  
FOR JOINING LACE TO UNDERGARMENTS  
FOR TWO-THREAD STITCH

No.	Plate	Name
164279	24845	Feed Dog Section (left)
164280	24845	Feed Dog Section (right)
1100AL	24845	Feed Dog Section (right) Screw
164281	24845	Feed Dog complete, Nos. 1100AL, 164279 and 164280
164530	24845	Guide (swing-out)
164297	24845	Guide (swing-out) Arm
164298	24845	Guide (swing-out) Arm Holder
50267R	24845	Guide (swing out) Arm Holder Screw (2)
164541	24845	Guide (swing out) Arm Lock Spring
1423J	24845	Guide (swing out) Arm Lock Spring Screw
1550J	24845	Guide (swing out) Arm Lock Spring Screw Nut
1425J	24845	Guide (swing out) Hinge Screw
42436	24845	Guide (swing out) Hinge Screw Washer
1443J	24845	Guide (swing-out) Screw (2)
164432	24845	Guide (swing out) Separating Blade
164436	24845	Guide (swing out) Separating Blade Holder
228J	24845	Guide (swing out) Separating Blade Holder Screw
164433	24845	Guide (swing out) with Arm, Holder and Separating Blade complete, Nos. 228J, 1423J, 1425J, 1550J, 42436, 164297, 164298, 164432, 164436, 164530, 164541 and two 1443J
164258	24845	Presser Bar (swing out)
164259	24845	Presser Foot Body
164260	24845	Presser Foot Chain Cutter Friction Plate
164261	24845	Presser Foot Chain Cutter Knife
51306E	24845	Presser Foot Chain Cutter Knife Screw
164262	24845	Presser Foot Chaining-off Finger
164263	24845	Presser Foot Clamping Plate
50225J	24845	Presser Foot Clamping Plate Screw
164264	24845	Presser Foot with Chain Cutter complete, Nos. 50225J, 51306E, 164259, 164260, 164261, 164262 and 164263
164252	24845	Spreader
164434	24845	Throat Plate
164612	24845	Throat Plate Guide with 853AI
164435	24845	Set of Fittings complete, Nos. 164252, 164258, 164264, 164281, 164433, 164434, 164612 and two 50267R

NOTE: When using Set of Fittings complete No. 164435 the following parts which are not included in this Set of Fittings, are necessary, if machine has previously been fitted other than regular (see Set of Fittings No. 164270).

164550	24845	Knife (movable)
164091	24845	Thread (looper) Stripper and Take-up
164175	24845	Thread (looper) Take-up

SET OF FITTINGS COMPLETE No. 164437  
 FOR STRETCHING AND INSERTING ELASTIC, 1/8 INCH TO 3/16 INCH AND  
 FOR STITCHING THROUGH TAPE 3/16 INCH WIDE  
 FOR RAYON AND LIGHT AND MEDIUM WEIGHT SWEATER MATERIALS  
 FOR THREE-THREAD PURL-ON-EDGE STITCH

No.	Plate	Name
160591	24846	Elastic Guide (movable)
160592	24846	Elastic Guide (stationary)
160593	24846	Elastic Guide Bracket with 10248 and 120565
337J	24846	Elastic Guide Screw (4)
51614J	24846	Elastic Tension Guide Nut
160594	24846	Elastic Tension Plate
10248	24846	Elastic Tension Plate Position Pin
120565	24846	Elastic Tension Plate Spacing Washer
1560C	24846	Elastic Tension Plate Tension Regulating Thumb Nut
916C	24846	Elastic Tension Plate Tension Screw Stud
1547J	24846	Elastic Tension Plate Tension Screw Stud Nut
44209	24846	Elastic Tension Plate Tension Screw Stud 916C with 1560C
13710	24846	Elastic Tension Plate Tension Spring
160595	24846	Elastic Tension Guide complete Nos. 1547J, 13710, 44209, 160591, 160592, 160593, 160594 and four 337J
164338	24846	Presser Foot Body
164339	24846	Presser Foot Chaining off Finger
164340	24846	Presser Foot Clamping Plate
50225J	24846	Presser Foot Clamping Plate Screw
164341	24846	Presser Foot Guide (adjustable) for stitching through tape 3/16" wide
164342	24846	Presser Foot Guide (adjustable) for use when inserting elastic 1/8" to 3/16" wide
50169J	24846	Presser Foot Guide (adjustable) Screw
164343	24846	Presser Foot complete, Nos. 50169J, 50225J, 164338, 164339, 164340, 164341 and 164342
164437	24846	Set of Fittings complete, Nos. 51614J, 160595 and 164343
NOTE: When using Set of Fittings complete No. 164437 the following parts which are not included in this Set of Fittings, are necessary, if machine has previously been fitted other than regular (see Set of Fittings No. 164270).		
164011	24846	Feed (back) Dog Section (left)
164012	24846	Feed (back) Dog Section (right)
1100AL	24846	Feed (back) Dog Section (right) Screw
164013	24846	Feed (back) Dog complete, Nos. 1100AL, 164011 and 164012
164019	24846	Feed (front) Dog
164550	24846	Knife (movable)
164055	24846	Looper (right hand)
164350	24846	Presser Bar (swing out)
164175	24846	Thread (looper) Take up (left)
164091	24846	Thread (looper) Take up (right)
164178	24846	Throat Plate
164591	24846	Throat Plate Guide with 853AL

SET OF FITTINGS COMPLETE No. 164451  
 FOR SEAMING SEMI-GIRDLES  
 FOR THREE-THREAD LOOSE PURL STITCH  
 FOR 1/8 INCH BIGHT

No.	Plate	Name
164254	24847	Feed (back) Dog Section (left)
164255	24847	Feed (back) Dog Section (right)
1100AL	24847	Feed (back) Dog Section (right) Screw
164256	24847	Feed (back) Dog complete, Nos. 1100AL, 164254 and 164255
164257	24847	Feed (front) Dog
164258	24847	Presser Bar (swing out)
164259	24847	Presser Foot Body
164260	24847	Presser Foot Chain Cutter Friction Plate
164261	24847	Presser Foot Chain Cutter Knife
51306E	24847	Presser Foot Chain Cutter Knife Screw
164262	24847	Presser Foot Chaining off Finger
164263	24847	Presser Foot Clamping Plate
50225J	24847	Presser Foot Clamping Plate Screw
164264	24847	Presser Foot with Chain Cutter complete, Nos. 50225J, 51306E, 164259, 164260, 164261, 164262 and 164263
164381	24847	Thread (needle) Controller
164290	24847	Throat Plate
164612	24847	Throat Plate Guide with 853AL
164451	24847	Set of Fittings complete, Nos. 164256, 164257, 164258, 164264, 164290, 164381 and 164612
NOTE: When using Set of Fittings complete No. 164451 the following Parts which are not included in this Set of Fittings, are necessary, if machine has previously been fitted other than regular (see Set of Fittings No. 164270).		
164550	24847	Knife (movable)
164055	24847	Looper (right hand)



SET OF FITTINGS COMPLETE No. 164488  
FOR STITCHING THROUGH 1/16 IN. CORD  
1/8 INCH BIGHT, FOR THREE-THREAD STITCH

No.	Plate	Name
164337	24848	Cord Guide
51614J	24848	Cord Guide Nut
164222	24848	Feed (back) Dog Section (left)
164223	24848	Feed (back) Dog Section (right)
1100AL	24848	Feed (back) Dog Section (right) Screw
164224	24848	Feed (back) Dog complete, Nos. 1100AL, 164222 and 164223
164225	24848	Feed (front) Dog
164338	24848	Presser Foot Body
164485	24848	Presser Foot Chaining off Finger and Cord Guide
164340	24848	Presser Foot Clamping Plate
50225J	24848	Presser Foot Clamping Plate Screw
164341	24848	Presser Foot Guide (adjustable)
50169J	24848	Presser Foot Guide (adjustable) Screw
164486	24848	Presser Foot with Chain Cutter and Cord Guide complete, Nos. 50169J, 50225J, 164338, 164340, 164341 and 164485
164487	24848	Throat Plate
164488	24848	Set of Fittings complete, Nos. 51614J, 164224, 164225, 164337, 164486 and 164487
NOTE: When using Set of Fittings complete No. 164488, the following parts which are not included in this Set of Fittings, are necessary, if machine has previously been fitted other than regular (see Set of Fittings No. 164270)		
164550	24848	Knife (movable)
164055	24848	Looper (right hand)
164350	24848	Presser Bar (swing out)
164175	24848	Thread (looper) Take up (left)
164091	24848	Thread (looper, right hand) Stripper and Take up
164151	24848	Thread (needle) Controller
164591	24848	Throat Plate Guide

SET OF FITTINGS COMPLETE No. 164490  
FOR LINGERIE, CREPE DE CHINE, SILK, RAYON AND NYLON  
1/16 INCH BIGHT  
FOR THREE-THREAD TIGHT STITCH

No.	Plate	Name
164254	24849	Feed (back) Dog Section (left)
164255	24849	Feed (back) Dog Section (right)
1100AL	24849	Feed (back) Dog Section (right) Screw
164256	24849	Feed (back) Dog complete, Nos. 1100AL, 164254 and 164255
164257	24849	Feed (front) Dog
164258	24849	Presser Bar (swing-out)
164477	24849	Presser Foot Body
164260	24849	Presser Foot Chain Cutter Friction Plate
164261	24849	Presser Foot Chain Cutter Knife
51306F	24849	Presser Foot Chain Cutter Knife Screw
164478	24849	Presser Foot Chaining off Finger
164263	24849	Presser Foot Clamping Plate
50225J	24849	Presser Foot Clamping Plate Screw
164479	24849	Presser Foot complete, Nos. 50225J, 51306F, 164260, 164261, 164263, 164477 and 164478
164489	24849	Throat Plate
164612	24849	Throat Plate Guide
164490	24849	Set of Fittings complete, Nos. 164256, 164257, 164258, 164479, 164489 and 164612
NOTE: When using Set of Fittings complete No. 164490, the following parts which are not included in this Set of Fittings, are necessary, if machine has previously been fitted other than regular (see Set of Fittings 164270)		
164550	24849	Knife (movable)
164055	24849	Looper (right Hand)
164091	24849	Thread (looper, right hand) Stripper and Take up
164175	24849	Thread (looper) Take up (left)
164151	24849	Thread (needle) Controller

**SET OF FITTINGS COMPLETE No. 164657**  
**(Coarse Feed) FOR INTERMITTENT GATHERING**  
**(Knee or Manual Control) FOR NINON,**  
**ORGANDY, TAFFETA AND COTTON MATERIALS**

No.	Plate	Name
164543	24852	Feed (back) Dog Section (left)
164223	24852	Feed (back) Dog Section (right)
1100AL	24852	Feed (back) Dog Section (right) Screw
164544	24852	Feed (back) Dog complete, Nos. 1100AL, 164223 and 164543
164545	24852	Feed (front) Dog
164566	24852	Gathering Plate (swing out, pivoted)
164569	.....	Gathering Plate (swing out, pivoted) complete, Nos. 164566, 164567 and 164568
164649	24852	Gathering Plate (swing out, pivoted) Arm
1425J	24852	Gathering Plate (swing out, pivoted) Arm Hinge Screw
42436	24852	Gathering Plate (swing out, pivoted) Arm Hinge Screw Washer (3)
164573	24852	Gathering Plate (swing out, pivoted) Arm Holder
164582	.....	Gathering Plate (swing out, pivoted) Arm Holder (adjustable) complete, Nos. 164573, 164581 and two 190J
50267R	24852	Gathering Plate (swing out, pivoted) Arm Holder Screw (2)
164581	24852	Gathering Plate (swing out, pivoted) Arm Seat
190J	24852	Gathering Plate (swing out, pivoted) Arm Seat Screw (2)
164567	24852	Gathering Plate (swing out, pivoted) Holder
164570	24852	Gathering Plate (swing out, pivoted) Holder Bracket
50004J	24852	Gathering Plate (swing out, pivoted) Holder Bracket Screw (2)
1550J	24852	Gathering Plate (swing out, pivoted) Holder Bracket Screw Nut (2)
934B	24852	Gathering Plate (swing out, pivoted) Holder Screw (2)
164568	24852	Gathering Plate (swing out, pivoted) Pin
164576	24852	Gathering Plate (swing out, pivoted) Pull
1143AL	24852	Gathering Plate (swing out, pivoted) Stop Screw
1700C	24852	Gathering Plate (swing out, pivoted) Stop Screw Nut
164650	24852	Gathering Plate (swing out, pivoted) with Arm and Holder, complete, Nos. 1143AL, 1425J, 1700C, 164569, 164570, 164576, 164582, 164649, two each 934B, 1550J, 50004J, and three 42436
164655	24852	Gathering Plate (swing out, solid)
164656	.....	Gathering Plate (swing out, solid) with Arm and Holder complete, Nos. 1143AL, 1425J, 1700C, 164576, 164649, 164655, two each 1550J, 50004J and three 42436
164651	24852	Gathering Plate Presser Lever
140210C	24852	Gathering Plate Presser Lever Hinge Screw
1521X	24852	Gathering Plate Presser Lever Hinge Screw Nut
1377C	24852	Gathering Plate Presser Lever Screw Stud (eccentric)
1698X	24852	Gathering Plate Presser Lever Screw Stud (eccentric) Nut
24210	24852	Gathering Plate Presser Lever Screw Stud (eccentric) Nut Washer
164652	24852	Gathering Plate Pressure Bracket
164234	24852	Gathering Plate Pressure Bracket Adjusting Slide (cylindrical)
140657K	24852	Gathering Plate Pressure Bracket Adjusting Slide Screw
140457C	24852	Gathering Plate Pressure Bracket Adjusting Slide Screw Locking Screw
164653	24852	Gathering Plate Pressure Bracket Pressure Spring
51939	24852	Gathering Plate Pressure Bracket Roller
51940	.....	Gathering Plate Pressure Bracket Roller complete, Nos. 51939 with 140658F

No.	Plate	Name
140658F	24852	Gathering Plate Pressure Bracket Roller Screw Stud
1700J	24852	Gathering Plate Pressure Bracket Roller Screw Stud Nut
164578	24852	Gathering Plate Pressure Bracket Support
164654	24852	Gathering Plate Pressure Bracket and Support complete, Nos. 1377C, 1521X, 1698X, 1700J, 24210, 51940, 140210C, 140457C, 140657K, 164234, 164578, 164651, 164652 and 164653
164562	24852	Presser Bar (swing-out)
164563	24852	Presser Foot
164564	24852	Presser Foot Cord Guide (spring)
240J	24852	Presser Foot Cord Guide Screw
164565	24852	Presser Foot complete, Nos. 240J, 164563 and 164564
140180J	24852	Presser Foot Screw (2)
164580	24852	Tension Extension Plate (2)
140596AL	24852	Tension Extension Plate Screw (2)
1700J	24852	Tension Screw Stud Nut (2)
164227	24852	Throat Plate
164657	24852	Set of Fittings complete (coarse Feed) Nos. 164227, 164544, 164545, 164562, 164565, 164650 or 164656, 164654 and two each 1700J, 50267R, 140180J, 140596AL and 164580
NOTE: When using Set of Fittings complete No. 164657, the following parts which are not included in this Set of Fittings, are necessary, if machine has previously been fitted other than regular (see Set of Fittings No. 164270)		
164550	24852	Knife (movable)
164055	24852	Looper (right hand)
164091	24852	Thread (looper, right hand) Stripper and Take up
164175	24852	Thread (looper) Take-up (left)
164151	24852	Thread (needle) Controller
164591	24852	Throat Plate Guide

## SET OF FITTINGS COMPLETE No. 164658

## (Fine Feed) FOR INTERMITTENT GATHERING

## (Knee or Manual Control) FOR NYLON AND RAYON MATERIALS

No.	Plate	Name
164559	24853	Feed (back) Dog Section (left)
164012	24853	Feed (back) Dog Section (right)
1100AL	24853	Feed (back) Dog Section (right) Screw
164560	24853	Feed (back) Dog complete, Nos. 1100AL, 164012 and 164559
164561	24853	Feed (front) Dog
164566	24853	Gathering Plate (swing out, pivoted)
164569	.....	Gathering Plate (swing out, pivoted) complete, Nos. 164566, 164567 and 164568
164649	24853	Gathering Plate (swing out, pivoted) Arm
1425J	24853	Gathering Plate (swing out, pivoted) Arm Hinge Screw
42436	24853	Gathering Plate (swing out, pivoted) Arm Hinge Screw Washer (3)
164573	24853	Gathering Plate (swing out, pivoted) Arm Holder
164582	.....	Gathering Plate (swing out, pivoted) Arm Holder (adjustable) complete, Nos. 164573, 164581 and two 190J
50267R	24853	Gathering Plate (swing out, pivoted) Arm Holder Screw (2)
164581	24853	Gathering Plate (swing out, pivoted) Arm Seat
190J	24853	Gathering Plate (swing out, pivoted) Arm Seat Screw (2)
164567	24853	Gathering Plate (swing out, pivoted) Holder
164570	24853	Gathering Plate (swing out, pivoted) Holder Bracket
50004J	24853	Gathering Plate (swing out, pivoted) Holder Bracket Screw (2)
1550J	24853	Gathering Plate (swing out, pivoted) Holder Bracket Screw Nut (2)
934B	24853	Gathering Plate (swing out, pivoted) Holder Screw (2)
164568	24853	Gathering Plate (swing out, pivoted) Pin
164576	24853	Gathering Plate (swing out, pivoted) Pull
1143AL	24853	Gathering Plate (swing out, pivoted) Stop Screw
1700C	24853	Gathering Plate (swing out, pivoted) Stop Screw Nut
164650	24853	Gathering Plate (swing out, pivoted) with Arm and Holder complete, Nos. 1143AL, 1425J, 1700C, 164569, 164570, 164576, 164582, 164649, two each 934B, 1550J, 50004J, and three 42436
164655	24853	Gathering Plate (swing out, solid)
164656	.....	Gathering Plate (swing out, solid) with Arm and Holder complete, Nos. 1143AL, 1425J, 1700C, 164576, 164649, 164655, two each 1550J, 50004J and three 42436
164651	24853	Gathering Plate Presser Lever
140210C	24853	Gathering Plate Presser Lever Hinge Screw
1521X	24853	Gathering Plate Presser Lever Hinge Screw Nut
1377C	24853	Gathering Plate Presser Lever Screw Stud (eccentric)
1698X	24853	Gathering Plate Presser Lever Screw Stud (eccentric) Nut
24210	24853	Gathering Plate Presser Lever Screw Stud (eccentric) Nut Washer
164652	24853	Gathering Plate Pressure Bracket
164234	24853	Gathering Plate Pressure Bracket Adjusting Slide (cylindrical)
140657K	24853	Gathering Plate Pressure Bracket Adjusting Slide Screw
140457C	24853	Gathering Plate Pressure Bracket Adjusting Slide Screw Locking Screw
164653	24853	Gathering Plate Pressure Bracket Pressure Spring
51939	24853	Gathering Plate Pressure Bracket Roller
51940	.....	Gathering Plate Pressure Bracket Roller complete, Nos. 51939 with 140658F
140658F	24853	Gathering Plate Pressure Bracket Roller Screw Stud

No.	Plate	Name
1700J	24853	Gathering Plate Pressure Bracket Roller Screw Stud Nut
164578	24853	Gathering Plate Pressure Bracket Support
164654	24853	Gathering Plate Pressure Bracket and Support complete, Nos. 1377C, 1521X, 1698X, 1700J, 24210, 51940, 140210C, 140457C, 140657K, 164234, 164578, 164651, 164652 and 164653
164562	24853	Presser Bar (swing-out)
164563	24853	Presser Foot
164564	24853	Presser Foot Cord Guide (spring)
240J	24853	Presser Foot Cord Guide Screw
164565	24853	Presser Foot complete, Nos. 240J, 164563 and 164564
140180J	24853	Presser Foot Screw (2)
164580	24853	Tension Extension Plate (2)
140596AL	24853	Tension Extension Plate Screw (2)
1700J	24853	Tension Screw Stud Nut (2)
164227	24853	Throat Plate
164658	24853	Set of Fittings complete (coarse Feed) Nos. 164227, 164560, 164561, 164562, 164565, 164650 or 164656, 164654 and two each 1700J, 50267R, 140180J, 140596AL and 164580
NOTE: When using Set of Fittings complete No. 164658, the following parts which are not included in this Set of Fittings, are necessary, if machine has previously been fitted other than regular (see Set of Fittings No. 164270)		
164550	24853	Knife (movable)
164055	24853	Looper (right hand)
164091	24853	Thread (looper, right hand) Stripper and Take-up
164175	24853	Thread (looper) Take-up (left)
164151	24853	Thread (needle) Controller
164591	24853	Throat Plate Guide

**SET OF FITTINGS COMPLETE No. 164667**  
**(Coarse Feed) FOR INTERMITTENT GATHERING**  
**(Knee or Manual Control) FOR NINON,**  
**ORGANDY, TAFFETA AND COTTON MATERIALS**  
**(Feed Eccentric Connection assembled in a reverse position)**

No.	Plate	Name
164004	24854	Feed Bar Slide Block (back) (2)
164005	24854	Feed Bar Slide Block (front)
164687	24854	Feed (back) Bar with 164010
164017	24854	Feed (back) Bar Connection
164008	24854	Feed (back) Bar Connection Bearing
164009	24854	Feed (back) Bar Connection Hinge Screw Stud
1671C	24854	Feed (back) Bar Connection Hinge Screw Stud Nut
164010	24854	Feed (back) Bar Connection Hinge Screw Stud Position Pin
131740	24854	Feed (back) Bar Connection Spring
164006	24854	Feed (front) Bar with 164010
164007	24854	Feed (front) Bar Connection
164664	24854	Feed (front) Bar Connection Bearing
164665	24854	Feed (front) Bar Connection Hinge Screw Stud
1671C	24854	Feed (front) Bar Connection Hinge Screw Stud Nut
164010	24854	Feed (front) Bar Connection Hinge Screw Stud Position Pin
164666	24854	Feed (back) and (front) Bars complete, Nos. 131740, 164005, 164006, 164007, 164008, 164009, 164017, 164664, 164665, 164687 and two each 1671C and 164004
164543	24852	Feed (back) Dog Section (left)
164223	24852	Feed (back) Dog Section (right)
1100AL	24852	Feed (back) Dog Section (right) Screw
164544	24852	Feed (back) Dog complete, Nos. 1100AL, 164223 and 164543
164545	24852	Feed (front) Dog
164566	24852	Gathering Plate (swing out, pivoted)
164569	24852	Gathering Plate (swing out, pivoted) complete, Nos. 164566, 164567 and 164568
164649	24852	Gathering Plate (swing-out, pivoted) Arm
1425J	24852	Gathering Plate (swing out, pivoted) Arm Hinge Screw
42436	24852	Gathering Plate (swing-out, pivoted) Arm Hinge Screw Washer (3)
164573	24852	Gathering Plate (swing out, pivoted) Arm Holder
164582	24852	Gathering Plate (swing out, pivoted) Arm Holder (adjustable) complete, Nos. 164573, 164581 and two 190J
50267R	24852	Gathering Plate (swing out, pivoted) Arm Holder Screw (2)
164581	24852	Gathering Plate (swing out, pivoted) Arm Seat
190J	24852	Gathering Plate (swing out, pivoted) Arm Seat Screw (2)
164567	24852	Gathering Plate (swing out, pivoted) Holder
164570	24852	Gathering Plate (swing out, pivoted) Holder Bracket
50004J	24852	Gathering Plate (swing-out, pivoted) Holder Bracket Screw (2)
1550J	24852	Gathering Plate (swing out, pivoted) Holder Bracket Screw Nut (2)
934B	24852	Gathering Plate (swing out, pivoted) Holder Screw (2)
164568	24852	Gathering Plate (swing out, pivoted) Pin
164576	24852	Gathering Plate (swing out, pivoted) Pull
1143AL	24852	Gathering Plate (swing out, pivoted) Stop Screw
1700C	24852	Gathering Plate (swing out, pivoted) Stop Screw Nut
164650	24852	Gathering Plate (swing-out, pivoted) with Arm and Holder complete, Nos. 1143AL, 1425J, 1700C, 164569, 164570, 164576, 164582, 164649, two each 934B, 1550J, 50004J, and three 42436

No.	Plate	Name
164655	24852	Gathering Plate (swing-out, solid)
164656	24852	Gathering Plate (swing out, solid) with Arm and Holder complete, Nos. 1143AL, 1425J, 1700C, 164576, 164649, 164655, two each 1550J, 50004J and three 42436
164651	24852	Gathering Plate Presser Lever
140210C	24852	Gathering Plate Presser Lever Hinge Screw
1521X	24852	Gathering Plate Presser Lever Hinge Screw Nut
1377C	24852	Gathering Plate Presser Lever Screw Stud (eccentric)
1698X	24852	Gathering Plate Presser Lever Screw Stud (eccentric) Nut
24210	24852	Gathering Plate Presser Lever Screw Stud (eccentric) Nut Washer
164652	24852	Gathering Plate Pressure Bracket
164234	24852	Gathering Plate Pressure Bracket Adjusting Slide (Cylindrical)
140657K	24852	Gathering Plate Pressure Bracket Adjusting Slide Screw
140457C	24852	Gathering Plate Pressure Bracket Adjusting Slide Screw Locking Screw
164653	24852	Gathering Plate Pressure Bracket Pressure Spring
51939	24852	Gathering Plate Pressure Bracket Roller
51940	24852	Gathering Plate Pressure Bracket Roller complete, Nos. 51939 with 140658F
140658F	24852	Gathering Plate Pressure Bracket Roller Screw Stud
1700J	24852	Gathering Plate Pressure Bracket Roller Screw Stud Nut
164578	24852	Gathering Plate Pressure Bracket Support
164654	24852	Gathering Plate Pressure Bracket and Support complete, Nos. 1377C, 1521X, 1698X, 1700J, 24210, 51940, 140210C, 140457C, 140657K, 164234, 164578, 164651, 164652 and 164653
164562	24852	Presser Bar (swing-out)
164563	24852	Presser Foot
164564	24852	Presser Foot Cord Guide (spring)
240J	24852	Presser Foot Cord Guide Screw
164565	24852	Presser Foot complete, Nos. 240J, 164563, and 164564
140180J	24852	Presser Foot Screw (2)
164580	24852	Tension Extension Plate (2)
140596AL	24852	Tension Extension Plate Screw (2)
1700J	24852	Tension Screw Stud Nut (2)
164227	24852	Throat Plate
164657	24852	Set of Fittings complete, (coarse feed) Nos. 164227, 164544, 164545, 164562, 164565, 164650 or 164656, 164654 and two each 1700J, 50267R, 140180J, 140596AL and 164580
164667	24852	Set of Fittings 164657 with 164666
		NOTE: When using Set of Fittings No. 164667 the following parts which are not included in this Set of Fittings, are necessary, if machine has previously been fitted other than regular (see Set of Fittings No. 164270)
164550	24852	Knife (movable)
164055	24852	Looper (right hand)
164091	24852	Thread (looper, right hand) Stripper and Take-up
164175	24852	Thread (looper) Take-up (left)
164151	24852	Thread (needle) Controller
164591	24852	Throat Plate Guide

## SET OF FITTINGS COMPLETE No. 164668

(Coarse Feed) FOR INTERMITTENT GATHERING

(Knee or Manual Control) FOR NINON,

ORGANDY, TAFFETA AND COTTON MATERIALS

(Feed Eccentric Connection assembled in a reverse position)

No.	Plate	Name
164004	24854	Feed Bar Slide Block (back) (2)
164005	24854	Feed Bar Slide Block (front)
164687	24854	Feed (back) Bar with 164010
164017	24854	Feed (back) Bar Connection
164008	24854	Feed (back) Bar Connection Bearing
164009	24854	Feed (back) Bar Connection Hinge Screw Stud
1671C	24854	Feed (back) Bar Connection Hinge Screw Stud Nut
164010	24854	Feed (back) Bar Connection Hinge Screw Stud Position Pin
131740	24854	Feed (back) Bar Connection Spring
164006	24854	Feed (front) Bar with 164010
164007	24854	Feed (front) Bar Connection
164664	24854	Feed (front) Bar Connection Bearing
164665	24854	Feed (front) Bar Connection Hinge Screw Stud
1671C	24854	Feed (front) Bar Connection Hinge Screw Stud Nut
164010	24854	Feed (front) Bar Connection Hinge Screw Stud Position Pin
164666	24854	Feed (back) and (front) Bars complete, Nos. 131740, 164005, 164006, 164007, 164008, 164009, 164017, 164664, 164665, 164687 and two each 1671C and 164004
164559	24853	Feed (back) Dog Section (left)
164012	24853	Feed (back) Dog Section (right)
1100AL	24853	Feed (back) Dog Section (right) Screw
164560	24853	Feed (back) Dog complete, Nos. 1100AL, 164012 and 164559
164561	24853	Feed (front) Dog
164566	24853	Gathering Plate (swing out, pivoted)
164569	.....	Gathering Plate (swing out, pivoted) complete, Nos. 164566, 164567 and 164568
164649	24853	Gathering Plate (swing out, pivoted) Arm
1425J	24853	Gathering Plate (swing out, pivoted) Arm Hinge Screw
42436	24853	Gathering Plate (swing out, pivoted) Arm Hinge Screw Washer (3)
164573	24853	Gathering Plate (swing out, pivoted) Arm Holder
164582	.....	Gathering Plate (swing out, pivoted) Arm Holder (adjustable) complete, Nos. 164573, 164581 and two 190J
50267R	24853	Gathering Plate (swing out, pivoted) Arm Holder Screw (2)
164581	24853	Gathering Plate (swing out, pivoted) Arm Seat
190J	24853	Gathering Plate (swing out, pivoted) Arm Seat Screw (2)
164567	24853	Gathering Plate (swing out, pivoted) Holder
164570	24853	Gathering Plate (swing out, pivoted) Holder Bracket
50004J	24853	Gathering Plate (swing out, pivoted) Holder Bracket Screw (2)
1550J	24853	Gathering Plate (swing out, pivoted) Holder Bracket Screw Nut (2)
934B	24853	Gathering Plate (swing out, pivoted) Holder Screw (2)
164568	24853	Gathering Plate (swing out, pivoted) Pin
164576	24853	Gathering Plate (swing out, pivoted) Pull
1143AL	24853	Gathering Plate (swing out, pivoted) Stop Screw
1700C	24853	Gathering Plate (swing out, pivoted) Stop Screw Nut
164650	24853	Gathering Plate (swing out, pivoted) with Arm and Holder complete, Nos. 1143AL, 1425J, 1700C, 164569, 164570, 164576, 164582, 164649, two each 934B, 1550J, 50004J, and three 42436

No.	Plate	Name
164655	24853	Gathering Plate (swing-out, solid)
164656	.....	Gathering Plate (swing out, solid) with Arm and Holder complete, Nos. 1143AL, 1425J, 1700C, 164576, 164649, 164655, two each 1550J, 50004J and three 42436
164651	24853	Gathering Plate Presser Lever
140210C	24853	Gathering Plate Presser Lever Hinge Screw
1521X	24853	Gathering Plate Presser Lever Hinge Screw Nut
1377C	24853	Gathering Plate Presser Lever Screw Stud (eccentric)
1698X	24853	Gathering Plate Presser Lever Screw Stud (eccentric) Nut
24210	24853	Gathering Plate Presser Lever Screw Stud (eccentric) Nut Washer
164652	24853	Gathering Plate Pressure Bracket
164234	24853	Gathering Plate Pressure Bracket Adjusting Slide (cylindrical)
140657K	24853	Gathering Plate Pressure Bracket Adjusting Slide Screw
140457C	24853	Gathering Plate Pressure Bracket Adjusting Slide Screw Locking Screw
164653	24853	Gathering Plate Pressure Bracket Pressure Spring
51939	24853	Gathering Plate Pressure Bracket Roller
51940	.....	Gathering Plate Pressure Bracket Roller complete, Nos. 51939 with 140658F
140658F	24853	Gathering Plate Pressure Bracket Roller Screw Stud
1700J	24853	Gathering Plate Pressure Bracket Roller Screw Stud Nut
164578	24853	Gathering Plate Pressure Bracket Support
164654	24853	Gathering Plate Pressure Bracket and Support complete, Nos. 1377C, 1521X, 1698X, 1700J, 24210, 51940, 140210C, 140457C, 140657K, 164234, 164578, 164651, 164652 and 164653
164562	24853	Presser Bar (swing-out)
164563	24853	Presser Foot
164564	24853	Presser Foot Cord Guide (spring)
240J	24853	Presser Foot Cord Guide Screw
164565	24853	Presser Foot complete, Nos. 240J, 164563, and 164564
140180J	24853	Presser Foot Screw (2)
164580	24853	Tension Extension Plate (2)
140596AL	24853	Tension Extension Plate Screw (2)
1700J	24853	Tension Screw Stud Nut (2)
164277	24853	Throat Plate
164658	24853	Set of Fittings complete, (coarse feed) Nos. 164277, 164560, 164561, 164562, 164565, 164650 or 164656, 164654 and two each 1700J, 50267R, 140180J, 140596AL and 164580
164668	.....	Set of Fittings 164658 with 164666
164550	24853	NOTE: When using Set of Fittings No. 164668 the following parts which are not included in this Set of Fittings, are necessary, if machine has previously been fitted other than regular (see Set of Fittings No. 164270)
164055	24853	Knife (movable)
164091	24853	Looper (right hand)
164175	24853	Thread (looper, right hand) Stripper and Take-up
164151	24853	Thread (looper) Take-up (left)
164591	24853	Thread (needle) Controller
164591	24853	Throat Plate Guide

## ACCESSORIES

No.	Plate	Name
164203	24826	Feed Eccentric Extractor (not regularly furnished with machine)
164592	24826	Gauge (not regularly furnished with machine)
160725	24826	Oil Container
160727	24826	Oil Container (filled, 5 oz. mfg. oil, light grade, not stainless) Nos. 160725 and 160726
160726	24826	Oil Container Cap
160728	24826	Oil Container Spout, for use when filling Oil Reservoir
164198	24826	Presser Bar Lifting Chain Spring (under table)
26026	24826	Screw Driver
164196	24826	Threader (6)
164204	24826	Tweezers
164197	24826	Wrench (socket)
10875	.....	Wrench (flat)

## BELT GUARD (Adjustable)

No.	Plate	Name
164183	24763	Belt Guard
164199	24763	Belt Guard Bracket (back)
164200	24763	Belt Guard Bracket (front)
51326J	24763	Belt Guard Screw (2)
164201	24763	Belt Guard (adjustable) complete, Nos. 164183, 164199, 164200 and two each 51326J and wood screws 3/4 in. No. 7 F.H.

## CHIP CHUTE

No.	Plate	Name
168198	24763	Chip Chute with four wood screws 3/8 in. No. 6 R.H. blacked

## FOOT LIFTER PARTS

No.	Plate	Name
6439	24763	Chain, 36 in. to 45 in. with 56864 and 56865
NOTE: When ordering No. 6439, give length required.		
4879	24763	Chain Connecting Link
56864	24763	Chain Hook (large)
56865	24763	Chain Hook (small)
4881	24763	Treadle
4882	24763	Treadle Shaft
4883	24763	Treadle Spring
4884	24763	Treadle Stand
4885	24763	Treadle complete, Nos. 4879, 4881, 4882, 4883, 4884 and two wood screws 1 in. No. 16 F.H.

## MACHINE BASE

No.	Plate	Name
164184	24763	Machine Base with 50608R, 139017 and two each wood screws 3/4 in. No. 8 R.H. and 1 1/4 in. No. 6 F.H.
50608R	24763	Machine Base Plug Screw
139017	24763	Machine Base Plug Screw Washer
164188	24763	Machine Cushion (large) (2)
164189	24763	Machine Cushion (small) (2)
164190	24763	Machine Pad (felt)
140418E	24812	Machine Screw Stud (back)
657E	24812	Machine Screw Stud (front)

THREAD UNWINDER No. 151031  
FOR THREE SPOOLS

No.	Plate	Name
228692		Spool Pin (3)
201528X		Spool Pin Nut (3)
395243		Spool Pin Washer (3)
151023	24764	Spool Rest with 858AL and three each 201528X, 228692 and 395243
150203	24764	Spool Rest Cushion (felt) (3)
858AL	24764	Spool Rest Hub Set Screw
151024	24764	Spool Rest Rod
1122C	24764	Spool Rest Rod Set Screw (2)
151025	24764	Spool Rest Stand with two 1122C and three wood screws 1 in. No. 12 F.H.
151026	24764	Thread Guide (lower)
50311C	24764	Thread Guide (lower) Holder Set Screw
151027	24764	Thread Guide (lower) Support with 50311C
151028	24764	Thread Guide (upper, hollow) (2)
151029	24764	Thread Guide (upper) Holder with four 453AL
151030	24764	Thread Guide Rod
453AL	24764	Thread Guide Rod Set Screw
453AL	24764	Thread Guide Set Screw (3)
151031	24764	Thread Unwinder complete, Nos. 151023, 151024, 151025, 151026, 151027, 151029, 151030, two 151028 and three 150203

THREAD UNWINDER No. 151163  
FOR FOUR SPOOLS

No.	Plate	Name
228692	24806	Spool Pin
201528X		Spool Pin Nut
228693		Spool Pin Washer
395243		Spool Pin Washer (3)
151023	24806	Spool Rest with 858AL and three each 201528X, 228692 and 395243 (three spools)
225259	24806	Spool Rest with 201018C, 201528X, 228692 and 228693 (one spool)
150203	24806	Spool Rest Cushion (felt) (4)
858AL	24806	Spool Rest Hub Set Screw for 151023
151024	24806	Spool Rest Rod
1122C	24806	Spool Rest Rod Set Screw (2)
201018C	24806	Spool Rest Set Screw for 225259
151025	24806	Spool Rest Stand with two 1122C and three wood screws 1 in. No. 12 F.H.
151026	24806	Thread Guide (lower)
50311C	24806	Thread Guide (lower) Holder Set Screw
151027	24806	Thread Guide (lower) Support with 50311C
151028	24806	Thread Guide (upper, hollow) (2)
151162	24806	Thread Guide (upper, solid)
151029	24806	Thread Guide (upper) Holder with four 453AL
151030	24806	Thread Guide Rod
453AL	24806	Thread Guide Rod Set Screw
453AL	24806	Thread Guide Set Screw (3)
151163	24806	Thread Unwinder complete, Nos. 151023, 151024, 151025, 151026, 151027, 151029, 151030, 151162, 225259, two 151028 and four 150203

SINGER Needles should be used  
 in SINGER Machines  
 These Needles and their Containers  
 are marked with the  
 Company's Trade Mark "SIMANCO.\*\*\*" 1

Needles in Containers marked  
 "FOR SINGER MACHINES"  
 are NOT SINGER made needles. 2

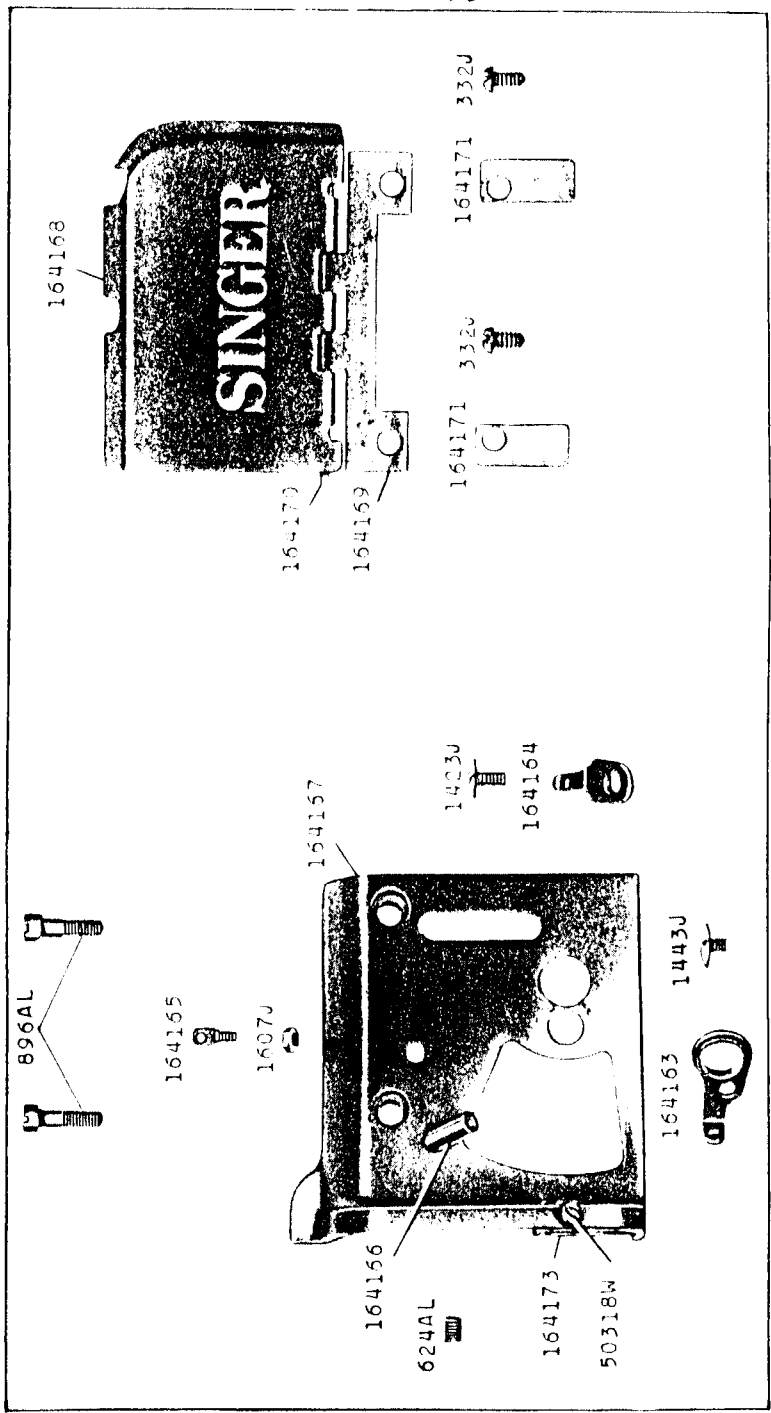

24763 - 1/4

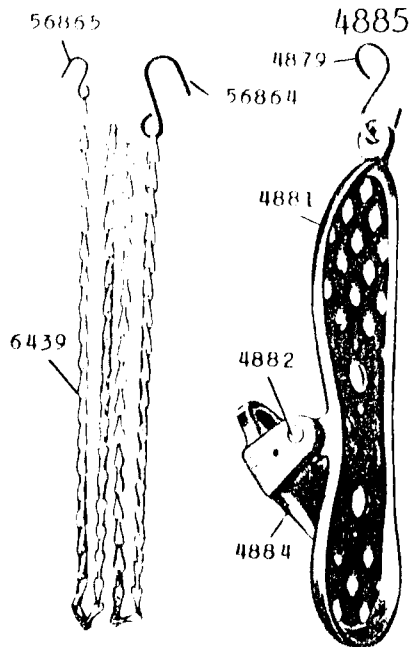
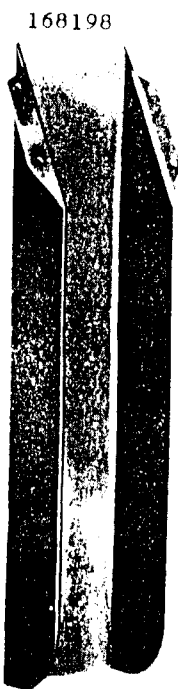
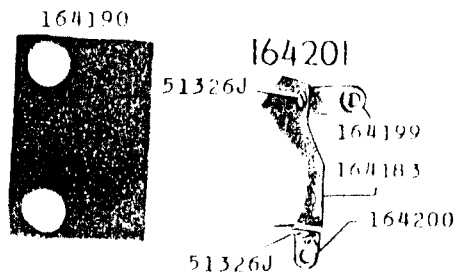
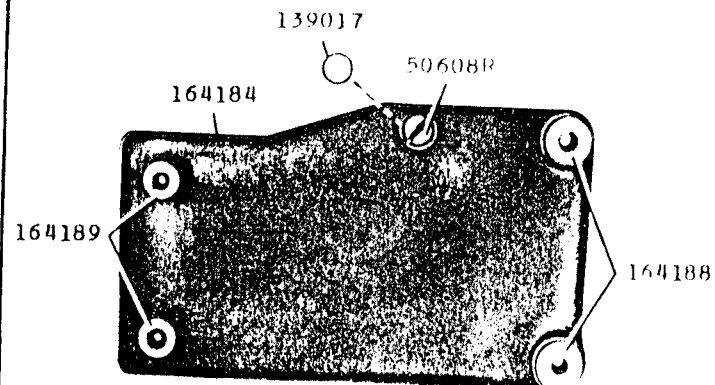

24764 - 1/6

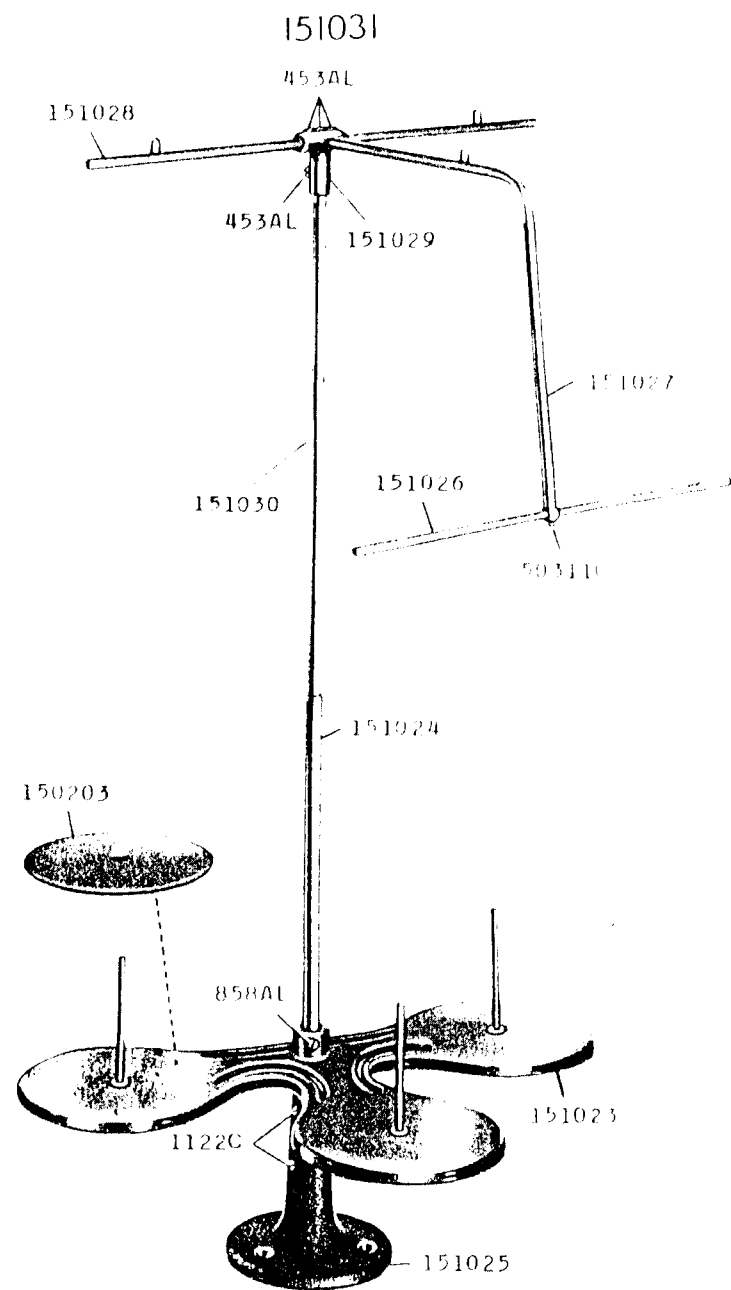





24812-1/3

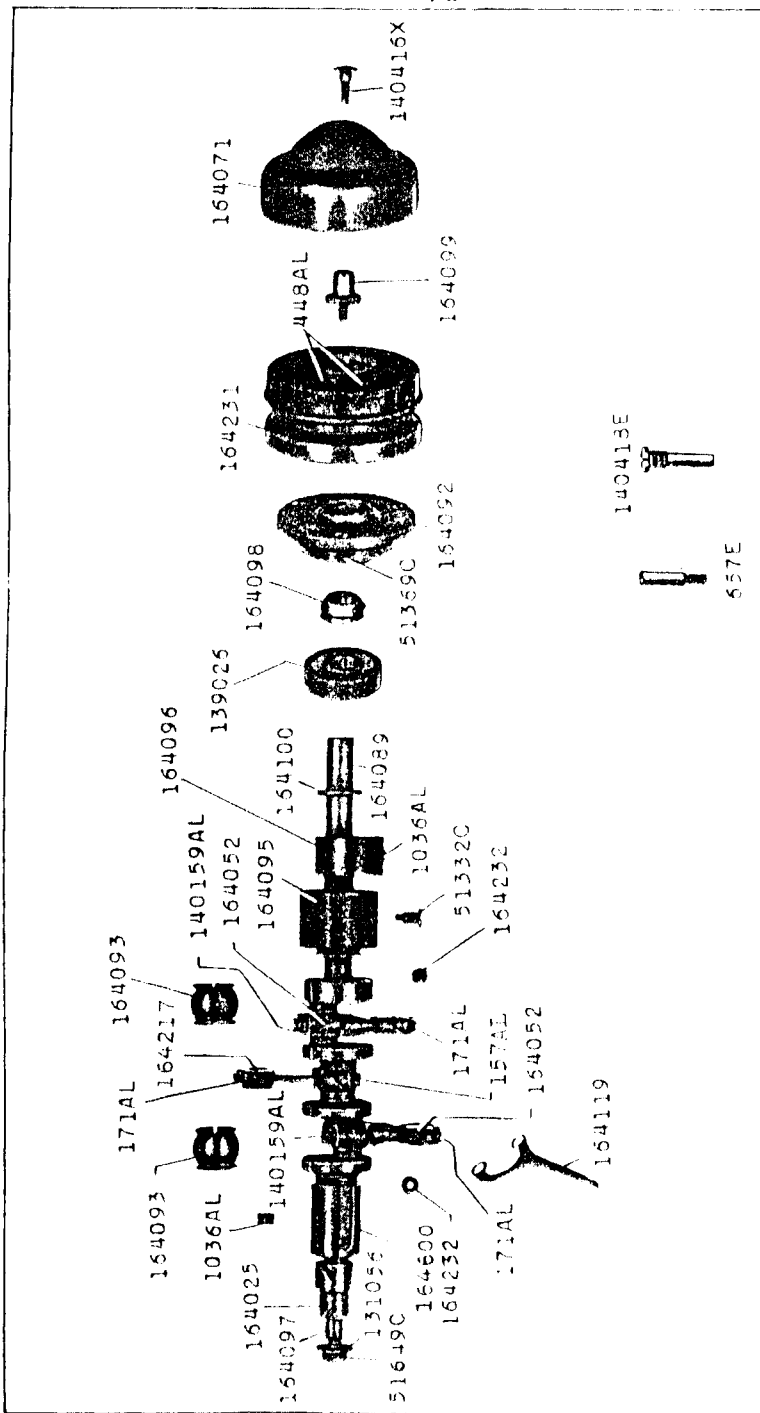

24813-1/3

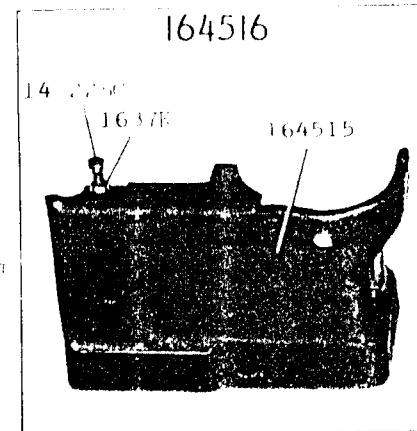
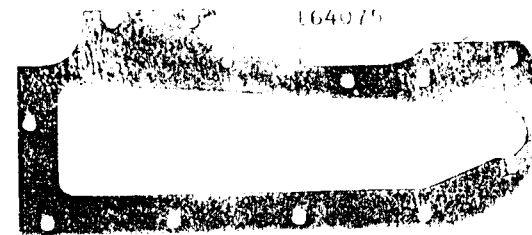
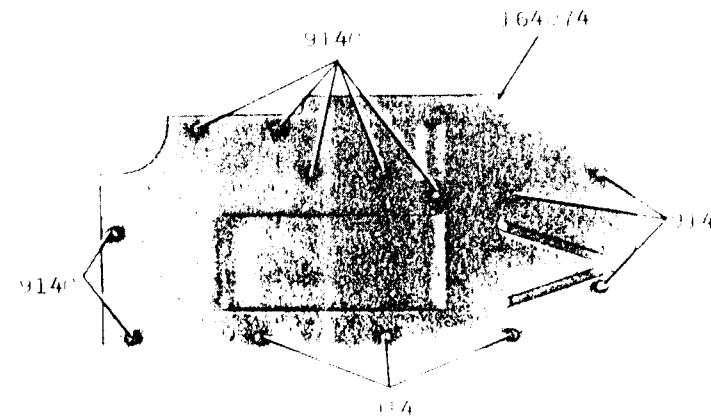

1637E



164515

9140



505711









24831-1/3

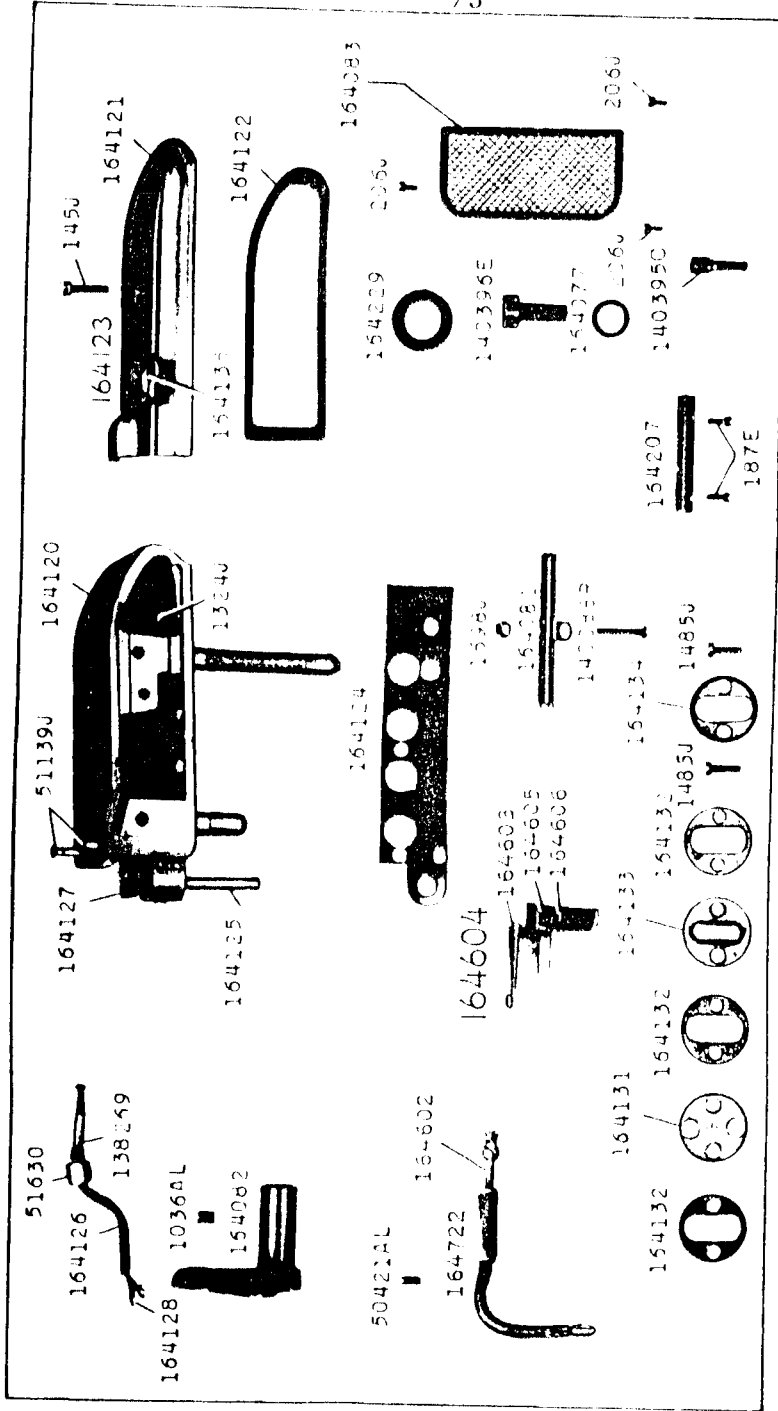

24832-2/3

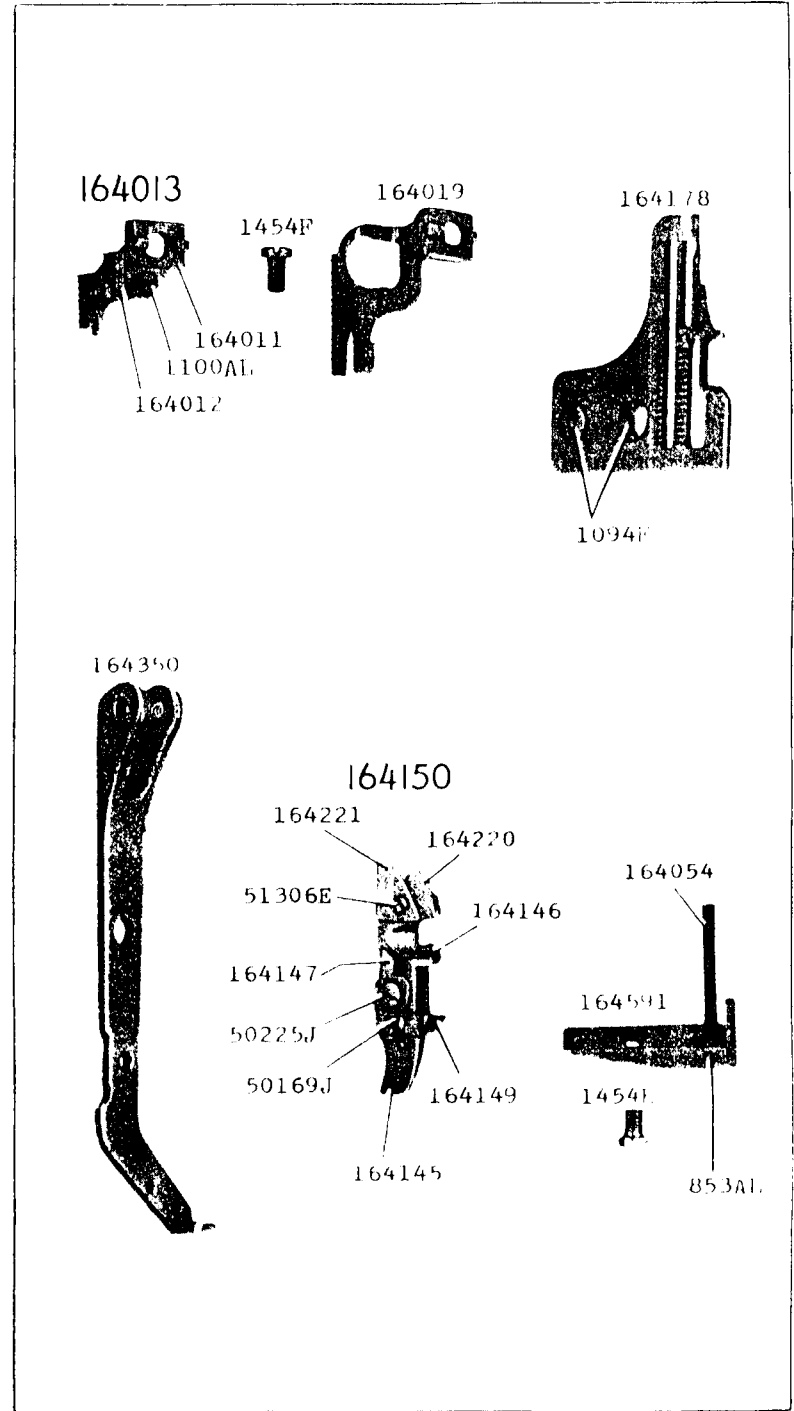

24833-2/3

164270

164013

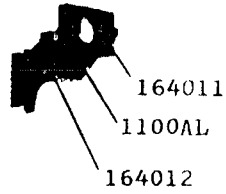

164019



164178

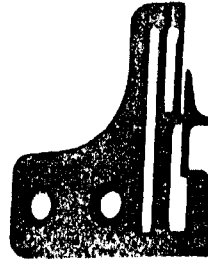

164055



164550



164091

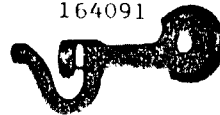

164350

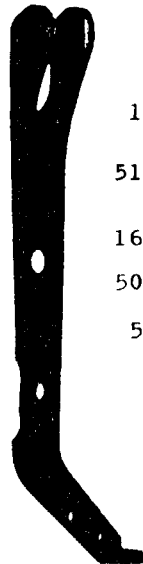

164150

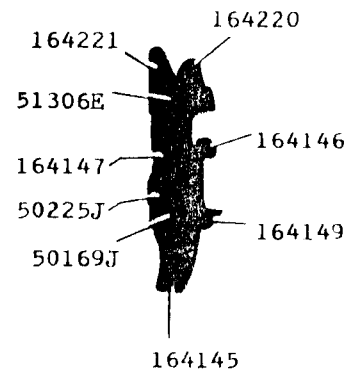

164175



164151



164591

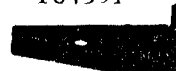

24834-2/3

164266

164256

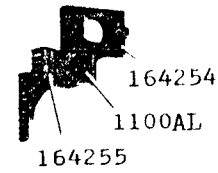

164257

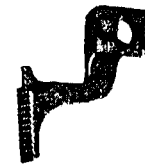

164265

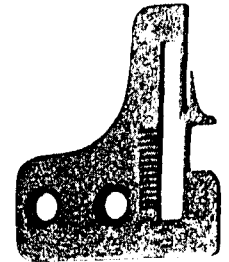

164264

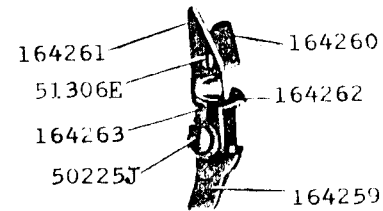

164612

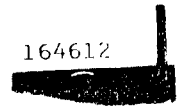

164258

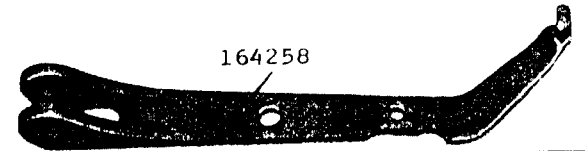

164151

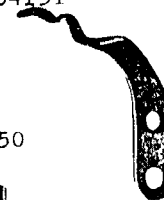

164055



164550



164091



164175



24835-2/3

164271

164013

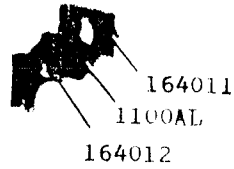

164019



164267

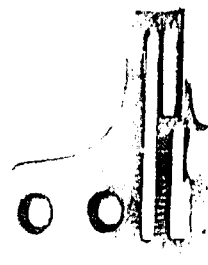

164055



164550



164091



164350

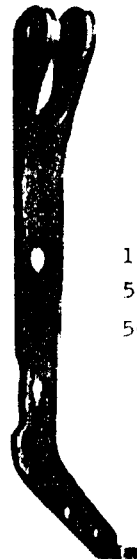

164150

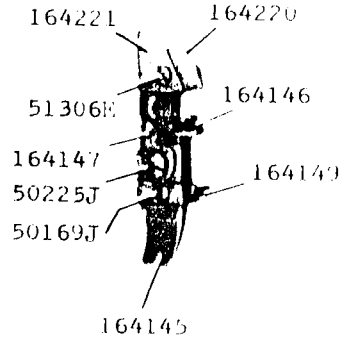

164151



164591

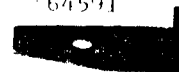

24836-2/3

164272

164224



164225



164226

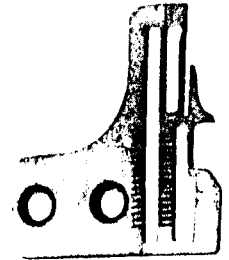

164362

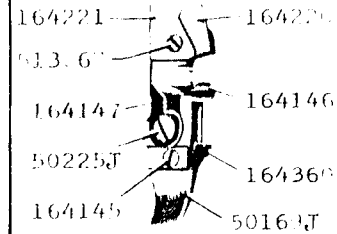

164556



164350



164055



164151



164091

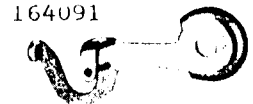

164591

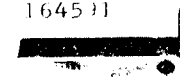

164175





24837-2/3

164273

164224

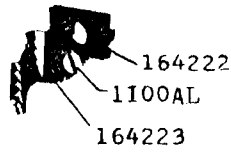

164225



164227

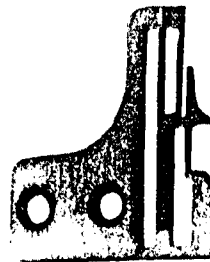

164362

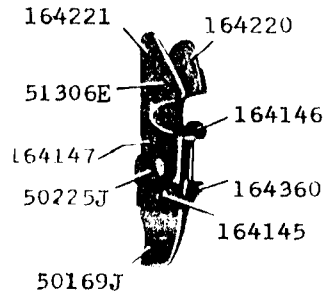

164556



164350

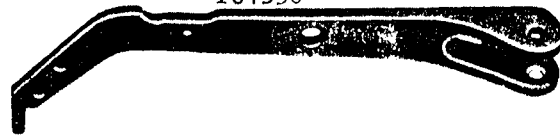

164055



164151

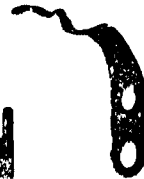

164091



164591

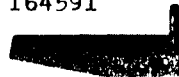

164175



24838-2/3

164274

164224

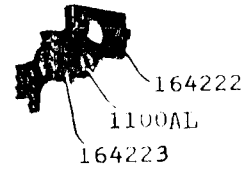

164225



164228

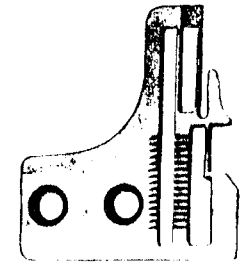

164362

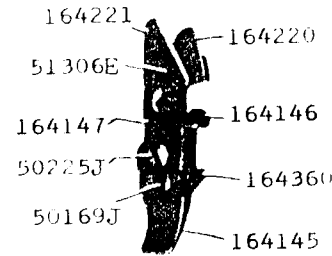

164556



164350



164055



164151



164091



164591

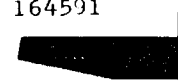

164175



*var 165105*

24839-2/3

164344

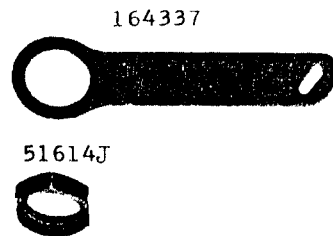

164337

51614J



164343

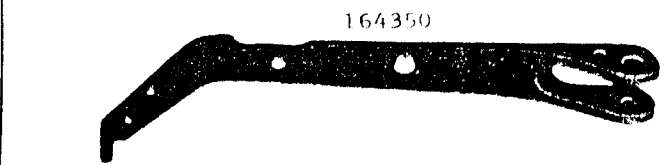
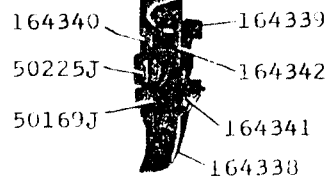

164350

164013

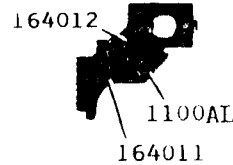

164012  
1100AL  
164011

164019



164178

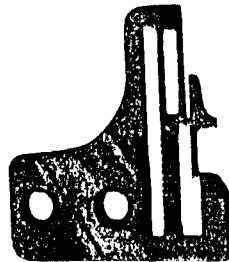

164055



164591

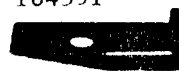

164550



164175



164091

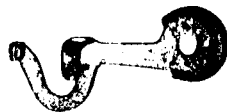

24840-2/3

164388

164224

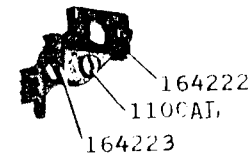

164225

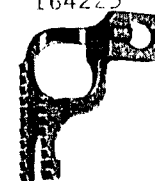

164227

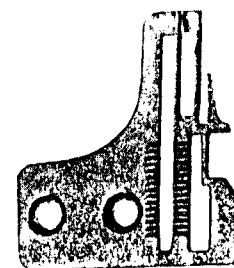

164362

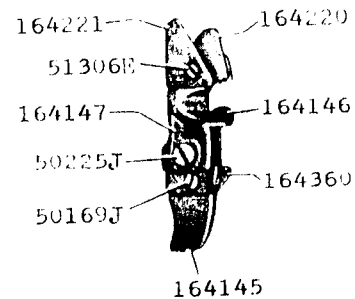

164556



164257

164381



164591

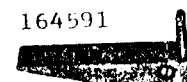

164091



164350

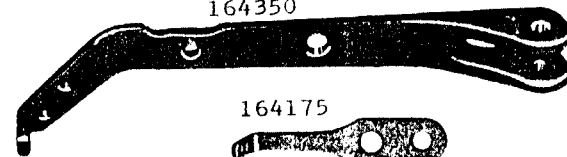

164175



24841-2/3

164389

164324

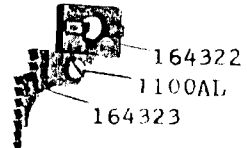

164325

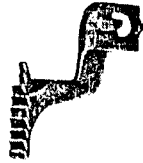

164290

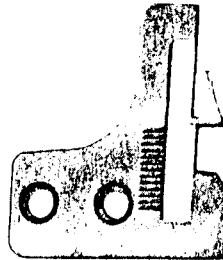

164264

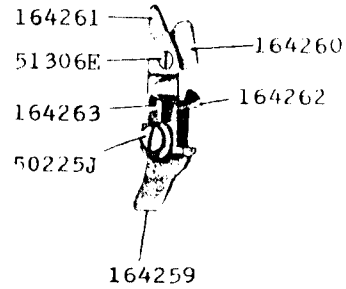

164252



164612

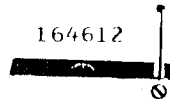

164259

164258



164151



164550



164175



164091



24842-2/3

164390

164324

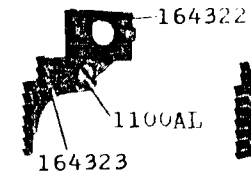

164325

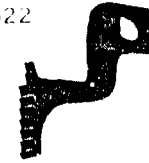

164290

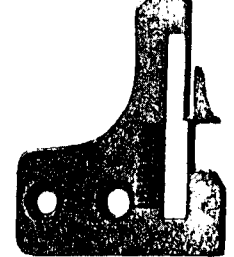

164264

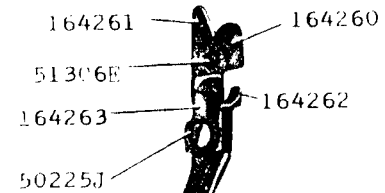

164260

164262

164259

164612

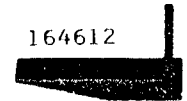

164258

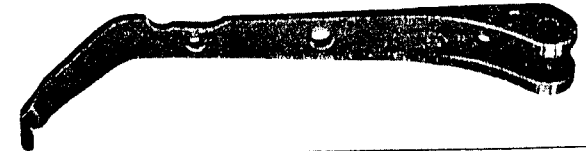

164550



164055



164151



164175



164091

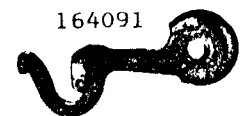

24843-2/3

164395

164393

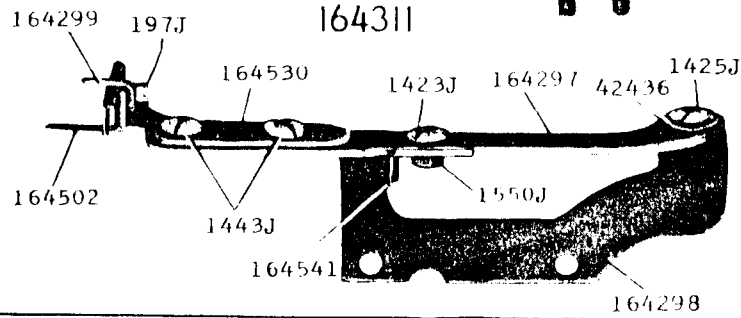
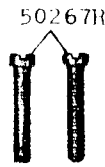
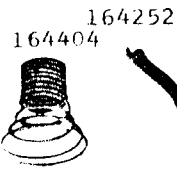
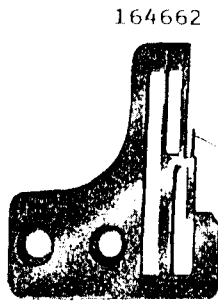
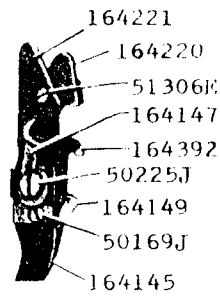

164311

24844-2/3

164431

164281

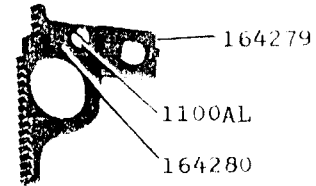

164290

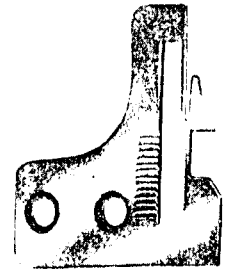

164430

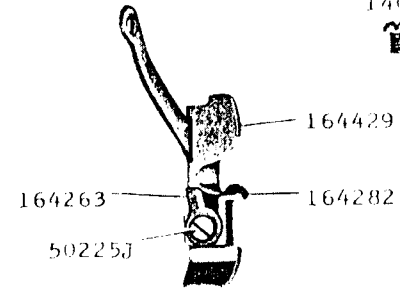

140180J

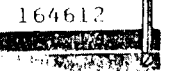

164258



164350

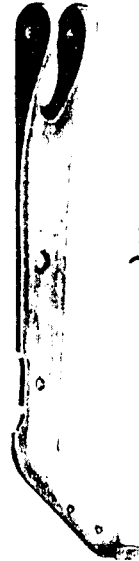

164013

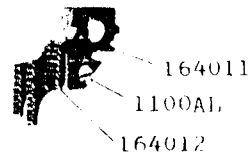

164019

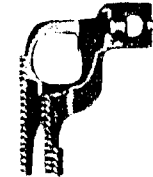

164151



164550



164175



164091



164591



164550



164055



164151



164175



164091



24845-2/3

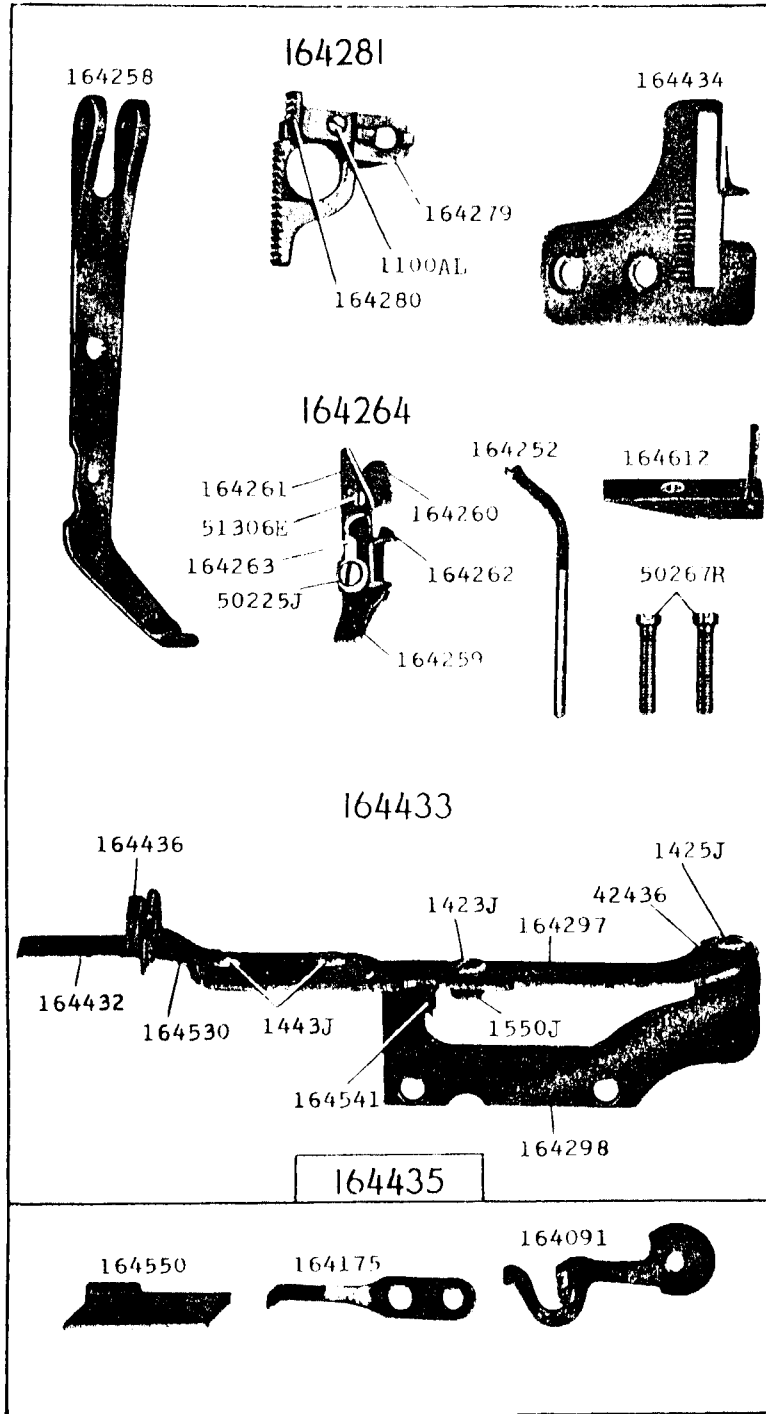

24846-2/3

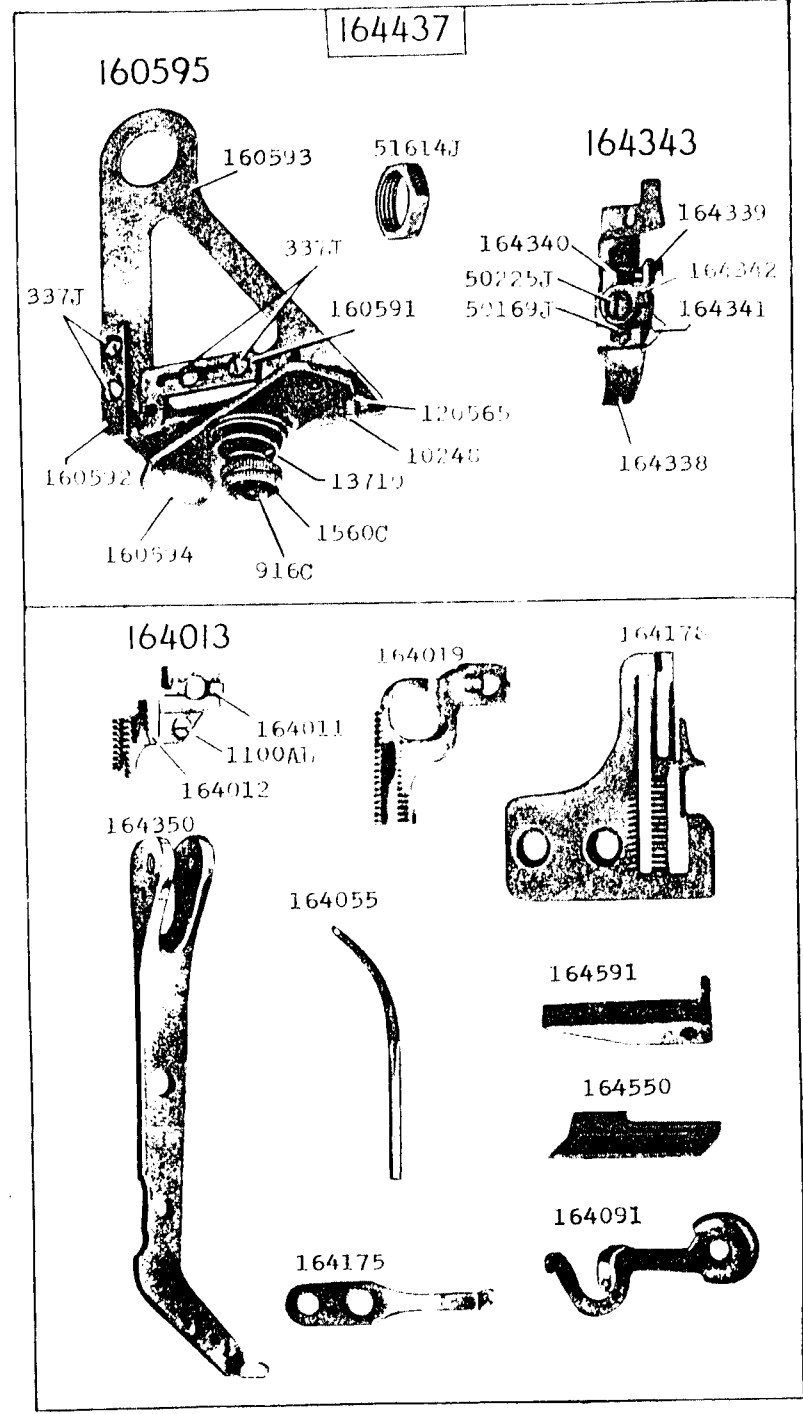

24847-2/3

164451

164256

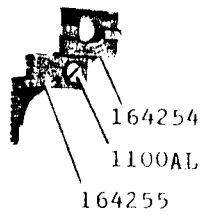

164257

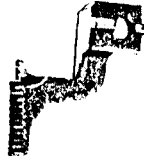

164290

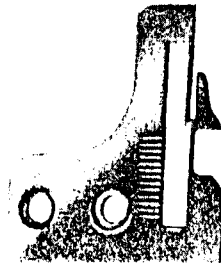

164264

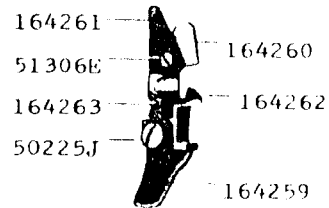

164612

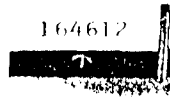

164381



164258



164550



164055

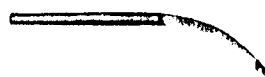

24848-2/3

164488

164337



51614J



164486

164340

50225J

50169J

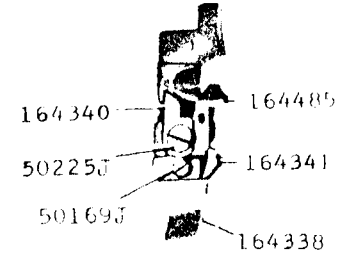

164224

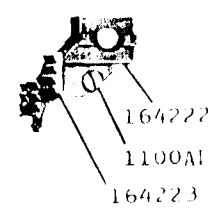

164225



164487

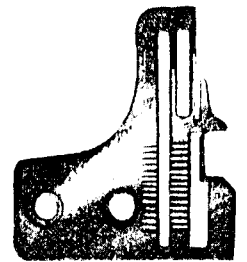

164350



164151



164550



164055



164591



164175



164091



24849-2/3

164490

164256

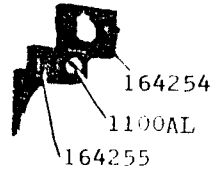

164257



164489

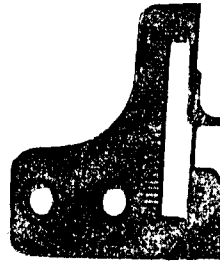

164479

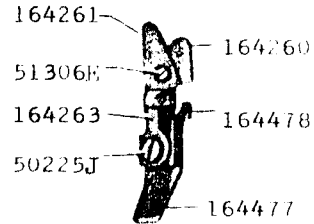

164612

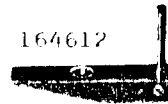

164258

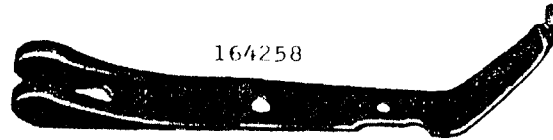

164055



164151



164550



164175



24850-1/2

160595

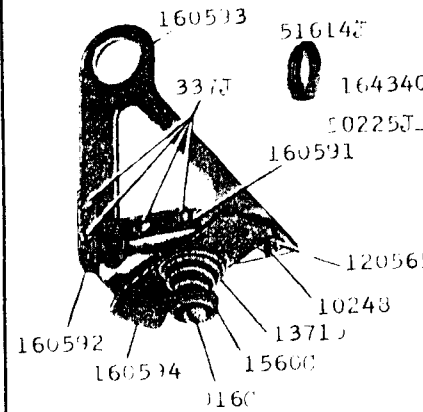

164343

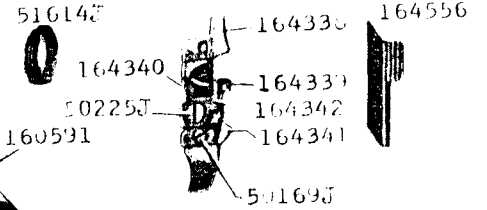

164381



164440

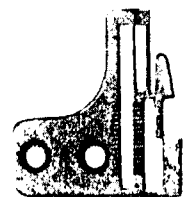

164224

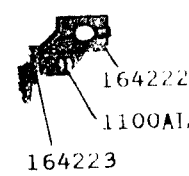

164225



164538

164055



164591



164350

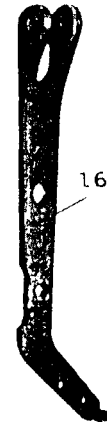

164175



164091



24851-2/3

164549

164544



164545



164227

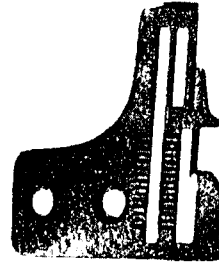

164548

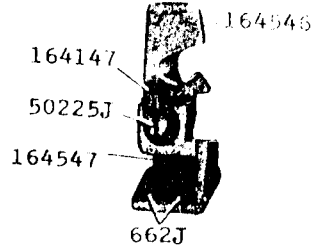

164556



164350

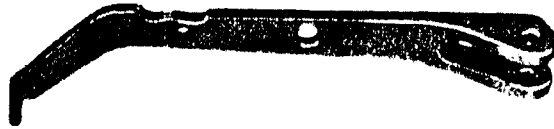

164055



164151



164091



164591



164175



24852-1/3

164657

164544



164545



164565

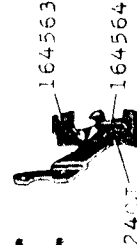

164227

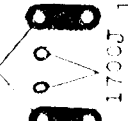

164654

140210C



164651



24210

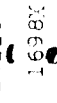

164234

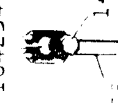

164655



164650



164566

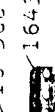

164568

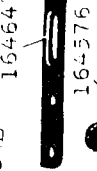

1550J



164581



164091



164591



164175

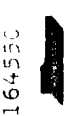

164055

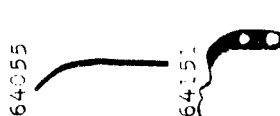

164151



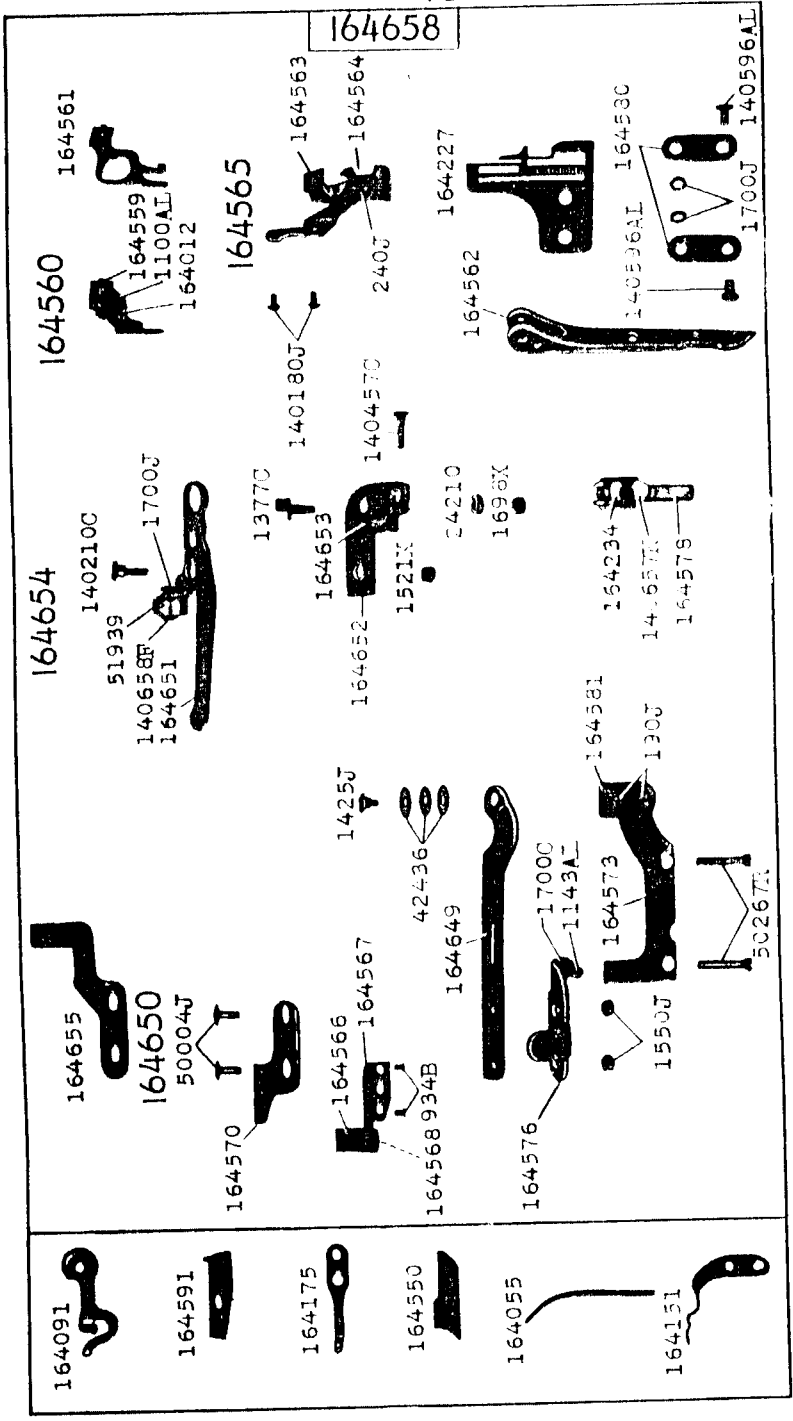

24853-1/3

164658

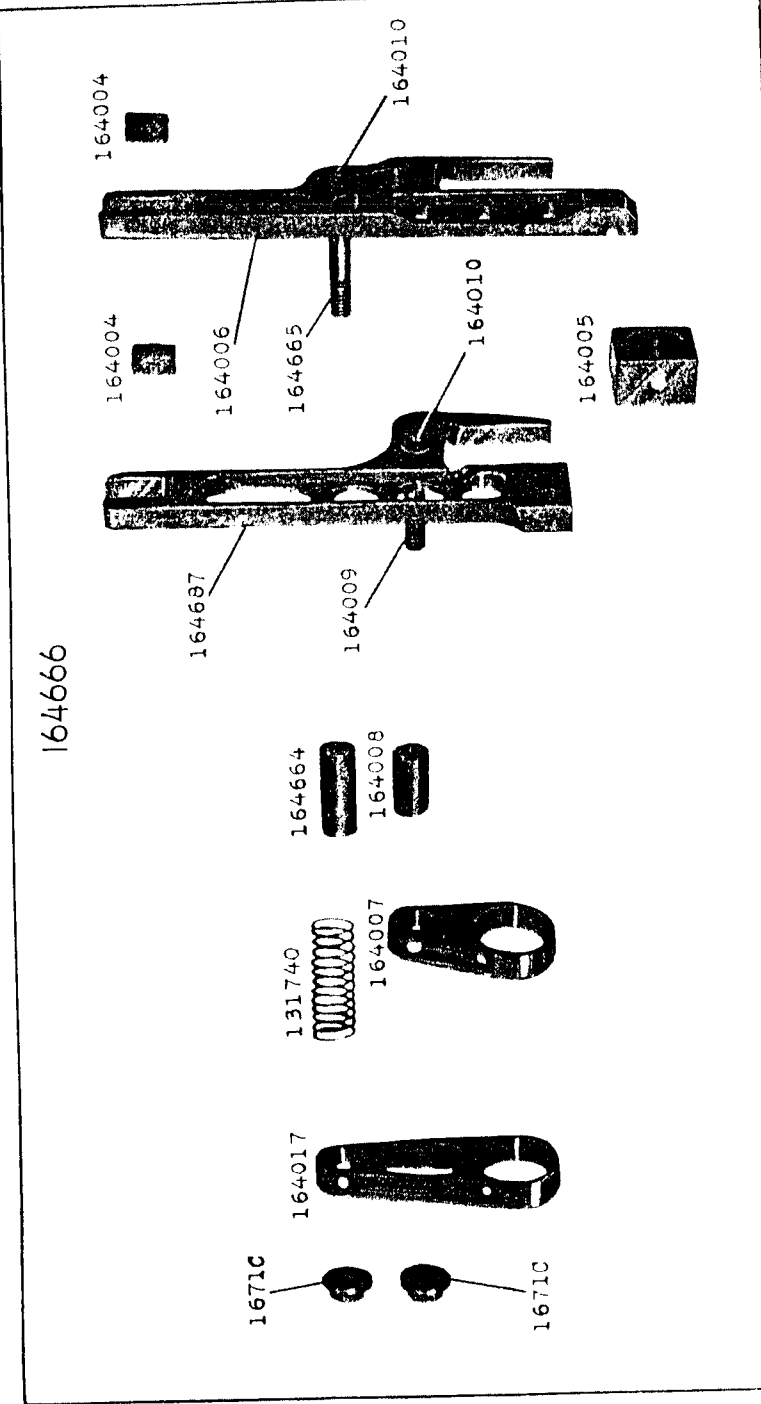

24854-1/2

164666