

**SINGER**  
**47W120**

# LIST OF PARTS



## MACHINE No. 47w120

---

THE SINGER MANUFACTURING COMPANY

## INDEX

---

	PAGE
ACCESSORIES .....	14
BOBBIN WINDER .....	14
KNEE LIFTER .....	15
MACHINE No. 47w120 .....	7
NUMERICAL LIST OF PARTS .....	17

# Instructions for Ordering

In ordering from this list, use **ONLY** the **PART** number in the **FIRST** column.

The number stamped on a Sewing Machine Part is the number of the Single Part only, except when the part includes Set Screws, Clamping Screws, Studs and Rollers Spun on, Small Wires riveted, or Parts soldered together, etc., which it is necessary to furnish in combination.

Every combination of parts sent out has its specific number which, although not stamped on Parts (except in above case), must be used when ordering the combination.

Each number always indicates the **SAME PART** in whatever list it appears, or for whatever Machine.

The letters after some of the numbers indicate the style of finish only, as follows:

- A. Hardened, Polished and Plated.
- B. Polished and Plated.
- C. Hardened only.
- D. Polished only.
- E. Soft, not polished.
- F. Hardened and Polished.
- H. Blued.

These letters **MUST BE USED** when they appear in the list and **AFTER** the number, as in the list.

In this series

- 200001 to 201500 are Screw Numbers.
- 201501 to 201800 are Nut Numbers.
- 201801 to 202000 are Roller Numbers.
- 202001 and upward are Numbers of Machine Parts.

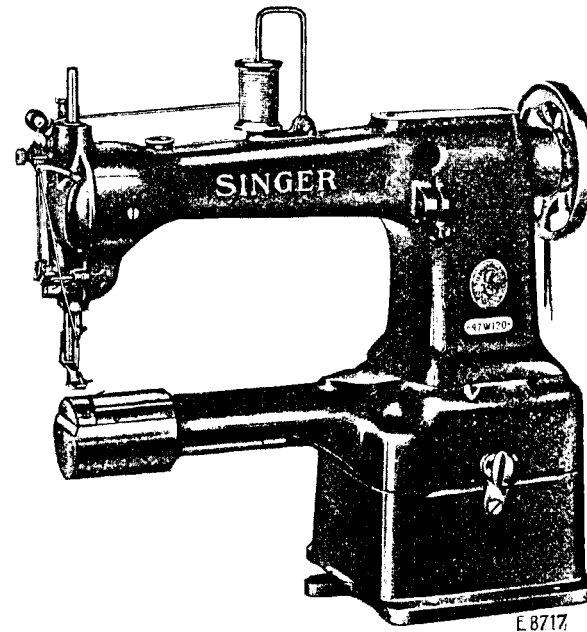
The figures in the second column refer only to the plate in which the illustration of the part is shown and are **NOT TO BE USED** in ordering.

Two or more numbers over a cut indicate that the difference between such parts is not visible in an illustration.

Parts marked with an asterisk (\*) are furnished only when repairs are made at the factory.

## LIST OF PARTS COMPLETE

FOR



### MACHINE No. 47w120

CYLINDER BED. NO FEED MOTION.

KNEE LIFTER

For General Darning

No.	Plate	Name
*213361	—	Arm .....
213144	15214	“ Cap .....
200278H	12311	“ “ Screw .....
202248	15213	“ “ “ Washer .....
204235	15213	“ Position Pin .....
200963E	12311	“ Screw (3) .....
202005	15213	“ “ Washer (3) .....
213341	15215	“ Shaft .....
204801	15214	“ “ Bushing (back) with 202260 .....

No.	Plate	Name
202260	—	Arm Shaft Bushing (back) Oil Packing (wick) .....
200338c	15213	Arm Shaft Bushing (back) Set Screw .....
213299	15214	Arm Shaft Bushing (center) with 202260 .....
202260	—	Arm Shaft Bushing (center) Oil Packing (wick) .....
200341c	15213	Arm Shaft Bushing (center) Set Screw .....
213781	15214	Arm Shaft Bushing (front) with 202036 and 202260 .....
202260	—	Arm Shaft Bushing (front) Oil Packing (wick) .....
200502B	15213	Arm Shaft Bushing (front) Oil Packing Thumb Screw .....
202036	15213	Arm Shaft Bushing (front) Position Pin .....
200352c	15213	Arm Shaft Bushing (front) Set Screw .....
204804	15214	Arm Shaft Connection with four 200054E (2) .....
200054E	15213	Arm Shaft Connection Screw .....
204805	15215	Balance Wheel, 5½ in. diam. (belt groove 2¾ in. diam.), with 200328c and 200335c .....
200062H	12311	Balance Wheel Adjusting Screw ..
200328c	12311	" " Position Screw .....
200335c	12311	" " Set Screw .....
*213377	—	Bed (cylinder) with 201461c, 213314, 213380 and two 200516E .....
*213786	—	Bed (cylinder) Cap (use 221188 for repairs) .....
221188	15214	Bed (cylinder) Cap with two each 200100D and 222404 .....
222404	15213	Bed (cylinder) Cap Position Pin ..
200100D	15213	" " " Screw .....
200574D	15213	" " " " (2) .....
213787	—	" " End Cover .....
213353	—	" " Base (6 in. high) .....
213890	—	" " (4 in. high) .....
		Note. High Bed Base 213353 furnished only when ordered.
203184	15213	Bed Clamp .....
200262H	15213	" " Hinge Screw .....
202622	15213	" " Packing Washer .....
200728B	15213	" " Thumb Screw .....
203185	15213	" " Washer .....

No.	Plate	Name
202618	15215	Bed Hinge .....
200030H	15213	" " Screw (6) .....
213338	15214	" Slide (back) .....
213685	15213	" " Clamp Plate .....
213686	15213	" " " " .....
200582H	15213	" " " " Screw (4)..
203208	11228	Bobbin .....
203210	11228	" Case Base with 202056, 203211 to 203213 and 203216 .....
203211	15213	Bobbin Case Base Latch .....
*202056	—	" " " " Pin .....
203212	15213	" " " " Plunger ..
203213	15213	" " " " Spring ..
203209	11228	" " Cap with 200984c, 203214, 203215 and two 200594c ..
203214	11228	Bobbin Case Tension Spring .....
200984c	11228	" " " " Regulating Screw .....
200594c	11228	Bobbin Case Tension Spring Screw
203215	11228	" " Thread Guide .....
200594c	11228	" " " " Screw ..
203216	11228	" " Washer (cloth) .....
203217	11228	Bobbin Case complete, Nos. 203209 and 203210 .....
204184	15215	Face Plate with 200355H, 200368H, 200688c, 202090, 204185, 204281 and two 200397H .....
200053c	12311	Face Plate Screw .....
204185	15213	" " Thread Guide .....
200397H	12309	" " " " Set Screw
204186	—	Face Plate complete, Nos. 200135E, 200309E, 200319c, 200577H, 204059, 204184, 204267, 204272 and 204277 to 204280 .....
*203239	—	Hook (sewing) .....
203240	11228	" 203239 with 201253F, 201376F and 203251 .....
203290	11228	Hook and Bobbin Case complete, Nos. 203217 and 203240 .....
203549	15213	Hook Bevel Gear Socket, 18 teeth
200556H	15213	" " " " Screw ...
213319	15213	" " Pinion with two 200386c
200386c	15217	" " " Set Screw .....
221172	15215	" Driving Shaft .....
213314	15214	" " " Bearing .....
202126	15217	" " " " Position Pin (2) .....

No.	Plate	Name
200516E	12311	Hook Driving Shaft Bearing Screw
213380	15214	" " " Bushing .....
201461c	15217	" " " " Position Screw .....
204246	15217	Hook Driving Shaft Collar (back) with two 200383c .....
200383c	15217	Hook Driving Shaft Collar (back) Set Screw .....
203244	15217	Hook Driving Shaft Collar (front) with two 200393c .....
200393c	15217	Hook Driving Shaft Collar (front) Set Screw .....
203251	11228	Hook Gib .....
201376F	15217	" " Hinge Screw .....
201253F	15217	" " Screw .....
203552	15216	" Saddle (right) with 202299 ..
202299	—	" " Oil Packing (wick) ...
200541E	15217	" " Screw (2) .....
225837	15217	" " " Washer (2) .....
203254	11228	" Washer .....
203554	—	Hook Saddle (right) complete, Nos. 200556H, 203254, 203290, 203549 and 203552 .....
202781	15215	Knee Lifter Lifting Lever .....
227306	—	" " " " 202781 with 200262H .....
200262H	15213	Knee Lifter Lifting Lever Hinge Screw .....
221145	15216	Knee Lifter Lifting Lever Position Spring (right) .....
200835D	15217	Knee Lifter Lifting Lever Position Spring Screw .....
208613	15216	Needle Bar (hollow) .....
204247	—	" " 208613 with 200125F, 200175D and 204250 .....
204248	15217	Needle Bar Connecting Link .....
200658c	15217	" " " " Hinge Screw Stud .....
201519E	15217	Needle Bar Connecting Link Hinge Screw Stud Nut .....
204249	15217	Needle Bar Connecting Stud with 200072c and 202277 .....
202277	—	Needle Bar Connecting Stud Oil Packing (wick) .....
200072c	15217	Needle Bar Connecting Stud Pinch Screw .....

No.	Plate	Name
204326	—	Needle Bar Packing Cord (2) ....
200504E	15217	" " Screw Bushing (lower)
200503B	15217	" " " " (upper)
204250	15217	" " Thread Guide .....
200175D	15217	" " " " Screw ..
200125F	15217	" Set Screw .....
204251	15216	Presser Bar (hollow) with 200074F
204252	10441	" " Lifter .....
200550c	10441	" " " Hinge Screw ...
204255	10441	" " Lifting Bracket with 200086c .....
200086c	10441	Presser Bar Lifting Bracket Pinch Screw .....
204254	10441	Presser Bar Lifting Bracket Posi- tion Guide .....
200362c	10441	Presser Bar Lifting Bracket Posi- tion Guide Set Screw .....
204327	—	Presser Bar Packing Washer (felt)
200504E	15217	" " Screw Bushing (lower)
204255	—	" " Spring .....
200491B	10441	" " Thumb Screw (pres- sure regulating) .....
221193	15218	Presser Foot .....
200074E	10441	" " Screw .....
202068	15216	Spool Holder Base .....
200575H	12311	" " " Screw .....
204296	15216	" " Wire .....
200079H	12311	" " " Hinge Screw ...
204297	15216	Spool Holder complete, Nos. 200079H, 202068 and 204296 .....
212920	15216	Take-up Cam with 200335c and 200430c .....
203268	—	Take-up Cam 212920 with 200383c, 200658c and 201519E .....
203172	15217	Take-up Cam Friction Washer ...
200430c	12311	" " Position Screw .....
200383c	15217	" " " " Check Screw .....
200335c	12311	Take-up Cam Set Screw .....
204262	15217	" Lever .....
206556	—	" " 204262 with 204263 ...
204263	15217	" " Bearing with 204264..
204264	15217	" " " Position Pin ...
200042F	12311	" " " Screw .....
201816	15217	" " Roller .....
204266	—	Take-up Lever complete, Nos. 200042F, 201816 and 206556 .....

No.	Plate	Name
244007	12309	Tension Disc .....
202090	15217	" " Position Pin .....
204267	15217	" Release Lever .....
200688C	15217	" " " Position Screw .....
200309E	12309	" " " Screw .....
202075	12309	" " Plunger .....
208489	15218	" " Slide .....
206608	15217	" " " Spring .....
202407	10881	" Spring .....
200632B	12309	" Stud .....
200397H	12309	" " Set Screw .....
201572B	10881	" Thumb Nut .....
204271	12309	" Washer .....
204272	12309	Tension complete, Nos. 200632B, 201572B, 202075, 202407, 204271 and two 244007 .....
204273	15217	Thread Controller Adjusting Collar with 200684H (for Presser Bar)
200684H	15218	Thread Controller Adjusting Collar Screw .....
204274	12309	Thread Controller Plate .....
200577H	12311	" " " Screw .....
202098	12309	" " Roller .....
204275	12309	" " " Guard .....
202084	15218	" " " " Washer .....
200300C	12309	" " " Screw .....
204276	12309	" " Spring .....
204333	12309	" " " Guard .....
200581H	12309	" " " " Screw .....
204277	12309	" " " Stop .....
204278	12309	" " " " Driving Gear .....
200319C	12309	Thread Controller Spring Stop Driving Gear Hinge Screw .....
200135E	12309	Thread Controller Spring Stop Screw .....
204279	12309	Thread Controller Spring Stud with 204925 .....
200355H	15218	Thread Controller Spring Stud Set Screw .....
204925	15218	Thread Controller Spring Stud Washer .....
205987	12309	Thread Controller complete, Nos. 200300C, 200581H, 202084, 202098, 204274, 204275 and 204333 .....
204280	12309	Thread Controller and Spring com- plete, Nos. 204276 and 205987 ..

No.	Plate	Name
202413	15218	Thread Guide .....
204281	12309	" Retainer Guide Wire .....
202091	12309	" " Sleeve .....
202092	12309	" " Spring .....
204058	12309	" " Stud .....
200368H	12309	" " " Set Screw .....
204059	12309	Thread Retainer complete, Nos. 202091, 202092 and 204058 .....
221194	15218	Throat Plate, 40 needle hole, for needle sizes 16 and 18 .....
200577H	12311	Throat Plate Screw (2) .....

## ACCESSORIES

No.	Plate	Name
203208	11228	Bobbin (5) .....
*225482	—	" Case Screw Driver Blade ..
*225483	—	" " " " Handle ..
225497	14154	Bobbin Case Screw Driver complete, Nos. 225482 and 225483 ..
204033	15218	Wrench .....
126 x3	—	Needles, six, size 18 .....
227104	—	Drip Pan with one wood screw 1½ in., No. 14 .....
41401	14154	Machine Rest Pin (wood) .....
120342	14154	Oiler (copper plated) with 120343
120343	14154	" Spout, 3½ in. long .....
*225484	—	Screw Driver Blade .....
*225485	—	" " Handle .....
225498	14154	Screw Driver complete (7¼ in. long), Nos. 225484 and 225485 ..
225554	14154	Wrench (steel) .....

### BOBBIN WINDER

#### Swing Automatic, Right Hand

225453	10884	Frame with 202277 and 225438 ...
225454	10884	" Hinge Pin .....
202277	—	" Oil Packing (wick) .....
225438	10884	" " Well Cap .....
225455	10884	" Spring .....
225456	10884	" " Plunger .....
202473	10885	Pulley with 200380c .....
200380c	15218	" Set Screw .....
225381	10884	Spindle .....
225444	10884	Stop Latch .....
200056E	10884	" " Screw .....
225458	10884	" " Thumb Lever .....
225459	10884	" " " " Hinge Stud
225459	10884	" " " " Joint Stud
202478	10884	" " Trip Lever .....
200299H	10884	" " " " Hinge Screw
225461	10881	Tension Bracket with 201499B ....
200082D	10881	" " Screw .....
228026	10884	" " " Washer .....
2102	10881	" Disc .....
202407	10881	" Spring .....
201499B	10881	" Stud .....
201572B	10881	" " Thumb Nut .....

No.	Plate	Name
225462	10881	Bobbin Winder Tension Bracket complete, Nos. 201572B, 202407, 225461 and two 2102 .....
225433	10885	Bobbin Winder and Tension Bracket Base .....
225382	10885	Universal Bobbin Winder complete, Nos. 200056E, 200082D, 200299H, 202473, 202478, 225381, 225433, 225444, 225453 to 225456, 225458, 225462, 228026 and two each 225459 and wood screws ¾ in., No. 12, R.H.B. ....

### KNEE LIFTER

227626	15219	Lifting Lever Chain Spring .....
227471	—	" " " " " 227626 with 202784 .....
202784	15219	Lifting Lever Chain Spring Hook ..
2763	15219	Rock Shaft .....
12242	15219	" " Hanger (back) with two wood screws 1 in., No. 10 ..
21327	15219	Rock Shaft Hanger (front) with two wood screws 1 in., No. 10 ..
6337	15219	Rock Shaft Lifting Bracket with two 356c .....
39811	15219	Rock Shaft Lifting Bracket Extension with 39576 .....
356c	15219	Rock Shaft Lifting Bracket Extension Set Screw .....
356c	15219	Rock Shaft Lifting Bracket Set Screw .....
227676	15219	Rock Shaft Lifting Chain with 202784 .....
39576	15219	Rock Shaft Lifting Chain Hook (lower) .....
202784	15219	Rock Shaft Lifting Chain Hook (upper) .....
228562	15219	Rock Shaft Knee Arm .....
2766	15219	" " " " Hub with 356c .....
356c	15219	Rock Shaft Knee Arm Hub Set Screw .....
1507R	15219	Rock Shaft Knee Arm Lock Nut
228563	—	Knee Lifter Rock Shaft Knee Arm complete, Nos. 1507R, 2766, 2767 and 228562 .....

No.	Plate	Name
2767	15219	Rock Shaft Knee Plate with 356c..
228255	15219	" " " " Counter
		Balance Spring .....
356c	15219	Rock Shaft Knee Plate Set Screw
2770	15219	" " Stop Dog with 356c ...
356c	15219	" " " " Set Screw ..
228251	15219	Knee Lifter Rock Shaft complete, Nos. 2763, 6337, 12242, 21327, 39811, 227676, 228255, 228563, Form A 1079 and two 2770 .....

(Other Knee Lifter parts are listed with parts of machine head.)

PLATE 10441—FULL SIZE

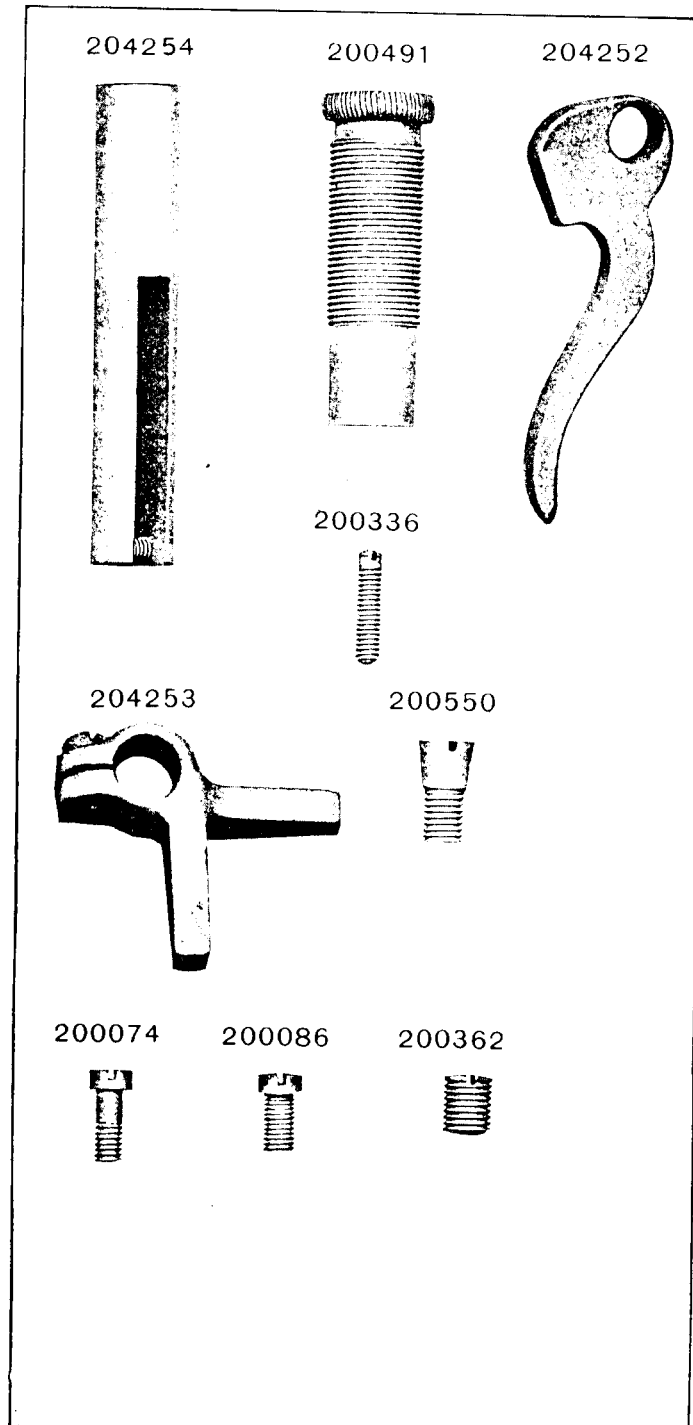
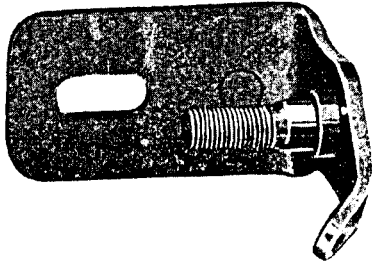




PLATE 10881—FULL SIZE

225461



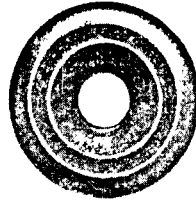
200082



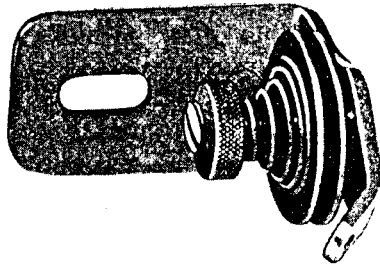
202104



2102



225462



202407



201499

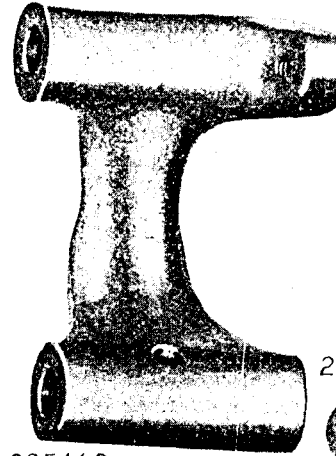


201572

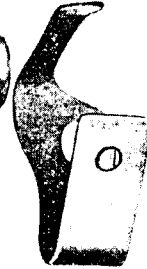


PLATE 10884—FULL SIZE

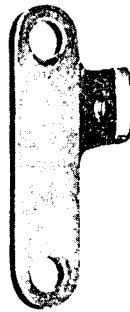
225453



225444



202478



228026



225458



225460



225454



200299



225438



200056



225459



200105



225456



225381

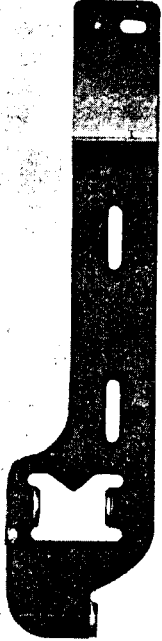


225455



PLATE 10885-ONE-FOURTH SIZE

225433



202473

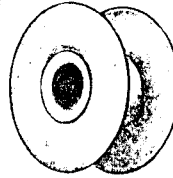


225382



PLATE 11228-FULL SIZE

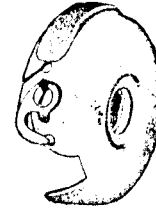
203208



203214



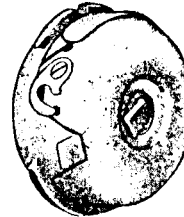
203209



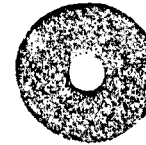
203215



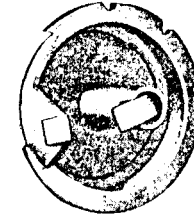
203217



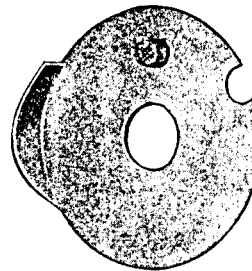
203216



203210



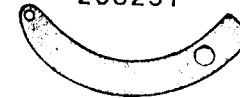
203254



200600



203251



200984



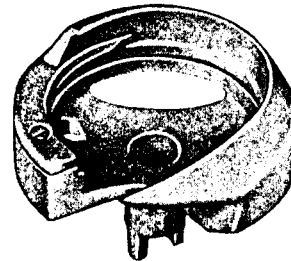
200616



200594



203240



203290

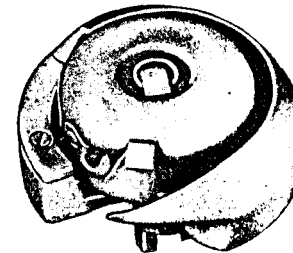


PLATE 12309 - FULL SIZE

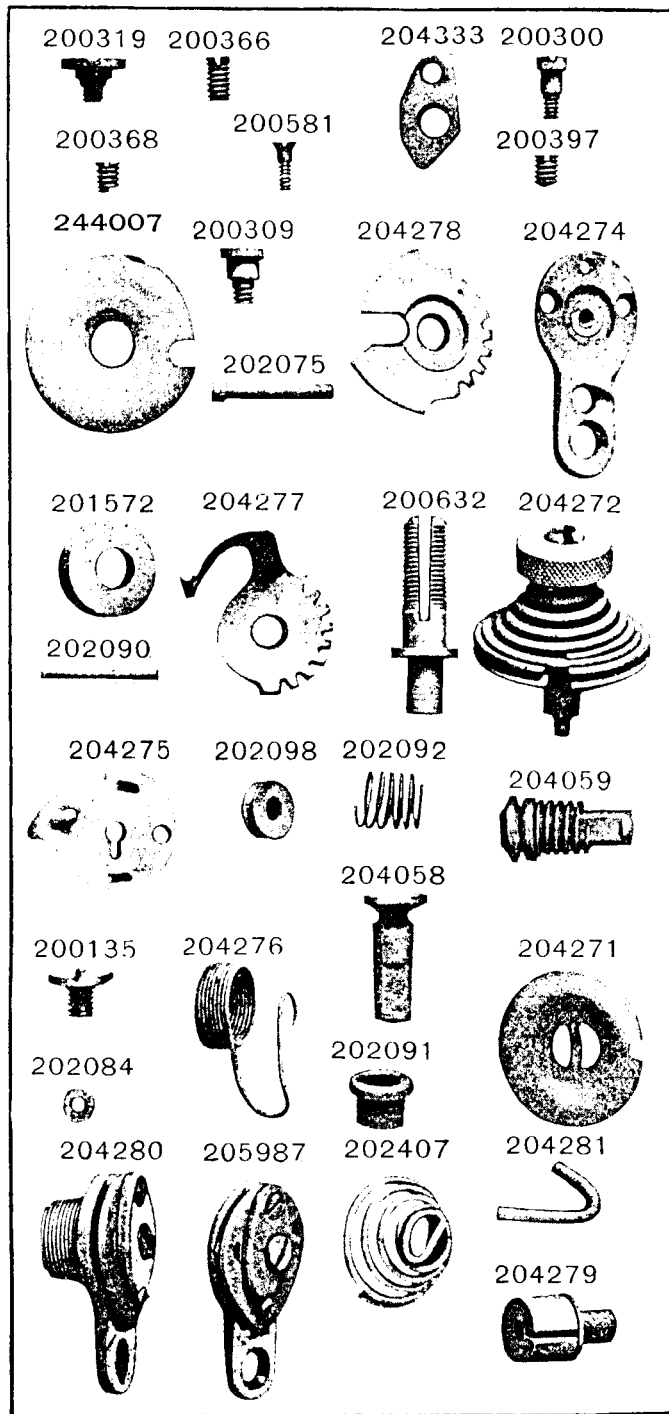


PLATE 12311 - FULL SIZE

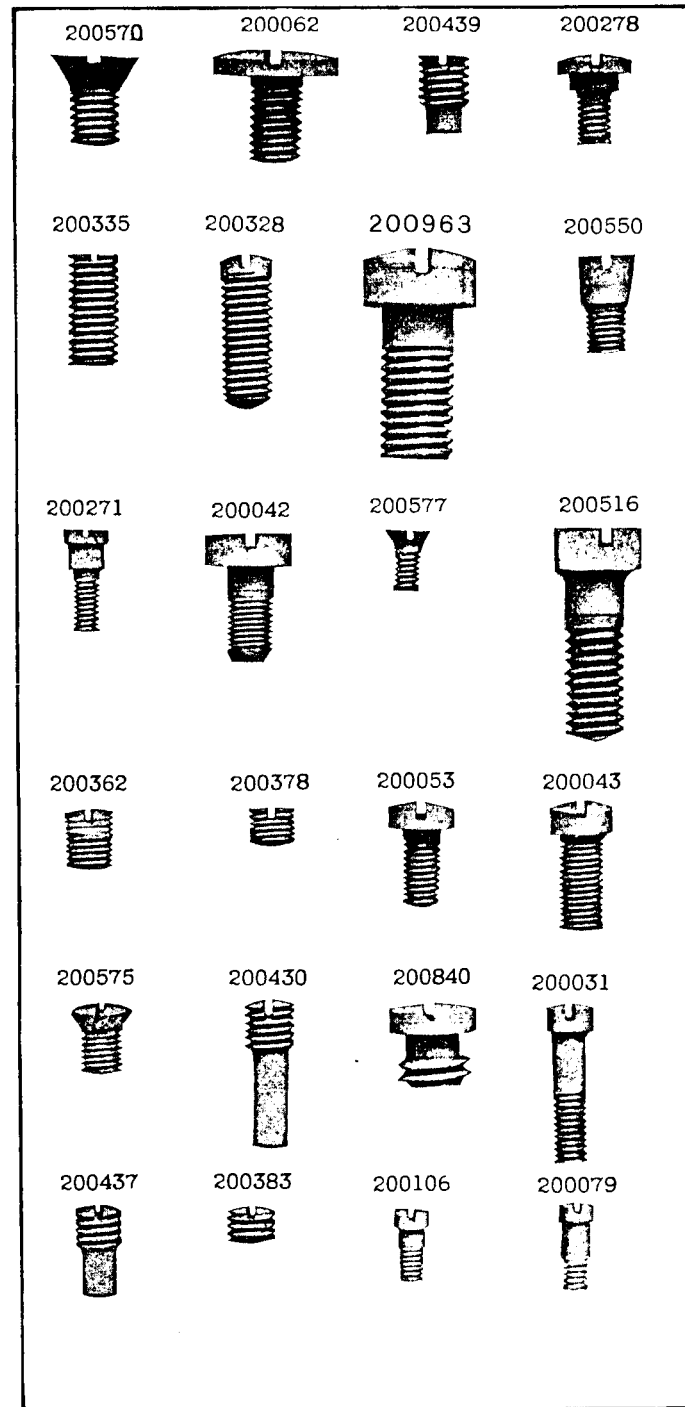


PLATE 14154—ONE-HALF SIZE

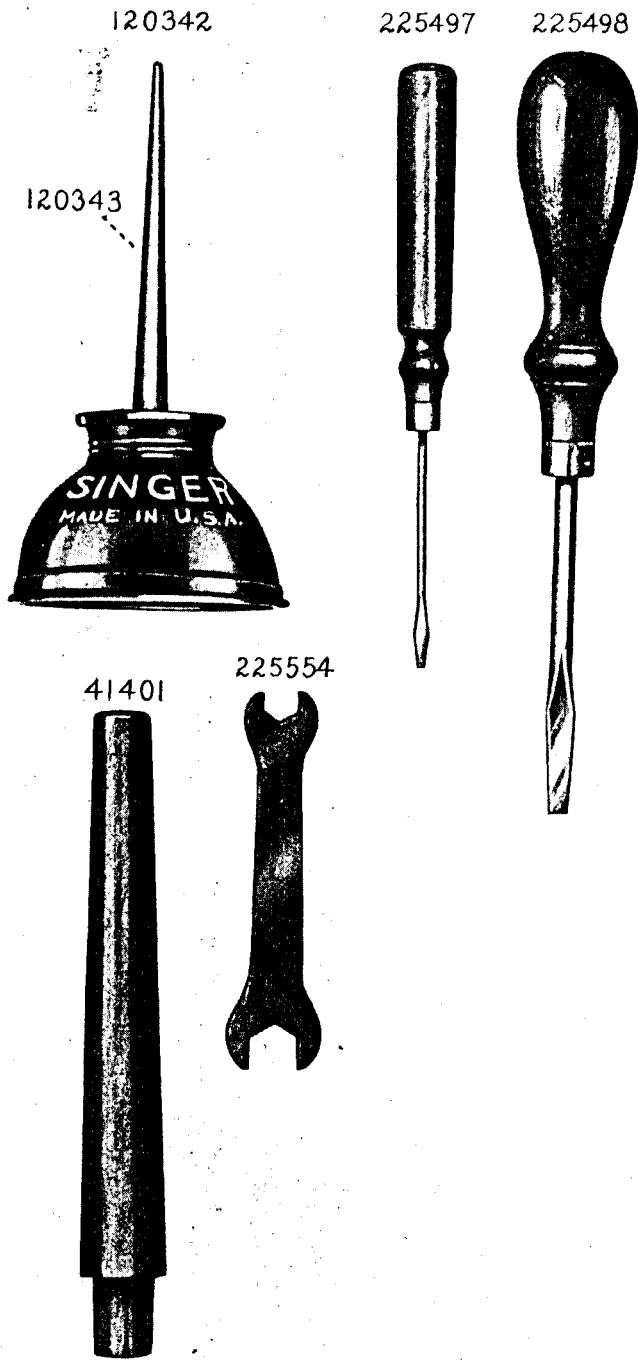


PLATE 15213—FULL SIZE

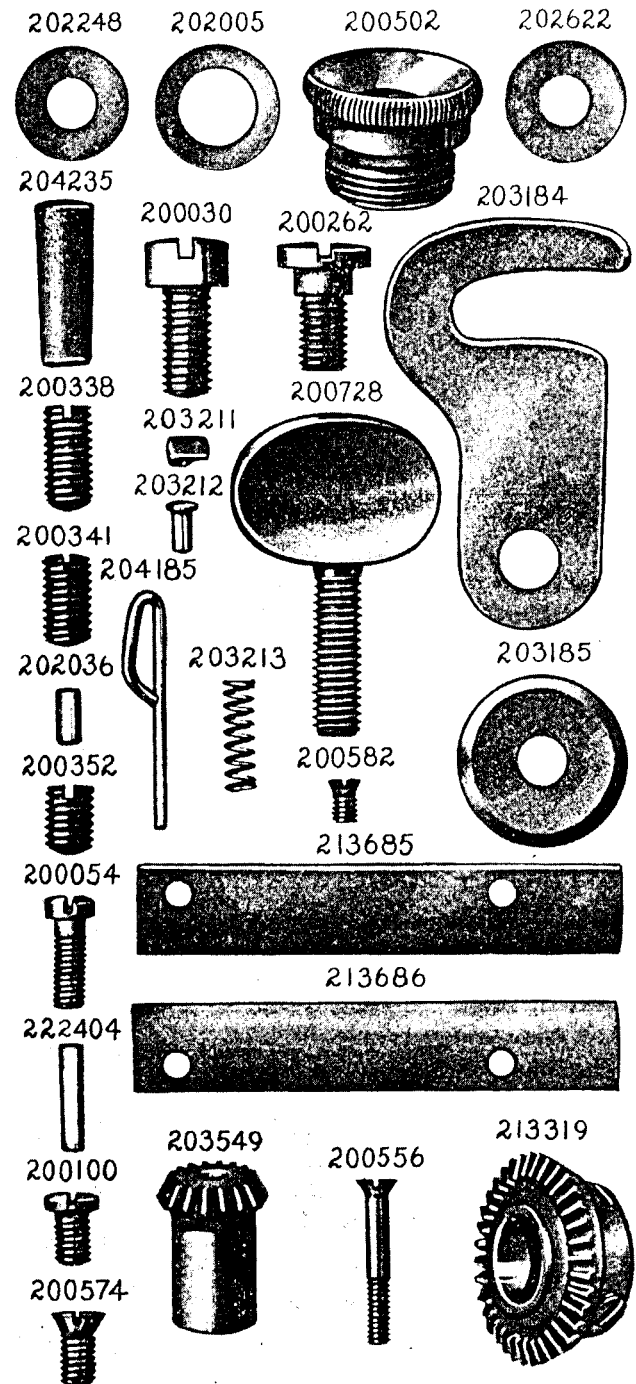
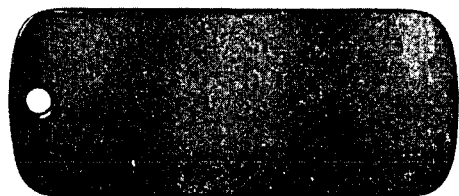
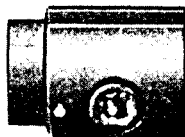


PLATE 15214—ONE-HALF SIZE

213144



213781



213299



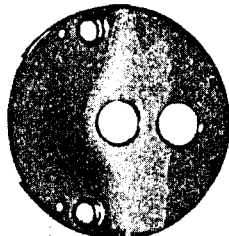
204801



204804



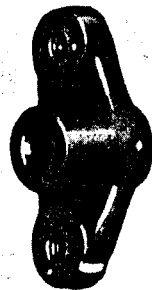
221188



213338



213314

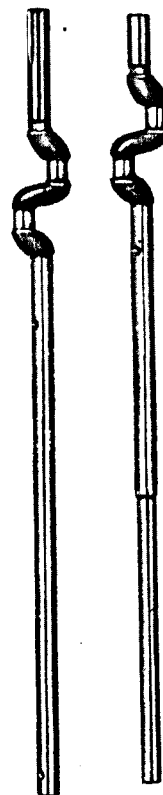


213380

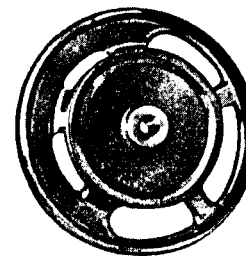


PLATE 15215—ONE-FOURTH SIZE

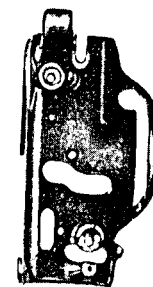
213341 221172



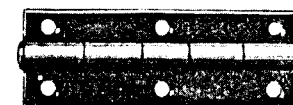
204805



204184



202618



202781



PLATE 15216—ONE-HALF SIZE

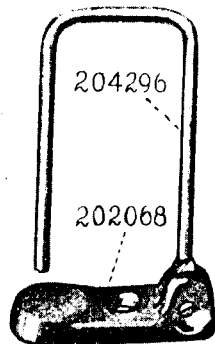
208613



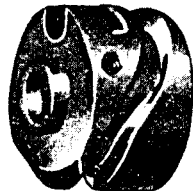
204251



204297



212920



203552



221145

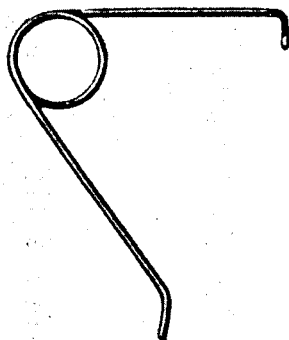
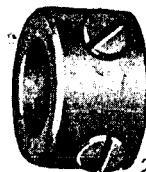


PLATE 15217—FULL SIZE

204246



203244



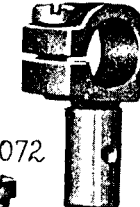
225837



204248



204249



200383



200504



200386



200072



202126



200503

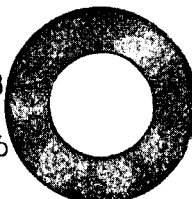


204262

201461



203172



204264



201519



200393



201816



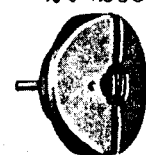
202090



201376



204263



204267



201253



200541



200835



204250



200688



200658



200125



206608



200175

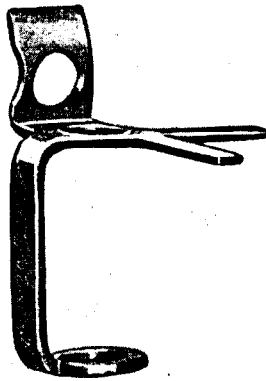


204273



PLATE 15218—FULL SIZE

208489



200684



202084



221194



221193



202413



200380



200355



204925



204033

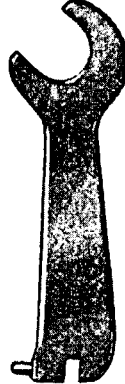
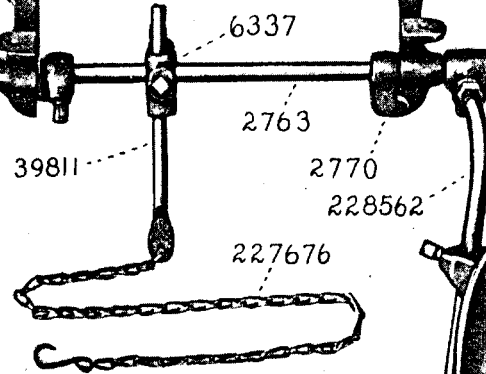


PLATE 15219—ONE-FOURTH SIZE

12242



228251



21327

6337

2763

39811

2770

228562

227676

2767

FULL SIZE

227626



1507



202784



39576



228255



356



2766

