

MACHINE PARTS CHART

for

SINGER^{*}

20U43

SINGER*

20U 43

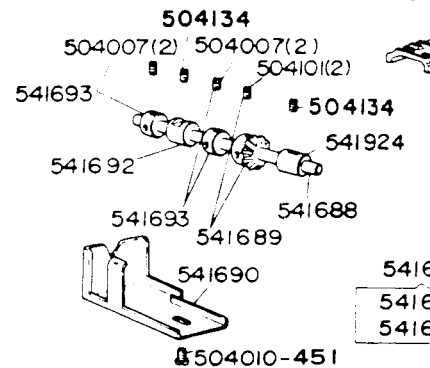
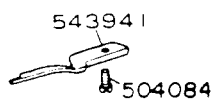
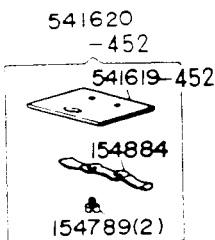
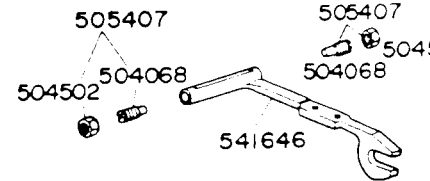
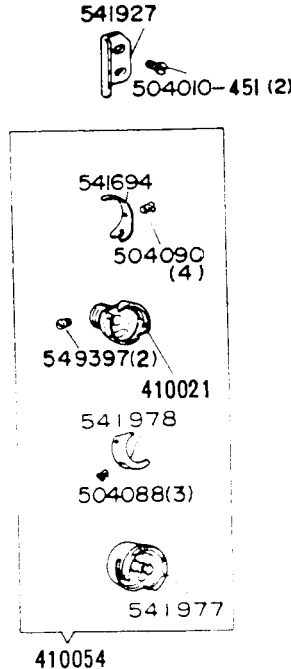
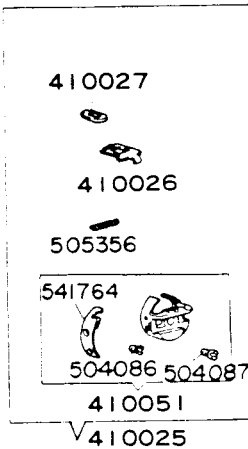
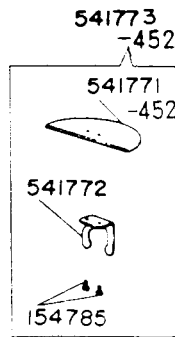
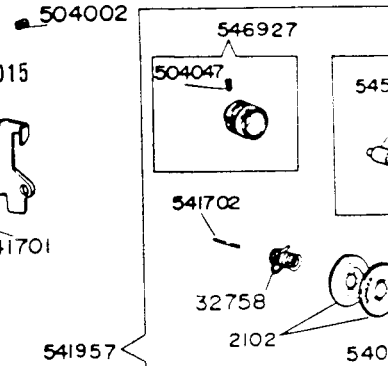
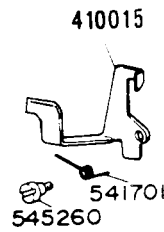
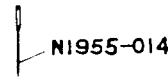
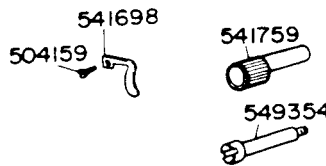
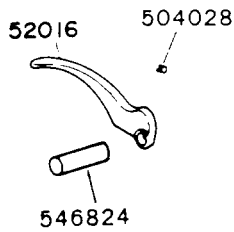
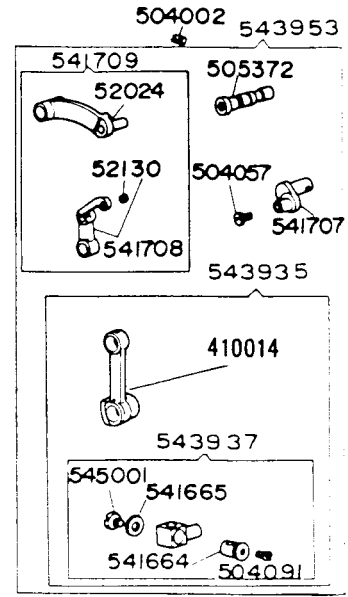
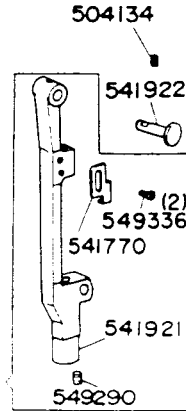
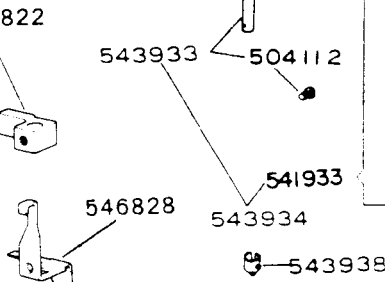
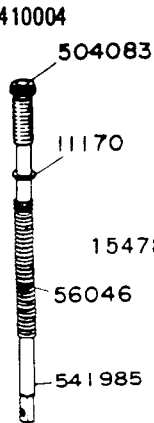
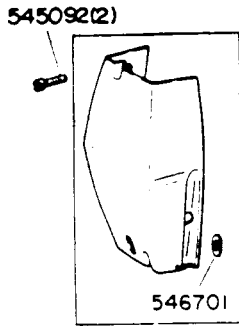
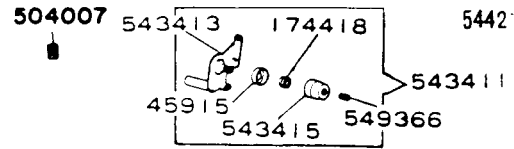
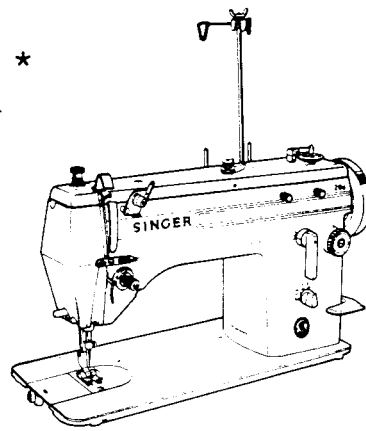

410054

12

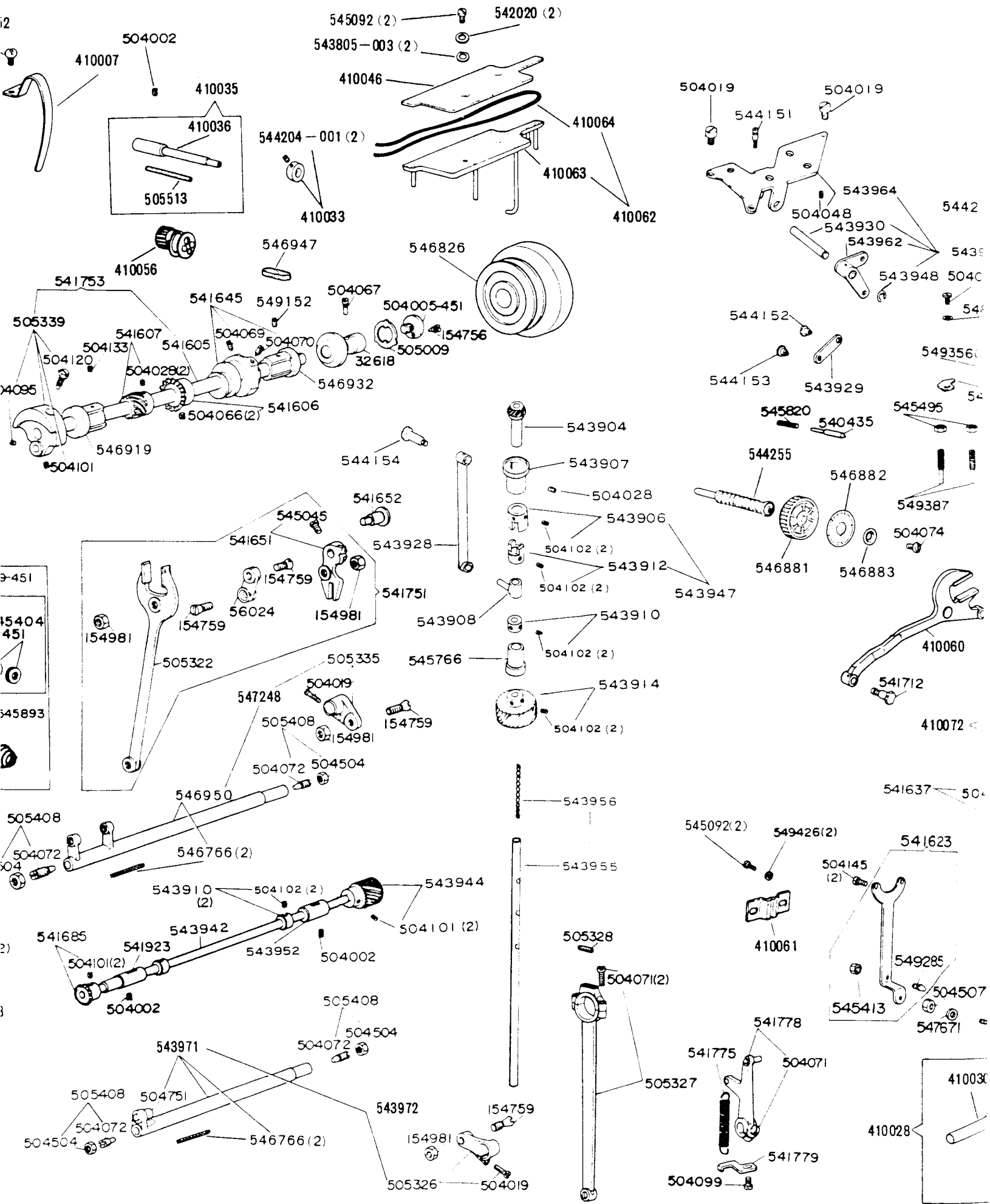

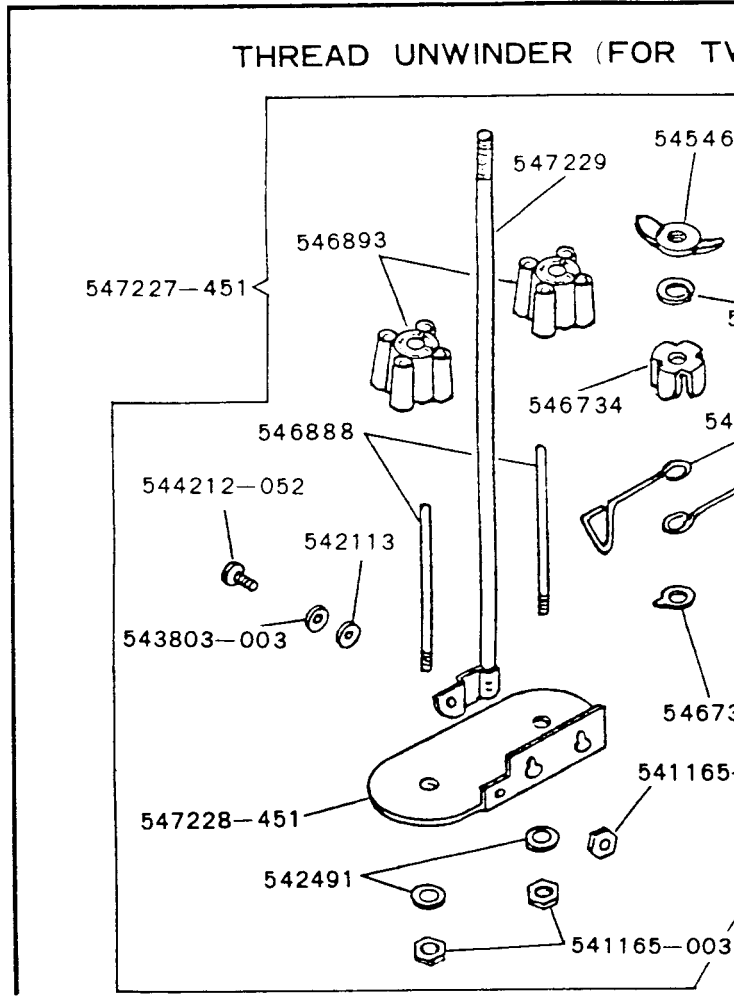
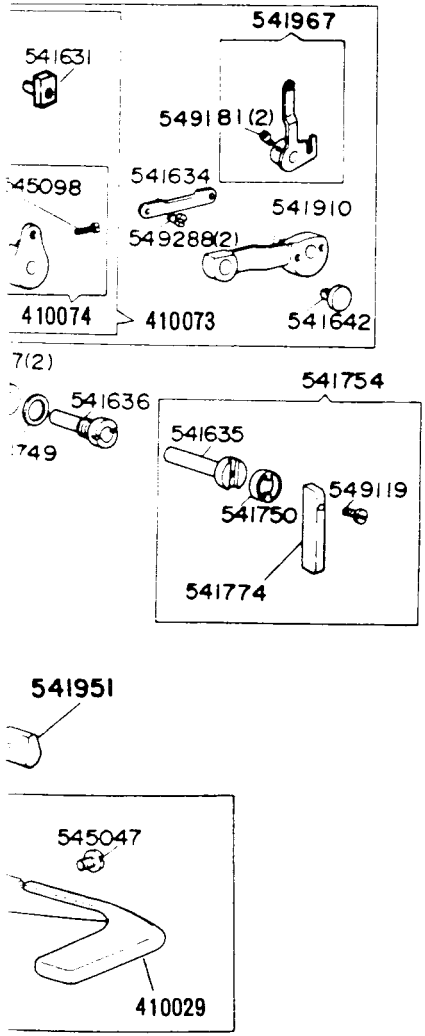
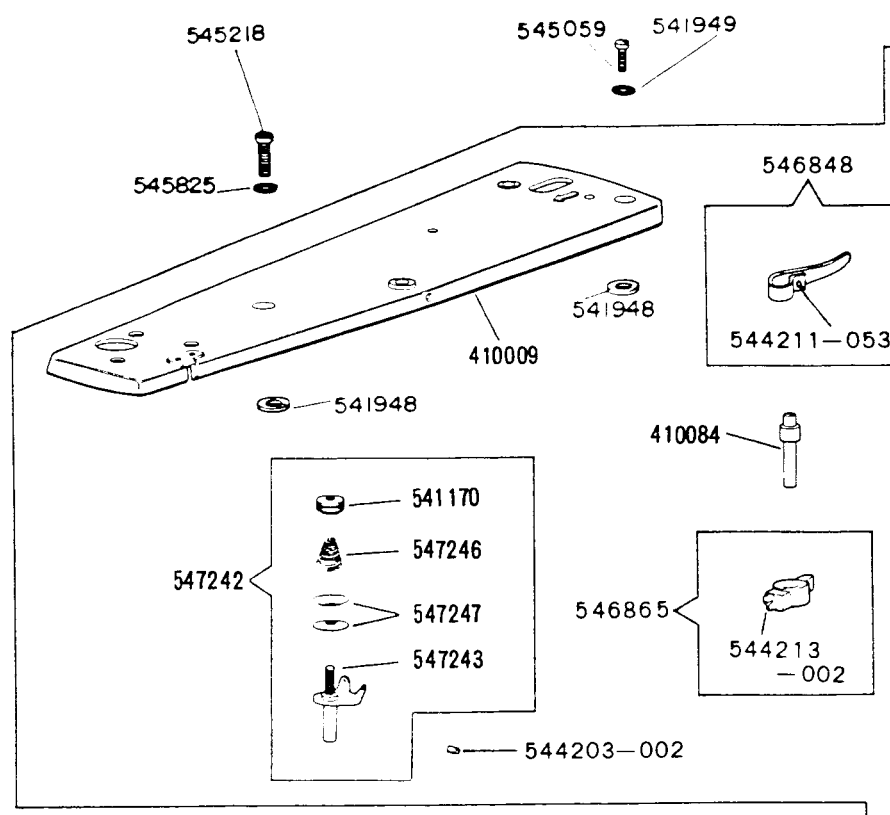
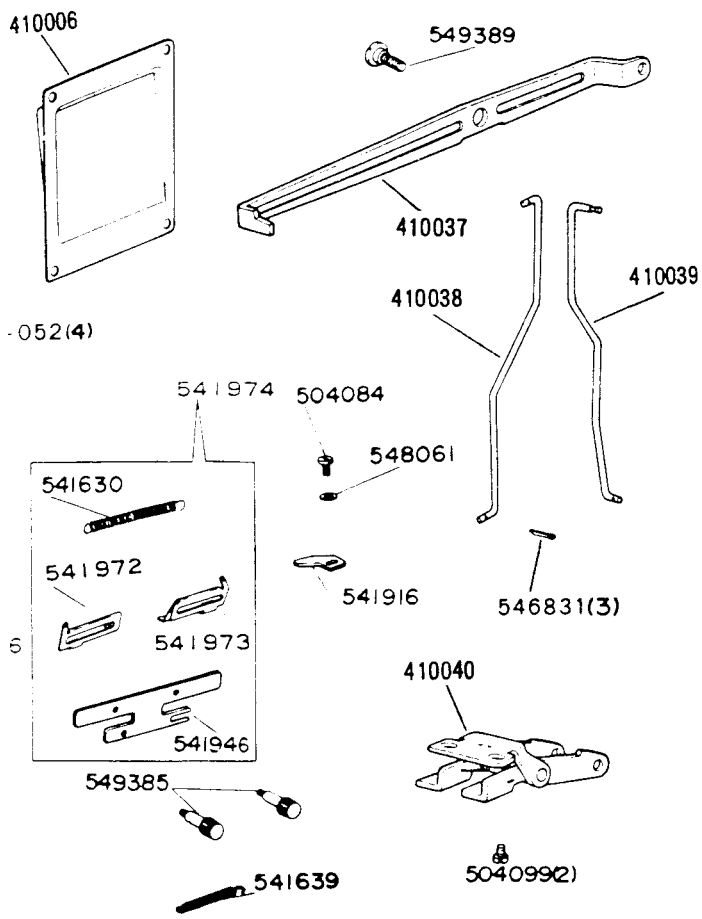

ACCESSORIES AND ATTACHMENTS

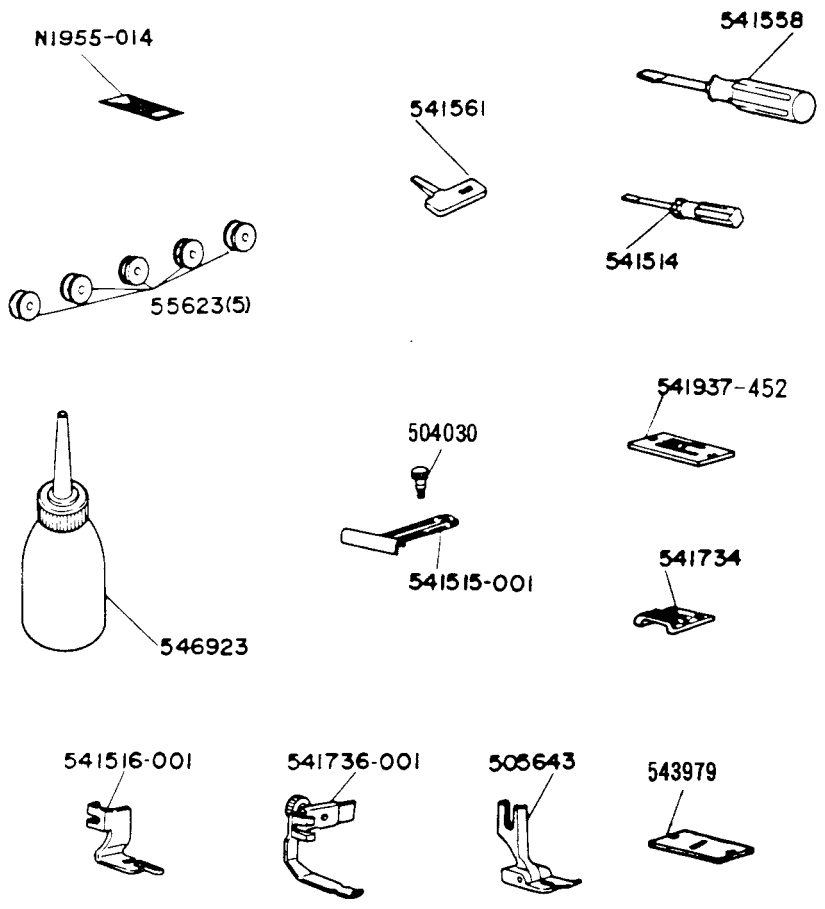
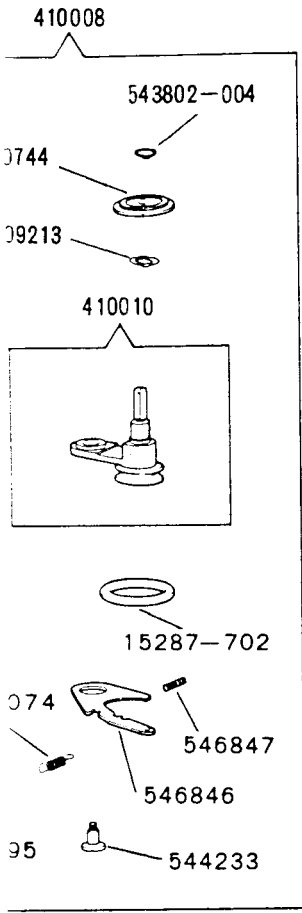

SPOOLS)

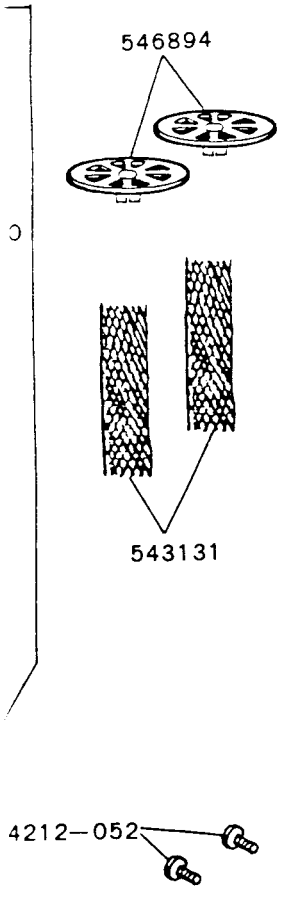

NUMERICAL LIST OF PARTS FOR 20043 M/C

<u>PART NO.</u>	<u>DESCRIPTION</u>	<u>PART NO.</u>	<u>DESCRIPTION</u>
691-845	Throat Plate Screw (2)	410744	Bobbin Winder Spindle Guard
2102	Tension Disc (2)	504002	Zig-Zag Triangular Cam Shaft Set Screw
11170	Presser Bar Spring Washer	504002	Rotating Hook Drive Shaft Bushing (back) Set Screw
15287-702	Bobbin Winder Friction Ring	504002	Rotating Hook Drive Shaft Bushing (front) Set Screw
32618	Clamp Stop Motion Clamp Flanged Bushing	504002	Thread Take-up Lever Link Hinge Pin Set Screw
32758	Thread Take-up Spring	504002	Thread Take-up Spring Regulator Set Screw
45915	Pre-Tension Disc	504005-451	Clamp Stop Motion Clamp Screw
52016	Presser Bar Lifter	504007	Bight Amplitude Slide Block Crank Shaft Bushing Collar Set Screw (2)
52024	Thread Take-up Lever Link	504007	Pre-Tension Set Screw
52130	Thread Take-up Lever Thread Eyelet Bushing	504007	Rotating Hook Shaft Retainer Collar Screw (4)
55623	Rotating Hook Bobbin	504010-451	Needle Bar Connecting Link Guide Screw (2)
56024	Feed Connecting Link	504010-451	Rotating Hook Shaft Bevel Gear Cover Screw
56046	Presser Bar Spring	504010-451	Thread Guard (upper) Set Screw
154756	Clamp Stop Motion Clamp Stop Screw	504019	Feed Lifting Rock Shaft Crank Clamping Screw
154759	Feed Connecting Link Hinge Screw (2)	504019	Feed Rock Shaft Crank Clamping Screw
154759	Feed Forked Connection Hinge Screw	504019	Hook Advancing Crank Bracket Screw (left) (right) (2)
154759	Feed Lifting Rock Shaft Crank Connecting Rod Hinge Screw	504028	Presser Bar Lifter Pin Set Screw
154780	Presser Bar Guide Bracket Set Screw	504028	Arm Shaft (horizontal) Worm Gear Set Screw (2)
154785	Bed Plate Bracket Screw (2)	504028	Arm Shaft (upright) Bushing (upper) Set Screw
154789	Bed Slide Spring Screw (2)	504047	Tension Stud Set Screw
154884	Bed Slide Spring	504048	Hook Advancing Crank Shaft Set Screw
154981	Feed Connecting Link Hinge Screw Nut (2)	504057	Needle Bar Connecting Link Cap Screw
154981	Feed Forked Connection Hinge Screw Nut	504063-451	Presser Foot Screw
154981	Feed Lifting Rock Shaft Crank Connecting Rod Hinge Screw Nut	504066	Arm Shaft (horizontal) Bevel Gear Set Screw (2)
174418	Pre-Tension Spring	504067	Clamp Stop Motion Clamp Flanged Bushing Set Screw
408074	Bobbin Winder Bracket Regulating Plate Spring	504068	Feed Bar Screw Center (2)
409213	Bobbin Winder Spindle Guard Wave Washer	504069	Feed and Feed Lifting Eccentric Position Screw
410004	Face Plate with 546701	504070	Feed and Feed Lifting Eccentric Set Screw
410006	Arm Side Cover	504071	Feed Lifting Rock Shaft Crank Connecting Rod Cap Screw (2)
410007	Thread Take-up Lever Guard	504071	Feed Reverse Lever Link Clamping Screw
410008	Arm Top Cover Complete, Nos. 15287-702, 408074, 409213, 410009, 410010, 410084, 410744, 543802-004, 544203-002, 544233, 546846, 546847, 546848, 546865, 546895, 547242 and two 541948	504072	Feed Lifting Rock Shaft Screw Center (2)
410009	Arm Top Cover	504072	Feed Rock Shaft Screw Center (2)
410010	Bobbin Winder Bracket Complete	504074	Feed Regulating Stud Head Cap Screw
410014	Needle Bar Connecting Link	504083	Presser Regulating Thumb Screw
410015	Tension Releasing Lever	504084	Bight Amplitude Stop Plate (left) (right) Screw (2)
410021	Rotating Hook	504084	Rotating Hook Bobbin Case Holder Position Bracket Screw
410025	Rotating Hook Bobbin Case Complete, Nos. 410026, 410027, 410051 and 505356	504086	Rotating Hook Bobbin Case Tension Regulating Screw
410026	Rotating Hook Bobbin Case Latch	504087	Rotating Hook Bobbin Case Tension Spring Screw
410027	Rotating Hook Bobbin Case Latch Lever	504088	Rotating Hook Section Screw (3)
410028	Feed Reverse Lever Complete, Nos. 410028, 410029 and 545047	504090	Rotating Hook Thread Guard Screw (4)
410029	Feed Reverse Lever	504091	Needle Bar Set Screw
410030	Feed Reverse Lever Hinge Stud	504095	Thread Take-up Crank Position Screw
410033	Zig-Zag Triangular Cam Shaft Collar with two 544204	504099	Feed Reverse Lever Return Spring Bracket Screw
410035	Zig-Zag Triangular Cam Shaft Complete, Nos. 410036 and 505513	504099	Bell Crank Bracket Screw (2)
410036	Zig-Zag Triangular Cam Shaft	504101	Rotating Hook Drive Shaft Screw Gear (back) Set Screw(2)
410037	Lifting Lever	504101	Rotating Hook Drive Shaft Bevel Gear (front) Set Screw(2)
410038	Lifting Lever Connecting Rod	504101	Rotating Hook Shaft Bevel Gear Set Screw (2)
410039	Bight Amplitude Slide Block Crank Knee Operating Connection	504102	Thread Take-up Crank Set Screw
410040	Bell Crank Complete	504102	Arm Shaft (upright) Bevel Gear (upper) Joint Set Screw (2)
410046	Oil Reservoir Felt	504102	Arm Shaft (upright) Retainer Collar Set Screw (2)
410051	Rotating Hook Bobbin Case with 504086, 504087 and 541764	504102	Rotating Hook Drive Shaft Retainer Collar Set Screw (4)
410054	Rotating Hook and Rotating Hook Bobbin Case Holder Complete, Nos. 410021, 541694, 541977, 541978, two 549397, three 504086, and four 504090	504102	Arm Shaft (upright) Retainer Joint Set Screw
410056	Zig-Zag Triangular Cam Gear and Zig-Zag Triangular Cam Complete	504102	Arm Shaft (upright) Screw Gear Set Screw (2)
410060	Zig-Zag Stitch Regulator Fork	504112	Needle Set Screw
410061	Bight and L-C-R Position Block	504120	Needle Bar Crank Position Screw
410062	Oil Reservoir 410063 with 410064	504133	Arm Shaft (horizontal) Flanged Bushing (front) Set Screw
410063	Oil Reservoir	504134	Needle Bar Frame Pin Set Screw
410064	Oil Reservoir Oil Wick	504134	Rotating Hook Shaft Bushing (short) Set Screw
410072	Bight Amplitude Slide Block Crank 541967 with 410073, 541434, 541442, 541910 and two 543288	504134	Rotating Hook Shaft Bushing (long) Set Screw
410073	Bight Amplitude Slide Block Guide 410074 with 541631	504145	Bight and L-C-R Position Lever Set Screw (2)
410074	Bight Amplitude Slide Block Guide with 545096	504159	Slack Thread Regulator Set Screw
410084	Bobbin Winder Latch Stud	504532	Feed Bar Screw Center Nut (2)
		504534	Feed Lifting Rock Shaft Screw Center Nut (2)
		504534	Feed Rock Shaft Screw Center Nut (2)
		504537	Bight and L-C-R Position Lever Thumb Stud Nut
		504751	Feed Lifting Rock Shaft Roller and Stud
		505001	Arm Jewel Pin (2)
		505006	Clamp Stop Motion Clamp Washer
		505320	Feed Forked Connection
		505326	Feed Lifting Rock Shaft Crank with 544019
		505327	Feed Lifting Rock Shaft Crank Connecting Rod with two 504071

NUMERICAL LIST OF PARTS FOR 20043 M/C

<u>PART NO.</u>	<u>DESCRIPTION</u>	<u>PART NO.</u>	<u>DESCRIPTION</u>
505328	Feed Lifting Rock Shaft Crank Connecting Rod Cap Oil Pad (felt)	541772	Bed Plate Bracket
505335	Feed Rock Shaft Crank with 504019	541773-452	Bed Plate Complete, Nos. 541771-452 with 541772 and two 154785
505339	Needle Bar Crank with 504095, 504101 and 504120	541774	Bight Amplitude Slide Block Crank Shaft Knob
505356	Rotating Hook Bobbin Case Latch Spring	541775	Feed Reverse Lever Return Spring
505372	Thread Take-up Lever Link Hinge Pin	541778	Feed Reverse Lever Link with 504071
505407	Feed Bar Screw Center 504068 with 504502 (2)	541779	Feed Reverse Lever Return Spring Bracket (hook)
505408	Feed Lifting Rock Shaft Screw Center 504072 with 504504 (2)	541910	Bight and L-C-R Position Lever Arm
505408	Feed Rock Shaft Screw Center 504072 with 504504 (2)	541916	Bight Amplitude Stop Plate (left) (right) (2)
505513	Zig-Zag Triangular Cam Shaft Oil Wick	541921	Needle Bar Frame
540435	Feed Regulating Stud Lock Pin	541922	Needle Bar Frame Pin
540472	Thread Guard (upper)	541923	Rotating Hook Drive Shaft Bushing (front)
540682	Tension Spring	541924	Rotating Hook Shaft Bushing (long)
541170	Bobbin Winder Tension Nut	541927	Needle Bar Connecting Link Guide
541605	Arm Shaft (horizontal)	541933	Needle Bar Frame 541921 with 541770, 549290 and two 549336
541606	Arm Shaft (horizontal) Bevel Gear with two 504066	541946	Bight Amplitude Regulating Plate Holder
541607	Arm Shaft (horizontal) Worm Gear with two 504028	541948	Arm Top Cover Cushion (2)
541619-452	Bed Slide	541949	Arm Top Cover Screw (back) O-Ring
541620-452	Bed Slide Complete, Nos. 154884, 541619-452 and two 154789	541951	Bight and L-C-R Position Lever Thumb Stud
541623	Bight and L-C-R Position Lever Complete, Nos. 545413 and 549285	541957	Tension Complete, Nos. 32752, 540682, 541702, 545893, 545899-451, 546927 and two 2102
541630	Bight Amplitude Regulating Plate Spring	541967	Bight Amplitude Slide Block Crank with two 549181
541631	Bight Amplitude Slide Block	541972	Bight Amplitude Regulating Plate (left)
541634	Bight Amplitude Slide Block Crank Link	541973	Bight Amplitude Regulating Plate (right)
541635	Bight Amplitude Slide Block Crank Shaft	541974	Bight Amplitude Regulating Plate Holder and Bight Amplitude Regulating Plate Complete, Nos. 541630, 541946, 541972 and 541973
541636	Bight Amplitude Slide Block Crank Shaft Bushing	541977	Rotating Hook Bobbin Case Holder
541637	Bight Amplitude Slide Block Crank Shaft Bushing Collar with two 504007	541978	Rotating Hook Section
541639	Bight Amplitude Slide Block Crank Spring	541985	Presser Bar
541642	Bight Amplitude Slide Block Guide Stud	542020	Oil Reservoir Set Screw Washer (2)
541645	Feed and Feed Lifting Eccentric with 504069 and 504070	543411	Pre-Tension Complete, Nos. 45915, 174418, 543413, 543415 and 545366
541646	Feed Bar	543413	Pre-Tension Bracket
541651	Feed Regulator with 545045	543415	Pre-Tension Cap
541652	Feed Regulator Hinge Stud	543802-004	Bobbin Winder Spindle Guard Retaining Ring
541664	Needle Bar Connecting Stud Hinge Pin	543805-003	Oil Reservoir Set Screw Spring Lock Washer (2)
541665	Needle Bar Connecting Stud Hinge Pin Washer	543904	Arm Shaft (upright) Bevel Gear (upper)
541685	Rotating Hook Drive Shaft Bevel Gear (front) with two 504101	543906	Arm Shaft (upright) Bevel Gear (upper) Joint with two 504102
541688	Rotating Hook Shaft	543907	Arm Shaft (upright) Bushing (upper)
541689	Rotating Hook Shaft Bevel Gear with two 504101	543908	Arm Shaft (upright) Connecting Stud
541690	Rotating Hook Shaft Bevel Gear Cover	543910	Arm Shaft (upright) Retainer Collar with two 504102
541692	Rotating Hook Shaft Bushing (short)	543910	Rotating Hook Drive Shaft Retainer Collar with two 504102 (2)
541693	Rotating Hook Shaft Retainer Collar with two 504007 (2)	543912	Arm Shaft (upright) Retainer Joint with two 504102
541694	Rotating Hook Thread Guard	543914	Arm Shaft (upright) Screw Gear (lower) with two 504102
541696	Set of Gears (lower, front) Nos. 541685 and 541689	543928	Hook Advancing Crank Connecting Rod
541698	Slack Thread Regulator	543929	Hook Advancing Crank Link
541701	Tension Releasing Lever Spring	543930	Hook Advancing Crank Shaft
541702	Tension Releasing Pin	543933	Needle Bar (hollow) with 504112
541707	Thread Take-up Crank	543934	Needle Bar (hollow) 543933 with 541933
541708	Thread Take-up Lever with 52130	543935	Needle Bar Connecting Link 410014 with 543937
541709	Thread Take-up Lever Complete, Nos. 52024 and 541708	543937	Needle Bar Connecting Stud with 504091, 545001, 541664 and 541665
541712	Zig-Zag Stitch Regulator Fork Eccentric Connection Pin	543938	Needle Bar Thread Guard
541749	Bight Amplitude Slide Block Crank Shaft Bushing Washer	543939	Presser Foot (spring hinged) Complete
541750	Bight Amplitude Slide Block Crank Shaft Ring	543941	Rotating Hook Bobbin Case Holder Position Bracket
541751	Feed Forked Connection 505322 with 56024, 541651, two 154759 and two 154981	543942	Rotating Hook Drive Shaft
541753	Arm Shaft (horizontal) and Needle Bar Crank Complete, Nos. 505339 and 541605	543944	Rotating Hook Drive Shaft Screw Gear (back) with two 504101
541754	Bight Amplitude Slide Block Crank Shaft Knob 541774 with 541636, 541750 and 549112	543947	Arm Shaft (upright) Retainer Joint Complete, Nos. 543912 and 543904
541759	Needle Bar Frame Clamping Stud	543948	Hook Advancing Crank Shaft Snap Ring
541764	Rotating Hook Bobbin Case Tension Spring	543952	Rotating Hook Drive Shaft Bushing (back)
541770	Needle Bar Timing Indicator Plate	543953	Thread Take-up Complete, Nos. 504057, 505372, 541707, 541709 and 543935
541771-452	Bed Plate	543955	Arm Shaft (upright) with 543956
		543956	Arm Shaft (upright) Oil Wick
		543962	Hook Advancing Crank
		543964	Hook Advancing Crank Bracket with 504048
		543965	Hook Advancing Crank and Hook Advancing Crank Bracket Complete, Nos. 543960, 543964, 541702 and 543964
		543971	Feed Lifting Rock Shaft with 504751 and two 54778

NUMERICAL LIST OF PARTS FOR 20U-2 M/C

<u>PART NO.</u>	<u>DESCRIPTION</u>	<u>PART NO.</u>	<u>DESCRIPTION</u>
543972	Feed Lifting Rock Shaft Complete, Nos. 505326 and 543971	548061	Bight Amplitude Stop Plate (left) (right) Washer (2)
543977	Throat Plate (for zig-zag stitching)	549119	Bight Amplitude Slide Block Crank Shaft Knob Set Screw
543978	Feed Dog	549152	Arm Shaft (horizontal) Flanged Bushing (back) Set Screw
544054	Arm Screw	549181	Bight Amplitude Slide Block Crank Set Screw (2)
544151	Hook Advancing Crank Bracket Screw	549285	Bight and L-C-R Position Lever Screw Pin
544152	Hook Advancing Crank Link Hinge Screw (back)	549288	Bight Amplitude Slide Block Crank Link Hinge Screw (2)
544153	Hook Advancing Crank Link Hinge Screw (front)	549290	Zig-Zag Stitch Regulator Fork Eccentric Connecting Pin Set Screw
544154	Hook Advancing Crank Connecting Rod Hinge Screw	549336	Needle Bar Timing Indicator Plate Screw (2)
544203-002	Bobbin Winder Tension Set Screw	549354	Needle Bar Frame Clamping Stud Screw
544204-001	Zig-Zag Triangular Cam Shaft Collar Set Screw (2)	549356	Bight Amplitude Regulating Plate Holder Set Screw (2)
544211-053	Bobbin Winder Latch Screw	549366	Pre-Tension Cap Screw
544212-052	Arm Side Cover Set Screw (4)	549376	Feed Dog Screw (2)
544213-002	Bobbin Winder Regulator Set Screw	549285	Bight Amplitude Regulating Plate Thumb Screw (2)
544217-052	Thread Take-up Lever Guard Set Screw	549387	Bight and L-C-R Position Lever Arm Regulating Screw (2)
544233	Bobbin Winder Bracket Hinge Screw	549389	Lifting Lever Hinge Screw
544255	Feed Regulating Stud	549397	Rotating Hook Set Screw (2)
545001	Needle Bar Connecting Stud Hinge Pin Screw	549426	Bight and L-C-R Position Block Washer (2)
545045	Feed Regulator Hinge Stud Set Screw	N1955-014	Needle (size #14) with Pontoon C.A.E.
545047	Feed Reverse Lever Hinge Stud Cap Screw		
545059	Arm Top Cover Screw (back)		
545092	Face Plate Screw (2)		
545092	Oil Reservoir Set Screw (2)		
545092	Bight and L-C-R Position Block Set Screw (2)		
545098	Bight Amplitude Slide Block Guide Stud Set Screw		
545218	Arm Top Cover Screw (front)	55623	Rotating Hook Bobbin (5)
545260	Tension Releasing Lever Hinge Screw	504030	Cloth Guide Thumb Screw
545404-451	Tension Regulating Thumb Nut (2)	505643	Presser Foot (spring hinged) Complete (for straight stitching)
545413	Bight and L-C-R Position Lever Screw Pin Nut	541514	Screw Driver (small)
545495	Bight and L-C-R Position Lever Arm Regulating Screw Nut (2)	541515-001	Cloth Guide (purchased part)
545766	Arm Shaft (upright) Bushing (lower)	541516-001	Hemmer Foot (1/8 hem) (purchased part)
545820	Feed Regulating Stud Lock Pin Spring	541558	Screw Driver (large)
545825	Arm Top Cover Screw (front) O-Ring	541561	Screw Driver (for throat plate)
545893	Tension Releasing Disc	541734	Feed Dog (for straight stitching)
545898	Tension Stud	541736-001	Zipper Foot (purchased part)
545899-451	Tension Stud 545898 with two 545404-451	541937-452	Throat Plate (for straight stitching)
546701	Face Plate Washer (rubber)	543979	Throat Plate (for embroidery)
546766	Feed Lifting Rock Shaft Oil Wick (2)	546923	Oiler (130 cc, filled with type "B" oil)
546766	Feed Rock Shaft Oil Wick (2)	N1955-014	Needle (size #14) with Pontoon C.A.E.(3)
546822	Presser Bar Guide Bracket with 154780		
546824	Presser Bar Lifter Pin		
546826	Handwheel		
546828	Presser Bar Lifting and Releasing Lever Bracket	541165-003	Thread Unwinder Thread Guide Holder Bracket Hinge Screw Nut
546831	Lifting Lever Connecting Rod Pin (2)	541165-003	Thread Unwinder Spool Pin Nut (2)
546831	Bight Amplitude Slide Block Crank Knee Operating Connection Pin	542113	Thread Unwinder Thread Guide Holder Bracket Hinge Screw Friction Washer
546846	Bobbin Winder Bracket Regulating Plate	542491	Thread Unwinder Spool Pin Spring Washer (2)
546847	Bobbin Winder Bracket Spring	543131	Thread Unwinder Spool Net (2)
546848	Bobbin Winder Latch with 544211-053	543803-003	Thread Unwinder Thread Guide Holder Bracket Hinge Screw Washer
546865	Bobbin Winder Regulator with 544213-002	544212-052	Thread Unwinder Thread Guide Holder Bracket Hinge Screw
546881	Feed Regulating Stud Head	544212-052	Thread Unwinder Spool Mounting Bracket Screw (2)
546882	Feed Regulating Stud Head Plate	545465	Thread Unwinder Thread Guide Lock Nut
546883	Feed Regulating Stud Head Plate Retainer	546734	Thread Unwinder Thread Guide Position Cup
546895	Bobbin Winder Bracket Regulating Plate Spring Stud	546735	Thread Unwinder Thread Guide Rod Washer
546919	Arm Shaft (horizontal) Flanged Bushing (front)	546740	Thread Unwinder Thread Guide Lock Nut Spring Washer
546927	Thread Take-up Spring Regulator with 504047	546888	Thread Unwinder Spool Pin (2)
546932	Arm Shaft (horizontal) Flanged Bushing (back)	546891	Thread Unwinder Thread Guide (2)
546947	Arm Shaft (horizontal) Flanged Bushing (back) Oil Pad (felt)	546893	Thread Unwinder Spool Holder (2)
546950	Feed Rock Shaft with two 546766	546894	Thread Unwinder Spool Cap (2)
547242	Bobbin Winder Tension Complete, Nos. 541172, 547243, 547246 and two 547247	547227-451	Thread Unwinder (for two spools) Complete, Nos. 541165-003, 542113, 543803-003, 544212-052, 545465, 546734, 546735, 546740, 547228-451, 547229, two each 541165-003, 542491, 546888, 546891 and 546892
547243	Bobbin Winder Tension Stud Complete		
547246	Bobbin Winder Tension Spring	547228-451	Thread Unwinder Spool Mounting Bracket
547247	Bobbin Winder Tension Disc	547229	Thread Unwinder Thread Guide Holder and Bracket Complete
547248	Feed Rock Shaft and Feed Rock Shaft Crank Complete, Nos. 505335 and 546950		
547671	Bight and L-C-R Position Lever Thumb Stud Nut Spring Washer		

ACCESSORIES AND ATTACHMENTS

(Supplied with Machine)

THREAD UNWINDER (FOR TWO SPOOLS)

(Supplied with Machine)