

**SINGER**  
**20UX143**

**SINGER**

**SEWING MACHINE  
MODEL**

**20UX143**

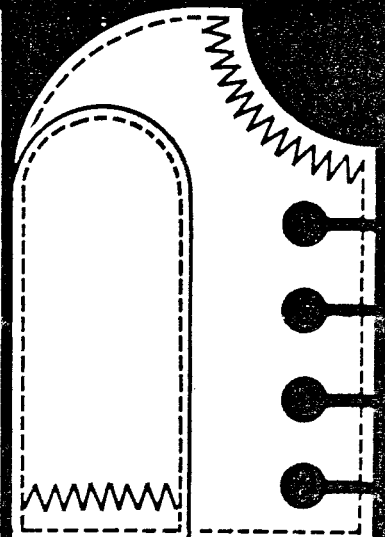
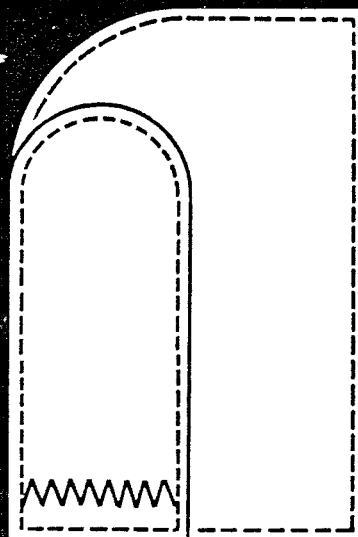
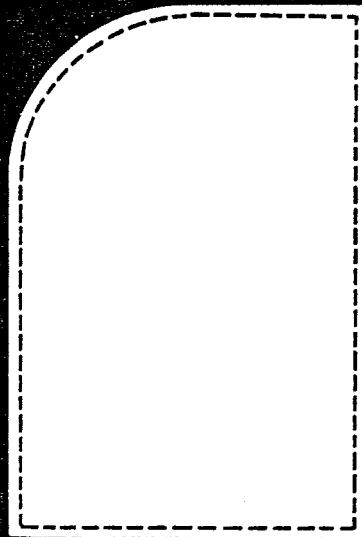
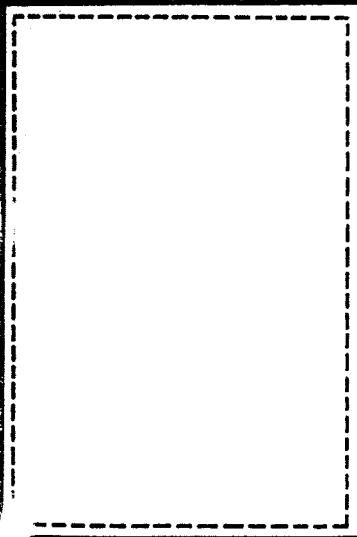
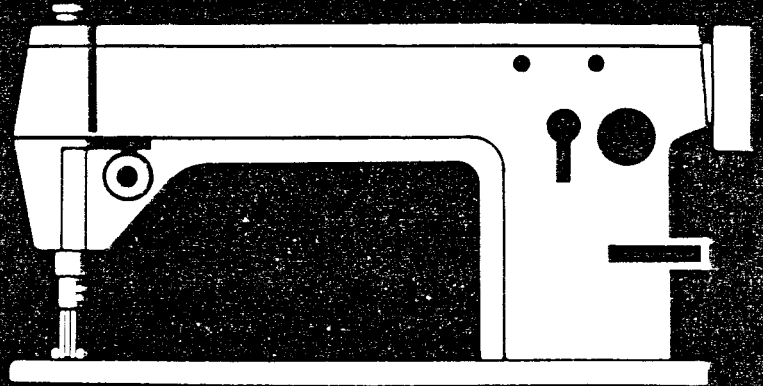

## PRINCIPAL PARTS OF MODEL 20U143 MACHINE

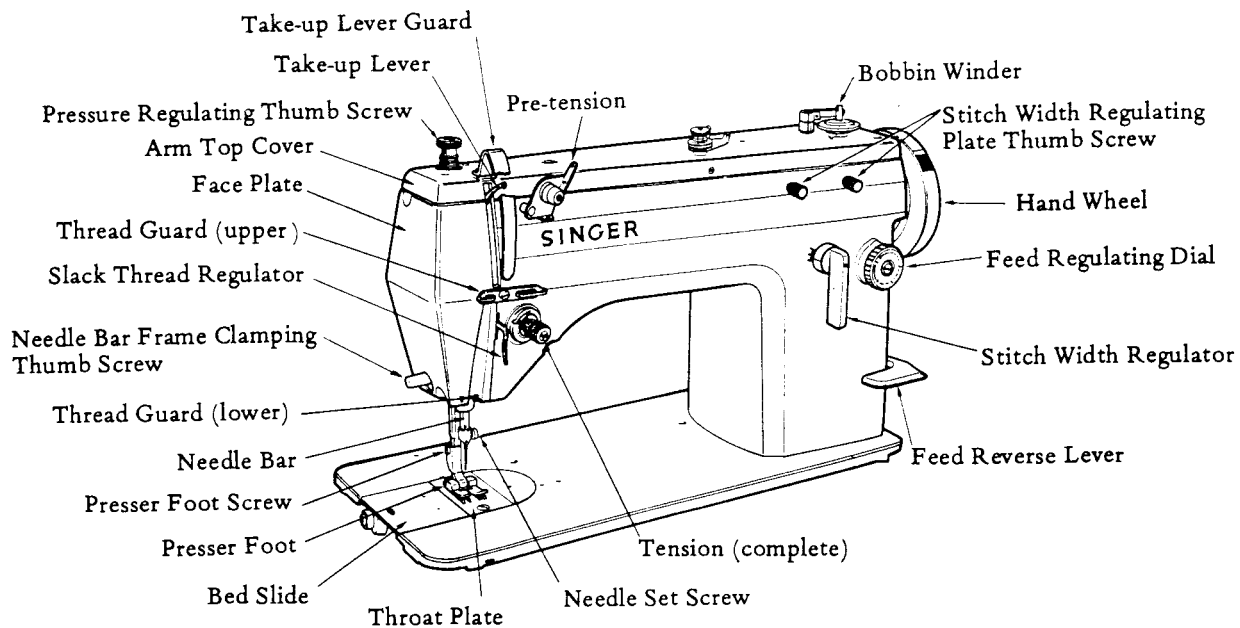

## CONTENTS

	Page		Page
Principal Parts of Model 20UX143 . . . . .	1	Satin Stitching . . . . .	17
Fabric, Thread, Needle and Stitch Length Table . . . . .	2	Zigzag Stitching . . . . .	18
Needles and Thread . . . . .	3	Lingerie Seams . . . . .	18
To See the Needle . . . . .	3	Seams in Knit Fabrics . . . . .	18
Threading the Needle . . . . .	4	Buttonholes . . . . .	19
To Remove the Bobbin . . . . .	4	Monograms and Motifs . . . . .	21
To Wind the Bobbin . . . . .	5	Script Lettering . . . . .	21
Threading the Bobbin Case . . . . .	7	Applique . . . . .	23
To Replace the Bobbin Case . . . . .	8	Hemmer Foot . . . . .	24
Raising the Bobbin Thread . . . . .	8	Plain Narrow Hems . . . . .	24
To Adjust Stitch Length . . . . .	9	Zipper Foot . . . . .	25
To Adjust Pressure . . . . .	9	Zipper Insertion . . . . .	25
To Adjust Thread Tensions . . . . .	10	Coarded Seams . . . . .	26
Stitch Width Regulator . . . . .	11	Other Practical Applications . . . . .	27
How to Control the Width of Zigzag Stitch . . . . .	12	Caring for Your Machine . . . . .	29
Needle Bar Frame Clamping Device . . . . .	14	Knee Operating Stitch Width Control . . . . .	31
Straight Stitching . . . . .	14	How to Set Knee Lifter When Used Only for Lifting Presser Foot . . . . .	32
Changing the Throat Plate and Feed Dog . . . . .	15	To Remove and Replace Throat Plate . . . . .	33
How to Sew a Seam . . . . .	16		

Copyright © 1980 THE SINGER COMPANY  
All Rights Reserved Throughout the World

## NEEDLES AND THREAD

This machine uses needle Catalog 1955 (Pontoon C.A.E.), available in sizes 9, 11, 14, 16 and 18.

The needle you use should be straight, with a sharp point, to ensure perfect stitch formation and needle penetration through the fabric. The needle should also be fine enough to prevent the fabric from being marred with large punctures, yet heavy enough to pierce the fabric without being bent or deflected. Remember, too, that the eye of the needle must be large enough for the thread to pass through it freely; too fine a needle will cause the thread to fray.

Be sure to use like threads for both needle and bobbin.

### TO SET THE NEEDLE

1. Raise needle bar to its highest position by turning hand wheel toward you.
2. Loosen the needle set screw and insert needle into needle bar as far as it will go, with the **long groove toward you**. Then tighten the needle set screw.

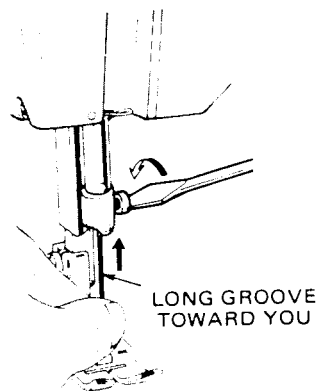

### FABRIC, THREAD, NEEDLE AND STITCH LENGTH TABLE

Fabrics	Thread sizes	Needle sizes	Stitches per inch	Stitch length setting
<b>DELICATE</b> — tulle, chiffon, fine lace, silk, organdy, fine tricot	Fine Mercerized 80 to 120 Cotton Synthetic Thread	9	15 to 20	1-1/2 ~ 1-1/4
<b>LIGHTWEIGHT</b> — batiste, organdy, jersey, voile, taffeta, silk, crepe, plastic film	50 Mercerized 60 to 80 Cotton A Silk Synthetic Thread	9 or 11	12 to 15 (8 to 10 for plastic)	1-3/4 ~ 1-1/2 (3-1/4 ~ 1-1/2)
<b>MEDIUM WEIGHT</b> — gingham, percale, pique, linen, chintz, faille, satin, fine corduroy, suitings	50 Mercerized 50 to 60 Cotton A Silk Synthetic Thread	11 or 14	12 to 15	1-3/4 ~ 1-1/2
<b>MEDIUM HEAVY</b> — gabardine, tweed, sailcloth, denim, coatings, drapery fabrics	Heavy Duty Mercerized 40 to 50 Cotton	16	10 to 12	2-1/2 ~ 1-3/4
<b>HEAVY</b> — overcoatings, dungaree, upholstery fabrics, canvas	Heavy Duty Mercerized 30 to 40 Cotton	18	6 to 10	4-1/2 ~ 2-1/2

## TO WIND THE BOBBIN

1. Stop motion of needle by loosening stop-motion screw **A**. Hold hand wheel with left hand and turn stop-motion screw toward you with right hand.
2. Place bobbin on bobbin winder spindle **B**, pushing it on as far as it will go.
3. Place thread spool on spool pin and pass the thread through thread guide **C<sub>1</sub>**, between tension discs **D** and through thread guide **C<sub>2</sub>** and to the bobbin. Wind end of thread around the bobbin a few times and press latch **E** against bobbin, then start the machine.
4. Allow the tension discs to control flow of thread. Do not guide or hold thread when winding the bobbin.
5. Winding will stop automatically when bobbin is fully wound.
6. Remove bobbin from spindle and tighten stop-motion screw **A** by turning it away from you with right hand while holding the hand wheel with your left hand.

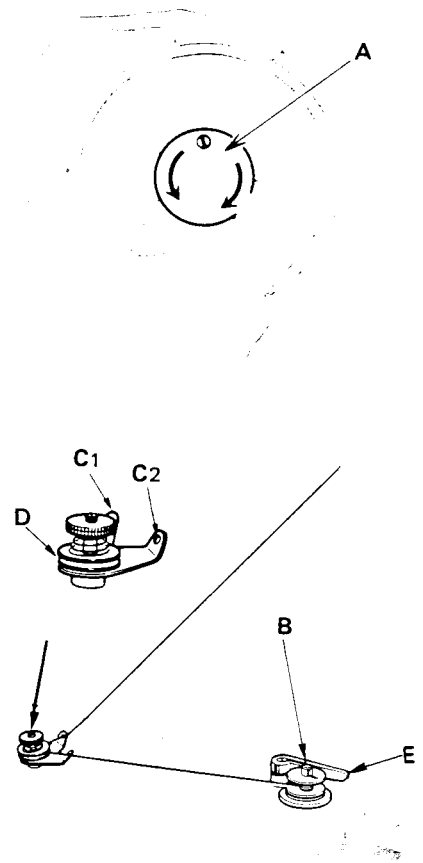

### THREADING THE NEEDLE

1. Turn hand wheel toward you to raise take-up lever to its highest position.
2. Raise the presser foot.
3. Lead thread from the thread unwinder through all the threading points shown. Thread the needle from front to back.
4. Draw about 3 inches of thread through eye of needle.

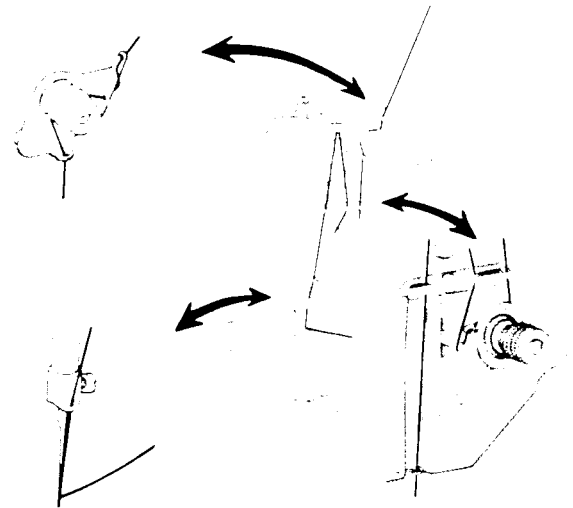

### TO REMOVE THE BOBBIN

1. Turn hand wheel toward you until needle is at its highest position.
2. Open bed slide.
3. Reach up from under the table with left hand, open bobbin case latch **A**, and lift out bobbin case **B**.
4. Release latch and remove bobbin from bobbin case.

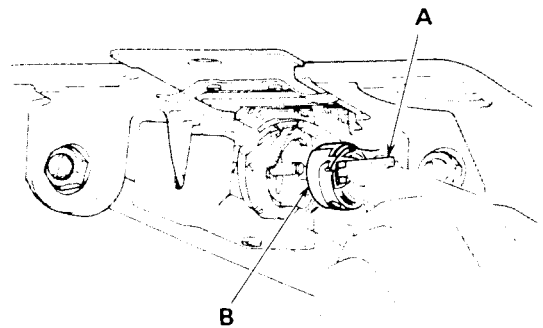



## THREADING THE BOBBIN CASE

1. Hold bobbin so that thread unwinds in the direction shown, and put bobbin in bobbin case.
2. Pull thread into notch **A** and draw it under tension spring **B**.
3. Draw thread out from slot on end of spring and pass it through bobbin case thread guard **C**. Allow about 4 inches of thread to hang freely from bobbin.

NOTE: When straight stitching, a better result can be obtained if bobbin-thread is not threaded through bobbin case thread guard **C**.

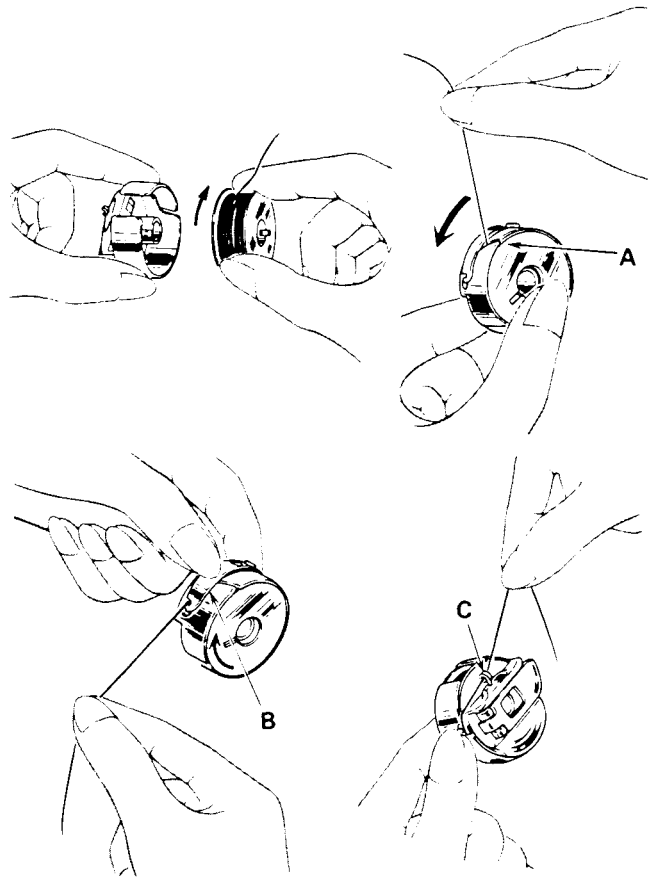

## TO WIND THE BOBBIN (cont'd)

Bobbins can be wound while the machine is stitching. To wind bobbins while the machine is stitching, follow the preceding instructions only do not loosen the stop-motion screw.

To adjust the amount of thread on the bobbin, loosen screw **F** on latch **E** and while holding stud **G** with a screwdriver, swing latch **E** away from you or toward you, as required.

- For more thread on bobbin, swing latch **E** away from you.
- For less thread on bobbin, swing latch **E** toward you.
- Tighten screw **F**

If thread winds unevenly on bobbin, loosen screw **H** and move tension bracket **I** up or down, as required, then tighten screw **H**.

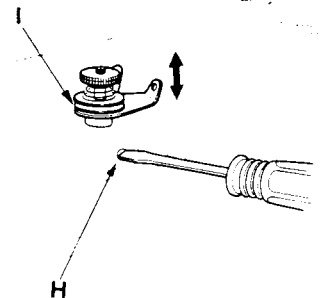
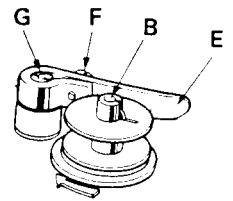

## TO ADJUST STITCH LENGTH

When you want to change the stitch length, press down and hold feed reverse lever **A** in center position and —

- Turn feed regulating dial **B** clockwise to shorten the stitch.
- Turn feed regulating dial counterclockwise to lengthen the stitch.

The machine will produce a maximum stitch length of 5 mm.

To change direction of feed for back tacking press feed reverse lever down and hold lever in lowest position until back tack is completed.

NOTE: Numerals on feed regulating dial are reference points and do not denote actual number of stitches per inch.

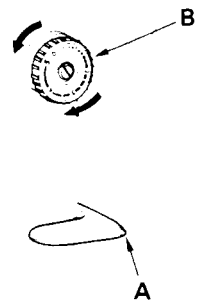

## TO ADJUST PRESSURE

The pressure screw regulates the pressure that the presser foot exerts on the fabric.

The pressure on the fabric should be as light as possible while still sufficient to ensure proper feeding. Generally, heavy fabric requires heavy pressure and lightweight fabric, light pressure.

- To increase pressure, turn screw downward.
- To decrease pressure, turn screw upward.



### TO REPLACE THE BOBBIN CASE

Hold bobbin case by latch **A** and place it on spindle of bobbin case holder **B** so that position finger **C** enters notch **D** at right of bobbin case holder. Release latch and press bobbin case firmly in place to assure proper position. Close bed cover.

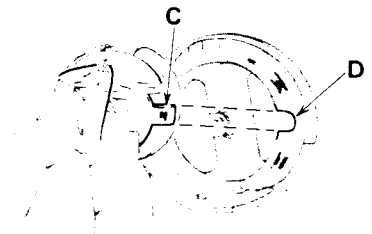

### RAISING THE BOBBIN THREAD

Hold needle thread lightly with left hand. Turn hand wheel so that needle enters throat plate and brings up bobbin thread. Pull end of bobbin thread up through throat plate and place both needle and bobbin threads diagonally under the presser foot.

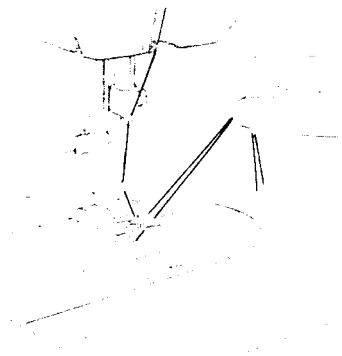
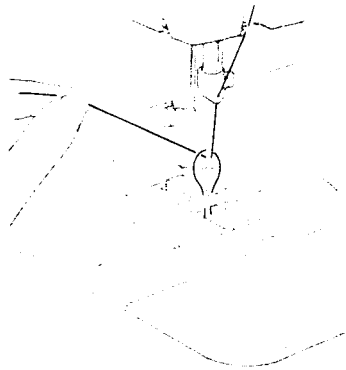
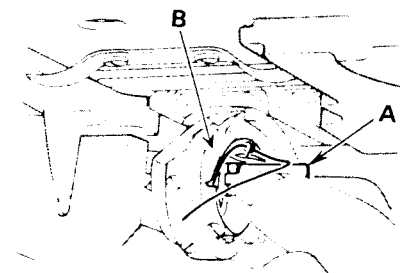

## STITCH WIDTH REGULATOR

The width of zigzag stitch is controlled with the spring biased stitch width regulating lever **A**. This lever regulates swing of needle from its straight stitching position to maximum zigzag width of 12mm.

**Do not make any stitch width adjustment while the needle is in the fabric.**

**NOTE:** The stitch width regulating lever **A** may be turned upward, if desired, simply by loosening screw **B** and turning lever **A** upward.

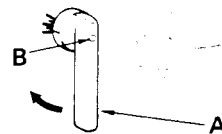

## TO ADJUST THREAD TENSIONS

### NEEDLE THREAD

First, regulate the needle thread tension only when the presser foot is down.

Tension on the needle thread should be just enough to set the stitch properly in the fabric.

Having lowered the presser foot, hold thumb nut **E** and loosen lock nut **D**. Then turn thumb nut **E** as instructed in the sketch at right.

When tension has been correctly set for average sewing, tighten lock nut **D**.

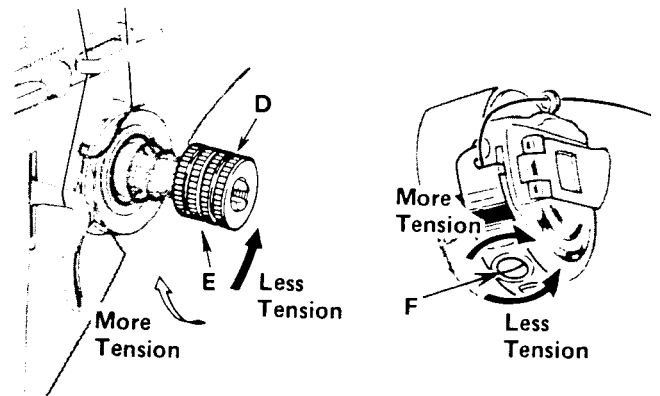

### BOBBIN THREAD

For average sewing, the tension on the bobbin thread should be very light.

To regulate the tension on the bobbin thread, remove the bobbin case and:

- Turn screw **F** clockwise to increase the tension.
- Turn screw **F** counterclockwise to decrease the tension.

A perfect stitch will have the needle and bobbin threads locked between the two layers of fabric with no loops on top or bottom and no puckers, as shown in Fig. **A** at right.

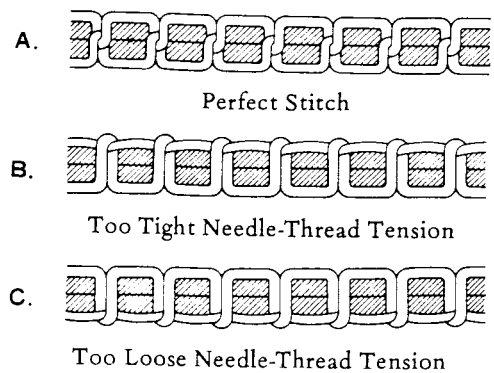

3. To sew zigzag stitches in fixed width, loosen thumb screws **A** and **B**, turn stitch width regulator **C** to desired stitch width and while holding regulator **C** in this position, tighten thumb screw **B**. Then tighten thumb screw **A**. This will lock the stitch width regulator in desired position and leave both hands free to handle the fabric.

4. For sewing two different width ornamental zigzag stitches, set the machine as instructed below.

First, loosen thumb screws **A** and **B**. Turn stitch width regulator **C** to desired width for the narrow zigzag stitch and while holding the regulator **C**, tighten thumb screw **B**. Then turn stitch width regulator **C** to desired width for the wider zigzag stitch and tighten thumb screw **A**.

Having set the machine as instructed above, the narrow width zigzag can now be sewn without regulating the stitch width regulator **C**. To sew the wider zigzag, the stitch width regulator must be turned as far it will go and held in this position until the wider zigzag stitching is completed.

This method of setting the stitch width is very convenient when sewing the side stitches and bar tacks of a buttonhole.

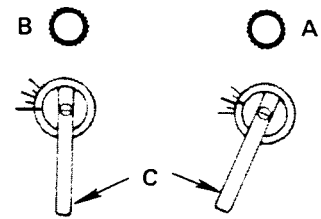

Setting For Zero To 5mm Wide Zigzag Stitch

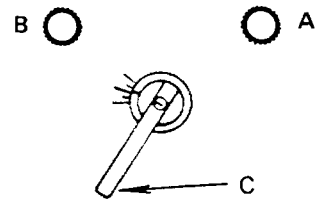

Setting for Desired Fixed Width Zigzag Stitch

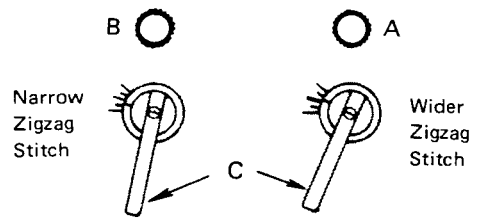

Setting For Dual Width Ornamental Zigzag Stitch

## HOW TO CONTROL THE WIDTH OF ZIGZAG STITCH

The two thumb screws **A** and **B** provided on front of arm allow you to control the width of zigzag stitches. Thumb screw **A** is used to control the width of the wider zigzag stitch and thumb screw **B** to control the narrower zigzag stitch.

1. To obtain minimum to maximum width (12mm) zigzag stitches, first loosen thumb screw **B** to permit the stitch width regulator **C** to return to its zero position and retighten thumb screw **B**. Then loosen thumb screw **A**, turn stitch width regulator **C** clockwise as far as it will go and while holding the regulator **C** in this position, retighten thumb screw **A**. You can now regulate the stitch width regulator within the range of zero to 12 mm.
2. To make narrower zigzag stitches, for example, a zero to 5 mm wide zigzag stitches, loosen thumb screws **A** and **B** and retighten thumb screw **B** as explained above. Then turn stitch width regulator **C** to 5 mm setting and while holding regulator **C**, retighten thumb screw **A**.

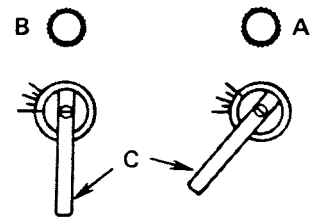
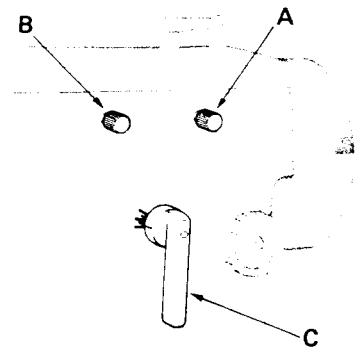

Setting For Zero To 12 mm  
Wide Zigzag Stitch



**CHANGING THE THROAT PLATE AND FEED DOG**

- 1. Open bed slide; then remove throat plate. (Use screwdriver **A** furnished with machine for removal and replacement of throat plate and feed dog.)
- 2. Using a screwdriver, remove bed plate **B** as shown in sketch at right and remove feed dog **C**.
- 3. To replace general purpose or straight stitch feed dog, fasten feed dog to machine temporarily and replace general purpose or straight stitch throat plate. Set feed dog correctly in position so that it will not hit the edges of the feed dog slot in the throat plate.
- 4. Replace bed plate and press it firmly in place.

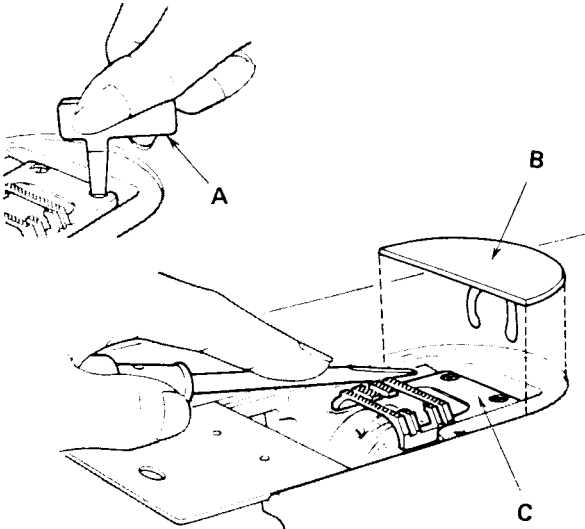

## NEEDLE BAR FRAME CLAMPING DEVICE

When straight stitching, a better sewing result can be obtained by locking the needle bar frame immovable with the clamping device.

To clamp the needle bar frame, turn knob clockwise as far as it will go (about 1/4 turn).

When zigzag stitching, be sure the clamp is released.

To release the clamp, turn knob counterclockwise as far as it will go until the white mark on the knob is located at the top.

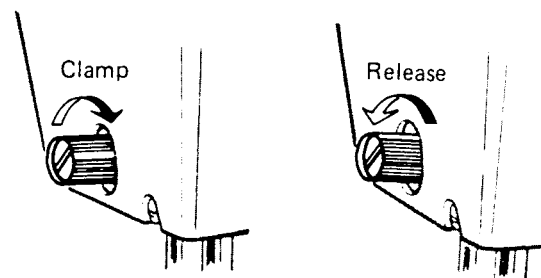

## STRAIGHT STITCHING

General Purpose Presser Foot, Throat Plate and Feed Dog are used for all utility sewing and where there is occasion to alternate between straight and zigzag stitching in the sewing procedure.

Straight Stitch Presser Foot, Throat Plate and Feed Dog are used for straight stitching only. These Fittings are suited especially for stitching delicate or spongy fabrics, synthetics, knits and tricot. Additional maneuverability is also obtained when sewing curved and shaped seams, precision edging and hard-to-reach areas.

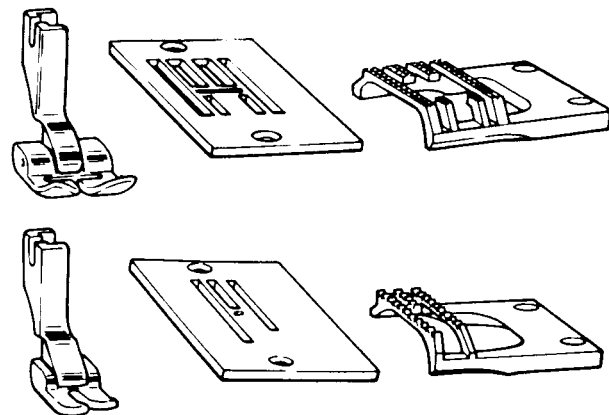

## SATIN STITCHING

Satin stitching, a series of closely spaced zigzag stitches that form a smooth, satin-like surface, is useful for both utility and decorative work.

When you wish to produce a satin stitch, make a test sample first so that you can adjust the stitch length and thread tension properly.

Soft fabric may require a backing to ensure firm satin stitching. Crisp organdy or lawn is suitable for this purpose.

### Adjusting Stitch Length for Satin Stitching

If you wish a closely packed satin stitch, turn feed regulating dial clockwise until stitches are closely spaced and form a smooth surface.

### Adjusting Tension for Satin Stitching

All zigzag stitching requires less tension than straight stitching; and satin stitching requires even less than open zigzag stitching. Furthermore, the wider the satin stitch, the lighter the tension on the thread must be.

Notice the stitching on your sample. If the stitching looks too taut, or if the fabric is puckering, lower the needle-thread tension by turning the tension dial counterclockwise. A properly balanced satin stitch should lie flat across the material.

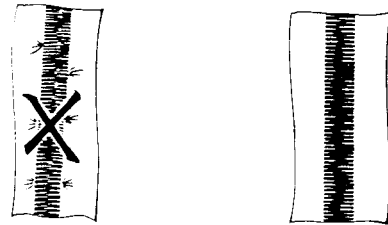
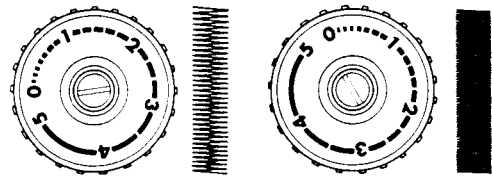

## HOW TO SEW A SEAM

1. Set feed regulating dial for desired stitch length.
2. Raise take-up lever to its highest point and place fabric under presser foot.
3. Position needle in fabric, lower presser foot and stitch to end of seam.
4. To reinforce seam ends, press stitch reverse lever down to its lowest position and backstitch.
5. With take-up lever at its highest point, raise presser

foot and remove fabric.

Most fabrics need to be guided in front of the presser foot only. Some fabrics, however, require support while being stitched.

— For filmy sheers, knits, tricots, etc., apply gentle tension by holding seam in front and back of presser foot.

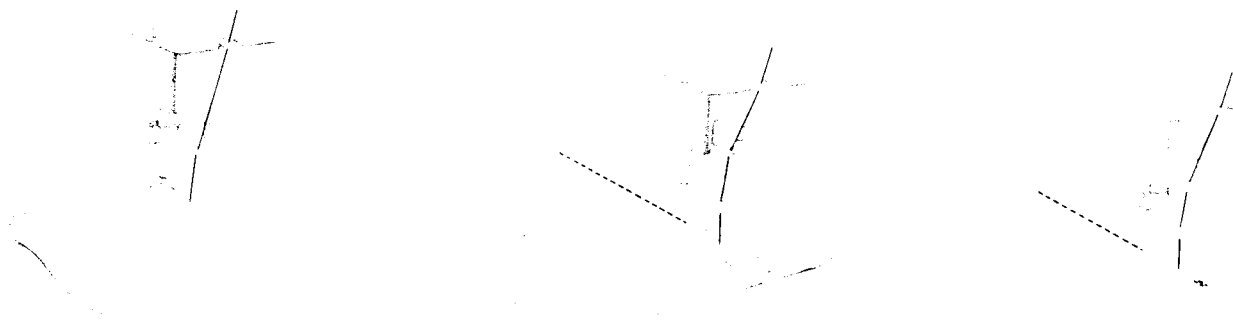

## BUTTONHOLES

Stitch Width Regulator: Desired Width (2 ~ 3 mm)

Stitch Length: Satin Stitch

Throat Plate: General Purpose

Presser Foot: General Purpose

When making buttonholes, always make a test buttonhole in a sample of your fabric. Be sure to duplicate the thickness of the garment and include interfacing if appropriate.

It is almost always advisable to use an interfacing in the buttonhole area. An interfacing holds the fabric firmly so that a neat buttonhole may be stitched and keeps the finished buttonhole in shape. Interfacing is essential when making buttonholes in synthetic or knit fabrics that stretches easily.

**Buttonhole Length:** First, decide how long the opening needs to be. This will depend on the diameter and the thickness of the button. Then mark the fabric as illustrated.

**Stitch Length:** Use a satin stitch as described on page 18.

**Buttonhole Stitch Width:** Loosen the right thumb screw, turn stitch width regulator to desired stitch width (2~3 mm) and while holding the regulator in this position, retighten the thumb screw. (The stitch width regulator can now be regulated only within the range of zero to the setting you have just made.)

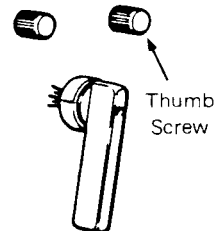
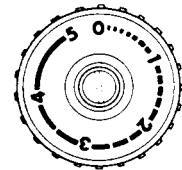
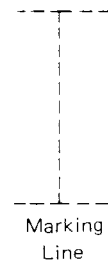

## ZIGZAG STITCHING

### LINGERIE SEAMS

Dainty lingerie seams can be made durable with plain zigzag stitching.

1. After straight-stitching seam on the wrong side, press both seam allowances in the same direction.
2. From the right side, top-stitch with a fine zigzag letting the needle alternately enter the seam line and the seam thickness.

### SEAMS IN KNIT FABRICS

A narrow, closely spaced, zigzag stitch is ideal for seaming knit fabrics. It is particularly desirable for underarm seams where elasticity and give are needed.

For neckline and waistline seams, where a stay is needed to prevent undue stretching, this same stitch can be used to apply seam tape. To insure a flat, smooth stayed finish, position tape with edge exactly on seam line. If seam is curved, pre-shape tape to fit by steam pressing, and baste in place. Stitch, allowing the needle to enter seam tape and seam allowance alternately.

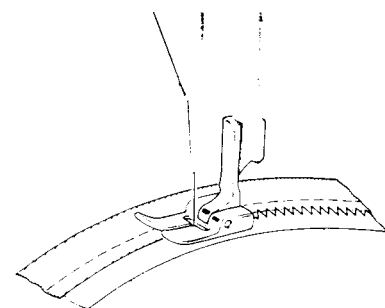
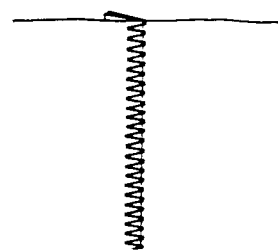

## MONOGRAMS AND MOTIFS

Stitch Width Regulator: 2mm ~ 5mm

Stitch Length: Satin Stitch

Throat Plate and Presser Foot: General Purpose

Select a design from many transfer patterns available or sketch one to suit your purpose. Always make a sample first to find the right stitch length, thread tension, and pressure.

1. Transfer the design (by tracing, usually) to the right side of fabric.
2. If the fabric is soft or loosely woven, baste a backing of lawn or organdy onto the wrong side.

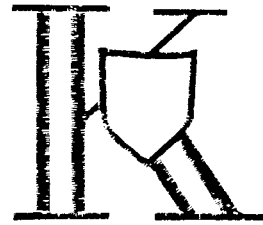

3. Stitch, following the outline of the design.
4. After stitching, trim the backing close to the stitching.

## SCRIPT LETTERING (FREE-MOTION WORK)

Stitch Width Regulator: Setting Desired

Stitch Length: "0"

Throat Plate: Embroidery

Presser Foot: None

In free-motion stitching, you sew without a presser foot and control fabric movement (and hence stitch length) your-

self, by means of an embroidery hoop. Either a straight or a zigzag stitch setting can be used.

If you are embroidering, you can vary the length of stitches simply by moving the hoop faster or slower. The faster you move it, the more open the stitches will be. A slow hoop movement will produce closely

**NOTE:** Having made the above adjustments, you can now sew the side stitches by turning the stitch width regulator as far as it will go either by hand or by knee.

**First Side Stitching:** Position needle in fabric at point **A**, lower presser foot and stitch to point **B**. Leave needle in fabric. Raise presser foot and pivot work on needle.

**Second Side Stitching:** With the needle in fabric at point **B**, lower presser foot and stitch to point **C**. Leave needle in fabric.

**Fastening Stitch:** With needle in fabric at point **C**, raise presser foot and pivot work on needle. Lower foot and sew four or five stitches to point **D** over the first side stitching. Then set machine for straight stitching and take approximately three stitches to point **E** to secure stitching. Remove work, draw threads to underside, fasten and trim. Cut opening for button with sharp scissors.

**Bar Tacks:** When all buttonholes have been completed, it is advisable to strengthen the buttonhole ends with bar tacks.

Set stitch width regulator so that the bar tacks will straddle and be in line with the outer edges of the left and right side stitchings. Take approximately six stitches to complete tack. Raise needle out of fabric, set machine for straight stitching and back tack approximately three stitches and complete the fastening stitch in the same way as side stitching. To stitch the final bar tack, duplicate bar tack previously made.

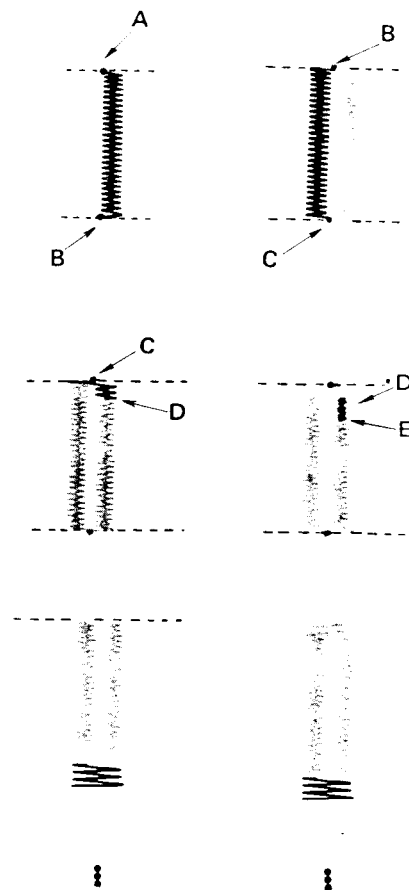



## APPLIQUE

Stitch Width Regulator: Zigzag Width Desired

Throat Plate: General Purpose

Presser Foot: General Purpose

Applique adds beauty and interest to clothes and household linens. The stitch most commonly used in appliqueing is zigzag stitch, closely spaced to form a satin stitch. The width of this stitch can be varied to accommodate fabrics of different weaves and textures.

### Procedure

1. Position the design and pin or baste it to the fabric.
2. Set stitch width regulator for straight stitching and outline the entire design with a short stitch.
3. Trim any excess fabric on the outer edges of the stitching. Remove basting.
4. Readjust stitch width regulator for desired stitch width and stitch, following the straight-stitch outline. This step will produce a smooth overedged finish, with no raw edges to be trimmed.

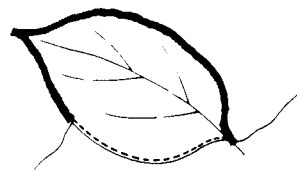
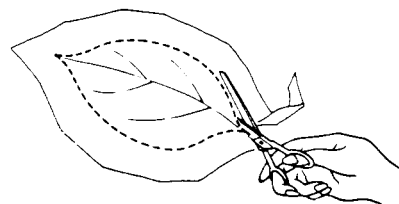

packed stitches. You can also vary the width of the stitches from a hairline to the full width of whatever stitch width setting you have chosen, simply by moving the hoop, or by regulating the stitch width regulator as you sew. If you move it sideways and stitch in a horizontal line, you will get a hairline; if you move it forward or backward and stitch in a vertical line, you will get full stitch width.

Thus you can produce a ribbon-like effect in script lettering. This takes practice but you can achieve some lovely effects that look much like hand embroidery.

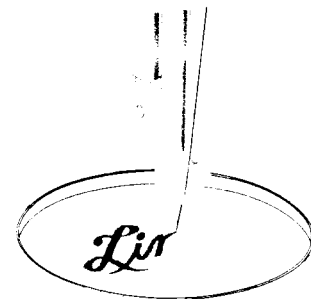

1. Always make a sample first to find the right stitch settings and spacing.
2. Trace or mark lettering on right side of fabric. If the fabric is soft or loosely woven, add an underlay of crisp lawn or organdy.
3. Place work in embroidery hoop large enough to encompass the entire design. Be sure fabric is held taut.
4. Position work under needle and lower presser bar to engage tension.
5. Hold needle thread loosely and turn hand wheel toward you to bring bobbin thread up through fabric at start of design. Hold both threads and lower the needle into the fabric.
6. Stitch, following the outline of the lettering. Maintain an even rate of speed so that the stitches are uniformly spaced.
7. After stitching, trim the backing close to the stitching.

## ZIPPER FOOT

This foot is designed to facilitate the placement of stitching close to a raised edge. It is attached to the machine in place of the regular presser foot and may be adjusted to either the right or left side of the needle.

### APPLICATIONS

Zipper Insertion	Tubular Cording
Corded Seams	Slip Cover Welting

### ZIPPER INSERTIONS

Stitch Width Regulator: Straight Stitching Position

Throat Plate: General Purpose or Straight Stitch

Presser Foot: Zipper Foot

Feed Dog: General Purpose or Straight Stitch

When the zipper is to the right of the needle:

1. Loosen the thumb screw **B** at the back of the foot, and slide the foot to the left of the needle.
2. Check the position of the foot by lowering the needle into the side notch **A** of the foot, making sure it clears the foot.
3. Lock the foot into position by tightening the thumb screw.

When the zipper is to the left of the needle, adjust the foot to the right of the needle in the same way.

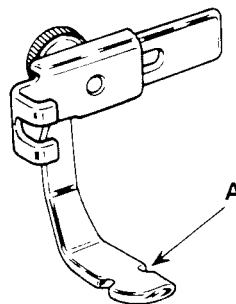

ZIPPER FOOT

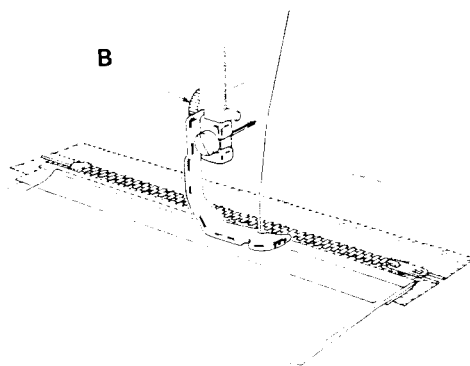

## HEMMER FOOT

You can turn and stitch a narrow hem in a single operation if you use the hemmer foot. Thus, you can eliminate basting or pinning whenever you are making ruffle edges, lingerie finishes, and the like.

### PLAIN NARROW HEMS

Stitch Width Regulator: Straight Stitching Position

Throat Plate: Straight Stitch

Presser Foot: Hemmer Foot

Feed Dog: Straight Stitch

Form a double 1/8 inch fold at edge of fabric; crease fold for about 2 inches. Draw bobbin and needle threads under hemmer foot. Place fabric under the foot and stitch through creased fold for several stitches. Hold thread ends in left hand and guide raw edge in front of hemmer evenly into scroll. Sew slowly, still holding thread ends until hem is well started. Feed material evenly into hemmer scroll.

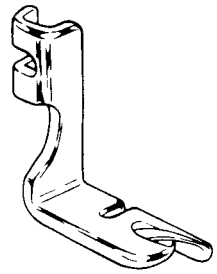

HEMMER FOOT

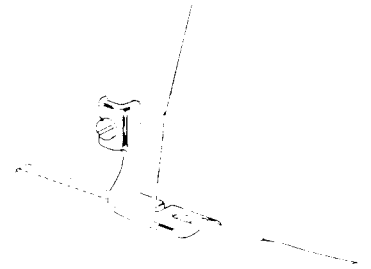

OTHER PRACTICAL APPLICATIONS

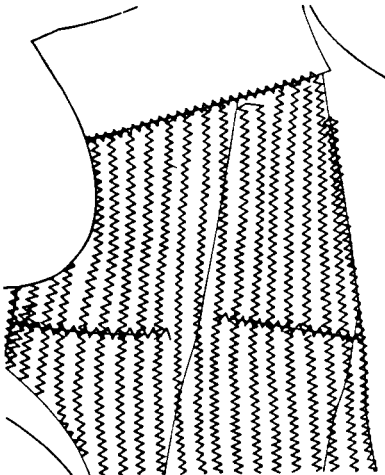

Preparing the Interfacing

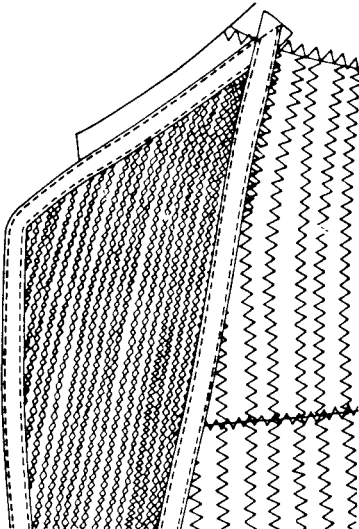

Felling Interfacing to Outer Garment

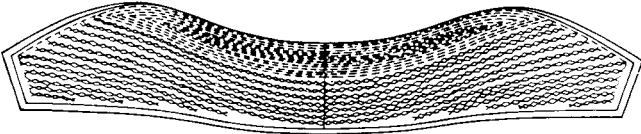

Under Collar

## CORDED SEAMS

Stitch Width Regulator: Straight Stitching Position

Throat Plate: General Purpose or Straight Stitch

Presser Foot: Zipper Foot

Feed Dog: General Purpose or Straight Stitch

The corded seam is a typical treatment for slip covers, children's clothes, blouses, and lingerie. To make a corded seam, make the welting first, then stitch it into the seam.

### To make the welting

1. Cut bias strips of fabric (width: three times the diameter of the cord plus 1-1/4 inches).
2. Sew strips together on the lengthwise grain to obtain desired length.
3. Fold resulting strip over cord, raw edges even.
4. Adjust zipper foot to the left side of the needle.
5. Lower zipper foot.
6. Stitch close to the cord (but do not crowd stitching against cord), pulling gently on the strip, both in front and in back of the zipper foot.

### To stitch welting into seam

1. Place the corded welting between two fabrics.
2. Stitch, this time crowding the foot against the cord.

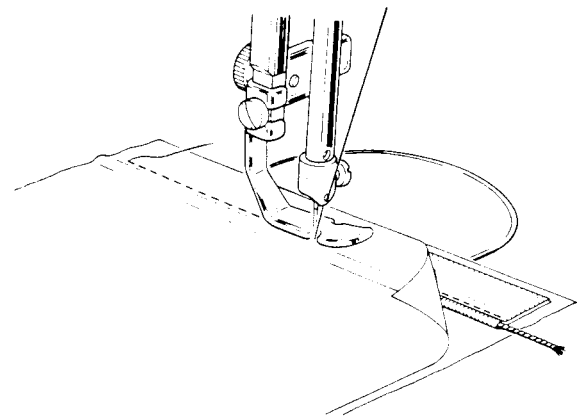
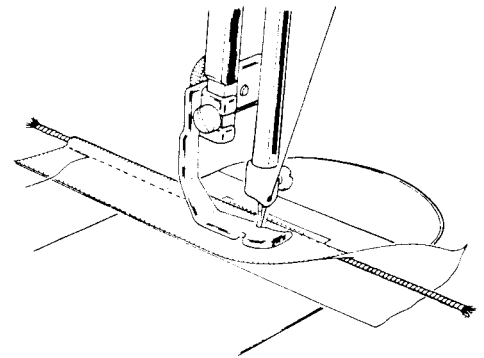

## CARING FOR YOUR MACHINE

Your SINGER machine will serve you perfectly for many years if you take a few moments of your time to keep it clean. How often you will need to clean and lubricate the machine will depend on how often you will use it. When in regular use, the machine should be cleaned periodically to remove lint and fluff which may have accumulated around the working parts. A machine in continuous use should be oiled frequently, especially when the machine is operated at maximum recommended speed.

With a soft cloth, clean:

- Pre-tension **A**
- Take-up lever **B** and thread guard **C**
- Tension discs **D**
- Needle bar **E** and presser bar **F**
- Machine arm and bed **G** (If necessary, dampen the cloth and use mild soap to clean machine surface).

With a lint brush, clean:

- Feed dog **H**
- Rotating hook and area under throat plate.

Turn hand wheel over toward you until oil hole in rotating hook appears in sight. Apply one or two drops of oil to the oil hole.

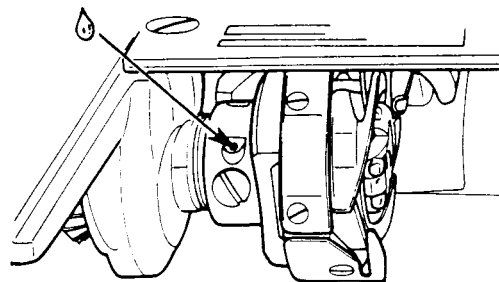
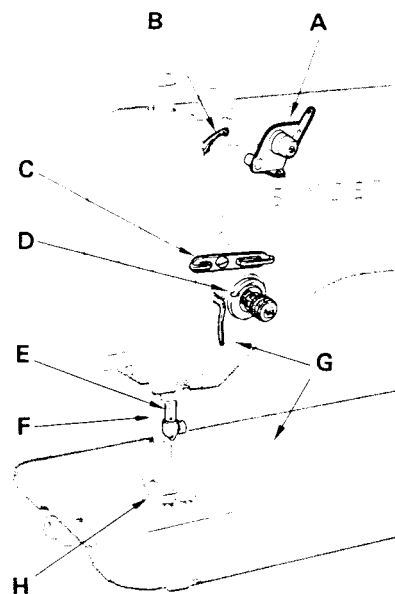

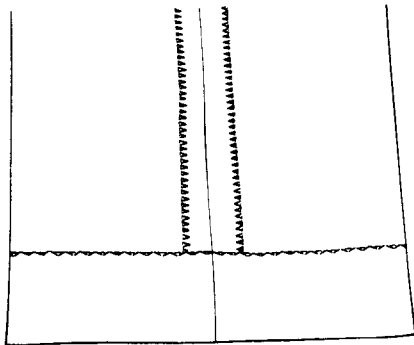

Overedging Trouser Seams • Overcasting Trouser Cuffs

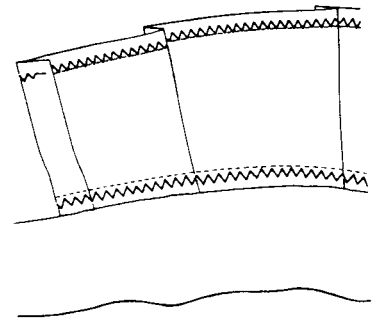

Inner Waistband of Trouser

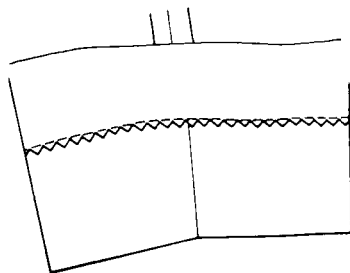

Inner Sleeve Cuffing

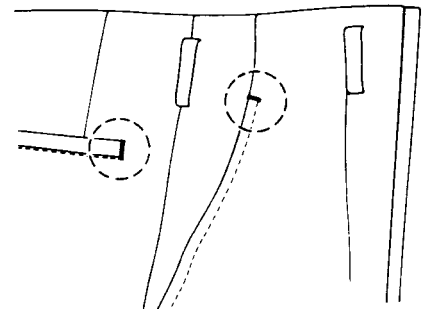

Pocket Bar Tack



## KNEE OPERATING STITCH WIDTH CONTROL

A knee operated bell crank complete (A and B) shown in the sketch at right is fastened to the underside of the bed. Bell crank A is used for lifting the presser foot, and bell crank B is used for regulating the stitch width with your knee.

To control the width of zigzag stitches with your knee and leave both hands free to handle the fabric, loosen screw D and move lifting arm C so that it is positioned just under the bell crank B; then tighten screw D.

The stitch width can now be controlled from zero to maximum width of 12 mm with your knee by pushing the knee plate E to the right. The further you push the knee plate to the right, the wider the stitch width you will obtain.

NOTE: The presser foot cannot be raised with the knee lifter when machine is set up for knee operating stitch width control. If there is an occasion you wish to use the knee lifter, merely move lifting arm C away from you and position it just under bell crank A.

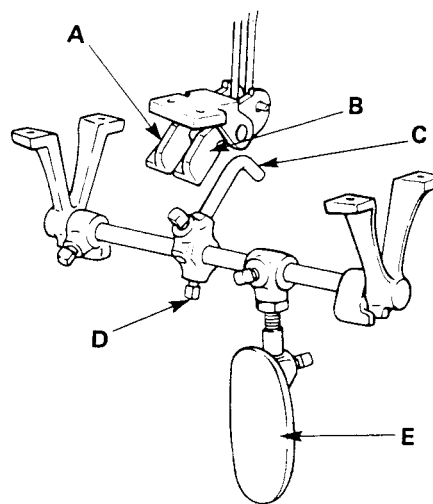

Loosen and remove screws and remove face plate by sliding it downward. Remove screws and lift off arm top cover. Clean and oil the places indicated. Also apply a drop of oil to all other oiling points shown. Keep oil pad under arm top cover saturated with oil.

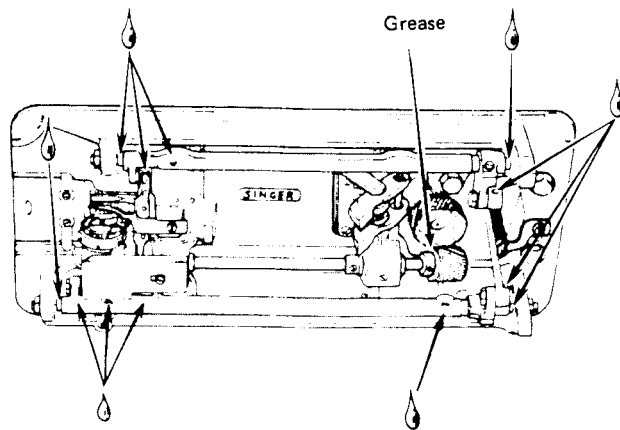
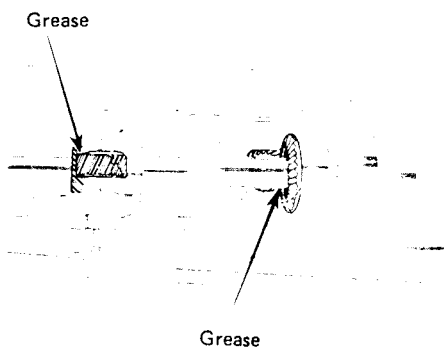
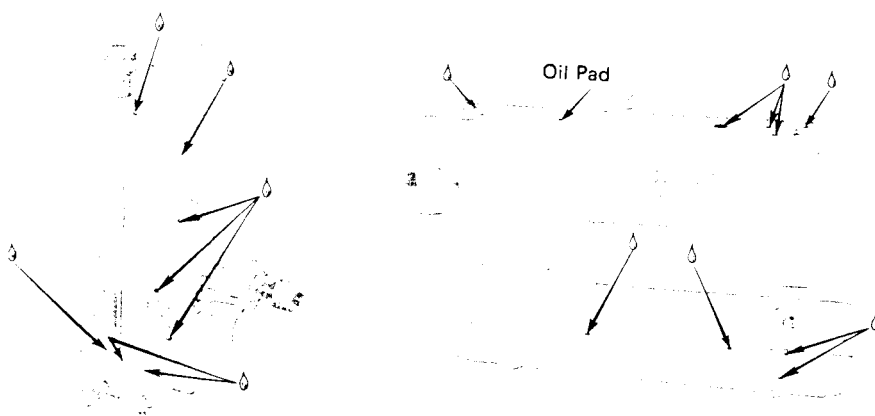

## TO REMOVE AND REPLACE THROAT PLATE

Turn handwheel toward you to raise needle to highest point.

Lift the right end of throat plate **A** and remove throat plate pin **B** from the hole in the bed. Then withdraw throat plate **A** to left to remove.

To replace throat plate **A**, withdraw the throat plate toward right while lifting the right end of the throat plate and insert throat plate pin in the hole provided in the bed.

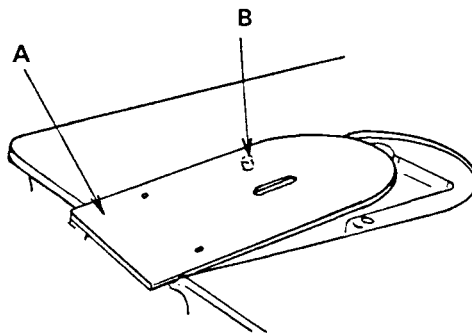

## HOW TO SET KNEE LIFTER WHEN USED ONLY FOR LIFTING PRESSER FOOT

Move lifting arm **C** to the position where bell crank **A** which is connected to lifting lever can be operated. Then tighten screw **D**.

Make certain that the point end of the lifting arm **C** does not interfere with the oil pan, and then fix rock shaft stop dog **F**.

Raise presser foot with presser bar lifter and push knee plate **E** to the right until the presser bar lifter comes down (height of presser foot above throat plate approximately 9 mm). Make certain that the knee plate does not move any further and secure rock shaft stop dog **G**.

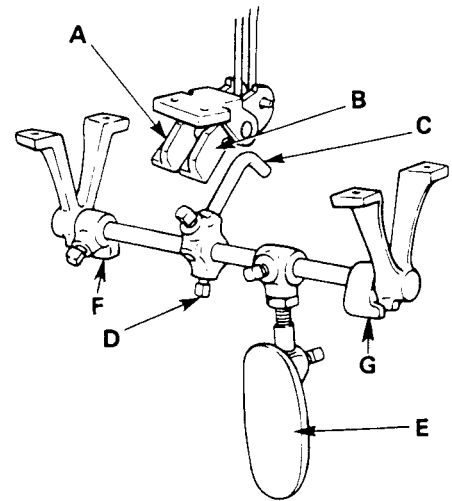

## PERFORMANCE CHECK LIST

### If machine fails to start:

- Are electrical plugs properly connected?
- Is power and light switch on?

### If thread breaks:

- Is machine properly threaded?
- Is needle the correct size for the thread and fabric you are using? Is a catalog 1955 needle securely tightened in the needle bar?
- Is thread free of slubs and knots?
- Is needle-thread tension too tight?
- Are thread guides, tension discs, and bobbin area lint-free?

### If fabric fails to feed:

- Is presser foot down?
- Is pressure adjusted properly for the weight and texture of your fabric?
- Is feed regulating dial properly adjusted?

### Remember to:

Refer to your instruction book. It was written to explain the most efficient way to operate and use this versatile new machine.

Keep your machine in good working condition by following the easy at-home-care steps outlined in the instruction book.

Remove the belt when machine is not in use. This is to prevent stretching the leather belt.

\* A Trademark of THE SINGER COMPANY