

FILE

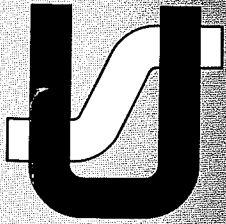

**FINEST QUALITY**

# *Union Special*<sup>®</sup>

LEWIS • COLUMBIA

**INDUSTRIAL  
SEWING  
MACHINES**

**PROPERTY OF  
DEVELOPMENT/CATALOG DEPT.**

Please return to the Catalog Dept.

Date received to file: **OCT 02 1992**

**STYLE  
39500AT**

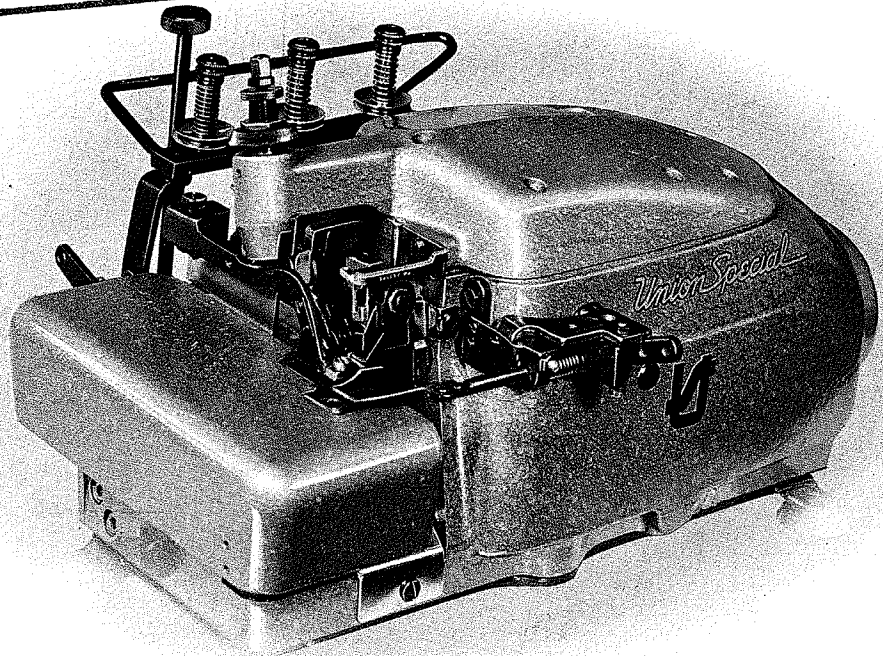

**CATALOG  
No.  
103AT**

**CLASS 39500**

**STREAMLINED**

**HIGH SPEED OVERSEAMERS**

*Union Special* **MACHINE COMPANY**

**CHICAGO**

Catalog No. 103 AT  
(Supplement to Catalog No. 103 U)

INSTRUCTIONS  
FOR  
ADJUSTING AND OPERATING

LIST OF PARTS

CLASS 39500  
STYLE 39500 AT

The parts listed in this catalog are  
furnished at list prices for repairs only.

First Edition

Copyright 1963  
by  
Union Special Machine Co.  
Rights Reserved in All Countries

*Union Special*  
**MACHINE COMPANY**  
INDUSTRIAL SEWING MACHINES  
**CHICAGO**

Printed in U.S.A.

December, 1963

## IDENTIFICATION OF MACHINE

Each Union Special machine is identified by a Style number which is stamped into the name plate on the machine. Style numbers are classified as standard and special. Standard Style numbers have one or more letters suffixed, but never contain the letter "Z". Example: "Style 39500 AT". Special Style numbers contain the letter "Z". When only minor changes are made in a standard machine, a "Z" is suffixed to the standard Style number. Example: "Style 39500 ATZ".

Styles of machines similar in construction are grouped under a class number which differs from the style number in that it contains no letters. Example: "39500".

## APPLICATION OF CATALOG

This catalog is a supplement to Catalog No. 103 U and should be used in conjunction therewith. Only those parts which are used on Style 39500 AT and not on Styles 39500 S, T or U are illustrated and listed at the back of the book. For clarity, certain 39500 S, T and U parts are shown in phantom to help locate the 39500 AT parts.

Opposite the illustration page, parts are identified by detail number, part number, description and amount required. When ordering repair parts always use the part number listed in the second column.

Adjusting and operating instructions included represent only areas concerned with Style 39500 AT.

The catalog applies specifically to the Standard Style of machine as listed herein. It can also be applied with discretion to some Special Styles of machines in this class. Reference to direction, such as right, left, front, back, etc., are given from the operator's position while seated at the machine. Operating direction of handwheel is away from the operator.

## STYLE OF MACHINE

Single Curved Blade Needle, Two Loopers, Three Thread, Overseaming Machine. Differential Feed, Trimming Mechanism with Spring Pressed Lower Knife, and Automatic Lubricating System.

39500 AT For turned down edge seaming and intermittently gathering on woven material. Seam specification 504 EFe-1 (inverted). Standard width of seam  $3/32$  to  $1/8$  inch, depending upon material. Knee press controlled tandem intermittent differential feed. Independent swing-out auxiliary pressure plate attachment. Standard gathering ratio 2.5 to 1. Depending on stitch length, a ratio up to 3 to 1 is obtainable by changing the feed cams. Stitch range, 10 to 20 per inch; cam adjusted main and differential feeds.

## OILING

CAUTION! Oil was drained from machine when shipped, so reservoir must be filled before beginning to operate. Oil capacity of Class 39500 is six ounces. A straight mineral oil of a Saybolt viscosity of 200 to 250 seconds at 100° Fahrenheit should be used.

Machine is filled with oil at spring cap in top cover. Oil level is checked at sight gauge on front of machine. Red bulb on oil level indicator should show between gauge lines.

Machine is automatically lubricated. No oiling is necessary, other than keeping main reservoir filled. Check oil daily before the morning start. Add oil as required.

Drain plug screw is located at back of machine near bottom edge of base. It is a magnetic screw designed to accumulate possible foreign materials which may have entered the crank case. It should be removed and cleaned periodically.

## IDENTIFYING PARTS

Where construction permits, each part is stamped with its part number. On some of the smaller parts, and on those where construction does not permit, an identification letter is stamped in to distinguish the part from similar ones.

Part numbers represent the same part, regardless of catalog in which they appear.

**IMPORTANT! ON ALL ORDERS, PLEASE INCLUDE PART NAME AND STYLE OF MACHINE FOR WHICH PART IS ORDERED.**

## TERMS

Prices are net cash and subject to change without notice. All shipments are forwarded f. o. b. shipping point. Parcel Post shipments are insured unless otherwise directed. A charge is made to cover postage and insurance.

## NEEDLES

Each Union Special needle has both a type number and a size number. The type number denotes the kind of shank, point, length, groove, finish and other details. The size number, stamped on the needle shank, denotes the largest diameter of blade measured in thousandths of an inch, midway between the shank and the eye. Collectively, the type number and the size number is the complete symbol.

Style 39500 AT uses a curved blade needle. The standard needle for this Style is Type 154 GBS. It has a round shank, round point, curved blade, standard length, double groove, struck groove, spotted, chromium plated, in sizes 025, 027, 029, 032.

To have needle orders promptly and accurately filled, an empty package, a sample needle, or the type and size number should be forwarded. Use description on label. A complete order would read: "1000 Needles, Type 154 GBS, Size 029".

Selection of the proper needle size should be determined by size of thread used. Thread should pass freely through needle eye in order to produce a good stitch formation.

## USE GENUINE NEEDLES AND REPAIR PARTS

Success in the operation of these machines can be secured only with genuine Union Special Needles and Repair Parts as furnished by the Union Special Machine Company, its subsidiaries and authorized distributors. They are designed according to the most approved scientific principles, and are made with utmost precision. Maximum efficiency and durability are assured.

Genuine needles are packaged with labels marked *Union Special*. Genuine repair parts are stamped with the Union Special trade mark. Each trade mark is your guarantee of the highest quality in materials and workmanship.

## THREAD STAND

After thread comes from cone on thread stand (V, Fig. 1), it is brought up through back thread eyelet, then down through front thread eyelet (W). Next it is threaded through each pair of holes in tension thread guide wire (A), down right hand hole and up through left hand hole. Then thread continues between tension discs (AD), through slot (AE), and on through thread guide (B).

## THREADING

Only parts involved in threading are shown in threading diagram (Fig. 1). Parts are placed in their relative positions for clarity.

It will simplify threading this machine to follow recommended sequence of threading lower looper first, upper looper second, and needle third.

Before beginning to thread, swing cloth plate open, turn handwheel in operating direction until needle (N) is at high position, release pressure on presser foot by turning presser foot release bushing (U); and swing presser arm (H) out of position.

Be sure threads, as they come from the tension thread guide, are between tension discs (AD) and in diagonal slots (AE) in tension posts (AC).

### TO THREAD LOWER LOOPER

Double end of thread and lead it through both eyes of lower looper thread eyelet (E, Fig. 1) from right to left. Note: Thread must pass in front of looper thread pull-off (T). Lead thread behind fabric guard (F) and through both holes of frame looper thread guide (G). Turn handwheel in operating direction until heel of lower looper (K) is all the way to the left; then thread through both eyes from left to right. Left eye of lower looper can be threaded easily if tweezers are in left hand.

### TO THREAD UPPER LOOPER

Turn handwheel until point of upper looper (L) is all the way left. Lead thread through auxiliary looper thread eyelet (D) from back to front, then through both eyes of upper looper thread eyelet (C) from left to right. Note: Thread must pass in front of looper thread pull-off (T). After pulling up upper looper thread tube assembly (M), lead thread under neck of top cover casting and down through thread tube assembly. Pull thread out bottom of tube; push tube down, then insert thread through upper looper eye from front to back.

**CAUTION!** Be sure upper looper thread is under lower looper thread when passing from tube assembly to upper looper eye.

### TO THREAD THE NEEDLE

Turn handwheel in operating direction until needle (N, Fig. 1) is at its highest position. Insert needle thread from right to left, through both eyes of needle thread eyelet (R), under neck of top cover casting; then down through hole in top cover needle thread eyelet (P). Thread needle from front.

## THREAD TENSION

The amount of tension on needle and looper threads is regulated by three knurled tension nuts (AA, Fig. 1). Tension on threads should be only enough to secure proper stitch formation.



## FEED ECCENTRIC

Feed eccentrics used in this machine have been selected to produce approximately 16 stitches per inch. It will be noted that the part number of the main feed eccentric is No. 39540-16, while that of the differential feed eccentric is No. 39540-6. Minor numbers of the part symbol indicate approximately the number of stitches obtainable when using that eccentric. Unless otherwise specified, machine will be shipped with above combination of eccentrics.

Generally speaking, main (right hand) feed eccentric determines number of stitches produced; differential (left hand) feed eccentric is selected in relation to degree and direction of stretch of material being sewn, or type of operation.

The following stitch number feed eccentrics are available under No. 39540: 4, 5, 6, 7, 8, 9, 10, 11, 12, 13, 14, 15, 16, 18, 20, 22, 24, 26, 28, 30, 32, 34, 36, 40. Only two eccentrics are supplied with each machine. Additional eccentrics may be ordered separately. To order an eccentric, use No. 39540 with a minor number suffixed to indicate number of stitches desired. Example: "39540-16".

### ASSEMBLING AND ADJUSTING SEWING PARTS (Page 8)

All instructions pertaining to the adjustment of Style 39500 AT are the same as those for Style 39500 T covered by Catalog No. 103 U with the following exceptions. The differences, applicable only to Style 39500 AT, are underlined below with page numbers where each is found in Catalog No. 103 U.

### SETTING THE UPPER KNIFE (Page 11)

Replace upper knife assembly. Clamp upper knife (D, Fig. 13) in position, setting nut (E) to hold clamp (F) in its most clockwise position against upper knife. At bottom of its stroke, front cutting edge of upper knife should extend not less than 1/64 inch below cutting edge of lower knife. The chain guard (J) should be set down against the upper knife and slightly back from the cutting edge.

After upper knife has been set for proper width of trim, screw (G) should be tightened to lock upper knife holding block (H) in place. This will simplify resetting when upper knife is replaced.

NOTE: An approximate setting for the upper knife would be to measure twice the distance of the desired width of seam, from the centerline of the needle to the cutting edge of the upper knife. Example: If a 3/32 inch seam width is desired, set the upper knife cutting edge 3/16 inch away from the centerline of needle.

### SETTING THE PRESSER FOOT HOLD DOWN PLATE (This adjustment to follow "Setting The Presser Foot", Page 12)

This machine comes equipped with a presser foot hold down plate (A, Fig. 16A). It is for the purpose of holding down the rear of the presser foot and when set correctly it will help produce a more flat pucker free seam. An approximate setting is shown in Fig. 16A. Set the machine with the feed dogs below the throat plate and insert a .005 inch shim (B) under the front portion of the presser foot (C). Loosen the screws (D) which hold the hold down plate in position and move the plate down until it rests firmly against the presser foot. Tighten the two screws and remove shim.  
NOTE: Always be sure feed dogs are below surface of throat plate when making this setting.

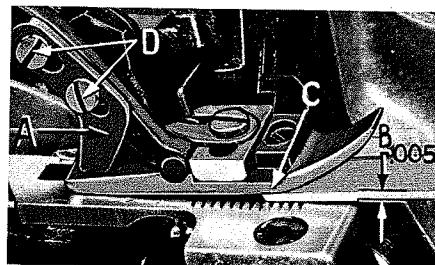
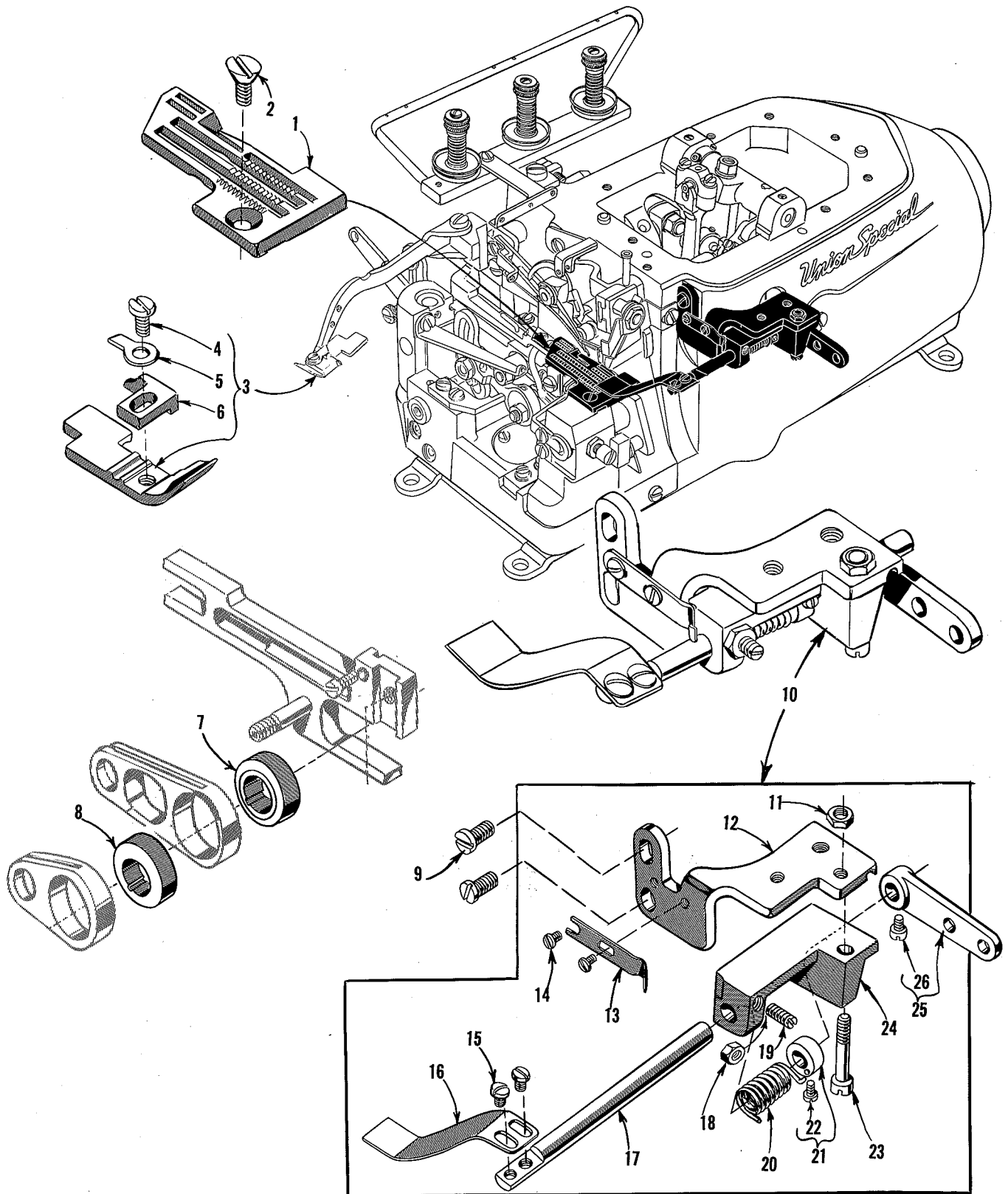

Fig. 16A

### SETTING THE AUXILIARY PRESSURE PLATE (Page 12, Item 4)

With the differential feed dog down below the surface of the throat plate, and the pressure plate resting on the throat plate with the maximum pressure the spring will allow, there should be approximately 1/64 inch clearance between the top of the operating lever (F, Fig. 17) and the bottom of notch in the mounting bracket (C, Fig. 18). To make this adjustment, loosen screw (A, Fig. 18) and move lever to desired position.





The parts illustrated on the preceding page and described on this page represent the parts used on Style 39500 AT, but not used on Styles 39500 S, T or U.

Parts shown in phantom views, bearing no reference numbers, are common to Styles 39500 S, T, U and AT.

Use Catalog No. 103 U, Style 39500 S, for all parts not illustrated or described here.

<u>Ref. No.</u>	<u>Part No.</u>	<u>Description</u>	<u>Amt. Req.</u>
1	22524	Screw-----	1
2	39524 AT	Throat Plate, marked "BF"-----	1
3	39520 AT	Presser Foot-----	1
4	J87 J	Screw-----	1
5	39530 G	Hinge Spring-----	1
6	39597 AT	Stitch Tongue, marked "ET"-----	1
7	39540-16	Main Feed Driving Eccentric-----	1
8	39540-6	Differential Feed Driving Eccentric-----	1
9	22569 C	Screw-----	2
10	29480 DC	Auxiliary Pressure Plate Assembly-----	1
11	907	Nut-----	1
12	39531 AS	Mounting Bracket-----	1
13	39531 E	Latch Spring-----	1
14	604	Screw-----	2
15	22561	Screw-----	2
16	39531	Presser Plate-----	1
17	39531 A	Pressure Plate Shaft-----	1
18	41071 G	Lock Nut-----	1
19	HS82	Screw-----	1
20	39531 C	Pressure Plate Spring-----	1
21	39531 B	Shaft Collar-----	1
22	604	Screw-----	1
23	22582	Screw-----	1
24	39531 AT	Pressure Plate Shaft Bracket-----	1
25	39531 AR	Pressure Plate Operating Lever-----	1
26	77 A	Screw-----	1



FINEST QUALITY

# Union Special®

LEWIS and COLUMBIA



INDUSTRIAL SEWING MACHINES

## SALES OFFICES AND REPRESENTATIVES

†Handle Union Special and Columbia only.

‡Handle Lewis and Columbia only.

All others handle Union Special, Lewis and Columbia with certain exceptions.

### UNITED STATES

ALABAMA, BIRMINGHAM, 8630 First Ave. South, Lloyd D. Baldwin, Tel. 833-9904.

ALABAMA, MONTGOMERY 7, 1959 Amelia Drive, Garnet H. Hamlet, Tel. 265-0942.

★CALIFORNIA, LOS ANGELES 21, 1100 E. Pico Blvd., Paul M. Mason, Mgr., Tel. Madison 5-5828.

CALIFORNIA, SAN FRANCISCO 7, 1275 Mission St., Robert J. Vail, Tel. Underhill 1-1580.

‡CALIFORNIA, SAN FRANCISCO 3, Apparel City Sewing Machine Co., 1155 Mission St., Tel. MArket 1-6660.

COLORADO, ARVADA, Casey's Sewing Machine Service, 5719 Reed St., Tel. 424-6630 (Textile Machines).

COLORADO, DENVER 10, 1801 South Marion St., Louis E. Carter, Tel. 777-7060. (Bag Closing Machines)

CONNECTICUT, DANBURY, 22 Barnum Road, Robert W. Gaines, Tel. 746-3652.

FLORIDA, MIAMI 37, 2247 N.W. 2nd Ave., Hymen L. Simon, Tel. Franklin 4-2235.

FLORIDA, PLANT CITY, 506 N. Gordon St., James C. Morgan, Tel. 752-1829.

★GEORGIA, ATLANTA, 2120 Plastaza Bridge Road, N.E., Merritt M. Ambrose, Mgr., Tel. 875-9237.

GEORGIA, COMMERCE, Lakeview Drive, J. Tom Hanlev, Tel. 335-4061.

GEORGIA, DECATUR, 1713 Coventry Road, Joe V. Parker, Tel. 377-5559.

GEORGIA, DUBLIN, 1615 Knox St., John W. Jones, Tel. 372-4663.

★ILLINOIS, CHICAGO 10, 400 N. Franklin St., Orville A. Ullrick, Mgr., Tel. 644-6920.

KANSAS, PRAIRIE VILLAGE, 7351 Rosewood, Cleo C. Smith, Tel. HE 2-1705.

KENTUCKY, LOUISVILLE 7, P.O. Box 7261, Raymond E. Hinton, Tel. 587-0042.

LOUISIANA, NEW ORLEANS, P.O. Box 1065, Chalmette, La., Larry A. Van Hooser, Tel. 271-3106.

MARYLAND, BALTIMORE 15, P.O. Box 2505, Ralph B. Foster, Tel. 727-8499.

‡MARYLAND, BALTIMORE 1, J. Dashew, Inc., 417 W. Baltimore St., Tel. LExington 9-1838.

†★MASSACHUSETTS, BOSTON 11, 179 Lincoln St., William E. Palm, Mgr., Tel. Liberty 2-0147.

‡MASSACHUSETTS, BOSTON 11, Zalkind Sewing Machine & Supply Co., 205 Lincoln St., Tel. HANcock 6-5888.

†MASSACHUSETTS, CANTON, York St., RFD. Roy T. Pedersen, Tel. 828-1412.

‡MASSACHUSETTS, FALL RIVER, Zalkind Sewing Machine & Supply Co., 1059 S. Main St., Tel. OSborne 5-7847.

†MASSACHUSETTS, TAUNTON, P.O. Box #2 Raynham, Walter P. Godek, Tel. VanDyke 2-6149.

MASSACHUSETTS, WALTHAM, 43 Walnut Street, Larry Kelsen, Tel. 899-2374.

†MASSACHUSETTS, WORCESTER, 34 Woodside Dr., Graf-ton, Gus M. Buckley, Tel. Vernon 9-3440.

MICHIGAN, DEARBORN 6, 5747 Evergreen Road, John F. Lux, Tel. 584-4210.

MINNESOTA, MINNEAPOLIS, 2800 Texas Ave., St. Louis Park 26, Minn., Leonard W. Koehler, Tel. 644-6236.

MISSISSIPPI, JACKSON 3, 327 Eastview St., Jamie A. Boyette, Tel. Fleetwood 5-1976.

MISSISSIPPI, TUPLO, 606 Racove Drive, Bill Hayward, VI 2-5848.

MISSOURI, KANSAS CITY 31, 8235 President Court, Charles Wickersham, Tel. HI 4-0764.

‡MISSOURI, KANSAS CITY 5, Textile Machinery Co., 915 Broadway, Tel. Victor 2-9558.

MISSOURI, ST. LOUIS 34, 9860 Guthrie Ave., Carl E. McLaughlin, Tel. Chestnut 1-2368.

†NEW HAMPSHIRE, NASHUA, P.O. Box 257, Herman E. Haberman Jr., Tel. Tuxedo 2-9698 and 2-9812.

†NEW JERSEY, NORTH ARLINGTON, 8 Rutherford Place, Joseph Loglisci, Tel. 991-8211.

†NEW JERSEY, RUTHERFORD, 246 Sylvan St., Richard W. Whitson, Tel. Geneva 8-2178.

NEW YORK, LATHAM, 57 Sylvan Ave., Clarence A. Wheeler, Tel. State 5-6371.

★NEW YORK, NEW YORK 1, 370 7th Ave., (Penn Terminal Bldg.) Clarence L. Rosenquist, Mgr., Tel. Chickering 4-8800.

‡NEW YORK, ROCHESTER 9, A. J. Adams Co., 1051 Culver Rd., Tel. BUtler 8-7250.

NEW YORK, UNIONDALE, 873 Henry St., Anthony Candell, Tel. Ivanhoe 3-7477.

NORTH CAROLINA, GREENSBORO, P.O. Box 226, William D. Harrod, Tel. 299-9367.

OHIO, CLEVELAND 3, 6020 Euclid Ave., Hirsch Garment Equipment Corporation, Tel. Express 1-8811.

OHIO, COLUMBUS, P.O. Box 874, Jerry Smith, Tel. AXmin-ister 1-1222.

OKLAHOMA, OKLAHOMA CITY 19, 2226 Southwest 53rd St., G. B. Wiley, Tel. 685-2836.

PENNSYLVANIA, ALLENTOWN, P.O. Box 542, Luther D. Cassell, Tel. 797-2111.

PENNSYLVANIA, BLOOMSBURG, P.O. Box 361, Irvin H. Kendig, Tel. 784-7864.

PENNSYLVANIA, CLARKS SUMMIT, 428 West Grove Ave., John J. Laffer, Tel. JUNiper 7-2820.

PENNSYLVANIA, EGYPT, 628 Main Street, Bernard Sagano-wich, Tel. 262-2125.

★PENNSYLVANIA, PHILADELPHIA 24, 4234 Macalester Ave., Ben W. Merz, Mgr., Tel. Gladstone 5-9800.

†PENNSYLVANIA, PITTSBURGH (Irwin), 100 Arona Road, W. Dale Speer, Tel. (Pittsburgh) 563-3589.

PENNSYLVANIA, REAMSTOWN, P.O. Box 176, David M. Bender, Tel. 272-6292.

PENNSYLVANIA, YORK, P.O. Box 884, Harding T. Powell, Tel. 28040.

SOUTH CAROLINA, COLUMBIA, 2039 Winsor Hills Drive, Virlyn R. Crisler, Tel. Sunset 7-0863.

SOUTH CAROLINA, GREENVILLE, 25 Str Abbot St., Orville W. Gregory, Tel. Cedar 9-5539.

TENNESSEE, KNOXVILLE 19, 3905 Greenleaf Ave., Horace E. Clinard, Tel. 588-1865.

TENNESSEE, MEMPHIS 17, 4695 Dunn Rd., Richard J. Lind-horst, Tel. Mutual 5-6750.

TENNESSEE, NASHVILLE 12, 1602 South Observatory Drive, William J. Brauch, Tel. Cypress 2-5123. 2517 Woodberry Drive, F. M. Blunkall, Tel. 883-3352.

★TEXAS, DALLAS 19, 4200 Hines Blvd., P.O. Box 6727, Zack X. Bennett, Mgr., Tel. Lakeside 6-8369.

TEXAS, EL PASO, P.O. Box 9573, Edward E. Smith, Tel. 598-2928.

TEXAS, SAN ANTONIO, Jerry Gregory, P.O. Box 13126, Tel. DI 2-5924.

UTAH, SALT LAKE CITY, 1215 E. 13th South St., Larry F. Rosvall, Tel. IN 7-6931.

VIRGINIA, LYNCHBURG, P.O. Box 1075, Clarence D. Mairs, Tel. 239-1477.

VIRGINIA, PETERSBURG, P.O. Box 847, Thomas J. Traylor, Tel. 732-8080.

WASHINGTON, SEATTLE, 1608 North 35th St., Marvin H. Corns, Tel. 624-8083.

### CANADA

Union Special Machine Co. of Canada, Ltd.

BRITISH COLUMBIA, NORTH BURNABY, James Stewart, 1276 Rosser Street, Tel. 861-1580.

MANITOBA, WINNIPEG, Frank Thierman, Rm. 201, Whitea Bldg., 70 Arthur St., Tel. Whitehall 3-4933.

★ONTARIO, TORONTO 2B, Les Yates, Mgr.-Rep., 355 King St. West, Tel. Empire 6-2939.

★QUEBEC, MONTREAL 10, John Caschetto, Mgr.-Rep., 40 Moliere St., Tel. 276-2575.

FINEST  
QUALITY  
WORK

HIGHEST  
PRODUCTION  
RATES

LOWEST  
MAINTENANCE  
COSTS

Sales Agents For UNION SPECIAL Machines;  
Also Agent for (L) LEWIS and (C) COLUMBIA where marked.

**AFRICA**

(TEXTILE & BAG MAKING MACHINES) Berzack Bros., Ltd. REPUBLIC OF SOUTH AFRICA—JOHANNESBURG 135/7 Pritchard St. CAPETOWN—78 Darling St. DURBAN—72/74 Commercial Road. PORT ELIZABETH—125 Queen Street. SOUTHERN RHODESIA, FEDERATION OF RHODESIA & NYASALAND—BULAWAYO—16-14th Ave. SALISBURY—102 Sinica St. (L)

(BAG CLOSING MACHINES) South African Scale Co. Pty., Ltd. REPUBLIC OF SOUTH AFRICA—JOHANNESBURG—32 Von Brandis St. BLOMFONTEIN—53 Zaïron St. CAPETOWN—Wales and Bree Sts. DURBAN—22 Allwal St. EAST LONDON—38 Argyle St. LADYSMITH, Natal—355 Murchison. PORT ELIZABETH—Box 611. Also at PIETERMARITZBURG, PRETORIA, VEREENGING OF SOUTHERN RHODESIA, FEDERATION OF RHODESIA & NYASALAND BULAWAYO—2 Leander House, Rhodes Street. SALISBURY—95 Victoria Street. NORTHERN RHODESIA—KITWE—Blanyfere Road.

ERITREA, ASMARA—S.A. Calderoni Africa, Avenue P. Astafa Woosen (L & C)

ETHIOPIA, ADDIS ABABA—Maison F. Livierato (Ethiopia) Ltd. P.O. Box 1699.

KENYA, NAIROBI—Transcandia, Ltd., College House, Saddler St. (P.O. Box 5933) (L & C) (Also Uganda, Tanganyika and Zanzibar)

MAURITIUS, PORT LOUIS—(Bag Closing & Bag Making Machines) Hall, Geneva, Langlois, Ltd., 42 Sir William Newton St.

MOROCCO, CASABLANCA—R. Geissmann & Fils, Rue El Idrissi Es Sakati (L)

NIGERIA, APAPA, LAGOS—Sunflag Knitting Mills (Nigeria) Ltd. 9 Warehouse Road.

SUDAN, KHARTOUM—Franco Pinto (Sudan) Ltd., P.O. Box 305, (L & C)

TUNISIA, TUNIS—Comptoir Industrial & Manager, 8 Rue du 18 Janvier 1952 (L)

**ASIA**

CAMBODIA, PHOM-PENH—Denis Freres, 219 P.B. Sisowath, P.O. Box 48. (C & L)

HONGKONG—G. R. Coleman Co. (Hongkong) Ltd., Room 308, Bank of Canton Bldg., 6 Des Voeux St., Central. (L & C)

INDIA, CALCUTTA—Don, Watson & Co., (Pvt.) Ltd., (In Bengal Assam Behar Orissa) 19 British Indian St. (L) Royal Sewing Machine Agency, (All other states) P-12, Kalakar Street. Branch—Bombay 2, 36, Panchayat Wadi. (L & C)

JAPAN, OSAKA—Kondo Sewing Machine Co. 163, Umegoe-cho Kita-ku. (L) Branch—Tokyo 6-3 Ginza, Chuo-ku.

KOREA, SEOUL—Uebersee-Handel A.G., Rm. 604, Bando Bldg. 180 1-ka Ulchiro; Chung-Ku, Int. P.O. Box 1268. (L)

LAOS, VIETIANE—Denis Freres, P.O. Box 133. (C & L)

PAKISTAN, (WEST) KARACHI—Universal Trading Corp., 29 Zeeanat Mansion, McLeod Road. LAHORE—A. Rahman & Co. (Pakistan) Ltd., Czernin Palace, Bank Square, The Mall. (EAST) (Bag closing and bag making machines) Thomas C. Keay, Ltd., 15 Baltic Street, Dundee, Scotland.

TAIWAN, TAIPEI—G. R. Coleman Co. (Hongkong) Ltd., 16 Nan Yang St. (L & C)

THAILAND, BANGKOK—Yip In Tsoi & Co., Ltd., P.O. Box 23. (L & C)

VIETNAM, SAIGON—Societe des Riz d'Indochine, Denis Freres, P.O. Box 444, 2 Rue Tu Do. (C & L)

**AUSTRALIA**

SOLE DISTRIBUTORS: Capron, Carter Pty., Ltd., 86 Liverpool Street, SYDNEY. Branches at: BRISBANE—454 Brunswick St., Valley, N.I. MELBOURNE—154 A'Beckett St. AGENTS: ADELAIDE—Topp & Farmer, Ltd., 177 Hindley St. PERTH—Thomsons, Ltd., 789 Hay St. TASMANIA, HOBART—Reliance Trading Co., 105 MacQuarie St. (L & C)

**EUROPE**

AUSTRIA, VIENNA—Firma Nähschuster, Mariahilferstr. 51. (L)

BELGIUM, BRUSSELS—Union Special Machine Corporation of America, 90 Rue de la Caserne, Henry Deloof, Mgr. (C)

DENMARK, COPENHAGEN—Rothensborg Specialmaskiner for Sy-industrien A/S, Nikolaj Plads 23. Offices at: AALBORG, HERNING, KOLDING, ODENSE, RISSKOV-AARHUS AND SILKEBORG. (L)

FINLAND, HELSINKI-LAUTTASAARI—Suomen Konellike O/Y, Vattuniemenkatu 13. Branches at: TAMPERE-Pienteoillisu-stalo. TURKU, Tiipistonkatu 16. (L & C)

FRANCE, PARIS—Cie. des Machines Union Special de France, 91 Ave. de la Republique—Thos. de Samsen, Directeur. Branch at: ROUBAIX (NORD)—50 Ave. J. Lebas. LYON, VILLEURBANNE (RHONE) 58 rue Alexandre Boutin.

GERMANY, STUTTGART—Union Special Maschinenfabrik, G.m.b.H., Schwabstr. 33—A. W. Krieger, Managing Director. Th. M. Baanstra, Director of Sales, BRANCHES AT: BIELEFELD, EBINGEN, FRANKFURT, HAMBURG, KOLN, MUNCHEN. (C & L Button Sewers)

GREAT BRITAIN—(Textile Machines)—ENGLAND, LEICESTER, Union Special Machine Co., Ltd., 25 Bede Street, Braunstone Gate, A. B. Fitzpatrick, Manager. BRANCHES: BRISTOL, J. R. Rockingham, 54 Clarendon Road, Redland. LEEDS, C. Waters, 60 Merrion St. LONDON, E. C. 1, H. O. Hall, 108 City Road. SUB-AGENTS: LONDON—W 1—G. Johnson & Son (Sewing Machinery) Ltd., 53 Great Titchfield St. MANCHESTER 19, S. A. Smith (Manchester) Ltd., Park Grove Works, Levenshulme. NORTH-EARN IRELAND, NEWTOWNABBEE, GLENGORMLEY, COUNTY ANTRIM, Wilson Coulter, Ltd., Ferbro Bldgs., 335 Antrim Road, Glengormley. SCOTLAND, GLASGOW, S. E., Allardice & Co., 9 Stevenson Street. (Bag Closing and Bag Making Machines) SCOTLAND, DUNDEE—Thomas C. Keay, Ltd., 15 Baltic Street—Agent for entire British Isles.

GREECE, ATHENS—Georges Yannakouras-Dimoulis, 30 Petraki St. (L & C)

IRELAND, DUBLIN—(Textile Machines) W. Blythman, 224 Parnell Street (L) (Bag Closing and Bag Making Machines) Thomas C. Keay, Ltd., 15 Baltic St., Dundee, Scotland.

ITALY, MILANO—Giovanni Conti & Nipoti, Via Varese 18. (L & C)

THE NETHERLANDS, AMSTERDAM—N. V. Machinehandel C. & H. Verbeek, Kloveriersburgwal 77. Offices at: ARNHEM, ENSCHEDE, GRONINGEN, ROTTERDAM, SIT- TARD, TILBURG. (L & C)

NORWAY, OSLO—Jac. Jacobsen A/S, Luxo-Garden, Enebak- kveien 117, BERGEN—Bjornsonstg 24. (C)

PORTUGAL, OPORTO—Rest & Janus, Succs. Lda., Rua Barao de Forrester 914. (L)

SPAIN, BARCELONA—Rupida, S.A., Avenida Jose Antonio 860. (L)

SWEDEN, BORAS—Rud. Nyström & Co., A/B, Lilla Bran- nerigatan 6. Branches at: OREBRO—Staldgatan 37-39. MALMO, S. Forstangsgatan 16. Sub-Agent STOCKHOLM, A/B Forsberg & Kato, Tomtebgatan 38.

SWITZERLAND, URDORF (ZH)—M. L. Bourquin, Vogelaustr. (Postfach). (L-Button Sewer)

**LATIN AMERICA**

Union Special International, Inc.

ARGENTINA, BUENOS AIRES—IROMAC S.A.C., Division Pamaco Costura, S.A., San Jose 350. (Union Special Machine Company) (L & C)

BRAZIL, SAO PAULO—Pancostura S.A.—Industria e Comercio, Rua Aurora 59A-71. Branches at: PORTO ALEGRE—Rua Voluntarios da Patria 533; RECIFE—Rua Princesa Isabel 105; RIO DE JANEIRO—Rua Alexandre Mackenzie 117. (C & L)

CHILE, SANTIAGO—Lowenstein & Stewart, S.A.C., Calle Santa Domingo 1140. (L & C)

COLOMBIA, BOGOTA—Macalzado, Ltda., Calle 13 #22-53. (L) Branches at: BARRANQUILLA—Calle 30 #12-29. BUCARAMANGA—Calle 34 #17-45. CALI—Carrera 1A #22-50. MEDELLIN—Carrera 51, (Bolivar) #41-180. PE- REIRA—Carrera 8 #22-12. (L)

COSTA RICA, SAN JOSE—Enrique Rodrigues S., P.O. Box 1949. (L & C)

DOMINICAN REPUBLIC, SANTA DOMINGO—Roberto Domin- quez, G., Calle Dr. Pedro H. Urena 19. (L)

ECUADOR, GUAYAQUIL—Distribuidora Richard O. Custer, S.A., 9 de Octubre 211-213. Branch at QUITO—Carrera Benalcázar 659.

EL SALVADOR, SAN SALVADOR—Vairo Hermanos, Colo- nia Vairo. (L)

GUATEMALA, GUATEMALA—Compania Agro Comercial, S.A., 8a Avenida Sur #10-43. (L & C)

HONDURAS, SAN PEDRO SULA—Jacobo E. Handel, P.O. Box 559.

MEXICO, MONTERREY, N.L.—Talleres Perez Zozaya, S.A. de C.V., Cuauhtemoc Norte 335. Branches at: GUADALA- JARA, JAL.—Hidalgo 45 y 47; MEXICO, D.F.—Distribui- dora Union Especial, S.A. de C.V., Ave., Pino Suarez 99-a (Apartado 12770); SAN LUIS POTOSI, S.L.P.—J. de los Reyes 80. (L)

NICARAGUA, MANAGUA—Casa Hentgen, 1A Calle S.O. #209. (L)

PANAMA, PANAMA—Agencias Hagus, S.A., Ave. 7a Espana #45.

PERU, LIMA A. y F. Wiese, S.A., Esq. Nunez y Filipinas. (L)

PUERTO RICO, SAN JUAN—Abarca Warehouse Corp., P.O. Box 2352. (L & C)

SURINAM, PARAMARIBO—Kirpalani's, Ltd., 17-27 Maagden St. (L & C)

URUGUAY, MONTEVIDEO—Storer & Cia., S.A., Uruguaya, Mercedes 1312. (L)

VENEZUELA, CARACAS—H. Blohm, S.A., Dr. Paul A. Chorro 29. (L)

**NEAR EAST**

CYPRUS, NICOSIA—Christodoulides Bros. & Co., 94 Tri- coupplis St. (L)

IRAN, TEHRAN—Sava Trading Corp., Ave. Bozarjomehri 881. Seray Saadiyeh. (L & C)

IRAQ, BAGHDAD—Sons of O. O. Agopian, P.O. Box 121. (L & C)

ISRAEL, TEL AVIV—L. Taube, Ltd., 15 Lilienblom St. (L)

LEBANON, BEIRUT—Sons of O. O. Agopian, P.O. Box 1165. (L & C)

SYRIA, DAMAS—Elias Aractingi & Fils, Sidi Amoun. (L & C)

TURKEY, ISTANBUL—M. Bemaýor, Mahmutpasao Abut Efendi Han Nr. 46-47 (Textile, L & C) David ve Leon Varber ve Seriki, Hamdi Bey Geccidi 36, 38, 40, Posta Kutusu 385. (Bag Closing & Bag Making Only)

U.A.R., Cairo—Societe Misr, 6 Rue Adly—Tech. Sub-Agent—A. Kavaldjian, S.A.R.L., 200 Sharia Shubra.

**NEW ZEALAND**

SOLE DISTRIBUTOR: H. A. Tuck & Co., Ltd., 171 Albert St., AUCKLAND. BRANCH AT: WELLINGTON, Ford Bldg., Courtenay Place. (L) SUB-AGENTS: Glendernid, Ltd., CHRISTCHURCH—90 Orbell St. DUNEDIN—192-196 Cas- tle St., P.O. Box 40. (C)

**PACIFIC ISLANDS**

HAWAII, HONOLULU—(Textile Machines) Territorial Sales Co., 508 Atkinson Drive. (L) (Bag Closing and Bag Mak- ing Machines) H. S. Gray Co., 759 Puuloa Rd.

PHILIPPINE ISLANDS, MAKATI, RIZAL—Atkins, Kroll & Co., Inc., 313 Malugay Street, (Buendia Extension). Branch at CEBU. (L & C)

**WEST INDIES**

Union Special International, Inc.

JAMAICA, KINGSTON—Morris E. Parkin, 96 King St. (L)

TRINIDAD, PORT OF SPAIN—Ackrill & Co., 17 Henry St. (L & C)

BAHAMAS, NASSAU—H. L. Simon & Co., 2650 N.W. 5th Avenue, Miami 37, Florida

Additional Sales Agents for (L) LEWIS and (C) COLUMBIA Machines

AUSTRIA IV, VIENNA—Franz Korpet, Wiednerhaupt Str. 36. (C)

BELGIUM, BRUSSELS—N. V. Machinehandel C & H Verbeek, Kruidtuinlaan 57a, Buyl Bldg. (L)

COLOMBIA, BOGOTA—L. Koenig, Ave. Caracas 12-48. (C)

DENMARK, COPENHAGEN—Dimas, Det Internationale Indus- trimaskine A/S, Valdemarsgade 8. (C)

FRANCE, PARIS—Societe G. Arnon & Cie., 14 Rue Commines (L)—Aspe-Dumont & Cie., 13 Rue de la Fontaine-Au-Roi. (C)

GERMANY, BIELEFELD—Durkoppwerke A/G (Also all their branches). (L except button sewer) KREFELD—Herbert Jannsen, Alte Linnerstr. 104 (C. tie mach.)

GREAT BRITAIN—ENGLAND—Eastman Machine Co., Ltd., 89 Baddington Lane, CROYDON, Surrey. LONDON, E.C. 1—15-17 City Road (Showroom and Shop). LEEDS—60 Merrion St. MANCHESTER—60-62 Corporation St. (L). NORTHERN IRELAND, BELFAST (15)—Bernard L. Lewis, 40 Parkmount Terrace Shore Rd. REPUBLIC OF IRELAND—DUBLIN—W. Blythman, 224 Parnell Street. SCOTLAND, GLASGOW, S-2—Hugh Sweeney, 11 Drumreuch Place. (L). LONDON E.C. 1—W. & J. Bogad & Co., Ltd., 50-52 Great Sutton Street. (C)

IRELAND, DUBLIN—Machines, Ltd., 24 Upper Abbey St. (C)

ISRAEL, TEL AVIV—Israel Sewing Machine Co., 22 Yehuda Halevy St. (C)

MEXICO, MEXICO, D.F.—Casa Diaz de Maquinas de Caser, Av. Republic Del Salvador 89-93 (C)

MOROCCO, CASABLANCA—Durkopp Coudrex, 25 Rue Bascur- nama. (C)

NORWAY, OSLO—J. A. Johansen A/S, Torvgatan 10. (L)

REPUBLIC OF SOUTH AFRICA, JOHANNESBURG—African Sewing Machine Company (Pty.) Ltd., 85/87 Pritchard Street. Branches at: CAPE TOWN—110 Plein St.; DURBAN —16 Saville St. (C)

SOUTHERN RHODESIA, FEDERATION OF RHODESIA & NYASALAND, BULAWAYO—African Sewing Machine Com- pany (Rhodesia) (Pvt.) Ltd., 138 Rhodes Ave.

SPAIN, BARCELONA—Arbis Maquinaria Y. Suministros Tex- tiles, Avenida Mistrat 61. (C)

SWEDEN, BORAS—Husqvarna, Industrismaskiner A/B—Kungsgatan 34. Branches: GOTEBOG—Stigbergsgatan 1 MALMO—Isak Slakteregatan 9—OREBRO—Stortorget 19 —STOCKHOLM—Brunnsgatan 6-8. Agents—ULRICEHAM—Firma Hjalmar Svensson, Tinghusgatan 2—BERTILS—Maskinservice, Stadsaga 427. (C)

SWEDEN, A/B. A. C. Gustafson, Kungsgatan 28. Boras. Branches: MALMO—Stora Kvornsgatan 29. STOCKHOLM—Kungsgatan 18. (L)

SWITZERLAND, ZURICH—Fritz Zellwegar & Sohne, Sel- naustr. 27. (L except Button Sewer) Guttinger A.G., Sihlstrasse 37. (C)

URUGUAY, MONTEVIDEO—C. Brandes & Cia., S.A., Calle Rincan 658. (C)

# INDUSTRIAL SEWING MACHINES

**... for Every Purpose!**

Job requirements vary — that's why Union Special builds a wide variety of specially designed sewing machines. It is also the reason why Union Special field representatives make a careful study of requirements before giving you detailed recommendations on the kind of equipment to install. Plants equipped with modern, high speed Union Specials have an important advantage. Union Special machines are built to do the job faster . . . better . . . cheaper, and they stay on the job with minimum time out for repairs. You're ahead when you use Union Special.

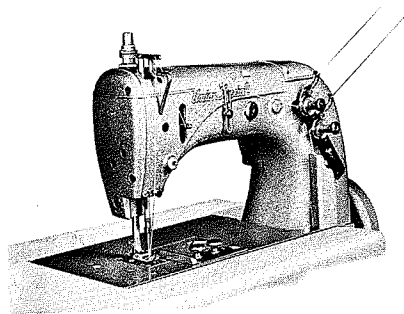

## 50000 SERIES MACHINES

The thousands of manufacturers using Union Special's new 50000 SERIES machines are finding these ultra-modern, streamlined models to be invaluable aids in cutting costs of operations and boosting production of a wide variety of products. Each of the many machines in the improved 50000 SERIES is specially designed to do a specific job efficiently, quickly, and economically!

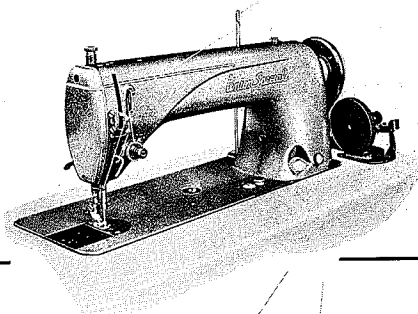

## THE 61400 LOCKSTITCH

Never before has a general purpose Lockstitch machine been so thoroughly engineered for handling modern industrial sewing requirements! And never has a machine offered more than the new Union Special SIXTY-ONE-FOUR — a superior machine for light or heavy weight work . . . for short runs as well as long . . . for tacking and back stitching . . . for curved seams and straight runs.

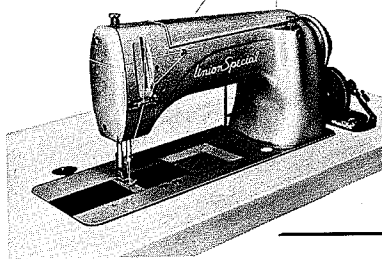

## NEEDLE FEED LOCKSTITCH MACHINES

Latest improvements in engineering, manufacturing methods, and materials have been combined in Union Special Class 61800 and Class 62200 needle feed Lockstitch machines providing operators with smooth, streamlined, light-running machines that reduce fatigue and strain. It's no wonder that manufacturers in plants throughout the country are praising the superior performance of these ultra-modern machines!

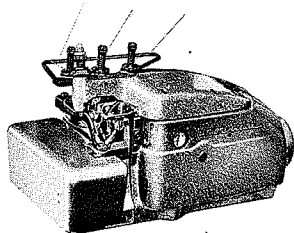

## THE NEW CLASS 39500 OVEREDGER

This new development antiquates every machine presently on the market for use where a curved needle machine is recommended. From its handsome, dynamically functional, modern design to its innermost mechanism, the THIRTY-NINE-FIVE has been produced to accelerate quicker . . . run faster . . . operate more smoothly and quietly . . . with less maintenance . . . and yield a greater profit than any other like equipment available to users today.

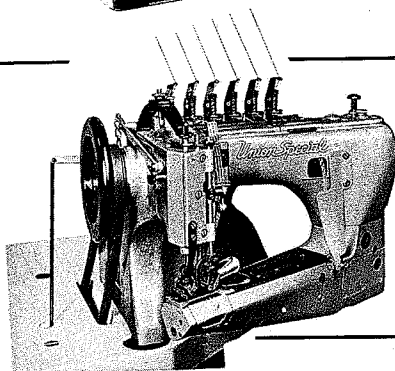

## 35700-35800 FEED-OFF-THE-ARM MACHINES

Union Special's popular feed-off-the-arm felling machines are light running, smooth operating machines that offer great advantages: sewing head of the latest type, new presser bar which practically eliminates feed marking, and presser foot which will lift at the lightest touch. Faster felling is certain with Union Special Class 35700-35800 feed-off-the-arm machines.