

Form 19740  
( 541 )  
Printed in U. S. A.

HISTORICAL COPY  
DO NOT REMOVE

LIST  
OF  
PARTS



FOR FAMILY SHOPS

MACHINES  
Nos. 127-12 and 127-14

\*\*\* A TRADE MARK OF  
THE SINGER MANUFACTURING COMPANY

## INDEX

---

	Page
Accessories.....	13
Attachment Set.....	13
Bias Gauge.....	13
Bobbin Winder (Automatic).....	13
Braider.....	14
Corder Bow.....	14
Feed Cover Plate.....	15
Feller (Foot).....	15
Finger Guard.....	15
Hemmers (Foot).....	15
Machine No. 127-12.....	7
Machine No. 127-14.....	11
Needle Threader (Universal).....	16
Numerical List of Parts.....	21
Presser Feet.....	16
Presser Foot with Graduated Adjustable Guides.....	16
Quilter.....	17
Ruffler Shirring Plate.....	17
Special Attachments.....	19
Under Braider.....	18

## INSTRUCTIONS FOR ORDERING

In ordering from this list, use ONLY the part NUMBER in the FIRST column.

The number stamped on a Sewing Machine Part is in every case the number of the single part only.

Every combination of parts sent out as such has its specific number, which, although not stamped on the parts, must be used when ordering the combination.

Each number always indicates the SAME PART in whatever list it appears, or for whatever machine.

The letters after some of the numbers indicate the style of finish only, as follows:

- A-Hardened, Polished, Nickel Plated and Buffed
- A.A-Buffered and Chromium Plated
- A.B-Hardened, Polished, Buffed and Chromium Plated
- A.C-Brown Baking Enamel Finish
- A.D-Gray Baking Enamel Finish
- A.E-Hardened, Bright Rumbled and Nickel Plated
- A.F-Hardened, Bright Rumbled, Nickel Plated, Bright Rumbled and Chromium Plated
- A.G-Alumilite, Plain
- A.H-Alumilite, Dyed
- A.J-Polished, Nickel Plated and Chromium Plated
- A.K-Hardened, Polished, Nickel Plated and Chromium Plated
- A.L-Heat Treated for Toughness
  - B-Polished, Nickel Plated and Buffed
  - C-Hardened Only
- C.R-Hardened and Merlized
  - D-Polished Only
  - E-Soft, Not Polished
  - F-Hardened and Polished
- F.J-Hardened, Polished and Nickel Plated
  - G-Bright Rumbled and Nickel Plated
  - H-Blued
- J-Nickel Plated Only
- K-Hardened and Nickel Plated
- L-Brass Plated
- M-Oxidized
- N-Japanned, Dull
- P-Japanned, Bright
- P.P-Wrinkle Finish
  - R-Merlized
  - S-Cadmium Plated
  - T-Copper Plated
- T.A-Hardened, Polished, Copper and Nickel Plated and Buffed
- T.B-Copper and Nickel Plated and Polished
- T.J-Copper and Nickel Plated Only
- T.K-Hardened, Copper and Nickel Plated
- T.L-Copper and Brass Plated
- T.M-Copper Plated and Oxidized

## INSTRUCTIONS FOR ORDERING - Continued

- U-Zinc Plated
  - V-Silver Plated
  - W-Polished and Nickel Plated
  - X-Black Oxide, for Iron and Steel
  - X.C-Hardened and Black Oxide, for Iron or Steel
  - Y-Black Nickel Plated Only
  - Z-Chromium Plated
  - Z.A-Hardened, Polished, Nickel Plated, Buffed and Chromium Plated
  - Z.B-Polished, Nickel Plated, Buffed and Chromium Plated
  - Z.C-Hardened and Chromium Plated
  - Z.D-Polished and Chromium Plated
  - Z.G-Bright Rumbled, Nickel Plated, Bright Rumbled and Chromium Plated
  - Z.J-Nickel and Chromium Plated
  - Z.Y-Copper and Chromium Plated
- These letters MUST BE USED when they appear in the list; and AFTER the number as in the list.

In this series:

1 to 1500, 50001 to 51500 and 140001 to 142000 are Screw Numbers

1501 to 1800 and 51501 to 51800 are Nut Numbers

1801 to 2000 and 51801 to 52000 are Roller Numbers

2001 to 50000 and 52001 to 140000 and 142001 to

190000 are Sewing Machine Parts, 190001 and upward are numbers of Electrical Parts.

The figures in the second column refer only to the plates, illustrating the parts, and are NOT TO BE USED in ordering.

Parts marked with an asterisk (\*) are furnished only when repairs are made at factory.

LIST OF PARTS COMPLETE  
FOR

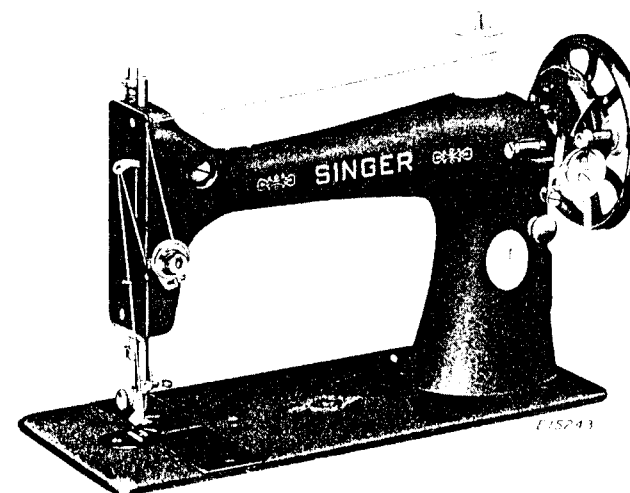

MACHINE No. 127-12

FOR FAMILY USE. VIBRATING SHUTTLE,  
WITH SHUTTLE EJECTOR.

No.	Plate	Name
*55530PP	----	Arm with 443A, 8206, 15404 and two 15405.
2002	23453	" Dowel Pin (2).....
8203E	23453	" Rock Shaft with 122E.....
55518	----	" " " 8203E with 520C and 1520E.
122E	23453	" " " Adjusting Screw.....
8204	23453	" " " Center (upper).....
301C	23453	" " " Screw Center.....
55516	----	" " " " " 301C with 1508E
1508E	23453	" " " " " Nut.....
649E	23453	" Screw (3).....
8341	23453	" Shaft.....
55524	----	" " 8341 with 2117, 8206 and 55523.
8206	23453	" " Bushing.....
443A	23453	" " " Set Screw.....
125425X	23453	" Side Cover (embossed).....
51224B	23453	" " " Thumb Screw.....
2007	23453	" Spool Pin.....
8879	23453	" " " Washer (cloth).....
15282	23453	Balance Wheel, 2 1/4 in. pulley.....
*8328PP	----	Bed.....
55515	23454	" Oil Hole (shuttle) Packing (braided cotton).....
256W	23453	Clamp Stop Motion Clamp Screw.....

## PARTS FOR MACHINE No. 127-12

No.	Plate	Name
248K	23453	Clamp Stop Motion Clamp Stop Screw.....
2020	23453	" " " " Washer.....
15313	23453	" " " Flanged Bushing with two 462AL.....
462AL	23453	Clamp Stop Motion Flanged Bushing Set Screw (2).....
15314	23453	Clamp Stop Motion complete, Nos. 248K, 256W, 2020 and 15313.....
8210X	23454	Face Plate with 125423.....
219A	23454	" " Screw (2).....
125422	23454	" " Thread Guard.....
125423	-----	" " " " 125422 with 125424.....
125424	23454	Face Plate Thread Guard Rivet.....
32562	23453	Feed Cam with 1285C.....
1285C	23453	" " Set Screw.....
8321	23454	" Dog, 12 teeth (16 teeth to the inch) 4 teeth right of needle (square corners) for 8323XC.....
8437E	23453	Feed Dog Carrier.....
1833	23453	" " " Roller and Screw Stud..
315C	23453	" " " Screw Center (2).....
15445	-----	" " " " 315C with 1519E (2).....
1519E	23453	Feed Dog Carrier Screw Center Nut (2)..
191C	23454	" " Screw.....
8348E	23453	" Forked Connection.....
8349	-----	" " " 8348E with 1832..
1381C	23453	" " " Hinge Screw (ec- centric).....
1520E	23453	Feed Forked Connection Hinge Screw Nut..
1832	23453	" " " Roller with 1085E
1085E	23453	" " " " Screw Stud
253W	23453	" Regulating Thumb Screw.....
8216	23453	" Regulator.....
8217	23453	" " Friction Washer.....
42E	23453	" " Hinge Screw.....
8334E	23453	" Rock Shaft.....
307C	23453	" " " Screw Center (2).....
56814	-----	" " " " 307C with 1513E (2).....
1513E	23453	Feed Rock Shaft Screw Center Nut (2)...
51045AL	23453	Machine Hinge Set Screw (2).....
8221D	23455	Needle Bar.....
8222	23455	" " Cam with 175E.....
55527	-----	" " " 8222 with 1836.....
175E	23455	" " " Clamping Screw.....
233E	23455	" " " Position Screw.....
1836	23455	" " " Roller and Screw Stud....
8338	23455	" " Thread Guard.....

## PARTS FOR MACHINE No. 127-12

No.	Plate	Name
249A	23455	Needle Bar Thread Guard and Needle Stop Screw.....
2054	23455	Needle Clamp with 552C.....
552C	23455	" " Thumb Screw.....
8224D	23455	Presser Bar.....
55507	23455	" " Guide Bracket with 453AL....
453AL	23455	" " " " Set Screw.....
54503AE	23455	" " Lifter.....
97E	23455	" " " Screw.....
8225	23455	" " Spring.....
2070	23455	" " Washer.....
8337	23455	" Foot.....
51224B	23455	" " Thumb Screw.....
263J	23455	Pressure Regulating Thumb Screw.....
8444E	23453	Shuttle Bell Crank.....
54523	23453	" " " 8444E with 50036E....
50036E	23453	" " " Hinge Screw.....
8228	23454	" Bobbin.....
215H	23454	" Tension Regulating Screw.....
8326	23454	" " Spring.....
54505	23454	Shuttle complete, Nos. 215H, 8228 and 8326
54527	23454	" Carrier with Cushion Spring.....
54507	23454	Shuttle Carrier complete, Nos. 50126E, 54510, 54511 and 54527.....
231K	23454	Shuttle Carrier Screw.....
54510	23454	" Ejector.....
50126E	23454	" " Hinge Screw.....
54511	23454	" " Spring.....
8232R	23453	" Pitman.....
44C	23453	" " Screw Stud.....
520C	23453	" " " " (eccentric)...
1520E	23453	" " " " " Nut
216C	23453	" " " " " Screw
55503X	23454	" Slide (back).....
55504X	23454	" " (front).....
2102	23454	Tension Disc (2).....
1560G	23454	" Regulating Thumb Nut.....
32572	23454	" Releasing Disc.....
55505	23455	" " Lever.....
55506	23455	" " " Hinge Pin.....
12329	23455	" " " Spring.....
54515	23454	" " Pin.....
1274J	23454	" Screw Stud.....
8238	23454	" Spring.....
55520	-----	Tension complete, Nos. 1274J, 1560G, 8238, 8244, 32572, 54515 and two 2102....
26075	23455	Thread Cutter and Holder.....
*55523	-----	" Take-up Cam.....
55521	23453	" " " 55523 with two 448AL (for Agents only).....

No.	Plate	Name
2117	-----	Thread Take-up Cam Pin.....
448AL	23453	" " " Set Screw (2).....
55526	23455	" " " Lever with 1822 and 50527C.....
50527C	23455	Thread Take-up Lever Hinge Screw.....
1822	23455	" " " Roller and Stud....
8244	23454	" " " Spring.....
54530	23454	" " " Regulator Plate...
233R	23454	" " " " " Ad- justing Screw.....
8323XC	23454	Throat Plate for 8321.....
219XC	23454	" " " Screw.....
*15404	-----	Trade Mark.....
15405	-----	" " " Rivet (2).....

## MACHINE No. 127-14

FOR FAMILY USE. VIBRATING SHUTTLE,  
WITH SHUTTLE EJECTOR.

THIS MACHINE IS THE SAME AS NO. 127-12 MACHINE WITH  
THE ADDITION OF THE FOLLOWING:

### HAND ATTACHMENT PARTS

No.	Plate	Name
94050	23456	Hand Attachment Body.....
94027	23456	" " " Bracket.....
183E	23456	" " " " Screw (2)
94028	23456	" " " Crank Handle (wood)....
94029	23456	" " " " Spindle....
94030	23456	" " " " " Flange (loose).....
94069	23456	Hand Attachment Crank Hinge Pin.....
94031	23456	" " " " Lever.....
94032	23456	" " " " Lock Pin.....
94033	23456	" " " " " Head
8282	23456	" " " " " " Spring.....
94034	-----	Hand Attachment Crank complete, Nos. 94028 to 94031.....
94046	23456	Hand Attachment Driver.....
94036	23456	" " " " Finger.....
94041	-----	" " " " " 94036 with SS567E, 94039 and 94040.....
94039	23456	Hand Attachment Driver Finger Driving Pad (rawhide).....
94040	23456	Hand Attachment Driver Finger Driving Pad Plate.....
SS567E	23456	Hand Attachment Driver Finger Driving Pad and Plate Binding Screw.....
94044	23456	Hand Attachment Driver Finger Hinge Pin.
94037	23456	" " " " " Latch.....
SS565E	23456	" " " " " " Screw Stud.....
94038	23456	Hand Attachment Driver Finger Latch Spring.....
94051	23456	Hand Attachment Gear with 8282, 94032 and 94033.....
94016	23456	Hand Attachment Gear Cover.....
399A	23456	" " " " " Screw (2)...
SS599F	23456	" " " " " Screw Stud.....

## PARTS FOR MACHINE No. 127-14

No.	Plate	Name
94048	23456	Hand Attachment Pinion.....
80028	23456	" " " Dowel Pin.....
SS600F	23456	" " " Screw Stud.....
94052	23456	Hand Attachment complete, Nos. SS565E, SS566C, SS599F, SS600F, 80028, 94016, 94027, 94034, 94037, 94038, 94041, 94044, 94046, 94048, 94050, 94051, 94069 and two each 183E and 399A.....
SS566C	23456	Hand Attachment Screw.....

## ACCESSORIES

No.	Plate	Name
120329	-----	Machine Cover.....
120862	23458	Oil Can, contents 1 1/3 fl. oz. (filled with household oil).....

## ATTACHMENT SET

No.	Plate	Name
121461	23457	Binder Folder.....
121463	23457	" Foot.....
51104B	23457	" Screw.....
120565	23457	" " Washer.....
121464	23457	Binder complete, Nos. 51104B, 120565, 121461 and 121463.....
8228	23457	Bobbin (four).....
36865	23457	Edge Stitcher.....
35931	23457	Hemmer (adjustable).....
120842	23457	" (foot) flat bottom, for 5/64 in. hem.....
-----	-----	Needles (six).....
121441	23457	Presser Foot (double toe) for gathering.
25537	23457	Screw Driver (machine).....
120378	23457	" " (shuttle tension).....
8879	23457	Spool Pin Washer (cloth).....
121900	-----	Attachment Set Nos. 8879, 25537, 35931, 36865, 120378, 120842, 121441, 121464, four 8228 and six needles.....
120598	23457	Ruffler for one, six and twelve stitch ruffling.....
121901	23457	Attachment Set complete, Nos. 120598 and 121900.....

## BIAS GAUGE

No.	Plate	Name
25525	23458	Bias Gauge.....

## BOBBIN WINDER (Automatic)

No.	Plate	Name
8342	6806	Back Center.....
8256	6806	" " Head.....

BOBBIN WINDER (Automatic)

No.	Plate	Name
8343	6806	Back Center Spring.....
55509	6806	Bracket (belt cover).....
158R	6806	" Screw.....
*8257	6806	Cam.....
50231A	6806	" Screw.....
55510	6806	Frame.....
55512	6806	" Friction Washer.....
50101B	6806	" Hinge Screw.....
1718J	6806	" " " Nut.....
15287	6806	Friction Ring (rubber).....
15288	6806	Pulley.....
50102A	6806	Spindle.....
8346	6806	Thread Guide.....
92B	6806	" " Hinge Screw.....
8260	6806	" " Spring.....
8261	6806	Worm Wheel.....
55514	6806	" " 8261 with 8257 and 50231A....
2749	6806	" " Friction Washer.....
50104B	6806	" " Screw Stud (eccentric).....
1718J	6806	" " " Nut.....
55511	6806	Bobbin Winder (automatic) complete, Nos. 92B, 2749, 8256, 8260, 8342, 8343, 8346, 15287, 15288, 50101B, 50102A, 50104B, 55509, 55510, 55512, 55514 and two 1718J.....

BRAIDER

No.	Plate	Name
25510	23459	Braider.....
289B	23459	" Thumb Screw.....

CORDER BOW

FOR TOP CORDING

No.	Plate	Name
26399	23459	Corder (bow) complete.....
190J	23459	" Screw.....

FEED COVER PLATE

No.	Plate	Name
8335	23458	Feed Cover Plate with 1423B and 8336, for art work.....
8336	23458	Feed Cover Plate Position Stud.....
1423B	23458	" " " Screw.....

FELLER (Foot)

No.	Plate	Name
36835	23459	Feller (foot).....

FINGER GUARD

No.	Plate	Name
121725	23459	Finger Guard.....

HEMMERS (Foot)

No.	Plate	Name
36333	23458	Hemmer (foot) 1/16 in. hem for chiffon and silk.....
36469	23458	Hemmer (foot) 1/32 in. hem for chiffon and silk, slotted for lace.....
25904	23458	Hemmer (foot) 1/16 in. hem for silk ties
25911	23458	" " 3/32 in. hem.....
120842	23457	" " flat bottom, 5/64 in. hem.
35884	23459	" " 3/16 in. hem.....
6267	----	" Folder.....
25888	----	" Tongue.....

Note: When ordering Nos. 6267 or 25888, give width  
of hem and No. of Hemmer for which it is re-  
quired.



## NEEDLE THREADER (Universal)

No.	Plate	Name
121632	23458	Needle Threader (universal).....
121631	23458	" " Hook.....
140157J	23458	" " " Screw.....

## PRESSER FOOT WITH GRADUATED ADJUSTABLE GUIDES

No.	Plate	Name
121717	23458	Presser Foot with 36696.....
35002	23458	" " Extension.....
35003	23458	" " Graduated Adjustable Guide (long, left).....
35004	23458	Presser Foot Graduated Adjustable Guide (long, right).....
35005	23458	Presser Foot Graduated Adjustable Guide (short, right).....
35006	23458	Presser Foot Graduated Adjustable Guide (short, right) flush.....
35135	23458	Presser Foot Graduated Adjustable Guide Clamp.....
35206	23458	Presser Foot Graduated Adjustable Guide Clamp Lever.....
337J	23458	Presser Foot Graduated Adjustable Guide Clamp Screw.....
36696	23458	Presser Foot Graduated Adjustable Guide Clamp Steady Pin.....
121718	23458	Presser Foot with Extension and Gradu- ated Adjustable Guides complete, Nos. 337J, 35002 to 35006, 35135, 35206 and 121717.....

## PRESSER FEET

No.	Plate	Name
15429	23459	Presser Foot (left toe) for stitching on edge and inserting cord.....
125035	23459	Presser Foot (right toe) for stitching on edge and inserting cord.....

## PRESSER FEET

No.	Plate	Name
121875	23459	Presser Foot for 121877.....
140347W	23459	" " Adjusting Thumb Screw for 121877.....
121876	23459	Presser Foot Body for 121877.....
121877	23459	Presser Foot (adjustable, for sewing either on the right or left side of the needle) complete, for cording and zipper work, Nos. 121875, 121876 and 140347W.....
28831	23458	Presser Foot for darning.....
121441	23457	" " (double toe) for gathering.
121614	23459	" " with 51282J and 121615, for blind stitch braiding, for soutache braid.....
121615	23459	Presser Foot Braid Guide.....
Note: When ordering Nos. 121614 or 121615, send sample of braid for which it is to be used.		
51282J	23459	Presser Foot Braid Guide Screw.....
36058	23459	" " with 665B and 36059, for blind stitch cording, to turn small curves.....
36059	23459	Presser Foot Cord Guide.....
Note: When ordering Nos. 36058 or 36059, send sample of cord for which it is to be used.		
665B	23459	Presser Foot Cord Guide Screw.....
8321	23459	Feed Dog, 12 teeth (16 teeth to the inch) 4 teeth right of needle (square corners) for 36060XC.....
36060XC	23459	Throat Plate for 8321, for 36058.....
36067	23459	Presser Foot, for braiding, for art work, for braid 1/16 in. to 3/16 in. wide.....
Note: When ordering No. 36067, state the size or send sample of the braid for which it is to be used.		

## QUILTER

No.	Plate	Name
35932	23459	Quilter.....

## RUFFLER SHIRRING PLATE

No.	Plate	Name
35934	23459	Ruffler Shirring Plate.....

## UNDER BRAIDER

No.	Plate	Name
121547	23458	Under Braider.....
25637	23458	" " Foot.....
51395W	----	" " Thumb Screw.....

SINGER Needles should be used  
in SINGER Machines.  
These Needles and their Containers  
are marked with the  
Company's Trade Mark "SIMANCO. \*\*\*" 1

Needles in Containers marked  
"FOR SINGER MACHINES"  
are NOT **SINGER** made needles. 2

## SPECIAL ATTACHMENTS

FOR COMPONENT PARTS OF THESE ATTACHMENTS,  
REFER TO FORM 19385, LIST OF PARTS FOR SINGER  
FASHION AIDS.

No.	Plate	Name
121795	----	Buttonhole Attachment complete.....
121094	----	Darning Foot (spring) complete.....
26538	----	Embroidery Attachment complete for one thread.....
35505	----	Embroidery Attachment complete for two threads.....
121387	----	Hemstitching and Picoting Attachment complete.....
121634	----	Needle Threader and Seam Ripper complete
121255	----	Singercraft Fagoter complete.....
121079	----	Singercraft Guide complete.....
35985	----	Tubular Trimming Attachment complete....
121706	----	Zigzag Attachment (adjustable) complete.

SINGER Needles should be used  
in SINGER Machines.  
These Needles and their Containers  
are marked with the  
Company's Trade Mark "SIMANCO. \*\*\*" 1

Needles in Containers marked  
"FOR SINGER MACHINES"  
are NOT **SINGER** made needles. 2

**NUMERICAL  
LIST  
OF PARTS**

## NUMERICAL LIST OF PARTS

No.	Plate	Name
42E	23453	Feed Regulator Hinge Screw.....
44C	23453	Shuttle Pitman Screw Stud.....
92B	6806	Bobbin Winder Thread Guide Hinge Screw for 55511.....
97E	23455	Presser Bar Lifter Screw.....
122E	23453	Arm Rock Shaft Adjusting Screw for 8203E
158R	6806	Bobbin Winder Bracket Screw.....
175E	23455	Needle Bar Cam Clamping Screw for 8222..
183E	23456	Hand Attachment Body Bracket Screw for 94052 (2).....
190J	23459	Corder Screw.....
191C	23454	Feed Dog Screw.....
215H	23454	Shuttle Tension Regulating Screw for 54505.....
216C	23453	Shuttle Pitman Screw Stud (eccentric) Screw.....
219A	23454	Face Plate Screw (2).....
219XC	23454	Throat Plate Screw.....
231K	23454	Shuttle Carrier Screw.....
233E	23455	Needle Bar Cam Position Screw.....
233R	23454	Thread Take-up Spring Regulator Plate Adjusting Screw.....
248K	23453	Clamp Stop Motion Clamp Stop Screw for 15314.....
249A	23455	Needle Bar Thread Guard and Needle Stop Screw.....
253W	23453	Feed Regulating Thumb Screw.....
256W	23453	Clamp Stop Motion Clamp Screw for 15314
263J	23455	Pressure Regulating Thumb Screw.....
289B	23459	Braider Thumb Screw.....
301C	23453	Arm Rock Shaft Screw Center for 55516...
307C	23453	Feed Rock Shaft Screw Center for 56814 (2).....
315C	23453	Feed Dog Carrier Screw Center for 15445 (2).....
337J	23458	Presser Foot Graduated Adjustable Guide Clamp Screw for 121718.....
399A	23456	Hand Attachment Gear Cover Screw for 94052 (2).....
443A	23453	Arm Shaft Bushing Set Screw for 55530FP.
448AL	23453	Thread Take-up Cam Set Screw for 55521 (2).....
453AL	23455	Presser Bar Guide Bracket Set Screw for 55507.....
462AL	23453	Clamp Stop Motion Flanged Bushing Set Screw for 15313 (2).....

NUMERICAL

LIST

OF PARTS

No.	Plate	Name
520C	23453	Shuttle Pitman Screw Stud (eccentric) for 55518.....
552C	23455	Needle Clamp Thumb Screw for 2054.....
SS565E	23456	Hand Attachment Driver Finger Latch Screw Stud for 94052.....
SS566C	23456	Hand Attachment Screw for 94052.....
SS567E	23456	" " Driver Finger Driving Pad and Plate Binding Screw for 94041...
SS599F	23456	Hand Attachment Gear Screw Stud for 94052.....
SS600F	23456	Hand Attachment Pinion Screw Stud for 94052.....
649E	23453	Arm Screw (3).....
665B	23459	Presser Foot Cord Guide Screw for 36058.
1085E	23453	Feed Forked Connection Roller Screw Stud for 1832.....
1274J	23454	Tension Screw Stud for 55520.....
1285C	23453	Feed Cam Set Screw for 32562.....
1381C	23453	Feed Forked Connection Hinge Screw (eccentric).....
1423B	23458	Feed Cover Plate Screw for 8335.....
1508E	23453	Arm Rock Shaft Screw Center Nut for 55516.....
1513E	23453	Feed Rock Shaft Screw Center Nut for 56814 (2).....
1519E	23453	Feed Dog Carrier Screw Center Nut for 15445 (2).....
1520E	23453	Feed Forked Connection Hinge Screw Nut..
1520E	23453	Shuttle Pitman Screw Stud (eccentric) Nut for 55518.....
1560G	23454	Tension Regulating Thumb Nut for 55520..
1718J	6806	Bobbin Winder Frame Hinge Screw Nut for 55511.....
1718J	6806	Bobbin Winder Worm Wheel Screw Stud Nut for 55511.....
1822	23455	Thread Take-up Lever Roller and Stud for 55526.....
1832	23453	Feed Forked Connection Roller with 1085E, for 8349.....
1833	23453	Feed Dog Carrier Roller and Screw Stud..
1836	23455	Needle Bar Cam Roller and Screw Stud for 55527.....
2002	23453	Arm Dowel Pin (2).....
2007	23453	" Spool Pin.....
2020	23453	Clamp Stop Motion Clamp Washer for 15314
2054	23455	Needle Clamp with 552C.....
2070	23455	Presser Bar Spring Washer.....
2102	23454	Tension Disc for 55520 (2).....
2117	-----	Thread Take-up Cam Pin for 55524.....
2749	6806	Bobbin Winder Worm Wheel Friction Washer for 55511.....

No.	Plate	Name
6267	-----	Hemmer Folder.....
Note: When ordering No. 6267, give width of hem and No. of Hemmer for which it is required.		
8203E	23453	Arm Rock Shaft with 122E, for 55518.....
8204	23453	" " " Center (upper).....
8206	23453	" Shaft Bushing for 55524 and 55530PP.
8210X	23454	Face Plate with 125423.....
8216	23453	Feed Regulator.....
8217	23453	" " Friction Washer.....
8221D	23455	Needle Bar.....
8222	23455	" " Cam with 175E, for 55527.....
8224D	23455	Presser Bar.....
8225	23455	" " Spring.....
8228	23457	Bobbin for 121900 (four).....
8223	23454	Shuttle Bobbin for 54505.....
8232R	23453	" Pitman.....
8238	23454	Tension Spring for 55520.....
8244	23454	Thread Take-up Spring for 55520.....
8256	6806	Bobbin Winder Back Center Head for 55511
*8257	6806	" " Cam for 55514.....
8260	6806	" " Thread Guide Spring for 55511.....
8261	6806	Bobbin Winder Worm Wheel for 55514.....
8282	23456	Hand Attachment Crank Lever Lock Pin Spring for 94051.....
8321	23454	Feed Dog, 12 teeth (16 teeth to the inch) 4 teeth right of needle (square corners) for 8323XC and 3606XC.....
8323XC	23454	Throat Plate for 8321.....
8326	23454	Shuttle Tension Spring for 54505.....
*8328PP	-----	Bed.....
8334E	23453	Feed Rock Shaft.....
8335	23458	" Cover Plate with 1423B and 8336, for art work.....
8336	23458	Feed Cover Plate Position Stud for 8335.
8337	23455	Presser Foot.....
8338	23455	Needle Bar Thread Guard.....
8341	23453	Arm Shaft for 55524.....
8342	6806	Bobbin Winder Back Center for 55511.....
8343	6806	" " " " Spring for 55511.....
8346	6806	Bobbin Winder Thread Guide for 55511....
8348E	23453	Feed Forked Connection for 8349.....
8349	-----	" " " 8348E with 1832..
8437E	23453	" Dog Carrier.....
8444E	23453	Shuttle Bell Crank for 54523.....
8879	23453	Arm Spool Pin Washer (cloth).....
8879	23457	Spool Pin Washer (cloth) for 121900.....
12329	23455	Tension Releasing Lever Spring.....
15282	23453	Balance Wheel, 2 1/4 in. pulley.....

## NUMERICAL LIST OF PARTS

No.	Plate	Name
55507	23455	Presser Bar Guide Bracket with 453AL....
55509	6806	Bobbin Winder Bracket (belt cover) for 55511.....
55510	6806	Bobbin Winder Frame for 55511.....
55511	6806	Bobbin Winder (automatic) complete, Nos. 92B, 2749, 8256, 8260, 8342, 8343, 8346, 15287, 15288, 50101B, 50102A, 50104B, 55509, 55510, 55512, 55514 and two 1718J.....
55512	6806	Bobbin Winder Frame Friction Washer for 55511.....
55514	6806	Bobbin Winder Worm Wheel 8261 with 8257 and 50231A, for 55511.....
55515	23454	Bed Oil Hole (shuttle) Packing (braided cotton).....
55516	-----	Arm Rock Shaft Screw Center 301C with 1508E.....
55518	-----	Arm Rock Shaft 8203E with 520C and 1520E
55520	-----	Tension complete, Nos. 1274J, 1560G, 8238, 8244, 32572, 54515 and two 2102.....
55521	23453	Thread Take-up Cam 55523 with two 448AL (for Agents only).....
*55523	-----	Thread Take-up Cam for 55521 and 55524..
55524	-----	Arm Shaft 8341 with 2117, 8206 and 55523
55526	23455	Thread Take-up Lever with 1822 and 50527C.....
55527	-----	Needle Bar Cam 8222 with 1836.....
*55530PP	-----	Arm with 443A, 8206, 15404 and two 15405
56814	-----	Feed Rock Shaft Screw Center 307C with 1513E (2).....
80028	23456	Hand Attachment Pinion Dowel Pin for 94052.....
94016	23456	Hand Attachment Gear Cover for 94052....
94027	23456	" " Body Bracket for 94052..
94028	23456	" " Crank Handle (wood) for 94034.....
94029	23456	Hand Attachment Crank Handle Spindle for 94034.....
94030	23456	Hand Attachment Crank Handle Spindle Flange (loose) for 94034.....
94031	23456	Hand Attachment Crank Lever for 94034...
94032	23456	" " " " Lock Pin for 94051.....
94033	23456	Hand Attachment Crank Lever Lock Pin Head for 94051.....
94034	-----	Hand Attachment Crank complete for 94052, Nos. 94028 to 94031.....
94036	23456	Hand Attachment Driver Finger for 94041.
94037	23456	" " " " Latch for 94052.....

No.	Plate	Name
94038	23456	Hand Attachment Driver Finger Latch Spring for 94052.....
94039	23456	Hand Attachment Driver Finger Driving Pad (rawhide) for 94041.....
94040	23456	Hand Attachment Driver Finger Driving Pad Plate for 94041.....
94041	-----	Hand Attachment Driver Finger 94036 with SS567E, 94039 and 94040, for 94052..
94044	23456	Hand Attachment Driver Finger Hinge Pin for 94052.....
94046	23456	Hand Attachment Driver for 94052.....
94048	23456	" " Pinion for 94052.....
94050	23456	" " Body for 94052.....
94051	23456	" " Gear with 8282, 94032 and 94033, for 94052.....
94052	23456	Hand Attachment complete for 127-14 Machine, Nos. SS565E, SS566C, SS599F, SS600F, 80028, 94016, 94027, 94034, 94037, 94038, 94041, 94044, 94046, 94048, 94050, 94051, 94069 and two each 183E and 399A.....
94069	23456	Hand Attachment Crank Hinge Pin for 94052.....
120329	-----	Machine Cover (Accessories).....
120378	23457	Screw Driver (shuttle tension) for 121900.....
120565	23457	Binder Screw Washer for 121464.....
120598	23457	Ruffler for one, six and twelve stitch ruffling, for 121901.....
120842	23457	Hemmer (foot) flat bottom, for 5/64 in. hem for 121900.....
120862	23458	Oil Can, contents 1 1/3 fl. oz. (filled with household oil) Accessories...
121079	-----	Singercraft Guide complete.....
121094	-----	Darning Foot (spring) complete.....
121255	-----	Singercraft Fagoter complete.....
121387	-----	Hemstitching and Picoting Attachment complete.....
121441	23457	Presser Foot (double toe) for gathering for 121900.....
121461	23457	Binder Folder for 121464.....
121463	23457	" Foot for 121464.....
121464	23457	Binder complete for 121900, Nos. 51104B, 120565, 121461 and 121463.....
121547	23458	Under Braider.....
121614	23459	Presser Foot with 51282J and 121615, for blind stitch braiding, for soutache braid.....
121615	23459	Presser Foot Braid Guide for 121614

Note: When ordering Nos. 121614 or 121615, send sample of braid for which it is to be used.

## NUMERICAL LIST OF PARTS

No.	Plate	Name
121631	23458	Needle Threader Hook for 121632.....
121632	23458	" " (universal).....
121634	-----	" " and Seam Ripper complete
121706	-----	Zigzag Attachment (adjustable) complete.
121717	23458	Presser Foot with 36696, for 121718.....
121718	23458	Presser Foot with Extension and Gradu- ated Adjustable Guides complete, Nos. 337J,35002 to 35006, 35135,35206 and 121717.....
121725	23459	Finger Guard.....
121795	-----	Buttonhole Attachment complete.....
121875	23459	Presser Foot for 121877.....
121876	23459	" " Body for 121877.....
121877	23459	Presser Foot (adjustable, for sewing either on the right or left side of the needle) complete, for cording and zipper work, Nos. 121875, 121876 and 140347W.....
121900	-----	Attachment Set for 121901, Nos. 2279, 25537, 35931, 36865, 120378, 120842, 121441, 121464, four 8228 and six needles.....
121901	23457	Attachment Set complete, Nos. 120598 and 121900.....
125035	23459	Presser Foot (right toe) for stitching on edge and inserting cord.....
125422	23454	Face Plate Thread Guard for 125423.....
125423	-----	" " " " 125422 with 125424, for 8210X.....
125424	23454	Face Plate Thread Guard Rivet for 125423
125425X	23453	Arm Side Cover (embossed).....
140157J	23458	Needle Threader Hook Screw for 121632...
140347W	23459	Presser Foot Adjusting Thumb Screw for 121877.....

## ILLUSTRATIONS OF PARTS

QTY	NO	DESCRIPTION
1	55511	...
1	55512	...
1	55513	...
1	55514	...
1	55515	...
1	55516	...
1	55517	...
1	55518	...
1	55519	...
1	55520	...
1	55521	...
1	55522	...
1	55523	...
1	55524	...
1	55525	...
1	55526	...
1	55527	...
1	55528	...
1	55529	...
1	55530	...
1	55531	...
1	55532	...
1	55533	...
1	55534	...
1	55535	...
1	55536	...
1	55537	...
1	55538	...
1	55539	...
1	55540	...
1	55541	...
1	55542	...
1	55543	...
1	55544	...
1	55545	...
1	55546	...
1	55547	...
1	55548	...
1	55549	...
1	55550	...
1	55551	...
1	55552	...
1	55553	...
1	55554	...
1	55555	...
1	55556	...
1	55557	...
1	55558	...
1	55559	...
1	55560	...
1	55561	...
1	55562	...
1	55563	...
1	55564	...
1	55565	...
1	55566	...
1	55567	...
1	55568	...
1	55569	...
1	55570	...
1	55571	...
1	55572	...
1	55573	...
1	55574	...
1	55575	...
1	55576	...
1	55577	...
1	55578	...
1	55579	...
1	55580	...
1	55581	...
1	55582	...
1	55583	...
1	55584	...
1	55585	...
1	55586	...
1	55587	...
1	55588	...
1	55589	...
1	55590	...
1	55591	...
1	55592	...
1	55593	...
1	55594	...
1	55595	...
1	55596	...
1	55597	...
1	55598	...
1	55599	...
1	55600	...

ILLUSTRATIONS  
OF  
PARTS

QTY	NO	DESCRIPTION
1	55511	...
1	55512	...
1	55513	...
1	55514	...
1	55515	...
1	55516	...
1	55517	...
1	55518	...
1	55519	...
1	55520	...
1	55521	...
1	55522	...
1	55523	...
1	55524	...
1	55525	...
1	55526	...
1	55527	...
1	55528	...
1	55529	...
1	55530	...
1	55531	...
1	55532	...
1	55533	...
1	55534	...
1	55535	...
1	55536	...
1	55537	...
1	55538	...
1	55539	...
1	55540	...
1	55541	...
1	55542	...
1	55543	...
1	55544	...
1	55545	...
1	55546	...
1	55547	...
1	55548	...
1	55549	...
1	55550	...
1	55551	...
1	55552	...
1	55553	...
1	55554	...
1	55555	...
1	55556	...
1	55557	...
1	55558	...
1	55559	...
1	55560	...
1	55561	...
1	55562	...
1	55563	...
1	55564	...
1	55565	...
1	55566	...
1	55567	...
1	55568	...
1	55569	...
1	55570	...
1	55571	...
1	55572	...
1	55573	...
1	55574	...
1	55575	...
1	55576	...
1	55577	...
1	55578	...
1	55579	...
1	55580	...
1	55581	...
1	55582	...
1	55583	...
1	55584	...
1	55585	...
1	55586	...
1	55587	...
1	55588	...
1	55589	...
1	55590	...
1	55591	...
1	55592	...
1	55593	...
1	55594	...
1	55595	...
1	55596	...
1	55597	...
1	55598	...
1	55599	...
1	55600	...

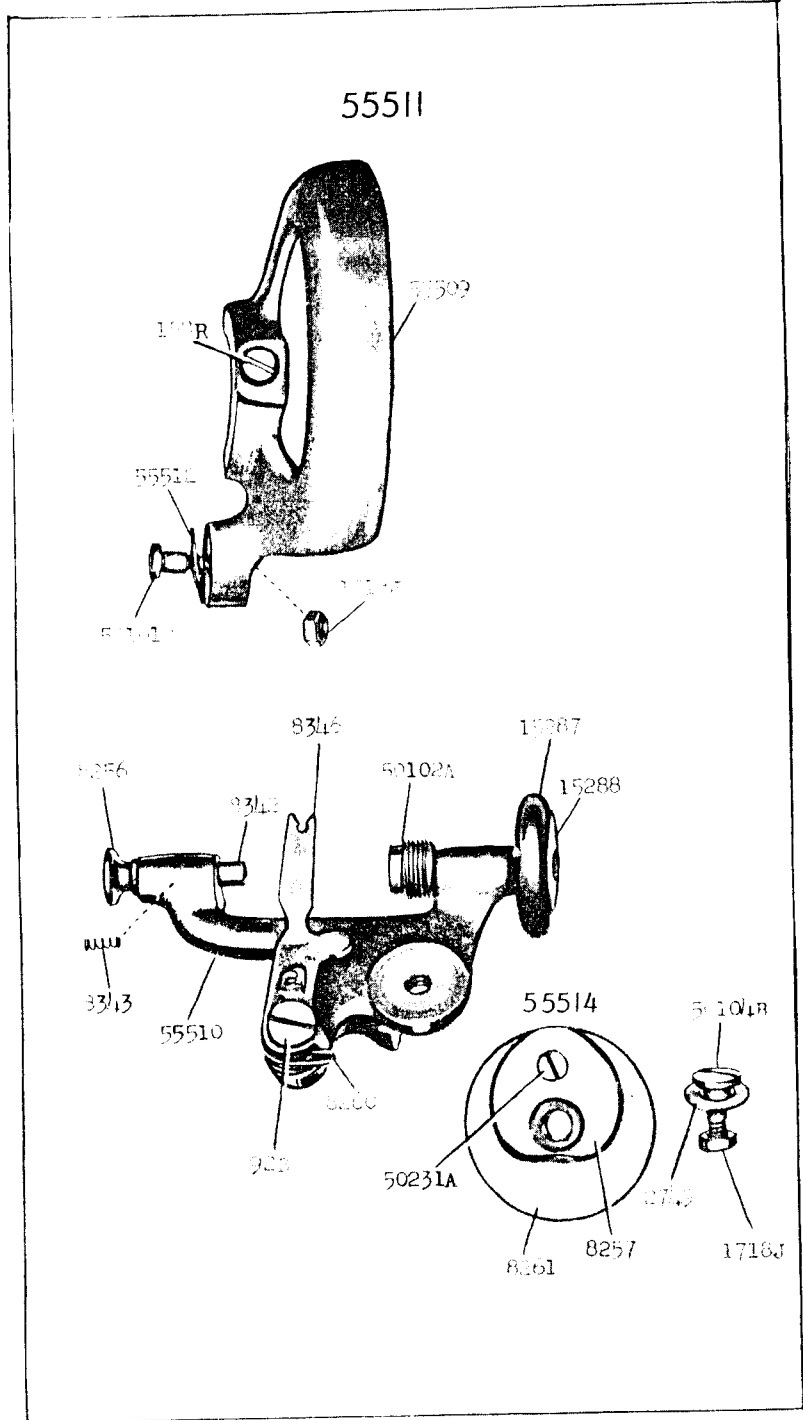



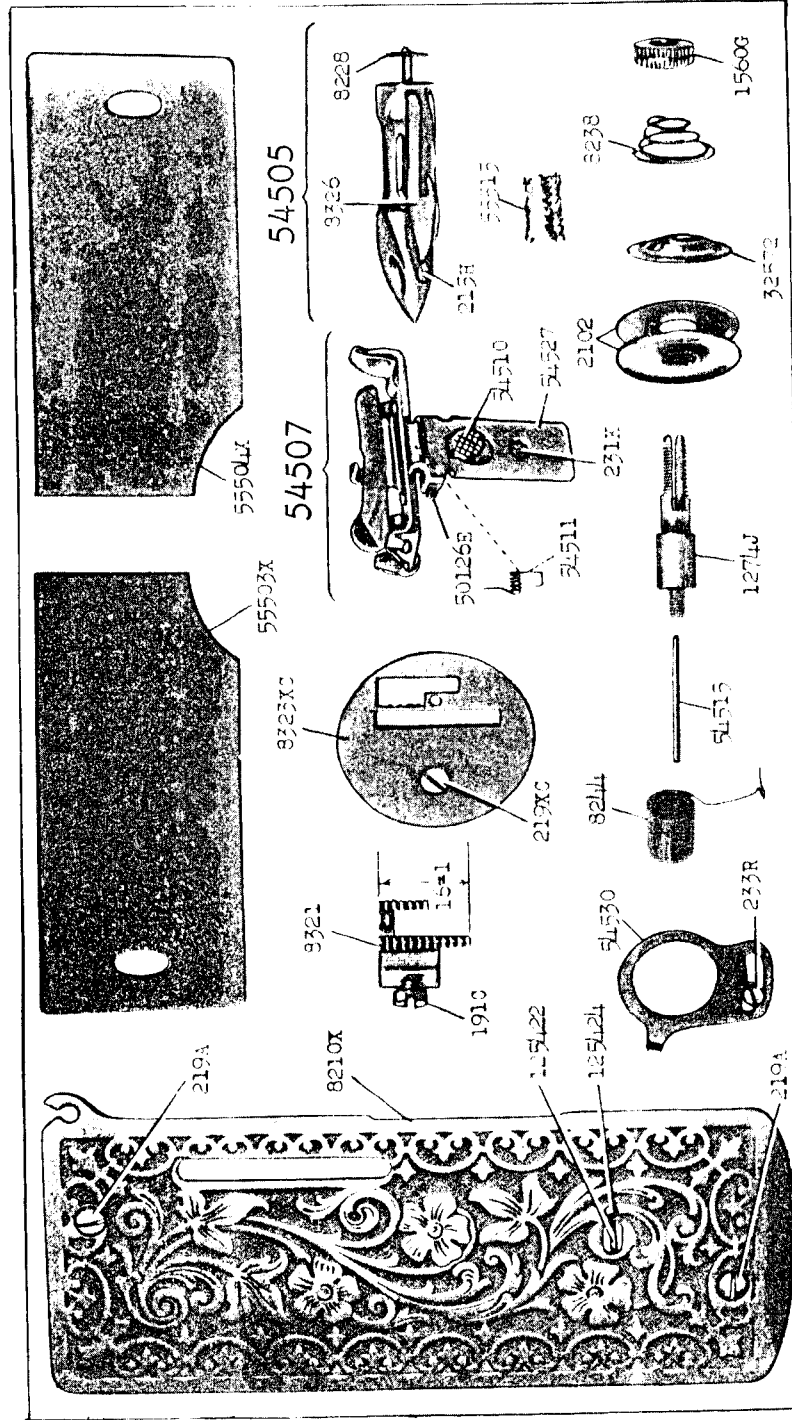
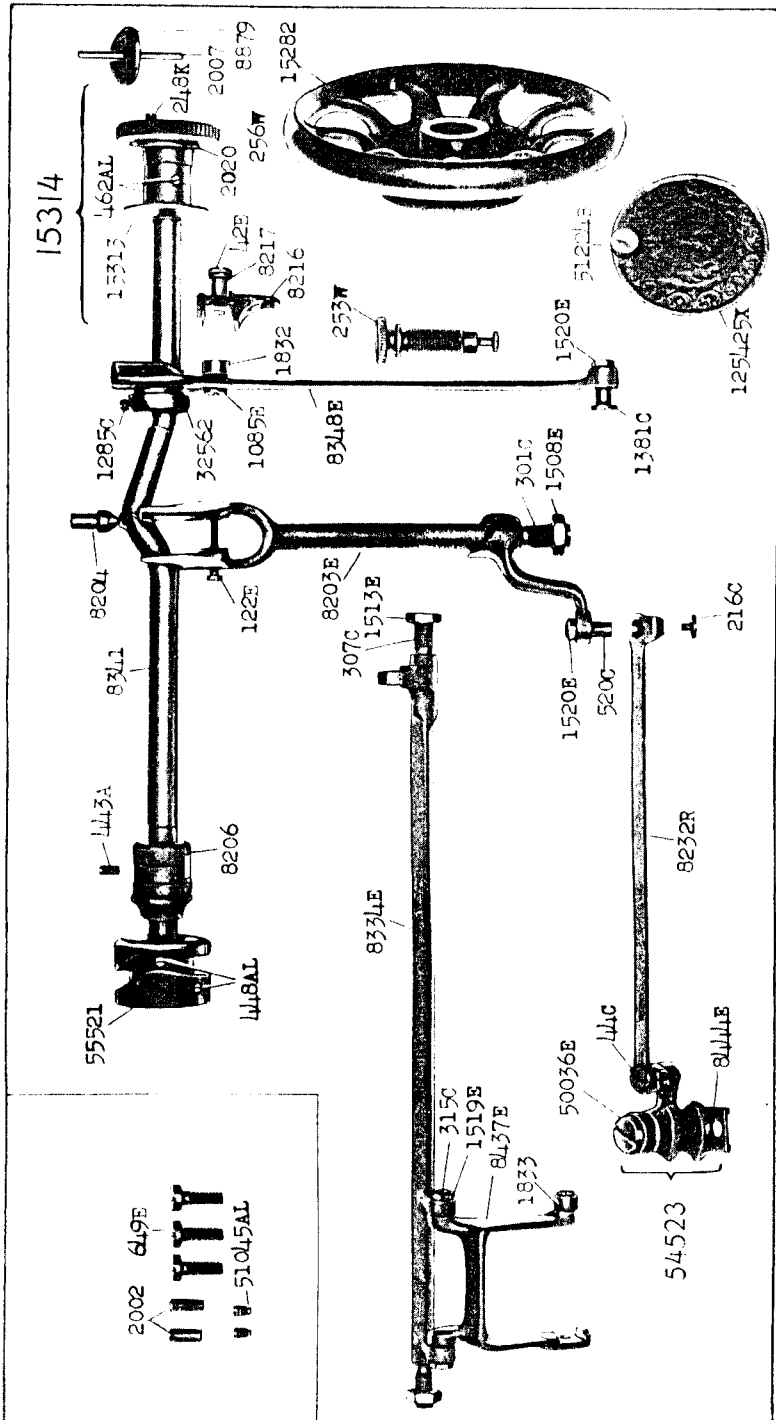



23457 - 1/2

121901

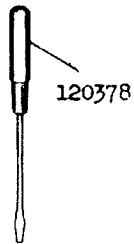
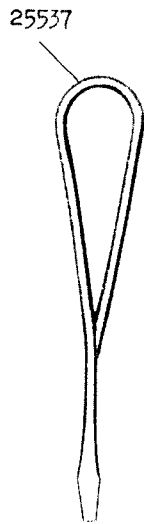
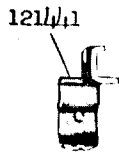
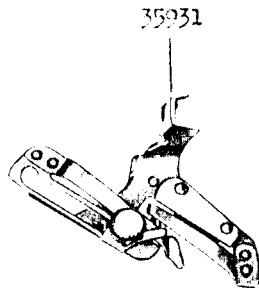
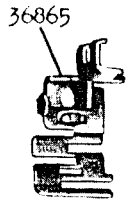
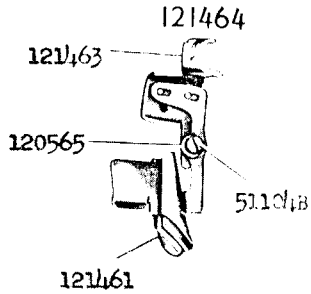
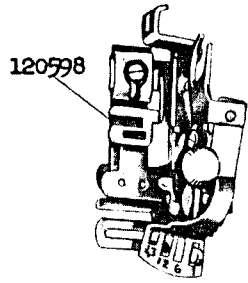

8228

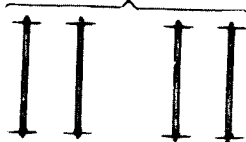

23458 - 1/2

8335

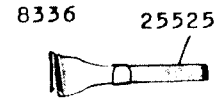
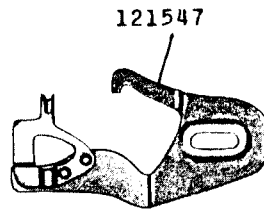
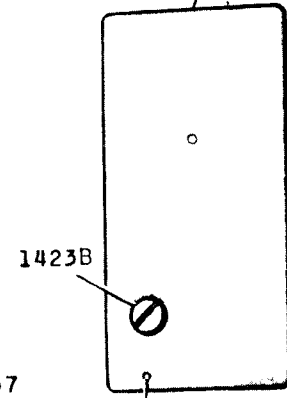

121632

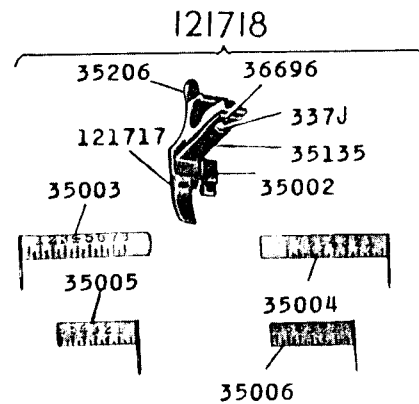
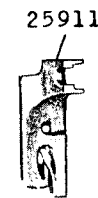
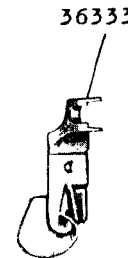
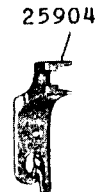
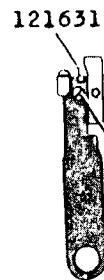

35006

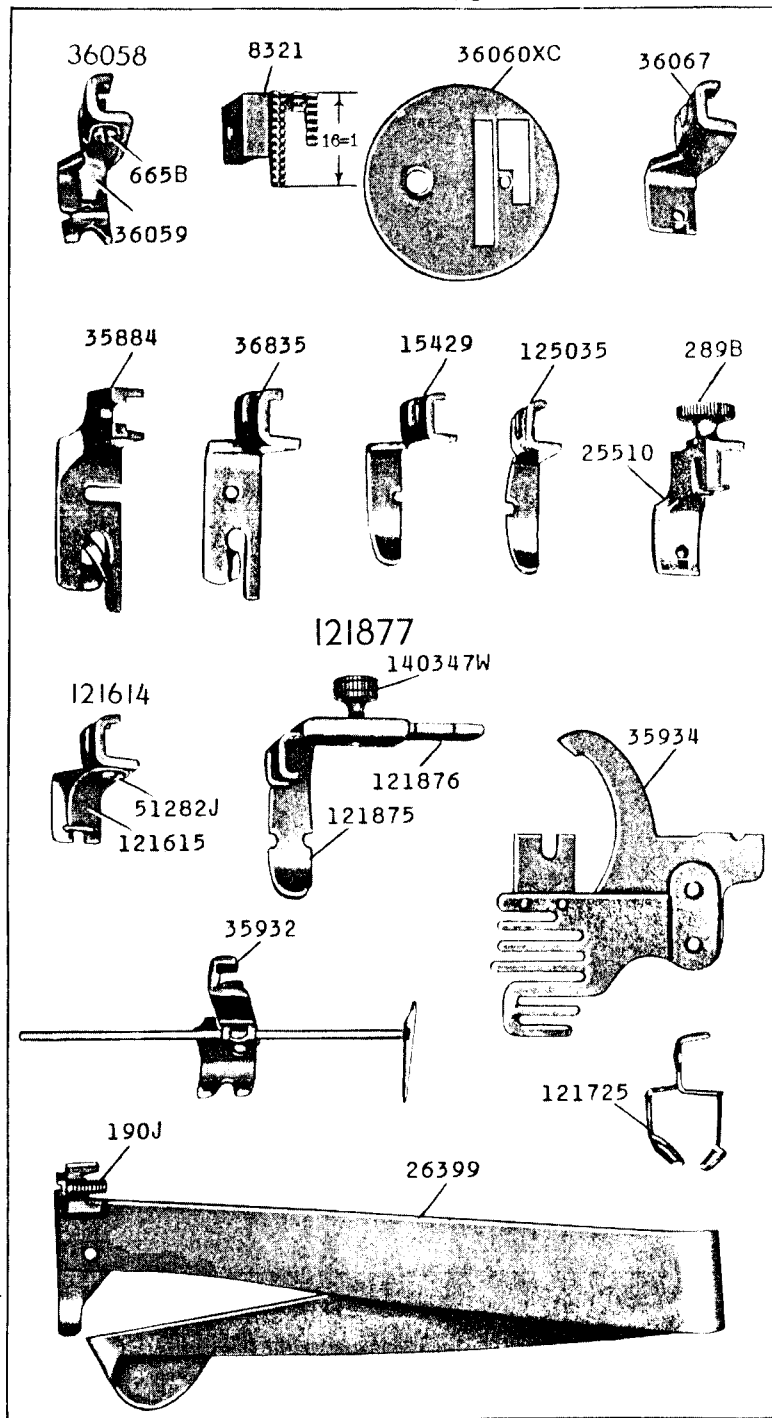

June 7, 1943

Department #54

RECEIVED  
JUN 10 1943  
U. S. DEPARTMENT OF THE ARMY  
OFFICE OF THE QUARTERMASTER GENERAL  
WASHINGTON, D. C.

List of Parts Complete

-200-

Machine No. 116-2

List of Parts Complete  
for  
Machine No. 116-2

No.	Name
*125001	Arm
*125002	" 125001 with 435AL, 448AL, 15404, 15486, 15498 and two 15405
2002	Arm Dowel Pin
138 E	" Screw
125003	" Shaft
125004	" " 125003 with 15433, 15498 and 125022
15498	" " Bushing
435 AL	" " " Set Screw
144 D	" " Screw
15196	" Side Cover
51224 W	" " " Thumb Screw
52239	" Spool Pin and Thread Eyelet
8679	" " " Washer (cloth)
2138	Balance Wheel (power) light rim, 2 3/4 in. pulley, with two 448AL
448 AL	Balance Wheel Set Screw
*63501	Bed
63502	Clamp Arm
63503	" " Bracket
63560	" " Hinge Block with 735AL
63505	" " " " Pin
735 AL	" " " " " Set Screw
219 D	" " " " Screw
203 J	" " Screw
63561	" Carrier with 51215
63507	" " Cap
219 D	" " " Screw
63562	" " Lever
63563	" " " Connecting Link

66 C	Clamp Carrier Lever Connecting Link Hinge Screw
660 D	" " " Hinge Screw
63564	" " Regulator with 1877
52877 F	" " " Hinge Stud
448 AL	" " " " " Set Screw
63565	" " " Plate
63566	" " " " Indicator
665 D	" " " " Screw
1877	" " " Roller and Screw Stud
1236 C	" " " Screw Stud
7070	" " " " " Sleeve
1658 J	" " " " " Thumb Nut
51815	" " Roller and Screw Stud
63567	" Check
50335 C	" " Hinge Screw
63512	" Pressure Arm
203 J	" " " Screw
51816	" " Roller and Stud
63513	" " " Bracket with 453AL and 51816
453 AL	" " " " Set Screw
63514	" Spring
2811	Crank Connecting Rod with two 159E
159 E	" " " Cap Screw
375 C	" " " Hinge Screw
1518 E	" " " " " Nut
2866	Face Plate
63515	Face Plate complete, Nos. 448AL, 460AL, 600C, 1560C, 2103, 2105, 2107, 2111, 2127, 2269, 2866, 2870, 53645 and two each 233D and 2102
2107	Face Plate Thread Guard
233 D	" " " " Screw
190 D	" " Screw
125032	Feed Cam

2039		Feed Connecting Link
378 C	"	" " " Hinge Screw
1520 E	"	" " " " " Nut
17042	"	Eccentric with 448AL
448 AL	"	" " Set Screw
63516	"	Forked Connection
378 C	"	" " " Hinge Screw
1520 E	"	" " " " " Nut
63517	"	Regulator
50353 E	"	" " Hinge Screw
8217	"	" " " " Friction Washer
747 D	"	" " " Thumb Screw
63518	"	Rock Shaft
63519		Feed Rock Shaft complete, Nos. 63518 and 63520
63520	"	" " " Crank with 157E
157 E	"	" " " " Clamping Screw
307 C	"	" " " Screw Center
1513 J	"	" " " " " Nut
63521	"	Wheel
63522	"	" " Driving Lever
63523	"	" " " " Block
63524	"	" " " " " Cap
257 D	"	" " " " " Screw
63525	"	" " " " " Spring
234 D	"	" " " " " Screw
63526	"	" " " " Link
870 F	"	" " " " " Hinge Screw for 63522
50336 F	"	" " " " " " " 63518
1521 E	"	" " " " " " Nut for 50336
50337 C	"	" " Hinge Screw
1518 E	"	" " " " Nut
2718	"	" " " " Washer



63527		Feed Wheel Retaining Clutch
63528	" " " "	Bracket
180 D	" " " "	" " Screw
63529	" " " "	Cap
211 D	" " " "	" " Screw
63530	" " " "	Spring
229 D	" " " "	" " Screw
63568		Guide
1209 C	"	Screw
23390	" "	Washer
2050		Needle Bar
*15248	" "	Connecting Link with 51002E
51002 E	" "	" " Adjusting Screw
570 C	" "	" " Hinge Screw
1520 E	" "	" " " " Nut
2052	" "	" " Stud with 1550
155 C	" "	" " Set Screw
290 E	" "	Screw Bushing
15068	" "	Thread Guard
251 F	" "	" " Screw
15069	"	Clamp with 246F
246 F	" "	Screw
*63532		Oscillating Rock Shaft with 4784
3042	" " " "	Hinge Pin
1513 J	" " " "	" " Nut
635 C	" " " "	" " Screw Bearing
1513 J	" " " "	" " " " Nut
4784	" " " "	Oil Pad (felt)
63533	"	Shaft
15163	" "	Crank for 15164
15426	" " " "	" " 15165
*15164		Oscillating Shaft Crank complete, Nos. 4320, 15165, 15168 and 15171

15165	Oscillating Shaft Crank complete, Nos. 1519E, 15171, 15426 and two 462AL
2049	Oscillating Shaft Crank Pin
462 AL	" " " Set Screw
15170	" " " Slide Block
226 J	" " " " " Cap Screw
12424	" " " " " " Washer
1035 C	" " " " " Screw Stud
1519 E	" " " " " " Nut
15171	Oscillating Shaft Crank Slide Block complete, Nos. 226J, 1035C, 12424 and 15170
63534	Presser Bar
2062	" " Lifter
15486	" " " Hinge Stud
448 AL	" " " " " Set Screw
2952	" " Lifting Bracket with 453AL
453 AL	" " " " " Set Screw
290 E	" " Screw Bushing
2308	" " Spring
2070	" " " Washer
263 J	Pressure Regulating Thumb Screw
2996	Shuttle Bobbin
33941	" " Case
15140	" " " Latch
2973	" " " " Lever
2974	" " " " " Fulcrum Pin
2975	" " " " " Spring
592 E	" " " " " Stop Screw
15141	Shuttle Bobbin Case Hinge, Nos. 2973, 2974 and 15140
7553	" " " Position Finger
2523	" " " " " Rivet
33942	Shuttle Bobbin Case complete, Nos. 591F, 592E, 2523, 2975, 7553, 15141, 15273 and 33941

2515	Shuttle Body
591 F	" Tension Regulating Screw
15278	" " Spring
63535	" 1 11/16 in. diam., Nos. 2515, 2996 and 33942
*2542	" Driver
2441	" " 2542 with two 462AL
2049	" " Pin
462 AL	" " Set Screw
63536	" Race Back
2532	" " " Position Pin
2533	" " " Spring
648 J	" " " " Screw
63537	" " Body with 11193
63538	" " Cap
335 D	" " " Screw
63539	" " Cover
63540	" " " 63539 with 63541 and two 26092
63541	" " " Bracket
21516	" " " " Hinge Pin
26092	" " " " Rivet
63542	" " " Spring
330 D	" " " " Screw
11195	" " Latch Pin Steady Pin
145 D	" " Screw
63543	Shuttle Race complete, Nos. 330D, 648J, 2533, 21516, 63538 to 63539, 63540, 63542 and two each 335D and 2532
2102	Tension Disc
1560 C	" Regulating Thumb Nut
2370	" Releaser
2269	" " Hinge Pin
600 C	" Screw Stud
448 AL	" " " Set Screw

2103	Tension Spring
2105	" Thread Guard
2112	Thread Retaining Disc with 2113
2113	" " " Steady Pin
2114	" " Spring
2115	" " Stud
460 AL	" " " Set Screw
2111	Thread Retainer Guide complete, Nos. 2112, 2114 and 2115
15275	" Take-up Cam with 1293AL
*15433	" " " 15275 with 570C and 1520E
1293 AL	" " " Position Screw
*15491	" " Lever with 1322
50527 C	" " " Hinge Screw
1822	" " " Roller and Stud
55645	" " Spring
2127	" " " Regulator Plate
233 D	" " " " " Adjusting Screw
*15404	Trade Mark
15405	" " Rivet