

GRIFFA PRINCIPALE
MAIN FEED DOG
GRIFFE PRINCIPALE
HAUPT-TRANSPORTEUR

Rumoldi

GRIFFA PRINCIP.

MAIN FEED DOG

GRIFFE PRINCIPALE

HAUPTTRANSPORTEUR

Indice	TAB	R300
Data	Foglio 1	Segue F. 2

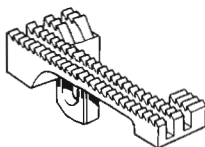
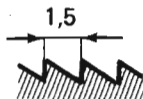
200758-0-10

Serve per
Serves for
Pour machines
Dient fuer

023-04-01
023-04-03
023-04-04

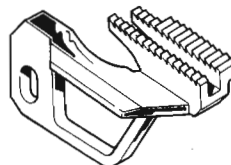
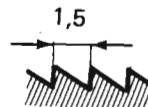
202053-0-10

Serve per
Serves for
Pour machines
Dient fuer

327-00-1CD-01
327-01-1CD-01
327-01-1CD-02
327-28-1CD-02
327-29-1CD-01
327-29-1CD-02
327-29-1CD-03
028-00-01
028-01-01
028-01-02
028-28-01
028-28-02
028-29-01
028-29-02
028-29-03
228-00-01
228-01-01
228-28-01
228-28-02
228-28-12

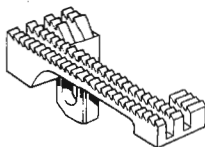
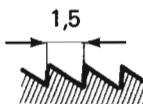
200782-0-10

Serve per
Serves for
Pour machines
Dient fuer

023-04-02
023-04-05

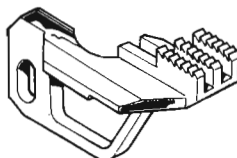
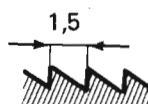
202054-0-10

Serve per
Serves for
Pour machines
Dient fuer

327-16-1CD-01
028-16-01

Indice
Data
Vr

Si rende noto che il contenuto della presente tavola non potrà essere utilizzato o rappresentato, né commentato, né riprodotto, né copiato, né ristampato, né in alcun modo divulgato, senza l'autorizzazione scritta della proprietaria S.p.A. V.lli. Rumoldi & C. La stessa intende tutelare i suoi diritti in conformità di legge.

Rumoldi

GRIFFA PRINCIP.

MAIN FEED DOG

GRIFFE PRINCIPALE

HAUPTTRANSPORTEUR

Indice	TAB	R300
00		
Data	Foglio 3	Segue F. 4

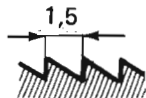
202606-0-10

Serve per
Serves for
Pour machines
Dient fuer

327-12-1CD-01

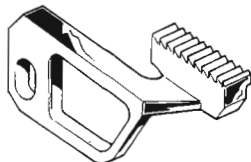
**202698-2-11**

Serve per
Serves for
Pour machines
Dient fuer

028-00-04
028-00-05
028-30-01
028-30-02
228-00-02
228-00-03
228-00-14
228-28-10

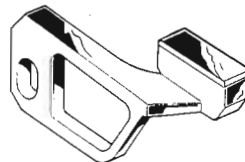
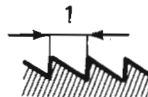
**202695-0-10**

Serve per
Serves for
Pour machines
Dient fuer

327-00-1CD-02
327-00-1CD-03
327-00-1CD-05
327-28-1CD-09
028-00-04
028-00-05
028-30-01
028-30-02
228-00-02
228-00-03
228-00-14
228-28-10

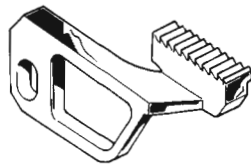
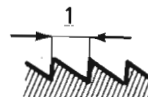
**202750-0-10**

Serve per
Serves for
Pour machines
Dient fuer

028-10-01

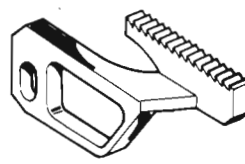

Si rende noto che il contenuto della presente tavola non potrà essere utilizzato o riprodotto, in tutto o in parte, senza il permesso scritto della proprietaria S.p.A. V. L. D. I. & C. La stessa intende tutelare i suoi diritti a norma di legge.

Indice
Data
Vr
Modifiche

Rimoldi

GRIFFA PRINCIP.

MAIN FEED DOG

GRIFFE PRINCIPALE

HAUPTTRANSPORTEUR

Indice	TAB	R300
00		
Data	Foglio 5	Segue F. 6

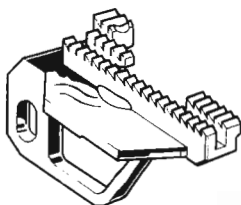
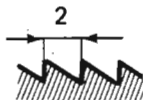
202927-0-10

Serve per
Serves for
Pour machines
Dient fuer

327-28-1 CU-06

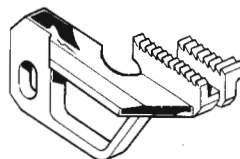
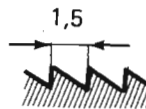
203028-0-10

Serve per
Serves for
Pour machines
Dient fuer

327-00-1CD-06
327-00-1CD-30
327-00-1MD-23
327-00-1MD-33
327-01-1CD-03
327-01-1CD-06
327-01-1MD-08
327-01-1MD-09
028-00-02
028-00-25
028-01-03
228-00-04
228-00-13
228-01-02.

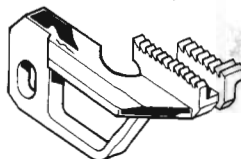
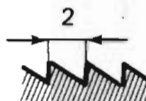
203001-0-10

Serve per
Serves for
Pour machines
Dient fuer

327-00-1CD-06
327-00-1CD-30
327-00-1MD-23
327-00-1MD-33
327-01-1CD-03
327-01-1MD-08
327-01-1MD-09
327-01-1MD-10
327-34-1MD-02
327-34-1MD-03
028-00-18
028-01-03
028-01-08
028-34-01
228-01-02
228-34-01

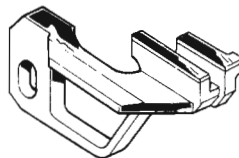
203030-2-11

Serve per
Serves for
Pour machines
Dient fuer

327-00-1CD-06
327-00-1CD-30
327-00-1MD-23
327-00-1MD-33
327-01-1CD-03
327-01-1MD-08
327-01-1MD-09

Si rende noto che il contenuto della presente tavola non è da considerarsi un brevetto e che, senza alcun diritto di esclusiva, è liberamente divulgato a terzi o riprodotto sia integralmente che parzialmente senza l'autorizzazione scritta dell'editore. Lo stesso intende tutelare i suoi diritti.

Indice
Data
Vr

modello

203060-0-10

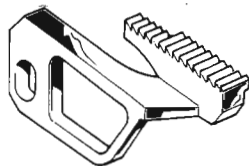
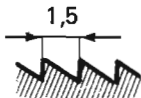

Serve per
Serves for
Pour machines
Dient fuer

- 327-00-1CD-25
- 327-00-1CD-26
- 327-00-1CD-27
- 327-00-1CD-29
- 327-29-1CD-08
- 028-00-20
- 028-00-21
- 028-00-22
- 028-00-24
- 028-29-07
- 028-30-03
- 028-30-04
- 028-30-05
- 228-00-11
- 228-00-12

203140-0-10

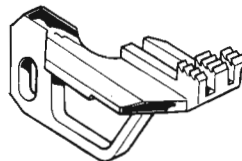
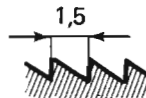

Serve per
Serves for
Pour machines
Dient fuer

- 327-00-1CD-32
- 327-22-1CD-02
- 327-22-1CD-03
- 327-23-1CD-02

203096-2-00

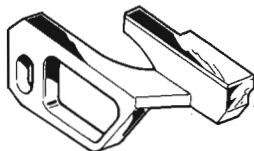

Serve per
Serves for
Pour machines
Dient fuer

- 327-00-1CD-25
- 327-00-1CD-26
- 327-00-1CD-27
- 327-00-1CD-29
- 327-29-1CD-08

203199-0-10

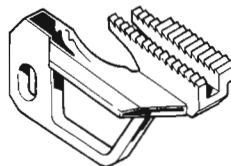
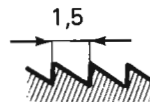

Serve per
Serves for
Pour machines
Dient fuer

- 327-00-1CD-07
- 327-00-1CD-31
- 327-01-1CD-04
- 327-01-1CD-05
- 327-29-1CD-04
- 327-29-1CD-05
- 327-29-1CD-06
- 028-00-03
- 028-01-04
- 028-29-04
- 028-29-05
- 028-29-06
- 228-00-05
- 228-00-15
- 228-01-03
- 228-01-04

Si rende noto che il contenuto della presente tavola non è da considerarsi un brevetto. Il presente disegno è riservato ai terzi o riprodotto o integrato, senza autorizzazione scritta, è vietato. Le stesse intenzioni tutelano i suoi diritti. Rumoldi S.p.A. - Roma

modifiche

N°	Data	Indice



203201-2-11

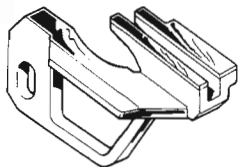

Serve per
Serves for
Pour machines
Dient fuer

- 327-00-1CD-07
- 327-00-1CD-31
- 327-01-1CD-04
- 327-29-1CD-05
- 327-29-1CD-06

203332-0-10

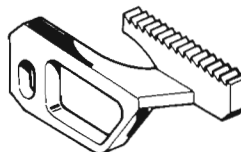
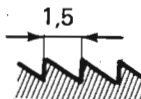

Serve per
Serves for
Pour machines
Dient fuer

- 327-00-1CD-10
- 327-28-1CD-11
- 028-00-07
- 028-00-08
- 228-00-07
- 228-00-08

203270-0-10

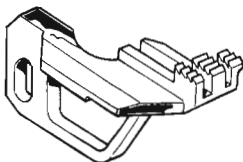
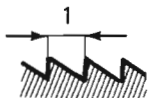

Serve per
Serves for
Pour machines
Dient fuer

- 327-22-1CD-04
- 327-22-1CD-05
- 327-23-1CD-08

203335-2-11

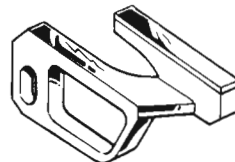

Serve per
Serves for
Pour machines
Dient fuer

- 327-00-1CD-09
- 327-00-1CD-39
- 327-28-1CD-07
- 028-00-06
- 028-28-07
- 228-00-06
- 228-00-17
- 228-28-07

Indice
Data
Vr

Si rende noto che il contenuto della presente tavola non potrà essere utilizzato o rappresentato né come merce divulgata a terzi o riprodotto sia integralmente sia in parte senza il permesso scritto dalla proprietaria S.p.A. V.lli. La stessa intende tutelare i suoi diritti e la propria fama di legge.



Si rende noto che il contenuto della presente tavola non potrà essere utilizzato o rappresentato, né copiato, né ristampato, né divulgato, né autorizzato senza la permesso scritto della proprietaria S.p.A. V. L. OLDI & C. La stessa intende tutelare i suoi diritti secondo la norma di legge.

Rumoldi

GRIFFA PRINCIP.

MAIN FEED DOG

GRIFFE PRINCIPALE

HAUPTTRANSPORTEUR

Indice	R300			
00				
Data	Foglio 9	Segue F.10		

203533-0-10

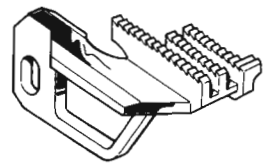
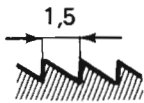

Serve per
Serves for
Pour machines
Dient fuer

- 327-00-2CD-15
- 327-00-2CD-45
- 327-01-2CD-10
- 028-00-12

203538-0-10

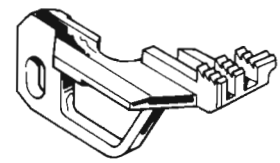
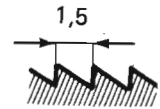

Serve per
Serves for
Pour machines
Dient fuer

- 327-00-2CD-39
- 327-22-2CD-06
- 327-23-2CD-06

203536-0-10

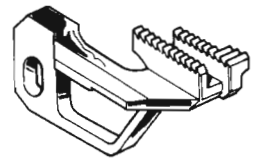
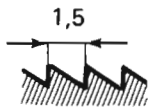

Serve per
Serves for
Pour machines
Dient fuer

- 327-00-2CD-16
- 327-00-2CD-41
- 028-00-13

203607-2-11

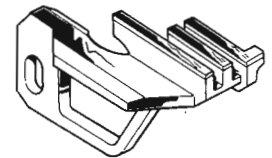

Serve per
Serves for
Pour machines
Dient fuer

- 327-00-2CD-17
- 327-00-2CD-18
- 327-00-2CD-35
- 327-00-2MD-36
- 327-01-2CD-05
- 327-01-2CD-06
- 327-01-2MD-11
- 028-00-14
- 028-00-15
- 028-00-16
- 028-01-06
- 028-01-05

203608-0-10

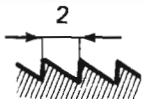

Serve per
Serves for
Pour machines
Dient fuer

327-00-2CD-35

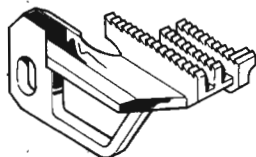

203668-0-11

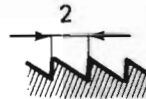

Serve per
Serves for
Pour machines
Dient fuer

327-00-2CD-15
327-00-2CD-18
327-00-2MD-36
327-01-2CD-06
327-01-2MD-11

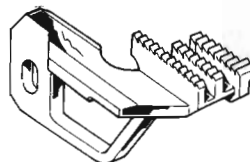

203651-0-11

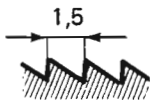

Serve per
Serves for
Pour machines
Dient fuer

327-00-2CD-17
327-00-2CD-18
327-00-2CD-35
327-00-2MD-20
327-00-2MD-21
327-00-2MD-36
327-01-2CD-05
327-01-2CD-06
327-01-2MD-07
327-01-2MD-11
028-00-14
028-00-15
028-00-16
028-00-17
028-01-05
028-01-06
028-01-07

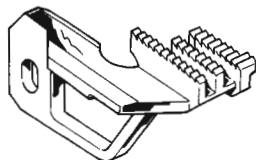

203746-0-10

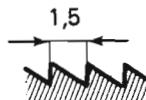

Serve per
Serves for
Pour machines
Dient fuer

327-00-1MD-34
327-22-1CD-01
327-22-1MD-07
327-23-1CD-01
327-23-1MD-07

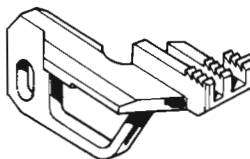

Si rende noto che il contenuto della presente tavola non potrà essere utilizzato o rappresentato, né copiato, senza permesso scritto e autorizzato dalla proprietà S.p.A. V. R. & C. Le stessa intende tutelare i suoi diritti a norma di legge.

modifiche

Indice	Data
Vr	





Indice
Data
V.

Si rende noto che il contenuto della presente tavola non potrà essere utilizzato o riprodotto, né comunque divulgato a terzi o riprodotto, integrazionemente o parzialmente, senza il permesso scritto della proprietaria S.p.A. V. BOLDI & C. La stessa intende tutelare i suoi diritti, norma di legge.

Rimoldi

GRIFFA PRINCIP.

MAIN FEED DOG

GRIFFE PRINCIPALE

HAUPTTRANSPORTEUR

Indice		
00		
Data		

TAB

R300

Foglio 11 | Segue F.12

203805-0-10

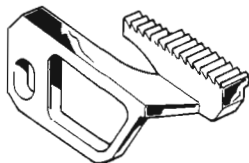
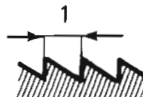

Serve per
Serves for
Pour machines
Dient fuer

028-00-23
028-30-06

203840-2-11

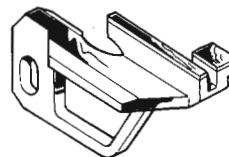

Serve per
Serves for
Pour machines
Dient fuer

227-34-03

203838-0-10

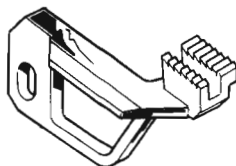
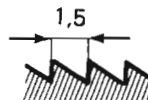

Serve per
Serves for
Pour machines
Dient fuer

227-34-01

204061-0-10

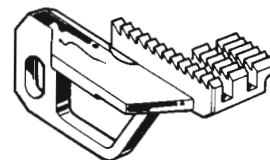
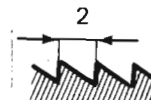

Serve per
Serves for
Pour machines
Dient fuer

327-49-1MD-01

204322-0-10

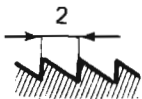

Serve per
Serves for
Pour machines
Dient fuer

028-28-05
028-28-06
228-28-05
228-28-06

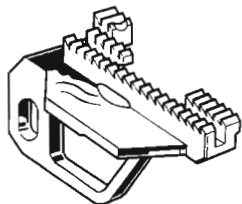

204425-0-10

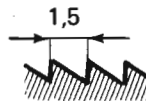

Serve per
Serves for
Pour machines
Dient fuer

228-10-04
228-10-08

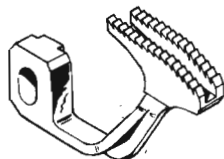

204375-2-11

Serve per
Serves for
Pour machines
Dient fuer

228-00-18

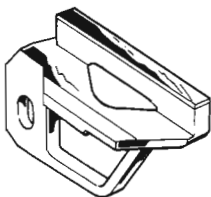

204520-0-11

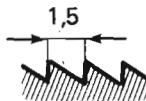

Serve per
Serves for
Pour machines
Dient fuer

028-28-09
028-29-08
228-28-09

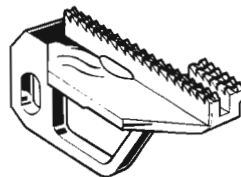

Si vende solo che il contratto della presente tavola non potrà essere utilizzato o appoggiato ad alcun altro contratto di viaggio a terzi o riprodotto integralmente o parzialmente senza il permesso scritto dalla Rumoldi S.p.A. stessa intendendo tutelare i suoi diritti e norme di legge.

modifiche

Indice	Data	V.



Rimoldi

GRIFFA PRINCIP.

MAIN FEED DOG

GRIFFE PRINCIPALE

HAUPTTRANSPORTEUR

Indice			TAB	R300
00				
Data			Foglio 13 Segue F.14	

204541-0-11

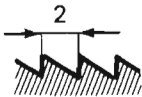

Serve per
Serves for
Pour machines
Dient fuer

028-28-09
028-29-08
228-28-09

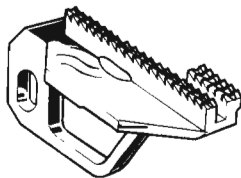

204605-0-11

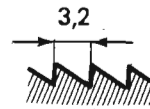

Serve per
Serves for
Pour machines
Dient fuer

028-00-19
228-00-16

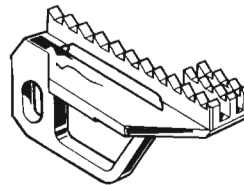

204545-0-11

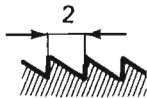

Serve per
Serves for
Pour machines
Dient fuer

028-28-10
028-28-11
228-28-08
228-28-11

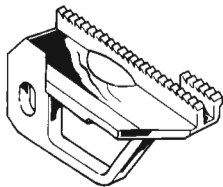

204666-0-10

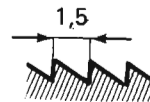

Serve per
Serves for
Pour machines
Dient fuer

329-00-2CD-01

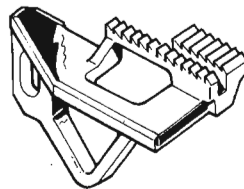

Indice
Data
Vi.
modifiche

Si rende noto che il contenuto della presente tavola non potrà essere utilizzato o riprodotto senza permesso scritto dalla proprietaria S.p.A. V. OLIOI & C. La stessa intende tutelare i suoi diritti e in forma di legge.

204815-0-10

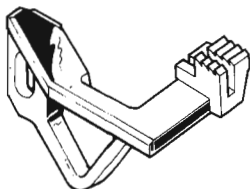
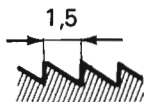

Serve per
Serves for
Pour machines
Dient fuer

329-22-2CD-02
329-23-2CD-02

204848-0-10

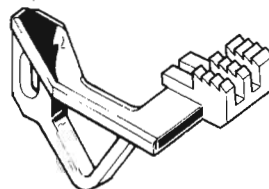
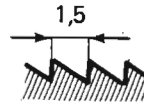

Serve per
Serves for
Pour machines
Dient fuer

329-00-2CD-15
329-22-2CD-03
329-23-2CD-03

204846-0-10

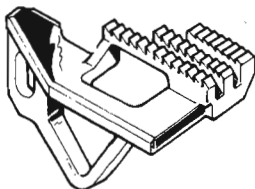
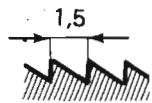

Serve per
Serves for
Pour machines
Dient fuer

329-00-2CD-06
329-00-2CD-08
329-00-2CD-12
329-01-2CD-01

204849-0-10

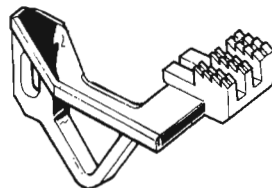
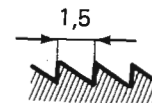

Serve per
Serves for
Pour machines
Dient fuer

329-00-2CD-15
329-22-2CD-03
329-23-2CD-03

Indice
Data
V.
modifiche

Si rende noto che il contenuto della presente tavola
nonche' divulgato, o terzi o riprodotto sia integral-
mente che parzialmente senza autorizzazione scrit-
ta della Rumoldi S.p.A. e' espressamente vietato. La
stessa intende tutelare i suoi diritti secondo la
norma di legge.

Inghiera
Dato
Vr

Si rende noto che il contenuto della presente tavola non potrà essere utilizzato o rappresentato né comunque divulgato a terzi o riprodotta integralmente senza permesso scritto dalla proprietà della proprietaria S.p.A. V. G. S. I. & C. La stessa intende tutelare i suoi diritti e norme di legge.

205007-0-10

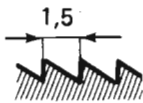
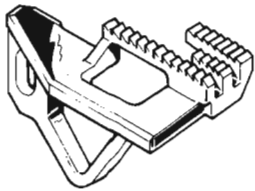
Serve per
Serves for
Pour machines
Dient fuer

329-00-2CD-06
329-00-2CD-10
329-01-2CD-02

205010-0-10

Serve per
Serves for
Pour machines
Dient fuer

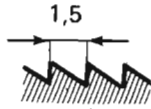
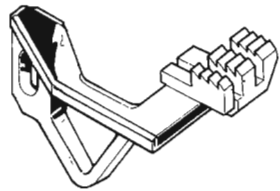
329-00-2CD-07
329-00-2CD-13
329-22-2CD-04
329-23-2CD-04

205009-2-11

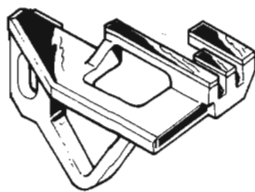

Serve per
Serves for
Pour machines
Dient fuer

329-00-2CD-06
329-00-2CD-10

205059-0-10

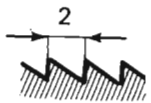
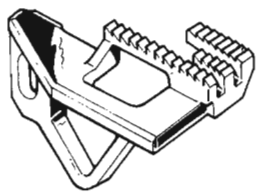
Serve per
Serves for
Pour machines
Dient fuer

329-00-2CD-06
329-00-2CD-10
329-01-2CD-02

Rimoldi

GRIFFA PRINCIP.

MAIN FEED DOG

GRIFFE PRINCIPALE

HAUPTTRANSPORTEUR

Indice	00	TAB	R300
Data		Foglio 19	Segue F.20

205205-0-10

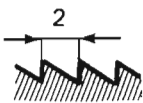

Serve per
Serves for
Pour machines
Dient fuer

330-00-1CD-02

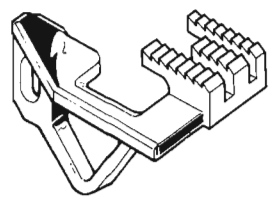

205240-0-10

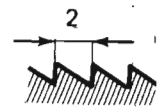

Serve per
Serves for
Pour machines
Dient fuer

330-00-1CD-03

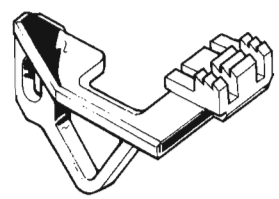

205221-0-10

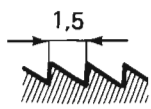

Serve per
Serves for
Pour machines
Dient fuer

330-00-1CD-02

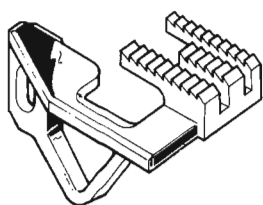

205241-0-10

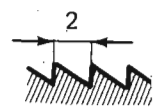

Serve per
Serves for
Pour machines
Dient fuer

330-00-1CD-03

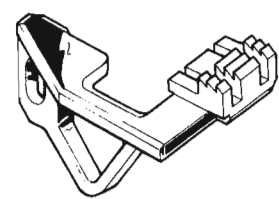

Si rende noto che il contenuto della presente tavola
 non può essere riprodotto, né in tutto o in parte, né
 in alcun modo, senza permesso scritto dalla Direzione
 della proprietà S.p.A. Rimoldi S.p.A. Le
 stesse intenzioni, tuttavia, sono dirette, norma di legge.

modiche
 Vr
 Data
 indic

Rimoldi**GRIFFA PRINCIP.****MAIN FEED DOG****GRIFFE PRINCIPALE****HAUPTTRANSPORTEUR**

00	Indice	TAB	R300
Data	Foglio 21 Segue F.22		

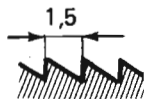
205539-0-00
 Serve per
 Serves for
 Pour machines
 Dient fuer

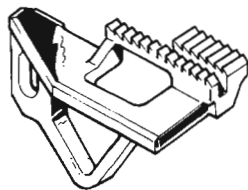
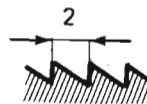
 329-00-2CD-03
 329-00-2CD-09
**205702-0-00**
 Serve per
 Serves for
 Pour machines
 Dient fuer

330-00-1CD-04

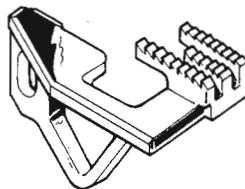
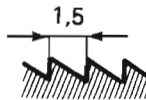
**205615-0-00**
 Serve per
 Serves for
 Pour machines
 Dient fuer

329-22-2CD-03

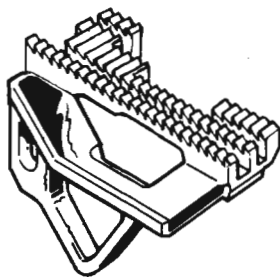
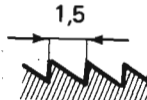
**205951-0-00**
 Serve per
 Serves for
 Pour machines
 Dient fuer

327-30-1CD-07

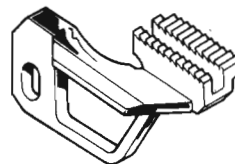
 indice
 Data
 Vr

modifich

 Si rende noto che il contenuto della presente tavola
 è di proprietà esclusiva della Rimoldi S.p.A. e non può
 essere divulgato a terzi o riprodotto sia integral-
 mente che parzialmente senza l'autorizzazione scrit-
 ta della Rimoldi S.p.A. La Rimoldi S.p.A. si riserva la
 stessa intenzione tutelare i suoi diritti secondo la
 norma di legge.

Rumold

GRIFFA PRINCIP.

MAIN FEED DOG

GRIFFE PRINCIPALE

HAUPTTRANSPORTEUR

Indice

TAB

R300

00

Foglio 23 | Segue F.24

206298-0-00

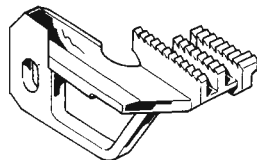
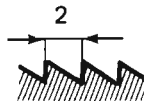

Serve per
Serves for
Pour machines
Dient fuer

327-00-2CD-14
327-00-2CD-17
327-00-2CD-18
327-00-2MD-20
327-00-2MD-21
327-00-2MD-36
327-01-2CD-05
327-01-2CD-06
327-01-2CD-12
328-01-2MD-07
327-01-2MD-11
028-00-11
028-00-14
028-00-15
028-00-16
028-00-17
028-01-05
028-01-06
028-01-07

207052-0-00

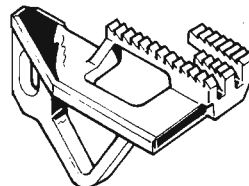
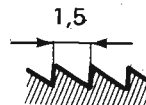

Serve per
Serves for
Pour machines
Dient fuer

329-00-2CD-06

207048-0-00

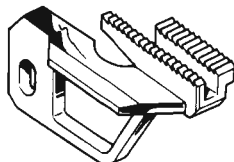
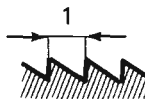

Serve per
Serves for
Pour machines
Dient fuer

327-00-2CD-13
327-00-2CD-38
028-00-10
228-00-10

920802-0-10

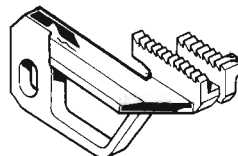
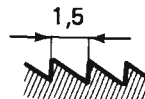

Serve per
Serves for
Pour machines
Dient fuer

327-00-1CD-06/103-90
327-00-1CD-30/103-90
028-00-02/103-90
028-00-25/103-90
228-00-04/103-90
228-00-13/103-90

Indice
Data
Vr

modifiche

Si rende noto che il contenuto della presente tavola non potrà essere utilizzato o rappresentato né con mezzi meccanici né con altri procedimenti senza l'autorizzazione scritta della proprietaria S.p.A. V. L. S. L. D. I. & C. La stessa intende tutelare i suoi diritti e norme di legge.

920830-0-00

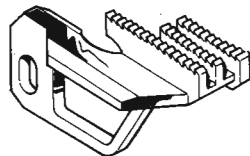
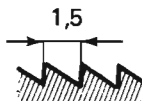

Serve per
Serves for
Pour machines
Dient fuer

- 327-00-2CD-15/108-91
- 327-00-2CD-17/108-91
- 327-00-2CD-18/108-91
- 327-00-2MD-21/108-91
- 327-00-2MD-36/108-91
- 028-00-12/108-90
- 028-00-14/108-90
- 028-00-15/108-90
- 028-00-16/108-90

920850-0-00

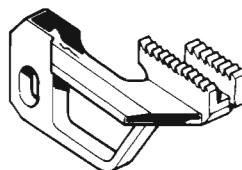
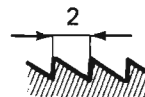

Serve per
Serves for
Pour machines
Dient fuer

- 327-00-2CD-32/108-91

920831-0-00

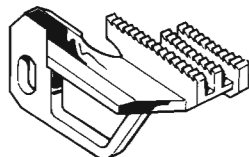
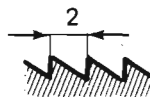

Serve per
Serves for
Pour machines
Dient fuer

- 327-00-2CD-14/108-91
- 327-00-2CD-15/108-91
- 327-00-2CD-17/108-91
- 327-00-2CD-18/108-91
- 327-00-2MD-21/108-91
- 327-00-2MD-36/108-91
- 028-00-11/108-90
- 028-00-14/108-90
- 028-00-15/108-90
- 028-00-16/108-90

920856-0-00

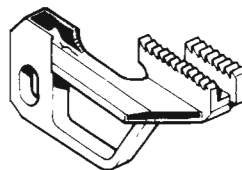
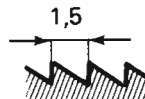

Serve per
Serves for
Pour machines
Dient fuer

- 327-00-2CD-16/108-91
- 028-00-13/108-90

modifiche

Indice
Data
V.



Si rende noto che il contenuto della presente tavola tecnica non rappresenta un'offerta di vendita. Il presente materiale è riservato ai clienti e ai concessionari della Rimoldi S.p.A. e non può essere ristampato, copiato, distribuito o utilizzato in qualsiasi modo senza il permesso scritto della Rimoldi S.p.A. La Rimoldi S.p.A. si riserva il diritto di modificare, senza preavviso, le caratteristiche tecniche, i prezzi e le condizioni di vendita del presente materiale. Rimoldi S.p.A. è iscritta al Registro Imprese di Roma al n. 00000000999. Rimoldi S.p.A. è iscritta al Registro Imprese di Roma al n. 00000000999. Rimoldi S.p.A. è iscritta al Registro Imprese di Roma al n. 00000000999.

Remoldi

GRIFFA PRINCIP.

MAIN FEED DOG

GRIFFE PRINCIPALE

HAUPTTRANSPORTEUR

Indice	TAB	R300
00		
Data	Foglio 25	Segue F.---

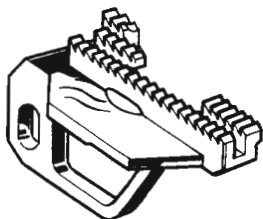
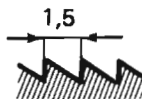
921392-0-00

Serve per
Serves for
Pour machines
Dient fuer

327-28-1CU-04/135-81
028-28-03/135-80
028-28-04/135-80
228-28-03/135-80
228-28-04/135-80

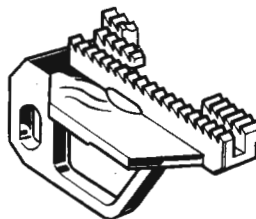
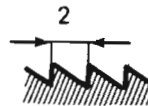
923896-0-00

Serve per
Serves for
Pour machines
Dient fuer

028-28-05/135-80
028-28-06/135-80
228-28-05/135-80
228-28-06/135-80

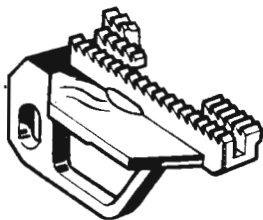
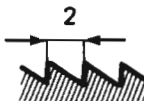
923893-0-00

Serve per
Serves for
Pour machines
Dient fuer

327-28-1CU-06/135-81

Serve per
Serves for
Pour machines
Dient fuer

Indice	
Data	
Vr	

modifiche

Si rende noto che il contenuto della presente tavola non potrà essere utilizzato o rappresentato né copiato, duplicato o terzi o riprodotto sia integralmente che parzialmente, senza il permesso scritto della proprietaria S.p.A. V. S. 10, D. & C. La stessa intende tutelare i suoi diritti, forme di legge.

Rundlauf

GRIFFA PRINCIPAL

MAIN FEED DOG

GRIFFE PRINCIPALE

HAUPTTRANSPORTEUR

R 300

933892-0-00

Serve per
Serves for
Pour machines
Dient fuer



337-58-1CU-04V138-81
028-58-03V138-80
028-58-04V138-80
328-58-03V138-80
328-58-04V138-80

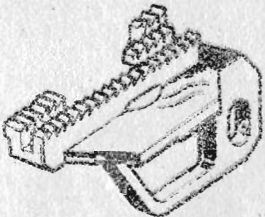

933893-0-00

Serve per
Serves for
Pour machines
Dient fuer



337-58-1CU-04V138-81



933898-0-00

Serve per
Serves for
Pour machines
Dient fuer



328-58-08V138-80
028-58-08V138-80
028-58-08V138-80
328-58-08V138-80

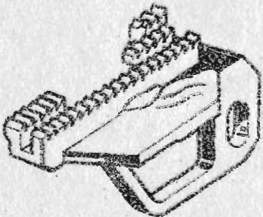

Serve per
Serves for
Pour machines
Dient fuer



Small vertical text on the right edge of the page, likely a copyright or manufacturer's note.