

---

**PARTS LIST**

Dec. 1980

# **DV.DW**SERIES

**MODELS: DV.DW**

---

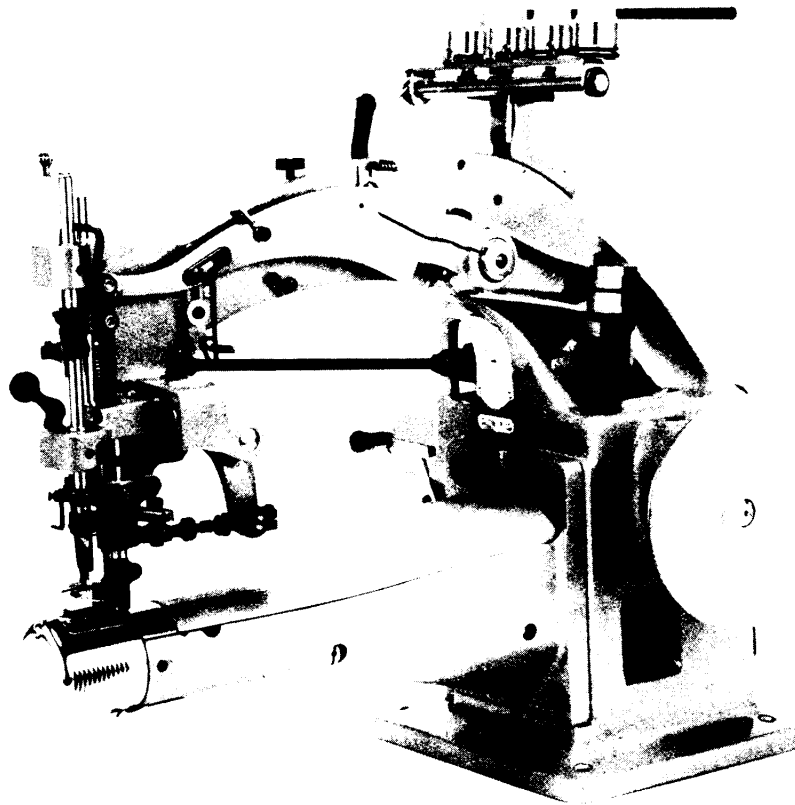

**PEGASUS<sup>®</sup>**



## IN ORDERING PARTS

This book has been arranged to simplify ordering repair parts for model DW-3, DW-7 and DV-1, on the basis of model DW-3.

Various sections of the mechanisms are shown on each page. On the page opposite the illustrations will be found a listing of the parts with their reference numbers, parts numbers, names and the number of pieces required.

Parts whose numbers are marked with an asterisk (\*), appeared in from page 3 to 17 except page 15, e.g. \*192138, Ref. No. 23, Page 3, are used for model DW-3 and DW-7 only, not for model DV-1. Parts used for model DV-1 only are illustrated and listed in page 18 and 19.

All the gauge parts such as needle clamp, needle plate, feed dog and presser foot for each model are illustrated and listed on the pages 20 and 21.

At the back of this list, a numerical index of all parts is shown. This will facilitate locating the illustrations and descriptions when only the part number is known.

In ordering parts from this list, the part number MUST be quoted exactly as it is shown in the second column on the page opposite the illustrations. Reference number should never be used in ordering parts.

## 部品表御利用に際して

本部品表はDW-3型を基本にDW-7、DV-1型ミシンの修理用部品を容易に御利用頂ける様編集されている。

機構別に各頁に収録され、部品図解頁(左開き)の反対頁(右開き)には参照番号、部品番号、名称、使用数量の順で記載されている。

3頁から17頁(15頁を除く)にわたり\*印の付された部品番号(例 参照番号23、3頁)はDW-3、DW-7型にのみ共通で、DV-1型には使用されない。DV-1型専用部品は18、19頁に収録されている。

全ての機種針抱、針板、送り歯、押エ等のゲージパーツは20頁、21頁のゲージパーツ表に収録されている。

本部品表の最終頁(24頁)には部品番号索引表を付し、部品番号のみでその図解、名称等が容易に引き出せる。

本部品表に基き部品御注文の際、参照番号は絶対に使用されず必ず部品番号のみを明示下さい。

本部品表は1970年11月現在製造中のDW/DV型ミシン用に作成されております。

## CONTENTS

MACHINE ARM-BED & COVERS .....	アーム・ベッド・外部機構 .....	2 ~ 3
MAIN SHAFT MECHANISM .....	主軸機構 .....	4 ~ 5
NEEDLE BAR DRIVE MECHANISM & THREAD PARTS .....	針棒機構 .....	6 ~ 7
LOOPER DRIVE MECHANISM .....	ルーバー機構 .....	8 ~ 9
FEED MECHANISM .....	送り機構 .....	10 ~ 11
PRESSER FOOT & LIFTING MECHANISM .....	押エ機構 .....	12 ~ 13
SPREADER DRIVE MECHANISM & THREAD PARTS .....	飾り振り機構 (DW-3、DW-7型専用) .....	14 ~ 15
(FOR MODEL DW-3 & DW-7 ONLY)		
LOOPER THREAD PARTS .....	裏糸調子機構 .....	16 ~ 17
PARTS FOR MODEL DV-1 ONLY .....	DV-1型専用部品 .....	18 ~ 19
LIST OF GAUGE PARTS .....	ゲージパーツ表 .....	20 ~ 21
ACCESSORIES .....	付属品 .....	22 ~ 23
NUMERICAL INDEX OF PARTS .....	部品番号索引 .....	24

## 目次

PAGE  
頁

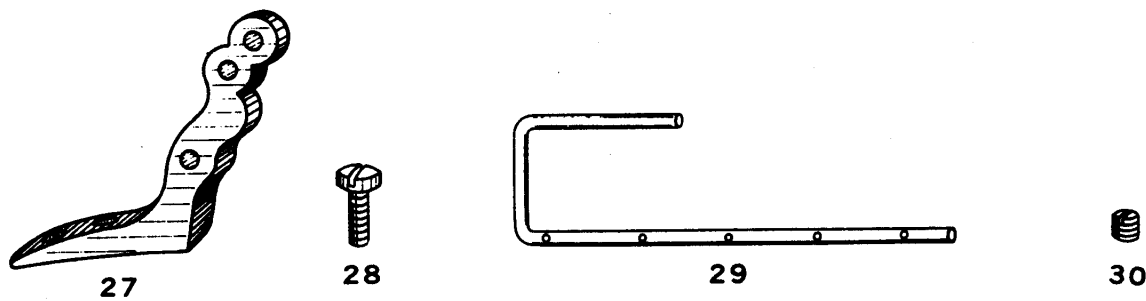
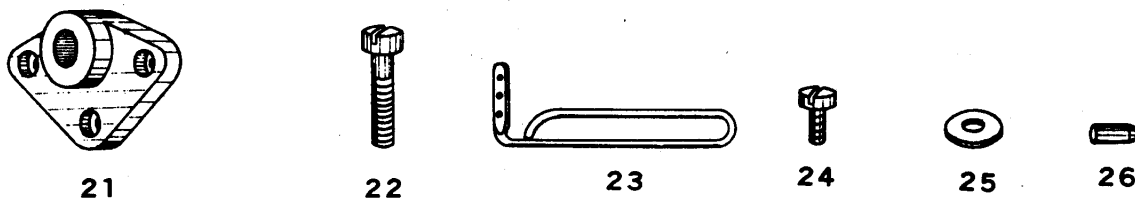
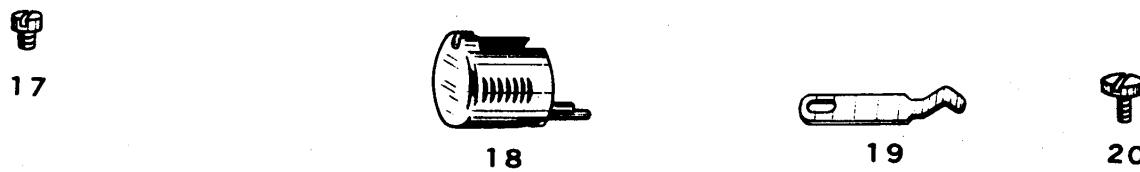
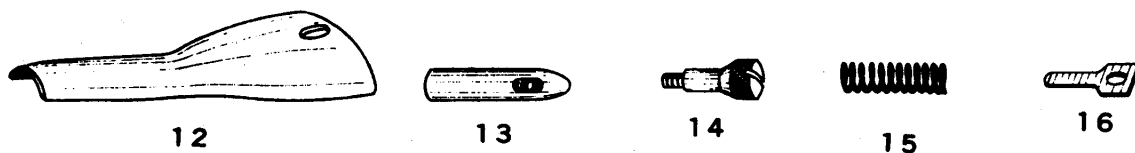
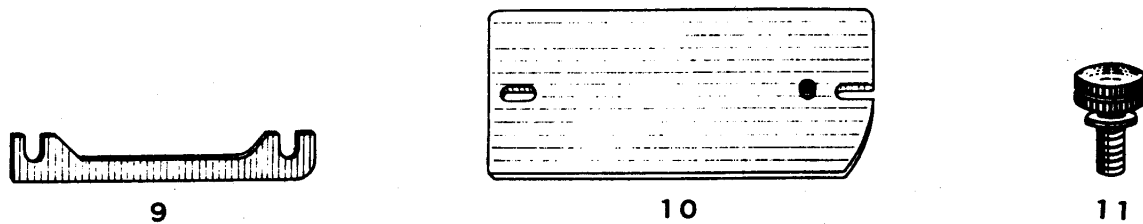
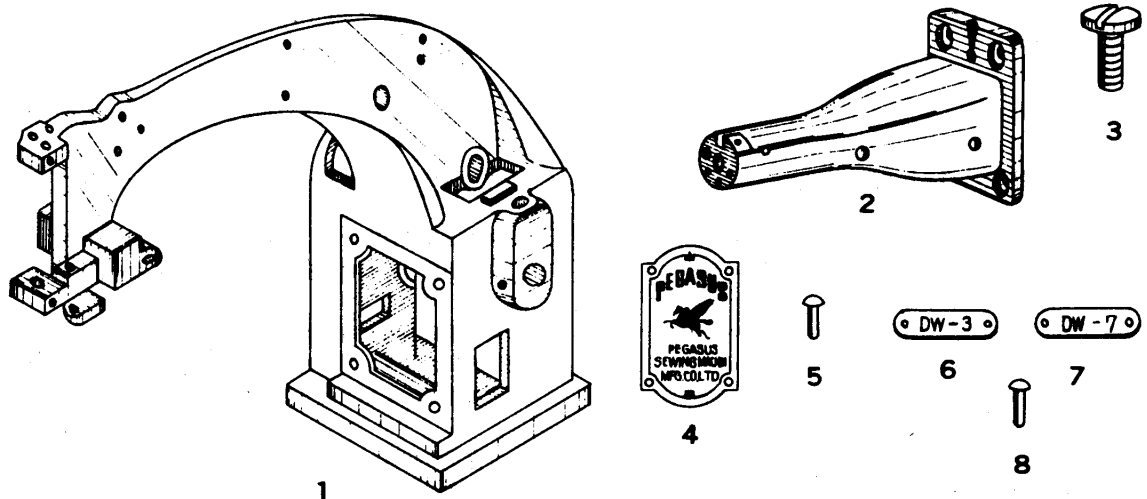

## MACHINE ARM-BED & COVERS

### アーム・ベッド・外部機構

Ref. No. 参照番号	Parts No. 部品番号	Name	名称	Qt. 数量
1	*192001	Machine arm	アーム ベッド	1
2	192002A	" cylinder bed	筒	1
3	5311	" " " screw	＊止ネジ	4
4	202046	Name plate	銘板	1
5	137011G	" " pin	＊止ピン	4
6	149038	Model plate, for model DW-3 only	型式板 (DW-3)	1
7	149039	" plate, for model DW-7 only	＊ (DW-7)	1
8	137011G	" plate pin	＊止ピン	2
9	200384	Machine cylinder bed shim	筒取付用鉄板	1
10	192128	" arm rear cover	後カバー	1
11	128-2	" " " " screw	＊止ネジ	2
12	192129 A	" cylinder bed cover	前カバー	1
13	192131	" " " " plunger	＊ピン	1
14	5337	" " " " " screw	＊＊引ネジ	1
15	192130	" " " " " spring	＊＊押バネ	1
16	192132	" " " " latch	＊前板バネ	1
17	132-1	" " " " " screw	＊＊止ネジ	1
18	191134A	Looper cover	ルーパーカバー	1
19	192133	" " latch	＊止板バネ	1
20	62-1	" " " " screw	＊＊止ネジ	1
21	192137	" shaft bushing	筒メタル	1
22	5310	" " " " screw	＊止ネジ	3
23	*192138	Needle thread guide	土台糸道	1
24	42-1	" " " " screw	＊止ネジ	1
25	137142	" " " " " washer	＊＊座金	1
26	198016	" " " " pin	＊止ピン	1
27	149027	Thread guide stand	L型糸道土台	1
28	144-2	" " " " screw	＊止ネジ	2
29	*192145A	" guide	L型糸道	1
30	11-1	" " " " screw	糸道棒止ネジ	1

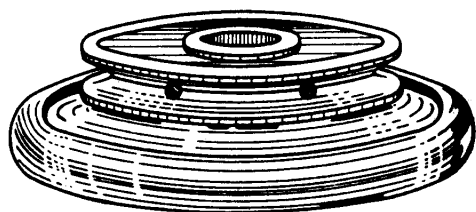

1



2



3



4

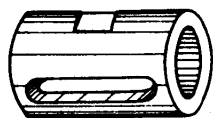

5



6



7



8

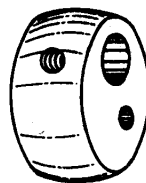

9



10



11



12



13

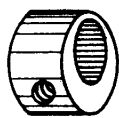

14



15

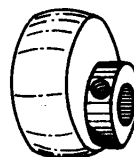

16



17



18

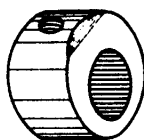

19



20

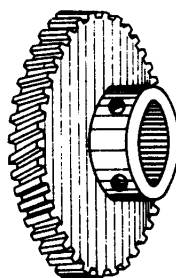

21



22

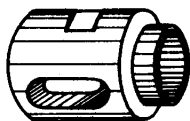

23



24



25

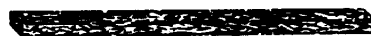

26

## MAIN SHAFT MECHANISM

### 主 軸 機 構

Ref. No. 参照番号	Parts No. 部品番号	Name	名 称	Qt. 数量
1	192003	Pulley	プーリー	1
2	3-1	" spot screw	＊ 止ネジ(先有)	1
3	3-2	" set screw	＊ ＊ (先無)	1
4	192004	Main shaft	主軸大シャフト	1
5	192005	" " bushing (right)	大シャフトブッシュ大	1
6	2022-3	" " " " screw	＊ 止ネジ	1
7	200493	" " " " oil wick	＊ 給油フェルト	1
8	200390	" " " " " hole wick	＊ ＊	2
9	192006	Needle bar drive eccentric	針棒上下ロッド球大	1
10	6-1	" " " " spot screw	＊ 止ネジ(先有)	1
11	6-2	" " " " set screw	＊ ＊ (先無)	1
12	192007	Feed rocker eccentric	送り変動ロッド球A(段付)	1
13	6-1	" " " " spot screw	＊ 止ネジ(先有)	1
14	192008	Looper lever eccentric	ルーバー前後ロッド球	1
15	8-1	" " " " spot screw	＊ 止ネジ(先有)	1
16	192009	" shaft rocker eccentric	ルーバーロッド球大	1
17	6-1	" " " " spot screw	＊ 止ネジ(先有)	1
18	6-2	" " " " set screw	＊ ＊ (先無)	1
19	192010	Feed lift eccentric	送り変動ロッド球B(段無)	1
20	6-1	" " " " spot screw	＊ 止ネジ(先有)	1
21	*193011	Spreader drive gear	片振り下ギヤー	1
22	11-1	" " " " screw	＊ 止ネジ	2
23	*192012	Main shaft bushing (left)	大シャフトブッシュ小(段付)	1
24	2022-3	" " " " screw	＊ 止ネジ	1
25	*200334	" " " " oil wick	＊ 給油フェルト	2
26	*202024	" " " " " hole wick	＊ 立油穴給油フェルト	1

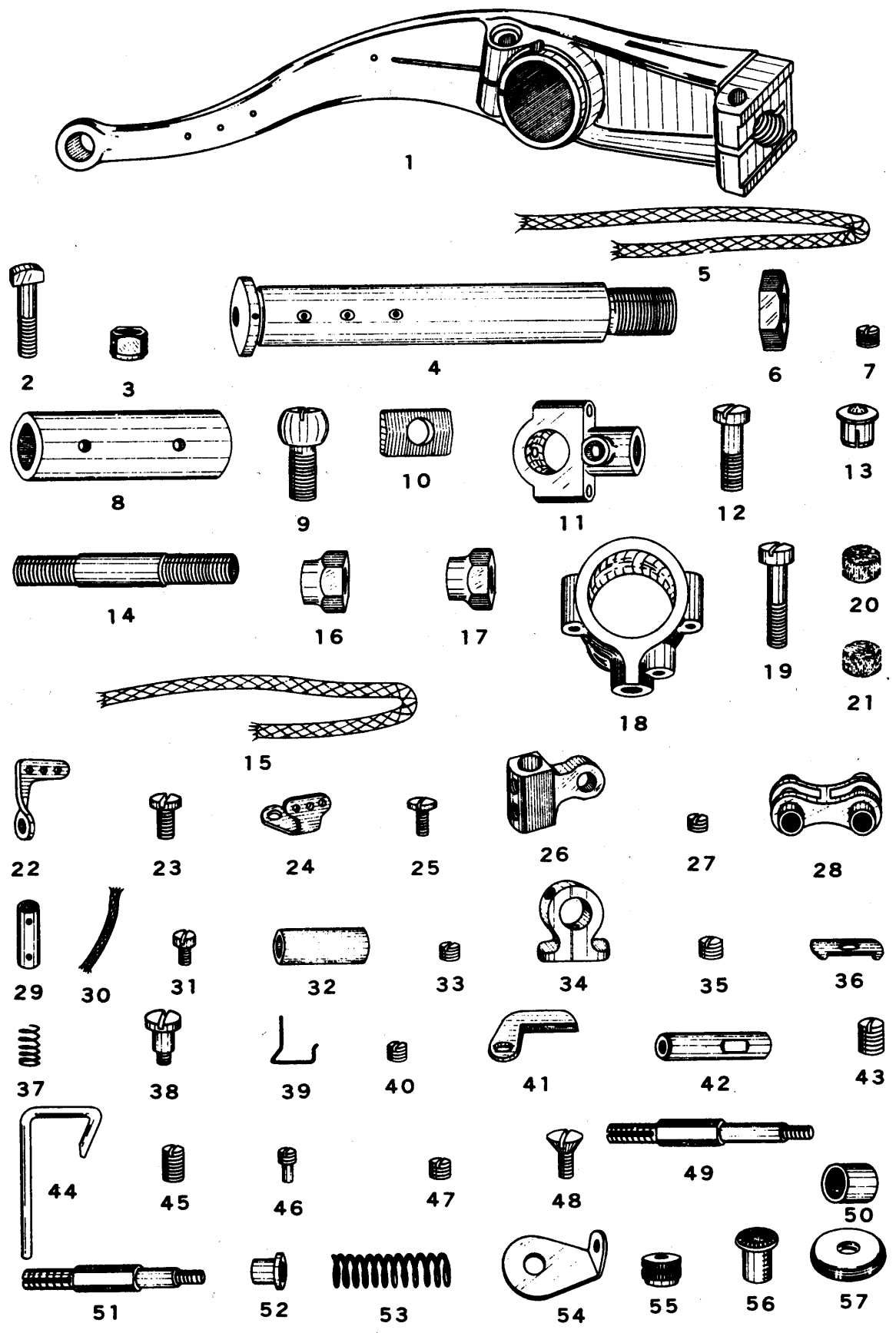



## NEEDLE BAR DRIVE MECHANISM & THREAD PARTS

### 針 棒 機 構

Ref. No. 参照番号	Parts No. 部品番号	Name	名 称	Qt. 数量	Remarks 備 考
1	200387	Needle bar drive arm	針棒クランク	1	
2	5307	" " " " clamp screw	締付ネジ	2	
3	5308	" " " " " " nut	ナット	2	
4	192055	" " " " stud	軸	1	
5	202175	" " " " " " oil wick	給油紐	1	
6	55-1	" " " " " " nut	ナット	1	
7	5306	" " " " " " oil plug screw	油穴蓋ネジ	1	
8	192056	" " " " " " collar	カラー	1	
9	192057	" " " " " " ball stud	針棒ロッド球小	1	
10	192058	" " " " " " guide	振り止メ	1	
11	192059	" " " " rod head (small)	針棒ロッド小	1	
12	59-1	" " " " " " cap screw	蓋止ネジ	2	
13	192059-1	" " " " " " oil cap	オイルカップ組	1	
14	192060	" " " " rod	針棒ロッド連結パイプ	1	
15	202175	" " " " " " oil wick	給油紐	1	
16	60-1	" " " " " " nut (right)	ナット右	1	
17	60-2	" " " " " " nut (left)	ナット左	1	
18	192061	" " " " " " head (large)	針棒ロッド大	1	
19	59-1	" " " " " " cap screw	蓋止ネジ	2	
20	200390	" " " " " " oil wick	給油フェルト	1	
21	200389	" " " " " " hole wick		1	
22	*192062	" " " " " " thread eyelet	針棒クランク糸道	1	
23	62-1	" " " " " " screw	止ネジ	1	
24	192064	" " " " " " thread eyelet	針棒糸道	1	
25	64-1	" " " " " " screw	止ネジ	1	
26	200388	" " " " clamp	針棒抱キ	1	
27	65-1	" " " " screw	止ネジ	3	
28	200653	" " " " drive link	針棒リンク	1	
29	200654	" " " " " " pin	ピン	2	
30	202175	" " " " " " oil wick	給油紐	2	
31	44-3	" " " " " " screw	止ネジ	1	
32	192068	" " " " bushing	針棒ブッシュ	2	
33	24-1	" " " " " " screw	止ネジ	2	
34	192069	" " " " thread nipper bracket	針棒糸調子台	1	
35	24-1	" " " " " " screw	止ネジ	1	
36	192070	" " " " nipper	糸調子皿	1	
37	198034	" " " " " " spring	バネ	1	
38	9070-2	" " " " " " stud screw	止ネジ	1	
39	*192071-3	" " " " clamp thread guide wire	針抱糸道	1	
40	* 71-4	" " " " " " screw	止ネジ	1	
41	200371	" " " " guard	針受	1	
42	200372	" " " " stud	軸	1	
43	6-2	" " " " " " screw	止ネジ	1	
44	191143	" " " " bar thread take-up wire	針棒糸掛	1	
45	143-1	" " " " " " screw	止ネジ	1	
46	71-1	" " " " clamp screw, for center needle	針抱止ネジ(先有)	1	
47	65-1	" " " " " " screw, for left & right needles	(先無)	2	
48	5373	" " " " plate screw	針板止ネジ	2	
49	192150	" " " " thread tension post (long)	針糸調子棒(長)	1	
50	192153A	" " " " " " spacer	パイプA	1	
51	192123	" " " " " " post (short)	棒(短)	2	1 pc. only for DW-7 & DV-1 DW-7, DV-1は1ケのみ
52	192127A	" " " " " " spacer	パイプB	2	
53	192152	" " " " " " spring	糸調子バネ(強)	3	2 pcs. only for DW-7 & DV-1 DW-7, DV-1は2ケのみ
54	200361	" " " " " " guide	台	3	
55	5372	" " " " " " nut	ナット	3	
56	192124	" " " " " " spring bushing	止パイプ	3	
57	192126	" " " " " " disc	皿	6	4 pcs. only for DW-7 & DV-1 DW-7, DV-1は4ケのみ

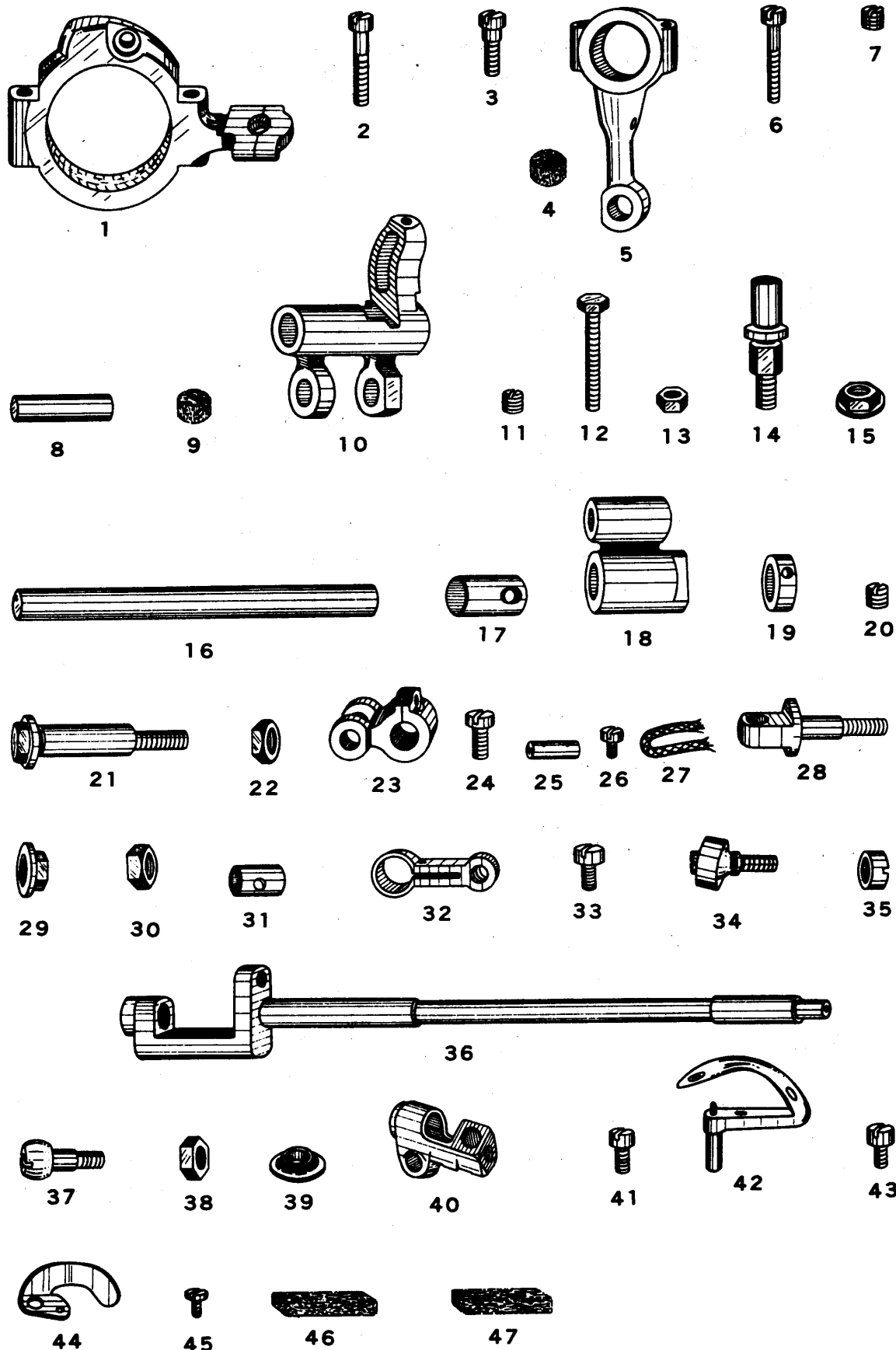

# LOOPER DRIVE MECHANISM

## ルーパー機構

Ref. No. 参照番号	Parts No. 部品番号	Name	名称	Qt. 数量
1	192032	Looper shaft rocker connection	ルーパー振りロッド	1
2	16-2	" " " " cap screw (long)	" 蓋止ネジ(大)	2
3	5376	" " " " " screw (short)	" " (小)	2
4	200389	" " " " oil wick	" 給油フェルト	2
5	192033	" lever connection	ルーパー前後ロッド	1
6	16-2	" " " cap screw	" 蓋止ネジ	2
7	11-1	" " " set screw	" 軸止ネジ	1
8	192029	" " " pin	" 小軸	1
9	200389	" " " oil wick	" 給油フェルト	1
10	192035	" lever	ルーパー前後調節器	1
11	11-1	" " screw	" 止ネジ	2
12	35-2	" " lock screw	" 押ネジ	1
13	35-3	" " " " nut	" " ナット	1
14	192036	" " stud	" ネジ	1
15	26-1	" " " nut	" 座付ナット	1
16	192037	" " shaft	" 軸	1
17	192154	" " " bushing	" " ブッシュ	2
18	192038	" shaft rocker connection brace	ルーパーロッド振り止連結器	1
19	192040	" " " " " collar	" " 軸カラー	3
20	11-1	" " " " " " screw	" " " 止ネジ	3
21	192041	" " " " " stud	" " 連結六角ネジ	1
22	28-1	" " " " " " nut	" " " ナット	1
23	200385	" lever link	ルーパー調節器リンク	1
24	42-1	" " " screw	" 止ネジ	1
25	200654	" " " pin	" ピン	1
26	44-3	" " " " screw	" " 止ネジ	1
27	202175	" " " " oil wick	" " 給油紐	1
28	200386	" shaft rocker stud	ルーパー調節器長ネジ	1
29	26-1	" " " " nut	" " 座付ナット	1
30	28-1	" " " " lock nut	" リンクピン長ネジナット	1
31	192045	" shaft rocker bushing	ルーパーシャフトブッシュ	1
32	192046	" " " connection link	ルーパーロッド振り止メ	1
33	5328	" " " " " screw	" " 止ネジ	1
34	192047	" " " " ball stud	" " 球	1
35	47-1	" " " " " nut	" " ナット	1
36	192048	" shaft	ルーパーシャフト	1
37	192049	" " rocker ball	ルーパー振りロッド球小	1
38	28-1	" " " " nut	" " ナット	1
39	192050	" " " " collar	" " 座金	1
40	192051	" holder	ルーパー台	1
41	51-1	" " screw	" 止ネジ	1
42	*192052	Looper	ルーパー	1
43	51-2	" screw	" 止ネジ	1
44	192053	" guard	" 補助器	1
45	1231	" " screw	" " 止ネジ	1
46	202473	" lever shaft bushing oil wick	ルーパー前後調節器軸ブッシュ給油フェルト	2
47	202473	" shaft bushing oil wick	筒前後メタル給油フェルト	2

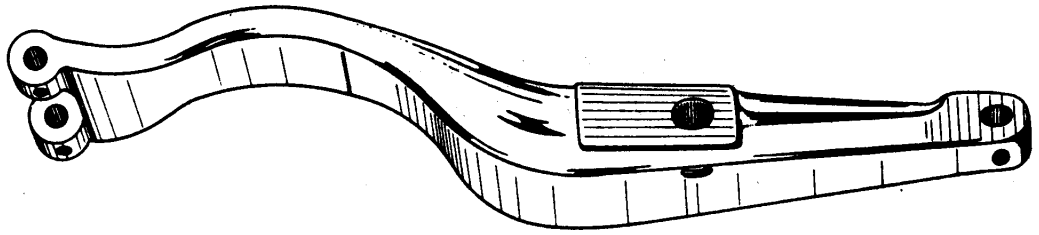

1

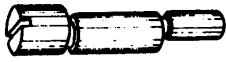

2



3

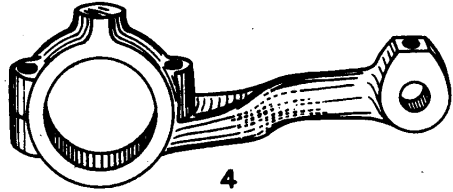

4



5



6



7



8

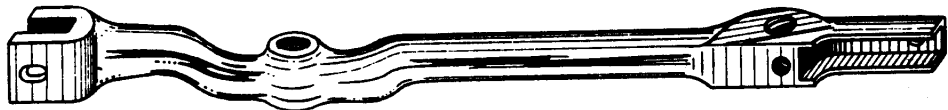

9

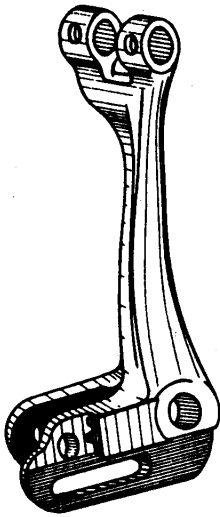

16



10



11



12



13



14

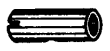

15

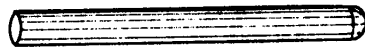

17



18

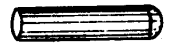

19



20



21



22



23

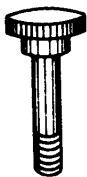

24



25



26

## FEED MECHANISM

### 送 り 機 構

Ref. No. 参照番号	Parts No. 部品番号	Name	名 称	Qt. 数量
1	192013	Feed lift lever	送り上下台	1
2	192014	" dog vertical adjusting pin	送り上下エキセン軸	1
3	14-1	" " " " " screw	" " 止ネジ	2
4	192016	" lift lever & rocker connection	送り変動ロッド	2
5	11-1	" " " " " " pin screw	" " ピン止ネジ	2
6	16-2	" " " " " " cap screw	" " 蓋止ネジ	4
7	200390	" " " " " " oil wick	" " 給油フェルト	2
8	192017	" bar guide pin	送り台連結軸	1
9	192018	" bar	送り台	1
10	192028	" " link stud	" 止ネジ	1
11	28-1	" " " " nut	" " ナット	1
12	192019	" lift lever link pin	" 連結チエン芯ネジ	2
13	192020	" " " link (right)	" " (B)	1
14	192021	" " " link (left)	" " (A)	1
15	192015	" " " " bushing	送り上下台ブッシュ	2
16	192022	" rocker	送り調節器	1
17	192023	" " shaft	" 軸	1
18	14-1	" " " screw	" " 止ネジ	1
19	192029	" " connection pin	" 小軸	2
20	192024	" " shaft collar	" 軸カラー	2
21	24-1	" " " " " screw	" " " 止ネジ	2
22	192025	" bar link	送り調節桿	1
23	192027	" " " bushing	" カラー	2
24	192026	Stitch regulating stud	送り調節段ネジ	1
25	26-1	" " " nut	" 座付ナット	1
26	30-1	Feed dog screw	送り歯止ネジ	2

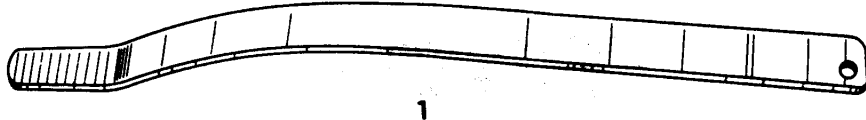

1



2

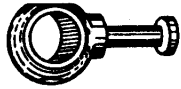

3



4

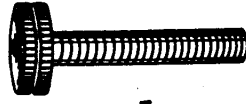

5



6

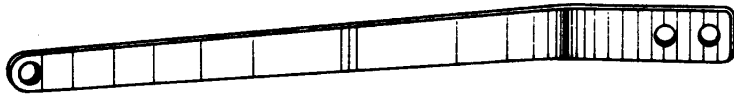

7



8

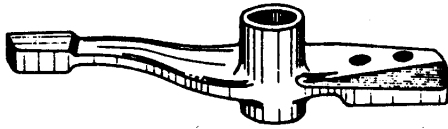

9

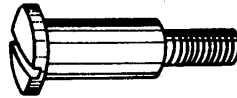

10



11



12



13

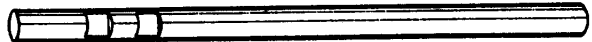

14



15



16



17



18

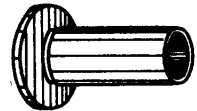

19



20



21

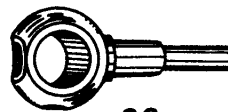

22



23



24

**PRESSER FOOT & LIFTING MECHANISM**

**押 工 機 構**

Ref. No. 参照番号	Parts No. 部品番号	Name	名 称	Qt. 数量
1	192072	Presser spring	押エ板バネ	1
2	192072-1	" " pin	＊ ビン	1
3	192077	" " rest	＊ 受	1
4	24-1	" " " screw	＊ ＊止ネジ	1
5	192083	" " adjusting screw	＊ 押シネジ	1
6	83-1	" " " " lock nut	＊ ＊ ナット	1
7	192073	Foot lift lever extension	押エ上板金	1
8	42-1	" " " " screw	＊ 止ネジ	2
9	192074	" " lever	押エ上クランク	1
10	192075	" " " stud	＊ 段ネジ	1
11	192081	" " " spring	＊ 引バネ	1
12	192081-1	" " " stop pin	＊ ＊ 当リピン	1
13	192081-2	" " " spring pin	＊ ＊ 引ピン	1
14	192076B	Presser guide bar	押エ上棒	1
15	200443	" " " stop collar	押エ上ゲストッパーカラー	1
16	24-1	" " " " " screw	＊ 止ネジ	2
17	*192079	" bar	押エ棒	1
18	44-3	" " connection screw	＊ 止ネジ	1
19	*193080	" " bushing	片振り押エ棒ブッシュ下	1
20	106-2	" " " clamp screw	＊ 止ネジ	1
21	192079-2	" " retaining ring	押エ棒金輪	1
22	192078	" " connection	＊ 抱キ	1
23	24-1	" " " screw	＊ ＊ 止ネジ	1
24	5328	" foot screw	押エ止ネジ	1

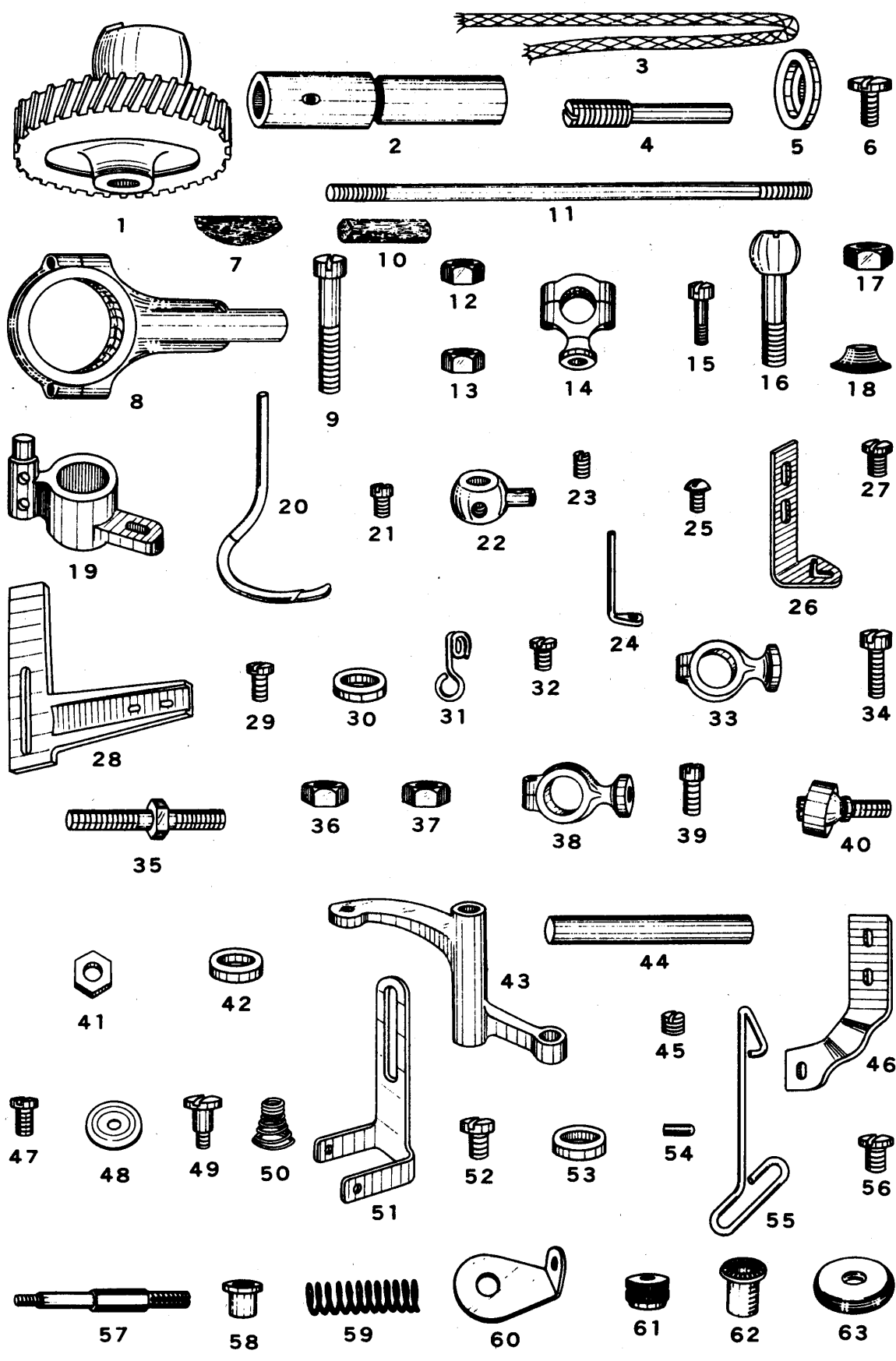



**SPREADER DRIVE MECHANISM & THREAD PARTS (FOR MODEL DW-3 & DW-7 ONLY)**

**飾り振り機構 (DW-3, DW-7 型専用)**

Ref. No. 参照番号	Parts No. 部品番号	Name	名称	Qt. 数量
1	193085	Spreader drive gear	片振り上ギヤ	1
2	192086	" " " shaft	上ギヤ軸	1
3	202175	" " " " oil wick	〃 〃 給油紐	1
4	5309	" " " " screw	〃 〃 止ネジ	1
5	192087	" " " washer	〃 〃 頭座金	1
6	87-1	" " " " screw	〃 〃 止ネジ	1
7	200492	" " " shaft oil wick	〃 〃 軸給油フェルト	1
8	192088	connecting rod head (large)	飾り振りロッド	1
9	16-2	" " " " " cap screw	〃 〃 蓋止ネジ	2
10	201767	" " " " " oil wick	〃 〃 給油フェルト	1
11	192089	" " " rod	〃 〃 引棒	1
12	89-1	" " " " " nut (left)	〃 〃 ナット左	1
13	28-1	" " " " " (right)	〃 〃 ナット右	1
14	192090	connection rod head (small)	飾り振りロッド小	1
15	5376	" " " " " cap screw	〃 〃 蓋止ネジ	2
16	192091	" " " " " ball stud	〃 〃 球	1
17	28-1	" " " " " " " nut	〃 〃 ナット	1
18	192092	" " " " " " " washer	〃 〃 座金	1
19	193095	" " " carrier	片振り台	1
20	193098	Spreader (cover thread finger)	片振り	1
21	44-3	" " " screw	〃 〃 止ネジ	2
22	193170	thread eyelet holder	〃 〃 針棒糸道台	1
23	65-1	" " " " " screw	〃 〃 〃 止ネジ	1
24	193171	" " " eyelet	〃 〃 第一糸道	1
25	1333	" " " " " screw	〃 〃 〃 止ネジ	1
26	193173	" " " " " guide	〃 〃 糸道	1
27	64-1	" " " " " screw	〃 〃 〃 止ネジ	2
28	193172	" " " " " bracket	〃 〃 〃 台	1
29	1175-2	" " " " " " " screw	〃 〃 〃 〃 止ネジ	2
30	167061	" " " " " " " washer	〃 〃 〃 〃 座金	2
31	193174	" " " " " eyelet	〃 〃 第二糸道	1
32	1175-2	" " " " " " " screw	〃 〃 〃 止ネジ	1
33	192100	carrier connection head (right)	飾り振り台連結ロッド右	1
34	1175-2	" " " " " " " screw	〃 〃 〃 止ネジ	1
35	192102	" " " " " connecting rod	飾り振りロッド連結棒	1
36	102-1	" " " " " " " nut (right)	〃 〃 〃 ナット右	1
37	102-2	" " " " " " " (left)	〃 〃 〃 ナット左	1
38	192103	carrier connection head (left)	飾り振りロッド左	1
39	46-1	" " " " " " " screw	〃 〃 〃 止ネジ	1
40	192104	" " " " " connecting rod ball stud	飾り振りロッド球足長	2
41	35-3	" " " " " " " nut	片振りロッド下球ナット	1
42	167061	" " " " " " " washer	〃 〃 〃 〃 座金	1
43	193093	" " " " " rocker	片振り連結台二又	1
44	192105	" " " " " shaft	飾り振りロッド連結二又軸	1
45	11-1	" " " " " " " screw	〃 〃 〃 止ネジ	2
46	193175	" " " " " thread nipper tension bracket	片振り小調子台	1
47	1175-2	" " " " " " " screw	〃 〃 〃 止ネジ	2
48	137108	" " " " " " " disc	〃 〃 〃 皿	2
49	1092	" " " " " " " stud screw	〃 〃 〃 止ネジ	1
50	137109	" " " " " " " spring	〃 〃 〃 バネ	1
51	193179	" " " " " take-up eyelet	片振り二又糸道	1
52	1175-2	" " " " " " " screw	〃 〃 〃 止ネジ	1
53	137142	" " " " " " " washer	〃 〃 〃 〃 座金	1
54	193179-2	" " " " " " " guide pin	〃 〃 〃 案内ピン	1
55	193180	" " " " " take-up	片振り腕糸道	1
56	62-1	" " " " " " " screw	〃 〃 〃 止ネジ	2
57	192123	" " " " " tension post	飾り糸調子棒(短)	1
58	192127A	" " " " " spring spacer	〃 〃 バイブB	1
59	192148	" " " " " spring	〃 〃 バネ(中)	1
60	200361	" " " " " guide	〃 〃 〃 台	1
61	5372	" " " " " nut	〃 〃 ナット	1
62	192124	" " " " " spring bushing	〃 〃 〃 止バイブ	1
63	192126	" " " " " disc	〃 〃 〃 皿	2

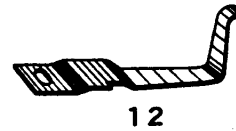
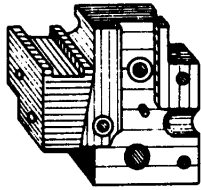
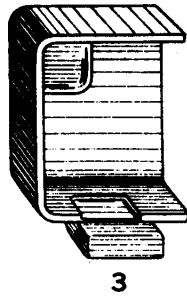
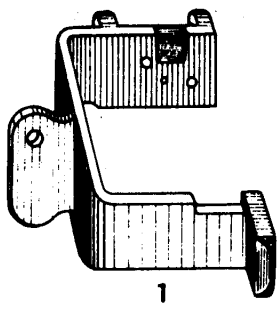

8

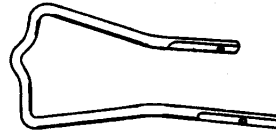
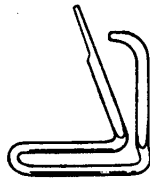
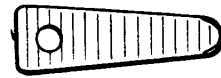

14

15

16

18

20

21

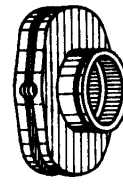

22

23

24

25

26

27

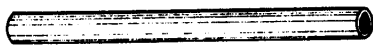

28

29

30

31

32

33

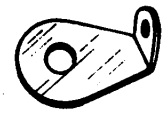

34

35

36

37

38

39



40

41

## LOOPER THREAD PARTS

### 裏糸調子機構

Ref. No. 参照番号	Parts No. 部品番号	Name	名称	Qt. 数量
1	192107 A	Looper thread take-up cover bracket	裏糸道カバー	1
2	107-1	" " " " " screw	止ネジ	2
3	192108	" " " cover	蓋	1
4	107-2	" " " " hinge pin	クビンネジ	1
5	192109	" " " " latch	板バネ	1
6	1175-2	" " " " " screw	止ネジ	1
7	167061	" " " " " washer	座金	1
8	192110	" " " control bracket	下糸調子取付台	1
9	5328	" " " " " screw	止ネジ	2
10	192111	" " " " finger	下糸弛メ	1
11	5328	" " " " " screw	止ネジ	2
12	192112	" " " nipper spring (upper)	下糸調節板バネ上	1
13	1175-2	" " " " " screw	止ネジ	1
14	167063	" " " " (lower)	下	1
15	192114	" " " " cast-off wire	下糸捌キ	1
16	5373	" " " " " screw	止ネジ	1
17	192114-2	" " " " " pin	止ピン	1
18	192116	" " " take-up eyelet	下糸二又糸道	1
19	192115	" " " " " spring	押エバネ	1
20	42-1	" " " " " screw	止ネジ	1
21	1170-3	" " " " " stop screw	当リネジ	1
22	44-3	" " " " " stop lock screw	止ネジ	1
23	192117	" " " controller cam	下糸調節器小	1
24	5373	" " " " " screw	止ネジ	1
25	192118	" " " nipper spring cam	中	1
26	192119	" " " take-up	大	1
27	65-1	" " " " " screw	止ネジ	1
28	192120	" " " tube	下糸道パイプ	1
29	198177	" " " " clamp	止金	1
30	30-1	" " " " " screw	止ネジ	1
31	192121	" " " eyelet	筒中糸道	1
32	62-1	" " " " " screw	止ネジ	1
33	192123	" " " tension post	下糸調子芯棒	1
34	5372	" " " " nut	ナット	1
35	192124	" " " " spring bushing	止パイプ	1
36	192125	" " " " spring	バネ(細)	1
37	192126	" " " " disc	皿	2
38	192127 A	" " " " post spacer	棒パイプB	1
39	202849	" " " " guide	台	1
40	192122	" " " " guide wire	筒前糸道	1
41	62-1	" " " " " screw	止ネジ	1

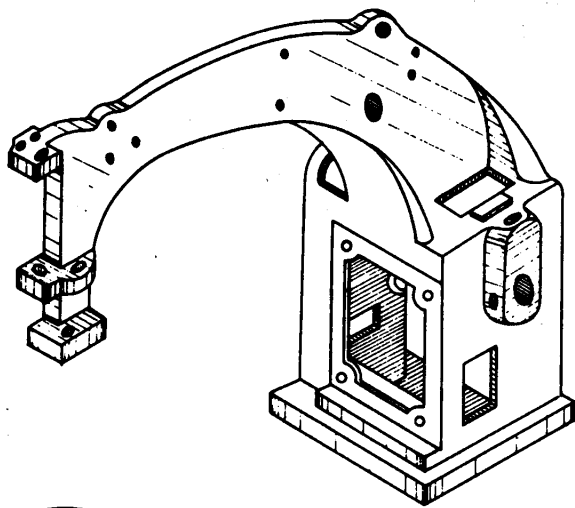

• DV-1 •  
2



3



4



5



6

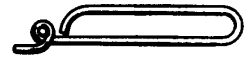

7

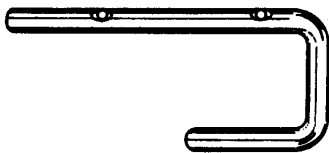

8

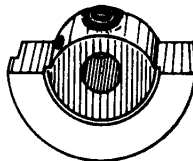

9



10



11



12



13

**PARTS FOR MODEL DV-1 ONLY**

**DV-1型専用部品**

<u>Ref. No.</u> 参照番号	<u>Parts No.</u> 部品番号	<u>Name</u>	<u>名称</u>	<u>Qt.</u> 数量
1	191001	Machine arm	アーム	1
2	200370	Model plate	型式板	1
3	191012	Main shaft bushing (left)	大シャフトブッシュ小(段付)	1
4	200493	" " " " oil wick	" " " 給油フェルト	1
5	191052	Looper	ルーパー	1
6	191079	Presser bar	押工棒	1
7	191138	Needle thread eyelet	土台糸道	1
8	191145A	Thread guide	L型糸道	1
9	191011	Main shaft counter balance	モーション	1
10	6-1	" " " " spot screw	" 止ネジ(先有)	1
11	14-1	" " " " set screw	" " (先無)	1
12	191154	Needle thread take-up eyelet	針棒クランク巻糸道	1
13	62-1	" " " " screw	" 止ネジ	1

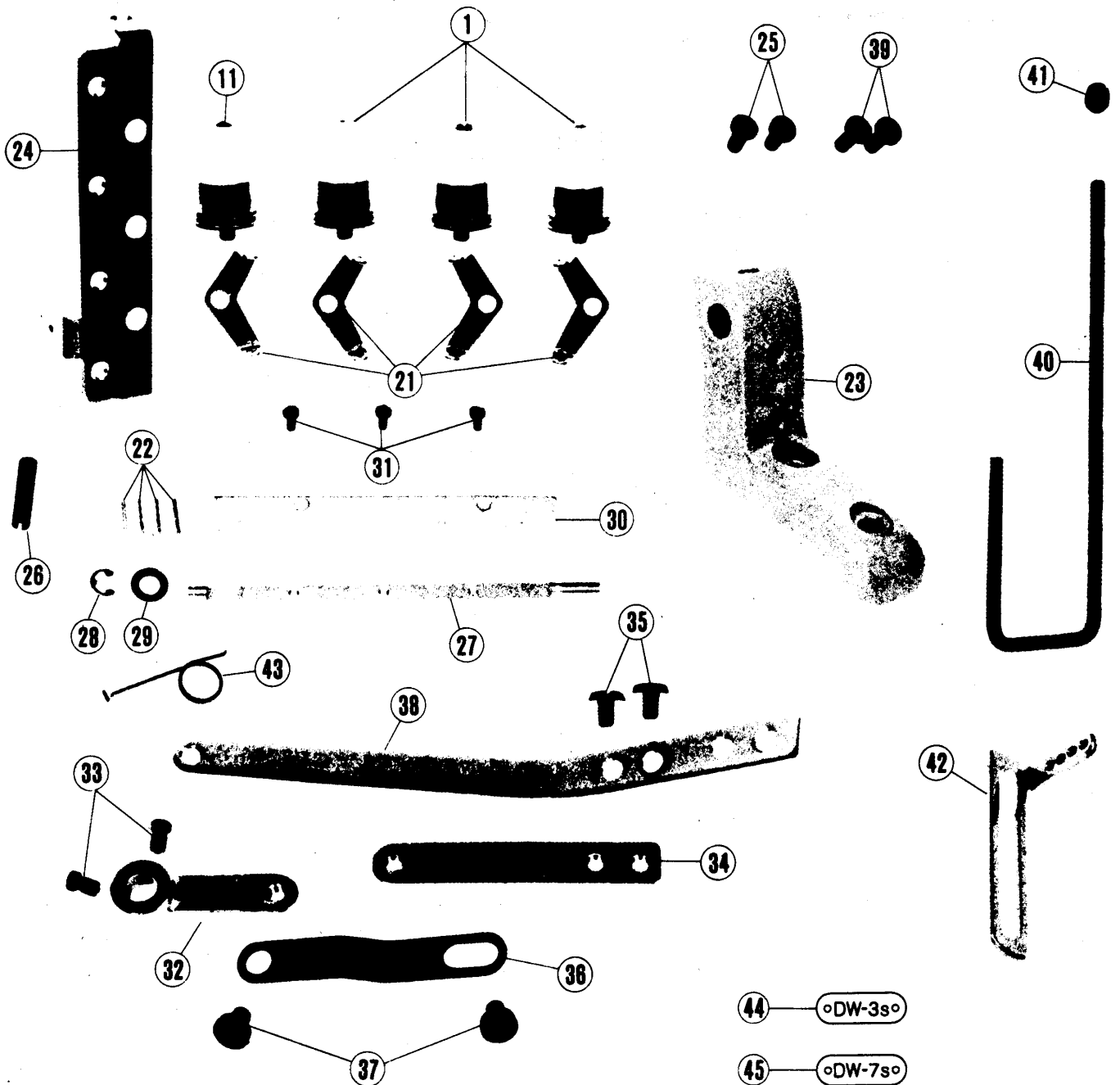
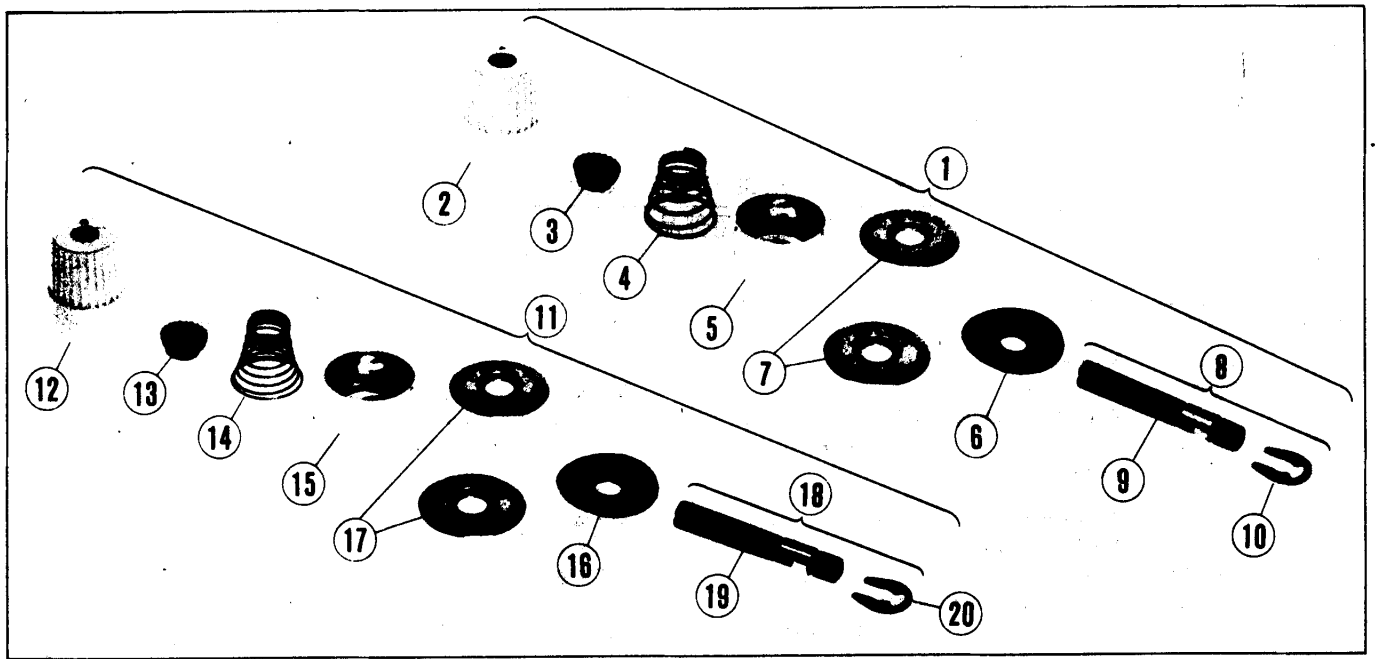

## DW-3s and DW-7s SPECIFIC PARTS

### DW-3s・DW-7s専用

Ref. No. 参照番号	Parts No. 部品番号	Name	名称	Qt. 数量	Remarks 備考
1	207110	Needle thread tension complete	針糸調子(組)	3	Complete with Ref. No. 2~8 参照番号2~8ノ組
2	208447	Tension nut	調子ナット	3	
3	208448	Pipe	パイプ	3	
4	201037	Tension spring (heavy)	圧縮バネ(強)	3	
5	306359	Cup	受皿	3	
6	208449	Felt	フェルト	3	Complete with Ref. No. 9~10 参照番号9~10ノ組
7	210319	Disc	皿	6	
8	306306	Post complete	段付ネジ(組)	3	
9	306307	Post	段付ネジ	3	
10	200983	Retaining ring	止メ輪	3	
11	207112	Spreader thread tension complete	飾り糸調子(組)	1	Complete with Ref. No. 12~18 参照番号12~18ノ組
12	208447	Tension nut	調子ナット	1	
13	208448	Pipe	パイプ	1	
14	201068	Tension spring (light)	圧縮バネ(弱)	1	
15	306359	Cup	受皿	1	
16	208449	Felt	フェルト	1	Complete with Ref. No. 19~20 参照番号19~20ノ組
17	210319	Disc	皿	2	
18	306306	Post complete	段付ネジ(組)	1	
19	306307	Post	段付ネジ	1	
20	200983	Retaining ring	止メ輪	1	
21	207183	Thread guide	糸道	4	
22	149029	Pin	平行ピン	4	
23	149027-ED	Thread tension bracket base	糸調子台ブラケット	1	
24	149028	Thread tension bracket	糸調子台	1	
25	5117	Screw	" 止ネジ	2	
26	201291	Pin	スプリングピン	1	
27	149030	Thread tension release shaft	糸弛メ軸	1	
28	202522	Ring	" 止メ輪	1	
29	202868	Washer	" 座金	1	
30	149031	Thread tension release plate	糸弛メ押し板	1	
31	1189	Screw	" " 止ネジ	3	
32	149032	Upper lever	糸弛メレバー(上)	1	
33	5084	Screw	" " 止ネジ	2	
34	149033	Lower lever	糸弛メレバー(下)	1	
35	5214	Screw	" " 止ネジ	2	
36	206157	Link	糸弛メリンク	1	
37	5386	Screw	" " 止ネジ	2	
38	192073	Foot lift lever	押エ足揚レバー	1	
39	42-1	Screw	" " 止ネジ	2	
40	192145A	Thread guide bar	糸道棒	1	
41	5234	Screw	" 止ネジ	1	
42	149034	Thread guide	糸道	1	
43	149035	Spring	ネジリバネ	1	
44	149038	Type plate for model DW-3s	型式板(DW-3s)	1	
45	149039	Type plate for model DW-7s	" (DW-7s)	1	
46	149036Z	Tension releacer complete DW-3s	糸弛メ装置一式(DW-3s用)	1	参照番号1, 11, 21~43ノ組 参照番号1, 21~43ノ組
47	149037Z	Tension releacer complete DW-7s	糸弛メ装置一式(DW-7s用)	1	



1



2

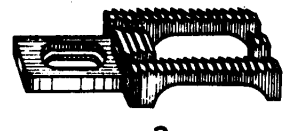

3

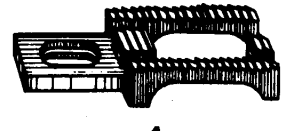

4

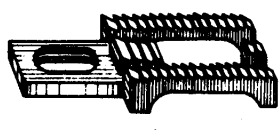

5



6

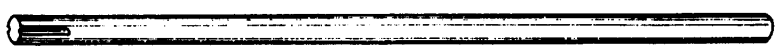

7

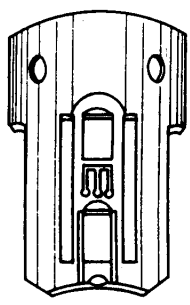

8

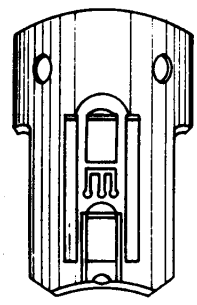

9

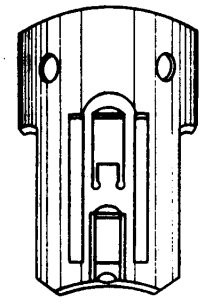

10

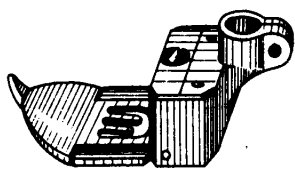

11

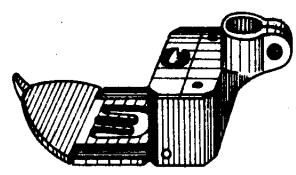

12

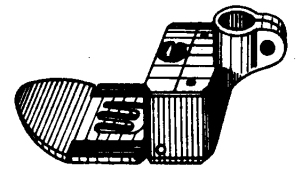

13

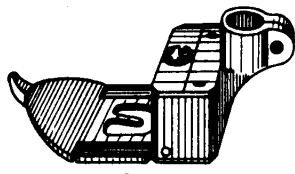

14

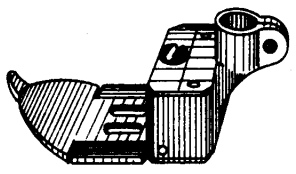

15

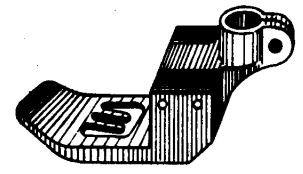

16

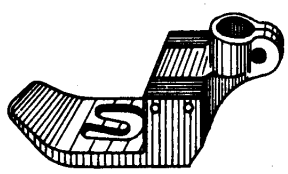

17



LIST OF GAUGE PARTS  
ゲージパーツ表

Model	Needle gauge	Ref. No.	Needle clamp	Ref. No.	Feed dog	Ref. No.	Needle bar	Ref. No.	Needle plate	Ref. No.	Presser foot (solid)	Ref. No.	Presser foot (hinged)	Remarks
機種	針 巾	参照番号	針 抱	参照番号	送り曲	参照番号	針 棒	参照番号	針 板	参照番号	押工(固定)	参照番号	押工(自由)	備考
D W-3	5.5mm	1	192071	3	200478	6	192063	8	200475	11	* 200483	16	200585	Standard model (標準型)
										12	** 200482			
	5.5mm	1	192071	4	200477	6	192063	9	*** 200479	13	*** 193084	16	200585	
D W-7	3.2mm	1	192071	5	200442	7	200359	10	200444	14	200451	17	200587	
	4.0mm	1	192071	5	200442	7	200360	10	200445	14	200452	17	200586	Standard model (標準型)
D V-1	5.0mm	2	191071A	5	200442	7	191063	10	191031	15	191084			Standard model (標準型)
	6.35mm	2	191071A	5	200450	7	200449	10	200446	15	200440			

\* 200483.....Chaining-off fingers are of unequal length. (爪差付)  
 \*\* 200482.....Chaining-off fingers are of equal length. (爪差無)  
 \*\*\* 200479.....Without guide tips. (案内金無)  
 \*\*\*\* 193084.....Without guide tip. (案内金兼)

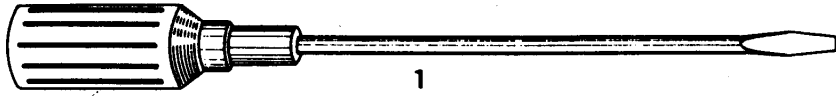

1



2

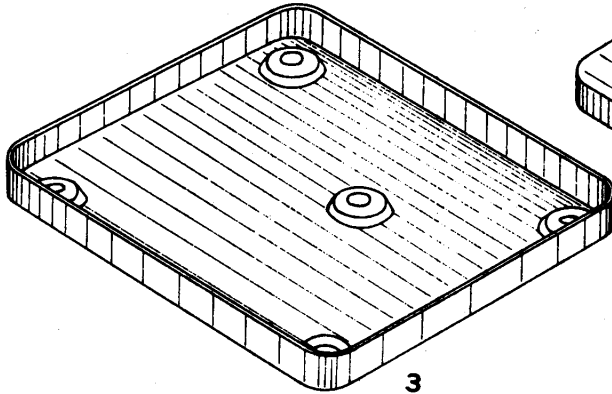

3

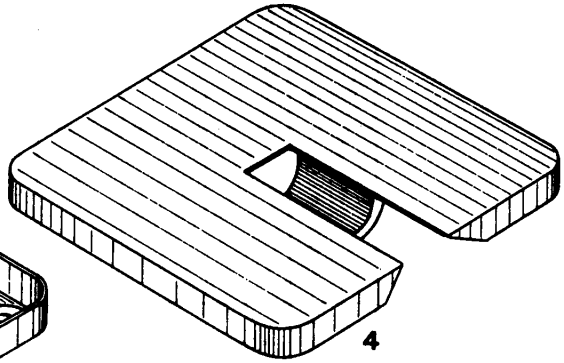

4

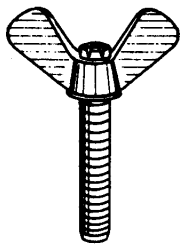

5

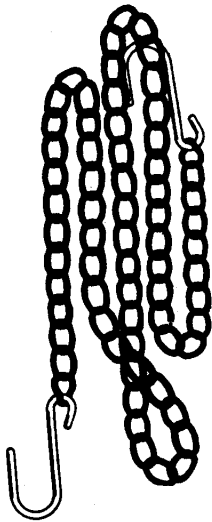

6



7

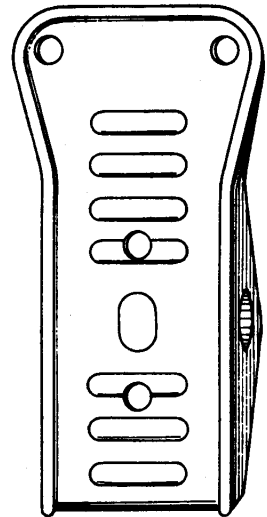

8



9



10

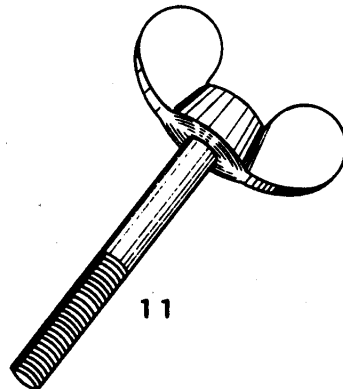

11

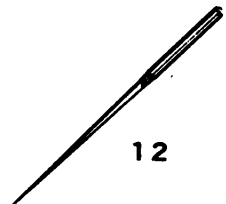

12

**ACCESSORIES**

**付 属 品**

Ref. No. 参照番号	Parts No. 部品番号	Name	名 称	Qt. 数量
1	127	Screw driver (large)	ドライバー(大)	1
2	128	" driver (medium)	〃 (中)	1
3	200486	Oil pan	オイルパン	1
4	191155	Auxiliary plate	差し板	1
5	206	" " thumb screw	〃 蝶ボルト	1
<hr/>				
6	126	Treadle chain	クサリ	1
7	132	Oiler (containing 50cc oil)	油差シ(50cc入り)	1
8	121	Treadle	靴(組)	1
9	130A-9.5	Combination wrench (9.5mm)	スパナ(9.5mm)	1
10	131A	Tweezers	ピンセット	1
<hr/>				
11	9207	Machine thumb screw	蝶ネジ	1
12	DVx1	Needle (DVx1 #11)	針(DVx1 #11)	10

# NUMERICAL INDEX OF PARTS

## 部品番号索引

Parts No.	Page	Ref. No.	Parts No.	Page	Ref. No.	Parts No.	Page	Ref. No.	Parts No.	Page	Ref. No.	Parts No.	Page	Ref. No.
部品番号	頁	参照番号	部品番号	頁	参照番号	部品番号	頁	参照番号	部品番号	頁	参照番号	部品番号	頁	参照番号
3-1	5	2	62-1	3	20	191079	19	6	192073	13	7	193095	15	19
3-2	5	3	62-1	7	23	191084	21	15	192074	13	9	193098	15	20
6-1	5	10	62-1	15	32	191134 A	3	18	192075	13	10	193170	15	22
6-1	5	13	62-1	15	47	191138	19	7	192076 B	13	14	193171	15	24
6-1	5	17	62-1	15	56	191143	7	44	192077	13	3	193172	15	28
6-1	5	20	62-1	17	32	191145 A	19	8	192078	13	22	193173	15	26
6-1	19	10	62-1	17	41	191154	19	12	192079	13	17	193174	15	31
6-2	5	11	62-1	19	13	191155	23	4	192079-2	13	21	193175	15	46
6-2	5	18	64-1	7	25	192001	3	1	192081	13	11	193179	15	51
6-2	7	43	64-1	15	27	192002 A	3	2	192081-1	13	12	193179-2	15	54
8-1	5	15	65-1	7	27	192003	5	1	192081-2	13	13	193180	15	55
11-1	3	30	65-1	7	47	192004	5	4	192083	13	5	200334	5	25
11-1	5	22	65-1	15	23	192005	5	5	192086	15	2	200356	3	6
11-1	9	7	65-1	17	27	192006	5	9	192087	15	5	200359	21	7
11-1	9	11	71-1	7	46	192007	5	12	192088	15	8	200360	21	7
11-1	9	20	71-4	7	40	192008	5	14	192089	15	11	200361	7	54
11-1	11	5	83-1	13	6	192009	5	16	192090	15	14	200361	15	60
11-1	15	45	87-1	15	6	192010	5	19	192091	15	16	200361	17	39
14-1	11	3	89-1	15	12	192012	5	23	192092	15	18	200366	3	7
14-1	11	18	102-1	15	36	192013	11	1	192100	15	33	200370	19	2
14-1	19	11	102-2	15	37	192014	11	2	192102	15	35	200371	7	41
16-2	9	2	106-2	13	20	192015	11	15	192103	15	38	200372	7	42
16-2	9	6	107-1	17	2	192016	11	4	192104	15	40	200384	3	9
16-2	11	6	107-2	17	4	192017	11	8	192105	15	44	200385	9	23
16-2	15	9	109-1	15	29	192018	11	9	192107 A	17	1	200386	9	28
24-1	7	33	109-1	15	52	192019	11	12	192108	17	3	200387	7	1
24-1	7	35	109-1	17	6	192020	11	13	192109	17	5	200388	7	26
24-1	11	21	109-1	17	13	192021	11	14	192110	17	8	200389	7	21
24-1	13	4	120-2	17	29	192022	11	16	192111	17	10	200389	9	4
24-1	13	16	121	23	8	192023	11	17	192112	17	12	200389	9	9
24-1	13	23	123-1	7	55	192024	11	20	192114	17	15	200390	5	8
26-1	9	15	123-1	15	61	192025	11	22	192114-2	17	17	200390	7	20
26-1	9	29	123-1	17	34	192026	11	24	192115	17	19	200390	11	7
26-1	11	25	126	23	6	192027	11	23	192116	17	18	200440	21	15
28-1	9	22	127	23	1	192028	11	10	192117	17	23	200442	21	5
28-1	9	30	128	23	2	192029	9	8	192118	17	25	200443	13	15
28-1	9	38	128-2	3	11	192029	11	19	192119	17	26	200444	21	10
28-1	11	11	129-1	3	14	192032	9	1	192120	17	28	200445	21	10
28-1	15	13	130 A-9.5	23	9	192033	9	5	192121	17	31	200446	21	10
28-1	15	17	131 A	23	10	192035	9	10	192122	17	40	200449	21	7
30-1	11	26	132	23	7	192036	9	14	192123	7	51	200450	21	5
30-1	17	30	132-1	3	17	192037	9	16	192123	15	57	200451	21	14
31-1	7	48	143-1	7	45	192038	9	18	192123	17	33	200452	21	14
31-1	17	16	144-2	3	28	192040	9	19	192124	7	56	200475	21	8
31-1	17	24	206	23	5	192041	9	21	192124	15	62	200477	21	4
32-2	9	3	1092	15	49	192045	9	31	192124	17	35	200478	21	3
32-2	15	15	1231	9	45	192046	9	32	192125	17	36	200479	21	9
35-2	9	12	1333	15	25	192047	9	34	192126	7	57	200482	21	12
35-3	9	13	2022-3	5	6	192048	9	36	192126	15	63	200483	21	11
35-3	15	41	2022-3	5	24	192049	9	37	192126	17	37	200486	23	3
42-1	3	24	5306	7	7	192050	9	39	192127 A	17	38	200492	15	7
42-1	9	24	5307	7	2	192051	9	40	192127 A	7	52	200493	5	7
42-1	13	8	5308	7	3	192052	9	42	192127 A	15	58	200493	19	4
42-1	17	20	5309	15	4	192053	9	44	192128	3	10	200585	21	16
44-3	7	31	5310	3	22	192055	7	4	192129 A	3	12	200586	21	17
44-3	9	26	5311	3	3	192056	7	8	192130	3	15	200587	21	17
44-3	13	18	9070-2	7	38	192057	7	9	192131	3	13	200653	7	28
44-3	15	21	9207	23	11	192058	7	10	192132	3	16	200654	7	29
44-3	17	22	137010	3	4	192059	7	11	192133	3	19	200654	9	25
46-1	9	33	137011 G	3	5	192059-1	7	13	192137	3	21	201767	15	10
46-1	13	24	137011 G	3	8	192060	7	14	192138	3	23	202024	5	26
46-1	15	34	137108	15	48	192061	7	18	192138-3	3	26	202175	7	5
46-1	15	39	137109	15	50	192062	7	22	192144 A	3	27	202175	7	15
46-1	17	9	137142	3	25	192063	21	6	192145 A	3	29	202175	7	30
46-1	17	11	137142	15	53	192064	7	24	192150	7	49	202175	9	27
46-1	17	21	167061	15	30	192068	7	32	192152	7	53	202175	15	3
47-1	9	35	167061	15	42	192069	7	34	192153 A	7	50	202473	9	46
51-1	9	41	167061	17	7	192070	7	36	192154	9	17	202473	9	47
51-2	9	43	167063	17	14	192070-1	7	37	192148	15	59	D V x 1	23	12
55-1	7	6	191001	19	1	192071	21	1	193011	5	21			
59-1	7	12	191011	19	9	192071 A	21	2	193080	13	19			
59-1	7	19	191012	19	3	192071-3	7	39	193084	21	13			
60-1	7	16	191052	19	5	192072	13	1	193085	15	1			
60-2	7	17	191063	21	7	192072-1	13	2	193093	15	43			

PART NO.	PAGE	REF. NO.
208448	21	3
208448	21	13
208449	21	6
208449	21	16
210319	21	7
210319	21	17
306306	21	8
306306	21	18
306307	21	9
306307	21	19
306359	21	5
306359	21	15





■ PEGASUS  
SEWING MACHINE MFG.  
CO., LTD.®

