

SINGER
51W32,W100

HISTORICAL COPY

Form 2008 w
October, 1926
PRINTED IN U. S. A.

~~DO NOT REMOVE~~
PARTS DEPARTMENT
PARTS CATALOG

LIST
OF
PARTS



MACHINES
Nos. 51w32 and 51w100

THE SINGER MANUFACTURING COMPANY

INDEX

COPYRIGHT, U. S. A.,
1916, 1919, 1920, 1921, 1922 AND 1923,
BY THE SINGER MANUFACTURING COMPANY
ALL RIGHTS RESERVED FOR ALL COUNTRIES

	PAGE
ACCESSORIES	18
BOBBIN WINDER	18
FOOT LIFTER	19
MACHINE No. 51W32	7
" " 51W100	17
NUMERICAL LIST OF PARTS	23
ROLLER PRESSERS	20
WOOD BASE (FLAT)	22
" " (OBLIQUE)	22
WORK PLATE PLATFORM	22

Instructions for Ordering

In ordering from this list, use **ONLY** the **PART** number in the **FIRST** column.

The number stamped on a Sewing Machine Part is the number of the Single Part only, except when the part includes Set Screws, Clamping Screws, Studs and Rollers Spun on, Small Wires riveted, or Parts soldered together, etc., which it is necessary to furnish in combination.

Every combination of parts sent out has its specific number which, although not stamped on Parts (except in above cases) must be used when ordering the combination.

Each number always indicates the **SAME PART** in whatever list it appears, or for whatever Machine.

The letters after some of the numbers indicate the style of finish only, as follows:

- A. Hardened, Polished and Plated.
- B. Polished and Plated.
- C. Hardened only.
- D. Polished only.
- E. Soft, not polished.
- F. Hardened and Polished.
- H. Blued.

These letters **MUST BE USED** when they appear in the list and **AFTER** the number, as in the list.

In this series

- 200001 to 201500 are Screw Numbers.
- 201501 to 201800 are Nut Numbers.
- 201801 to 202000 are Roller Numbers.
- 202001 and upward are numbers of Machine Parts.

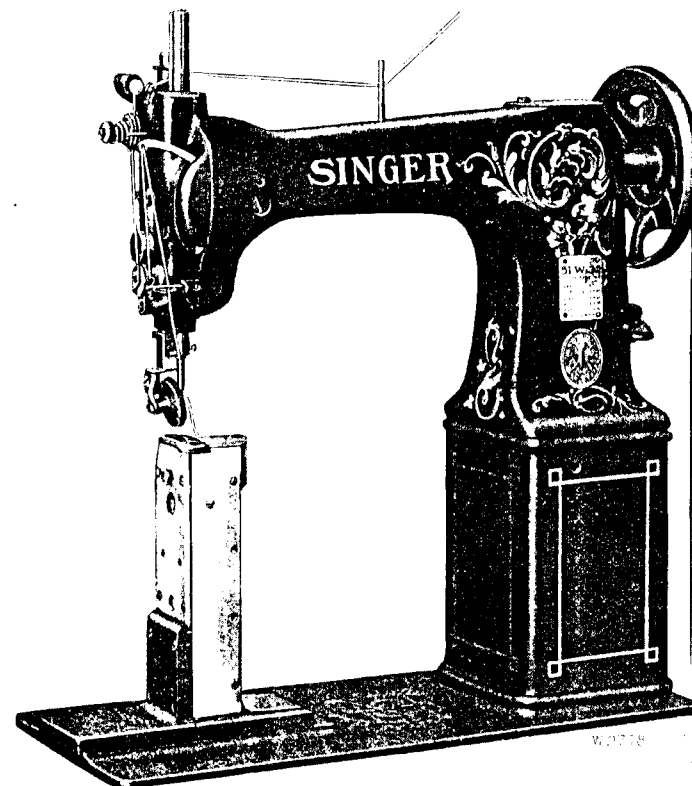
The figures in the second column refer only to the plate in which the illustration of the part is shown and are **NOT TO BE USED** in ordering.

Two or more numbers over a cut indicate that the difference between such parts is not visible in an illustration.

Parts marked with an asterisk (*) are furnished only when repairs are made at the factory.

LIST OF PARTS COMPLETE

FOR



MACHINE No. 51w32

DROP FEED. ROLLER PRESSER

For Heavy Leather and Legging Work

No.	Plate	Name
*221258	---	Arm with 200439c, 202036 and 204705
*213434	---	Arm Base
204235	13997	" " Position Pin (2)
200010e	11763	" " Screw (3)
202005	12374	" " Washer (3)
204163	12344	" Cap
200278H	12311	" " Screw

No.	Plate	Name
202248	13997	Arm Cap Screw Washer
10554	13997	" Position Pin (2)
200963E	12311	" Screw (3)
202005	12374	" " Washer (3)
203202	11561	" Shaft
204705	11562	" " Bushing (front)
200439C	12311	" " " Position Screw ..
213432	11561	" " Connection with four 200054E (2)
200054E	13335	Arm Shaft Connection Screw
202299	—	" " Oil Packing (wick) (2)
204805	11561	Balance Wheel, 5 $\frac{1}{2}$ in. diam. (belt groove 2 $\frac{3}{4}$ in. diam.), with 200328C and 200335C
200062H	12311	Balance Wheel Adjusting Screw ..
200328C	12311	" " Position Screw
200335C	12311	" " Set Screw
*221201	—	Bed with 203248, 203249, two each 200362C, 200516E, 200840E and 202299
202258	12153	Bed Hinge Connection (2)
200570E	12311	" " " Screw (4)
203470	13997	Bobbin
*203498	—	" Case
203648	13997	" " Latch
*202056	—	" " " Pin
203473	13997	" " " Plunger
203474	13997	" " " Spring
234079	13997	" " Lever
234065	13997	" " " Driving Block
200076D	13997	" " " " "
		Screw
201272C	13335	Bobbin Case Lever Hinge Screw ..
203214	13997	" " Tension Spring
200984C	13997	" " " " Regu- lating Screw
200594C	13997	Bobbin Case Tension Spring Screw
203216	—	" " Washer (cloth)
203500	13335	Bobbin Case complete, Nos. 200594C, 200984C, 202056, 203214, 203216, 203473, 203474, 203498 and 203648
204184	11561	Face Plate with 200355H, 200368H, 200688C, 202090, 204185, 204281 and two 200397H
200053C	12311	Face Plate Screw
204185	13997	" " Thread Guide
200397H	12309	" " " " Set Screw

No.	Plate	Name
221205	—	Face Plate complete, Nos. 200113E, 200135E, 200309E, 200319C, 200577H, 204059, 204184, 204267, 204277 to 204280, 204330 and 221223
213426	11762	Feed Bar
213425	—	" " 213426 with 200214E, 201525E and 221508
200214E	13335	Feed Bar Hinge Screw
201525E	13335	" " " " Nut
221250	11774	" Dog
203609	11762	" " Lever with 200098E
200362C	10441	" " " Adjusting Screw
201524E	13335	" " " " "
		Check Nut
200263F	11763	Feed Dog Lever Hinge Screw
201528D	11763	" " " " " Nut ..
221206	11775	" " " Post
221210	—	" " " " 221206 with 200265E, 201525E, 203609, 203610, 221211, 221212, four each 200054E and 200578H
221209	11562	Feed Dog Lever Post Cover (back)
221260	11562	" " " " " (front)
200159F	11778	" " " " " "
		Clamp Screw
221211	11562	Feed Dog Lever Post Cover (side) with 200362C and 201524E
200583H	11763	Feed Dog Lever Post Cover (back or front) Screw
200578H	11763	Feed Dog Lever Post Cover (side) Screw
200024C	11763	Feed Dog Lever Post Screw (2)
221212	11562	" " " " Support
200054E	13335	" " " " "
		Screw
200008C	11778	Feed Dog Lever Post Support Screw (2)
203637	11763	Feed Dog Lever Post Support Screw Washer (2)
203610	11763	Feed Dog Lever Slide Block
200265E	11763	" " " " " Hinge Screw
201525E	13335	Feed Dog Lever Slide Block Hinge Screw Nut
200098E	13335	Feed Dog Screw
213428	11763	" Driving Cam with 200382C and 200437C
213429	11762	Feed Driving Cam Fork Lever with 204195 and 204293

No.	Plate	Name
213427	11762	Feed Driving Cam Fork Lever Connection with 200668c and 201525E
204194	11763	Feed Driving Cam Fork Lever Connection Clamp with 200031c
200031c	12311	Feed Driving Cam Fork Lever Connection Clamp Pinch Screw
200668c	13335	Feed Driving Cam Fork Lever Connection Clamp Screw Stud
201525E	13335	Feed Driving Cam Fork Lever Connection Clamp Screw Stud Nut
200002E	13335	Feed Driving Cam Fork Lever Connection Hinge Screw
201522E	13335	Feed Driving Cam Fork Lever Connection Hinge Screw Nut
*204195	—	Feed Driving Cam Fork Lever Shaft
204197	11763	“ “ “ “ Collar with 200113F
200113F	12225	Feed Driving Cam Fork Lever Shaft Collar Set Screw
204293	12374	Feed Driving Cam Fork Lever Shaft Position Pin
204196	13335	Feed Driving Cam Fork Lever Shaft Sleeve (split)
200043c	12311	Feed Driving Cam Fork Lever Shaft Sleeve Set Screw
201524E	13335	Feed Driving Cam Fork Lever Shaft Sleeve Set Screw Nut
213693	11762	Feed Driving Cam Fork Lever complete, Nos. 204194 and 213429
200437c	12311	Feed Driving Cam Position Screw
200382c	13997	“ “ “ Set Screw
204199	13998	“ “ Rock Shaft
213495	—	“ “ “ “ 204199 with 200002E, 201522E and 213427
202305	13335	Feed Driving Rock Shaft Center (2)
200043c	12311	“ “ “ “ “ Set Screw (2)
221508	11763	Feed Driving Rock Shaft Crank with two 200383c
200383c	12311	Feed Driving Rock Shaft Crank Set Screw
213007	11763	Feed Lifting Cam with 202126
204202	12374	“ “ “ Fork with 200027E
200027E	13335	“ “ “ “ Pinch Screw
202126	12374	“ “ “ Position Pin
200045E	13335	“ “ “ Screw
203305	11762	“ “ Rock Shaft
203315	11762	“ “ “ “ 203305 with 203238

No.	Plate	Name
202305	13335	Feed Lifting Rock Shaft Center (2)
200043c	12311	“ “ “ “ “ Set Screw (2)
202276	12374	Feed Lifting Rock Shaft Slide Block
203238	12374	Feed Lifting Rock Shaft Slide Block 202276 with 200243E and 201531E
200243E	13335	Feed Lifting Rock Shaft Slide Block Hinge Screw
201531E	12374	Feed Lifting Rock Shaft Slide Block Hinge Screw Nut
204206	13335	Feed Regulating Handle
204207	—	“ “ “ 204206 with 200098F, 202622, 204208 to 204210, 204213 and 204925
204208	13335	Feed Regulating Handle Adjustable Stop
200098F	13335	Feed Regulating Handle Adjustable Stop Screw
204925	13335	Feed Regulating Handle Adjustable Stop Screw Washer
204209	13335	Feed Regulating Handle Position Pin
204210	11763	Feed Regulating Handle Shaft
204211	11763	“ “ “ “ Crank with 200098F
213433	11762	Feed Regulating Handle Shaft Crank Link
200271E	12311	Feed Regulating Handle Shaft Crank Link Hinge Screw (lower)
200291E	13335	Feed Regulating Handle Shaft Crank Link Hinge Screw (upper)
200098F	13335	Feed Regulating Handle Shaft Crank Set Screw
204213	13335	Feed Regulating Handle Shaft Sleeve (split)
200362c	10441	Feed Regulating Handle Shaft Sleeve Set Screw
202622	11763	Feed Regulating Handle Shaft Sleeve Washer
202036	13997	Feed Regulating Handle Stop Pin
213902	—	Feed Regulating Handle complete, Nos. 200291E, 204207, 204211 and 213433
227307	11561	Foot Lifter Lifting Lever
227479	—	“ “ “ “ 227307 with 200262u
227353	—	Foot Lifter Lifting Lever 227479 with 227273

No.	Plate	Name
200262u	11763	Foot Lifter Lifting Lever Hinge Screw
227475	11561	Foot Lifter Lifting Lever Rod with 202302
227273	---	Foot Lifter Lifting Lever Rod 227475 with 206628, 227227 and 227576
204126	11778	Foot Lifter Lifting Lever Rod Clamp with two 200530c
227316	12388	Foot Lifter Lifting Lever Rod Clamp Hook
227576	12388	Foot Lifter Lifting Lever Rod Clamp Hook 227316 with 204126
200530c	11778	Foot Lifter Lifting Lever Rod Clamp Set Screw
202302	11778	Foot Lifter Lifting Lever Rod Cotter Pin
206628	12388	Foot Lifter Lifting Lever Rod Spring
227227	12388	Foot Lifter Lifting Lever Rod Spring Collar with 200113f
200113f	12225	Foot Lifter Lifting Lever Rod Spring Collar Set Screw
*221214	---	Hook (sewing)
221216	13335	" 221214 with 201253f, 201376f and 203251
221217	11774	Hook and Bobbin Case complete, Nos. 203500 and 221216
203242	12344	Hook Bevel Gear, 24 teeth, with two 200383c
200383c	12311	Hook Bevel Gear Set Screw
203242	12344	" " Pinion, 24 teeth, with two 200383c
200383c	12311	Hook Bevel Pinion Set Screw
203306	11562	" Counter Shaft
203244	12374	" " Collar with two 200393c
200393c	12374	Hook Counter Shaft Collar Set Screw
203245	12344	Hook Counter Shaft Driving Gear, 44 teeth, with 200362c and 200439c
213157	---	Hook Counter Shaft Driving Gear 203245 with 200045e and 213007
200439c	12311	Hook Counter Shaft Driving Gear Position Screw
200362c	10441	Hook Counter Shaft Driving Gear Set Screw
203246	12344	Hook Counter Shaft Gear, 22 teeth, with two 200383c

No.	Plate	Name
200383c	12311	Hook Counter Shaft Gear Set Screw
202299	12311	" " " Oil Packing (wick)
200840e	12311	Hook Counter Shaft Oil Packing (wick) Stop Screw
203247	13998	Hook Driving Shaft
203248	11562	" " " Bearing with 202299
202299	---	Hook Driving Shaft Bearing Oil Packing (wick)
202126	12374	Hook Driving Shaft Bearing Position Pin
200516e	12311	Hook Driving Shaft Bearing Screw
203249	12344	" " " Bushing (eccentric)
202299	---	Hook Driving Shaft Bushing Oil Packing (wick)
200362c	10441	Hook Driving Shaft Bushing Set Screw
213141	11778	Hook Driving Shaft Collar with two 200393c
200393c	12374	Hook Driving Shaft Collar Set Screw
203251	13997	Hook Gib
201376f	11778	" " Hinge Screw
201253f	11778	" " Screw
221218	11775	" Post
221219	---	" " 221218 with 200159f, 200555u, 201272c, 202299, 203242, 221209, 221215, 221217, 221221, 221222, 221260, 234065, 234079, two 200076b and eight 200583u ..
202299	---	Hook Post Oil Packing (wick)
200008c	11778	" " Screw (2)
203637	11763	" " " Washer (2)
221215	11762	" " Slide
221221	11775	" Socket
200555u	13997	" " Screw
221222	11774	" Washer
221220	---	Hook Post complete, Nos. 221210 and 221219
208613	---	Needle Bar (hollow)
204247	11562	" " 208613 with 200125f, 200175b and 204250
204248	13997	Needle Bar Connecting Link
200658c	13997	" " " " Hinge Screw Stud
201519e	13997	Needle Bar Connecting Link Hinge Screw Stud Nut



No.	Plate	Name
204249	12374	Needle Bar Connecting Stud with 200072c and 202277
202277	---	Needle Bar Connecting Stud Oil Packing (wick)
200072c	12374	Needle Bar Connecting Stud Pinch Screw
213435	13999	Needle Bar Guard
204326	---	" " Packing Cord (2)
200504E	13999	" " Screw Bushing (lower)
204250	13999	" " Thread Guide
200175D	13999	" " " " Screw ..
200125F	12374	" Set Screw
204252	10441	Presser Bar Lifter
200550c	10441	" " " Hinge Screw ...
204253	10441	" " Lifting Bracket with 200086c
200086c	10441	Presser Bar Lifting Bracket Pinch Screw
204254	10441	Presser Bar Lifting Bracket Position Guide
200362c	10441	Presser Bar Lifting Bracket Position Guide Set Screw
204327	---	Presser Bar Packing Washer (felt)
200504E	13999	" " Screw Bushing (lower)
204258	13999	" " Spring
200491B	10441	" " Thumb Screw (pressure regulating)
201906	13999	Roller Presser, 1 $\frac{1}{4}$ in. diam., $\frac{3}{8}$ in. face (fine), with 200548c and 201534H
202839	11767	Roller Presser Arm
204567	13999	" " " 202839 with 201906
202560	12225	Roller Presser Arm Bracket (swing)
202838	---	Roller Presser Arm Bracket 202560 with 200096b and 204567
200675c	12225	Roller Presser Arm Bracket Position Screw Stud
202558	12225	Roller Presser Arm Bracket Spring
202559	12225	" " " " " "
200141F	12225	Roller Presser Arm Bracket Spring Stop
200096b	12225	Roller Presser Arm Screw
204495	12225	" " Bar
200548c	13999	" " Hinge Screw
201534H	12225	" " " " Nut

No.	Plate	Name
204496	---	Roller Presser and Bar complete, Nos. 200675c, 202558, 202559, 202838, 204495 and two 200141F..
202068	12153	Spool Holder Base
200575H	12311	" " " Screw
204296	12153	" " Wire
200079H	12311	" " " Hinge Screw ...
204297	12153	Spool Holder complete, Nos. 200079H, 202068 and 204296
213006	11778	Take-up Cam with 200335c, 200383c, 200430c, 200658c and 201519E ...
203172	13999	Take-up Cam Friction Washer
200430c	12311	" " Position Screw
200383c	12311	" " " " Check Screw
200335c	12311	Take-up Cam Set Screw
204262	13999	" Lever
206556	---	" " 204262 with 204263 ..
204263	13999	" " Bearing with 204264..
204264	13999	" " " Position Pin ...
200042F	12311	" " " Screw
201816	13999	" " Roller
204266	---	Take-up Lever complete, Nos. 200042F, 201816 and 206556
202402	12309	Tension Disc
202090	12309	" " Position Pin
204267	14000	" Release Lever
200688c	11778	" " " Position Screw
200309E	12309	" " " Screw
202075	12309	" " Plunger
208489	14000	" " Slide
206608	14000	" " " Spring
225708	14000	" Spring
201375J	14000	" Stud
200397H	12309	" " Set Screw
201572B	10881	" Thumb Nut
204271	12309	" Washer
221223	11774	Tension complete, Nos. 201375J, 201572B, 202075, 204271, 225708 and two 202402
204273	14000	Thread Controller Adjusting Collar with 200684H (for Presser Bar)..
200684H	14000	Thread Controller Adjusting Collar Screw
204274	12309	Thread Controller Plate
200577H	12311	" " " Screw
202098	12309	" " Roller
204275	12309	" " " Guard
202084	12309	" " " " Washer

No.	Plate	Name
200300c	12309	Thread Controller Roller Screw ..
204276	12309	" " Spring
204333	12309	" " " Guard
200581H	12309	" " " " Screw..
204277	12309	" " " Stop
204278	12309	" " " " Driving Gear
200319c	12309	Thread Controller Spring Stop Driving Gear Hinge Screw
200135E	12309	Thread Controller Spring Stop Screw
204279	12309	Thread Controller Spring Stud with 204925
200355H	14000	Thread Controller Spring Stud Set Screw
204925	13335	Thread Controller Spring Stud Washer
205987	12309	Thread Controller complete, Nos. 200300c, 200581H, 202084, 202098, 204274, 204275 and 204333
204280	12309	Thread Controller and Spring com- plete, Nos. 204276 and 205987 ..
202413	14000	Thread Guide
204329	---	" Oiler (felt)
204330	12225	" " Bracket with 204329 ..
200113F	12225	" " " Screw
204281	12309	" Retainer Guide Wire
202091	12309	" " Sleeve
202092	12309	" " Spring
204058	12309	" " Stud
200368H	12309	" " " Set Screw
204059	12309	Thread Retainer complete, Nos. 202091, 202092 and 204058
221238	11774	Throat Plate, 38 needle hole, for needle sizes 23 and 24
200577H	12311	Throat Plate Screw (2)

MACHINE No. 51w100

DROP FEED. ROLLER PRESSER

For Heavy Leather and Leggin Work

Same as No. 51w32 with the following exceptions:

No.	Plate	Name
*204290	----	Arm with 200439c, 202036 and 204705, in place of 221258
213622	11561	Arm Shaft, in place of 203202
*221203	----	Bed with 203248, 203249, two each 200362c, 200516E, 200840E and 202299, in place of 221201
204294	13998	Feed Driving Rock Shaft, in place of 204199
221213	----	Feed Driving Rock Shaft 204294 with 200002E, 201522E and 213427, in place of 213495
202781	11561	Foot Lifter Lifting Lever, in place of 227307
227306	----	Foot Lifter Lifting Lever 202781 with 200262H, in place of 227479
213624	13998	Hook Driving Shaft, in place of 203247

ACCESSORIES

FOR MACHINE No. 51w32

No.	Plate	Name
203470	13997	Bobbin (5)
*225482	—	" Case Screw Driver Blade ..
*225483	—	" " " " Handle ..
225497	12153	Bobbin Case Screw Driver complete, Nos. 225482 and 225483 ..
225487	11778	Roller Presser Hinge Screw Nut Wrench
128 x 6	—	Needles, twist point, six, size 25 ..
225191	—	Drip Pan with four wood screws $\frac{1}{2}$ in., No. 5
41400	12153	Machine Rest Pin (wood)
120342	12153	Oiler (copper plated) with 120343..
120343	12153	" Spout, 3 $\frac{1}{2}$ in. long
*225484	—	Screw Driver Blade
*225485	—	" " Handle
225498	12153	Screw Driver complete (7 $\frac{1}{2}$ in. long), Nos. 225484 and 225485 ..
225554	12153	Wrench (steel)

BOBBIN WINDER

Swing Automatic, Right Hand

225453	10884	Frame with 202277 and 225438 ..
225454	10884	" Hinge Pin
202277	—	" Oil Packing (wick)
225438	10884	" " Well Cap
225455	10884	" Spring
225456	10884	" " Plunger
202473	10885	Pulley with 200380c
200380c	14000	" Set Screw
225381	10884	Spindle
225444	10884	Stop Latch
200056E	10884	" " Screw
225458	10884	" " Thumb Lever
225459	10884	" " " " Hinge Stud
225460	10884	" " " " Joint Stud
202478	10884	" " Trip Lever
200299H	10884	" " " " Hinge Screw
225461	10881	Tension Bracket with 201499B
200082D	10881	" " Screw
228026	10884	" " " Washer

No.	Plate	Name
2102	10881	Tension Disc
202407	10881	" Spring
201499B	10881	" Stud
201572B	10881	" " Thumb Nut
225462	10881	Bobbin Winder Tension Bracket complete, Nos. 201572B, 202407, 225461 and two 2102
225433	10885	Bobbin Winder and Tension Bracket Base
225382	10885	Universal Bobbin Winder complete, Nos. 200056E, 200082D, 200299H, 202473, 202478, 225381, 225433, 225444, 225453 to 225456, 225458 to 225460, 225462, 228026 and two wood screws $\frac{3}{4}$ in., No. 13, R.H.B.

FOOT LIFTER

227952	11561	Foot Lifter Lever (left or right) with 227954
227678	11561	Foot Lifter Lever Chain, 48 in. long, with 202784
227954	14000	Foot Lifter Lever Chain Hook (lower)
202784	12388	Foot Lifter Lever Chain Hook (upper)
225016	12388	Foot Lifter Lever Hinge Pin
227953	11561	" " " Stand with two wood screws 1 in., No. 13
227955	11561	Foot Lifter Lever (left or right) complete, Nos. 225016, 227678, 227952 and 227953

(Other Foot Lifter parts are listed with parts of machine head.)

MACHINE No. 51w100

Same as for No. 51w32 with the following exception:

225181	—	Drip Pan (long) with four wood screws $\frac{1}{2}$ in., No. 5, in place of 225191
--------	---	--

ROLLER PRESSERS

No.	Plate	Name
201906	13999	Roller Presser, $1\frac{1}{4}$ in. diam., $\frac{3}{16}$ in. face (fine), with 200548c and 201534u
201907	11767	Roller Presser, $1\frac{1}{4}$ in. diam., $\frac{3}{16}$ in. face (fine), with 200548c and 201534u
201908	11767	Roller Presser, $1\frac{1}{4}$ in. diam., $\frac{1}{8}$ in. face (fine), with 200548c and 201534u
201909	11767	Roller Presser, $1\frac{1}{4}$ in. diam., $\frac{3}{16}$ in. face (coarse), with 200551c and 201534u
201910	11225	Roller Presser, $1\frac{1}{4}$ in. diam., $\frac{1}{8}$ in. face (coarse), with 200551c and 201534u
201911	11767	Roller Presser, 1 in. diam., $\frac{1}{8}$ in. face (coarse), with 200551c and 201534u
201914	13999	Roller Presser, $\frac{5}{8}$ in. diam., $\frac{1}{8}$ in. face (coarse), with 200551c and 201534u
201915	11767	Roller Presser, $\frac{1}{2}$ in. diam., $\frac{3}{16}$ in. face (coarse), with 200554c
201916	11767	Roller Presser, $\frac{1}{2}$ in. diam., $\frac{1}{16}$ in. face (fine), with 200554c
202839	11767	Roller Presser Arm
208497	—	" " "
204571	—	" " "
204573	—	" " "
204567	13999	" " " 202839 with 201906
204569	11767	Roller Presser Arm 202839 with 201907
208498	12225	Roller Presser Arm 208497 with 201910
204572	13999	Roller Presser Arm 204571 with 201914
204574	11767	Roller Presser Arm 204573 with 201916
202560	12225	Roller Presser Arm Bracket (swing)
202838	—	Roller Presser Arm Bracket 202560 with 200096b and 204567

No.	Plate	Name
204436	—	Roller Presser Arm Bracket 202560 with 200096b and 204569
208499	—	Roller Presser Arm Bracket 202560 with 200096b and 208498
200675c	12225	Roller Presser Arm Bracket Position Screw Stud
202558	12225	Roller Presser Arm Bracket Spring
202559	12225	" " " " " " Stop
200141r	12225	Roller Presser Arm Bracket Spring Stop Screw
200096b	12225	Roller Presser Arm Screw
204495	12225	" " Bar
200554c	11767	" " Hinge Screw
200551c	12225	" " " " "
200548c	13999	" " " " "
201534u	12225	" " " " " Nut
204437	—	Roller Presser and Bar complete, Nos. 200675c, 202558, 202559, 204436, 204495 and two 200141r..
204496	—	Roller Presser and Bar complete, Nos. 200675c, 202558, 202559, 202838, 204495 and two 200141r..
204576	—	Roller Presser and Bar complete, Nos. 200675c, 202558, 202559, 204495, 208499 and two 200141r..

WORK PLATE PLATFORM

No.	Plate	Name
213855	11772	Work Plate
200019e	14000	" " Arm Screw
202622	11763	" " " " Washer
213856	11772	" " Bracket
200189c	14000	" " " Screw
200189e	14000	" " " Screw
213857	11772	" " Slide (back)
203301	11772	" " " (front)
213858	11772	Work Plate complete, Nos. 200019e, 202622, 203301, 213855 to 213857 and four 200189c

NUMERICAL LIST OF PARTS

FOR

MACHINES

Nos. 51w32 and 51w100

WOOD BASE (FLAT)

227493	12153	Bed Hinge Plate 202259 with two wood screws $\frac{3}{4}$ in., No. 120
225589	---	Machine Cushion (leather)
227902	---	Wood Base with two 227493, four each 225589 and wood screws $\frac{1}{2}$ in., No. 10

WOOD BASE (OBLIQUE)

227903	---	Wood Base with two 227493, four 225589 and nine wood screws $\frac{1}{2}$ in., No. 10
--------	-----	---

NUMERICAL LIST OF PARTS

No.	Plate	Name
2102	10881	Bobbin Winder Tension Disc, for 225162
19554	13995	Arm Position Pin
41400	12153	Machine Rest Pin (wood)
120342	12153	Offer (copper plated) with 120343
120343	12153	" Spout, 3½ in. long, for 120342
200002e	13335	Feed Driving Cam Fork Lever Con- nection Hinge Screw, for 213495 and 221213
200008c	11775	Feed Dog Lever Post Support Screw
200008c	11775	Hook Post Screw
200010c	11763	Arm Base Screw
200019c	14009	Work Plate Arm Screw, for 213858
200024c	11763	Feed Dog Lever Post Screw
200027c	13335	" Lifting Cam Fork Pinch Screw, for 201202
200031c	12311	Feed Driving Cam Fork Lever Con- nection Clamp Pinch Screw, for 204194
200012c	12311	Take up Lever Bearing Screw, for 204266
200043c	12311	Feed Driving Cam Fork Lever Shaft Sleeve Set Screw
200043c	12311	Feed Driving Rock Shaft Center Set Screw
200043c	12311	Feed Lifting Rock Shaft Center Set Screw
200045c	13335	Feed Lifting Cam Screw, for 213157
200053c	12311	Face Plate Screw
200054c	13335	Arm Shaft Connection Screw, for 213432
200054c	13335	Feed Dog Lever Post Support Screw, for 221210
200056c	10881	Bobbin Winder Stop Latch Screw, for 225382
200062c	12311	Balance Wheel Adjusting Screw...
200072c	12371	Needle Bar Connecting Stud Pinch Screw for 204249
200076c	13997	Bobbin Case Lever Driving Block Screw for 221219
200079c	12311	Spool Holder Wire Hinge Screw, for 204297

No.	Plate	Name
200082D	10881	Bobbin Winder Tension Bracket Screw, for 225382
200086C	10441	Presser Bar Lifting Bracket Pinch Screw, for 204253
200096D	12225	Roller Presser Arm Screw, for 202838, 204436 and 208499
200098E	13335	Feed Dog Screw, for 203609
200098F	13335	" Regulating Handle Adjustable Stop Screw, for 204207
200098F	13335	Feed Regulating Handle Shaft Crank Set Screw, for 204211 ...
200113F	12225	Feed Driving Cam Fork Lever Shaft Collar Set Screw, for 204197
200113F	12225	Foot Lifter Lifting Lever Rod Spring Collar Set Screw, for 227227
200113F	12225	Thread Oiler Bracket Screw, for 221205
200125F	12374	Needle Set Screw, for 204247
200135E	12309	Thread Controller Spring Stop Screw, for 221205
200141F	12225	Roller Presser Arm Bracket Spring Stop Screw, for 204437, 204496 and 204576
200159F	11778	Feed Dog Lever Post Cover (front) Clamp Screw, for 221219
200175D	13999	Needle Bar Thread Guide Screw, for 204247
200189C	14000	Work Plate Bracket Screw, for 213858
200189C	14000	Work Plate Screw, for 213858
200214E	13335	Feed Bar Hinge Screw, for 213425
200243E	13335	" Lifting Rock Shaft Slide Block Hinge Screw, for 203238
200262H	11763	Foot Lifter Lifting Lever Hinge Screw, for 227306 and 227479 ...
200263F	11763	Feed Dog Lever Hinge Screw
200265E	11763	" " " Slide Block Hinge Screw, for 221210
200271E	12311	Feed Regulating Handle Shaft Crank Link Hinge Screw (lower)
200278H	12311	Arm Cap Screw
200291E	13335	Feed Regulating Handle Shaft Crank Link Hinge Screw (upper), for 213902
200299H	10884	Bobbin Winder Stop Latch Trip Lever Hinge Screw, for 225382..
200300C	12309	Thread Controller Roller Screw, for 205987

No.	Plate	Name
200309E	12309	Tension Release Lever Screw, for 221205
200319C	12309	Thread Controller Spring Stop Driving Gear Hinge Screw, for 221205
200328C	12311	Balance Wheel Position Screw, for 204805
200335C	12311	Balance Wheel Set Screw, for 204805
200335C	12311	Take-up Cam Set Screw, for 213006
200355H	14000	Thread Controller Spring Stud Set Screw, for 204184
200362C	10441	Feed Dog Lever Adjusting Screw, for 221211
200362C	10441	Feed Regulating Handle Shaft Sleeve Set Screw
200362C	10441	Hook Counter Shaft Driving Gear Set Screw, for 203245
200362C	10441	Hook Driving Shaft Bushing Set Screw, for 221201 and 221203 ...
200362C	10441	Presser Bar Lifting Bracket Position Guide Set Screw
200368H	12309	Thread Retainer Stud Set Screw, for 204184
200380C	14000	Bobbin Winder Pulley Set Screw, for 202473
200382C	13997	Feed Driving Cam Set Screw, for 213428
200383C	12311	Feed Driving Rock Shaft Crank Set Screw, for 221508
200383C	12311	Hook Bevel Gear Set Screw, for 203242
200383C	12311	Hook Bevel Pinion Set Screw, for 203242
200383C	12311	Hook Counter Shaft Gear Set Screw, for 203246
200383C	12311	Take-up Cam Position Screw Check Screw, for 213006
200393C	12374	Hook Counter Shaft Collar Set Screw, for 203244
200393C	12374	Hook Driving Shaft Collar Set Screw, for 213141
200397H	12309	Face Plate Thread Guide Set Screw, for 204184
200397H	12309	Tension Stud Set Screw
200430C	12311	Take-up Cam Position Screw, for 213006
200437C	12311	Feed Driving Cam Position Screw, for 213428

No.	Plate	Name
200439c	12311	Arm Shaft Bushing Position Screw, for 204290 and 221258
200439c	12311	Hook Counter Shaft Driving Gear Position Screw, for 203245
200491b	10441	Presser Bar Thumb Screw (pressure regulating)
200504E	13999	Needle Bar Screw Bushing (lower)
200504E	13999	Presser Bar Screw Bushing (lower)
200516E	12311	Hook Driving Shaft Bearing Screw, for 221201 and 221203
200530c	11778	Foot Lifter Lifting Lever Rod Clamp Set Screw, for 204126 ...
200548c	13999	Roller Presser Hinge Screw, for 201906 to 201908
200550c	10441	Presser Bar Lifter Hinge Screw ..
200551c	12225	Roller Presser Hinge Screw, for 201909 to 201911 and 201914
200554c	11767	Roller Presser Hinge Screw, for 201915 and 201916
200555u	13997	Hook Socket Screw, for 221219 ..
200570E	12311	Bed Hinge Connection Screw
200575u	12311	Spool Holder Base Screw
200577u	12311	Thread Controller Plate Screw, for 221205
200577u	12311	Throat Plate Screw
200578u	11763	Feed Dog Lever Post Cover (side) Screw, for 221210
200581u	12309	Thread Controller Spring Guard Screw, for 205987
200583u	11763	Feed Dog Lever Post Cover (back or front) Screw, for 221219
200594c	13997	Bobbin Case Tension Spring Screw, for 203500
200658c	13997	Needle Bar Connecting Link Hinge Screw Stud, for 213006
200668c	13335	Feed Driving Cam Fork Lever Connection Clamp Screw Stud, for 213427
200675c	12225	Roller Presser Arm Bracket Position Screw Stud, for 204437, 204496 and 204576
200684u	14000	Thread Controller Adjusting Collar Screw, for 204273
200688c	11778	Tension Release Lever Position Screw, for 204184
200840E	12311	Hook Counter Shaft Oil Packing (wick) Stop Screw, for 221201 and 221203
200963E	12311	Arm Screw

No.	Plate	Name
200984c	13997	Bobbin Case Tension Spring Regulating Screw, for 203500
201253F	11778	Hook Gib Screw, for 221216
201272c	13335	Bobbin Case Lever Hinge Screw, for 221219
201375J	14000	Tension Stud, for 221223
201376F	11778	Hook Gib Hinge Screw, for 221216
201499B	10881	Bobbin Winder Tension Stud, for 225461
201519E	13997	Needle Bar Connecting Link Hinge Screw Stud Nut, for 213006
201522E	13335	Feed Driving Cam Fork Lever Connection Hinge Screw Nut, for 213495 and 221213
201524E	13335	Feed Dog Lever Adjusting Screw Check Nut, for 221211
201524E	13335	Feed Driving Cam Fork Lever Shaft Sleeve Set Screw Nut ...
201525E	13335	Feed Bar Hinge Screw Nut, for 213425
201525E	13335	Feed Dog Lever Slide Block Hinge Screw Nut, for 221210
201525E	13335	Feed Driving Cam Fork Lever Connection Clamp Screw Stud Nut, for 213427
201528D	11763	Feed Dog Lever Hinge Screw Nut
201531E	12374	" Lifting Rock Shaft Slide Block Hinge Screw Nut, for 203238
201534u	12225	Roller Presser Hinge Screw Nut, for 201906 to 201911 and 201914..
201572B	10881	Bobbin Winder Tension Stud Thumb Nut, for 225462
201572B	10881	Tension Thumb Nut, for 221223 ..
201816	13999	Take-up Lever Roller, for 204266 ..
201906	13999	Roller Presser, 1 $\frac{1}{2}$ in. diam., $\frac{3}{8}$ in. face (fine), with 200548c and 201534u, for 204567
201907	11767	Roller Presser, 1 $\frac{1}{2}$ in. diam., $\frac{3}{8}$ in. face (fine), with 200548c and 201534u, for 204569
201908	11767	Roller Presser, 1 $\frac{1}{2}$ in. diam., $\frac{1}{4}$ in. face (fine), with 200548c and 201534u
201909	11767	Roller Presser, $\frac{3}{4}$ in. diam., $\frac{3}{8}$ in. face (coarse) with 200551c and 201534u
201910	12225	Roller Presser, $\frac{3}{4}$ in. diam., $\frac{1}{4}$ in. face (coarse) with 200551c and 201534u, for 208498

No.	Plate	Name
201911	11767	Roller Presser, 1 in. diam., $\frac{1}{2}$ in. face (coarse) with 200551c and 201534n
201914	13999	Roller Presser, $\frac{3}{4}$ in. diam., $\frac{1}{2}$ in. face (coarse) with 200551c and 201534n, for 204572
201915	11767	Roller Presser, $\frac{11}{16}$ in. diam., $\frac{5}{8}$ in. face (coarse) with 200551c
201916	11767	Roller Presser, $\frac{1}{2}$ in. diam., $\frac{1}{4}$ in. face (fine), with 200551c, for 204574
202005	12374	Arm Base Screw Washer
202005	12374	" Screw Washer
202036	13997	Feed Regulating Handle Stop Pin, for 204290 and 221258
*202056	-----	Bobbin Case Latch Pin, for 203500
202068	12153	Spool Holder Base, for 204797
202075	12309	Tension Release Plunger, for 221223
202084	12309	Thread Controller Roller Guard Washer, for 205987
202090	12309	Tension Disc Position Pin, for 204184
202091	12309	Thread Retainer Sleeve, for 204059
202092	12309	" " Spring, for 204059
202098	12309	" Controller Roller, for 205987
202126	12374	Feed Lifting Cam Position Pin, for 213007
202126	12374	Hook Driving Shaft Bearing Position Pin
202248	13997	Arm Cap Screw Washer
202258	12153	Bed Hinge Connection
202276	12374	Feed Lifting Rock Shaft Slide Block, for 203238
202277	-----	Bobbin Winder Frame Oil Packing (wick), for 225453
202277	-----	Needle Bar Connecting Stud Oil Packing (wick), for 204249
202299	-----	Arm Shaft Oil Packing (wick)
202299	-----	Hook Counter Shaft Oil Packing (wick), for 221201 and 221203
202299	-----	Hook Driving Shaft Bearing Oil Packing (wick), for 203248
202299	-----	Hook Driving Shaft Bushing Oil Packing (wick), for 221201 and 221203
202299	-----	Hook Post Oil Packing (wick), for 221219
202302	11778	Foot Lifter Lifting Lever Rod Cotter Pin, for 227475

No.	Plate	Name
202305	13335	Feed Driving Rock Shaft Center..
202305	13335	" Lifting Rock Shaft Center..
202402	12309	Tension Disc, for 221223
202407	10881	Bobbin Winder Tension Spring, for 225462
202413	14000	Thread Guide
202473	10885	Bobbin Winder Pulley with 200380c, for 225382
202478	10884	Bobbin Winder Stop Latch Trip Lever, for 225382
202558	12225	Roller Presser Arm Bracket Spring, for 204437, 204496 and 204576 ..
202559	12225	Roller Presser Arm Bracket Spring Stop, for 204437, 204496 and 204576
202560	12225	Roller Presser Arm Bracket (swing), for 202838, 204436 and 208499
202622	11763	Feed Regulating Handle Shaft Sleeve Washer, for 204207
202622	11763	Work Plate Arm Screw Washer, for 213858
202781	11561	Foot Lifter Lifting Lever, for 227306
202781	12388	" " Lever Chain Hook (upper), for 227678
202838	-----	Roller Presser Arm Bracket 202560 with 200096b and 204567, for 204496
202839	11767	Roller Presser Arm, for 204567 and 204569
203172	13999	Take-up Cam Friction Washer
203202	11561	Arm Shaft, for Machine No. 51w32
203214	13997	Bobbin Case Tension Spring, for 203500
203216	-----	Bobbin Case Washer (cloth), for 203500
203238	12374	Feed Lifting Rock Shaft Slide Block 202276 with 200243c and 201531c, for 203315
203242	12344	Hook Bevel Gear, 24 teeth, with two 200383c, for 221219
203242	12344	Hook Bevel Pinion, 24 teeth, with two 200383c
203244	12374	Hook Counter Shaft Collar with two 200393c
203245	12344	Hook Counter Shaft Driving Gear, 44 teeth, with 200362c and 200439c, for 213157
203246	12344	Hook Counter Shaft Gear, 22 teeth, with two 200383c

No.	Plate	Name
203247	13998	Hook Driving Shaft, for Machine No. 51w32
203248	11562	Hook Driving Shaft Bearing with 202299, for 221201 and 221203 ..
203249	12344	Hook Driving Shaft Bushing (eccentric), for 221201 and 221203 ...
203251	13997	Hook Gib, for 221216
203301	11772	Work Plate Slide (front), for 213858
203305	11762	Feed Lifting Rock Shaft, for 203315
203306	11562	Hook Counter Shaft
203315	11762	Feed Lifting Rock Shaft 203305 with 203238
203470	13997	Bobbin
203473	13997	" Case Latch Plunger, for 203500
203474	13997	Bobbin Case Latch Spring, for 203500
*203498	—	Bobbin Case, for 203500
203500	13335	Bobbin Case complete, Nos. 200594c, 200984c, 202056, 203214, 203216, 203473, 203474, 203498 and 203648, for 221217
203609	11762	Feed Dog Lever with 200098e, for 221210
203610	11763	Feed Dog Lever Slide Block, for 221210
203637	11763	Feed Dog Lever Post Support Screw Washer
203637	11763	Hook Post Screw Washer
203648	13997	Bobbin Case Latch, for 203500 ...
204058	12309	Thread Retainer Stud, for 204059..
204059	12309	Thread Retainer complete, Nos. 202091, 202092 and 204058, for 221205
204126	11778	Foot Lifter Lifting Lever Rod Clamp with two 200530c, for 227576
204163	12344	Arm Cap
204184	11561	Face Plate with 200355u, 200368u, 200688c, 202090, 204185, 204281 and two 200397u, for 221205
204185	13997	Face Plate Thread Guide, for 204184
204194	11763	Feed Driving Cam Fork Lever Connection Clamp with 200031c, for 213693
*204195	—	Feed Driving Cam Fork Lever Shaft, for 213429
204196	13335	Feed Driving Cam Fork Lever Shaft Sleeve (split)

No.	Plate	Name
204197	11763	Feed Driving Cam Fork Lever Shaft Collar with 200113f
204199	13998	Feed Driving Rock Shaft, for 213495
204202	12374	" Lifting Cam Fork with 200027f
204206	13335	" Regulating Handle, for 204207
204207	—	" " " 204206 with 200098f, 202622, 204208 to 204210, 204213 and 204925, for 213902 ..
		Nos. 204208 to 204210, for 204207
204208	13335	Feed Regulating Handle Adjustable Stop
204209	13335	Feed Regulating Handle Position Pin
204210	11763	Feed Regulating Handle Shaft
204211	11763	" " " " Crank with 200098f, for 213902..
204213	13335	Feed Regulating Handle Shaft Sleeve (split), for 204207
204235	13997	Arm Base Position Pin
204247	11562	Needle Bar 208613 with 200125f, 200175d and 204250
204248	13997	Needle Bar Connecting Link
204249	12374	" " " Stud with 200072c and 202277
204250	13999	Needle Bar Thread Guide, for 204247
204252	10441	Presser Bar Lifter
204253	10441	" " Lifting Bracket with 200086c
204254	10441	Presser Bar Lifting Bracket Position Guide
204258	13999	Presser Bar Spring
204262	13999	Take-up Lever, for 206556
204263	13999	" " Bearing with 204264, for 206556
204264	13999	Take-up Lever Bearing Position Pin, for 204263
204266	-	Take-up Lever complete, Nos. 200042f, 201816 and 206556
204267	14000	Tension Release Lever, for 221205
204271	12309	" Washer, for 221223
204273	14000	Thread Controller Adjusting Collar with 200684u (for Presser Bar)..
204274	12309	Thread Controller Plate, for 205987
204275	12309	" " Roller Guard, for 205987
204276	12309	Thread Controller Spring, for 204280

Nos. 204277 to 204280, for 221205

No.	Plate	Name
204277	12309	Thread Controller Spring Stop ...
204278	12309	" " " " " Driv- ing Gear
204279	12309	Thread Controller Spring Stud with 204925
204280	12309	Thread Controller and Spring com- plete, Nos. 204276 and 205987 ..
204281	12309	Thread Retainer Guide Wire, for 204184
*204290	-	Arm with 200439c, 202036 and 204705, for Machine No. 51w100...
204293	12374	Feed Driving Cam Fork Lever Shaft Position Pin, for 213429 ..
204294	13998	Feed Driving Rock Shaft, for 221213
204296	12153	Spool Holder Wire, for 204297
204297	12153	Spool Holder complete, Nos. 200079b, 202068 and 204296
204326	-	Needle Bar Packing Cord
204327	-	Presser Bar Packing Washer (felt)
204329	-	Thread Oiler (felt), for 204330 ...
204330	12225	" " " " Bracket with 204329, for 221205
204333	12309	Thread Controller Spring Guard, for 205987
204436	-	Roller Presser Arm Bracket 202560 with 200096d and 204369, for 204437
204437	-	Roller Presser and Bar complete, Nos. 200675c, 202558, 202559, 204436, 204495 and two 200141e
204495	12225	Roller Presser Bar, for 204437, 204496 and 204576
204496	-	Roller Presser and Bar complete, Nos. 200675c, 202558, 202559, 202838, 204495 and two 200141e...
204567	13999	Roller Presser Arm 202839 with 201906, for 202838
204569	11767	Roller Presser Arm 202839 with 201907, for 204436
204571	-	Roller Presser Arm, for 204572 ...
204572	13999	" " " " 204571 with 201914
204573	-	Roller Presser Arm, for 204574 ...
204574	11767	" " " " 204573 with 201916
204576	-	Roller Presser and Bar complete, Nos. 200675c, 202558, 202559, 204495, 208499 and two 200141e...

No.	Plate	Name
204705	11562	Arm Shaft Bushing (front), for 204290 and 221258
204805	11561	Balance Wheel, 5 1/4 in. diam. (belt groove 2 3/4 in. diam.), with 200328c and 200335c
204925	13335	Feed Regulating Handle Adjustable Stop Screw Washer, for 204297...
204925	13335	Thread Controller Spring Stud Washer, for 204279
205987	12309	Thread Controller complete, Nos. 200300c, 200581b, 202084, 202098, 204274, 204275 and 204333, for 204280
206556	-	Take up Lever 204262 with 204263, for 204266
206608	14000	Tension Release Slide Spring
206628	12388	Foot Lifter Lifting Lever Rod Spring, for 227273
208489	14000	Tension Release Slide
208497	-	Roller Presser Arm, for 208498 ..
208498	12225	" " " " 208497 with 201910, for 208499
208499	-	Roller Presser Arm Bracket 202560 with 200096d and 208498, for 204576
208613	-	Needle Bar (hollow), for 204247 ..
213606	11778	Take-up Cam with 200335c, 200383c, 200430c, 200658c and 201519e ...
213007	11763	Feed Lifting Cam with 202126, for 213157
213141	11778	Hook Driving Shaft Collar with two 200393c
213157	-	Hook Counter Shaft Driving Gear 203215 with 200045e and 213007...
213425	-	Feed Bar 213426 with 200214e, 201525e and 221508
213426	11762	Feed Bar, for 213425
213427	11762	" Driving Cam Fork Lever Con- nection with 200668c and 201525e, for 213495 and 221213
213428	11763	Feed Driving Cam with 200382c and 200437c
213429	11762	Feed Driving Cam Fork Lever with 204195 and 204293, for 213693 ..
213432	11561	Arm Shaft Connection with four 200054e
213433	11762	Feed Regulating Handle Shaft Crank Link, for 213902
*213434	-----	Arm Base
213435	13999	Needle Bar Guard

No.	Plate	Name
213495		Feed Driving Rock Shaft 204199 with 200002e, 201522e and 213427, for Machine No. 51w32
213622	11561	Arm Shaft, for Machine No. 51w100
213624	13998	Hook Driving Shaft, for Machine No. 51w100
213693	11762	Feed Driving Cam Fork Lever complete, Nos. 204194 and 213429 ..
		Nos. 213855 to 213857, for 213858
213855	11772	Work Plate
213856	11772	" " Bracket
213857	11772	" " Slide (back)
213858	11772	Work Plate complete, Nos. 200019c, 202622, 203301, 213855 to 213857 and four 200189c
213902		Feed Regulating Handle complete, Nos. 209291f, 204207, 204211 and 213433
*221261		Bed with 203248, 203249, two each 200362c, 200516f, 200840f and 202299, for Machine No. 51w32 ..
*221203		Bed with 203248, 203249, two each 2000362, 200516f, 200840f and 202299, for Machine No. 51w100 ..
221205		Face Plate complete, Nos. 200112a, 200135f, 200309f, 200319c, 200577a, 204059, 204184, 204267, 204277 to 204280, 204330 and 221223
221206	11775	Feed Dog Lever Post, for 221210 ..
221209	11562	" " " " Cover (back), for 221219
221210		Feed Dog Lever Post 221206 with 200265e, 201525e, 203609, 203610, 221211, 221212, four each 200954e and 200578a, for 221220
221211	11562	Feed Dog Lever Post Cover (side) with 200362c and 201524e, for 221210
221212	11562	Feed Dog Lever Post Support, for 221210
221213		Feed Driving Rock Shaft 204294 with 200002e, 201522e and 213427, for Machine No. 51w100
*221214		Hook (sewing), for 221216
221215	11762	" Post Slide, for 221219
221216	13335	" 221214 with 201253f, 201376f and 203251, for 221217

No.	Plate	Name
221217	11774	Hook and Bobbin Case complete, Nos. 203500 and 221216, for 221219
221218	11775	Hook Post, for 221219
221219		" " 221218 with 200159f, 200555a, 201272c, 202299, 203242, 221209, 221215, 221217, 221221, 221222, 221260, 234065, 234079, two 200076d and eight 200583a, for 221220
221220		Hook Post complete, Nos. 221210 and 221219
221221	11775	Hook Socket, for 221219
221222	11774	" Washer, for 221219
221223	11774	Tension complete, Nos. 201375a, 201572a, 202075, 204271, 225708 and two 202492, for 221205
221238	11774	Throat Plate, 38 needle hole, for needle sizes 23 and 24, for 221250
221250	11774	Feed Dog, for 221238
*221258		Arm with 200439c, 202036 and 204705, for Machine No. 51w32 ..
221260	11562	Feed Dog Lever Post Cover (front), for 221219
221508	11763	Feed Driving Rock Shaft Crank with two 200383c, for 213425
225016	12388	Foot Lifter Lever Hinge Pin, for 227955
225181		Drip Pan (long) with four wood screws $\frac{1}{2}$ in., No. 5, for Machine No. 51w100
225191		Drip Pan with four wood screws $\frac{1}{2}$ in., No. 5, for Machine No. 51w32
225381	10881	Bobbin Winder Spindle, for 225382
225382	10885	Universal Bobbin Winder complete, Nos. 200056e, 200082d, 200299a, 202473, 202478, 225381, 225433, 225444, 225453 to 225456, 225458 to 225460, 225462, 228026 and two wood screws $\frac{3}{4}$ in., No. 13, R.H.B.
225433	10885	Bobbin Winder and Tension Bracket Base, for 225382
225438	10884	Bobbin Winder Frame Oil Well Cap, for 225453
225444	10884	Bobbin Winder Stop Latch, for 225382
		Nos. 225453 to 225456, for 225382
225453	10884	Bobbin Winder Frame with 202277 and 225438

No.	Plate	Name
225454	10884	Bobbin Winder Frame Hinge Pin
225455	10884	" " " Spring
225456	10884	" " " "
		Plunger
		Nos. 225458 to 225460, for 225382
225458	10884	Bobbin Winder Stop Latch Thumb Lever
225459	10884	Bobbin Winder Stop Latch Thumb Lever Hinge Stud
225460	10884	Bobbin Winder Stop Latch Thumb Lever Joint Stud
225461	10881	Bobbin Winder Tension Bracket with 201499a, for 225462
225462	10881	Bobbin Winder Tension Bracket complete, Nos. 201572a, 202407, 225461 and two 2102, for 225382 ..
*225482	-	Bobbin Case Screw Driver Blade, for 225497
*225483	-	Bobbin Case Screw Driver Handle, for 225497
*225484	-	Screw Driver Blade, for 225498 ...
*225485	-	" " Handle, for 225498 ...
225487	11778	Roller Presser Hinge Screw Nut Wrench
225497	12153	Bobbin Case Screw Driver complete, Nos. 225482 and 225483 ...
225498	12153	Screw Driver complete (7½ in. long), Nos. 225484 and 225485 ...
225554	12153	Wrench (steel)
225589	-	Machine Cushion (leather), for 227902 and 227903
225708	14000	Tension Spring, for 221223
227227	12388	Foot Lifter Lifting Lever Rod Spring Collar with 200113E, for 227273
227273	-	Foot Lifter Lifting Lever Rod 227475 with 200628, 227227 and 227576, for 227353; also for Machine No. 51w100
227306	-	Foot Lifter Lifting Lever 202781 with 200262a, for Machine No. 51w100
227307	11561	Foot Lifter Lifting Lever, for 227479
227316	12388	" " " " Rod Clamp Hook, for 227576
227353	-	Foot Lifter Lifting Lever 227479 with 227273, for Machine No. 51w32

No.	Plate	Name
227475	11561	Foot Lifter Lifting Lever Rod with 202302, for 227273
227479	-	Foot Lifter Lifting Lever 227307 with 200262a, for 227353
227493	12153	Bed Hinge Plate 202259 with two wood screws ¾ in., No. 120, for 227902 and 227903
227576	12388	Foot Lifter Lifting Lever Rod Clamp Hook 227316 with 204126, for 227273
227678	11561	Foot Lifter Lever Chain, 48 in. long, with 202784, for 227955
227902	-	Wood Base (flat) with two 227493, four each 225589 and wood screws 1¼ in., No. 10
227903	-	Wood Base (oblique) with two 227493, four 225589 and nine wood screws 1¼ in., No. 10
227952	11561	Foot Lifter Lever (left or right) with 227954, for 227955
227953	11561	Foot Lifter Lever Stand with two wood screws 1 in., No. 13, for 227955
227954	14000	Foot Lifter Lever Chain Hook (lower), for 227952
227955	11561	Foot Lifter Lever (left or right) complete, Nos. 225016, 227678, 227952 and 227953
228026	10884	Bobbin Winder Tension Bracket Screw Washer, for 225382
234065	13997	Bobbin Case Lever Driving Block, for 221219
234079	13997	Bobbin Case Lever, for 221219

**ILLUSTRATIONS OF PARTS
FOR
MACHINES**

Nos. 51w32 and 51w100

PLATE 10441-FULL SIZE

204254



200491



204252



200336



204253



200550



200074



200086

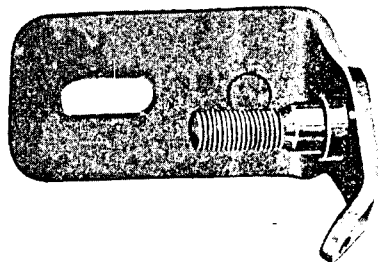


200362



PLATE 10881-FULL SIZE

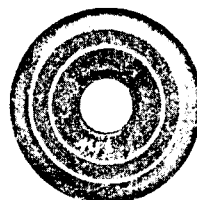
225461



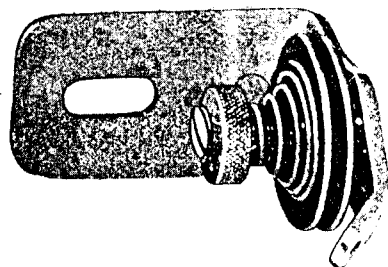
200082 202104



2102



225462



202407



201499

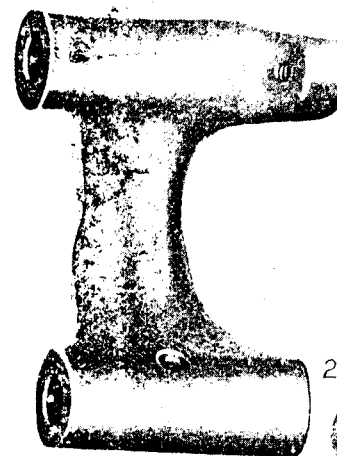


201572

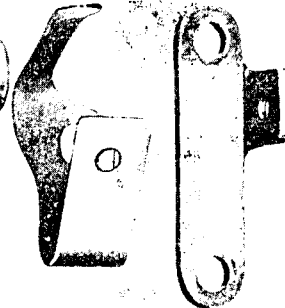


PLATE 10884-FULL SIZE

225453



225444 202478



225458



228026



225460



225454



200299



225438



200056



225459



200105



225456



225381



225455



PLATE 10885—ONE-FOURTH SIZE

225433



202473



225382

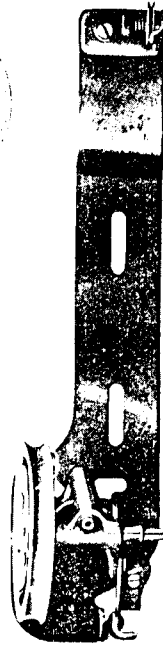


PLATE 11561—ONE-FOURTH SIZE

213432



213622



227475



203202



204805

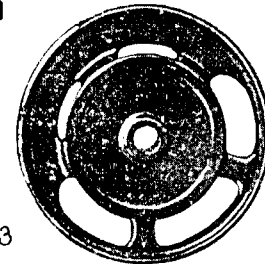
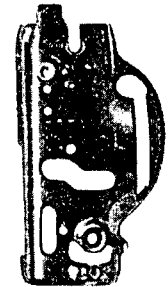
202781



227307



204184

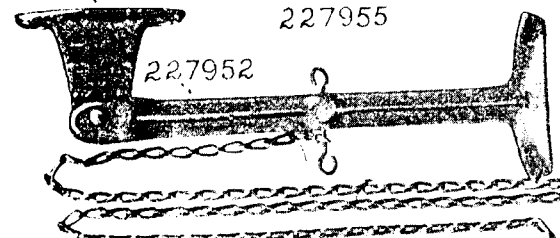


227953



227955

227952



227678

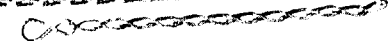


PLATE 11562-ONE-HALF SIZE

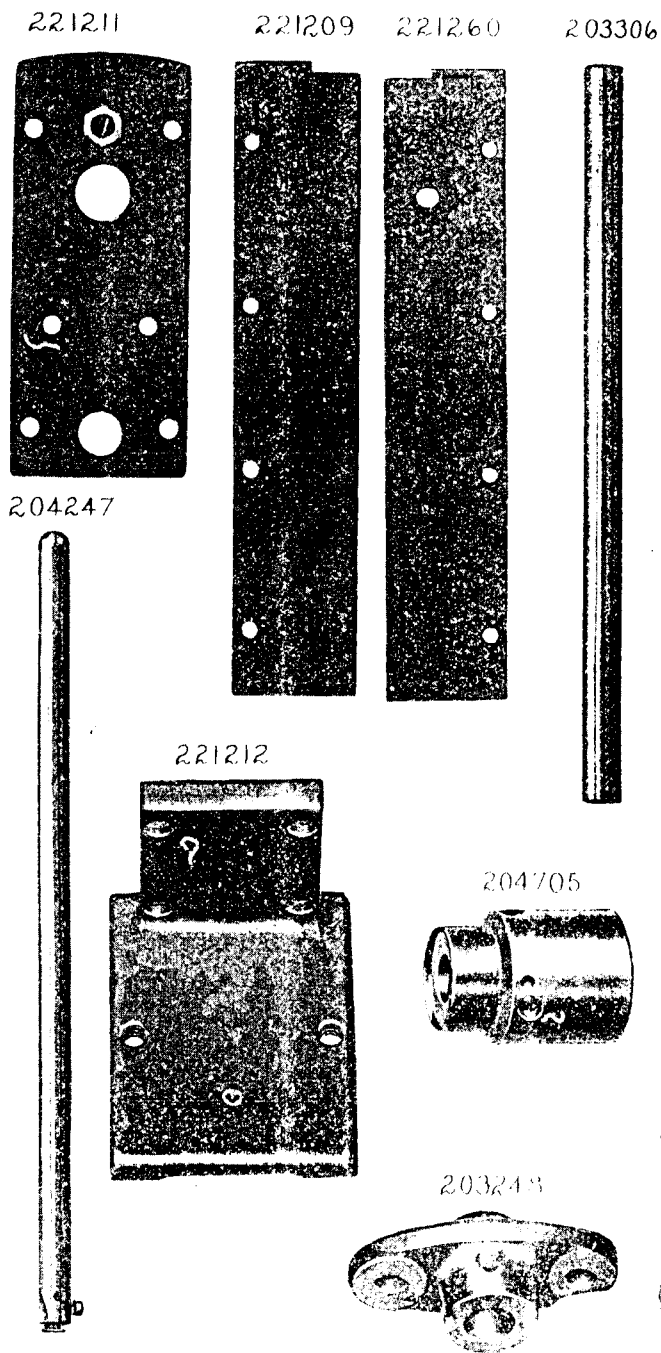


PLATE 11762-ONE-HALF SIZE

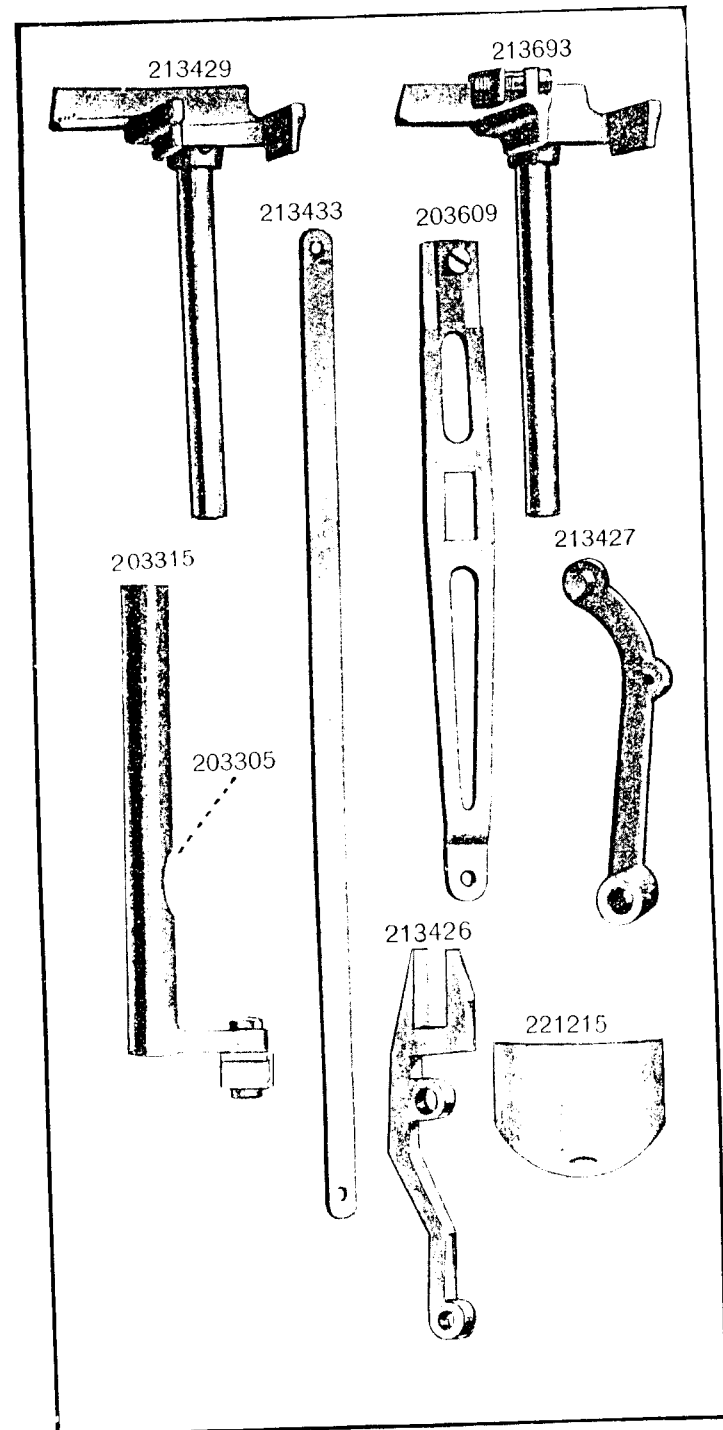


PLATE 11763-FULL SIZE

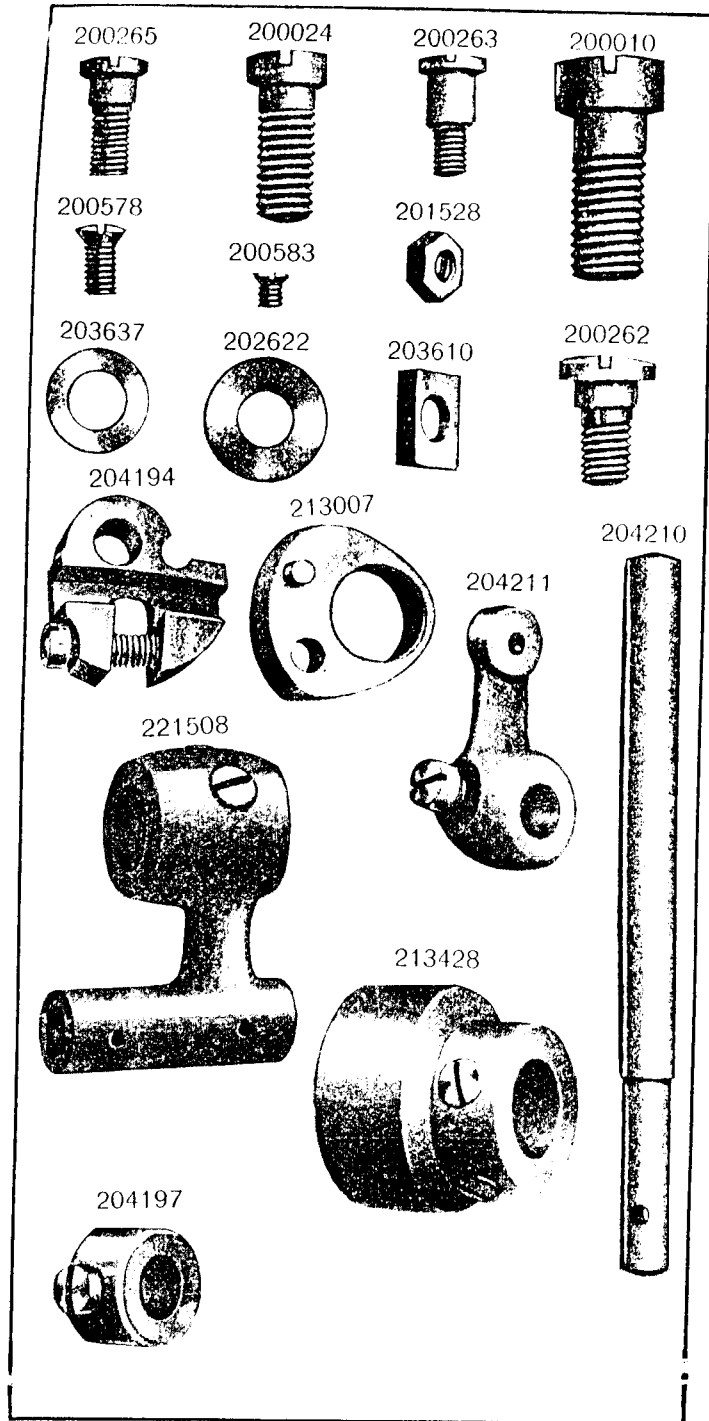


PLATE 11767-FULL SIZE

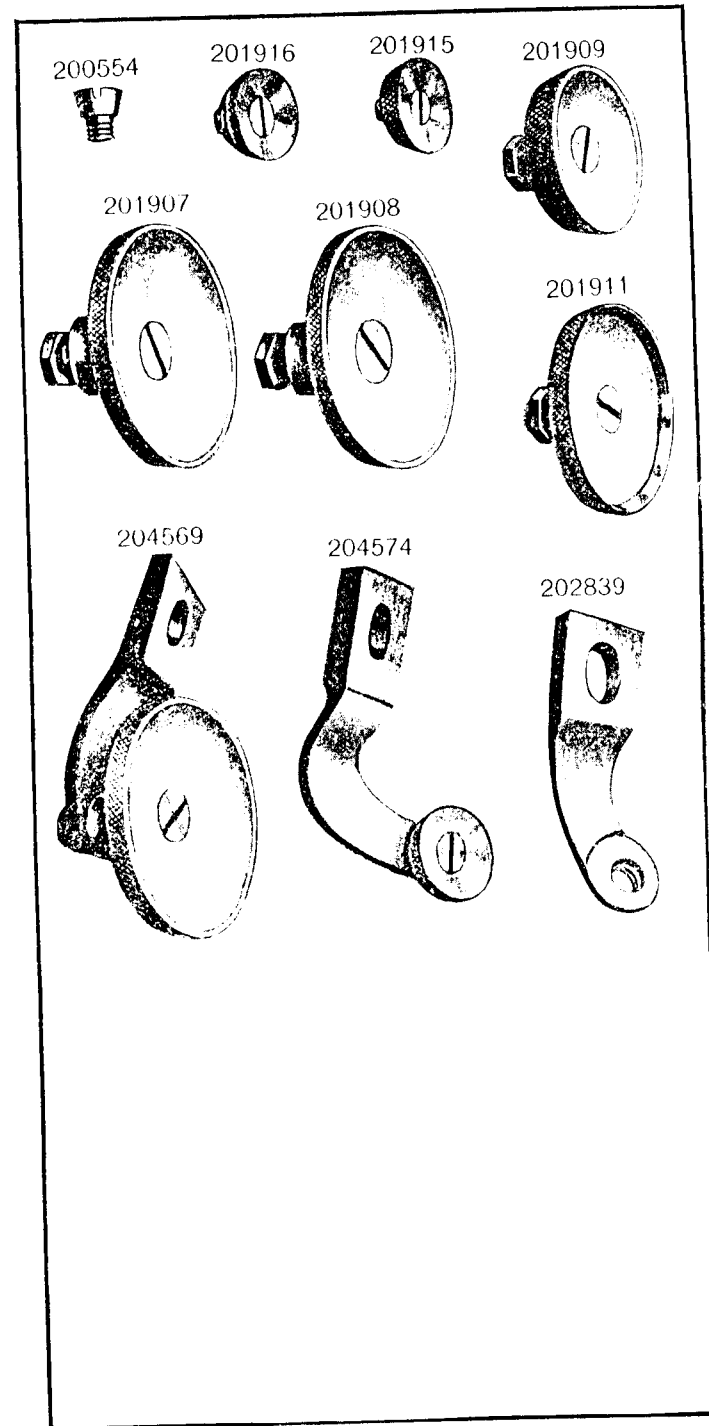


PLATE 11772—ONE-FOURTH SIZE

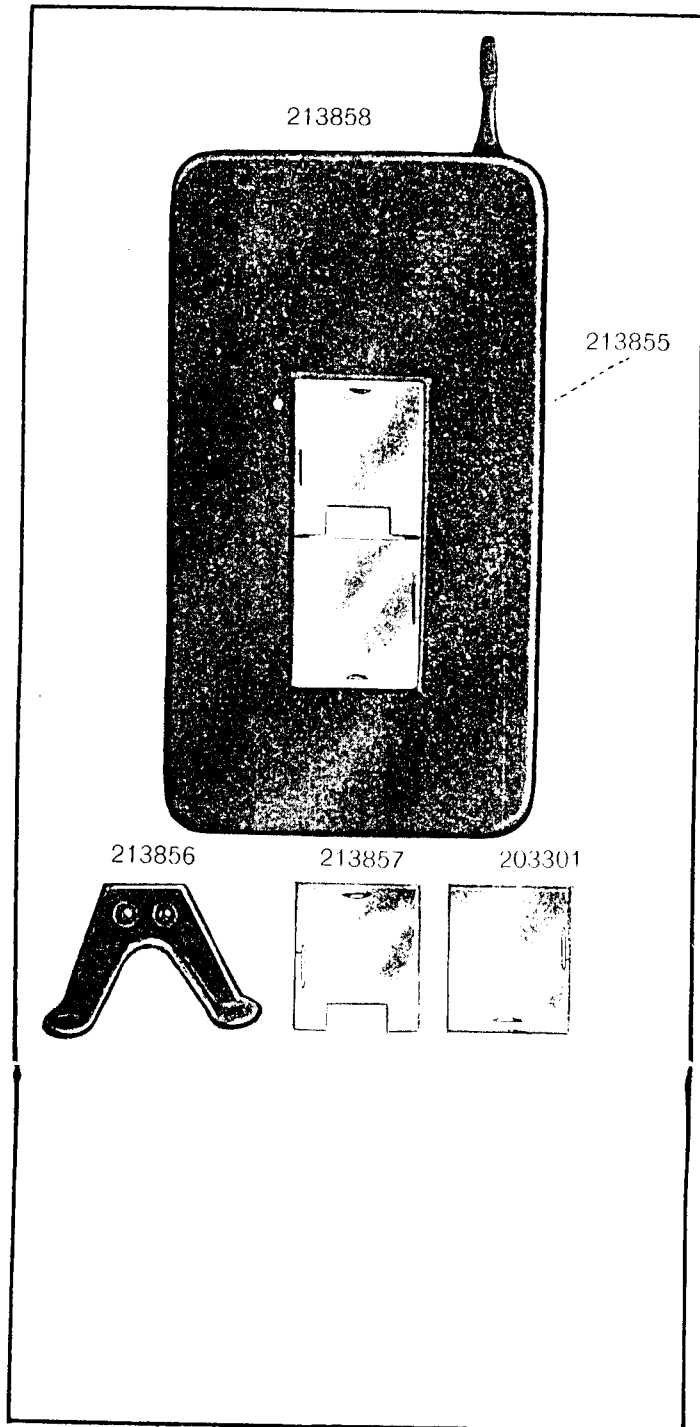


PLATE 11774—FULL SIZE

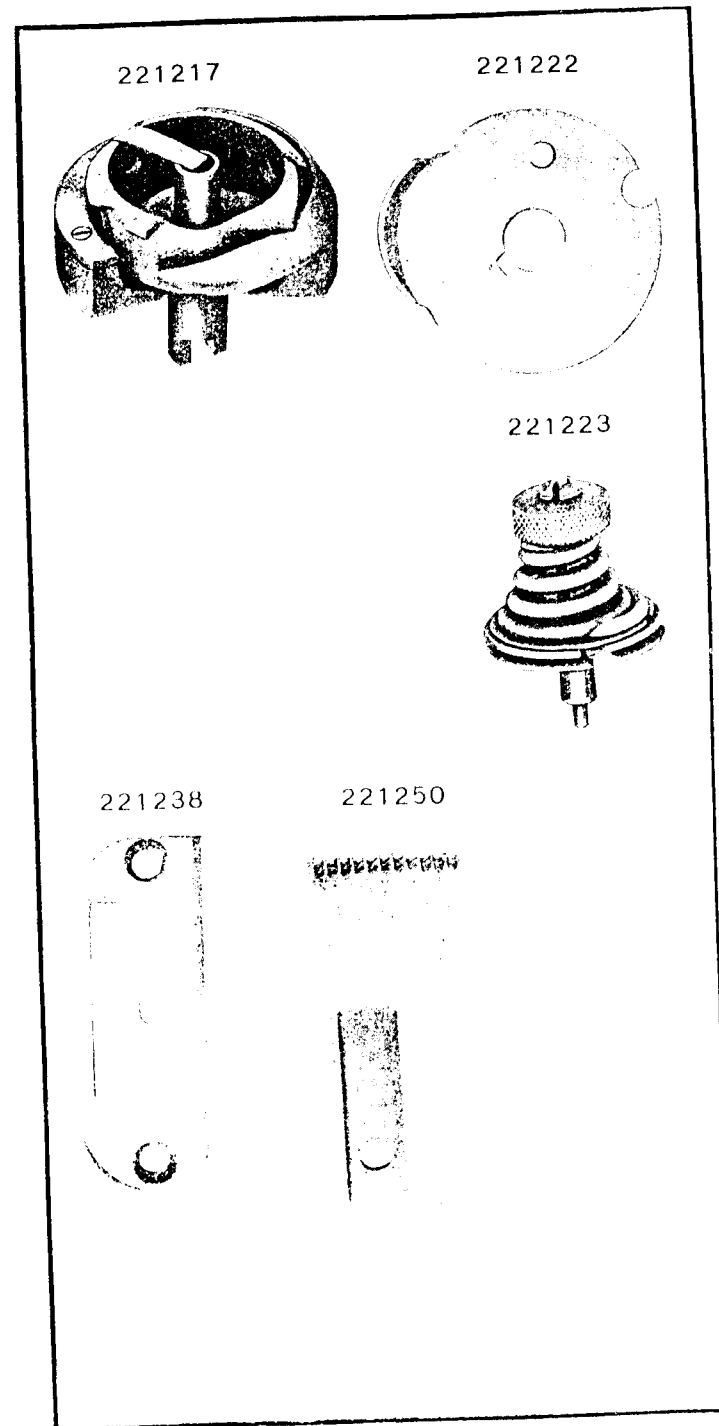


PLATE 11775—ONE-HALF SIZE

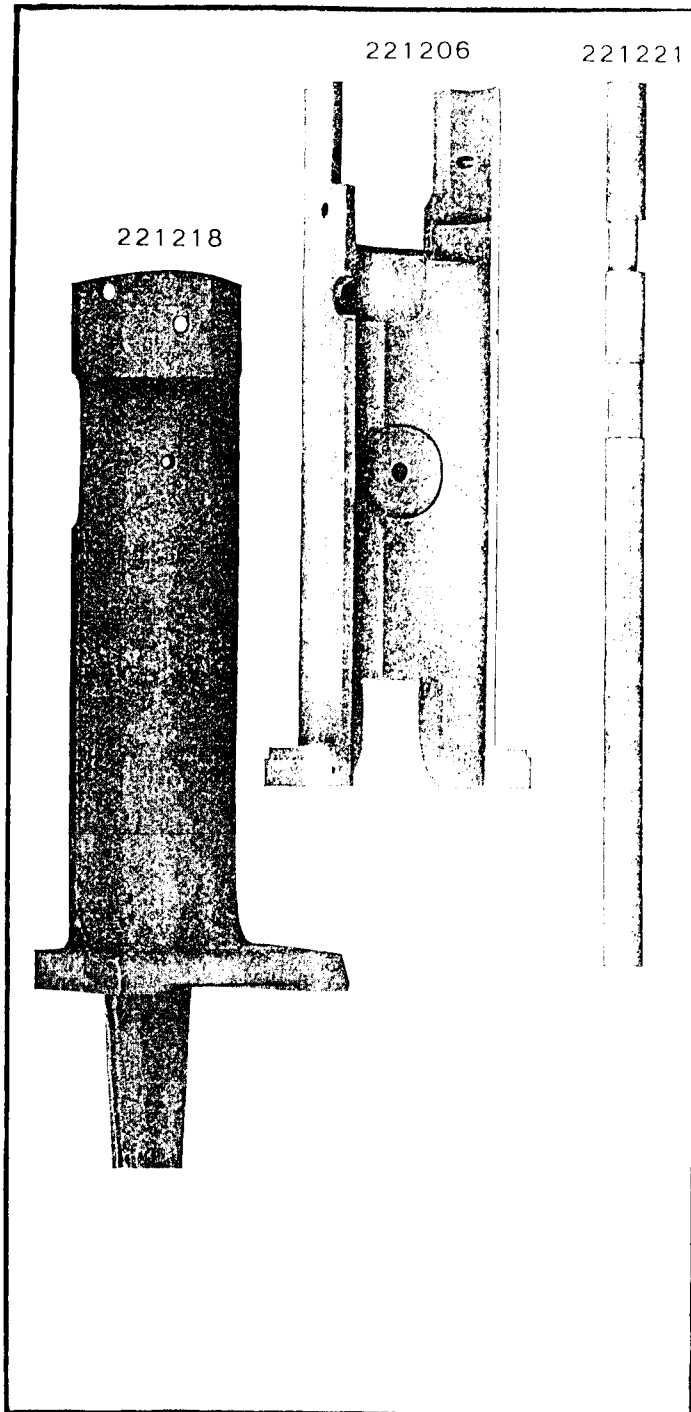


PLATE 11778—FULL SIZE

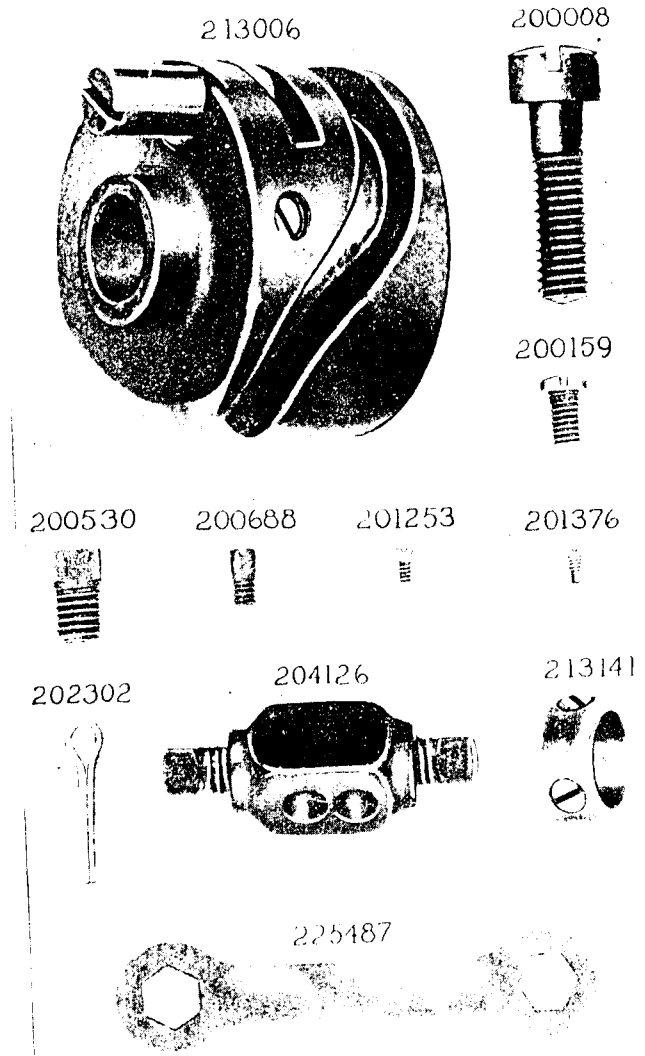


PLATE 12153—ONE HALF SIZE

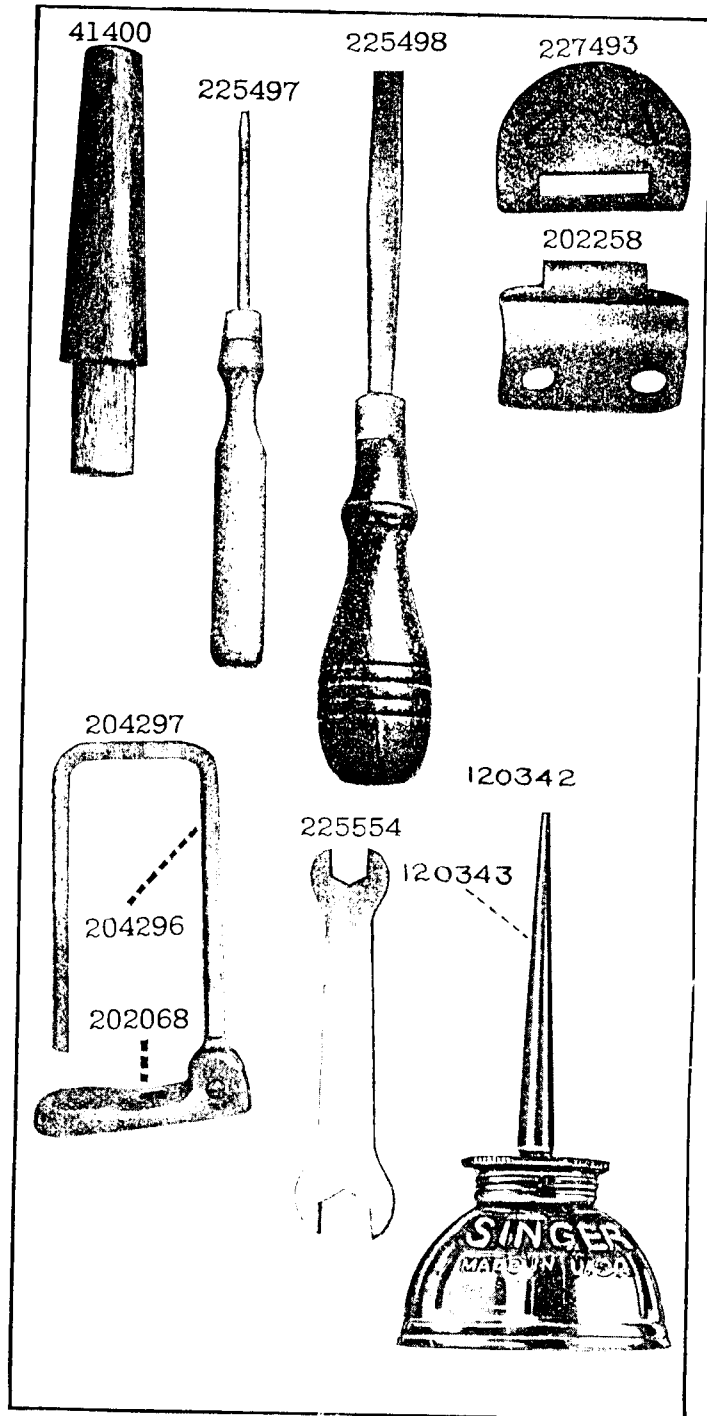


PLATE 12225—FULL SIZE

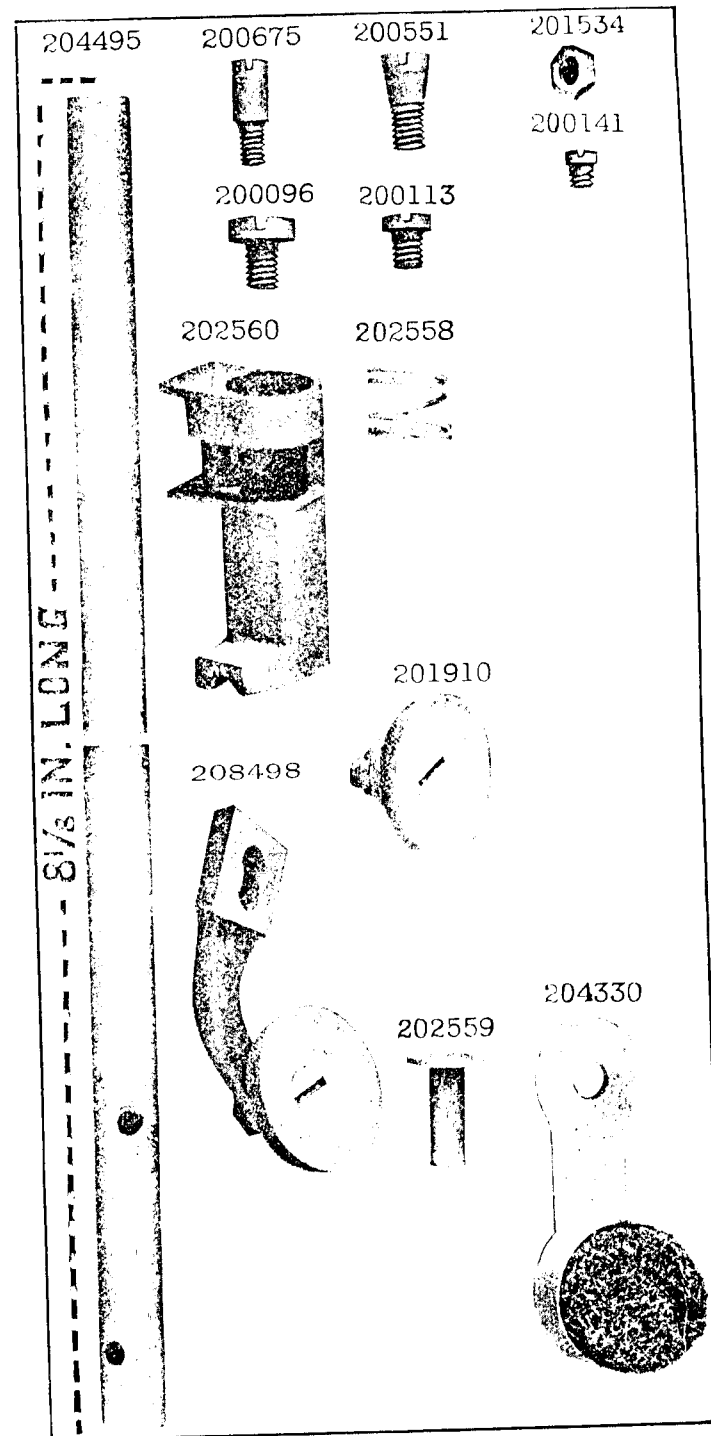


PLATE 12309 -FULL SIZE

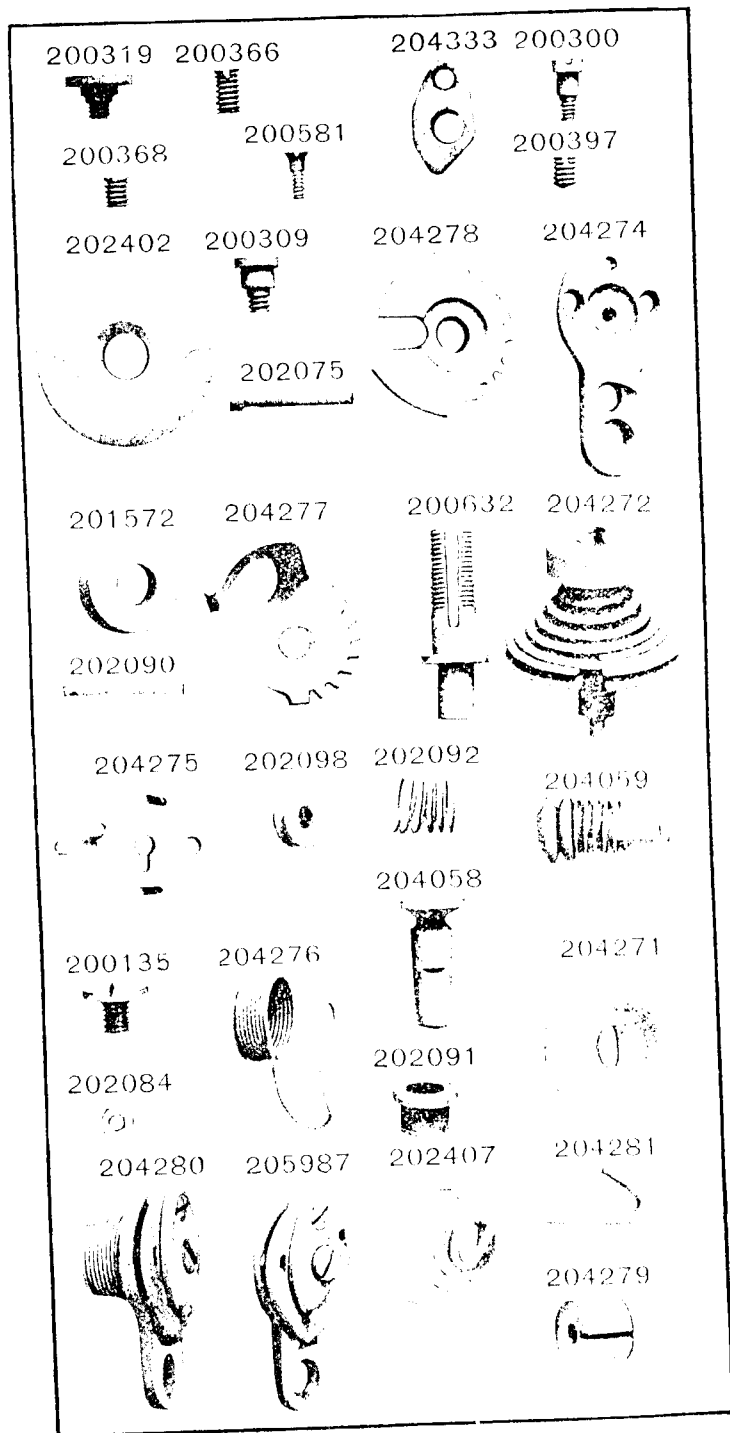


PLATE 12311 -FULL SIZE

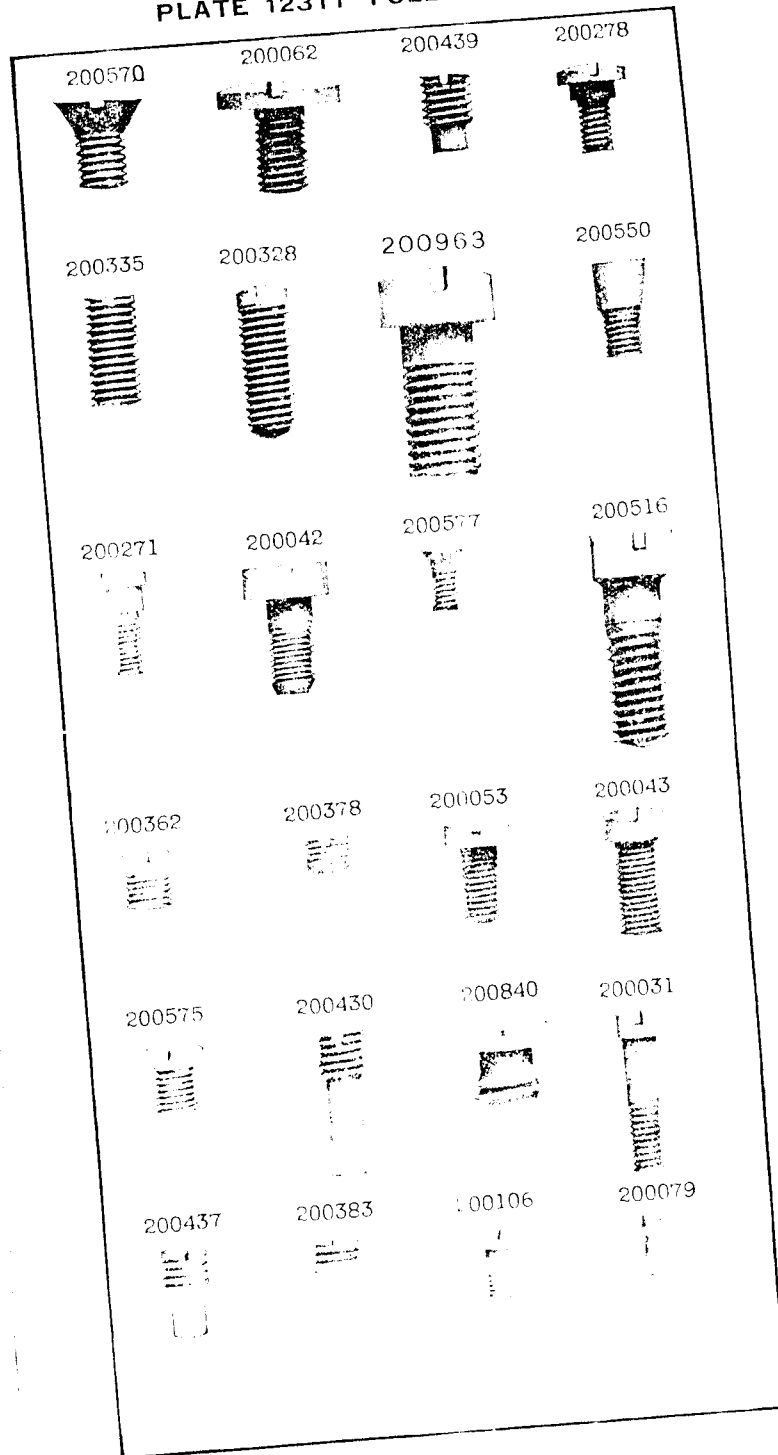


PLATE 12344—FULL SIZE

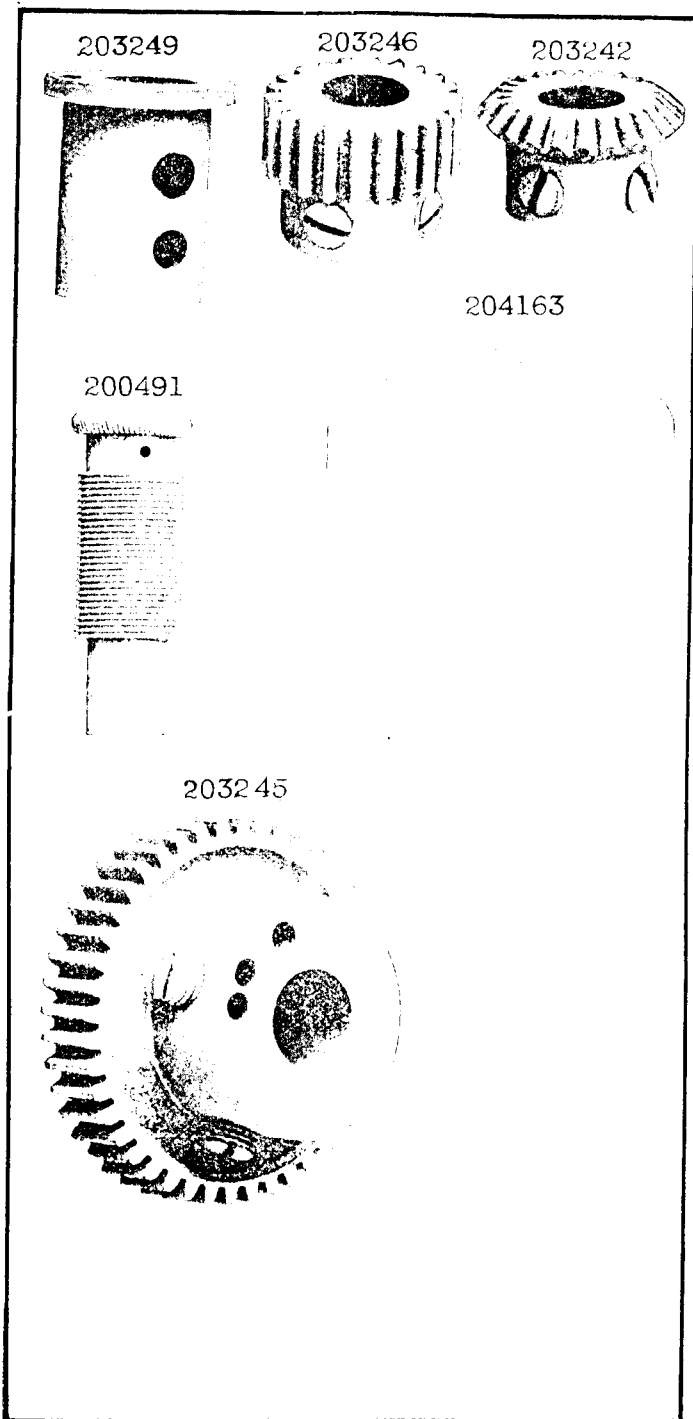


PLATE 12374—FULL SIZE

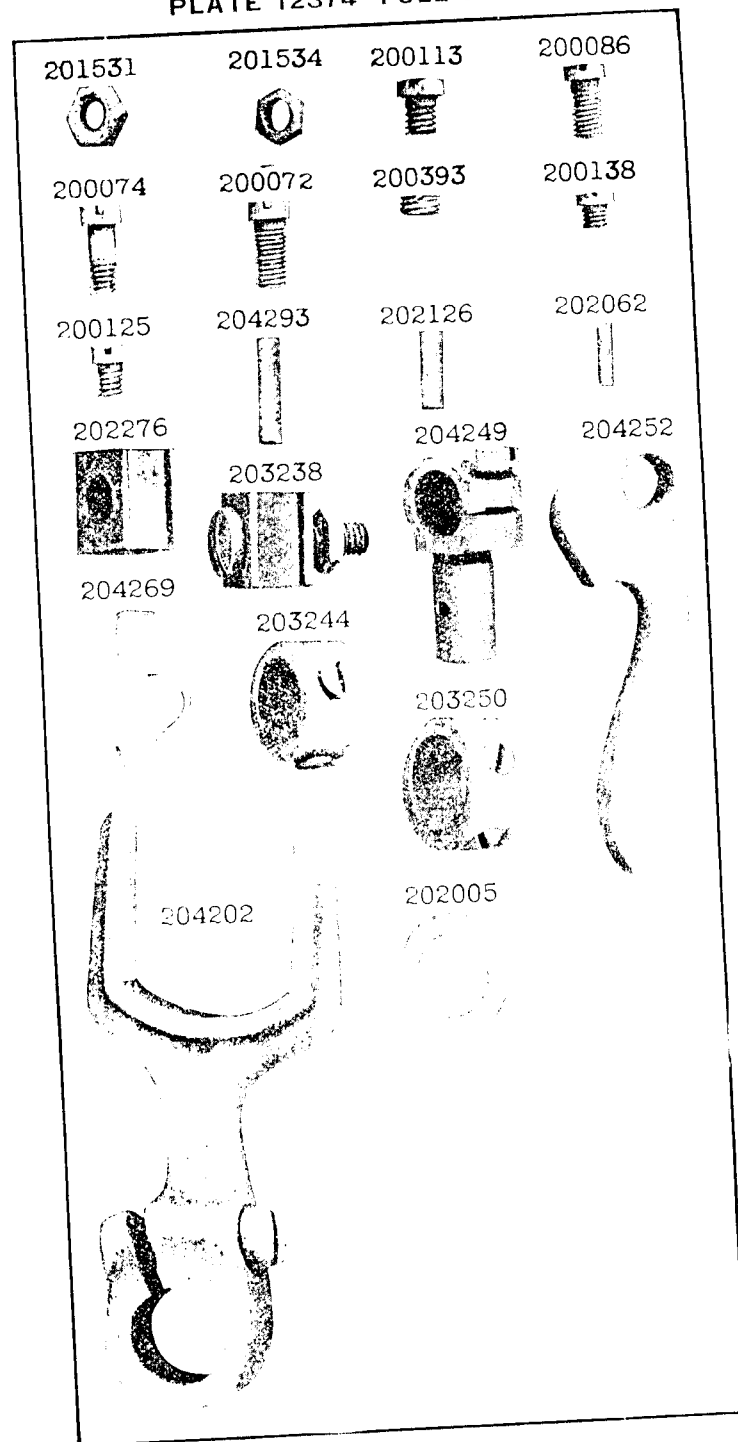


PLATE 12388—FULL SIZE

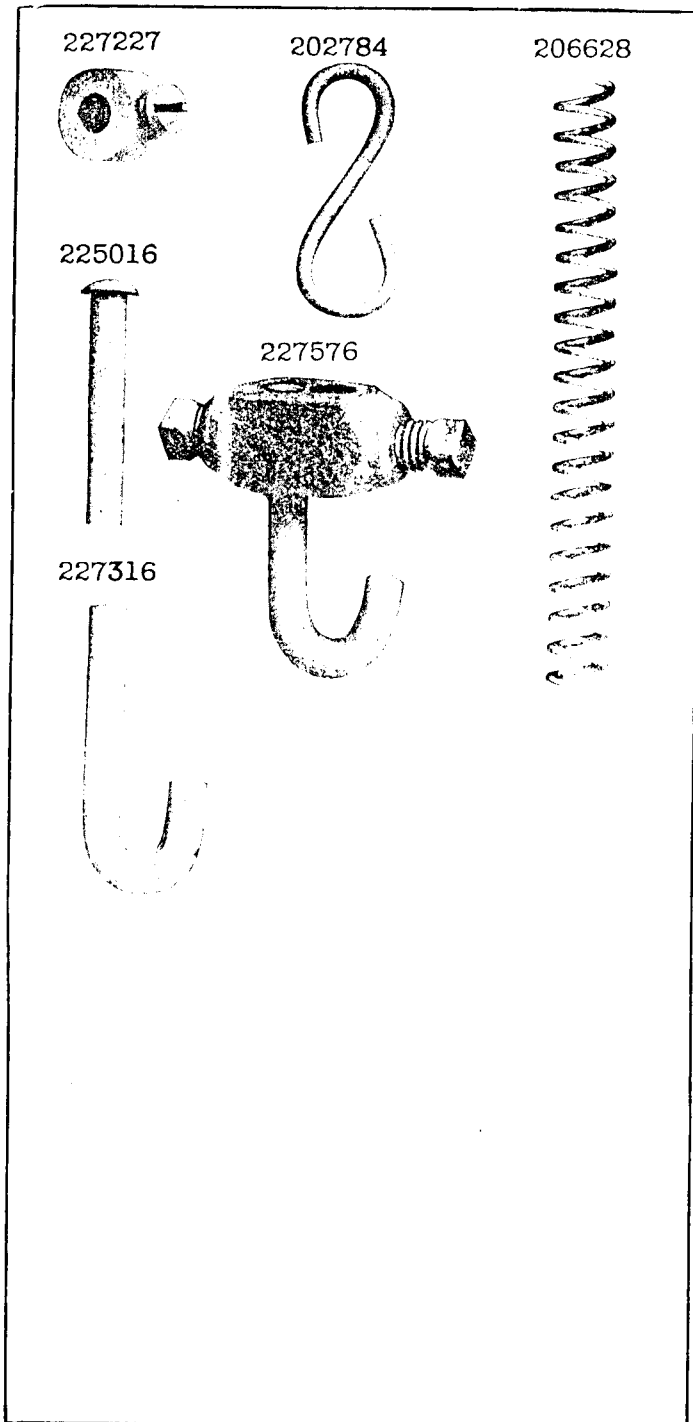


PLATE 13335—FULL SIZE

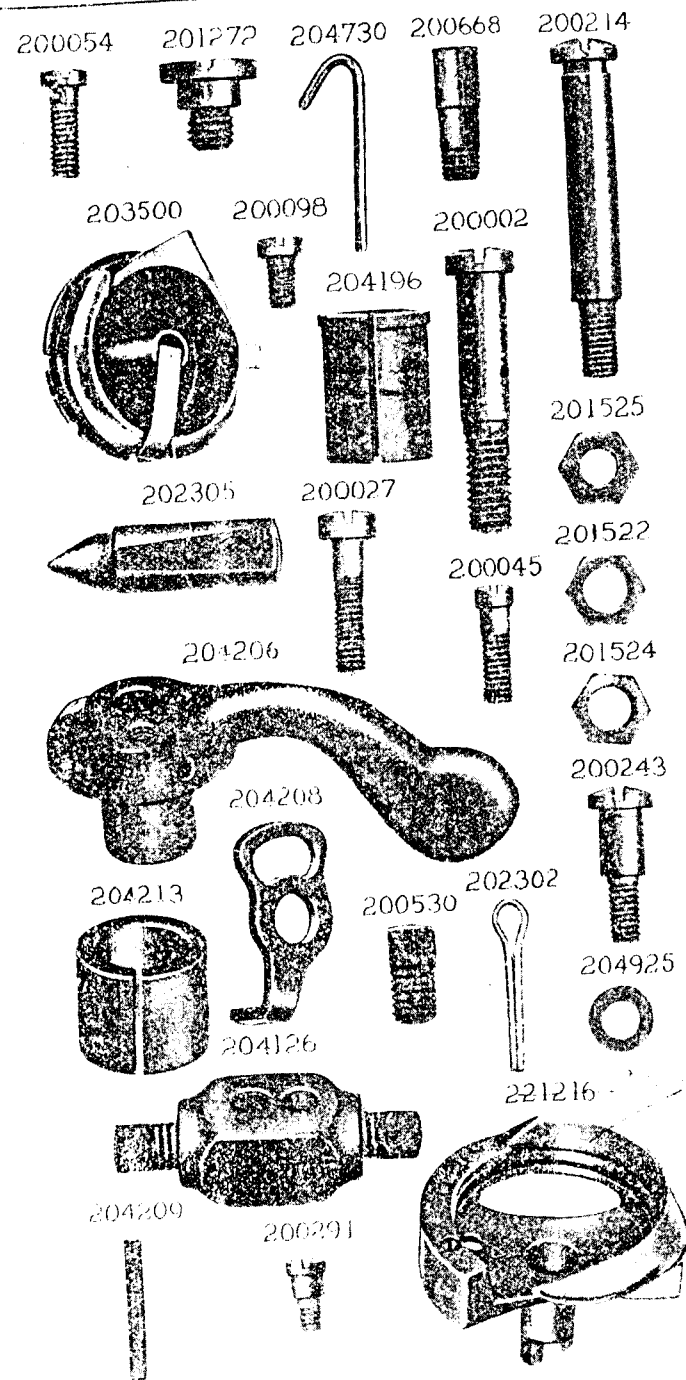
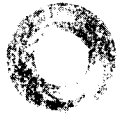


PLATE 13997—FULL SIZE

204235



202248

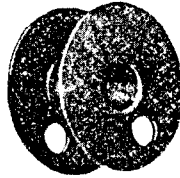


204248

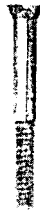
10554



203470



200555



200076



234079



203648



203473



203251



203474



234065



204185



200382



200658



203214



202036



201519



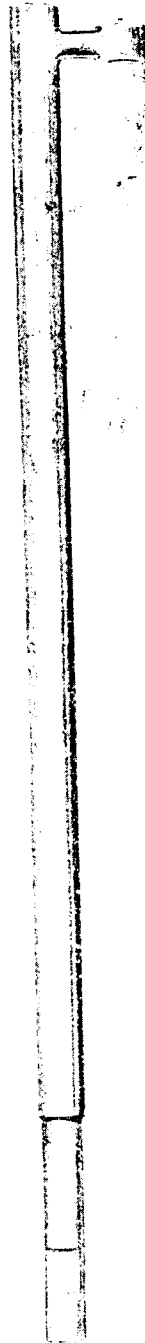
200594

200984

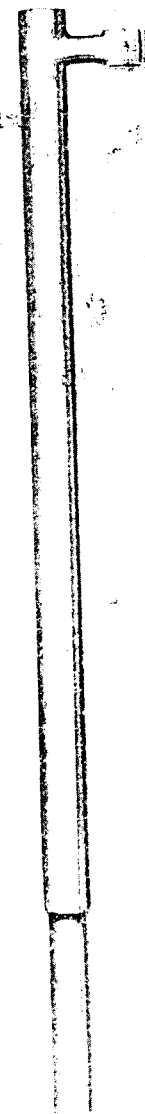


PLATE 13998—ONE-HALF SIZE

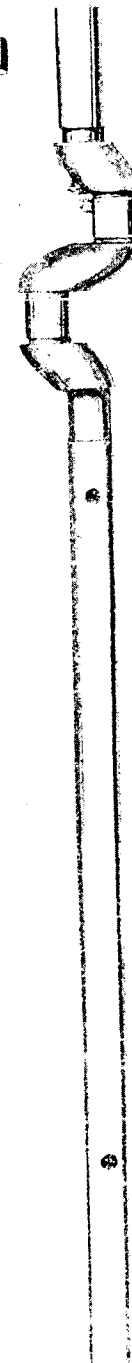
204294



204199



213624



203247

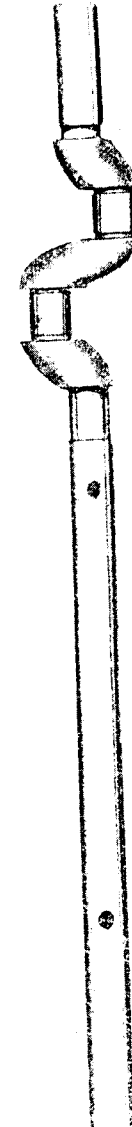
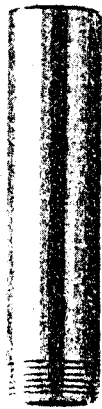
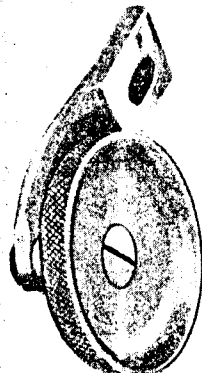


PLATE 13999-FULL SIZE

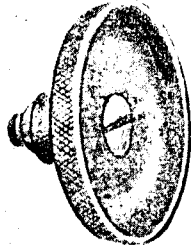
213435



204567



201906



201914



200548



204572



200504



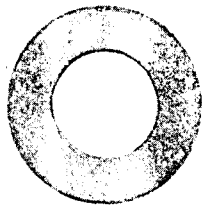
204258



204262



203172



204263



204264

201816



204250

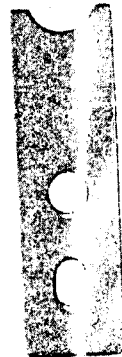


200175

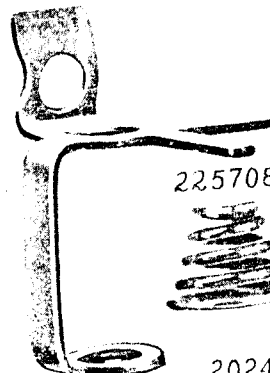


PLATE 14000-FULL SIZE

204267



208489



206608



201375



225708



202413



204273



200684



200380



200355



200019



200189



227954

