

FINEST QUALITY

Union Special[®]
LEWIS • COLUMBIA

**INDUSTRIAL
SEWING
MACHINES**

**CLASS
21700**

**INSTRUCTIONS
FOR
REPAIRING
AND
LIST OF PARTS
FOR
PULLING MACHINES**

**CATALOG
No. 32
Second
Edition**

Union Special **MACHINE COMPANY**

CHICAGO

Catalog No. 32

Second Edition

INSTRUCTIONS FOR REPAIRING
AND
LIST OF PARTS
FOR
CLASS 21700
PULLING MACHINES

Union Special
MACHINE COMPANY
INDUSTRIAL SEWING MACHINES
CHICAGO

Printed in U.S.A.

March, 1968

APPLICATION OF CATALOG

The matter contained in this catalog applies only to Union Special Pulling Machines, Class 21700.

SIMPLICITY The mechanism of these machines is so simple that they require practically no attention from the operator aside from regular oiling and cleaning.

OILING Wherever two or more moving parts contact each other, oil should be applied, **OFTEN**. The oiling diagram shows the various places where the oil should be applied, and all of the oiling places can be reached without removing the cloth plate.

It is very important that a good grade of light oil be used, particularly for the feed clutch mechanism. The use of *heavy lubricant* will prevent the feed clutch rollers from functioning properly. Lubricants of poor quality not only fail to form the proper filament of oil

PULLING MACHINE

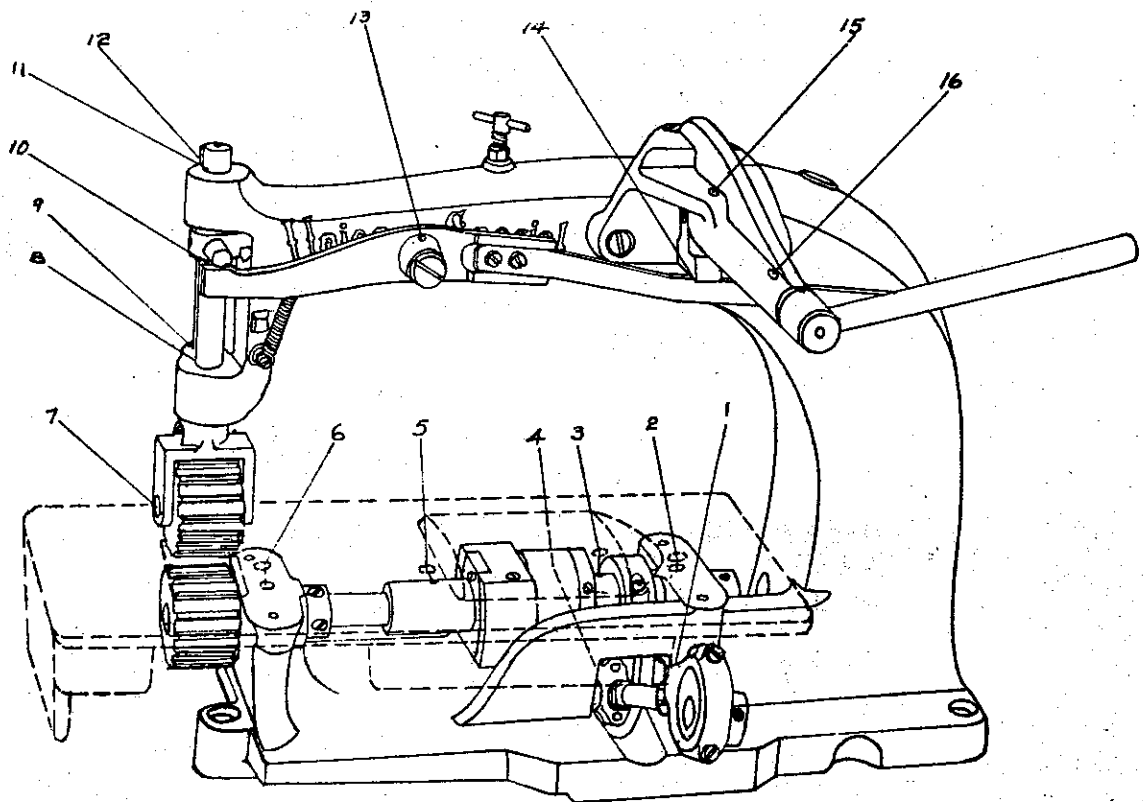

Oiling Diagram

APPLICATION OF CATALOG (Continued)

on the surfaces of the moving parts to provide protection from wear, but cause them to become gummed.

Frequent oiling is necessary, and we recommend that the machine be given a thorough oiling four times a day.

CLEANING In order to properly clean the machine, the cloth plate should be removed.

To clean out the feed clutch, gasoline should be poured into the oil recesses Nos. 3 and 5 (see diagram). The machine should then be run a few seconds and gasoline again applied. Again run the machine a few seconds until the gasoline has been worked out. Re-oil with a **GOOD GRADE OF LIGHT OIL**. This flushing operation should be repeated at least once a month when machine is operated continuously.

GENERAL INFORMATION When the puller fails to feed properly, it is usually due to one or more of the following causes:

- (1) An accumulation of gum on the feed clutch and check clutch rollers and shoes, in which case a thorough flushing of the feed clutch would be in order, as outlined under "Cleaning."
- (2) A weakened condition of the plunger springs No. 21718 A due to constant compression and expansion. Or it is possible one of these springs may be broken.
- (3) A slight groove in the face of the feed clutch or check clutch shoes, due to their constant contact with the oscillating steel rollers. These grooves will prevent the rollers from moving into a wedging position, which is so essential in order to function properly. The difficulty can be easily remedied by turning over the shoe to the unworn side, or replacing it.
- (4) A flat side or uneven surface on the feed clutch rollers. This condition prevents their oscillating and they should be replaced.

DISASSEMBLING Remove cloth plate, release check clutch holder No. 21716 C from bed by removing screw and nut, loosen screws in both shaft collars No. 21705, remove time screws in clutch sleeve No. 21717 C from holes marked "T" and loosen the remaining set screws. Grasp the feed roller and draw out the shaft. Loosen clamping screw in clutch arm No. 21709 and separate by pulling clutch from clutch arm. Separate clutches from the clutch sleeve by twisting apart, using both hands. This will cause the rollers, springs and plungers to fall out. It is advisable to provide a receptacle to catch them to avoid their being lost.

APPLICATION OF CATALOG (Continued)

REASSEMBLING The use of the clamping device illustrated below, will be found of great assistance for this purpose. Illustration

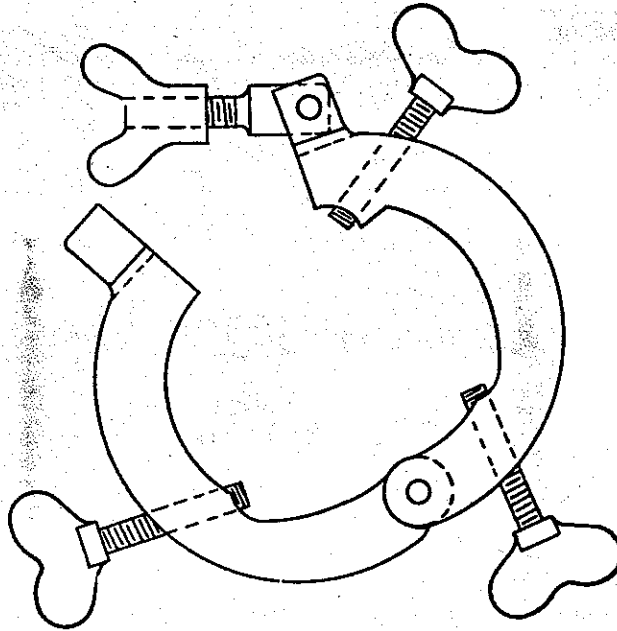

**Clamping Device No. 21745
Illustration No. 1**

No. 2 shows the clamping device in position with respect to the clutch rollers.

First put the shoes into position and secure them with their screws. Set the clutches upon their large end, slip the plungers into their springs and place into the retaining holes with plunger head out. Set the rollers on end and against plungers. Then place the clamping device No. 21745 into position as shown in illustration No. 2, making sure that the top of the clamp is flush with the top of the rolls. Turn the thumbscrews until the rollers are forced back as far as the plungers will permit. The clutch and clamp can now be lifted as a unit. Slip the clutch sleeve over the rollers as far as it will go. Remove the clamp and continue to slide the clutch sleeve over the rollers. After both clutches have been assembled in this manner, the feed clutch assembly is ready to be placed into the machine.

Slip the feed clutch into the feed clutch arm No. 21709. Insert shaft into its bearings, through the shaft collars and feed clutch assembly. In sliding the shaft through the clutch assembly it is necessary to turn the clutch sleeve with the fingers. This allows the holes to line up and permits the passage of the shaft. Turn the clutch sleeve on the shaft until the screw holes, marked "T" line up with the slot in the shaft, which can be seen through screw holes. Insert screws in screw holes and force screws into position while assembled

APPLICATION OF CATALOG (Continued)

clutch is held against inside bed lug to avoid lateral movement. Also set up the remaining set screws. Tighten screws in shaft collars.

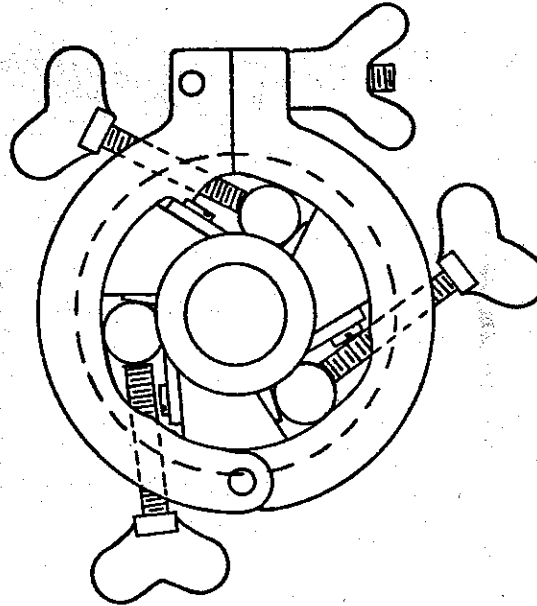

Clamping Device in Position
Illustration No. 2

Replace check clutch holder screw in bed, turning in as far as it will go without forcing to prevent binding of check clutch, then attach the lock nut. Locate clutch arm in such a position on the feed clutch so as not to cramp the connection with sewing machine. Replace cloth plate and machine is ready to operate.

ORDERING REPAIR PARTS

PLATES Grouped together according to scale will be found illustrations of parts similar in appearance, and to some extent, component parts that go together in the same subdivisions of the mechanism.

LIST OF PARTS Turning from plates to the list of parts, the definition of each part and its principal uses will be found. Always check the symbol against its definition before ordering. It is not necessary to furnish the plate number.

For convenience in ordering, minor parts, such as screws, nuts, and similar articles are repeated after each major part.

(—) A dash in the "plate number" column of the list of parts indicates the absence of an illustration.

(□) A square in the "Symbol to order by" column indicates that the part is commercial and can be readily purchased in any machinist's supply house.

(‡) A double dagger in the "Symbol to order by" column indicates that the component parts cannot be furnished separately.

IDENTIFYING PARTS Where the construction permits, each part is stamped with its part number. Some of the smaller parts are stamped with an identification letter to distinguish them from parts similar in appearance.

All part numbers represent the same part regardless of the catalog in which they appear.

SUPPLIES All supplies, including taps, reamers, belting, belt hooks, belt fasteners, screw drivers, and powdered oil stone will be promptly furnished.

TERMS Prices are strictly net cash and subject to change without notice. Express and freight shipments are forwarded at the buyer's risk f. o. b. shipping point. Parcel post shipments are insured unless otherwise directed. A charge is made to cover the postage and insurance.

Plate 1—Full Size



96



98



95



605 A



77



87



22751



22597



22590



21725



81



22526



93



22517



22754



22574



136

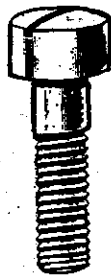

318



22811



22587



74



22577



22802

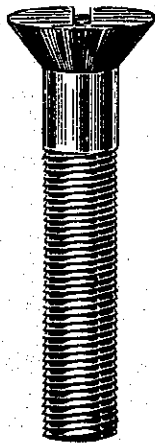

22637 D

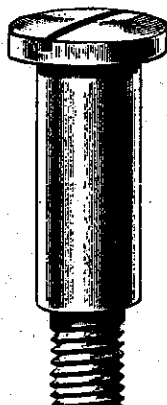

420

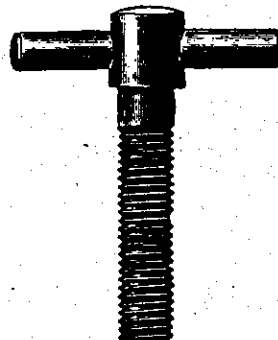

64 A



22517 A

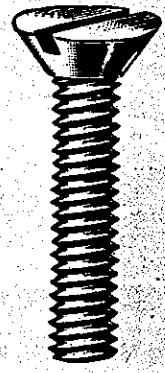

22637 A

Plate 2—Full Size



21718 A



21718 B



18



21714

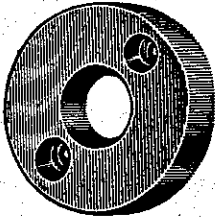

21741 B

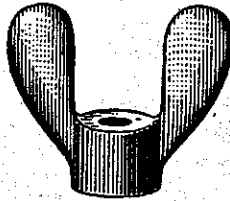

21745 B

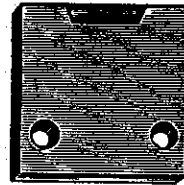

21713 E

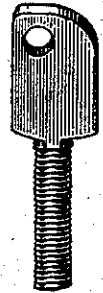

21745 A

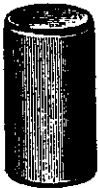

21719 B

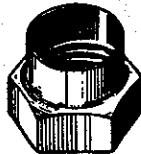

15430 C

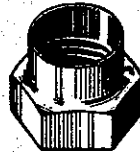

15430 D



21712



V109

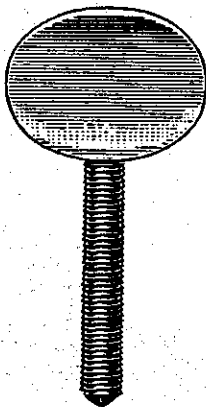

21745 C



21724 A

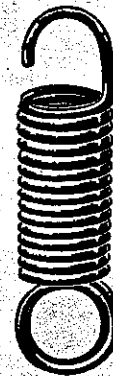

426

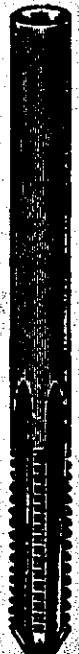

V118

Plate 3—One-half Size



21705



21741
21741 A

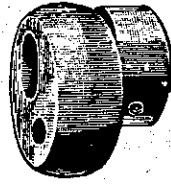

21703

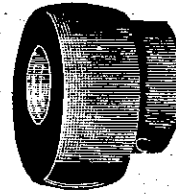

21703 A

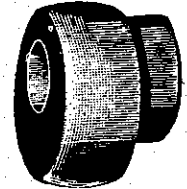

21703 H

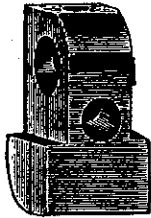

21735



15430 E

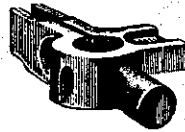

21728

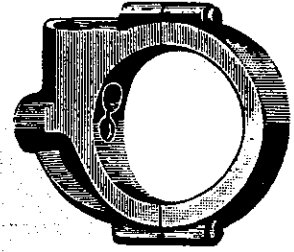

21707

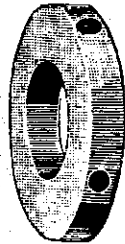

21713 B

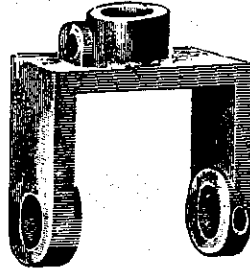

21726

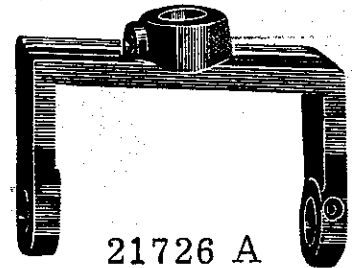

21726 A

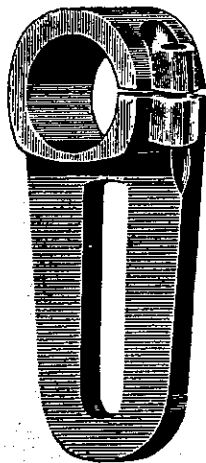

21709

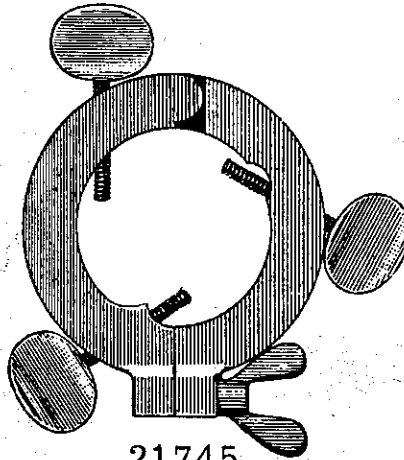

21745

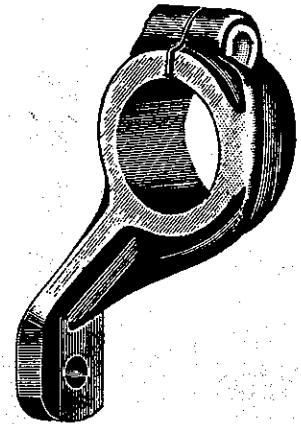

21716 AK

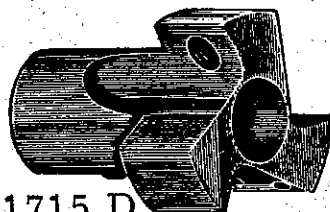

21715 D

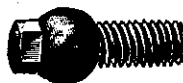

21710

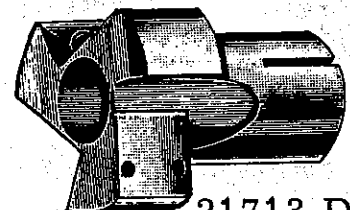

21713 D

Plate 4—One-half Size

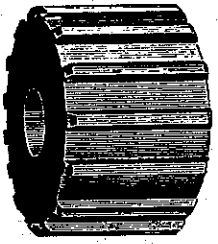

21722 A

(STD)

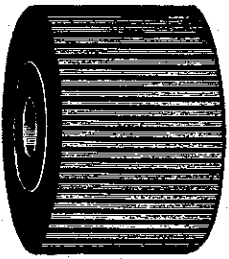

21722 B

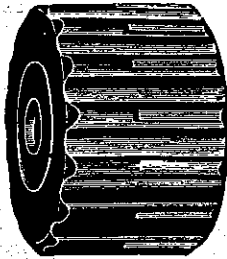

21722 D
21722 C

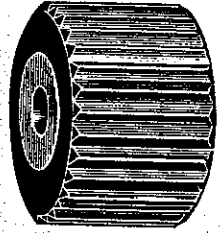

21722 E

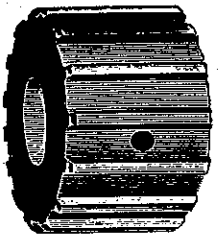

21720 A

(STD)

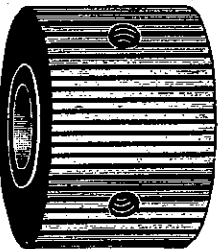

21720 B

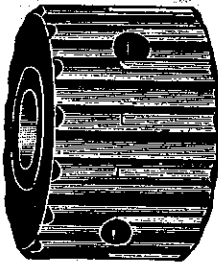

21720 D

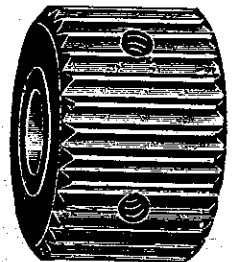

21720 E

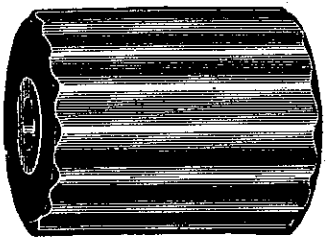

21722 L

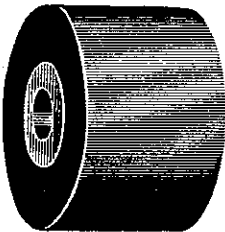

21722 U

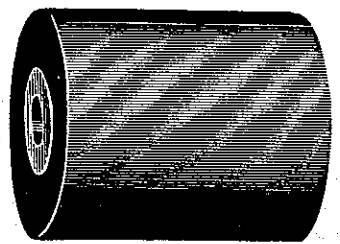

21722 V

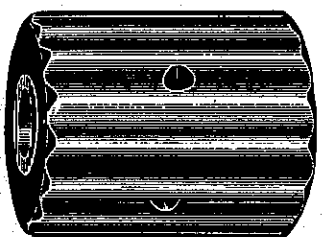

21720 L

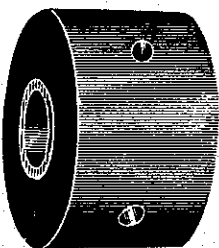

21720 U

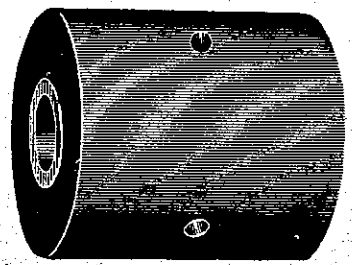

21720 V

Plate 5—One-half Size



21731



21727



21733 A



21729 A



21708
21708 D



21711



21724



21723

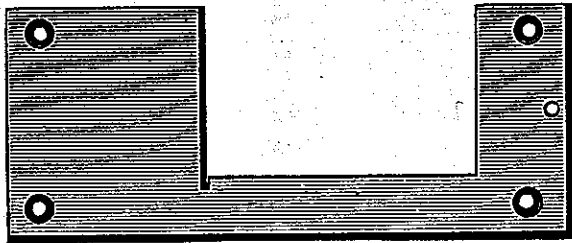

21721 A



21723 A



21723 B

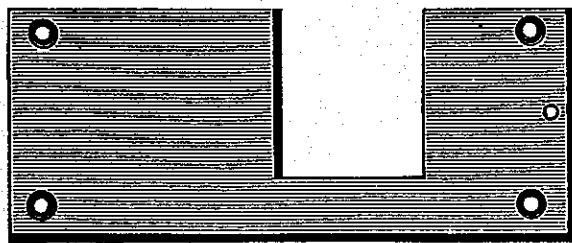

21721 B

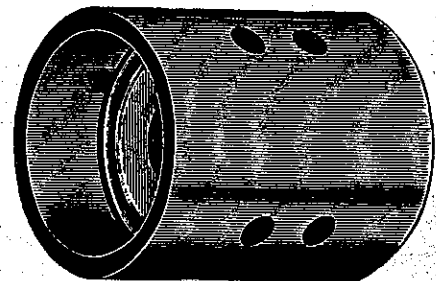

21717 C

Plate 6—One-fourth and One-eighth Sizes



21293 C



21704 B



21292 C



21734 AK



21733

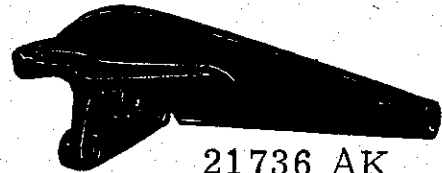

21736 AK
21736 AL

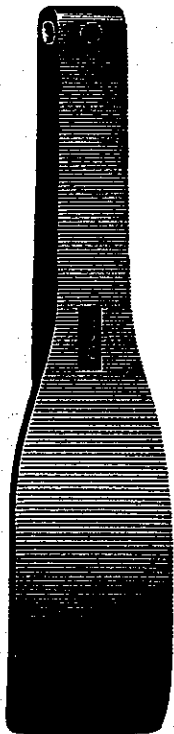

21291 D

one-eighth size



21702 A
21702 D

one-eighth size

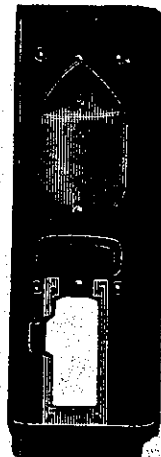

21702 B
21702 C

LIST OF PARTS

Symbol to Order By	The figures in the last column refer only to the plates illustrating the parts and are not to be used in ordering. Prices furnished on application.	Plate No.
18	Check Clutch Holder Screw Lock Nut, for No. 22517 A	2
64 A	Presser Spring Regulating Screw -----	1
64 B	Presser Spring Regulating Screw Nut -----	1
74	Clamp Screw, for feed clutch arm -----	1
77	Set Screw, for presser roller axles -----	1
81	Spot Screw, for driving eccentric; also for Nos. 21726, 21726 A -----	1
87	Screw, for throat plates -----	1
93	Screw, for lifter lever extension. -----	1
95	Set Screw, for driving eccentrics; also for Nos. 21293 C, 21713 B, 21726, 21726 A, 21728-----	1
96	Spot Screw, for presser bar connection and presser spring rest; also for No. 21735 -----	1
98	Set Screw, for driving eccentrics; also for No. 21705	1
V109	Tap marked "J2", for No. 22526-----	2
V118	Tap marked "X2", for No. 22754-----	2
136	Clamp Screw, for check clutch holder -----	1
318	Screw, for lifter cam shaft bracket -----	1
420	Lifter Lever Stud -----	1
426	Lifter Lever Spring -----	2
605 A	Lifter Lever Spring Screw No. 22515	
15430 C	Screw, for feed clutch and check clutch shoes -----	1
15430 D	Driving Eccentric Connecting Rod Nut, left thread	2
15430 E	Driving Eccentric Connecting Rod Nut, right thread	2
‡15430 E	Driving Eccentric Connecting Rod Rear Bearing -----	3
	Driving Eccentric Connecting Rod Rear Bearing Screws No. 22587 -----	-
21290 C	Lifter Treadle Assembly-----	-
21291 D	Lifter Treadle -----	6
21292 C	Lifter Treadle Base -----	6
21293 C	Lifter Treadle Pin -----	6
	Lifter Treadle Pin Set Screw No. 95	
21701 C	Base Plate, for pulling machine and sewing head	-
21702 A	Cloth Plate, for use with 2 1/4 inch feed rollers	6
21702 B	Cloth Plate, for use with 1 1/4 inch feed rollers	6
21702 C	Cloth Plate, taupe finish, for use with 1 1/4 inch feed rollers -----	6
21702 D	Cloth Plate, taupe finish, for use with 2 1/4 inch feed rollers -----	6
	Cloth Plate Screws No. 22574	
21703	Driving Eccentric, four to seven stitches per inch	3
21703 A	Driving Eccentric, eleven to sixteen stitches per inch	3
21703 H	Driving Eccentric, seven to thirteen stitches per inch	3
	Driving Eccentric Spot Screw No. 81 or 22894 L	
	Driving Eccentric Set Screw No. 98 or 22894 C	
21704 B	Shaft, hardened and ground, diameter .625 inch-----	6
21705	Shaft Collar -----	3
	Shaft Collar Screws No. 98 or 22894 C	
21707	Driving Eccentric Connecting Rod Front Bearing	3
	Driving Eccentric Connecting Rod Front Bearing Screws No. 22587	-

‡ See page 7

LIST OF PARTS

Symbol to Order By	The figures in the last column refer only to the plates illustrating the parts and are not to be used in ordering. Prices furnished on application.	Plate No.
21708	Driving Eccentric Connecting Rod Tube, 4 5/8 inches long -----	5
21708 D	Driving Eccentric Connecting Rod Tube, 2 1/8 inches long, for taupe finish pullers ----- Driving Eccentric Connecting Rod Nut, left thread, No. 15430 C ----- Driving Eccentric Connecting Rod Nut, right thread, No. 15430 D -----	5
21709	Feed Clutch Arm -----	3
21710	Feed Clutch Arm Clamp Screw No. 74 ----- Driving Eccentric Connecting Rod Rear Bearing Ball Stud -----	3
21711	Driving Eccentric Connecting Rod Rear Bearing Ball Stud Nut -----	5
21712	Driving Eccentric Connecting Rod Rear Bearing Ball Stud Washer -----	2
21713 B	Feed Clutch Collar -----	3
21713 D	Feed Clutch Collar Screws No. 95 -----	3
21713 E	Feed Clutch, without shoes ----- Feed Clutch Shoe, hardened and ground; also for No. 21715 D -----	2
21714	Feed Clutch Shoe Screw No. 605 A -----	2
21715 D	Feed Clutch Key -----	3
21715 AK	Check Clutch, without shoes ----- Check Clutch Holder ----- Check Clutch Holder Set Screw No. 22517 A ----- Check Clutch Holder Clamp Screw No. 136 -----	3
21717 C	Feed Clutch Sleeve, hardened and ground ----- Feed Clutch Sleeve Screws Nos. 22590, HA95 -----	5
21718 A	Feed Clutch Roller Spring -----	2
21718 B	Feed Clutch Roller Spring Pin -----	2
21719 B	Feed Clutch Roller, hardened and ground -----	2
21720 A	Feed Roller, steel, 1 1/4 inches long, square cut teeth Feed Roller Screws No. 22597 -----	4
21720 B	Feed Roller, wood fibre, 1 1/4 inches long, fine cor- rugated face ----- Feed Roller Screws No. 22751 -----	4
21720 D	Feed Roller, steel, 1 1/4 inches long, convex teeth with square offset ----- Feed Roller Screws No. 22597 -----	4
21720 E	Feed Roller, wood fibre, 1 1/4 inches long, "V" cut teeth ----- Feed Roller Screws No. 22751 -----	4
21720 L	Feed Roller, steel, 2 1/4 inches long, concave between teeth -----	4
21720 U	Feed Roller, rubber, 1 1/4 inches long, 2 inches diameter, flat face -----	4
21720 V	Feed Roller, rubber, 2 1/4 inches long, 2 inches diameter, flat face ----- Feed Roller Screws No. 22597 -----	4
21721 A	Throat Plate, for use with 2 1/4 inch feed rollers----	5
21721 B	Throat Plate, for use with 1 1/4 inch feed rollers----	5
	Throat Plate Screws No. 87 -----	

LIST OF PARTS

Symbol to Order By	The figures in the last column refer only to the plates illustrating the parts and are not to be used in ordering. Prices furnished on application.	Plate No.
21722 A	Presser Roller, steel, for use with feed roller No. 21720 A -----	4
21722 B	Presser Roller, wood fibre, for use with feed roller No. 21720 B -----	4
21722 C	Puller Roller, steel, for Style 21700 AK, 3/32 inch grooves 1 1/4 inch long, for use with feed roller No. 21720 A -----	4
21722 D	Presser Roller, steel, for use with feed roller No. 21720 D -----	4
21722 E	Presser Roller, wood fibre, for use with feed roller No. 21720 E -----	4
21722 L	Presser Roller, steel, for use with feed roller No. 21720 L -----	4
21722 U	Presser Roller, rubber, for use with feed roller No. 21720 U -----	4
21722 V	Presser Roller, rubber, for use with feed roller No. 21720 V -----	4
21723	Presser Roller Axle Assembly, for use with 1 1/4 inch presser rollers; one each Nos. 21723 A, 21724, 21725, 28619 -----	5
21723 A	Presser Roller Axle, 1 11/16 inches long -----	5
21723 B	Presser Roller Axle Assembly, for use with 2 1/4 inch presser rollers; one each Nos. 21723 C, 21724 A, 21725, 28619 -----	5
21723 C	Presser Roller Axle, 2 13/16 inches long -----	-
	Presser Roller Axle Set Screw No. 77	
21724	Presser Roller Axle Spring, for use with No. 21723 A	5
21724 A	Presser Roller Axle Spring, for use with No. 21723 C	2
21725	Presser Roller Axle Spring Screw -----	1
21726	Presser Roller Hanger, for 1 1/4 inch rollers -----	3
21726 A	Presser Roller Hanger Spot Screw No. 81	
	Presser Roller Hanger Set Screw No. 95	
21727	Presser Bar, hardened and ground, diameter .530 inch	5
21728	Presser Bar Connection and Presser Spring Rest -	3
	Presser Bar Connection and Presser Spring Rest Spot Screw No. 96	
	Presser Bar Connection and Presser Spring Rest Clamp Screw No. 22517	
	Presser Bar Connection and Presser Spring Rest Set Screw No. 95	
21729 A	Presser Spring -----	5
	Presser Spring Screw Pin No. 22577	
21731	Presser Guide Bar, hardened and ground, diameter .319 inch -----	5
21733	Lifter Lever Casting (screw No. 420) -----	6
21733 A	Lifter Lever Extension -----	5
21734	Lifter Cam Shaft -----	6
21734 G	Lifter Shaft Spring (screw No. 22585 A) -----	-
21734 AK	Lifter Cam Shaft, for Fifty Thousand Series Machines	6
21735	Lifter Cam, hardened -----	3
	Lifter Cam Clamp Screw No. 22811	
	Lifter Cam Spot Screw No. 96	
21736 AK	Lifter Cam Shaft Bracket, for Style 21700 AK -----	6

LIST OF PARTS

Symbol to Order By	The figures in the last column refer only to the plates illustrating the parts and are not to be used in ordering. Prices furnished on application.	Plate No.
21736 AL	Lifter Cam Shaft Bracket -----	6
	Lifter Cam Shaft Bracket Screws No. 318	
21741	Shaft Spacing Collar, between frame and lower feed roller -----	3
21741 A	Spacing Collar, between feed clutch and rear bearing	3
21741 B	Shim, 5/8 inch thick for increasing height of machine	2
21745	Clutch Assembling Clamp, complete -----	3
21745 A	Clutch Assembling Clamp Locking Screw -----	2
21745 B	Clutch Assembling Clamp Locking Screw Wing Nut	2
21745 C	Clutch Assembling Clamp Thumbscrew -----	2
22515	Screw, for lifter lever spring -----	-
22517	Clamp Screw, for presser bar connection and presser spring rest -----	1
22517 A	Screw, for check clutch holder -----	1
22526	Screw, plus size, for throat plates, 3/16 inch diameter, tap No. V109 -----	1
22574	Screw, for cloth plate -----	1
22577	Screw Pin, for presser spring -----	1
22585 A	Screw, for lifter shaft spring -----	-
22587	Screw, for driving eccentric connecting rod bearings	1
22590	Screw, for feed clutch sleeve -----	1
22597	Screw, for feed clutch collar; also for Nos. 21720 A, 21729 D, 21720 L, 21720 P, 21720 R -----	1
22637 A	Screw, 1 1/2 inches long, for fastening machine to base plate -----	1
22637 B	Screw, 2 1/2 inches long, for mounting machine	-
22637 D	Screw, 1 3/4 inches long, for fastening machine to base plate -----	1
22751	Screw, for wood fibre feed rollers -----	1
22754	Screw, plus size, for cloth plates, Tap No. V118- ---	1
22802	Stop Screw, for lifter cam -----	1
22811	Clamp Screw, for lifter cam -----	1
22894 C	Set Screw, for driving eccentric; also for No. 21705	-
22894 L	Spot Screw, for driving eccentric -----	-
29138	Driving Eccentric Assembly, four to seven stitches to inch; one each Nos. 21703 and 21707 lapped together	-
29138 A	Driving Eccentric Assembly, eleven to sixteen stitches to inch; one each Nos. 21703 A and 21707 lapped together -----	-
29138 C	Driving Eccentric Assembly, seven to thirteen stitches to inch; one each Nos. 21703 H and 21707 lapped together -----	-
29138 H	Puller Driving Eccentric Assembly, seven to thirteen stitches to inch, one each 21703 H, 21707 B lapped together -----	-
29139	Driving Eccentric Connecting Rod Rear Bearing Assembly; one each Nos. 21710 and 15430 E lapped together -----	-

LIST OF PARTS

Symbol to Order By	The figures in the last column refer only to the plates illustrating the parts and are not to be used in ordering. Prices furnished on application.	Plate No.
29139 A	Driving Eccentric Connecting Rod Rear Bearing Assembly, for Style 21700 AK; one each Nos. 21707 C, 21710 lapped together -----	-
29139 C	Puller Drive Connecting Rod Ball Joint, front, for Style 21700 AL, one each Nos. 21707 C, G21710 lapped together -----	-
29139 D	Pulley Drive Connecting Rod Ball Joint, rear, for Style 21700 AL, one each Nos. 21707 F, 21710 lapped together -----	-
51293 D	Coupling, for oiling tubes -----	-
51293 E	Oil Tube, right, for Fifty Thousand Series Machines	-
51293 F	Oil Tube, middle, for Fifty Thousand Series Machines	-

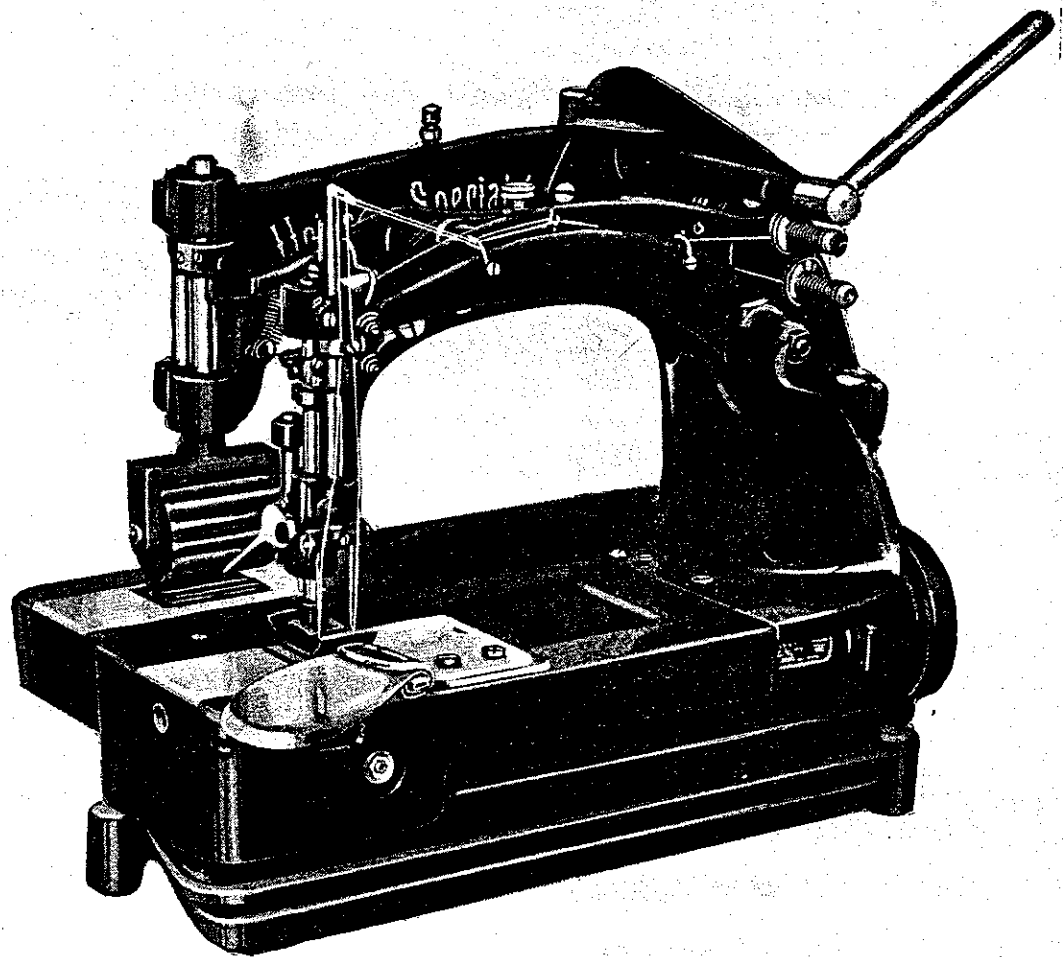

Union Special Pulling Machine
As operated in connection with Style 7400 AG
for Hemming Bloomers and
Inserting Elastic



Union Special[®]
INDUSTRIAL SEWING MACHINES

UNION SPECIAL maintains sales and service facilities throughout the world. These offices will aid you in the selection of the right sewing equipment for your particular operation. Union Special representatives and service men are factory trained and are able to serve your needs promptly and efficiently. Whatever your location, there is a Union Special Representative to serve you. Check with him today.

ATLANTA, GA.

BOSTON, MASS.

CHICAGO, ILL.

DALLAS, TEXAS

LOS ANGELES, CAL.

NEW YORK, N. Y.

PHILADELPHIA, PA.

MONTREAL, QUEBEC

BRUSSELS, BELGIUM

LEICESTER, ENGLAND

LONDON, ENGLAND

PARIS, FRANCE

STUTT GART, GERMANY

Representatives and distributors in all important industrial cities throughout the world.

Union Special

MACHINE COMPANY