

## LIST OF PARTS

## LISTADO DE PIE

Singer	18-1
Singer	18-2
Singer	18-3
Singer	18-5
Singer	18-6
Singer	18-7
Singer	18-8
Singer	18-9
Singer	18-14
Singer	18-15
Singer	18-16
Singer	18-17
Singer	18-18

PDF File not available

Archivo PDF no está disponible

For a copy of this chart, please contact our  
CustomerService department.

Para una copia de este gráfico, por favor contacte a  
Nuestro Departamento de Servicios al Cliente.

Search on “Directory” for telephone, fax number and  
E-mail address.

Busque la palabra “Directory” y Ud. Encontrará el número del teléfono, Fax y dirección del correo electrónico.

Form 8903—Revised  
July, 1929  
PRINTED IN U. S. A.

# LIST OF PARTS



## MACHINES

Nos. 18-1 to 18-3, 18-5  
to 18-9 and 18-14  
to 18-18

---

THE SINGER MANUFACTURING COMPANY

COPYRIGHT, U. S. A., 1914, 1923 and 1929,  
BY THE SINGER MANUFACTURING COMPANY  
ALL RIGHTS RESERVED FOR ALL COUNTRIES

## INDEX

	PAGE
ATTACHMENTS AND ACCESSORIES.....	95
BOBBIN WINDERS.....	96
FOOT LEVER PARTS.....	99
“ LIFTER PARTS.....	99
KNEE LIFTER PARTS.....	100
MACHINE BASE.....	95
“ No. 18-1.....	7
“ “ 18-2.....	12
“ “ 18-3.....	19
“ “ 18-5.....	25
“ “ 18-6.....	34
“ “ 18-7.....	42
“ “ 18-8.....	48
“ “ 18-9.....	53
“ “ 18-14.....	61
“ “ 18-15.....	66
“ “ 18-16.....	73
“ “ 18-17.....	82
“ “ 18-18.....	88
NUMERICAL LIST OF PARTS.....	109
OBSOLETE PARTS.....	102
STAND.....	101

## INSTRUCTIONS FOR ORDERING

In ordering from this list, use **ONLY** the part NUMBER in the **FIRST** column.

The number stamped on a Sewing Machine part is in every case the number of the single part only.

Every combination of parts sent out as such has its specific number, which, although not stamped on the parts, must be used when ordering the combination.

Each number always indicates the **SAME PART** in whatever list it appears, or for whatever machine.

The letters after some of the numbers indicate the style of finish only, as follows:

- A—Hardened, Polished, Nickel Plated and Buffed
- B—Polished, Nickel Plated and Buffed
- C—Hardened Only
- D—Polished Only
- E—Soft, Not Polished
- F—Hardened and Polished
- H—Blued
- J—Nickel Plated Only
- K—Hardened and Nickel Plated
- L—Brass Plated
- M—Oxidized
- P—Japanned
- R—Merlized
- T—Copper Plated
- T. A.—Hardened, Polished, Copper and Nickel Plated and Buffed.
- T. B.—Copper and Nickel Plated and Polished.
- T. J.—Copper and Nickel Plated Only.
- T. K.—Hardened, Copper and Nickel Plated.
- T. M.—Copper Plated and Oxidized.
- T. L.—Copper and Brass Plated.
- U—Zinc Plated
- V—Silver Plated
- W—Polished and Nickel Plated
- Z—Chromium Plated

These letters **MUST BE USED** when they appear in the list; and **AFTER** the number **as** in the list.

In this series:

- 1 to 1500 and 50001 to 51500 are Screw Numbers.
- 1501 to 1800 and 51501 to 51800 are Nut Numbers.
- 1801 to 2000 and 51801 to 52000 are Roller Numbers.
- 2001 to 50000 and 52001 and upward are numbers of Machine Parts.

The figures in the second column refer only to the plates, illustrating the parts, and are **NOT TO BE USED** in ordering.

Parts marked with an asterisk (\*) are furnished only when repairs are made at factory.

When ordering parts which differ as to **Gauge** (the distance between seams) the Gauge, as well as the **Number must be given** on order.

## LIST OF PARTS COMPLETE FOR MACHINE No. 18-1

FOR SHOE WORK. HAS DROP FEED AT RIGHT  
OF NEEDLE, ROLLER PRESSER

NO.	PLATE	NAME
*16170	—	Arm and Cylinder.....
3004	391	“ Shaft.....
3005	393	“ “ Bushing.....
448c	402	“ “ “ Set Screw.....
144b	402	“ “ Screw.....
4288	411	“ Side Cover (back).....
286b	401	“ “ “ “ Thumb Screw....
16102	3652	“ “ “ (front).....
164b	412	“ “ “ “ Screw.....
12403	400	“ Spool Pin and Thread Eyelet.....
8879	412	“ “ “ Washer (cloth).....
4370	391	Balance Wheel, heavy rim, 2¾ in. pulley, with two 448c.....
4388	3655	Balance Wheel (power) light rim, 2¾ in. pulley, with two 448c.....
2862	391	Balance Wheel (stand) heavy rim, 3 in. pulley, for 3022.....
448c	402	Balance Wheel Set Screw.....
256j	392	Clamp Stop Motion Clamp Screw.....
248A	402	“ “ “ “ Stop Screw....
2020	392	“ “ “ “ Washer.....
*3023	—	“ “ “ Flanged Bushing....
4933	392	“ “ “ “ “ 3023 with two 462c.....
2022	400	Clamp Stop Motion Flanged Bushing Pin
462c	412	“ “ “ “ “ Set Screw.....
3022	—	Clamp Stop Motion complete, Nos. 248A, 256j, 2020 and 4933.....
16158	3655	Cloth Plate.....
16143	3655	“ “ Bracket with 1107c.....
1107c	412	“ “ “ Set Screw.....
389F	401	“ “ Screw.....
16159	3655	“ “ Slide.....
3286	397	“ “ “ Spring.....
725j	412	“ “ “ “ Screw.....

## PARTS FOR MACHINE No. 18-1

NO.	PLATE	NAME
16160	3655	Cloth Plate complete, Nos. 3286, 16158, 16159 and two 725J.....
16161	—	Cloth Plate with Bracket complete, Nos. 16143, 16160 and two 389F.....
4292	391	Crank Connecting Rod with 4349 and two 145E.....
*4349	—	Crank Connecting Rod Cap.....
145E	3669	" " " " Screw.....
375c	402	" " " " Hinge Screw.....
1518E	401	" " " " " Nut
16045	412	Cylinder Oil Tube for oiling 6462.....
16036	411	" Side Cover.....
286D	401	" " " Thumb Screw.....
3032	393	Feed Cam with 446c.....
446c	402	" " Set Screw.....
3033	397	" Connecting Link.....
375c	402	" " " " Hinge Screw.....
1518E	401	" " " " " Nut..
16162	3678	" Dog.....
6458	397	" " Carrier.....
231c	412	" " Screw.....
3037	391	" Forked Connection.....
375c	402	" " " " Hinge Screw....
1518E	401	" " " " " Nut
6459	393	" Regulator.....
58E	402	" " Hinge Screw.....
818D	401	" " Thumb Screw.....
6460	391	" Rock Shaft.....
6018	392	" " " Crank with 207F.....
156F	402	" " " " Position Screw..
207F	402	" " " " Set Screw.....
16642	3656	Needle Bar with 10160.....
*3045	3669	" " Connecting Link.....
16220	—	" " " " 3045 with 377c, 1518E and 6487.....
377c	402	Needle Bar Connecting Link Hinge Screw
1518E	401	" " " " " " "
		Nut.....
6487	397	Needle Bar Connecting Stud with 155c..
155c	402	" " " " " Set Screw..
290E	402	" " Screw Bushing.....
16643	3654	" " Thread Guard.....
240D	402	" " " " Screw.....
16644	3654	" Clamp with 1112F.....
1112F	3654	" " Screw.....
10160	3664	" Stop Pin.....
*6461	392	Oscillating Rock Shaft (steel) with 4784..

## PARTS FOR MACHINE No. 18-1

NO.	PLATE	NAME
16176	—	Oscillating Rock Shaft complete, Nos. 6461 and 16212.....
6489	392	Oscillating Rock Shaft Hinge Pin ....
16212	—	" " " " " " 6489 with 1513J.....
1513J	401	Oscillating Rock Shaft Hinge Pin Nut...
4784	412	" " " Oil Pad.....
6462	391	" Shaft.....
*6056	—	" " Crank with 460c and 1813.....
6024	397	Oscillating Shaft Crank with 1813 and two 462c.....
2049	400	Oscillating Shaft Crank Pin.....
1813	401	" " " Roller and Stud.
462c	412	" " " Set Screw for 6024
460c	402	" " " " " " 6056
3054	393	Presser Bar.....
6464	393	" " Lifter.....
77J	412	" " " Screw.....
6465	398	" " " Washer.....
16194	3664	" " Lifting Bracket with 175J and two 457K.....
16195	—	Presser Bar Lifting Bracket 16194 with 16196 and two 335J.....
175J	402	Presser Bar Lifting Bracket Adjusting Screw.....
6469	397	Presser Bar Lifting Bracket Guide.....
175J	402	" " " " " Screw
457K	402	" " " " Set Screw...
16196	3664	" " " " Wearing Plate.....
335J	3657	Presser Bar Lifting Bracket Wearing Plate Screw.....
290E	402	Presser Bar Screw Bushing.....
5459	410	" " Spring (light) .047 wire.....
6466	393	" " " (medium) .055 wire...
6467	410	" " " (heavy) .063 wire.....
2070	398	" " " Washer.....
6069	396	" Foot.....
190D	402	" " Screw.....
262J	401	Pressure Regulating Thumb Screw.....
1868	399	Roller, 1/8 in. diam., coarse, with 652D and 1528J, for 6070.....
1841	3659	Roller, 1/8 in. diam., fine, with 652D and 1528J, for 6071.....

NO.	PLATE	NAME
6072	399	Roller Arm.....
440F	402	" " Adjusting Screw.....
1547J	402	" " " " Nut.....
6073	399	" " Bracket.....
2205	399	" " Lock Spring.....
176D	402	" " " " Screw.....
1549J	402	" " " " Nut.....
316F	402	" " Screw Centre.....
1547J	402	" " " " Nut.....
6070	399	Roller Presser complete, 1/8 in. coarse roller, Nos. 176D, 440F, 1549J, 1868, 2205, 6072, 6073, two 316F and three 1547J.....
6071	—	Roller Presser complete, 1/8 in. fine roller, No. 176D, 440F, 1549J, 1841, 2205, 6072, 6073, two 316F and three 1547J.....
190D	402	Roller Presser Screw.....
652D	3658	" Screw.....
1528J	412	" " Nut.....
2073	217	Shuttle Bobbin.....
2211	217	" " Retaining Spring.....
2212	217	" " " " Rivet..
*6058	—	Shuttle Body with 398E, 2082, 2084, 2211 and two 2212.....
*2075	—	Shuttle Cover.....
*44001	—	" " 2075 with 112E, 466c, 2078, 2080, 2086 and 2090.....
2076	217	Shuttle Cover Hinge Pin.....
2078	217	" Delivery Eye Thread Guard.....
2080	217	" " " " Rivet
2082	217	" Main Spring.....
398E	217	" " Screw.....
2084	217	" " Steady Pin.....
466c	217	" Tension Regulating Screw.....
2086	217	" " Spring.....
2090	217	" " Plate.....
112E	217	" " " " Screw.....
6028	217	Shuttle (high point) complete, Nos. 2073, 2076, 6058 and 44001.....
6470	399	Shuttle Driver and Feed Lifting Cam....
2049	400	" " " " " Pin
16171	3656	" Race (steel).....
16163	3656	" " Cap.....
16164	—	Shuttle Race Cap complete, Nos. 6472, 16163 and two 725J.....

NO.	PLATE	NAME
6472	398	Shuttle Race Cap Latch.....
725J	412	" " " " Screw.....
102D	402	" " " " Screw.....
50037D	3664	" " " " Screw.....
2102	398	Tension Disc.....
1560c	401	" Regulating Thumb Nut.....
600c	3654	" Screw Stud.....
16202	—	" " " 600c with 1560c.....
175D	402	" " " Set Screw.....
2103	400	" Spring.....
16022	398	" Thread Guard.....
219D	402	" " " Screw.....
16204	—	Tension complete, Nos. 2103, 16202 and two 2102.....
2106	400	Thread Eyelet (front of arm).....
*56831	—	" Take-up Cam (steel).....
3280	393	" " " 56831 with 446c...
3012	400	" " " Pin.....
446c	402	" " " Set Screw.....
*6474	393	" " Lever with 1819.....
16180	—	" " " 6474 with 76F....
76F	402	" " " Hinge Screw.....
1819	401	" " " Roller and Stud..
6768	400	" " Spring.....
6477	398	" " " Regulator Plate
233D	402	" " " " " "
		Adjusting Screw.....
16165	3678	Throat Plate for 16162.....
399D	402	" " " Screw.....
16077	3650	Drip Pan.....

**LIST OF PARTS COMPLETE  
FOR**

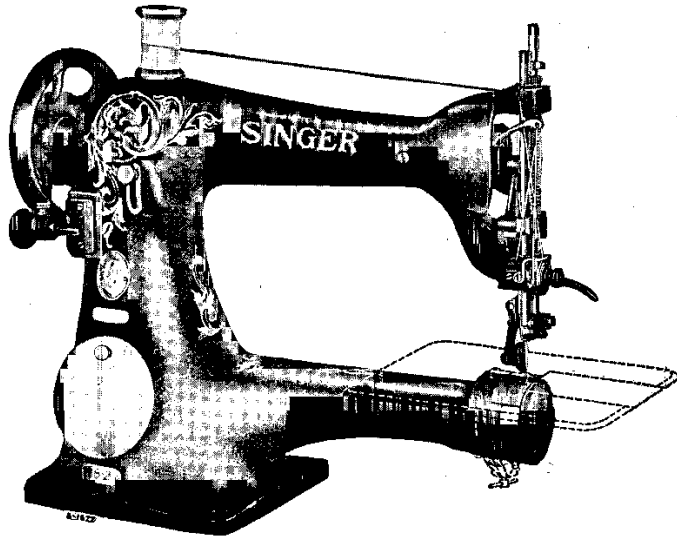

**MACHINE No. 18-2**

**FOR SHOE WORK. HAS DROP FEED AT LEFT  
OF NEEDLE, ROLLER PRESSER**

NO.	PLATE	NAME
*16170	—	Arm and Cylinder.....
3004	391	" Shaft.....
3005	393	" " Bushing.....
448c	402	" " " Set Screw.....
144d	402	" " " Screw.....
4288	411	" Side Cover (back).....
286d	401	" " " Thumb Screw....
16102	3652	" " " (front).....
164d	412	" " " " Screw.....
12403	400	" Spool Pin and Thread Eyelet.....
8879	412	" " " Washer (cloth).....

**PARTS FOR MACHINE No. 18-2**

NO.	PLATE	NAME
4370	391	Balance Wheel, heavy rim, 2¾ in. pulley, with two 448c.....
4388	3655	Balance Wheel (power) light rim, 2¾ in. pulley, with two 448c.....
2862	391	Balance Wheel (stand) heavy rim, 3 in. pulley, for 3022.....
448c	402	Balance Wheel Set Screw.....
256j	392	Clamp Stop Motion Clamp Screw.....
248A	402	" " " " Stop Screw..
2020	392	" " " " Washer.....
*3023	—	" " " " Flanged Bushing....
4933	392	" " " " " 3023 with two 462c.....
2022	400	Clamp Stop Motion Flanged Bushing Pin
462c	412	" " " " " Set Screw.....
3022	—	Clamp Stop Motion complete, Nos. 248A, 256j, 2020 and 4933.....
16032	390	Cloth Plate.....
16143	3655	" " Bracket with 1107c.....
1107c	412	" " " Set Screw.....
389F	401	" " Screw.....
16034	390	" " Slide.....
3286	397	" " " Spring.....
725j	412	" " " " Screw.....
6479	390	Cloth Plate complete, Nos. 3286, 16032, 16034 and two 725j.....
6478	—	Cloth Plate with Bracket complete, Nos. 6479, 16143 and two 389F.....
4292	391	Crank Connecting Rod with 4349 and two 145E.....
*4349	—	Crank Connecting Rod Cap.....
145E	3669	" " " " Screw.....
375c	402	" " " " Hinge Screw....
1518E	401	" " " " " Nut.
16045	412	Cylinder Oil Tube for oiling 6462.....
16036	411	" Side Cover.....
286d	401	" " " Thumb Screw.....
3032	393	Feed Cam with 446c.....
446c	402	" " Set Screw.....
3033	397	" Connecting Link.....
375c	402	" " " Hinge Screw.....
1518E	401	" " " " " Nut.
16094	3676	" Dog.....
16107	3676	" " 10 teeth (16 teeth to the inch)

NOTE: No. 16107 is sent with this machine unless another Feed Dog is specified on order



NO.	PLATE	NAME
16172	3676	Feed Dog, 13 teeth (22 teeth to the inch)
16078	3675	" "
16108	3676	" "
6458	397	" " Carrier.....
231c	412	" " Screw.....
3037	391	" Forked Connection.....
375c	402	" " " Hinge Screw....
1518E	401	" " " " " Nut
6459	393	" Regulator.....
58E	402	" " Hinge Screw.....
818D	401	" " Thumb Screw.....
6460	391	" Rock Shaft.....
6018	392	" " " Crank with 297F.....
156F	402	" " " " Position Screw...
207F	402	" " " " Set Screw.....
4301	393	Needle Bar.....
*3045	3669	" " Connecting Link.....
16220	—	" " " " 3045 with 377c, 1518E and 6487.....
377c	402	Needle Bar Connecting Link Hinge Screw
1518E	401	" " " " " " "
		Nut.....
6487	397	Needle Bar Connecting Stud with 155c...
155c	402	" " " " Set Screw...
290E	402	" " Screw Bushing.....
4302	400	" " Thread Guide.....
233D	402	" " " " Screw.....
4303	400	" Clamp with 808F.....
808F	402	" " Screw.....
*6461	392	Oscillating Rock Shaft (steel) with 4784
16176	—	Oscillating Rock Shaft complete, Nos. 6461 and 16212.....
6489	392	Oscillating Rock Shaft Hinge Pin.....
16212	—	" " " " " 6489 with 1513J.....
1513J	401	Oscillating Rock Shaft Hinge Pin Nut...
4784	412	" " " Oil Pad.....
6462	391	" Shaft.....
*6056	—	" " Crank with 460c and 1813.....
6024	397	Oscillating Shaft Crank with 1813 and two 462c.....
2049	400	Oscillating Shaft Crank Pin.....
1813	401	" " " Roller and Stud.
462c	412	" " " Set Screw for 6024
460c	402	" " " " " " 6056

NO.	PLATE	NAME
3054	393	Presser Bar.....
6464	393	" " Lifter.....
77F	412	" " " Screw.....
6465	398	" " " Washer.....
16194	3664	" " Lifting Bracket with 175J and two 457K.....
16195	—	Presser Bar Lifting Bracket 16194 with 16196 and two 335J.....
175J	402	Presser Bar Lifting Bracket Adjusting Screw.....
6469	397	Presser Bar Lifting Bracket Guide.....
175J	402	" " " " " Screw
457K	402	" " " " Set Screw...
16196	3664	" " " " Wearing Plate.....
335J	3657	Presser Bar Lifting Bracket Wearing Plate Screw.....
290E	402	Presser Bar Screw Bushing.....
5459	410	" " Spring (light) .047 wire.....
6466	393	" " " (medium) .055 wire...
6467	410	" " " (heavy) .063 wire.....
2070	398	" " " Washer.....
2180	396	" Foot.....
190D	402	" " Screw.....
262J	401	Pressure Regulating Thumb Screw.....
1868	399	Roller, $\frac{3}{8}$ in. diam., coarse, with 652D and 1528J, for 2196.....
1841	3659	Roller, $\frac{3}{8}$ in. diam., fine, with 652D and 1528J, for 2197.....
1839	3659	Roller, $1\frac{1}{4}$ in. diam., coarse, with 386D and 1528J, for 16099.....
1869	3659	Roller, $1\frac{1}{4}$ in. diam., fine, with 386D and 1528J, for 16100.....
1897	3666	Roller, $1\frac{1}{4}$ in. diam., coarse, with 386D and 1528J, for 16225.....
1898	—	Roller, $1\frac{1}{4}$ in. diam., fine, with 386D and 1528J, for 16226.....
1923	3666	Roller, $1\frac{1}{4}$ in. diam., coarse, with 652D and 1528J, for 16228.....
51832	—	Roller, $1\frac{1}{4}$ in. diam., coarse, for 51833...
51833	3665	Roller, (ball bearing) $1\frac{1}{4}$ in. coarse roller, $\frac{3}{32}$ in. face, Nos. 1528J, 1766c, 50553c, 51832 and twenty-four 16232, for 16233
51841	—	Roller, $1\frac{1}{4}$ in. diam., coarse, for 51842...
51842	3665	Roller, (ball bearing) $1\frac{1}{4}$ in. coarse roller, $\frac{3}{32}$ in. face, Nos. 1628J, 1766c, 50553c, 51841 and twenty-four 16232, for 16236.

NO.	PLATE	NAME
2203	399	Roller Arm for 2196 and 2197.....
16098	3653	" " " 16099, 16100, 16225, 16226 and 16228.....
16230	3665	Roller Arm for 16233 and 16236.....
440F	402	" " Adjusting Screw.....
1547J	402	" " " " Nut.....
2206	399	" " Bracket for 2196 and 2197....
4282	3659	" " " " 16099, 16100, 16225, 16226, 16228, 16233 and 16236
2205	399	Roller Arm Lock Spring.....
176D	402	" " " " Screw.....
1549J	402	" " " " " Nut.....
316F	402	" " Screw Centre.....
1547J	402	" " " " " Nut.....
16232	3665	" Ball, size $\frac{3}{8}$ in.....
1766c	3665	" Retaining Nut.....
2196	399	Roller Presser complete, $\frac{1}{8}$ in. coarse roller, Nos. 176D, 440F, 1549J, 1868, 2203, 2205, 2206, two 316F and three 1547J.....
2197	—	Roller Presser complete, $\frac{1}{8}$ in. fine roller, Nos. 176D, 440F, 1549J, 1841, 2203, 2205, 2206, two 316F and three 1547J
16099	3658	Roller Presser complete, $\frac{1}{4}$ in. coarse roller, Nos. 176D, 440F, 1549J, 1839, 2205, 4282, 16098, two 316F and three 1547J.....
16100	—	Roller Presser complete, $\frac{1}{4}$ in. fine roller, Nos. 176D, 440F, 1549J, 1869, 2205, 4282, 16098, two 316F and three 1547J
16225	3666	Roller Presser complete, $\frac{1}{4}$ in. coarse roller, Nos. 176D, 440F, 1549J, 1897, 2205, 4282, 16098, two 316F and three 1547J.....
16226	—	Roller Presser complete, $\frac{1}{4}$ in. fine roller, Nos. 176D, 440F, 1549J, 1898, 2205, 4282, 16098, two 316F and three 1547J
16228	3666	Roller Presser complete, $\frac{1}{4}$ in. coarse roller, Nos. 176D, 440F, 1549J, 1923, 2205, 4282, 16098, two 316F and three 1547J.....
16233	3665	Roller Presser (ball bearing) complete, $\frac{1}{4}$ in. coarse roller, $\frac{1}{8}$ in. face, Nos. 176D, 440F, 1549J, 2205, 4282, 16230, 51833, two 316F and three 1547J.....

NO.	PLATE	NAME
16236	3665	Roller Presser (ball bearing) complete, $\frac{1}{4}$ in. coarse roller, $\frac{1}{8}$ in. face, Nos. 176D, 440F, 1549J, 2205, 4282, 16230, 51842, two 316F and three 1547J.....
190D	402	Roller Presser Screw.....
652D	3658	" Screw for 1841, 1868 and 1923....
386D	3659	" " " 1839, 1869, 1897 and 1898.....
50553c	3665	Roller Screw for 51833 and 51842.....
1528J	412	" " Nut.....
2073	217	Shuttle Bobbin.....
2211	217	" " Retaining Spring.....
2212	217	" " " " Rivet....
*6058	—	Shuttle Body with 398E, 2082, 2084, 2211 and two 2212.....
*2075	—	Shuttle Cover.....
*44001	—	" " 2075 with 112E, 466c, 2078, 2080, 2086 and 2090.....
2076	217	Shuttle Cover Hinge Pin.....
2078	217	" Delivery Eye Thread Guard....
2080	217	" " " " Rivet
2082	217	" Main Spring.....
398E	217	" " " Screw.....
2084	217	" " " Steady Pin.....
466c	217	" Tension Regulating Screw.....
2086	217	" " Spring.....
2090	217	" " " Plate.....
112E	217	" " " " Screw.....
6028	217	Shuttle (high point) complete, Nos. 2073, 2076, 6058 and 44001.....
6470	399	Shuttle Driver and Feed Lifting Cam....
2049	400	" " " " " Pin
16171	3656	" Race (steel).....
16218	—	" " " 16171 with 6471 and two 102D.....
6800	403	Shuttle Race Cap.....
6471	—	Shuttle Race Cap complete, Nos. 6472, 6800 and two 725J.....
6472	398	Shuttle Race Cap Latch.....
725J	412	" " " " Screw.....
102D	402	" " " " Screw.....
50037D	3664	" " Screw.....
2102	398	Tension Disc.....
1560c	401	" Regulating Thumb Nut.....
600c	3654	" Screw Stud.....
16202	—	" " " 600c with 1560c....
175D	402	" " " Set Screw.....

NO.	PLATE	NAME
2103	400	Tension Spring.....
16022	398	" Thread Guard.....
219D	402	" " " Screw.....
16204	—	Tension complete, Nos. 2103, 16202 and two 2102.....
2106	400	Thread Eyelet (front of arm).....
*56831	—	" Take-up Cam (steel).....
3280	393	" " " 56831 with 446c...
3012	400	" " " Pin.....
446C	402	" " " Set Screw.....
*6474	393	" " Lever with 1819.....
16180	—	" " " 6474 with 76F....
76F	402	" " " Hinge Screw.....
1819	401	" " " Roller and Stud..
6768	400	" " Spring.....
6477	398	" " " Regulator Plate
233D	402	" " " " "
		Adjusting Screw.....
16095	3676	Throat Plate (fluted) needle hole drilled for No. 1 needle to locate close to the side nearest the feedway, for 16094, 16107 and 16172.....
NOTE: No. 16095 is sent with this machine unless another Throat Plate is specified on order		
16096	3675	Throat Plate (not fluted) needle hole drilled for No. 2 needle to locate close to the side nearest the feedway, for 16078.....
16131	3675	Throat Plate (fluted) needle hole drilled for No. 2 needle to locate close to the side nearest the feedway, for 16078...
6492	396	Throat Plate (fluted) large needle hole, for 16078.....
16097	—	Throat Plate (fluted) small needle hole, for 16078.....
16109	3676	Throat Plate (fluted) large needle hole, for 16108.....
16110	—	Throat Plate (fluted) small needle hole, for 16108.....
399D	402	Throat Plate Screw.....
16077	3650	Drip Pan.....

## LIST OF PARTS COMPLETE FOR MACHINE No. 18-3

### WHEEL FEED AT LEFT OF NEEDLE, ROLLER PRESSER. FOR LEATHER

NO.	PLATE	NAME
*16118	—	Arm and Cylinder.....
3004	391	" Shaft.....
3005	393	" " Bushing.....
448C	402	" " " Set Screw.....
144D	402	" " Screw.....
4288	411	" Side Cover (back).....
286D	401	" " " Thumb Screw....
16102	3652	" " " (front).....
164D	412	" " " " Screw.....
12403	400	" Spool Pin and Thread Eyelet.....
8879	412	" " " Washer (cloth).....
4370	391	Balance Wheel, heavy rim, 2 $\frac{3}{4}$ in. pulley, with two 448c.....
4388	3655	Balance Wheel (power) light rim, 2 $\frac{3}{4}$ in. pulley, with two 448c.....
2862	391	Balance Wheel (stand) heavy rim, 3 in. pulley, for 3022.....
448C	402	Balance Wheel Set Screw.....
256J	392	Clamp Stop Motion Clamp Screw.....
248A	402	" " " " Stop Screw..
2020	392	" " " " Washer.....
*3023	—	" " " Flanged Bushing....
4933	392	" " " " " 3023 with two 462c.....
2022	400	Clamp Stop Motion Flanged Bushing Pin
462C	412	" " " " " Set Screw.....
3022	—	Clamp Stop Motion complete, Nos. 248A, 256J, 2020 and 4933.....
6786	390	Cloth Plate.....
6083	390	" " Bracket with two 345c.....
345C	401	" " " Set Screw.....
389F	401	" " Screw.....
6496	390	" " Slide.....
3286	397	" " " Spring.....
725J	412	" " " " Screw.....

NO.	PLATE	NAME
6495	390	Cloth Plate complete, Nos. 3286, 6496, 6786 and two 725j.....
6494	—	Cloth Plate with Bracket complete, Nos. 6083, 6495 and two 389f.....
4292	391	Crank Connecting Rod with 4349 and two 145e.....
*4349	—	Crank Connecting Rod Cap.....
145E	3669	" " " " Screw.....
375c	402	" " " " Hinge Screw.....
1518E	401	" " " " " Nut
16045	412	Cylinder Oil Tube for oiling 16055.....
16036	411	" Side Cover.....
286D	401	" " " Thumb Screw.....
3033	397	Feed Connecting Link.....
375c	402	" " " Hinge Screw.....
1518E	401	" " " " " Nut.
3074	393	" Eccentric with 446c.....
446c	402	" " Set Screw.....
3037	391	" Forked Connection.....
375c	402	" " " Hinge Screw.....
1518E	401	" " " " " Nut
6459	393	" Regulator.....
58E	402	" " Hinge Screw.....
818D	401	" " Thumb Screw.....
6488	391	" Rock Shaft.....
6018	392	" " " Crank with 207F.....
156F	402	" " " " Position Screw..
207F	402	" " " " Set Screw.....
6497	403	" Wheel.....
6498	393	" " Driver.....
16168	400	" " " Spring.....
207F	402	" " " Screw.....
6089	400	" " Friction Spring.....
207F	402	" " " Screw.....
4301	393	Needle Bar.....
*3045	3669	" " Connecting Link.....
16220	—	" " " " 3045 with 377c, 1518E and 6487.....
377c	402	Needle Bar Connecting Link Hinge Screw
1518E	401	" " " " " " Nut.....
6487	397	Needle Bar Connecting Stud with 155c..
155c	402	" " " " Set Screw..
290E	402	" " Screw Bushing.....
4302	400	" " Thread Guide.....
233D	402	" " " " Screw.....
4303	400	" Clamp with 808f.....

NO.	PLATE	NAME
808F	402	Needle Clamp Screw.....
*6461	392	Oscillating Rock Shaft (steel) with 4784
16176	—	Oscillating Rock Shaft complete, Nos. 6461 and 16212.....
6489	392	Oscillating Rock Shaft Hinge Pin.....
16212	—	" " " " " 6489 with 1513j.....
1513j	401	Oscillating Rock Shaft Hinge Pin Nut...
4784	412	" " " Oil Pad.....
16055	391	" Shaft.....
*6056	—	" " Crank with 460c and 1813.....
6024	397	Oscillating Shaft Crank with 1813 and two 462c.....
2049	400	Oscillating Shaft Crank Pin.....
1813	401	" " " Roller and Stud.
462c	412	" " " Set Screw for 6024
460c	402	" " " " " " 6056
3054	393	Presser Bar.....
6464	393	" " Lifter.....
77j	412	" " " Screw.....
6465	398	" " " Washer.....
16194	3664	" " Lifting Bracket with 175j and two 457k.....
16195	—	Presser Bar Lifting Bracket 16194 with 16196 and two 335j.....
175j	402	Presser Bar Lifting Bracket Adjusting Screw.....
6469	397	Presser Bar Lifting Bracket Guide.....
175j	402	" " " " " Screw
457k	402	" " " " Set Screw...
16196	3664	" " " " Wearing Plate.....
335j	3657	Presser Bar Lifting Bracket Wearing Plate Screw.....
290E	402	Presser Bar Screw Bushing.....
5459	410	" " Spring (light) .047 wire....
6466	393	" " " (medium) .055 wire...
6467	410	" " " (heavy) .063 wire....
2070	398	" " " Washer.....
2180	396	" Foot.....
190D	402	" " Screw.....
262j	401	Pressure Regulating Thumb Screw.....
1868	399	Roller, 7/8 in. diam., coarse, with 652D and 1528j, for 2196.....
1841	3659	Roller, 7/8 in. diam., fine, with 652D and 1528j, for 2197.....

NO.	PLATE	NAME
1839	3659	Roller, 1¼ in. diam., coarse, with 386D and 1528J, for 16099.....
1869	3659	Roller, 1¼ in. diam., fine, with 386D and 1528J, for 16100.....
1897	3666	Roller, 1¼ in. diam., coarse, with 386D and 1528J, for 16225.....
1898	—	Roller, 1¼ in. diam., fine, with 386D and 1528J, for 16226.....
1923	3666	Roller, 1¼ in. diam., coarse, with 652D and 1528J, for 16228.....
51832	—	Roller, 1¼ in. diam., coarse, for 51833...
51833	3665	Roller, (ball bearing) 1¼ in. coarse roller, ¾ in. face, Nos. 1528J, 1766C, 50553C, 51832 and twenty-four 16232, for 16233
51841	—	Roller, 1¼ in. diam., coarse, for 51842...
51842	3665	Roller, (ball bearing) 1¼ in. coarse roller, ¾ in. face, Nos. 1528J, 1766C, 50553C, 51841 and twenty-four 16232, for 16236
2203	399	Roller Arm for 2196 and 2197.....
16098	3653	" " " " 16099, 16100, 16225, 16226 and 16228.....
16230	3665	Roller Arm for 16233 and 16236.....
440F	402	" " Adjusting Screw.....
1547J	402	" " " " Nut.....
2206	399	" " Bracket for 2196 and 2197...
4282	3659	" " " " 16099, 16100, 16225, 16226, 16228, 16233 and 16236
2205	399	Roller Arm Lock Spring.....
176D	402	" " " " Screw.....
1549J	402	" " " " Nut.....
316F	402	" " Screw Centre.....
1547J	402	" " " " Nut.....
16232	3665	" Ball, size ¾ in.....
1766C	3665	" Retaining Nut.....
2196	399	Roller Presser complete, ⅞ in. coarse roller, Nos. 176D, 440F, 1549J, 1868, 2203, 2205, 2206, two 316F and three 1547J.....
2197	—	Roller Presser complete, ⅞ in. fine roller, Nos. 176D, 440F, 1549J, 1841, 2203, 2205, 2206, two 316F and three 1547J
16099	3658	Roller Presser complete, 1¼ in. coarse roller, Nos. 176D, 440F, 1549J, 1839, 2205, 4282, 16098, two 316F and three 1547J.....

NO.	PLATE	NAME
16100	—	Roller Presser complete, 1¼ in. fine roller, Nos. 176D, 440F, 1549J, 1869, 2205, 4282, 16098, two 316F and three 1547J
16225	3666	Roller Presser complete, 1¼ in. coarse roller, Nos. 176D, 440F, 1549J, 1897, 2205, 4282, 16098, two 316F and three 1547J.....
16226	—	Roller Presser complete, 1¼ in. fine roller, Nos. 176D, 440F, 1549J, 1898, 2205, 4282, 16098, two 316F and three 1547J
16228	3666	Roller Presser complete, 1¼ in. coarse roller, Nos. 176D, 440F, 1549J, 1923, 2205, 4282, 16098, two 316F and three 1547J.....
16233	3665	Roller Presser (ball bearing) complete, 1¼ in. coarse roller, ¾ in. face, Nos. 176D, 440F, 1549J, 2205, 4282, 16230, 51833, two 316F and three 1547J.....
16236	3665	Roller Presser (ball bearing) complete, 1¼ in. coarse roller, ¾ in. face, Nos. 176D, 440F, 1549J, 2205, 4282, 16230, 51842, two 316F and three 1547J.....
190D	402	Roller Presser Screw.....
652D	3658	" Screw for 1841, 1868 and 1923....
386D	3659	" " " 1839, 1869, 1897 and 1898.....
50553C	3665	Roller Screw for 51833 and 51842.....
1528J	412	" " Nut.....
2073	217	Shuttle Bobbin.....
2211	217	" " Retaining Spring.....
2212	217	" " " " Rivet...
*6058	—	Shuttle Body with 398E, 2082, 2084, 2211 and two 2212.....
*2075	—	Shuttle Cover.....
*44001	—	" " 2075 with 112E, 466C, 2078, 2080, 2086 and 2090.....
2076	217	Shuttle Cover Hinge Pin.....
2078	217	" Delivery Eye Thread Guard.....
2080	217	" " " " Rivet
2082	217	" Main Spring.....
398E	217	" " " Screw.....
2084	217	" " " Steady Pin.....
466C	217	" Tension Regulating Screw.....
2086	217	" Spring.....
2090	217	" " " Plate.....
112E	217	" " " " Screw.....

NO.	PLATE	NAME
6028	217	Shuttle (high point) complete, Nos. 2073, 2076, 6058 and 44001.....
6499	399	Shuttle Driver.....
2049	400	" " Pin.....
16046	—	" " Race Ring.....
6472	398	" " " " Latch.....
725j	412	" " " " Screw.....
6500	403	Shuttle Race Ring complete, Nos. 6472, 16046 and two 725j.....
50008j	412	Shuttle Race Ring Screw.....
2102	398	Tension Disc.....
1560c	401	" " Regulating Thumb Nut.....
600c	3654	" " Screw Stud.....
16202	—	" " " " 600c with 1560c....
175b	402	" " " " Set Screw.....
2103	400	" " Spring.....
16022	398	" " Thread Guard.....
219b	402	" " " " Screw.....
16204	—	Tension complete, Nos. 2103, 16202 and two 2102.....
2106	400	Thread Eyelet (front of arm).....
*56831	—	" " Take-up Cam (steel).....
3280	393	" " " " 56831 with 446c....
3012	400	" " " " Pin.....
446c	402	" " " " Set Screw.....
*6474	393	" " " " Lever with 1819.....
16180	—	" " " " 6474 with 76f....
76f	402	" " " " Hinge Screw.....
1819	401	" " " " Roller and Stud..
6768	400	" " " " Spring.....
6477	398	" " " " Regulator Plate.....
233d	402	" " " " " " " ".....
		Adjusting Screw.....
16047	—	Throat Ring.....
6501	403	" " " " 16047 with 665j and 6502..
6502	408	" " " " Needle Plate.....
665j	408	" " " " " " Screw.....
399d	402	" " " " " " Screw.....
6769	—	Throat Ring complete, Nos. 6500, 6501 and two 50008j.....
16077	3650	Drip Pan.....

## LIST OF PARTS COMPLETE

FOR

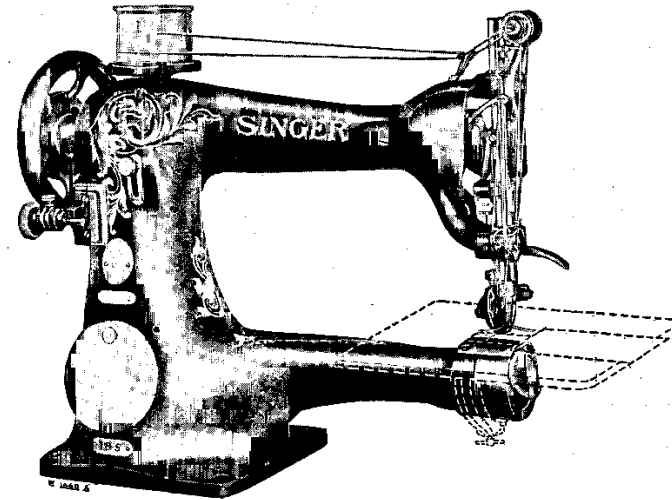

## MACHINE No. 18-5

FOR SHOE VAMPING AND OTHER WORK IN LEATHER. TWO NEEDLES, LONG BEAK SHUTTLES,  $\frac{1}{16}$  INCH TO  $\frac{1}{4}$  INCH GAUGES, DROP FEED, ROLLER PRESSER.

NO.	PLATE	NAME
*16119	—	Arm and Cylinder.....
3004	391	" " Shaft.....
3005	393	" " " " Bushing.....
448c	402	" " " " Set Screw.....
144d	402	" " " " Screw.....
4288	411	" " Side Cover (back).....
286d	401	" " " " " " Thumb Screw....
16102	3652	" " " " (front).....
164d	412	" " " " " " Screw.....
2415	393	" " Spool Bracket.....
15063	393	" " " " 2415 with two 12403
145d	412	" " " " " " Screw.....

NO.	PLATE	NAME
12403	400	Arm Spool Bracket Spool Pin and Thread Eyelet.....
11241	392	Arm Spool Bracket Spool Pin Washer (cloth).....
4370	391	Balance Wheel, heavy rim, 2 $\frac{3}{4}$ in. pulley, with two 448c.....
4388	3655	Balance Wheel (power) light rim, 2 $\frac{3}{4}$ in. pulley, with two 448c.....
2862	391	Balance Wheel (stand) heavy rim, 3 in. pulley, for 3022.....
448c	402	Balance Wheel Set Screw.....
256J	392	Clamp Stop Motion Clamp Screw.....
248A	402	" " " " Stop Screw..
2020	392	" " " " Washer.....
*3023	—	" " " " Flanged Bushing....
4933	392	" " " " " " 3023 with two 462c.....
2022	400	Clamp Stop Motion Flanged Bushing Pin
462c	412	" " " " " " Set Screw.....
3022	—	Clamp Stop Motion complete, Nos. 248A, 256J, 2020 and 4933.....
6716	394	Cloth Plate.....
6719	394	" " Bracket with 345c.....
345c	401	" " " " Set Screw.....
389F	401	" " " " Screw.....
6718	394	" " Slide.....
3286	397	" " " " Spring.....
725J	412	" " " " " " Screw.....
6717	394	Cloth Plate complete, Nos. 3286, 6716, 6718 and two 725J.....
6702	—	Cloth Plate with Bracket complete, Nos. 6717, 6719 and two 389F.....
4292	391	Crank Connecting Rod with 4349 and two 145E.....
*4349	—	Crank Connecting Rod Cap.....
145E	3669	" " " " " " Screw.....
375c	402	" " " " " " Hinge Screw.....
1518E	401	" " " " " " Nut
16045	412	Cylinder Oil Tube for oiling 16113.....
16036	411	" Side Cover.....
286D	401	" " " " " " Thumb Screw.....
3032	393	Feed Cam with 446c.....
446c	402	" " " " " " Set Screw.....
3033	397	" Connecting Link.....
375c	402	" " " " " " Hinge Screw.....
1518E	401	" " " " " " Nut.

NO.	PLATE	NAME
16018	396	Feed Dog, for $\frac{1}{2}$ in. to $\frac{3}{4}$ in. gauges.....
6677	396	" " " " $\frac{1}{2}$ in. to $\frac{1}{4}$ in. gauges.....
6458	397	" " Carrier.....
231c	412	" " Screw.....
3037	391	" Forked Connection.....
375c	402	" " " " " " Hinge Screw....
1518E	401	" " " " " " Nut
6459	393	" Regulator.....
58E	402	" " " " " " Hinge Screw.....
818D	401	" " " " " " Thumb Screw.....
6678	391	" Rock Shaft.....
6018	392	" " " " Crank with 207F.....
156F	402	" " " " " " Position Screw..
207F	402	" " " " " " Set Screw.....
4344	393	Needle Bar.....
16178	—	" " " " " " 4344 with 2273 and 4345.....
16182	—	" " " " " " " " 6524.....
*3045	3669	" " Connecting Link.....
16220	—	" " " " " " 3045 with 377c, 1518E and 6487.....
377c	402	Needle Bar Connecting Link Hinge Screw
1518E	401	" " " " " " " "
		Nut.....
6487	397	Needle Bar Connecting Stud with 155c..
155c	402	" " " " " " Set Screw..
3214	3654	" " Guide with 400c and 453c...
400c	3654	" " " " Adjusting Screw.....
453c	3654	" " " " Set Screw.....
290E	402	" " Screw Bushing.....
4345	400	" Clamp with two 336F, for $\frac{1}{2}$ in. to $\frac{5}{8}$ in. gauges.....
6524	400	Needle Clamp with two 50014F, for $\frac{3}{32}$ in. to $\frac{1}{4}$ in. gauges.....
2273	400	Needle Clamp Pin.....
336F	402	" Set Screw for 4345.....
50014F	3654	" " " " " " 6524.....
*16111	3652	Oscillating Rock Shaft.....
16112	—	Oscillating Rock Shaft complete, Nos. 4784, 16111 and 16212.....
6489	392	Oscillating Rock Shaft Hinge Pin....
16212	—	" " " " " " " " 6489 with 1513J.....
1513J	401	Oscillating Rock Shaft Hinge Pin Nut...
4784	412	" " " " " " Oil Pad.....
16113	3652	" Shaft.....
16115	—	" " Crank for 16116.....
*16192	—	" " " " " " 16193.....

NO.	PLATE	NAME
16116	3654	Oscillating Shaft Crank complete, Nos. 1518E, 16115, 19390 and two 462c.....
*16193	—	Oscillating Shaft Crank complete, Nos. 462c, 1518E, 16192 and 19390.....
2049	400	Oscillating Shaft Crank Pin.....
462c	412	" " " Set Screw.....
19389	3654	" " " Slide Block.....
226d	3669	" " " " " Cap Screw.....
12424	3654	Oscillating Shaft Crank Slide Block Cap Screw Washer.....
969c	3654	Oscillating Shaft Crank Slide Block Screw Stud.....
1518E	3654	Oscillating Shaft Crank Slide Block Screw Stud Nut.....
19390	3654	Oscillating Shaft Crank Slide Block complete, Nos. 226d, 969c, 12424 and 19389
16145	3656	Presser Bar (hollow).....
6464	393	" " Lifter.....
77F	412	" " " Screw.....
6465	398	" " " Washer.....
16197	3664	" " Lifting Bracket with 175J and two 457k.....
16198	—	Presser Bar Lifting Bracket 16197 with 16196 and two 335J.....
175J	402	Presser Bar Lifting Bracket Adjusting Screw.....
6469	397	Presser Bar Lifting Bracket Guide.....
175J	402	" " " " " Screw.....
457k	402	" " " " " Set Screw...
16196	3664	" " " " " Wearing Plate.....
335J	3657	Presser Bar Lifting Bracket Wearing Plate Screw.....
921E	3657	Presser Bar Screw Bushing.....
16156	3656	" " Spring (light) .055 wire.....
16147	3656	" " " (heavy) .063 wire.....
11170	3657	" " " Washer.....
16148	3657	" " Stop Collar with 1019c.....
1019c	3657	" " " " " Set Screw.....
688J	3657	Pressure Regulating Thumb Screw.....
1958	409	Roller, 1½ in. diam., with 1261d and 1528J, for 16071 and 16082.....
1875	404	Roller, 1½ in. diam., with 634d and 1528J, for 16014 and 16017.....
51834	—	Roller, 1½ in. diam., coarse, for 51835...

NO.	PLATE	NAME
51855	—	Roller, 1½ in. diam., ⅜ in. face, coarse, for 51856.....
51835	3666	Roller (ball bearing) 1½ in. coarse roller, Nos. 1528J, 1766c, 50553c, 51834 and twenty-four 16232, for 16234 and 16235
51856	3669	Roller, 1½ in. diam., ⅜ in. face, coarse (ball bearing) for 16237, Nos. 1528J, 1766c, 50553c, 51855 and twenty-four 16232.....
16015	409	Roller Arm for 16017 and 16071.....
6535	404	" " " 16014 and 16082.....
16231	3665	" " " 16234, 16235 and 16237..
440F	402	" " Adjusting Screw.....
1547J	402	" " " " " Nut.....
19200	404	" " Bracket for 16017, 16071 and 16235.....
4785	3659	Roller Arm Bracket for 16014, 16082 and 16234.....
7556	404	Roller Arm Lock Spring.....
176D	402	" " " " " Screw.....
1549J	402	" " " " " Nut.....
316F	402	" " " " " Screw Centre.....
1547J	402	" " " " " Nut.....
16232	3665	" Ball, size ⅜ in.....
1766c	3665	" " Retaining Nut.....
16080	409	" Needle Guard (flat) for 16082, 16234 and 16237.....
16010	404	Roller Needle Guard (flat) for 16014....
207F	402	" " " " " Screw.....
16016	404	" " " (round) for 16017, 16071 and 16235.....
16013	404	Roller Needle Guard (round) for 16014
16081	409	" " " " " " 16082, 16234 and 16237.....
16138	3659	Roller Needle Guard (round) with 242d and 16139, for 16014.....
16139	3659	Roller Needle Guard (round) Edge Guide for 16138.....
242D	3659	Roller Needle Guard (round) Edge Guide Screw.....
171F	402	Roller Needle Guard (round) Set Screw..
16082	409	Roller Presser complete, 1½ in. roller, ⅜ in. face, for ⅜ in. to ⅜ in. gauges, Nos. 171F, 176D, 207F, 440F, 1549J, 1958, 4785, 6535, 7556, 16080, 16081, two 316F and three 1547J.....



NO.	PLATE	NAME
16014	404	Roller Presser complete, 1½ in. roller, ⅜ in. face, for ⅜ in. to ⅛ in. gauges, Nos. 171F, 176D, 207F, 440F, 1549J, 1875, 4785, 6535, 7556, 16010, 16013, two 316F and three 1547J.....
16071	409	Roller Presser complete, 1½ in. roller, ⅜ in. face, for ⅜ in. to ¼ in. gauges, Nos. 171F, 176D, 440F, 1549J, 1958, 7556, 16015, 16016, 19200, two 316F and three 1547J.....
16017	404	Roller Presser complete, 1½ in. roller, ⅜ in. face, for ⅜ in. to ¼ in. gauges, Nos. 171F, 176D, 440F, 1549J, 1875, 7556, 16015, 16016, 19200, two 316F and three 1547J.....
16234	3666	Roller Presser (ball bearing) complete, 1½ in. roller, ⅜ in. face, for ⅜ in. to ¼ in. gauges, Nos. 171F, 176D, 207F, 440F, 1549J, 4785, 7556, 16080, 16081, 16231, 51835, two 316F and three 1547J.....
16235	—	Roller Presser (ball bearing) complete, 1½ in. roller, ⅜ in. face, for ⅜ in. to ¼ in. gauges, Nos. 171F, 176D, 440F, 1549J, 7556, 16016, 16231, 19200, 51835, two 316F and three 1547J.....
16237	3669	Roller Presser (ball bearing) complete, 1½ in. roller, ⅜ in. face, for ⅜ in. to ¼ in. gauges, Nos. 171F, 176D, 207F, 440F, 1549J, 4785, 7556, 16080, 16081, 16231, 51856, two 316F and three 1547J.....
190D	402	Roller Presser Screw.....
634D	412	" Screw for 1875.....
1261D	3658	" " " 1958.....
50553c	3665	" " " 51835.....
1528J	412	" " Nut.....
2210	405	Shuttle (inside) Bobbin.....
3230	405	" " " Retaining Spring.....
2212	405	" " " " " Rivet.....
*3235	—	Shuttle (inside) Body with 398E, 2084, 3230, 3240 and two 2212.....
*16205	—	Shuttle (inside) Cover.....
2076	405	" " " Hinge Pin.....
2078	405	" " " Delivery Eye Thread Guard.....
2080	405	Shuttle (inside) Delivery Eye Thread Guard Rivet.....

NO.	PLATE	NAME
3240	405	Shuttle (inside) Main Spring.....
398E	405	" " " " " Screw.....
2084	405	" " " " " Steady Pin.....
466c	405	" " " " " Tension Regulating Screw.....
2086	405	" " " " " Spring.....
2090	405	" " " " " Plate.....
112E	405	" " " " " " Screw.....
16206	3668	Shuttle (inside) closed eye, complete, for ⅜ in. to ¼ in. gauges, Nos. 112E, 466c, 2076, 2078, 2080, 2086, 2090, 2210, 3235 and 16205.....
2210	405	Shuttle (outside) Bobbin.....
3230	405	" " " " " Retaining Spring.....
2212	405	Shuttle (outside) Bobbin Retaining Spring Rivet.....
*3232	—	Shuttle (outside) Body with 398E, 2084, 3230, 3239 and two 2212, for 6913.....
*3383	—	Shuttle (outside) Body with 398E, 2084, 3230, 3239 and two 2212, for 6909.....
*16207	—	Shuttle (outside) Cover.....
2076	405	" " " " " Hinge Pin.....
3238	405	" " " " " Delivery Eye Thread Guard.....
2080	405	Shuttle (outside) Delivery Eye Thread Guard Rivet.....
3239	405	Shuttle (outside) Main Spring.....
398E	405	" " " " " Screw.....
2084	405	" " " " " Steady Pin.....
466c	405	" " " " " Tension Regulating Screw.....
3241	405	" " " " " Spring.....
3242	405	" " " " " Plate.....
112E	405	" " " " " " Screw.....
16209	3668	Shuttle (outside) closed eye, complete, for ⅜ in. to ¼ in. gauges, Nos. 112E, 466c, 2076, 2080, 2210, 3232, 3238, 3241, 3242 and 16207.....
16208	3668	Shuttle (outside) closed eye, complete, for ⅜ in. to ¼ in. gauges, Nos. 112E, 466c, 2076, 2080, 2210, 3238, 3241, 3242, 3383 and 16207.....
16213	3664	Shuttle Driver and Feed Lifting Cam....
2049	400	" " " " " " " Pin.....
16166	403	" " " " " Race Body (two pieces) with either 813D, 814D or 815D, for 6746....
16238	3668	Shuttle Race Body (two pieces) with either 813D, 814D or 815D, for 16239....

NO.	PLATE	NAME
16103	3654	Shuttle Race Cap.....
102D	402	" " " Screw.....
813D	402	" " Hinge Screw, for $\frac{1}{8}$ in. to $\frac{1}{2}$ in. gauges.....
814D	402	Shuttle Race Hinge Screw, for $\frac{3}{16}$ in. to $\frac{5}{8}$ in. gauges.....
815D	402	Shuttle Race Hinge Screw, for $\frac{1}{8}$ in. to $\frac{1}{4}$ in. gauges.....
6709	400	Shuttle Race Lock Pin.....
NOTE: When ordering No. 6709, state gauge of Shuttle Race for which it is required		
16101	3653	Shuttle Race Lock Pin Bushing.....
6758	398	" " " " Spring.....
102D	402	" " " " " Screw.....
6746	403	Shuttle Race complete, for $\frac{3}{8}$ in. to $\frac{1}{4}$ in. gauges, Nos. 6709, 6758, 16166 and two 102D.....
16239	3668	Shuttle Race complete, for $\frac{1}{2}$ in. to $\frac{5}{8}$ in. gauges, Nos. 6709, 6758, 16238 and two 102D.....
738D	402	Shuttle Race Screw.....
16136	3651	Tension and Needle Bar Guide Bracket
16137	—	Tension and Needle Bar Guide Bracket complete, Nos. 16136, two each 637E, 1560c, 2103 and four 2102.....
190D	402	Tension and Needle Bar Guide Bracket Screw.....
2102	398	Tension Disc.....
1560c	401	" Regulating Thumb Nut.....
6600	397	" Releaser.....
16149	3657	" " Bracket with two 465c
465c	402	" " " Set Screw.....
207D	402	" " Screw.....
637c	401	" Screw Stud.....
2103	400	" Spring.....
2413	398	" Thread Eyelet (double).....
330D	402	" " " Screw.....
*56831	—	Thread Take-up Cam (steel).....
3280	393	" " " 56831 with 446c..
3012	400	" " " Pin.....
446c	402	" " " Set Screw.....
*6704	393	" " Lever with 1819.....
16181	—	" " " 6704 with 76F....
76F	402	" " " Hinge Screw.....
1819	401	" " " Roller and Stud..
2410	398	" " Roller.....

NO.	PLATE	NAME
86D	412	Thread Take-up Roller Screw.....
2411	398	" " " Stud.....
175F	402	" " " " Set Screw..
6603	400	" " " Spring.....
6477	398	" " " Regulator Plate
233D	402	" " " " " " Adjusting Screw.....
6602	398	Thread Take-up Spring Thread Guard and Thread Eyelet.....
219D	402	Thread Take-up Spring Thread Guard and Thread Eyelet Screw.....
16151	—	Throat Plate Body.....
16152	3677	" " Needle Plate.....
228D	402	" " " " Screw.....
16153	3677	Throat Plate complete for 16018 for $\frac{1}{8}$ in. to $\frac{5}{16}$ in. gauges, and for 6677 for $\frac{1}{2}$ in. to $\frac{1}{4}$ in. gauges, Nos. 228D, 16151 and 16152.....
691D	412	Throat Plate Screw.....
16077	3650	Drip Pan.....

**LIST OF PARTS COMPLETE  
FOR  
MACHINE No. 18-6**

**FOR SHOE VAMPING. WHEEL FEED, GAUGES  
3/2 TO 1/8 INCH**

NO.	PLATE	NAME
*16120	—	Arm and Cylinder.....
3004	391	" Shaft.....
3005	393	" " Bushing.....
448c	402	" " " Set Screw.....
144d	402	" " " Screw.....
4288	411	" Side Cover (back).....
286d	401	" " " Thumb Screw....
16102	3652	" " " (front).....
164d	412	" " " " Screw.....
2415	393	" Spool Bracket.....
15063	393	" " " 2415 with two 12403..
145d	412	" " " " Screw.....
12403	400	" " " Spool Pin and Thread Eyelet.....
11241	392	Arm Spool Bracket Spool Pin Washer (cloth).....
4370	391	Balance Wheel, heavy rim, 2 3/4 in. pulley, with two 448c.....
4388	3655	Balance Wheel (power) light rim, 2 3/4 in. pulley, with two 448c.....
2862	391	Balance Wheel (stand) heavy rim, 3 in. pulley, for 3022.....
448c	402	Balance Wheel Set Screw.....
256j	392	Clamp Stop Motion Clamp Screw.....
248A	402	" " " " Stop Screw..
2020	392	" " " " Washer.....
*3023	—	" " " Flanged Bushing....
4933	392	" " " " 3023 with two 462c.....
2022	400	Clamp Stop Motion Flanged Bushing Pin
462c	412	" " " " " Set Screw.....
3022	—	Clamp Stop Motion complete, Nos. 248A, 256j, 2020 and 4933.....
6786	390	Cloth Plate.....
6083	390	" " Bracket with two 345c.....

NO.	PLATE	NAME
345c	401	Cloth Plate Bracket Set Screw.....
389F	401	" " " Screw.....
6496	390	" " " Slide.....
3286	397	" " " " Spring.....
725J	412	" " " " " Screw.....
6495	390	Cloth Plate complete, Nos. 3286, 6496, 6786 and two 725J.....
6494	—	Cloth Plate with Bracket complete, Nos. 6083, 6495 and two 389F.....
4292	391	Crank Connecting Rod with 4349 and two 145E.....
*4349	—	Crank Connecting Rod Cap.....
145E	3669	" " " " " Screw.....
375c	402	" " " " " Hinge Screw....
1518E	401	" " " " " " Nut..
16045	412	Cylinder Oil Tube for oiling 16113.....
16036	411	" Side Cover.....
286d	401	" " " " Thumb Screw....
3033	397	Feed Connecting Link.....
375c	402	" " " " " Hinge Screw....
1518E	401	" " " " " " Nut..
3074	393	" Eccentric with 446c.....
446c	402	" " " Set Screw.....
3037	391	" Forked Connection.....
375c	402	" " " " " Hinge Screw....
1518E	401	" " " " " " Nut
6459	393	" Regulator.....
58E	402	" " " Hinge Screw.....
818d	401	" " " Thumb Screw.....
6488	391	" Rock Shaft.....
6018	392	" " " Crank with 207F.....
156F	402	" " " " " Position Screw....
207F	402	" " " " " Set Screw.....
6497	403	" Wheel.....
6498	393	" " " Driver.....
16168	400	" " " " Spring.....
207F	402	" " " " " Screw.....
6089	400	" " " Friction Spring.....
207F	402	" " " " " Screw.....
4344	393	Needle Bar.....
16178	—	" " " 4344 with 2273 and 4345....
16182	—	" " " " " " 6524....
*3045	3669	" " " Connecting Link.....
16220	—	" " " " " 3045 with 377c, 1518E and 6487.....
377c	402	Needle Bar Connecting Link Hinge Screw

NO.	PLATE	NAME
1518E	401	Needle Bar Connecting Link Hinge Screw Nut.....
6487	397	Needle Bar Connecting Stud with 155c..
155c	402	" " " " Set Screw..
3214	3654	" " Guide with 400c and 453c...
400c	3654	" " Adjusting Screw.....
453c	3654	" " " Set Screw.....
290E	402	" " Screw Bushing.....
4345	400	" Clamp with two 336F, for $\frac{1}{2}$ in. to $\frac{3}{4}$ in. gauges.....
6524	400	Needle Clamp with two 50014F, for $\frac{3}{8}$ in. to $\frac{1}{2}$ in. gauges.....
2273	400	Needle Clamp Pin.....
336F	402	" Set Screw for 4345.....
50014F	3654	" " " " 6524.....
*16111	3652	Oscillating Rock Shaft.....
16112	—	Oscillating Rock Shaft complete, Nos. 4784, 16111 and 16212.....
6489	392	Oscillating Rock Shaft Hinge Pin.....
16212	—	" " " " " " 6 4 8 9 with 1513J.....
1513J	401	Oscillating Rock Shaft Hinge Pin Nut...
4784	412	" " " Oil Pad.....
16113	3652	" Shaft.....
16115	—	" Crank for 16116.....
*16192	—	" " " " 16193.....
16116	3654	Oscillating Shaft Crank complete, Nos. 1518E, 16115, 19390 and two 462c.....
*16193	—	Oscillating Shaft Crank complete, Nos. 462c, 1518E, 16192 and 19390.....
2049	400	Oscillating Shaft Crank Pin.....
462c	412	" " " Set Screw.....
19389	3654	" " " Slide Block.....
226D	3669	" " " " " Cap Screw.....
12424	3654	Oscillating Shaft Crank Slide Block Cap Screw Washer.....
969c	3654	Oscillating Shaft Crank Slide Block Screw Stud.....
1518E	3654	Oscillating Shaft Crank Slide Block Screw Stud Nut.....
19390	3654	Oscillating Shaft Crank Slide Block complete, Nos. 226D, 969c, 12424 and 19389
3054	393	Presser Bar.....
6464	393	" " Lifter.....
77F	412	" " " Screw.....
6465	398	" " " Washer.....

NO.	PLATE	NAME
16194	3664	Presser Bar Lifting Bracket with 175J and two 457K.....
16195	—	Presser Bar Lifting Bracket 16194 with 16196 and two 335J.....
175J	402	Presser Bar Lifting Bracket Adjusting Screw.....
6469	397	Presser Bar Lifting Bracket Guide.....
175J	402	" " " " " Screw
457K	402	" " " " " Set Screw....
16196	3664	" " " " " Wearing Plate
335J	3657	" " " " " " " Screw.....
290E	402	Presser Bar Screw Bushing.....
5459	410	" " Spring (light) .047 wire.....
6466	393	" " " (medium) .055 wire...
6467	410	" " " (heavy) .063 wire.....
2070	398	" " " Washer.....
6533	398	" " Stop Collar with 460c.....
460c	402	" " " " " Set Screw.....
262J	401	Pressure Regulating Thumb Screw.....
1958	409	Roller, $1\frac{1}{2}$ in. diam., with 1261D and 1528J, for 16071 and 16082.....
1875	404	Roller, $1\frac{1}{2}$ in. diam., with 634D and 1528J, for 16014 and 16017.....
51834	—	Roller, $1\frac{1}{2}$ in. diam., coarse, for 51835...
51835	3666	Roller (ball bearing) $1\frac{1}{2}$ in. coarse roller, Nos. 1528J, 1766c, 50553c, 51834 and twenty-four 16232, for 16234 and 16235
16015	409	Roller Arm for 16017 and 16071.....
6535	404	" " " 16014 and 16082.....
16231	3665	" " " 16234 and 16235.....
440F	402	" " Adjusting Screw.....
1547J	402	" " " " Nut.....
19200	404	" " Bracket for 16017, 16071 and 16235.....
4785	3659	Roller Arm Bracket for 16014, 16082 and 16234.....
7556	404	Roller Arm Lock Spring.....
176D	402	" " " " " Screw.....
1549J	402	" " " " " Nut.....
316F	402	" " Screw Centre.....
1547J	402	" " " " " Nut.....
16232	3665	" Ball, size $\frac{3}{8}$ in.....
1766c	3665	" Retaining Nut.....
16080	409	" Needle Guard (flat) for 16082 and 16234.....

NO.	PLATE	NAME
16010	404	Roller Needle Guard (flat) for 16014.....
207F	402	" " " " Screw.....
16016	404	" " " (round) for 16017, 16071 and 16235.....
16013	404	Roller Needle Guard (round) for 16014
16081	409	" " " " " 16082 and 16234.....
16138	3659	Roller Needle Guard (round) with 242D and 16139, for 16014.....
16139	3659	Roller Needle Guard (round) Edge Guide for 16138.....
242D	3659	Roller Needle Guard (round) Edge Guide Screw.....
171F	402	Roller Needle Guard (round) Set Screw..
16082	409	Roller Presser complete, 1½ in. roller, ⅜ in. face, for ⅜ in. to ⅝ in. gauges, Nos. 171F, 176D, 207F, 440F, 1549J, 1958, 4785, 6535, 7556, 16080, 16081, two 316F and three 1547J.....
16014	404	Roller Presser complete, 1½ in. roller, ⅜ in. face, for ⅜ in. to ⅝ in. gauges, Nos. 171F, 176D, 207F, 440F, 1549J, 1875, 4785, 6535, 7556, 16010, 16013, two 316F and three 1547J.....
16071	409	Roller Presser complete, 1½ in. roller, ⅜ in. face, for ⅜ in. to ¼ in. gauges, Nos. 171F, 176D, 440F, 1549J, 1958, 7556, 16015, 16016, 19200, two 316F and three 1547J.....
16017	404	Roller Presser complete, 1½ in. roller, ⅜ in. face, for ⅜ in. to ¼ in. gauges, Nos. 171F, 176D, 440F, 1549J, 1875, 7556, 16015, 16016, 19200, two 316F and three 1547J.....
16234	3666	Roller Presser (ball bearing) complete, 1½ in. roller, ⅜ in. face, for ⅜ in. to ⅝ in. gauges, Nos. 171F, 176D, 207F, 440F, 1549J, 4785, 7556, 16080, 16081, 16231, 51835, two 316F and three 1547J
16235	—	Roller Presser (ball bearing) complete, 1½ in. roller, ⅜ in. face, for ⅜ in. to ¼ in. gauges, Nos. 171F, 176D, 440F, 1549J, 7556, 16016, 16231, 19200, 51835, two 316F and three 1547J.....
190D	402	Roller Presser Screw.....
634D	412	" Screw for 1875.....
1261D	3658	" " " 1958.....

NO.	PLATE	NAME
50553c	3665	Roller Screw for 51835.....
1528J	412	" " Nut.....
2210	405	Shuttle (inside) Bobbin.....
3230	405	" " " Retaining Spring
2212	405	" " " " " "
		Rivet.....
*3235	—	Shuttle (inside) Body with 398E, 2084, 3230, 3240 and two 2212.....
*16205	—	Shuttle (inside) Cover.....
2076	405	" " " Hinge Pin.....
2078	405	" " Delivery Eye Thread Guard.....
2080	405	Shuttle (inside) Delivery Eye Thread Guard Rivet.....
3240	405	Shuttle (inside) Main Spring.....
398E	405	" " " " Screw.....
2084	405	" " " " Steady Pin.
466c	405	" " Tension Regulating Screw
2086	405	" " " Spring.....
2090	405	" " " Plate.....
112E	405	" " " " Screw
16206	3668	Shuttle (inside) closed eye, complete, for ⅜ in. to ½ in. gauges, Nos. 112E, 466c, 2076, 2078, 2080, 2086, 2090, 2210, 3235 and 16205.....
2210	405	Shuttle (outside) Bobbin.....
3230	405	" " " Retaining Spring.....
2212	405	Shuttle (outside) Bobbin Retaining Spring Rivet.....
*3232	—	Shuttle (outside) Body with 398E, 2084, 3230, 3239 and two 2212, for 6913.....
*3383	—	Shuttle (outside) Body with 398E, 2084, 3230, 3239 and two 2212, for 6909.....
*16207	—	Shuttle (outside) Cover.....
2076	405	" " " Hinge Pin.....
3238	405	" " Delivery Eye Thread Guard.....
2080	405	Shuttle (outside) Delivery Eye Thread Guard Rivet.....
3239	405	Shuttle (outside) Main Spring.....
398E	405	" " " " Screw.....
2084	405	" " " " Steady Pin
466c	405	" " Tension Regulating Screw.....
3241	405	Shuttle (outside) Tension Spring.....
3242	405	" " " " Plate..

NO.	PLATE	NAME
112E	405	Shuttle (outside) Tension Spring Plate Screw.....
16209	3668	Shuttle (outside) closed eye, complete, for $\frac{1}{2}$ in. to $\frac{3}{8}$ in. gauges, Nos. 112E, 466C, 2076, 2080, 2210, 3232, 3238, 3241, 3242 and 16207.....
16208	3668	Shuttle (outside) closed eye, complete, for $\frac{3}{8}$ in. to $\frac{1}{2}$ in. gauges, Nos. 112E, 466C, 2076, 2080, 2210, 3238, 3241, 3242, 3383 and 16207.....
16048	405	Shuttle Driver.....
2049	400	" " Pin.....
6653	403	" Race Body (two pieces) with 6571, 6576, 16049, 16050 and two each 6574 and 6575.....
16008	403	Shuttle Race Cap.....
6570	—	Shuttle Race Cap complete, Nos. 6472, 16008 and two 725J.....
6472	398	Shuttle Race Cap Latch.....
725J	412	" " " " Screw.....
102D	402	" " " " Screw.....
*6574	—	" " Hinge.....
16049	400	" " " Pin.....
6575	400	" " " Rivet.....
*6571	—	" " Latch.....
6573	400	" " " Pin.....
6572	398	" " " " Spring.....
102D	402	" " " " " Screw....
16050	400	" " " " Rivet.....
6576	396	" " Loop Separator.....
6587	396	" " Needle Plate.....
229D	3654	" " " " Screw.....
6642	403	Shuttle Race complete, for $\frac{1}{2}$ in. to $\frac{1}{8}$ in. gauges, Nos. 229D, 6572, 6573, 6587, 6653 and two 102D.....
50037D	3664	Shuttle Race Screw.....
16136	3651	Tension and Needle Bar Guide Bracket..
16137	—	Tension and Needle Bar Guide Bracket complete, Nos. 16136, two each 637C, 1560C, 2103 and four 2102.....
190D	402	Tension and Needle Bar Guide Bracket Screw.....
2102	398	Tension Disc.....
1560C	401	" Regulating Thumb Nut.....
6600	397	" Releaser.....
6601	397	" " Bracket with two 465C..
465C	402	" " " " Set Screw.....

NO.	PLATE	NAME
207F	402	Tension Releaser Screw.....
637C	401	" Screw Stud.....
2103	400	" Spring.....
2413	398	" Thread Eyelet (double).....
330D	402	" " " " Screw.....
*56831	—	Thread Take-up Cam (steel).....
3280	393	" " " " 56831 with 446C...
3012	400	" " " " Pin.....
446C	402	" " " " Set Screw.....
*6704	393	" " Lever with 1819.....
16181	—	" " " " 6704 with 76F....
76F	402	" " " " Hinge Screw.....
1819	401	" " " " Roller and Stud..
2410	398	" " " " Roller.....
86D	412	" " " " Screw.....
2411	398	" " " " Stud.....
175F	402	" " " " " Set Screw..
6603	400	" " " " Spring.....
6477	398	" " " " " Regulator Plate
233D	402	" " " " " " "
		Adjusting Screw.....
6602	398	Thread Take-up Spring Thread Guard and Thread Eyelet.....
219D	402	Thread Take-up Spring Thread Guard and Thread Eyelet Screw.....
16077	3650	Drip Pan.....

**LIST OF PARTS COMPLETE  
FOR  
MACHINE No. 18-7**

**FOR SHOES. C. B., CYLINDER 2 INCHES DIAMETER,  
DROP FEED AT LEFT OF NEEDLE**

NO.	PLATE	NAME
*16121	—	Arm and Cylinder.....
3004	391	" Shaft.....
3005	393	" " Bushing.....
448c	402	" " " Set Screw.....
144d	402	" " " Screw.....
4288	411	" Side Cover (back).....
286d	401	" " " " Thumb Screw....
16102	3652	" " " (front).....
164d	412	" " " " Screw.....
12403	400	" Spool Pin and Thread Eyelet.....
8879	412	" " " Washer (cloth).....
4370	391	Balance Wheel, heavy rim, 2¾ in. pulley, with two 448c.....
4388	3655	Balance Wheel (power) light rim, 2¾ in. pulley, with two 448c.....
2862	391	Balance Wheel (stand) heavy rim, 3 in. pulley, for 3022.....
448c	402	Balance Wheel Set Screw.....
256j	392	Clamp Stop Motion Clamp Screw.....
248A	402	" " " " Stop Screw....
2020	392	" " " " Washer.....
*3023	—	" " " Flanged Bushing....
4933	392	" " " " " 3023 with two 462c.....
2022	400	Clamp Stop Motion Flanged Bushing Pin
462c	412	" " " " " Set Screw.....
3022	—	Clamp Stop Motion complete, Nos. 248A, 256j, 2020 and 4933.....
6790	394	Cloth Plate.....
6792	394	" " Bracket with 345c.....
345c	401	" " " Set Screw.....
389F	401	" " " Screw.....
6791	—	Cloth Plate with Bracket complete, Nos. 6790, 6792 and two 389F.....
4292	391	Crank Connecting Rod with 4349 and two 145E.....

NO.	PLATE	NAME
*4349	—	Crank Connecting Rod Cap.....
145E	3669	" " " " Screw.....
375c	402	" " " Hinge Screw.....
1518E	401	" " " " Nut
16045	412	Cylinder Oil Tube for oiling 6462.....
16036	411	" Side Cover.....
286d	401	" " " Thumb Screw.....
3032	393	Feed Cam with 446c.....
446c	402	" " Set Screw.....
3033	397	" Connecting Link.....
375c	402	" " " Hinge Screw.....
1518E	401	" " " " Nut..
6504	396	" Dog.....
6505	406	" " Carrier.....
231c	412	" " Screw.....
3037	391	" Forked Connection.....
375c	402	" " " Hinge Screw....
1518E	401	" " " " " Nut
6459	393	" Regulator.....
58E	402	" " Hinge Screw.....
818E	401	" " Thumb Screw.....
6460	391	" Rock Shaft.....
6018	392	" " " Crank with 207F.....
156F	402	" " " Position Screw..
207F	402	" " " Set Screw.....
3044	393	Needle Bar.....
*3045	3669	" " Connecting Link.....
16220	—	" " " " 3045 with 377c, 1518E and 6487.....
377c	402	Needle Bar Connecting Link Hinge Screw
1518E	401	" " " " " "
		Nut.....
6487	397	Needle Bar Connecting Stud with 155c..
155c	402	" " " " Set Screw..
290E	402	" " Screw Bushing.....
2053	400	" " Thread Guard.....
233d	402	" " " " Screw.....
2167	400	" Clamp with 196F.....
196F	402	" " Screw.....
*6461	392	Oscillating Rock Shaft (steel) with 4784..
16176	—	Oscillating Rock Shaft complete, Nos. 6461 and 16212.....
6489	392	Oscillating Rock Shaft Hinge Pin....
16212	—	" " " " " 6489 with 1513j.....
1513j	401	Oscillating Rock Shaft Hinge Pin Nut...
4784	412	" " " Oil Pad.....

NO.	PLATE	NAME
6462	391	Oscillating Shaft.....
*7225	—	“ “ Crank with 1813.....
7054	406	“ “ “ 7225 with two 462c.....
2049	400	Oscillating Shaft Crank Pin.....
1813	401	“ “ “ Roller and Stud
462c	412	“ “ “ Set Screw.....
3054	393	Presser Bar.....
6464	393	“ “ Lifter.....
77j	412	“ “ “ Screw.....
6465	398	“ “ “ Washer.....
16194	3664	“ “ Lifting Bracket with 175j and two 457k.....
16195	—	Presser Bar Lifting Bracket 16194 with 16196 and two 335j.....
175j	402	Presser Bar Lifting Bracket Adjusting Screw.....
6469	397	Presser Bar Lifting Bracket Guide.....
175d	402	“ “ “ “ Screw
457k	402	“ “ “ “ Set Screw...
16196	3664	“ “ “ “ Wearing Plate.....
335j	3657	Presser Bar Lifting Bracket Wearing Plate Screw.....
290E	402	Presser Bar Screw Bushing.....
5459	410	“ “ Spring (light) .047 wire.....
6466	393	“ “ “ (medium) .055 wire..
6467	410	“ “ “ (heavy) .063 wire.....
2070	398	“ “ “ Washer.....
2180	396	“ Foot.....
190d	402	“ “ Screw.....
262j	401	Pressure Regulating Thumb Screw.....
1868	399	Roller, 7/8 in. diam., coarse, with 652d and 1528j, for 2196.....
1841	3659	Roller, 7/8 in. diam., fine, with 652d and 1528j, for 2197.....
1839	3659	Roller, 1 1/4 in. diam., coarse, with 386d and 1528j, for 16099.....
1869	3659	Roller, 1 1/4 in. diam., fine, with 386d and 1528j, for 16100.....
1897	3666	Roller, 1 1/4 in. diam., coarse, with 386d and 1528j, for 16225.....
1898	—	Roller, 1 1/4 in. diam., fine, with 386d and 1528j, for 16226.....
1923	3666	Roller, 1 1/4 in. diam., coarse, with 652d and 1528j, for 16228.....
51832	—	Roller, 1 1/4 in. diam., coarse, for 51833...

NO.	PLATE	NAME
51833	3665	Roller (ball bearing) 1 1/4 in. coarse roller, 1/2 in. face, Nos. 1528j, 1766c, 50553c, 51832 and twenty-four 16232, for 16233
51841	—	Roller, 1 1/4 in. diam., coarse, for 51842...
51842	3665	“ (ball bearing) 1 1/4 in. coarse roller, 5/8 in. face, Nos. 1528j, 1766c, 50553c, 51841 and twenty-four 16232, for 16236
2203	399	Roller Arm for 2196 and 2197.....
16098	3653	“ “ “ 16099, 16100, 16225, 16226 and 16228.....
16230	3665	Roller Arm for 16233 and 16236.....
440F	402	“ “ Adjusting Screw.....
1547j	402	“ “ “ “ Nut.....
2206	399	“ “ Bracket for 2196 and 2197...
4282	3659	“ “ “ “ 16099, 16100, 16225, 16226, 16228, 16233 and 16236..
2205	399	Roller Arm Lock Spring.....
176d	402	“ “ “ “ Screw.....
1549j	402	“ “ “ “ “ Nut.....
316F	402	“ “ Screw Centre.....
1547j	402	“ “ “ “ Nut.....
16232	3665	“ Ball, size 3/8 in.....
1766c	3665	“ “ Retaining Nut.....
2196	399	Roller Presser complete, 7/8 in. coarse roller, Nos. 176d, 440F, 1549j, 1868, 2203, 2205, 2206, two 316F and three 1547j.....
2197	—	Roller Presser complete, 7/8 in. fine roller, Nos. 176d, 440F, 1549j, 1841, 2203, 2205, 2206, two 316F and three 1547j..
16099	3658	Roller Presser complete, 1 1/4 in. coarse roller, Nos. 176d, 440F, 1549j, 1839, 2205, 4282, 16098, two 316F and three 1547j.....
16100	—	Roller Presser complete, 1 1/4 in. fine roller, Nos. 176d, 440F, 1549j, 1869, 2205, 4282, 16098, two 316F and three 1547j
16225	3666	Roller Presser complete, 1 1/4 in. coarse roller, Nos. 176d, 440F, 1549j, 1897, 2205, 4282, 16098, two 316F and three 1547j.....
16226	—	Roller Presser complete, 1 1/4 in. fine roller, Nos. 176d, 440F, 1549j, 1898, 2205, 4282, 16098, two 316F and three 1547j
16228	3666	Roller Presser complete, 1 1/4 in. coarse roller, Nos. 176d, 440F, 1549j, 1923, 2205, 4282, 16098, two 316F and three 1547j.....



NO.	PLATE	NAME
16233	3665	Roller Presser (ball bearing) complete, 1¼ in. coarse roller, ⅜ in. face, Nos. 176D, 440F, 1549J, 2205, 4282, 16230, 51833, two 316F and three 1547J.....
16236	3665	Roller Presser (ball bearing) complete, 1¼ in. coarse roller, ⅜ in. face, Nos. 176D, 440F, 1549J, 2205, 4282, 16230, 51842, two 316F and three 1547J.....
190D	402	Roller Presser Screw.....
652D	3658	" Screw for 1841, 1868 and 1923....
386D	3659	" " " 1839, 1869, 1897 and 1898.....
50553C	3665	Roller Screw for 51833 and 51842.....
1528J	412	" " Nut.....
2996	406	Shuttle Bobbin.....
16091	406	" " Case Latch.....
16027	406	" " " " Lever.....
2974	406	" " " " " Fulcrum Pin.....
2975	406	Shuttle Bobbin Case Latch Spring.....
592E	406	" " " " Stop Screw....
16092	—	" " " Hinge, Nos. 2974 16027 and 16091.....
16028	406	Shuttle Bobbin Case Position Finger....
2523	406	" " " " " Rivet.....
16093	406	Shuttle Bobbin Case complete, Nos. 591F, 592E, 2523, 2975, 6669, 16028 and 16092
6668	406	Shuttle Body.....
591F	406	" Tension Regulating Screw.....
6669	406	" " Spring.....
16023	406	Shuttle, 1½ in. diam., Nos. 2996, 6668 and 16093.....
6670	406	Shuttle Driver and Feed Lifting Cam....
2049	400	" " " " " " Pin
6762	403	" Race Body (steel).....
16105	3653	" " Needle Guard.....
1053D	3654	" " " Screw.....
6763	403	" " Ring (steel).....
185D	402	" " " Screw.....
6764	—	Shuttle Race (steel) complete, Nos. 6762, 6763, 16105 and two each 185D and 1053D.....
401D	402	Shuttle Race Screw.....
2102	398	Tension Disc.....
1560C	401	" Regulating Thumb Nut.....
16005	406	" Releaser.....
16006	406	" " Collar with 460C and 7393

NO.	PLATE	NAME
7393	400	Tension Releaser Collar Pin.....
460C	402	" " " Set Screw.....
102D	402	" " " Screw.....
600C	3654	" Screw Stud.....
16202	—	" " " 600C with 1560C.....
175D	402	" " " Set Screw.....
2103	400	" Spring.....
16022	398	" Thread Guard.....
219D	402	" " " Screw.....
16204	—	Tension complete, Nos. 2103, 16202 and two 2102.....
2112	400	Thread Retaining Disc with 2113.....
2113	400	" " " Steady Pin.....
2114	400	" " " Spring.....
2115	400	" " " Stud.....
460C	402	" " " Set Screw.....
2111	400	Thread Retainer Guide complete, Nos. 2112, 2114 and 2115.....
*56828	—	Thread Take-up Cam (steel).....
3182	393	" " " 56828 with 446C...
3012	400	" " " Pin.....
446C	402	" " " Set Screw.....
*6474	393	" " " Lever with 1819.....
16380	—	" " " 6474 with 76F....
76F	402	" " " Hinge Screw.....
1819	401	" " " Roller and Stud..
6768	400	" " " Spring.....
6477	398	" " " Regulator Plate
233D	402	" " " " " " " Adjusting Screw.....
6676	396	Throat Plate, large needle hole, for 6504
16125	—	" " " small needle hole, for 6504
401D	402	" " " Screw.....
16077	3650	Drip Pan.....

**LIST OF PARTS COMPLETE  
FOR  
MACHINE No. 18-8**

**C. B., DROP FEED AT RIGHT OF NEEDLE, CYLINDER  
BED 2 INCHES IN DIAMETER. FOR SHOE WORK**

NO.	PLATE	NAME
*16121	—	Arm and Cylinder.....
3004	391	Shaft.....
3005	393	" " Bushing.....
448c	402	" " " Set Screw.....
144d	402	" " Screw.....
4288	411	" Side Cover (back).....
286d	401	" " " " Thumb Screw....
16102	3652	" " " (front).....
164d	412	" " " Screw.....
12403	400	" Spool Pin and Thread Eyelet.....
8879	412	" " " Washer (cloth).....
4370	391	Balance Wheel, heavy rim, 2¾ in. pulley, with two 448c.....
4388	3655	Balance Wheel (power) heavy rim, 2¾ in. pulley, with two 448c.....
2862	391	Balance Wheel (stand) heavy rim, 3 in. pulley, for 3022.....
448c	402	Balance Wheel Set Screw.....
256j	392	Clamp Stop Motion Clamp Screw.....
248A	402	" " " " Stop Screw..
2020	392	" " " " Washer.....
*3023	—	" " " Flanged Bushing....
4933	392	" " " " 3023 with two 462c.....
2022	400	Clamp Stop Motion Flanged Bushing Pin
462c	412	" " " " " Set Screw.....
3022	—	Clamp Stop Motion complete, Nos. 248A, 256j, 2020 and 4933.....
16051	394	Cloth Plate.....
16052	394	" " Bracket with 345c.....
345c	401	" " " Set Screw.....
389F	401	" " Screw.....
16053	—	Cloth Plate with Bracket complete, Nos. 16051, 16052 and two 389f.....

NO.	PLATE	NAME
4292	391	Crank Connecting Rod with 4349 and two 145E.....
*4349	—	Crank Connecting Rod Cap.....
145E	3669	" " " " Screw.....
375c	402	" " " " Hinge Screw.....
1518E	401	" " " " " Nut
16045	412	Cylinder Oil Tube for oiling 6462.....
16036	411	" Side Cover.....
286d	401	" " " Thumb Screw.....
3032	303	Feed Cam with 446c.....
446c	402	" " Set Screw.....
3033	397	" Connecting Link.....
375c	402	" " " Hinge Screw.....
1518E	401	" " " " " Nut.
16001	396	" Dog.....
16086	3675	" " (circular feed).....
6505	406	" " Carrier.....
231c	412	" " Screw.....
3037	391	" Forked Connection.....
375c	402	" " " Hinge Screw....
1518E	401	" " " " " Nut
6459	393	" Regulator.....
58E	402	" " Hinge Screw.....
818D	401	" " Thumb Screw.....
6460	391	" Rock Shaft.....
6018	392	" " " Crank with 207F.....
156F	402	" " " " Position Screw..
207F	402	" " " " Set Screw.....
3044	393	Needle Bar.....
*3045	3669	" " Connecting Link.....
16220	—	" " " " 3045 with 377c, 1518E and 6487.....
377c	402	Needle Bar Connecting Link Hinge Screw
1518E	401	" " " " " "
		Nut.....
6487	397	Needle Bar Connecting Stud with 155c..
155c	402	" " " " Set Screw..
290E	402	" " Screw Bushing.....
2053	400	" " Thread Guard.....
233D	402	" " " " Screw.....
2167	400	" Clamp with 196f.....
196F	402	" " Screw.....
*6461	392	Oscillating Rock Shaft (steel) with 4784
16176	—	Oscillating Rock Shaft complete, Nos. 6461 and 16212.....

NO.	PLATE	NAME
6489	392	Oscillating Rock Shaft Hinge Pin.....
16212	—	“ “ “ “ “ “ 6489 with 1513J.....
1513J	401	Oscillating Rock Shaft Hinge Pin Nut...
4784	412	“ “ “ Oil Pad.....
6462	391	“ Shaft.....
*7225	—	“ “ Crank with 1813.....
7054	406	“ “ “ 7225 with two 462c.....
2049	400	Oscillating Shaft Crank Pin.....
1813	401	“ “ “ Roller and Stud
462c	412	“ “ “ Set Screw.....
3054	393	Presser Bar.....
6464	393	“ “ Lifter.....
77J	412	“ “ “ Screw.....
6465	398	“ “ “ Washer.....
16194	3664	“ “ Lifting Bracket with 175J and two 457K.....
16195	—	Presser Bar Lifting Bracket 16194 with 16196 and two 335J.....
175J	402	Presser Bar Lifting Bracket Adjusting Screw.....
6469	397	Presser Bar Lifting Bracket Guide.....
175J	402	“ “ “ “ “ Screw...
457K	402	“ “ “ “ “ Set Screw...
16196	3664	“ “ “ “ “ Wearing Plate.....
335J	3657	Presser Bar Lifting Bracket Wearing Plate Screw.....
290E	402	Presser Bar Screw Bushing.....
5459	410	“ “ Spring (light) .047 wire.....
6466	393	“ “ “ (medium) .055 wire...
6467	410	“ “ “ (heavy) .063 wire.....
2070	398	“ “ “ Washer.....
6069	396	“ Foot.....
190D	402	“ “ Screw.....
262J	401	Pressure Regulating Thumb Screw.....
1868	399	Roller, 3/8 in. diam., coarse, with 652D and 1528J, for 6070.....
1841	3659	Roller, 3/8 in. diam., fine, with 652D and 1528J, for 6071.....
6072	399	Roller Arm.....
440F	402	“ “ Adjusting Screw.....
1547J	402	“ “ “ “ Nut.....
6073	399	“ “ Bracket.....
2205	399	“ “ Lock Spring.....
176D	402	“ “ “ “ Screw.....

NO.	PLATE	NAME
1549J	402	Roller Arm Lock Spring Screw Nut.....
316F	402	“ “ Screw Centre.....
1547J	402	“ “ “ “ Nut.....
6070	399	Roller Presser complete, 1/8 in. coarse roller, Nos. 176D, 440F, 1549J, 1841, 1868, 2205, 6072, 6073, two 316F and three 1547J.....
6071	—	Roller Presser complete, 1/8 in. fine roller, Nos. 176D, 440F, 1549J, 1841, 2205, 6072, 6073, two 316F and three 1547J...
190D	402	Roller Presser Screw.....
652D	3658	“ Screw.....
1528J	412	“ “ Nut.....
2996	406	Shuttle Bobbin.....
16091	406	“ “ Case Latch.....
16027	406	“ “ “ Lever.....
2974	406	“ “ “ “ Fulcrum Pin.....
2975	406	Shuttle Bobbin Case Latch Spring.....
592E	406	“ “ “ “ Stop Screw...
16092	—	“ “ “ Hinge, Nos. 2974, 16027 and 16091.....
16028	406	Shuttle Bobbin Case Position Finger.....
2523	406	“ “ “ “ Rivet
16093	406	Shuttle Bobbin Case complete, Nos. 591F, 592E, 2523, 2975, 6669, 16028 and 16092
6668	406	Shuttle Body.....
591F	406	“ Tension Regulating Screw.....
6669	406	“ Spring.....
16023	406	Shuttle, 1 1/2 in. diam., Nos. 2996, 6668 and 16093.....
6670	406	Shuttle Driver and Feed Lifting Cam....
2049	400	“ “ “ “ “ Pin
16002	403	“ Race Body (steel).....
16003	403	“ “ Ring (steel).....
185D	402	“ “ “ Screw.....
16004	—	Shuttle Race (steel) complete, Nos. 16002, 16003 and two 185D.....
401D	402	Shuttle Race Screw.....
2102	398	Tension Disc.....
1560c	401	“ Regulating Thumb Nut.....
16005	406	“ Releaser.....
16006	406	“ “ Collar with 460c and 7393
7393	400	“ “ “ Pin.....
460c	402	“ “ “ Set Screw.....
102D	402	“ “ Screw.....
600c	3654	“ Screw Stud.....

NO.	PLATE	NAME
16202	—	Tension Screw Stud 600c with 1560c.....
175D	402	" " " Set Screw.....
2103	400	" Spring.....
16022	398	" Thread Guard.....
219D	402	" " Screw.....
16204	—	Tension complete, Nos. 2103, 16202 and two 2102.....
2112	400	Thread Retaining Disc with 2113.....
2113	400	" " " Steady Pin.....
2114	400	" " Spring.....
2115	400	" " Stud.....
460c	402	" " " Set Screw.....
2111	400	Thread Retainer Guide complete, Nos. 2112, 2114 and 2115.....
*56828	—	Thread Take-up Cam (steel).....
3182	393	" " " 56828 with 446c...
3012	400	" " " Pin.....
446c	402	" " " Set Screw.....
*6474	393	" " Lever with 1819.....
16180	—	" " " 6474 with 76F....
76F	402	" " " Hinge Screw.....
1819	401	" " " Roller and Stud..
6768	400	" " Spring.....
6477	398	" " " Regulator Plate
233D	402	" " " " " "
		Adjusting Screw.....
16007	396	Throat Plate for 16001.....
16087	3675	" " " 16086.....
401D	402	" " Screw.....
16077	3650	Drip Pan.....

## LIST OF PARTS COMPLETE FOR MACHINE No. 18-9

**TWO SHUTTLES, DROP FEED,  $\frac{3}{8}$  INCH TO  $\frac{1}{4}$  INCH GAUGES,  
WITH MECHANISM FOR STOPPING THE LEFT HAND  
NEEDLE. FOR CLOTH OR LEATHER.**

NO.	PLATE	NAME
*16122	—	Arm and Cylinder.....
3004	391	" Shaft.....
3005	393	" " Bushing.....
448c	402	" " " Set Screw.....
144D	402	" " Screw.....
4288	411	" Side Cover (back).....
286D	401	" " " Thumb Screw....
16102	3652	" " " (front).....
164D	412	" " " Screw.....
2415	393	" Spool Bracket.....
15063	393	" " " 2415 with two 12403
145D	412	" " " Screw.....
12403	400	" " " Spool Pin and Thread Eyelet.....
11241	392	Arm Spool Bracket Spool Pin Washer (cloth).....
4370	391	Balance Wheel, heavy rim, $2\frac{3}{4}$ in. pulley, with two 448c.....
4388	3655	Balance Wheel (power) light rim, $2\frac{3}{4}$ in. pulley, with two 448c.....
2862	391	Balance Wheel (stand) heavy rim, 3 in. pulley, for 3022.....
448c	402	Balance Wheel Set Screw.....
256J	392	Clamp Stop Motion Clamp Screw.....
248A	402	" " " Stop Screw.....
2020	392	" " " Clamp Washer.....
*3023	—	" " " Flanged Bushing....
4933	392	" " " " " 3023 with two 462c.....
2022	400	Clamp Stop Motion Flanged Bushing Pin
462c	412	" " " " " Set Screw.....
3022	—	Clamp Stop Motion complete, Nos. 248A, 256J, 2020 and 4933.....

NO.	PLATE	NAME
6716	394	Cloth Plate.....
6719	394	" " Bracket with 345c.....
345c	401	" " " Set Screw.....
389F	401	" " " Screw.....
6718	394	" " " Slide.....
3286	397	" " " Spring.....
725J	412	" " " " Screw.....
6717	394	Cloth Plate complete, Nos. 3286, 6716, 6718 and two 725J.....
6702	—	Cloth Plate with Bracket complete, Nos. 6717, 6719 and two 389F.....
4292	391	Crank Connecting Rod with 4349 and two 145E.....
*4349	—	Crank Connecting Rod Cap.....
145E	3669	" " " " Screw.....
375c	402	" " " Hinge Screw.....
1518E	401	" " " " Nut.
16045	412	Cylinder Oil Tube for oiling 16113.....
16036	411	" Side Cover.....
286D	401	" " " Thumb Screw.....
3032	393	Feed Cam with 446c.....
446c	402	" " Set Screw.....
3033	397	" Connecting Link.....
375c	402	" " " Hinge Screw.....
1518E	401	" " " " Nut.
6677	396	" Dog.....
6458	397	" " Carrier.....
231c	412	" " Screw.....
3037	391	" Forked Connection.....
375c	402	" " " Hinge Screw.....
1518E	401	" " " " Nut
6459	393	" Regulator.....
58E	402	" " Hinge Screw.....
818E	401	" " Thumb Screw.....
6678	391	" Rock Shaft.....
6018	392	" " " Crank with 207F.....
156F	402	" " " Position Screw..
207F	402	" " " " Set Screw.....
*16057	—	Needle Bar, for left hand needle, with 4766
*16058	—	" " " right hand needle.....
*3045	3669	" " Connecting Link.....
377c	402	" " " " Hinge Screw
1518E	401	" " " " " "
		Nut.....
16059	3653	Needle Bar Connecting Stud.....
207F	402	" " " " Screw.....
4766	3657	" " Coupling.....

NO.	PLATE	NAME
4767	3657	Needle Bar Coupling Pin.....
4768	3657	" " " " Lever.....
16060	3653	" " " " " Bell
		Crank with 9525.....
16061	3653	Needle Bar Coupling Pin Lever Bell
		Crank Bracket.....
159F	402	Needle Bar Coupling Pin Lever Bell
		Crank Bracket Screw.....
212D	3657	Needle Bar Coupling Pin Lever Bell
		Crank Cap Screw.....
16167	3657	Needle Bar Coupling Pin Lever Bell
		Crank Cap Screw Washer.....
9525	3657	Needle Bar Coupling Pin Lever Bell
		Crank Washer.....
16079	3653	Needle Bar Coupling Pin Lever Hub with
		330D.....
330D	402	Needle Bar Coupling Pin Lever Hub Set
		Screw.....
16062	3653	Needle Bar Coupling Pin Stop Bracket
335D	3657	" " " " " "
		Screw.....
921D	3657	Needle Bar Screw Bushing.....
4840	3657	" " Spring, for left hand needle..
4773	3657	" " " Collar.....
335D	3657	" " " " Screw.....
16144	3657	" " Stop Collar, for left hand
		needle.....
233D	402	Needle Bar Stop Collar Screw.....
16063	3653	" " Thread Eyelet.....
337D	3657	" " " " Screw.....
16067	3651	" " Trip Lever.....
6439	—	" " " " Chain, 36 in. to
		45 in., with 56864 and 56865.....
NOTE: When ordering No. 6439, give length required		
4879	3656	Needle Bar Trip Lever Chain Connecting
		Link for 4885.....
56864	413	Needle Bar Trip Lever Chain Hook (large)
56865	3664	" " " " " " (small)
16068	3651	" " " " Connection.....
90D	3657	" " " " " Screw..
802D	402	" " " " Hinge Screw.....
16069	3651	" " " " Spring.....
2022	400	" " " " Stop Pin.....
4881	3655	" " " " Treadle.....
4882	3656	" " " " Shaft.....
4883	3656	" " " " " Spring....

NO.	PLATE	NAME
4884	3655	Needle Bar Trip Lever Treadle Stand....
4885	3655	Needle Bar Trip Lever Treadle complete, Nos. 4879, 4881 to 4884 and two wood screws 1 in. No. 16.....
16064	3653	Needle Clamp, for right hand needle, with 874F, for $\frac{3}{8}$ in. to $\frac{1}{8}$ in. gauges.....
4861	3657	Needle Clamp, for right hand needle, with 336F and 620F, for $\frac{3}{8}$ in. to $\frac{1}{4}$ in. gauges
874F	3657	Needle Clamp and Needle (left hand) Set Screw for 16064.....
620F	3657	Needle Clamp Set Screw for 4861.....
620F	3657	" Set Screw, for left hand needle, for 16057, for 16065.....
336F	402	Needle Set Screw, for right hand needle, for 4861.....
16065	3651	Needle Bar complete, Nos. 207F, 337D, 620F, 4767, 4773, 4840, 4861 or 16064, 16057 to 16059, 16063, 16144 and two 233D.....
*16111	3652	Oscillating Rock Shaft.....
16112	—	Oscillating Rock Shaft complete, Nos. 4784, 16111 and 16212.....
6489	392	Oscillating Rock Shaft Hinge Pin.....
16212	—	" " " " " 6 4 8 9 with 1513J.....
1513J	401	Oscillating Rock Shaft Hinge Pin Nut....
4784	412	" " " Oil Pad.....
16113	3652	" Shaft.....
16115	—	" " Crank for 16116.....
*16192	—	" " " " " 16193.....
16116	3654	Oscillating Shaft Crank complete, Nos. 1518E, 16115, 19390 and two 462c.....
*16193	—	Oscillating Shaft Crank complete, Nos. 462c, 1518E, 16192 and 19390.....
2049	400	Oscillating Shaft Crank Pin.....
462c	412	" " " Set Screw.....
19389	3654	" " " Slide Block.....
226D	3669	" " " " " Cap Screw.....
12424	3654	Oscillating Shaft Crank Slide Block Cap Screw Washer.....
969c	3654	Oscillating Shaft Crank Slide Block Screw Stud.....
1518E	3654	Oscillating Shaft Crank Slide Block Screw Stud Nut.....

NO.	PLATE	NAME
19390	3654	Oscillating Shaft Crank Slide Block com- plete, Nos. 226D, 969c, 12424 and 19389
3054	393	Presser Bar.....
6464	393	" " Lifter.....
77J	412	" " " Screw.....
6465	398	" " " Washer.....
16194	3664	" " Lifting Bracket with 175J and two 457K.....
16195	—	Presser Bar Lifting Bracket 16194 with 16196 and two 335J.....
175J	402	Presser Bar Lifting Bracket Adjusting Screw.....
6469	397	Presser Bar Lifting Bracket Guide.....
175J	402	" " " " " Screw
457K	402	" " " " " Set Screw...
16196	3664	" " " " " Wear ing Plate.....
335J	3657	Presser Bar Lifting Bracket Wearing Plate Screw.....
875E	3657	Presser Bar Screw Bushing.....
5459	410	" " Spring (light) .047 wire.....
6466	393	" " " (medium) .055 wire..
6467	410	" " " (heavy) .063 wire.....
2070	398	" " " Washer.....
6533	398	" " Stop Collar with 460c.....
460c	402	" " " " " Set Screw.....
713E	3657	Pressure Regulating Thumb Screw.....
1918	3659	Roller, $1\frac{1}{2}$ in. diam., with 386D and 1528J
16015	409	" Arm.....
440F	402	" " Adjusting Screw.....
1547J	402	" " " " " Nut.....
19200	404	" " Bracket.....
7556	404	" " Lock Spring.....
176D	402	" " " " " Screw.....
1549J	402	" " " " " Nut.....
316F	402	" " Screw Centre.....
1547J	402	" " " " " Nut.....
16016	404	" Needle Guard (round).....
171F	402	" " " " " Set Screw..
16066	3653	Roller Presser complete, $1\frac{1}{2}$ in. roller, Nos. 171F, 176D, 440F, 1549J, 1918, 7556, 16015, 16016, 19200, two 316F and three 1547J.....
190D	402	Roller Presser Screw.....
386D	3659	" Screw.....
1528J	412	" " Nut.....

NO.	PLATE	NAME
2210	405	Shuttle (inside) Bobbin.....
3230	405	" " " Retaining Spring
2212	405	" " " " "
		Rivet.....
*3235	—	Shuttle (inside) Body with 398E, 2084, 3230, 3240 and two 2212.....
*16205	—	Shuttle (inside) Cover.....
2076	405	" " " Hinge Pin.....
2078	405	" " " Delivery Eye Thread Guard.....
2080	405	Shuttle (inside) Delivery Eye Thread Guard Rivet.....
3240	405	Shuttle (inside) Main Spring.....
398E	405	" " " " Screw.....
2084	405	" " " " Steady Pin..
466c	405	" " " Tension Regulating Screw
2086	405	" " " Spring.....
2090	405	" " " " Plate.....
112E	405	" " " " " Screw
16206	3668	Shuttle (inside) closed eye, complete, Nos. 112E, 466c, 2076, 2078, 2080, 2086, 2090, 2210, 3235 and 16205.....
2210	405	Shuttle (outside) Bobbin.....
3230	405	" " " Retaining Spring
2212	405	" " " " "
		Rivet.....
*3383	—	Shuttle (outside) Body with 398E, 2084, 3230, 3239 and two 2212.....
*16207	—	Shuttle (outside) Cover.....
2076	405	" " " " Hinge Pin.....
3238	405	" " " Delivery Eye Thread Guard.....
2080	405	Shuttle (outside) Delivery Eye Thread Guard Rivet.....
3239	405	Shuttle (outside) Main Spring.....
398E	405	" " " " " Screw.....
2084	405	" " " " " Steady Pin
466c	405	" " " " Tension Regulating Screw.....
3241	405	Shuttle (outside) Tension Spring.....
3242	405	" " " " " Plate
112E	405	" " " " " " "
		Screw.....
16208	3668	Shuttle (outside) closed eye, complete, Nos. 112E, 466c, 2076, 2080, 2210, 3238, 3241, 3242, 3383 and 16207.....

NO.	PLATE	NAME
16213	3664	Shuttle Driver and Feed Lifting Cam....
2049	400	" " " " " " " Pin
16166	403	Shuttle Race Body (two pieces) with either 813D, 814D or 815D.....
16103	3654	Shuttle Race Cap.....
102D	402	" " " " Screw.....
813D	402	" " " Hinge Screw, for $\frac{3}{8}$ in. to $\frac{1}{8}$ in. gauges.....
814D	402	Shuttle Race Hinge Screw, for $\frac{3}{8}$ in. to $\frac{5}{8}$ in. gauges.....
815D	402	Shuttle Race Hinge Screw, for $\frac{1}{8}$ in. to $\frac{1}{4}$ in. gauges.....
6709	400	Shuttle Race Lock Pin.....
NOTE: When ordering No. 6709, state gauge of Shuttle Race for which it is required		
16101	3653	Shuttle Race Lock Pin Bushing.....
6758	398	" " " " Spring.....
102D	402	" " " " " Screw.....
6746	403	Shuttle Race complete, for $\frac{3}{8}$ in. to $\frac{1}{4}$ in. gauges, Nos. 6709, 6758, 16166 and two 102D.....
738D	402	Shuttle Race Screw.....
6598	393	Tension Bracket.....
6599	—	Tension Bracket complete, Nos. 6598, two each 637c, 1560c, 2103 and four 2102..
190D	402	Tension Bracket Screw.....
2102	398	" Disc.....
1560c	401	" Regulating Thumb Nut.....
6600	397	" Releaser.....
6601	397	" " Bracket with two 465c
465c	402	" " " Set Screw....
207F	402	" " " Screw.....
637c	401	" Screw Stud.....
2103	400	" Spring.....
2413	398	" Thread Eyelet (double).....
330D	402	" " " Screw.....
*56831	—	Thread Take-up Cam (steel).....
3280	393	" " " 56831 with 446c...
3012	400	" " " Pin.....
446c	402	" " " Set Screw.....
*6704	393	" " Lever with 1819.....
16181	—	" " " 6704 with 76F....
76F	402	" " " Hinge Screw.....
1819	401	" " " Roller and Stud..
2410	398	" " Roller.....
86D	412	" " " Screw.....

NO.	PLATE	NAME
2411	398	Thread Take-up Roller Stud.....
175F	402	" " " " Set Screw..
6603	400	" " Spring.....
6477	398	" " " " Regulator Plate
233D	402	" " " " " "
		Adjusting Screw.....
6602	398	Thread Take-up Spring Thread Guard and Thread Eyelet.....
219D	402	Thread Take-up Spring Thread Guard and Thread Eyelet Screw.....
16151	---	Throat Plate Body.....
16152	3677	" " Needle Plate.....
228D	402	" " " " Screw.....
16153	3677	Throat Plate complete for 6677, Nos. 228D, 16151 and 16152.....
691D	412	Throat Plate Screw.....
16077	3650	Drip Pan.....

## LIST OF PARTS COMPLETE FOR MACHINE No. 18-14

DROP FEED AT RIGHT OF NEEDLE, ROLLER PRESSER.  
LEATHER

NO.	PLATE	NAME
*16029	---	Arm and Cylinder.....
16030	411	" Shaft.....
3005	393	" " Bushing.....
448C	402	" " " " Set Screw.....
144D	402	" " Screw.....
4288	411	" Side Cover (back).....
286D	401	" " " " Thumb Screw....
16106	3652	" " " (front).....
164D	412	" " " " Screw.....
12403	400	" Spool Pin and Thread Eyelet.....
8879	412	" " " Washer (cloth).....
4370	391	Balance Wheel, heavy rim, 2 $\frac{3}{4}$ in. pulley, with two 448c.....
4388	3655	Balance Wheel (power) light rim, 2 $\frac{3}{4}$ in. pulley, with two 448c.....
2862	391	Balance Wheel (stand) heavy rim, 3 in. pulley, for 3022.....
448C	402	Balance Wheel Set Screw.....
256D	392	Clamp Stop Motion Clamp Screw.....
248A	402	" " " " Stop Screw..
2020	392	" " " " Washer.....
*3023	---	" " " Flanged Bushing....
4933	392	" " " " " 3023 with two 462c.....
2022	400	Clamp Stop Motion Flanged Bushing Pin
462C	412	" " " " " Set Screw.....
3022	---	Clamp Stop Motion complete, Nos. 248A, 256J, 2020 and 4933.....
6799	390	Cloth Plate.....
16142	3655	" " Bracket with 1107c.....
1107C	412	" " " Set Screw.....
389F	401	" " Screw.....
6456	390	" " Slide.....
3286	397	" " Spring.....
725J	412	" " " " Screw.....



NO.	PLATE	NAME
6455	390	Cloth Plate complete, Nos. 3286, 6456, 6799 and two 725J.....
6454	—	Cloth Plate with Bracket complete, Nos. 6455, 16142 and two 389F.....
4292	391	Crank Connecting Rod with 4349 and two 145E.....
*4349	—	Crank Connecting Rod Cap.....
145E	3669	" " " " Screw.....
375c	402	" " " " Hinge Screw.....
1518E	401	" " " " " Nut
16045	412	Cylinder Oil Tube for oiling 16039.....
16036	411	" Side Cover.....
286D	401	" " " " Thumb Screw.....
3032	393	Feed Cam with 446c.....
446c	402	" " Set Screw.....
3033	397	" Connecting Link.....
375c	402	" " " " Hinge Screw.....
1518E	401	" " " " " Nut
6457	396	" Dog.....
6458	397	" " Carrier.....
231c	412	" " Screw.....
3037	391	" Forked Connection.....
375c	402	" " " " Hinge Screw....
1518E	401	" " " " " Nut
6459	393	" Regulator.....
58E	402	" " Hinge Screw.....
818D	401	" " Thumb Screw.....
16037	411	" Rock Shaft.....
6018	392	" " " Crank with 207F.....
156F	402	" " " " Position Screw...
207F	402	" " " " Set Screw.....
6061	393	Needle Bar.....
*3045	3669	" " Connecting Link.....
16220	—	" " " " 3045 with 377c, 1518E and 6487.....
377c	402	Needle Bar Connecting Link Hinge Screw
1518E	401	" " " " " " " Nut.....
6487	397	Needle Bar Connecting Stud with 155c....
155c	402	" " " " Set Screw....
290E	402	" " Screw Bushing.....
2053	400	" " Thread Guard.....
233D	400	" " " " Screw.....
2167	400	" Clamp with 196F.....
196F	402	" " Screw.....
*6461	392	Oscillating Rock Shaft (steel) with 4784

NO.	PLATE	NAME
16176	—	Oscillating Rock Shaft complete, Nos. 6461 and 16212.....
6489	392	Oscillating Rock Shaft Hinge Pin.....
16212	—	" " " " " 6489 with 1513J.....
1513J	401	Oscillating Rock Shaft Hinge Pin Nut...
4784	412	" " " Oil Pad.....
16039	411	" Shaft.....
*6056	—	" " Crank with 460c and 1813.....
6024	397	Oscillating Shaft Crank with 1813 and two 462c.....
2040	400	Oscillating Shaft Crank Pin.....
1813	401	" " " Roller and Stud..
462c	412	" " " Set Screw for 6024
460c	402	" " " " " " 6056
3054	393	Presser Bar.....
6464	393	" " Lifter.....
77J	412	" " " Screw.....
6465	398	" " " Washer.....
16194	3664	" " Lifting Bracket with 175J and two 457K.....
16195	—	Presser Bar Lifting Bracket 16194 with 16196 and two 335J.....
175J	402	Presser Bar Lifting Bracket Adjusting Screw.....
6469	397	Presser Bar Lifting Bracket Guide.....
175J	402	" " " " " Screw
457K	402	" " " " Set Screw...
16196	3664	" " " " Wearing Plate.....
335J	3657	Presser Bar Lifting Bracket Wearing Plate Screw.....
290E	402	Presser Bar Screw Bushing.....
5459	410	" " Spring (light) .047 wire.....
6466	393	" " " (medium) .055 wire..
6467	410	" " " (heavy) .063 wire.....
2070	398	" " " Washer.....
6069	396	" Foot.....
190D	402	" " Screw.....
262J	401	Pressure Regulating Thumb Screw.....
1868	399	Roller, 1/8 in. diam., coarse, with 652D and 1528J, for 6070.....
1841	3659	Roller, 1/8 in. diam., fine, with 652D and 1528J, for 6071.....



**LIST OF PARTS COMPLETE  
FOR  
MACHINE No. 18-15**

**FOR LEATHER. HAS DROP FEED AT LEFT OF NEEDLE,  
ROLLER PRESSER**

NO.	PLATE	NAME
*16173	—	Arm and Cylinder.....
16030	411	" Shaft.....
3005	393	" " Bushing.....
448c	402	" " " Set Screw.....
144d	402	" " " Screw.....
4288	411	" Side Cover (back).....
286d	401	" " " Thumb Screw....
16106	3652	" " " (front).....
164d	412	" " " " Screw.....
12403	400	" Spool Pin and Thread Eyelet.....
8879	412	" " " Washer (cloth).....
4370	391	Balance Wheel, heavy rim, 2¾ in. pulley, with two 448c.....
4388	3655	Balance Wheel (power) light rim, 2¾ in. pulley, with two 448c.....
2862	391	Balance Wheel (stand) heavy rim, 3 in. pulley, for 3022.....
448c	402	Balance Wheel Set Screw.....
256j	392	Clamp Stop Motion Clamp Screw.....
248A	402	" " " " Stop Screw...
2020	392	" " " " Washer.....
*3023	—	" " " " Flanged Bushing....
4933	392	" " " " " 3023 with two 462c.....
2022	400	Clamp Stop Motion Flanged Bushing Pin
462c	412	" " " " " " Set Screw.....
3022	—	Clamp Stop Motion complete, Nos. 248A, 256j, 2020 and 4933.....
16032	390	Cloth Plate.....
16143	3655	" " Bracket with 1107c.....
1107c	412	" " " " Set Screw.....
389F	401	" " " Screw.....
16034	390	" " Slide.....
3286	397	" " " Spring.....
725J	412	" " " " Screw.....

## PARTS FOR MACHINE No. 18-15

NO.	PLATE	NAME
6479	390	Cloth Plate complete, Nos. 3286, 16032, 16034 and two 725J.....
6478	—	Cloth Plate with Bracket complete, Nos. 6479, 16143 and two 389F.....
4292	391	Crank Connecting Rod with 4349 and two 145E.....
*4349	—	Crank Connecting Rod Cap.....
145E	3669	" " " " Screw.....
375c	402	" " " " Hinge Screw....
1518E	401	" " " " " " Nut.
16045	412	Cylinder Oil Tube for oiling 16039.....
16036	411	" Side Cover.....
286d	401	" " " Thumb Screw.....
3032	393	Feed Cam with 446c.....
446c	402	" " Set Screw.....
3033	397	" Connecting Link.....
375c	402	" " " " Hinge Screw....
1518E	401	" " " " " " Nut.
16107	3676	" Dog, 10 teeth (16 teeth to the inch)

NOTE: No. 16107 is sent with this machine unless  
another Feed Dog is specified on order

16172	3676	Feed Dog, 13 teeth (22 teeth to the inch)
16078	3675	" " " " " " " " " " " "
6458	397	" " Carrier.....
231c	412	" " Screw.....
3037	391	" Forked Connection.....
375c	402	" " " " Hinge Screw....
1518E	401	" " " " " " Nut
6459	393	" Regulator.....
58E	402	" " Hinge Screw.....
818d	401	" " Thumb Screw.....
16037	411	" Rock Shaft.....
6018	392	" " " Crank with 207F.....
156F	402	" " " " Position Screw..
207F	402	" " " " Set Screw.....
16038	3651	Needle Bar.....
*3045	3669	" " Connecting Link.....
16220	—	" " " " " 3045 with 377c, 1518E and 6487.....
377c	402	Needle Bar Connecting Link Hinge Screw
1518E	401	" " " " " " " " " " " "
		Nut.....
6487	397	Needle Bar Connecting Stud with 155c..
155c	402	" " " " Set Screw..
290E	402	" " Screw Bushing.....
4302	400	" " Thread Guide.....

NO.	PLATE	NAME
233D	402	Needle Bar Thread Guide Screw.....
4303	400	" Clamp with 808F.....
808F	402	" " Screw.....
6461	392	Oscillating Rock Shaft (steel) with 4784
16176	—	Oscillating Rock Shaft complete, Nos. 6461 and 16212.....
6489	392	Oscillating Rock Shaft Hinge Pin.....
16212	—	" " " " " 6 4 8 9 with 1513J.....
1513J	401	Oscillating Rock Shaft Hinge Pin Nut... ..
4784	412	" " " Oil Pad.....
16039	411	" Shaft.....
*6056	—	" Crank with 460c and 1813.....
6024	397	Oscillating Shaft Crank with 1813 and two 462c.....
2049	400	Oscillating Shaft Crank Pin.....
1813	401	" " " Roller and Stud.
462c	412	" " " Set Screw for 6024
460c	402	" " " " " " 6056
3054	393	Presser Bar.....
6464	393	" " Lifter.....
77J	412	" " " Screw.....
6465	398	" " " Washer.....
16194	3664	" " Lifting Bracket with 175J and two 457K.....
16195	—	Presser Bar Lifting Bracket 16194 with 16196 and two 335J.....
175J	402	Presser Bar Lifting Bracket Adjusting Screw.....
6469	397	Presser Bar Lifting Bracket Guide.....
175J	402	" " " " " Screw
457K	402	" " " " " Set Screw...
16196	3664	" " " " " Wearing Plate.....
335J	3657	Presser Bar Lifting Bracket Wearing Plate Screw.....
290E	402	Presser Bar Screw Bushing.....
5459	410	" " Spring (light) .047 wire.....
6466	393	" " " (medium) .055 wire..
6467	410	" " " (heavy) .063 wire.....
2070	398	" " " Washer.....
2180	396	" Foot.....
190D	402	" " Screw.....
262J	401	Pressure Regulating Thumb Screw.....
1868	399	Roller, $\frac{7}{8}$ in. diam., coarse, with 652D and 1528J, for 2196.....

NO.	PLATE	NAME
1841	3659	Roller, $\frac{7}{8}$ in. diam., fine, with 652D and 1528J, for 2197.....
1839	3659	Roller, $1\frac{1}{4}$ in. diam., coarse, with 386D and 1528J, for 16099.....
1869	3659	Roller, $1\frac{1}{4}$ in. diam., fine, with 386D and 1528J, for 16100.....
1897	3666	Roller, $1\frac{1}{4}$ in. diam., coarse, with 386D and 1528J, for 16225.....
1898	—	Roller, $1\frac{1}{4}$ in. diam., fine, with 386D and 1528J, for 16226.....
1923	3666	Roller, $1\frac{1}{4}$ in. diam., coarse, with 652D and 1528J, for 16228.....
51832	—	Roller, $1\frac{1}{4}$ in. diam., coarse, for 51833...
51833	3665	" (ball bearing) $1\frac{1}{4}$ in. coarse roller, $\frac{3}{4}$ in. face, Nos. 1528J, 1766c, 50553c, 51832 and twenty-four 16232, for 16233
51841	—	Roller, $1\frac{1}{4}$ in. diam., coarse, for 51842...
51842	3665	" (ball bearing) $1\frac{1}{4}$ in. coarse roller, $\frac{3}{4}$ in. face, Nos. 1528J, 1766c, 50553c, 51841 and twenty-four 16232, for 16236
2203	399	Roller Arm for 2196 and 2197.....
16098	3653	" " " 16099, 16100, 16225, 16226 and 16228.....
16230	3665	Roller Arm for 16233 and 16236.....
440F	402	" " Adjusting Screw.....
1547J	402	" " " " Nut.....
2206	399	" " Bracket for 2196 and 2197...
4282	3659	" " " " 16099, 16100, 16225, 16226, 16228, 16233 and 16236
2205	399	Roller Arm Lock Spring.....
176D	402	" " " " Screw.....
1549J	402	" " " " " Nut.....
316F	402	" " Screw Centre.....
1547J	402	" " " " Nut.....
16232	3665	" Ball, size $\frac{3}{4}$ in.....
1766c	3665	" " Retaining Nut.....
2196	399	Roller Presser complete, $\frac{7}{8}$ in. coarse roller, Nos. 176D, 440F, 1549J, 1868, 2203, 2205, 2206, two 316F and three 1547J.....
2197	—	Roller Presser complete, $\frac{7}{8}$ in. fine roller, Nos. 176D, 440F, 1549J, 1841, 2203, 2205, 2206, two 316F and three 1547J
16099	3658	Roller Presser complete, $1\frac{1}{4}$ in. coarse roller, Nos. 176D, 440F, 1549J, 1839, 2205, 4282, 16098, two 316F and three 1547J.....

NO.	PLATE	NAME
16100	—	Roller Presser complete, 1¼ in. fine roller, Nos. 176D, 440F, 1549J, 1869, 2205, 4282, 16098, two 316F and three 1547J
16225	3666	Roller Presser complete, 1¼ in. coarse roller, Nos. 176D, 440F, 1549J, 1897, 2205, 4282, 16098, two 316F and three 1547J
16226	—	Roller Presser complete, 1¼ in. fine roller, Nos. 176D, 440F, 1549J, 1898, 2205, 4282, 16098, two 316F and three 1547J
16228	3666	Roller Presser complete, 1¼ in. coarse roller, Nos. 176D, 440F, 1549J, 1923, 2205, 4282, 16098, two 316F and three 1547J
16233	3665	Roller Presser (ball bearing) complete, 1¼ in. coarse roller, ⅜ in. face, Nos. 176D, 440F, 1549J, 2205, 4282, 16230, 51833, two 316F and three 1547J
16236	3665	Roller Presser (ball bearing) complete, 1¼ in. coarse roller, ⅜ in. face, Nos. 176D, 440F, 1549J, 2205, 4282, 16230, 51842, two 316F and three 1547J
190D	402	Roller Presser Screw
652D	3658	" Screw for 1841, 1868 and 1923
386D	3659	" " " 1839, 1869, 1897 and 1898
50553C	3665	Roller Screw for 51833 and 51842
1528J	412	" " Nut
2073	217	Shuttle Bobbin
2211	217	" " Retaining Spring
2212	217	" " " " Rivet
*6058	—	Shuttle Body with 398E, 2082, 2084, 2211 and two 2212
*2075	—	Shuttle Cover
*44001	—	" " 2075 with 112E, 466C, 2078, 2080, 2086 and 2090
2076	217	Shuttle Cover Hinge Pin
2078	217	" Delivery Eye Thread Guard
2080	217	" " " " Rivet
2082	217	" Main Spring
398E	217	" " " Screw
2084	217	" " " Steady Pin
466C	217	" Tension Regulating Screw
2086	217	" " Spring
2090	217	" " " Plate
112E	217	" " " " Screw

NO.	PLATE	NAME
6028	217	Shuttle (high point) complete, Nos. 2073, 2076, 6058 and 44001
16175	3664	Shuttle Driver and Feed Lifting Cam
2049	400	" " " " " " Pin
16174	3664	" Race (steel)
16227	—	" " 16174 with 6471 and two 102D
6800	403	Shuttle Race Cap
6471	—	Shuttle Race Cap complete, Nos. 6472, 6800 and two 725J
6472	398	Shuttle Race Cap Latch
725J	412	" " " " Screw
102D	402	" " " " Screw
50037D	3664	" " " Screw
2102	398	Tension Disc
1560C	401	" Regulating Thumb Nut
600C	3654	" Screw Stud
16202	—	" " " 600C with 1560C
175D	402	" " " Set Screw
2103	400	" Spring
16022	398	" Thread Guard
219D	402	" " " " Screw
16204	—	Tension complete, Nos. 2103, 16202 and two 2102
2112	400	Thread Retaining Disc with 2113
2113	400	" " " Steady Pin
2114	400	" " Spring
2115	400	" " Stud
460C	402	" " " Set Screw
2111	400	Thread Retainer Guide complete, Nos. 2112, 2114 and 2115
*56831	—	Thread Take-up Cam (steel)
3280	393	" " " 56831 with 446C
3012	400	" " " Pin
446C	402	" " " Set Screw
*16041	412	" " " Lever with 1547J and 1915
16179	—	Thread Take-up Lever 16041 with 76F
76F	402	" " " Hinge Screw
1915	3654	" " " Roller and Screw Stud
1547J	402	Thread Take-up Lever Roller and Screw Stud Nut
6768	400	Thread Take-up Spring
6477	398	" " " Regulator Plate
233D	402	" " " " " " Adjusting Screw

NO.	PLATE	NAME
16095	3676	Throat Plate (fluted) needle hole drilled for No. 1 needle to locate close to the side nearest the feedway, for 16107 and 16172.....
NOTE: No. 16095 is sent with this machine unless another Throat Plate is specified on order		
16096	3675	Throat Plate (not fluted) needle hole drilled for No. 2 needle to locate close to the side nearest the feedway, for 16078.....
16131	3675	Throat Plate (fluted) needle hole drilled for No. 2 needle to locate close to the side nearest the feedway, for 16078....
6492	396	Throat Plate (fluted) large needle hole, for 16078.....
16097	—	Throat Plate (fluted) small needle hole, for 16078.....
16040	412	Throat Plate for 16078.....
399D	402	" " Screw.....
16077	3650	Drip Pan.....

## LIST OF PARTS COMPLETE

FOR

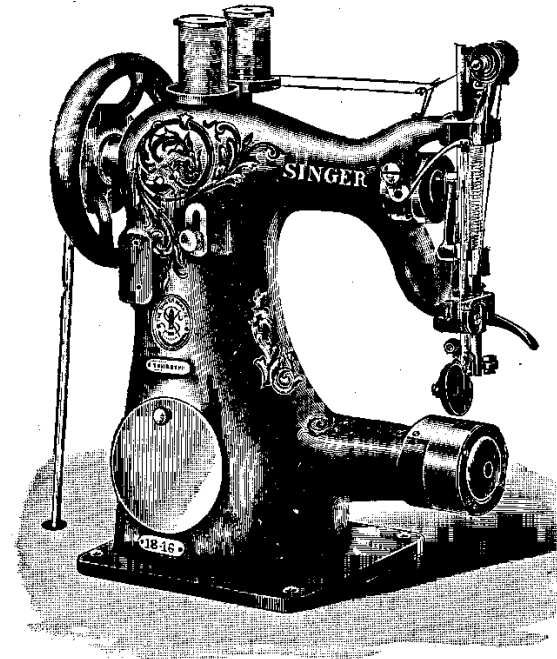

## MACHINE No. 18-16

FOR VAMPING SHOES AND OTHER WORK IN LEATHER.  
TWO NEEDLES, LONG BEAK SHUTTLES,  $\frac{1}{2}$  INCH TO  $\frac{1}{4}$   
INCH GAUGES. DROP FEED, ROLLER PRESSER.

NO.	PLATE	NAME
*16074	—	Arm and Cylinder.....
16030	411	" Shaft.....
3005	393	" " Bushing.....
448C	402	" " " Set Screw.....
144D	402	" " Screw.....

NO.	PLATE	NAME
4288	411	Arm Side Cover (back).....
286D	401	" " " " Thumb Screw...
16106	3652	" " " (front).....
164D	412	" " " " Screw.....
2415	393	" Spool Bracket.....
15063	393	" " " 2415 with two 12403
145D	412	" " " " Screw.....
12403	400	" " " Spool Pin and Thread
		Eyelet.....
11241	392	Arm Spool Bracket Spool Pin Washer
		(cloth).....
4370	391	Balance Wheel, heavy rim, 2¾ in. pulley,
		with two 448c.....
4388	3655	Balance Wheel (power) light rim, 2¾ in.
		pulley, with two 448c.....
2862	391	Balance Wheel (stand) heavy rim, 3 in.
		pulley, for 3022.....
448c	402	Balance Wheel Set Screw.....
256J	392	Clamp Stop Motion Clamp Screw.....
248A	402	" " " " Stop Screw..
2020	392	" " " " Washer.....
*3023	—	" " " Flanged Bushing...
4933	392	" " " " " 3023
		with two 462c.....
2022	400	Clamp Stop Motion Flanged Bushing Pin
462c	412	" " " " " Set
		Screw.....
3022	—	Clamp Stop Motion complete, Nos. 248A,
		256J, 2020 and 4933.....
6716	394	Cloth Plate.....
6719	394	" " Bracket with 345c.....
345c	401	" " " " Set Screw.....
389F	401	" " " Screw.....
6718	394	" " Slide.....
3286	397	" " " Spring.....
725J	412	" " " " Screw.....
6717	394	Cloth Plate complete, Nos. 3286, 6716,
		6718 and two 725J.....
6702	—	Cloth Plate with Bracket complete, Nos.
		6717, 6719 and two 389F.....
4292	391	Crank Connecting Rod with 4349 and
		two 145E.....
*4349	—	Crank Connecting Rod Cap.....
145E	3669	" " " " " Screw.....
375c	402	" " " " Hinge Screw.....
1518E	401	" " " " " Nut

NO.	PLATE	NAME
16045	412	Cylinder Oil Tube for oiling 16114.....
16036	411	" Side Cover.....
286D	401	" " " Thumb Screw.....
3032	393	Feed Cam with 446c.....
446c	402	" " Set Screw.....
3033	397	" Connecting Link.....
375c	402	" " " Hinge Screw.....
1518E	401	" " " " " Nut.
16018	396	" Dog, for ½ in. to ¾ in. gauges.....
6677	396	" " " ¾ in. to ¼ in. gauges.....
6458	397	" " Carrier.....
231c	412	" " Screw.....
3037	391	" Forked Connection.....
375c	402	" " " Hinge Screw....
1518E	401	" " " " " Nut
6459	393	" Regulator.....
58E	402	" " Hinge Screw.....
818D	401	" " Thumb Screw.....
16075	3651	" Rock Shaft.....
6018	392	" " " Crank with 207F.....
156F	402	" " " " Position Screw..
207F	402	" " " " Set Screw.....
4344	393	Needle Bar.....
16178	—	" " 4344 with 2273 and 4345.....
16182	—	" " " " " 6524.....
*3045	3669	" " Connecting Link.....
16220	—	" " " " 3045 with
		377c, 1518E and 6487.....
377c	402	Needle Bar Connecting Link Hinge Screw
1518E	401	" " " " " " "
		Nut.....
6487	397	Needle Bar Connecting Stud with 155c..
155c	402	" " " " " Set Screw..
3214	3654	" " Guide with 400c and 453c...
400c	3654	" " " Adjusting Screw.....
453c	3654	" " " Set Screw.....
290E	402	" " Screw Bushing.....
4345	400	" Clamp with two 336F, for ½ in.
		to ¾ in. gauges.....
6524	400	Needle Clamp with two 50014F, for ¾ in.
		to ¼ in. gauges.....
2273	400	Needle Clamp Pin.....
336F	402	" Set Screw for 4345.....
50014F	3654	" " " " 6524.....
*16111	3652	Oscillating Rock Shaft.....
16112	—	Oscillating Rock Shaft complete, Nos.
		4784, 16111 and 16212.....

NO.	PLATE	NAME
6489	392	Oscillating Rock Shaft Hinge Pin.....
16212	—	“ “ “ “ “ 6489 with 1513J.....
1513J	401	Oscillating Rock Shaft Hinge Pin Nut....
4784	412	“ “ “ Oil Pad.....
16114	3652	“ Shaft.....
16115	—	“ “ Crank for 16116.....
*16192	—	“ “ “ “ 16193.....
16116	3654	Oscillating Shaft Crank complete, Nos. 1518E, 16115, 19390 and two 462C....
*16193	—	Oscillating Shaft Crank complete, Nos. 462C, 1518E, 16192 and 19390.....
2049	400	Oscillating Shaft Crank Pin.....
462C	412	“ “ “ Set Screw.....
19389	3654	“ “ “ Slide Block.....
226D	3669	“ “ “ “ “ Cap Screw.....
12424	3654	Oscillating Shaft Crank Slide Block Cap Screw Washer.....
969C	3654	Oscillating Shaft Crank Slide Block Screw Stud.....
1518E	3654	Oscillating Shaft Crank Slide Block Screw Stud Nut.....
19390	3654	Oscillating Shaft Crank Slide Block com- plete, Nos. 226D, 969C, 12424 and 19389
16145	3656	Presser Bar (hollow).....
6464	393	“ “ Lifter.....
77F	412	“ “ “ Screw.....
6465	398	“ “ “ Washer.....
16197	3664	“ “ Lifting Bracket with 175J and two 457K.....
16198	—	Presser Bar Lifting Bracket 16197 with 16196 and two 335J.....
175J	402	Presser Bar Lifting Bracket Adjusting Screw.....
6469	397	Presser Bar Lifting Bracket Guide.....
175J	402	“ “ “ “ “ Screw
457K	402	“ “ “ “ “ Set Screw...
16196	3664	“ “ “ “ “ Wearing Plate.....
335J	3657	Presser Bar Lifting Bracket Wearing Plate Screw.....
921E	3657	Presser Bar Screw Bushing.....
16156	3656	“ “ Spring (light) .055 wire.....
16147	3656	“ “ “ (heavy) .063 wire....
11170	3657	“ “ “ Washer.....
16148	3657	“ “ Stop Collar with 1019C.....

NO.	PLATE	NAME
1019C	3657	Presser Bar Stop Collar Set Screw.....
688J	3657	Pressure Regulating Thumb Screw.....
1958	409	Roller, 1½ in. diam., with 1261D and 1528J, for 16071 and 16082.....
1875	404	Roller, 1½ in. diam., with 634D and 1528J, for 16014 and 16017.....
51834	—	Roller, 1½ in. diam., coarse, for 51835...
51835	3666	Roller (ball bearing) 1½ in. coarse roller, Nos. 1528J, 1766C, 50553C, 51834 and twenty-four 16232, for 16234 and 16235
16015	409	Roller Arm for 16017 and 16071.....
6535	404	“ “ “ 16014 and 16082.....
16231	3665	“ “ “ 16234 and 16235.....
440F	402	“ “ Adjusting Screw.....
1547J	402	“ “ “ “ Nut.....
19200	404	“ “ Bracket for 16017, 16071 and 16235.....
4785	3659	Roller Arm Bracket for 16014, 16082 and 16234.....
7556	404	Roller Arm Lock Spring.....
176D	402	“ “ “ “ “ Screw.....
1549J	402	“ “ “ “ “ Nut.....
316F	402	“ “ Screw Centre.....
1547J	402	“ “ “ “ “ Nut.....
16232	3665	“ Ball, size ⅜ in.....
1766C	3665	“ “ Retaining Nut.....
16080	409	“ Needle Guard (flat) for 16082 and 16234.....
16010	404	Roller Needle Guard (flat) for 16014....
207F	402	“ “ “ “ “ Screw.....
16016	404	“ “ “ (round) for 16017, 16071 and 16235.....
16013	404	Roller Needle Guard (round) for 16014
16081	409	“ “ “ “ “ 16082 and 16234.....
16138	3659	Roller Needle Guard (round) with 242D and 16139, for 16014.....
16139	3659	Roller Needle Guard (round) Edge Guide for 16138.....
242D	3659	Roller Needle Guard (round) Edge Guide Screw.....
171F	402	Roller Needle Guard (round) Set Screw..
16082	409	Roller Presser complete, 1½ in. roller, ⅜ in. face, for ⅜ in. to ⅜ in. gauges, Nos. 171F, 176D, 207F, 440F, 1549J, 1958, 4785, 6535, 7556, 16080, 16081, two 316F and three 1547J.....



NO.	PLATE	NAME
16014	404	Roller Presser complete, 1½ in. roller, ⅜ in. face, for ⅜ in. to ⅛ in. gauges, Nos. 171F, 176D, 207F, 440F, 1549J, 1875, 4785, 6535, 7556, 16010, 16013, two 316F and three 1547J.....
16071	409	Roller Presser complete, 1½ in. roller, ⅜ in. face, for ⅜ in. to ¼ in. gauges, Nos. 171F, 176D, 440F, 1549J, 1958, 7556, 16015, 16016, 19200, two 316F and three 1547J.....
16017	404	Roller Presser complete, 1½ in. roller, ⅜ in. face, for ⅜ in. to ¼ in. gauges, Nos. 171F, 176D, 440F, 1549J, 1875, 7556, 16015, 16016, 19200, two 316F and three 1547J.....
16234	3666	Roller Presser (ball bearing) complete, 1½ in. roller, ⅜ in. face, for ⅜ in. to ¼ in. gauges, Nos. 171F, 176D, 207F, 440F, 1549J, 4785, 7556, 16080, 16081, 16231, 51835, two 316F and three 1547J.....
16235	—	Roller Presser (ball bearing) complete, 1½ in. roller, ⅜ in. face, for ⅜ in. to ¼ in. gauges, Nos. 171F, 176D, 440F, 1549J, 7556, 16016, 16231, 19200, 51835, two 316F and three 1547J.....
190D	402	Roller Presser Screw.....
634D	412	" Screw for 1875.....
1261D	3658	" " " 1958.....
50553c	3665	" " " 51835.....
1528J	412	" " Nut.....
2210	405	Shuttle (inside) Bobbin.....
3230	405	" " " Retaining Spring
2212	405	" " " " "
		Rivet.....
*3235	—	Shuttle (inside) Body with 398E, 2084, 3230, 3240 and two 2212.....
16205	—	Shuttle (inside) Cover.....
2076	405	" " " Hinge Pin.....
2078	405	" " Delivery Eye Thread Guard.....
2080	405	Shuttle (inside) Delivery Eye Thread Guard Rivet.....
3240	405	Shuttle (inside) Main Spring.....
398E	405	" " " " Screw.....
2084	405	" " " " Steady Pin
466c	405	" " Tension Regulating Screw
2086	405	" " " Spring.....

NO.	PLATE	NAME
2090	405	Shuttle (inside) Tension Spring Plate....
112E	405	" " " " " Screw
16206	3668	Shuttle (inside) closed eye, complete, for ⅜ in. to ¼ in. gauges, Nos. 112E, 466c, 2076, 2078, 2080, 2086, 2090, 2210, 3235 and 16205.....
2210	405	Shuttle (outside) Bobbin.....
3230	405	" " " Retaining Spring
2212	405	" " " " "
		Rivet.....
*3232	—	Shuttle (outside) Body with 398E, 2084, 3230, 3239 and two 2212, for 6913.....
*3383	—	Shuttle (outside) Body with 398E, 2084, 3230, 3239 and two 2212, for 6909.....
*16207	—	Shuttle (outside) Cover.....
2076	405	" " " Hinge Pin.....
3238	405	" " Delivery Eye Thread Guard.....
2080	405	Shuttle (outside) Delivery Eye Thread Guard Rivet.....
3239	405	Shuttle (outside) Main Spring.....
398E	405	" " " " Screw.....
2084	405	" " " " Steady Pin
466c	405	" " Tension Regulating Screw.....
3241	405	Shuttle (outside) Tension Spring.....
3242	405	" " " " Plate
112E	405	" " " " " Screw.....
16209	3668	Shuttle (outside) closed eye, complete, for ⅜ in. to ¼ in. gauges, Nos. 112E, 466c, 2076, 2080, 2210, 3232, 3238, 3241, 3242 and 16207.....
16208	3668	Shuttle (outside) closed eye, complete, for ⅜ in. to ¼ in. gauges, Nos. 112E, 466c, 2076, 2080, 2210, 3238, 3241, 3242, 3383 and 16207.....
16213	3664	Shuttle Driver and Feed Lifting Cam....
2049	400	" " " " " Pin
16166	403	" Race Body (two pieces) with either 813D, 814D or 815D, for 6746.....
16238	3668	Shuttle Race Body (two pieces) with either 813D, 814D or 815D, for 16239.....
16103	3654	Shuttle Race Cap.....
102D	402	" " " Screw.....
813D	402	" " Hinge Screw, for ⅜ in. to ¼ in. gauges.....

NO.	PLATE	NAME
814D	402	Shuttle Race Hinge Screw, for $\frac{3}{8}$ in. to $\frac{1}{2}$ in. gauges.....
815D	402	Shuttle Race Hinge Screw, for $\frac{1}{8}$ in. to $\frac{1}{4}$ in. gauges.....
6709	400	Shuttle Race Lock Pin.....
NOTE: When ordering No. 6709, state gauge of Shuttle Race for which it is required		
16101	3653	Shuttle Race Lock Pin Bushing.....
6758	398	" " " " Spring.....
102D	402	" " " " Screw.....
6746	403	Shuttle Race complete, for $\frac{3}{8}$ in. to $\frac{1}{4}$ in. gauges, Nos. 6709, 6758, 16166 and two 102D.....
16239	3668	Shuttle Race complete, for $\frac{1}{2}$ to $\frac{5}{8}$ in. gauges, Nos. 6709, 6758, 16238 and two 102D.....
738D	402	Shuttle Race Screw.....
16136	3651	Tension and Needle Bar Guide Bracket..
16137	—	Tension and Needle Bar Guide Bracket complete, Nos. 16136, two each 637c, 1560c, 2103 and four 2102.....
190D	402	Tension and Needle Bar Guide Bracket Screw.....
2102	398	Tension Disc.....
1560c	401	" Regulating Thumb Nut.....
6600	397	" Releaser.....
16149	3657	" " Bracket with two 465c
465c	402	" " Set Screw.....
207F	402	" " Screw.....
637c	401	" Screw Stud.....
2103	400	" Spring.....
2413	398	" Thread Eyelet (double).....
330D	402	" " " Screw.....
*56831	—	Thread Take-up Cam (steel).....
3280	393	" " " 56831 with 446c...
3012	400	" " " Pin.....
446c	402	" " " Set Screw.....
*6704	393	" " Lever with 1819.....
16181	—	" " " 6704 with 76F....
76F	402	" " " Hinge Screw.....
1819	401	" " " Roller and Stud..
2410	398	" " Roller.....
86D	412	" " " Screw.....
2411	398	" " " Stud.....
175F	402	" " " Set Screw..
6603	400	" " Spring.....

NO.	PLATE	NAME
6477	398	Thread Take-up Spring Regulator Plate
233D	402	" " " " " "
		Adjusting Screw.....
6602	398	Thread Take-up Spring Thread Guard and Thread Eyelet.....
219D	402	Thread Take-up Spring Thread Guard and Thread Eyelet Screw.....
16151	—	Throat Plate Body.....
16152	3677	" " Needle Plate.....
228D	402	" " " " Screw.....
16153	3677	Throat Plate complete for 16018 for $\frac{1}{8}$ in. to $\frac{5}{8}$ in. gauges, and for 6677 for $\frac{3}{8}$ in. to $\frac{1}{4}$ in. gauges, Nos. 228D, 16151 and 16152.....
691D	412	Throat Plate Screw.....
16077	3650	Drip Pan.....

**LIST OF PARTS COMPLETE  
FOR  
MACHINE No. 18-17**

**FOR LEATHER. HAS WHEEL FEED AT LEFT OF NEEDLE.  
ROLLER PRESSER**

NO.	PLATE	NAME
*16123	—	Arm and Cylinder.....
16030	411	" Shaft.....
3005	393	" " Bushing.....
448c	402	" " " Set Screw.....
144d	402	" " " Screw.....
4288	411	" " Side Cover (back).....
286d	401	" " " Thumb Screw....
16106	3652	" " " (front).....
164d	412	" " " " Screw.....
12403	400	" " Spool Pin and Thread Eyelet.....
8879	412	" " " Washer (cloth).....
4370	391	Balance Wheel, heavy rim, 2¾ in. pulley, with two 448c.....
4388	3655	Balance Wheel (power) light rim, 2¾ in. pulley, with two 448c.....
2362	391	Balance Wheel (stand) heavy rim, 3 in. pulley, for 3022.....
448c	402	Balance Wheel Set Screw.....
256j	392	Clamp Stop Motion Clamp Screw.....
248A	402	" " " " Stop Screw..
2020	392	" " " " Washer.....
*3023	—	" " " " Flanged Bushing....
4933	392	" " " " " 3023 with two 462c.....
2022	400	Clamp Stop Motion Flanged Bushing Pin
462c	412	" " " " " " Set Screw.....
3022	—	Clamp Stop Motion complete, Nos. 248A, 256j, 2020 and 4933.....
6786	390	Cloth Plate.....
6083	390	" " Bracket with two 345c.....
345c	401	" " " Set Screw.....
389F	401	" " " Screw.....
6496	390	" " Slide.....
3286	397	" " " Spring.....
725j	412	" " " " Screw.....

NO.	PLATE	NAME
6495	390	Cloth Plate complete, Nos. 3286, 6496, 6786 and two 725j.....
6494	—	Cloth Plate with Bracket complete, Nos. 6083, 6495 and two 389F.....
4292	391	Crank Connecting Rod with 4349 and two 145E.....
*4349	—	Crank Connecting Rod Cap.....
145E	3669	" " " " Screw.....
375c	402	" " " " Hinge Screw.....
1518E	401	" " " " " Nut
16045	412	Cylinder Oil Tube for oiling 16169.....
16036	411	" Side Cover.....
286d	401	" " " Thumb Screw.....
3033	397	Feed Connecting Link.....
375c	402	" " " Hinge Screw.....
1518E	401	" " " " " Nut.
3074	393	" Eccentric with 446c.....
448c	402	" " Set Screw.....
3037	391	" Forked Connection.....
375c	402	" " " Hinge Screw....
1518E	401	" " " " " Nut
6459	393	" Regulator.....
58E	402	" " Hinge Screw.....
818d	401	" " Thumb Screw.....
16104	3651	" Rock Shaft.....
6018	392	" " " Crank with 207F.....
156F	402	" " " " Position Screw..
207F	402	" " " " Set Screw.....
6497	403	" Wheel.....
6498	393	" " Driver.....
16168	400	" " " Spring.....
207F	402	" " " " Screw.....
6089	400	" " Friction Spring.....
207F	402	" " " " Screw.....
4301	393	Needle Bar.....
*3045	3669	" " Connecting Link.....
16220	—	" " " " 3045 with 377c, 1518E and 6487.....
377c	402	Needle Bar Connecting Link Hinge Screw
1518E	401	" " " " " "
		Nut.....
6487	397	Needle Bar Connecting Stud with 155c..
155c	402	" " " " Set Screw..
290E	402	" " " Screw Bushing.....
4302	400	" " Thread Guide.....
233d	402	" " " " Screw.....
4303	400	" Clamp with 808F.....

NO.	PLATE	NAME
808F	402	Needle Clamp Screw.....
*6461	392	Oscillating Rock Shaft (steel) with 4784
16176	—	Oscillating Rock Shaft complete, Nos. 6461 and 16212.....
6489	392	Oscillating Rock Shaft Hinge Pin.....
16212	—	“ “ “ “ “ 6 4 8 9 with 1513j.....
1513j	401	Oscillating Rock Shaft Hinge Pin Nut...
4784	412	“ “ “ “ Oil Pad.....
16169	3656	“ Shaft.....
*6056	—	“ “ Crank with 460c and 1813.....
6024	397	Oscillating Shaft Crank with 1813 and two 462c.....
2049	400	Oscillating Shaft Crank Pin.....
1813	401	“ “ “ Roller and Stud
462c	412	“ “ “ Set Screw for 6024
460c	402	“ “ “ “ “ “ 6056
3054	393	Presser Bar.....
6464	393	“ “ Lifter.....
77F	412	“ “ “ Screw.....
6465	398	“ “ “ Washer.....
16194	3664	“ “ Lifting Bracket with 175j and two 457k.....
16195	—	Presser Bar Lifting Bracket 16194 with 16196 and two 335j.....
175j	402	Presser Bar Lifting Bracket Adjusting Screw.....
6469	397	Presser Bar Lifting Bracket Guide.....
175j	402	“ “ “ “ “ Screw
457k	402	“ “ “ “ “ Set Screw...
16196	3664	“ “ “ “ “ Wearing Plate.....
335j	3657	Presser Bar Lifting Bracket Wearing Plate Screw.....
290E	402	Presser Bar Screw Bushing.....
5459	410	“ “ Spring (light) .047 wire.....
6466	393	“ “ “ (medium) .055 wire..
6467	410	“ “ “ (heavy) .063 wire.....
2070	398	“ “ “ Washer.....
2180	396	“ Foot.....
190D	402	“ “ Screw.....
262j	401	Pressure Regulating Thumb Screw.....
1868	399	Roller, $\frac{7}{8}$ in. diam., coarse, with 652D and 1528j, for 2196.....
1841	3659	Roller, $\frac{7}{8}$ in. diam., fine, with 652D and 1528j, for 2197.....

NO.	PLATE	NAME
1839	3659	Roller, $1\frac{1}{4}$ in. diam., coarse, with 386D and 1528j, for 16099.....
1869	3659	Roller, $1\frac{1}{4}$ in. diam., fine, with 386D and 1528j, for 16100.....
1897	3666	Roller, $1\frac{1}{4}$ in. diam., coarse, with 386D and 1528j, for 16225.....
1898	—	Roller, $1\frac{1}{4}$ in. diam., fine, with 386D and 1528j, for 16226.....
1923	3666	Roller, $1\frac{1}{4}$ in. diam., coarse, with 652D and 1528j, for 16228.....
51832	—	Roller, $1\frac{1}{4}$ in. diam., coarse, for 51833...
51833	3665	“ (ball bearing) $1\frac{1}{4}$ in. coarse roller, $\frac{7}{8}$ in. face, Nos. 1528j, 1766c, 50553c, 51832 and twenty-four 16232, for 16233
51841	—	Roller, $1\frac{1}{4}$ in. diam., coarse, for 51842
51842	3665	“ (ball bearing) $1\frac{1}{4}$ in. coarse roller, $\frac{5}{8}$ in. face, Nos. 1528j, 1766c, 50553c, 51841 and twenty-four 16232, for 16236
2203	399	Roller Arm for 2196 and 2197.....
16098	3653	“ “ “ 16099, 16100, 16225, 16226 and 16228.....
16230	3665	Roller Arm for 16233 and 16236.....
440F	402	“ “ Adjusting Screw.....
1547j	402	“ “ “ “ Nut.....
2206	399	“ “ Bracket for 2196 and 2197...
4282	3659	“ “ “ “ 16099, 16100, 16225, 16226, 16228, 16233 and 16236
2205	399	Roller Arm Lock Spring.....
176D	402	“ “ “ “ Screw.....
1549j	402	“ “ “ “ “ Nut.....
316F	402	“ “ Screw Centre.....
1547j	402	“ “ “ “ Nut.....
16232	3665	“ Ball, size $\frac{3}{8}$ in.....
1766c	3665	“ Retaining Nut.....
2196	399	Roller Presser complete, $\frac{1}{8}$ in. coarse roller, Nos. 176D, 440F, 1549j, 1868, 2203, 2205, 2206, two 316F and three 1547j.....
2197	—	Roller Presser complete, $\frac{1}{8}$ in. fine roller, Nos. 176D, 440F, 1549j, 1841, 2203, 2205, 2206, two 316F and three 1547j...
16099	3658	Roller Presser complete, $1\frac{1}{4}$ in. coarse roller, Nos. 176D, 440F, 1549j, 1839, 2205, 4282, 16098, two 316F and three 1547j.....



## LIST OF PARTS COMPLETE

FOR

## MACHINE No. 18-18

FOR LEATHER. TWO NEEDLES, LONG BEAK SHUTTLES,  
 $\frac{3}{8}$  INCH TO  $\frac{1}{8}$  INCH GAUGES. WHEEL FEED. ROLLER  
 PRESSER.

NO.	PLATE	NAME
*16124	—	Arm and Cylinder.....
16030	411	" Shaft.....
3005	393	" " Bushing.....
448C	402	" " " Set Screw.....
144D	402	" " " Screw.....
4288	411	" Side Cover (back).....
286D	401	" " " " Thumb Screw...
16106	3652	" " " (front).....
164D	412	" " " " Screw.....
2415	393	" Spool Bracket.....
15063	393	" " " 2415 with two 12403
145D	412	" " " " Screw.....
12403	400	" " " " Spool Pin and Thread Eyelet.....
11241	392	Arm Spool Bracket Spool Pin Washer (cloth).....
4370	391	Balance Wheel, heavy rim, $2\frac{3}{4}$ in. pulley, with two 448c.....
4388	3655	Balance Wheel (power) light rim, $2\frac{3}{4}$ in. pulley, with two 448c.....
2862	391	Balance Wheel (stand) heavy rim, 3 in. pulley, for 3022.....
448C	402	Balance Wheel Set Screw.....
256J	392	Clamp Stop Motion Clamp Screw.....
248A	402	" " " " Stop Screw...
2020	392	" " " " Washer.....
*3023	—	" " " " Flanged Bushing...
4933	392	" " " " " 3023 with two 462c.....
2022	400	Clamp Stop Motion Flanged Bushing Pin
462C	412	" " " " " Set Screw.....
3022	—	Clamp Stop Motion complete, Nos. 248A, 256J, 2020 and 4933.....

NO.	PLATE	NAME
6786	390	Cloth Plate.....
6083	390	" " Bracket with two 345c.....
345C	401	" " " " Set Screw.....
389F	401	" " " " Screw.....
6496	390	" " Slide.....
3286	397	" " " " Spring.....
725J	412	" " " " " Screw.....
6495	390	Cloth Plate complete, Nos. 3286, 6496, 6786 and two 725J.....
6494	—	Cloth Plate with Bracket complete, Nos. 6083, 6495 and two 389F.....
4292	391	Crank Connecting Rod with 4349 and two 145E.....
*4349	—	Crank Connecting Rod Cap.....
145E	3669	" " " " " Screw.....
375C	402	" " " " " Hinge Screw.....
1518E	401	" " " " " " Nut
16045	412	Cylinder Oil Tube, for oiling 16114.....
16036	411	" Side Cover.....
286D	401	" " " " Thumb Screw.....
3033	397	Feed Connecting Link.....
375C	402	" " " " " Hinge Screw.....
1518E	401	" " " " " " Nut.
3074	393	" Eccentric with 446c.....
446C	402	" " " " " Set Screw.....
3037	391	" Forked Connection.....
375C	402	" " " " " Hinge Screw...
1518E	401	" " " " " " Nut
6459	393	" Regulator.....
58E	402	" " " " " Hinge Screw.....
818D	401	" " " " " Thumb Screw.....
16104	3651	" Rock Shaft.....
6018	392	" " " " " Crank with 207F.....
156F	402	" " " " " Position Screw...
207F	402	" " " " " Set Screw.....
6497	403	" Wheel.....
6498	393	" " " " " Driver.....
16168	400	" " " " " Spring.....
207F	402	" " " " " " Screw.....
6089	400	" " " " " Friction Spring.....
207F	402	" " " " " " Screw.....
4344	393	Needle Bar.....
16178	—	" " " " " 4344 with 2273 and 4345.....
16182	—	" " " " " " " 6524.....
*3045	3669	" " " " " " " Connecting Link.....
16220	—	" " " " " " " 3045 with 377c, 1518E and 6487.....

NO.	PLATE	NAME
377c	402	Needle Bar Connecting Link Hinge Screw
1518E	401	" " " " " "
		Nut.....
6487	397	Needle Bar Connecting Stud with 155c...
155c	402	" " " " Set Screw...
3214	3654	" " Guide with 400c and 453c...
400c	3654	" " " Adjusting Screw.....
453c	3654	" " " Set Screw.....
290E	402	" " Screw Bushing.....
4345	400	" Clamp with two 336F, for $\frac{1}{2}$ in. to $\frac{3}{4}$ in. gauges.....
6524	400	Needle Clamp with two 50014F, for $\frac{3}{32}$ in. to $\frac{1}{8}$ in. gauges.....
2273	400	Needle Clamp Pin.....
336F	402	" Set Screw for 4345.....
50014F	3654	" " " " 6524.....
*16111	3652	Oscillating Rock Shaft.....
16112	—	Oscillating Rock Shaft complete, Nos. 4784, 16111 and 16212.....
6489	392	Oscillating Rock Shaft Hinge Pin.....
16212	—	" " " " 6 4 8 9 with 1513J.....
1513J	401	Oscillating Rock Shaft Hinge Pin Nut...
4784	412	" " " Oil Pad.....
16114	3652	" Shaft.....
16115	—	" " Crank for 16116.....
*16192	—	" " " " 16193.....
16116	3654	Oscillating Shaft Crank complete, Nos. 1518E, 16115, 19390 and two 462c.....
*16193	—	Oscillating Shaft Crank complete, Nos. 462c, 1518E, 16192 and 19390.....
2049	400	Oscillating Shaft Crank Pin.....
462c	412	" " " Set Screw.....
19389	3654	" " " Slide Block.....
226D	3669	" " " " " Cap Screw.....
12424	3654	Oscillating Shaft Crank Slide Block Cap Screw Washer.....
969c	3654	Oscillating Shaft Crank Slide Block Screw Stud.....
1518E	3654	Oscillating Shaft Crank Slide Block Screw Stud Nut.....
19390	3654	Oscillating Shaft Crank Slide Block com- plete, Nos. 226D, 969c, 12424 and 19389
3054	393	Presser Bar.....
6464	393	" " Lifter.....
77F	412	" " " Screw.....

NO.	PLATE	NAME
6465	398	Presser Bar Lifter Washer.....
16194	3664	" " Lifting Bracket with 175J and two 457K.....
16195	—	Presser Bar Lifting Bracket 16194 with 16196 and two 335J.....
175J	402	Presser Bar Lifting Bracket Adjusting Screw.....
6469	397	Presser Bar Lifting Bracket Guide.....
175J	402	" " " " " Screw.
457K	402	" " " " Set Screw...
16196	3664	" " " " Wearing Plate.....
335J	3657	Presser Bar Lifting Bracket Wearing Plate Screw.....
290E	402	Presser Bar Screw Bushing.....
5459	410	" " Spring (light) .047 wire.....
6466	393	" " " (medium) .055 wire...
6467	410	" " " (heavy) .063 wire.....
2070	398	" " " Washer.....
6533	398	" " Stop Collar with 460c.....
460c	402	" " " Set Screw.....
262J	401	Pressure Regulating Thumb Screw.....
1958	409	Roller, $1\frac{1}{2}$ in. diam., with 1261D and 1528J, for 16071 and 16082.....
1875	404	Roller, $1\frac{1}{2}$ in. diam., with 634D and 1528J, for 16014 and 16017.....
51834	—	Roller, $1\frac{1}{2}$ in. diam., coarse, for 51835....
51835	3666	Roller (ball bearing) $1\frac{1}{2}$ in. coarse roller, Nos. 1528J, 1766c, 50553c, 51834 and twenty-four 16232, for 16234 and 16235
16015	409	Roller Arm for 16017 and 16071.....
6535	404	" " " 16014 and 16082.....
16231	3665	" " " 16234 and 16235.....
440F	402	" " Adjusting Screw.....
1547J	402	" " " " Nut.....
19200	404	" " Bracket for 16017, 16071 and 16235.....
4785	3659	Roller Arm Bracket for 16014, 16082 and 16234.....
7556	404	Roller Arm Lock Spring.....
176D	402	" " " " Screw.....
1549J	402	" " " " Nut.....
316F	402	" " Screw Centre.....
1547J	402	" " " " Nut.....
16232	3665	" Ball, size $\frac{3}{8}$ in.....
1766c	3665	" " Retaining Nut.....

NO.	PLATE	NAME
16080	409	Roller Needle Guard (flat) for 16082 and 16234.....
16010	404	Roller Needle Guard (flat) for 16014.....
207F	402	" " " " Screw.....
16016	404	" " " (round) for 16017, 16071 and 16235.....
16013	404	Roller Needle Guard (round) for 16014
16081	409	" " " " " 16082 and 16234.....
16138	3659	Roller Needle Guard (round) with 242D and 16139, for 16014.....
16139	3659	Roller Needle Guard (round) Edge Guide for 16138.....
242D	3659	Roller Needle Guard (round) Edge Guide Screw.....
171F	402	Roller Needle Guard (round) Set Screw..
16082	409	Roller Presser complete, 1½ in. roller, ⅜ in. face, for ⅜ in. to ⅜ in. gauges, Nos. 171F, 176D, 207F, 440F, 1549J, 1958, 4785, 6535, 7556, 16080, 16081, two 316F and three 1547J.....
16014	404	Roller Presser complete, 1½ in. roller, ⅜ in. face, for ⅜ in. to ⅜ in. gauges, Nos. 171F, 176D, 207F, 440F, 1549J, 1875, 4785, 6535, 7556, 16010, 16013, two 316F and three 1547J.....
16071	409	Roller Presser complete, 1½ in. roller, ⅜ in. face, for ⅜ in. to ¼ in. gauges, Nos. 171F, 176D, 440F, 1549J, 1958, 7556, 16015, 16016, 19200, two 316F and three 1547J.....
16017	404	Roller Presser complete, 1½ in. roller, ⅜ in. face, for ⅜ in. to ¼ in. gauges, Nos. 171F, 176D, 440F, 1549J, 1875, 7556, 16015, 16016, 19200, two 316F and three 1547J.....
16234	3666	Roller Presser (ball bearing) complete, 1½ in. roller, ⅜ in. face, for ⅜ in. to ⅜ in. gauges, Nos. 171F, 176D, 207F, 440F, 1549J, 4785, 7556, 16080, 16081, 16231, 51835, two 316F and three 1547J
16235	---	Roller Presser (ball bearing) complete, 1½ in. roller, ⅜ in. face, for ⅜ in. to ¼ in. gauges, Nos. 171F, 176D, 440F, 1549J, 7556, 16016, 16231, 19200, 51835, two 316F and three 1547J.....
190D	402	Roller Presser Screw.....

NO.	PLATE	NAME
634D	412	Roller Screw for 1875.....
1261D	3658	" " " 1958.....
50553C	3665	" " " 51835.....
1528J	412	" " " Nut.....
2210	405	Shuttle (inside) Bobbin.....
3230	405	" " " Retaining Spring
2212	405	" " " " " "
		Rivet.....
*3235	---	Shuttle (inside) Body with 398E, 2084, 3230, 3240 and two 2212.....
*16205	---	Shuttle (inside) Cover.....
2076	405	" " " Hinge Pin.....
2078	405	" " " Delivery Eye Thread Guard.....
2080	405	Shuttle (inside) Delivery Eye Thread Guard Rivet.....
3240	405	Shuttle (inside) Main Spring.....
398E	405	" " " " Screw.....
2084	405	" " " " Steady Pin..
466C	405	" " " Tension Regulating Screw
2086	405	" " " Spring.....
2090	405	" " " Plate.....
112E	405	" " " " " Screw
16206	3668	Shuttle (inside) closed eye, complete, for ⅜ in. to ⅜ in. gauges, Nos. 112E, 466C, 2076, 2078, 2080, 2086, 2090, 2210, 3235 and 16205.....
2210	405	Shuttle (outside) Bobbin.....
3230	405	" " " Retaining Spring
2212	405	" " " " " "
		Rivet.....
*3232	---	Shuttle (outside) Body with 398E, 2084, 3230, 3239 and two 2212, for 6913.....
*3383	---	Shuttle (outside) Body with 398E, 2084, 3230, 3239 and two 2212, for 6909.....
*16207	---	Shuttle (outside) Cover.....
2076	405	" " " Hinge Pin.....
3238	405	" " " Delivery Eye Thread Guard.....
2080	405	Shuttle (outside) Delivery Eye Thread Guard Rivet.....
3239	405	Shuttle (outside) Main Spring.....
398E	405	" " " " Screw.....
2084	405	" " " " Steady Pin
466C	405	" " " Tension Regulating Screw.....



NO.	PLATE	NAME
3241	405	Shuttle (outside) Tension Spring.....
3242	405	" " " " Plate
112E	405	" " " " "
		Screw.....
16209	3668	Shuttle (outside) closed eye, complete, for $\frac{1}{8}$ in. to $\frac{5}{8}$ in. gauges, Nos. 112E, 466c, 2076, 2080, 2210, 3232, 3238, 3241, 3242 and 16207.....
16208	3668	Shuttle (outside) closed eye, complete, for $\frac{3}{8}$ in. to $\frac{1}{2}$ in. gauges, Nos. 112E, 466c, 2076, 2080, 2210, 3238, 3241, 3242, 3383 and 16207.....
16048	405	Shuttle Driver.....
2049	400	" " Pin.....
6653	403	" Race Body (two pieces) with 6571, 6576, 16049, 16050 and two each 6574 and 6575.....
16008	403	Shuttle Race Cap.....
6570	—	Shuttle Race Cap complete, Nos. 6472, 16008 and two 725j.....
6472	398	Shuttle Race Cap Latch.....
725j	412	" " " " Screw.....
102D	402	" " " " Screw.....
*6574	—	" " Hinge.....
16049	400	" " " Pin.....
6575	400	" " " Rivet.....
*6571	—	" " Latch.....
6573	400	" " " Pin.....
6572	398	" " " Spring.....
102D	402	" " " " Screw.....
16050	400	" " " Rivet.....
6576	396	" " Loop Separator.....
6587	396	" " Needle Plate.....
229D	3654	" " " " Screw.....
6642	403	Shuttle Race complete, for $\frac{1}{8}$ in. to $\frac{1}{2}$ in. gauges, Nos. 229D, 6572, 6573, 6587, 6653 and two 102D.....
50037D	3664	Shuttle Race Screw.....
16136	3651	Tension and Needle Bar Guide Bracket
16137	—	Tension and Needle Bar Guide Bracket complete, Nos. 16136, two each 637c, 1560c, 2103 and four 2102.....
190D	402	Tension and Needle Bar Guide Bracket Screw.....
2102	398	Tension Disc.....
1560c	401	" Regulating Thumb Nut.....
6600	397	" Releaser.....

NO.	PLATE	NAME
6601	397	Tension Releaser Bracket with two 465c
465c	402	" " " Set Screw.....
207F	402	" " Screw.....
637c	401	" Screw Stud.....
2103	400	" Spring.....
2413	398	" Thread Eyelet (double).....
330D	402	" " " Screw.....
*56831	—	Thread Take-up Cam (steel).....
3280	393	" " " 56831 with 446c...
3012	400	" " " Pin.....
446c	402	" " " Set Screw.....
*6704	393	" " Lever with 1819.....
16181	—	" " " 6704 with 76F....
76F	402	" " " Hinge Screw.....
1819	401	" " " Roller and Stud..
2410	398	" " Roller.....
86D	412	" " " Screw.....
2411	398	" " " Stud.....
175F	402	" " " " Set Screw..
6603	400	" " " Spring.....
6477	398	" " " Regulator Plate
233D	402	" " " " " "
		Adjusting Screw.....
6602	398	Thread Take-up Spring Thread Guard and Thread Eyelet.....
219D	402	Thread Take-up Spring Thread Guard and Thread Eyelet Screw.....
16077	3650	Drip Pan.....

## MACHINE BASE

NO.	PLATE	NAME
16031	3650	Machine Base with four each 121E and wood screws $1\frac{1}{4}$ in. No. 12.....
121E	402	Machine Screw, to secure machine to base

## ATTACHMENTS AND ACCESSORIES

NO.	PLATE	NAME
51072E	401	Machine Bolt with 51581E, to secure machine to table.....
51581E	401	Machine Bolt Nut.....
6055	398	" " " Washer.....
120342	413	Oiler (copper plated) with 120343.....
120343	413	" Spout, $3\frac{1}{2}$ in. long.....

NO.	PLATE	NAME
26026	413	Screw Driver (machine).....
26485	413	" " (shuttle tension).....
8908	413	Wrench for 1520.....
8909	413	" " 1513, 1518 and 1524.....
4822	413	" " 1528, 1547 and 1549.....

## BOBBIN WINDERS

### BOBBIN WINDER

(TIGHT WHEEL)

FOR 2073 AND 2210

FOR MACHINES Nos. 18-1 TO 18-3, 18-5, 18-6, 18-9  
AND 18-14 TO 18-18

NO.	PLATE	NAME
2466	392	Eccentric.....
286D	401	" Thumb Screw.....
6682	392	Frame.....
180D	402	" Screw.....
2460	392	Friction Ring (rubber).....
2461	392	Pulley.....
2468	392	Spindle.....
2469	—	" 2468 with 2461.....
6681	392	Bobbin Winder complete, Nos. 286D, 2460, 2466, 2469 and 6682.....

### BOBBIN WINDER

(TIGHT WHEEL)

FOR 2996

FOR MACHINES Nos. 18-7 AND 18-18

NO.	PLATE	NAME
2466	392	Eccentric.....
286D	401	" Thumb Screw.....
6682	392	Frame.....
180D	402	" Screw.....
2460	392	Friction Ring (rubber).....
2461	392	Pulley.....
2693	392	Spindle.....
2694	—	" 2693 with 2461.....
6686	392	Bobbin Winder complete, Nos. 286D, 2460, 2466, 2694 and 6682.....

## BOBBIN WINDER

(LOOSE WHEEL)

FOR 2073 AND 2210

FOR MACHINES Nos. 18-1 TO 18-3, 18-5, 18-6,  
18-9 AND 18-14 TO 18-18

NO.	PLATE	NAME
2466	392	Eccentric.....
286D	401	" Thumb Screw.....
6684	392	Frame.....
180D	402	" Screw.....
2460	392	Friction Ring (rubber).....
2461	392	Pulley.....
2468	392	Spindle.....
2469	—	" 2468 with 2461.....
6683	392	Bobbin Winder complete, Nos. 286D, 2460, 2466, 2469 and 6684.....

### BOBBIN WINDER

(LOOSE WHEEL)

FOR 2996

FOR MACHINES Nos. 18-7 AND 18-8

NO.	PLATE	NAME
2466	392	Eccentric.....
286D	401	" Thumb Screw.....
6684	392	Frame.....
180D	402	" Screw.....
2460	392	Friction Ring (rubber).....
2461	392	Pulley.....
2693	392	Spindle.....
2694	—	" 2693 with 2461.....
6687	392	Bobbin Winder complete, Nos. 286D, 2460, 2466, 2694 and 6684.....

### BOBBIN WINDER

(SWINGING AUTOMATIC, LEFT HAND)

FOR 2073 AND 2210

NO.	PLATE	NAME
27545	3660	Base.....
27321	3660	Frame.....
50356D	3665	" Hinge Screw.....
1620J	3665	" " " Nut.....
27322	3661	" Spring.....

## BOBBIN WINDERS

NO.	PLATE	NAME
27541	3660	Pulley.....
27305	3660	Spindle.....
27323	3660	Spool Pin.....
27324	3660	" Stand.....
27325	3660	Spool Stand complete, Nos. 418E, 1562J, 10141, 11241, 27323, 27324, 34358 and two each 2455 and wood screws 1 in. No. 10.....
11241	3660	Spool Washer (cloth).....
27326	3660	Stop Latch.....
35D	3661	" " Hinge Screw.....
2455	3661	Tension Disc.....
1562J	3661	" Regulating Thumb Nut.....
418E	3661	" Screw Stud.....
10141	3661	" Spring.....
34358	3664	" Thread Guide.....
27652	3660	Bobbin Winder, Nos. 35D, 1620J, 27305, 27321, 27322, 27326, 27541, 27545, 50356D and two wood screws 1 in. No. 7
27546	—	Bobbin Winder (swinging automatic, left hand) complete, Nos. 27325 and 27652

## BOBBIN WINDER

(SWINGING AUTOMATIC, LEFT HAND)

FOR 2996

This Bobbin Winder is the same as 27546 with the following exceptions:

NO.	PLATE	NAME
15072	3661	Bobbin Position Pin.....
27849	—	Spindle.....
27538	3660	" 27849 with 15072, 27850 and 41828, in place of 27305.....
27850	—	Spindle Collar.....
41828	—	" " Pin.....
27328	3660	Stop Latch, in place of 27326.....
27653	—	Bobbin Winder, Nos. 35D, 1620J, 27321, 27322, 27328, 27538, 27541, 27545, 50356D and two wood screws 1 in. No. 7, in place of 27652.....
27547	—	Bobbin Winder (swinging automatic, left hand) complete, Nos. 27325 and 27653

## FOOT LEVER PARTS

NO.	PLATE	NAME
5596	3652	Bell Crank.....
56848	—	" " 5596 with 5599 and 5601.....
5599	3652	" " Bracket.....
5601	400	" " Hinge Pin.....
5735	3661	" " Spring.....
5598	3652	Bell Crank complete, Nos. 5735 and 56848
24378	2637	Foot Lever with two 1157c.....
24379	2637	" " 24378 with 5671, 24380, 24381 and four wood screws 1 in. No. 12.....
24380	2637	Foot Lever Bracket.....
5671	2638	" " Hinge Pin.....
24381	2637	" Rest with 24382.....
24382	2638	" " Pin.....
1157c	2638	" " " Set Screw.....
16126	3650	Lifting Lever Pitman.....
24383	2637	Pitman Rod (lower) 17 in. long.....
24384	2638	" " " Stop Collar with 1157c.....
1157c	2638	Pitman Rod (lower) Stop Collar Set Screw
24385	2637	" " (upper) 17 in. long, with 2761
2761	2638	" " " Cap (washer).....
24386	2637	" " " Guide Bracket with three wood screws 1 in. No. 12.....
9079	2638	Pitman Rod Clamp with 354c.....
354c	2638	" " " Screw.....
16127	—	Foot Lever complete, Nos. 5598, 9079, 16126, 24379, 24383, 24385, 24386 and two each 24384 and wood screws 3/4 in. No. 6.....

## FOOT LIFTER PARTS

NO.	PLATE	NAME
6439	—	Chain, 36 in. to 45 in., with 56864 and 56865.....
NOTE: When ordering No. 6439, give length required		
4879	3656	Chain Connecting Link for 4885.....
56864	413	" Hook (large).....
56865	3664	" " (small).....
6692	3655	Lifting Lever for 6698.....
16042	411	" " " 16054.....
802D	402	" " Hinge Screw.....
16130	3652	" " Spring for 6698.....

## FOOT LIFTER PARTS

NO.	PLATE	NAME
16043	411	Lifting Lever Spring for 16054.....
4881	3655	Treadle.....
4882	3656	" Shaft.....
4883	3656	" Spring.....
4884	3655	" Stand.....
4885	3655	Treadle complete, Nos. 4879, 4881 to 4884 and two wood screws 1 in. No. 16.....
6698	—	Foot Lifter complete for 18-1 to 18-3 and 18-5 to 18-8 Machines, Nos. 802d, 4885, 6439, 6692 and 16130.....
16054	—	Foot Lifter complete for 18-14 to 18-18 Machines, Nos. 802d, 4885, 6439, 16042 and 16043.....

## KNEE LIFTER PARTS

(POWER TABLE OR STAND)

NO.	PLATE	NAME
6692	3655	Lifting Lever for 6691 and 16154.....
16042	411	" " " 16044 and 16155.....
802d	402	" " Hinge Screw.....
16130	3652	" " Spring for 6691 and 16154.....
16043	411	" " " 16044 and 16155.....
6703	3650	Pitman, length 14½ in., for 6691 and 16044.....
7898	3650	" " 19 in., for 16154 and 16155.....
7124	3662	Rock Shaft.....
2764	3662	" " Hanger (back) with two wood screws 1 in. No. 10.....
16128	3662	Rock Shaft Hanger (front) with two wood screws 1 in. No. 10.....
16646	3662	Rock Shaft Knee Arm.....
16647	—	Rock Shaft Knee Arm complete, Nos. 2766, 2767 and 16646.....
2766	3662	Rock Shaft Knee Arm Hub with 356c.....
356c	401	" " " " Set Screw.....
2767	3662	" " " " Plate with 356c.....
356c	401	" " " " Set Screw.....
6337	3662	" " Lifting Bracket with two 356c.....
6338	3662	" " " " Hook.....
356c	401	" " " " Set Screw.....
356c	401	" " " " Set Screw.....
2770	3662	" " Stop Dog with 356c.....
356c	401	" " " " Set Screw.....
16129	3662	Rock Shaft complete, Nos. 2764, 6337, 6338, 7124, 16128, 16647 and two 2770.....

## KNEE LIFTER PARTS

NO.	PLATE	NAME
6691	—	Knee Lifter complete for 18-1 to 18-3 and 18-5 to 18-8 Machines, Nos. 802d, 6692, 6703, 16129 and 16130.....
16044	—	Knee Lifter complete for 18-14 to 18-18 Machines, Nos. 802d, 6703, 16042, 16043 and 16129.....
16154	—	Knee Lifter complete for 18-1 to 18-3 and 18-5 to 18-8 Machines on Base, Nos. 802d, 6692, 7898, 16129 and 16130.....
16155	—	Knee Lifter complete for 18-14 to 18-18 Machines on Base, Nos. 802d, 7898, 16042, 16043 and 16129.....

## STAND

ROCKING TREADLE, BALL BEARING PITMAN

NO.	PLATE	NAME
46553	3667	Band Wheel, 12½ in. diam., with 972c...
46519	3667	" " Crank.....
46520	—	Band Wheel Crank and Pitman (ball bearing) complete, Nos. 1520r, 25371, 46506 to 46509, 46519, 46523, 46630, 46655 and six 25362.....
297c	3826	Band Wheel Crank Screw Centre.....
46629	—	" " " " " 297c with 1507r.....
1507r	3826	Band Wheel Crank Screw Centre Nut....
972c	3826	" " Set Screw.....
25024	—	Belt, size ¼ in., length 68 in., with 25127.....
25127	3826	" Hook.....
25369	3810	Brace with three 46629.....
46550	3667	Brace (sectional) complete, Nos. 46551, 46552 and three 649r.....
506r	402	Brace Bolt with 1510r.....
1510r	401	" " Nut.....
46551	3667	" Section (left) with two 46629.....
46552	3667	" " (right) with 46629.....
649r	3664	" " Screw.....
25065	3667	Leg.....
25362	3826	Pitman Ball, size ½ in.....
46506	3826	" " Bearing Adjusting Screw Ring.....
46507	3826	Pitman Ball Bearing Adjusting Screw Ring Locking Washer (brass).....
46508	3826	Pitman Ball Bearing Ring.....
46509	3826	" " Case.....

NO.	PLATE	NAME
46655	3826	Pitman Ball Separator.....
46523	3667	" Rod with 25360.....
*25360	—	" " Ball.....
25371	3826	" " " Bushing.....
25361	3826	" " " Screw Bearing.....
46630	—	" " " " " 25361 with 1670E.....
1670R	3826	Pitman Rod Ball Screw Bearing Nut.....
1520R	3826	" " Lock Nut.....
25078	3667	Table Support.....
1059R	401	" " Bolt with 1510R.....
1510R	401	" " " Nut.....
46554	3667	Treadle.....
297C	3826	" Screw Centre.....
46629	—	" " " 297C with 1507J... ..
1507R	3826	" " " Nut.....
25086	3667	Wrench for 1507, 1510 and 1670.....
25200	3667	" " 972.....
25273	—	Stand (iron work) complete, Nos. 1059R, 25078, 25086, 25200, 25369, 46520, 46553, 46554, two 25065 and four 506R

### OBSOLETE PARTS

NO.	PLATE	NAME
*16029	—	Arm and Cylinder for 18-15 Machine....
*6451	—	" " " with 6452, 6453 and four 180D, for 18-1 and 18-2 Machines, use 11617.....
*16117	—	Arm and Cylinder for 18-1 and 18-2 Machines.....
*16157	—	Arm and Cylinder for 18-1 and 18-2 Machines.....
*6493	—	Arm and Cylinder with 6452, 6453 and four 180D, for 18-3 Machine, use 16118
*6521	—	Arm and Cylinder with 6452, 6453 and four 180D, for 18-5 Machine, use 16119
*6630	—	Arm and Cylinder with 6452, 6453 and four 180D, for 18-6 Machine, use 16120
*6503	—	Arm and Cylinder with 6452, 6453 and four 180D, for 18-7 and 18-8 Machines, use 16121.....
*16056	—	Arm and Cylinder with 6452, 6453 and four 180D, for 18-9 Machine, use 16122
*6453	—	Arm Side Plate for 6451, 6493, 6503, 6521, 6630 and 16056.....

NO.	PLATE	NAME
2139	410	Balance Wheel Speed Pulley, 1 $\frac{1}{4}$ in. diam., with 451c.....
2140	410	Balance Wheel Speed Pulley, 2 $\frac{1}{4}$ in. diam., with 437c.....
451c	398	Balance Wheel Speed Pulley Set Screw for 2139.....
437c	398	Balance Wheel Speed Pulley Set Screw for 2140.....
6785	390	Cloth Plate Bracket with 345c, for 6454, use 16142.....
16033	390	Cloth Plate Bracket with 345c, for 6478, use 16143.....
6787	—	Cloth Plate complete for 6788, Nos. 3286, 6786, 6789 and two 725J, use 6495.....
6788	—	Cloth Plate with Bracket complete for 18-6 Machine, Nos. 6083, 6787 and two 389R, use 6494.....
6789	—	Cloth Plate Slide for 6787, use 6496.....
3024	391	Crank Connecting Rod with 3025 and two 145E.....
*3025	—	Crank Connecting Rod Cap for 3024.....
158E	402	" " " " Screw for 3024 and 4292, use 145E.....
*6452	—	Cylinder Side Plate for 6451, 6493, 6503, 6521, 6630 and 16056.....
6522	408	Feed Cover for 18-5 Machine.....
6605	408	" " " " ".....
401D	402	" " Screw.....
6480	408	" Dog for 18-1 Machine.....
6490	396	" " " 18-2 and 18-15 Machines...
6523	3658	" " " $\frac{1}{2}$ in. to $\frac{3}{8}$ in. gauges, for 18-5 Machine.....
16132	3677	Feed Dog (flat feeding surface) for $\frac{1}{2}$ in. to $\frac{5}{8}$ in. gauges, for 18-5 and 18-16 Machines.....
16150	3677	Feed Dog (flat feeding surface) for $\frac{3}{4}$ in. to $\frac{1}{4}$ in. gauges, for 18-5 and 18-16 Machines.....
6679	407	Feed Dog, for cloth, for 18-5, 18-9 and 18-16 Machines.....
16088	3676	Feed Dog, for cloth (feeding surface same as 6679) for 18-2 Machine.....
16140	3678	Feed Dog, for cloth, for 18-2 Machine....
16072	407	" " " leather, for 18-5 Machine...
190D	402	" Rock Shaft Crank Set Screw.....
6693	—	Lifting Lever for 6696, use 6692.....
6699	392	" " Spring for 6696, use 16130

## OBSOLETE PARTS

NO.	PLATE	NAME
6695	3650	Knee Lifter Pitman, length 15 $\frac{7}{8}$ in., for 6696, use 6703.....
6697	3650	Knee Lifter Pitman, length 14 $\frac{7}{8}$ in., use 6703.....
2763	3662	Knee Lifter Rock Shaft for 6339.....
6334	3662	" " " " Hanger with two wood screws 1 in. No. 10, for 6339.....
6339	3662	Knee Lifter Rock Shaft complete for 6696, Nos. 2763, 2770, 6337, 6338, 16647 and two 6334.....
6696	—	Knee Lifter complete for 18-1 to 18-3 and 18-5 to 18-8 Machines, Nos. 802D, 6339, 6693 to 6695 and 6699, use 6991
6629	—	Machine Base with four each 121E and wood screws 1 $\frac{1}{4}$ in. No. 12, for 18-1 to 18-3 and 18-5 to 18-9 Machines.....
6714	410	Needle Bar for 6715.....
*6486	397	" " Connecting Link for 16220 and 18-9 Machine, use 3045.....
2166	398	Needle Bar Thread Eyelet.....
6715	407	Needle Clamp (screw shank) with two 336F, for 18-5 Machine.....
3108	3654	Needle Stop Pin for 16642.....
6481	410	Oscillating Rock Shaft with 197E, 2170 and two each 2171 and 2174, for 300 and 304, for 18-1 to 18-3, 18-5 and 18-6 Machines.....
6482	3656	Oscillating Rock Shaft with 197E, 2170 and two each 2172 and 2174, for 618 and 619, for 18-1 to 18-3, 18-5 and 18-6 Machines.....
2170	—	Oscillating Rock Shaft Oil Pad for 6481 and 6482.....
197E	—	Oscillating Rock Shaft Oil Pad Screw for 6481 and 6482.....
300c	398	Oscillating Rock Shaft Screw Centre (front) for 6481.....
304c	398	Oscillating Rock Shaft Screw Centre (back) for 6481.....
618c	398	Oscillating Rock Shaft Screw Centre (front) double taper, for 6482.....
619c	398	Oscillating Rock Shaft Screw Centre (back) double taper, for 6482.....
1513J	401	Oscillating Rock Shaft Screw Centre Nut
2171	410	" " " Steel Plate for 6481.....

## OBSOLETE PARTS

NO.	PLATE	NAME
2172	410	Oscillating Rock Shaft Steel Plate for 6482
2174	400	" " " " " Rivet for 6481 and 6482.....
6531	391	Oscillating Shaft for 6520, for 18-5, 18-6 and 18-9 Machines.....
16076	3651	Oscillating Shaft for 6520, for 18-16 Machine.....
*6520	—	Oscillating Shaft Crank with 1813, for 6532
6532	397	" " " 6520 with two 462c, for 18-5, 18-6, 18-9 and 18-16 Machines.....
6463	—	Oscillating Shaft Crank with two 457c, use 6024.....
457c	402	Oscillating Shaft Crank Set Screw for 6463
229D	3654	" " " Slide Block Cap Screw for 19390, use 226D.....
3054	393	Presser Bar for 18-5 and 18-16 Machines
6694	393	" " Lifting Bracket with 175J and two 457K, for 18-1 to 18-3, 18-6 to 18-9, 18-14, 18-15, 18-17 and 18-18 Machines, use 16195.....
16146	3657	Presser Bar Lifting Bracket with 175J and two 457K, for 18-5 and 18-16 Machines, use 16198.....
290E	402	Presser Bar Screw Bushing for 18-5 and 18-16 Machines.....
5459	410	Presser Bar Spring (light) .047 wire, for 18-5 and 18-16 Machines.....
6466	393	Presser Bar Spring (medium) .055 wire, for 18-5 and 18-16 Machines.....
6467	410	Presser Bar Spring (heavy) .063 wire, for 18-5 and 18-16 Machines.....
6468	393	Presser Bar Spring Bracket with 175J and two 457K, use 6694.....
2070	398	Presser Bar Spring Washer for 18-5 and 18-16 Machines.....
6533	398	Presser Bar Stop Collar with 460c, for 18-5 and 18-16 Machines.....
262J	401	Pressure Regulating Thumb Screw for 18-5 and 18-16 Machines.....
1917	3659	Roller, 1 $\frac{1}{2}$ in. diam., $\frac{1}{8}$ in. face, with 634D and 1528J, for 16070, 16071 and 16082
3223	3661	Roller Arm Bracket for 6534.....
6536	3658	" Needle Guard (flat) for 6518 and 6534.....
6519	3658	Roller Needle Guard (round) for 6518...

NO.	PLATE	NAME
6534	3658	Roller Presser complete, 1½ in. roller, for 18-5 Machine, Nos. 176D, 207F, 440F, 1549J, 1875, 2205, 3223, 6535, 6536, two 316F and three 1547J.....
16070	3653	Roller Presser, complete, 1½ in. roller, ⅜ in. face, for ⅜ in. to ⅛ in. gauges, for 18-5 Machine, Nos. 171F, 176D, 207F, 440F, 1549J, 1917, 4785, 6535, 7556, 16010, 16013, two 316F and three 1547J.....
6518	3658	Roller Presser complete, 1½ in. roller, for ⅜ in. to ⅝ in. gauges, for 18-5 and 18-6 Machines, Nos. 171F, 176D, 207F, 440F, 1549J, 1875, 4785, 6519, 6535, 6536, 7556, two 316F and three 1547J.....
6664	406	Shuttle, 1½ in. diam., for 18-7 and 18-8 Machines, Nos. 2996, 6665 and 6668, use 16023.....
16025	—	Shuttle Bobbin Case Hinge, Nos. 2974, 16026 and 16027, for 16024.....
*6944	—	Shuttle (inside) Cover for 6628.....
6628	405	Shuttle (inside) closed eye, complete, for ⅜ in. to ¼ in. gauges, for 18-5, 18-6, 18-9, 18-16 and 18-18 Machines, Nos. 112E, 466c, 2076, 2078, 2080, 2086, 2090, 2210, 3235 and 6944, use 16206.....
*6945	—	Shuttle (outside) Cover for 6909 and 6913.....
6913	405	Shuttle (outside) closed eye, complete, for ⅜ in. to ⅝ in. gauges, for 18-5, 18-6, 18-16 and 18-18 Machines, Nos. 112E, 466c, 2076, 2080, 2210, 3232, 3238, 3241, 3242 and 6945, use 16209.....
6909	405	Shuttle (outside) closed eye, complete, for ⅜ in. to ¼ in. gauges, for 18-5, 18-6, 18-9, 18-16 and 18-18 Machines, Nos. 112E, 466c, 2076, 2080, 2210, 3238, 3241, 3242, 3383 and 6945, use 16208.....
6666	3661	Shuttle Bobbin Case Latch for 6665.....
16026	406	" " " " " 16025.....
6667	3661	" " " Position Finger for 6665.....
6665	3661	Shuttle Bobbin Case complete for 6664, Nos. 591F, 592E, 2523, 2975, 6666, 6667 and 6669, use 16024.....
16024	3654	Shuttle Bobbin Case complete for 16023, Nos. 591F, 592E, 2523, 2975, 6669, 16025 and 16028, use 16093.....
6631	407	Shuttle Driver for 18-6 Machine, use 16048.....

NO.	PLATE	NAME
6483	408	Shuttle Driver and Feed Cam for 18-2 Machine.....
6537	407	Shuttle Driver and Feed Cam for 18-5 Machine, use 6734.....
6470	399	Shuttle Driver and Feed Lifting Cam for 18-15 Machine.....
6734	405	Shuttle Driver and Feed Lifting Cam for 18-5, 18-9 and 18-16 Machines, use 16213.....
6671	410	Shuttle Race (steel) for 6672.....
6559	410	" " Body (two pieces) with 6571, 6576, 16049, 16050 and two each 6574 and 6575, for 6548.....
6617	410	Shuttle Race Body (two pieces) with 6571, 6576, 16049, 16050 and two each 6574 and 6575, for 6606.....
6795	403	Shuttle Race Cap for 6796.....
6796	—	Shuttle Race Cap complete for 18-5, 18-9 and 18-16 Machine, Nos. 6472, 6795 and two 240D, use 16103.....
240D	402	Shuttle Race Cap Latch Screw for 6471, 6570, 6772, 6796 and 16164.....
6712	407	Shuttle Race Loop Separator, ⅜ in. to ¼ in. gauges, for 18-5 Machine.....
6713	407	Shuttle Race Loop Separator, ⅜ in. to ¼ in. gauges, for 18-5 Machine.....
233D	402	Shuttle Race Needle Plate Screw for 6548, 6606 and 6642.....
6673	410	Shuttle Race Ring for 6672 and 6764....
240J	402	" " " Screw for 6500, use 725J.....
683D	402	Shuttle Race Screw for 18-1, 18-2, 18-6 and 18-18 Machines.....
6674	408	Shuttle Race Thread Protector for 6672...
6675	408	" " " " Rivet for 6672.....
6548	410	Shuttle Race complete for 18-5 Machine, for ⅜ in. to ⅛ in. gauges, Nos. 233D, 6559, 6572, 6573, 6587 and two 102D.....
6606	410	Shuttle Race complete for 18-5 Machine, for ⅜ in. to ⅛ in. gauges, Nos. 233D, 6572, 6573, 6587, 6617 and two 102D...
6672	—	Shuttle Race complete for 18-7 Machine, Nos. 6671, 6673, 6674 and two each 185D and 6675, use 6764.....
6601	397	Tension Releaser Bracket with two 465c, for 18-5 and 18-16 Machines.....
413c	401	Tension Screw Stud.....

NO.	PLATE	NAME
6475	400	Thread Take-up Spring (music wire) for 413.....
6797	400	Thread Take-up Spring 6475, closed eye (music wire).....
6760	400	Thread Take-up Spring 6475 (heavy) use 6475.....
6476	400	Thread Take-up Spring with closed eye for 413.....
6604	400	Thread Take-up Spring with closed eyelet (music wire) for 600, for 18-5 and 18-6 Machines.....
6485	408	Thread Take-up Spring Regulator for 18-1 to 18-3 Machines.....
6484	408	Throat Plate for 6480.....
6491	408	" " " " for 18-2 Machine, use 16096.....
16141	3678	Throat Plate for 16140.....
16089	3676	" " large needle hole, for 16088
16090	—	" " small needle hole, for 16088
6705	407	" " with 228D and 6706, for 6677, use 16085.....
6707	3677	Throat Plate with 228D and 6708, for 6677, use 16085.....
6793	—	Throat Plate Body for 6700.....
16020	—	" " " " 16019.....
16083	—	" " " " 16085.....
16133	—	" " " " 16135.....
6701	407	" " Needle Plate for 6700.....
6706	407	" " " " 6705.....
6708	3677	" " " " 6707.....
16021	396	" " " " 16019.....
16084	409	" " " " 16085.....
16134	3677	" " " " 16135.....
6700	407	Throat Plate complete for 6679, Nos. 228D, 6701 and 6793.....
16019	396	Throat Plate complete, for 6677, for $\frac{3}{8}$ in. to $\frac{1}{4}$ in. gauges, for 18-5 Machine, Nos. 228D, 16020 and 16021, use 16085.....
16085	409	Throat Plate complete for 16018, for $\frac{3}{8}$ in. to $\frac{1}{4}$ in. gauges, and for 6677 for $\frac{3}{8}$ in. to $\frac{1}{4}$ in. gauges, for 18-5, 18-9 and 18-16 Machines, Nos. 228D, 16083 and 16084, use 16153.....
16135	3677	Throat Plate complete for 16132, for $\frac{3}{8}$ in. to $\frac{1}{4}$ in. gauges, and for 16150 for $\frac{3}{8}$ in. to $\frac{1}{4}$ in. gauges, for 18-5 and 18-16 Machines, Nos. 228D, 16133 and 16134.....

## NUMERICAL LIST OF PARTS

NO.	PLATE	NAME
35D	3661	Bobbin Winder Stop Latch Hinge Screw for 27652 and 27653.....
58E	402	Feed Regulator Hinge Screw.....
76F	402	Thread Take-up Lever Hinge Screw for 16179 to 16181.....
77J	412	Presser Bar Lifter Screw.....
86D	412	Thread Take-up Roller Screw for 18-5, 18-6, 18-9, 18-16 and 18-18 Machines..
90D	3657	Needle Bar Trip Lever Connection Screw for 18-9 Machine.....
102D	402	Shuttle Race Cap Screw for 6642, 6746, 16218 and 16227 and for 18-1 and 18-14 Machines.....
102D	402	Shuttle Race Latch Pin Spring Screw for 6548, 6606 and 6642.....
102D	402	Shuttle Race Lock Pin Spring Screw for 6746 and 16239.....
102D	402	Tension Releaser Screw for 18-7 and 18-8 Machines.....
112E	217	Shuttle Tension Spring Plate Screw for 44001.....
112E	405	Shuttle (inside) Tension Spring Plate Screw for 6628 and 16206.....
112E	405	Shuttle (outside) Tension Spring Plate Screw for 6909, 6913, 16208 and 16209
121E	402	Machine Base Screw, to secure machine to base, for 6629 and 16031.....
144D	402	Arm Shaft Screw.....
145D	412	" Spool Bracket Screw for 18-5, 18-6, 18-9, 18-16 and 18-18 Machines.....
145E	3669	Crank Connecting Rod Cap Screw for 4292.....
155C	402	Needle Bar Connecting Stud Set Screw for 6487.....
156F	402	Feed Rock Shaft Crank Position Screw..
158E	402	Crank Connecting Rod Cap Screw for 3024 and 4292, obsolete, use 145E.....
159F	402	Needle Bar Coupling Pin Lever Bell Crank Bracket Screw for 18-9 Machine
164D	412	Arm Side Cover (front) Screw.....
171F	402	Roller Needle Guard (round) Set Screw for 6518, 16014, 16017, 16066, 16070, 16071, 16082, 16234, 16235 and 16237



NO.	PLATE	NAME
175J	402	Presser Bar Lifting Bracket Adjusting Screw for 6694, 16146, 16194 and 16197
175J	402	Presser Bar Lifting Bracket Guide Screw
175D	402	Tension Screw Stud Set Screw for 18-1 to 18-3, 18-7, 18-8, 18-14, 18-15 and 18-17 Machines.....
175F	402	Thread Take-up Roller Stud Set Screw for 18-5, 18-6, 18-9, 18-16 and 18-18 Machines.....
176D	402	Roller Arm Lock Spring Screw for 2196, 2197, 6070, 6071, 6518, 6534, 16014, 16017, 16066, 16070, 16071, 16082, 16099, 16100, 16225, 16226, 16228 and 16233 to 16237.....
180D	402	Bobbin Winder Frame Screw for 6681, 6683, 6686 and 6687.....
185D	402	Shuttle Race Ring Screw for 6672, 6764 and 16004.....
190D	402	Feed Rock Shaft Crank Set Screw, obsolete.....
190D	402	Presser Foot Screw for 18-1 to 18-3, 18-7, 18-8, 18-14, 18-15 and 18-17 Machines
190D	402	Roller Presser Screw.....
190D	402	Tension and Needle Bar Guide Bracket Screw for 18-5, 18-6, 18-16 and 18-18 Machines.....
190D	402	Tension Bracket Screw for 18-9 Machine
196F	402	Needle Clamp Screw for 2167.....
197E	—	Oscillating Rock Shaft Oil Pad Screw for 6481 and 6482, obsolete.....
207F	402	Feed Rock Shaft Crank Set Screw for 6018
207F	402	“ Wheel Driver Spring Screw for 18-3, 18-6, 18-17 and 18-18 Machines.....
207F	402	Feed Wheel Friction Spring Screw for 18-3, 18-6, 18-17 and 18-18 Machines
207F	402	Needle Bar Connecting Stud Screw for 16055.....
207F	402	Roller Needle Guard (flat) Screw for 6518, 6534, 16014, 16070, 16082, 16234 and 16237.....
207D	402	Tension Releaser Screw for 18-5, 18-6, 18-9, 18-16 and 18-18 Machines.....
212D	3657	Needle Bar Coupling Pin Lever Bell Crank Cap Screw for 18-9 Machine...
219D	402	Tension Thread Guard Screw for 18-1 to 18-3, 18-7, 18-8, 18-14, 18-15 and 18-17 Machines.....

NO.	PLATE	NAME
219D	402	Thread Take-up Spring Thread Guard and Thread Eyelet Screw for 18-5, 18-6, 18-9, 18-16 and 18-18 Machines.....
226D	3669	Oscillating Shaft Crank Slide Block Cap Screw for 19390.....
228D	402	Throat Plate Needle Plate Screw for 6700, 6705, 6707, 16019, 16085, 16135 and 16153.....
229D	3654	Oscillating Shaft Crank Slide Block Cap Screw for 19390, obsolete, use 226D.....
229D	3654	Shuttle Race Needle Plate Screw for 6642
231C	412	Feed Dog Screw for 18-1, 18-2, 18-5, 18-7 to 18-9 and 18-14 to 18-16 Machines...
233D	402	Needle Bar Stop Collar Screw for 16065..
233D	402	“ “ Thread Guard Screw for 18-7, 18-8 and 18-14 Machines.....
233D	402	Needle Bar Thread Guide Screw for 18-2, 18-3, 18-15 and 18-17 Machines.....
233D	402	Shuttle Race Needle Plate Screw for 6548, 6606 and 6642, obsolete.....
233D	402	Thread Take-up Spring Regulator Plate Adjusting Screw.....
240D	402	Needle Bar Thread Guard Screw for 18-1 Machine.....
240D	402	Shuttle Race Cap Latch Screw for 6471, 6570, 6772, 6796 and 16164, obsolete...
240J	402	Shuttle Race Ring Latch Screw for 6500, obsolete, use 725J.....
242D	3659	Roller Needle Guard (round) Edge Guide Screw for 16138.....
248A	402	Clamp Stop Motion Clamp Stop Screw for 3022.....
256J	392	Clamp Stop Motion Clamp Screw for 3022
262J	401	Pressure Regulating Thumb Screw for 18-1 to 18-3, 18-6 to 18-8, 18-14, 18-15, 18-17 and 18-18 Machines and obsolete for 18-5 and 18-16 Machines.....
286D	401	Arm Side Cover (back) Thumb Screw....
286D	401	Bobbin Winder Eccentric Thumb Screw for 6681, 6683, 6686 and 6687.....
286D	401	Cylinder Side Cover Thumb Screw.....
290E	402	Needle Bar Screw Bushing for all machines except 18-9.....
290E	402	Presser Bar Screw Bushing for 18-1 to 18-3, 18-6 to 18-8, 18-14, 18-15, 18-17 and 18-18 Machines, and obsolete for 18-5 and 18-16 Machines.....

NO.	PLATE	NAME
297c	3826	Band Wheel Crank Screw Centre for 46629
297c	3826	Treadle Screw Centre for 46629.....
300c	398	Oscillating Rock Shaft Screw Centre (front) for 6481, obsolete.....
304c	398	Oscillating Rock Shaft Screw Centre (back) for 6481, obsolete.....
316F	402	Roller Arm Screw Centre for 2196, 2197, 6070, 6071, 6518, 6534, 16014, 16017, 16066, 16070, 16071, 16082, 16099, 16100, 16225, 16226, 16228 and 16233 to 16237.....
330d	402	Needle Bar Coupling Pin Lever Hub Set Screw for 16079.....
330d	402	Tension Thread Eyelet Screw for 18-5, 18-6, 18-9, 18-16 and 18-18 Machines
335d	3657	Needle Bar Coupling Pin Stop Bracket Screw for 18-9 Machine.....
335d	3657	Needle Bar Spring Collar Screw for 18-9 Machine.....
335J	3657	Presser Bar Lifting Bracket Wearing Plate Screw for 16195 and 16198.....
336F	402	Needle Set Screw, for right hand needle, for 4861.....
336F	402	Needle Set Screw for 4345 and 6715.....
337d	3657	" Bar Thread Eyelet Screw for 16065
345c	401	Cloth Plate Bracket Set Screw for 6083, 6719, 6785, 6792, 16033 and 16052.....
354c	2638	Pitman Rod Clamp Screw for 9079.....
356c	401	Rock Shaft Knee Arm Hub Set Screw for 2766.....
356c	401	Rock Shaft Knee Plate Set Screw for 2767
356c	401	Rock Shaft Lifting Bracket Hook Set Screw for 6337.....
356c	401	Rock Shaft Lifting Bracket Set Screw for 6337.....
356c	401	Rock Shaft Stop Dog Set Screw for 2770
375c	402	Crank Connecting Rod Hinge Screw.....
375c	402	Feed Connecting Link Hinge Screw.....
375c	402	" Forked Connection Hinge Screw....
377c	402	Needle Bar Connecting Link Hinge Screw for 16220 and 18-9 Machine.....
386d	3659	Roller Screw for 1839, 1869, 1897, 1898 and 1918.....
389F	401	Cloth Plate Screw for 6454, 6478, 6494, 6702, 6788, 6791, 16053 and 16161.....
398E	217	Shuttle Main Spring Screw for 6058.....
398E	405	" (inside) Main Spring Screw for 3235.....

NO.	PLATE	NAME
398E	405	Shuttle (outside) Main Spring Screw for 3232 and 3383.....
399D	402	Throat Plate Screw for 18-1, 18-2, 18-14 and 18-15 Machines.....
399D	402	Throat Ring Screw for 18-3 and 18-17 Machines.....
400c	3654	Needle Bar Guide Adjusting Screw for 3214.....
401d	402	Feed Cover Screw, obsolete.....
401d	402	Shuttle Race Screw for 18-7 and 18-8 Machines.....
401d	402	Throat Plate Screw for 18-7 and 18-8 Machines.....
413c	401	Tension Screw Stud, obsolete.....
418E	3661	Bobbin Winder Tension Screw Stud for 27325.....
437c	398	Balance Wheel Speed Pulley Set Screw for 2140, obsolete.....
440F	402	Roller Arm Adjusting Screw for 2196, 2197, 6070, 6071, 6518, 6534, 16014, 16017, 16066, 16070, 16071, 16082, 16099, 16100, 16225, 16226, 16228 and 16233 to 16237.....
446c	402	Feed Cam Set Screw for 3032.....
446c	402	" Eccentric Set Screw for 3074.....
446c	402	Thread Take-up Cam Set Screw for 3182 and 3280.....
448c	402	Arm Shaft Bushing Set Screw.....
448c	402	Balance Wheel Set Screw for 4370 and 4388.....
451c	398	Balance Wheel Speed Pulley Set Screw for 2139, obsolete.....
453c	3654	Needle Bar Guide Set Screw for 3214.....
457K	402	Presser Bar Lifting Bracket Set Screw for 6694, 16146, 16194 and 16197.....
457c	402	Oscillating Shaft Crank Set Screw for 6463, obsolete.....
460c	402	Oscillating Shaft Crank Set Screw for 6056.....
460c	402	Presser Bar Stop Collar Set Screw for 6533
460c	402	Tension Releaser Collar Set Screw for 16006.....
460c	402	Thread Retaining Stud Set Screw for 18-7, 18-8, 18-14, 18-15 and 18-17 Machines.....
462c	412	Clamp Stop Motion Flanged Bushing Set Screw for 4933.....

## NUMERICAL LIST OF PARTS

NO.	PLATE	NAME
462C	412	Oscillating Shaft Crank Set Screw for 6024, 6532, 7054, 16116 and 16193.....
465C	402	Tension Releaser Bracket Set Screw for 6601 and 16149.....
466C	217	Shuttle Tension Regulating Screw for 44001.....
466C	405	Shuttle (inside) Tension Regulating Screw for 6628 and 16206.....
466C	405	Shuttle (outside) Tension Regulating Screw for 6909, 6913, 16208 and 16209.....
506R	402	Brace Bolt with 1510R, for 25273.....
591F	406	Shuttle Tension Regulating Screw for 6665, 16024 and 16093.....
592E	406	Shuttle Bobbin Case Latch Stop Screw for 6665, 16024 and 16093.....
600C	3654	Tension Screw Stud for 16202.....
618C	398	Oscillating Rock Shaft Screw Centre (front) double taper, for 6482, obsolete
619C	398	Oscillating Rock Shaft Screw Centre (back) double taper, for 6482, obsolete
620F	3657	Needle Clamp Set Screw for 4861.....
620F	3657	" Set Screw, for left hand needle, for 16057, for 16065.....
634D	412	Roller Screw for 1875 and 1917.....
637C	401	Tension Screw Stud for 6599 and 16137..
649R	3664	Brace Section Screw for 46550.....
652D	3658	Roller Screw for 1841, 1868 and 1923....
665J	408	Throat Ring Needle Plate Screw for 6501
683D	402	Shuttle Race Screw for 18-1, 18-2, 18-6 and 18-18 Machines, obsolete.....
688J	3657	Pressure Regulating Thumb Screw for 18-5 and 18-16 Machines.....
691D	412	Throat Plate Screw for 18-5, 18-9 and 18-16 Machines.....
713E	3657	Pressure Regulating Thumb Screw for 18-9 Machine.....
725J	412	Cloth Plate Slide Spring Screw for 6455, 6479, 6495, 6717, 6787 and 16160.....
725J	412	Shuttle Race Cap Latch Screw for 6471, 6570, 6772 and 16164.....
725J	412	Shuttle Race Ring Latch Screw for 6500..
738D	402	" " Screw for 18-5, 18-9 and 18-16 Machines.....
802D	402	Lifting Lever Hinge Screw for 6691, 6696, 6698, 16044, 16054, 16154 and 16155..
802D	402	Needle Bar Trip Lever Hinge Screw for 18-9 Machine.....

## NUMERICAL LIST OF PARTS

NO.	PLATE	NAME
808F	402	Needle Clamp Screw for 4303.....
813D	402	Shuttle Race Hinge Screw, for $\frac{1}{2}$ in. to $\frac{1}{8}$ in. gauges, for 16166 and 16238.....
814D	402	Shuttle Race Hinge Screw, for $\frac{3}{8}$ in. to $\frac{1}{8}$ in. gauges, for 16166 and 16238.....
815D	402	Shuttle Race Hinge Screw, for $\frac{1}{4}$ in. to $\frac{1}{8}$ in. gauges, for 16166 and 16238.....
818D	401	Feed Regulator Thumb Screw.....
874F	3657	Needle Clamp and Needle (left hand) Set Screw for 16064.....
875E	3657	Presser Bar Screw Bushing for 18-9 Machine.....
921E	3657	Needle Bar Screw Bushing for 18-9 Machine.....
921E	3657	Presser Bar Screw Bushing for 18-5 and 18-16 Machines.....
969C	3654	Oscillating Shaft Crank Slide Block Screw Stud for 19390.....
972C	3826	Band Wheel Set Screw for 46553.....
1019C	3657	Presser Bar Stop Collar Set Screw for 16148.....
1053D	3654	Shuttle Race Needle Guard Screw for 6764
1059R	401	Table Support Bolt with 1510R, for 25273
1107C	412	Cloth Plate Bracket Set Screw for 16142 and 16143.....
1112F	3654	Needle Clamp Screw for 16644.....
1157C	2638	Foot Rest Pin Set Screw for 24378.....
1157C	2638	Pitman Rod (lower) Stop Collar Set Screw for 24384.....
1261D	3658	Roller Screw for 1958.....
1507R	3826	Band Wheel Crank Screw Centre Nut for 46629.....
1507R	3826	Treadle Screw Centre Nut for 46629.....
1510R	401	Brace Bolt Nut for 506.....
1510R	401	Table Support Bolt Nut for 1059.....
1513J	401	Oscillating Rock Shaft Hinge Nut for 16212.....
1513J	401	Oscillating Rock Shaft Screw Centre Nut, obsolete.....
1518E	401	Crank Connecting Rod Hinge Screw Nut
1518E	401	Feed Connecting Link Hinge Screw Nut
1518E	401	" Forked Connection Hinge Screw Nut
1518E	401	Needle Bar Connecting Link Hinge Screw Nut for 16220 and 18-9 Machine.....
1518E	3654	Oscillating Shaft Crank Slide Block Screw Stud Nut for 16116 and 16193.....
1520R	3826	Pitman Rod Lock Nut for 46520.....

NO.	PLATE	NAME
1528j	412	Roller Screw Nut for 1839, 1841, 1868, 1869, 1875, 1897, 1898, 1917, 1918, 1923, 1958, 51833, 51835, 51842 and 51856.....
1547j	402	Roller Arm Adjusting Screw Nut for 2196, 2197, 6070, 6071, 6518, 6534, 16014, 16017, 16066, 16070, 16071, 16082, 16099, 16100, 16225, 16226, 16228 and 16233 to 16237.....
1547j	402	Roller Arm Screw Centre Nut for 2196, 2197, 6070, 6071, 6518, 6534, 16014, 16017, 16066, 16070, 16071, 16082, 16099, 16100, 16225, 16226, 16228 and 16233 to 16237.....
1547j	402	Thread Take-up Lever Roller and Screw Stud Nut for 16041.....
1549j	402	Roller Arm Lock Spring Screw Nut for 2196, 2197, 6070, 6071, 6518, 6534, 16014, 16017, 16066, 16070, 16071, 16082, 16099, 16100, 16225, 16226, 16228 and 16233 to 16237.....
1560c	401	Tension Regulating Thumb Nut for 6599, 16137 and 16202.....
1562j	3661	Bobbin Winder Tension Regulating Thumb Nut for 27325.....
1620j	3665	Bobbin Winder Frame Hinge Screw Nut for 27652 and 27653.....
1670R	3826	Pitman Rod Ball Screw Bearing Nut for 46630.....
1766c	3665	Roller Ball Retaining Nut for 51833, 51835, 51842 and 51856.....
1813	401	Oscillating Shaft Crank Roller and Stud for 6024, 6056, 6520 and 7225.....
1819	401	Thread Take-up Lever Roller and Stud for 6474 and 6704.....
1839	3659	Roller, 1¼ in. diam., coarse, with 386D and 1528j, for 16099.....
1841	3659	Roller, ⅞ in. diam., fine, with 652D and 1528j, for 2197 and 6071.....
1868	399	Roller, ⅞ in. diam., coarse, with 652D and 1528j, for 2196 and 6070.....
1869	3659	Roller, 1¼ in. diam., fine, with 386D and 1528j, for 16100.....
1875	404	Roller, 1½ in. diam., with 634D and 1528j, for 6518, 6534, 16014 and 16017.....
1897	3666	Roller, 1¼ in. diam., coarse, with 386D and 1528j, for 16225.....

NO.	PLATE	NAME
1898	—	Roller, 1¼ in. diam., fine, with 386D and 1528j, for 16226.....
1915	3654	Thread Take-up Lever Roller and Screw Stud for 16041.....
1917	3659	Roller, 1½ in. diam., ⅞ in. face, with 634D and 1528j, for 16070, 16071 and 16082, obsolete.....
1918	3659	Roller, 1½ in. diam., with 386D and 1528j, for 16066.....
1923	3666	Roller, 1¼ in. diam., coarse, with 652D and 1528j, for 16228.....
1958	409	Roller, 1½ in. diam., with 1261D and 1528j, for 16071 and 16082.....
2020	392	Clamp Stop Motion Clamp Washer for 3022.....
2022	400	Clamp Stop Motion Flanged Bushing Pin
2022	400	Needle Bar Trip Lever Stop Pin for 18-9 Machine.....
2049	400	Oscillating Shaft Crank Pin.....
2049	400	Shuttle Driver and Feed Lifting Cam Pin for 18-1, 18-2, 18-5, 18-7 to 18-9 and 18-14 to 18-16 Machines.....
2049	400	Shuttle Driver Pin for 18-3, 18-6, 18-71 and 18-18 Machines.....
2053	400	Needle Bar Thread Guard for 18-7, 18-8 and 18-14 Machines.....
2070	398	Presser Bar Spring Washer for 18-1 to 18-3, 18-6 to 18-9, 18-14, 18-15, 18-17 and 18-18 Machines, and obsolete for 18-5 and 18-16 Machines.....
2073	217	Shuttle Bobbin for 6028.....
*2075	—	“ Cover for 44001.....
2076	217	“ Hinge Pin for 6028.....
2076	405	“ (inside) Cover Hinge Pin for 6628 and 16206.....
2076	405	Shuttle (outside) Cover Hinge Pin for 6909, 6913, 16208 and 16209.....
2078	217	Shuttle Delivery Eye Thread Guard for 44001.....
2078	405	Shuttle (inside) Delivery Eye Thread Guard for 6628.....
2080	217	Shuttle Delivery Eye Thread Guard Rivet for 44001.....
2080	405	Shuttle (inside) Delivery Eye Thread Guard Rivet for 6628 and 16206.....
2080	405	Shuttle (outside) Delivery Eye Thread Guard Rivet for 6909, 6913, 16208 and 16209.....

## NUMERICAL LIST OF PARTS

NO.	PLATE	NAME
2082	217	Shuttle Main Spring for 6058.....
2084	217	" " " Steady Pin for 6058
2084	405	" (inside) Main Spring Steady Pin for 3235.....
2084	405	Shuttle (outside) Main Spring Steady Pin for 3232 and 3383.....
2086	217	Shuttle Tension Spring for 44001.....
2086	405	" (inside) Tension Spring for 6628 and 16206.....
2090	217	Shuttle Tension Spring Plate for 44001...
2090	405	" (inside) Tension Spring Plate for 6628 and 16206.....
2102	398	Tension Disc for 6599, 16137 and 16204..
2103	400	" Spring for 6599, 16137 and 16204
2106	400	Thread Eyelet (front of arm) for 18-1 to 18-3 Machines.....
2111	400	Thread Retainer Guide complete for 18-7, 18-8, 18-14, 18-15 and 18-17 Machines, Nos. 2112, 2114 and 2115...
2112	400	Thread Retaining Disc with 2113, for 2111
2113	400	" " " Steady Pin for 2112.....
2114	400	Thread Retaining Spring for 2111.....
2115	400	" " Stud for 2111.....
2139	410	Balance Wheel Speed Pulley, 1 $\frac{1}{8}$ in. diam., with 451c, obsolete.....
2140	410	Balance Wheel Speed Pulley, 2 $\frac{1}{8}$ in. diam., with 437c, obsolete.....
2166	398	Needle Bar Thread Eyelet, obsolete.....
2167	400	" Clamp with 196f, for 18-7, 18-8 and 18-14 Machines.....
2170	—	Oscillating Rock Shaft Oil Pad for 6481 and 6482, obsolete.....
2171	410	Oscillating Rock Shaft Steel Plate for 6481, obsolete.....
2172	410	Oscillating Rock Shaft Steel Plate for 6482, obsolete.....
2174	400	Oscillating Rock Shaft Steel Plate Rivet for 6481 and 6482, obsolete.....
2180	396	Presser Foot for 18-2, 18-3, 18-7, 18-15 and 18-17 Machines.....
2196	399	Roller Presser complete, $\frac{3}{8}$ in. coarse roller, for 18-2, 18-3, 18-7, 18-15 and 18-17 Machines, Nos. 176d, 440f, 1549j, 1868, 2203, 2205, 2206, two 316f and three 1547j.....

## NUMERICAL LIST OF PARTS

NO.	PLATE	NAME
2197	—	Roller Presser complete, $\frac{1}{8}$ in. fine roller, for 18-2, 18-3, 18-7, 18-15 and 18-17 Machines, Nos. 176d, 440f, 1549j, 1841, 2203, 2205, 2206, two 316f and three 1547j.....
2203	399	Roller Arm for 2196 and 2197.....
2205	399	" " Lock Spring for 2196, 2197, 6070, 6071, 6534, 16099, 16100, 16225, 16226, 16228, 16233 and 16236.....
2206	399	Roller Arm Bracket for 2196 and 2197...
2210	405	Shuttle (inside) Bobbin for 6628 and 16206
2210	405	" (outside) Bobbin for 6909, 6913, 16208 and 16209.....
2211	217	Shuttle Bobbin Retaining Spring for 6058
2212	217	" " " " Rivet for 6058.....
2212	405	Shuttle (inside) Bobbin Retaining Spring Rivet for 3235.....
2212	405	Shuttle (outside) Bobbin Retaining Spring Rivet for 3232 and 3383.....
2273	400	Needle Clamp Pin for 16178 and 16182...
2410	398	Thread Take-up Roller for 18-5, 18-6, 18-9, 18-16 and 18-18 Machines.....
2411	398	Thread Take-up Roller Stud for 18-5, 18-6, 18-9, 18-16 and 18-18 Machines...
2413	398	Tension Thread Eyelet (double) for 18-5, 18-6, 18-9, 18-16 and 18-18 Machines...
2415	393	Arm Spool Bracket for 15063.....
2455	3661	Bobbin Winder Tension Disc for 27325...
2460	392	" " Friction Ring (rubber) for 6681, 6683, 6686 and 6687.....
2461	392	Bobbin Winder Pulley for 2469 and 2694
2466	392	" " Eccentric for 6681, 6683, 6686 and 6687.....
2468	392	Bobbin Winder Spindle for 2469.....
2469	—	" " " 2468 with 2461, for 6681 and 6683.....
2523	406	Shuttle Bobbin Case Position Finger Rivet for 6665, 16024 and 16093.....
2693	392	Bobbin Winder Spindle for 2694.....
2694	—	" " " 2693 with 2461, for 6686 and 6687.....
2761	2638	Pitman Rod (upper) Cap (washer) for 24385.....
2763	3662	Knee Lifter Rock Shaft for 6339, obsolete
2764	3662	Rock Shaft Hanger (back) with two wood screws 1 in. No. 10, for 16129.....

NO.	PLATE	NAME
2766	3662	Rock Shaft Knee Arm Hub with 356c, for 16647.....
2767	3662	Rock Shaft Knee Plate with 356c, for 16647.....
2770	3662	Rock Shaft Stop Dog with 356c, for 6339 and 16129.....
2862	391	Balance Wheel (stand) heavy rim, 3 in. pulley, for 3022.....
2974	406	Shuttle Bobbin Case Latch Lever Fulcrum Pin for 16025 and 16092.....
2975	406	Shuttle Bobbin Case Latch Spring for 6665, 16024 and 16093.....
2996	406	Shuttle Bobbin for 6664 and 16023.....
3004	391	Arm Shaft for 18-1 to 18-3 and 18-5 to 18-9 Machines.....
3005	393	Arm Shaft Bushing.....
3012	400	Thread Take-up Cam Pin.....
3022	—	Clamp Stop Motion complete, Nos. 248A, 256J, 2020 and 4933.....
*3023	—	Clamp Stop Motion Flanged Bushing for 4933.....
3024	391	Crank Connecting Rod with 3025 and two 158E, obsolete.....
*3025	—	Crank Connecting Rod Cap for 3024, obsolete.....
3032	393	Feed Cam with 446c, for 18-1, 18-2, 18-5, 18-7 to 18-9 and 18-14 to 18-16 Machines.....
3033	397	Feed Connecting Link.....
3037	391	" Forked Connection.....
3044	393	Needle Bar for 18-7 and 18-8 Machines.....
*3045	3669	" " Connecting Link for 16220 and 18-9 Machine.....
3054	393	Presser Bar for 18-1 to 18-3, 18-6 to 18-9, 18-14, 18-15, 18-17 and 18-18 Machines and obsolete for 18-5 and 18-16 Machines.....
3074	393	Feed Eccentric with 446c, for 18-3, 18-6, 18-17 and 18-18 Machines.....
3108	3654	Needle Stop Pin for 16642, obsolete.....
3182	393	Thread Take-up Cam 56828 with 446c, for 18-7 and 18-8 Machines.....
3214	3654	Needle Bar Guide with 400c and 453c, for 18-5, 18-6, 18-16 and 18-18 Machines.....
3223	3661	Roller Arm Bracket for 6534, obsolete.....
3230	405	Shuttle (inside) Bobbin Retaining Spring for 3235.....

NO.	PLATE	NAME
3230	405	Shuttle (outside) Bobbin Retaining Spring for 3232 and 3383.....
*3232	—	Shuttle (outside) Body with 398E, 2084, 3230, 3239 and two 2212, for 6913 and 16209.....
*3235	—	Shuttle (inside) Body with 398E, 2084, 3230, 3240 and two 2212, for 6628 and 16206.....
3238	405	Shuttle (outside) Delivery Eye Thread Guard for 6909, 6913, 16208 and 16209.....
3239	405	Shuttle (outside) Main Spring for 3232 and 3383.....
3240	405	Shuttle (inside) Main Spring for 3235.....
3241	405	" (outside) Tension Spring for 6909, 6913, 16208 and 16209.....
3242	405	Shuttle (outside) Tension Spring Plate for 6909, 6913, 16208 and 16209.....
3280	393	Thread Take-up Cam 56831 with 446c, for all machines except 18-7 and 18-8.....
3286	397	Cloth Plate Slide Spring for 6455, 6479, 6495, 6717, 6787 and 16160.....
*3383	—	Shuttle (outside) Body with 398E, 2084, 3230, 3239 and two 2212, for 6909 and 16208.....
4282	3659	Roller Arm Bracket for 16099, 16100, 16225, 16226, 16228, 16233 and 16236.....
4288	411	Arm Side Cover (back).....
4292	391	Crank Connecting Rod with 4349 and two 145E.....
4301	393	Needle Bar for 18-2, 18-3 and 18-17 Machines.....
4302	400	Needle Bar Thread Guide for 18-2, 18-3, 18-15 and 18-17 Machines.....
4303	400	Needle Clamp with 808F, for 18-2, 18-3, 18-15 and 18-17 Machines.....
4344	393	Needle Bar for 16178 and 16182.....
4345	400	" Clamp with two 336F, for $\frac{1}{2}$ in. to $\frac{3}{4}$ in. gauges, for 16178.....
*4349	—	Crank Connecting Rod Cap for 4292.....
4370	391	Balance Wheel, heavy rim, $2\frac{3}{4}$ in. pulley, with two 448c.....
4388	3655	Balance Wheel (power) light rim, $2\frac{3}{4}$ in. pulley, with two 448c.....
4766	3657	Needle Bar Coupling for 16057.....
4767	3657	" " " Pin for 16065.....
4768	3657	" " " " Lever for 18-9 Machine.....

NO.	PLATE	NAME
4773	3657	Needle Bar Spring Collar for 16065.....
4784	412	Oscillating Rock Shaft Oil Pad for 6461 and 16112.....
4785	3659	Roller Arm Bracket for 6518, 16014, 16070, 16082, 16234 and 16237.....
4822	413	Wrench for 1528, 1547 and 1549 (Attachments and Accessories).....
4840	3657	Needle Bar Spring, for left hand needle, for 16065.....
4861	3657	Needle Clamp, for right hand needle, with 336F and 620F, for $\frac{3}{8}$ in. to $\frac{1}{4}$ in. gauges, for 16065.....
4879	3656	Foot Lifter Chain Connecting Link for 4885.....
4879	3656	Needle Bar Trip Lever Chain Connecting Link for 4885.....
Nos. 4881 to 4884 for 4885		
4881	3655	Foot Lifter Treadle.....
4881	3655	Needle Bar Trip Lever Treadle.....
4882	3656	Foot Lifter Treadle Shaft.....
4882	3656	Needle Bar Trip Lever Treadle Shaft.....
4883	3656	Foot Lifter Treadle Spring.....
4883	3656	Needle Bar Trip Lever Treadle Spring.....
4884	3655	Foot Lifter Treadle Stand.....
4884	3655	Needle Bar Trip Lever Treadle Stand.....
4885	3655	Foot Lifter Treadle complete for 6698 and 16054, Nos. 4879, 4881 to 4884 and two wood screws 1 in. No. 16.....
4885	3655	Needle Bar Trip Lever Treadle complete for 18-9 Machine, Nos. 4879, 4881 to 4884 and two wood screws 1 in. No. 16.....
4933	392	Clamp Stop Motion Flanged Bushing 3023 with two 462c, for 3022.....
5459	410	Presser Bar Spring (light) .047 wire, for 18-1 to 18-3, 18-6 to 18-9, 18-14, 18-15, 18-17 and 18-18 Machines and obsolete for 18-5 and 18-16 Machines.....
5596	3652	Bell Crank for 56848.....
5598	3652	Bell Crank complete for 16127, Nos. 5735 and 56848.....
5599	3652	Bell Crank Bracket for 56848.....
5601	400	" " Hinge Pin for 56848.....
5671	2638	Foot Lever Hinge Pin for 24379.....
5735	3661	Bell Crank Spring for 5598.....
6018	392	Feed Rock Shaft Crank with 207F.....

NO.	PLATE	NAME
6024	397	Oscillating Shaft Crank with 1813 and two 462c, for 18-1 to 18-3, 18-14, 18-15 and 18-17 Machines.....
6028	217	Shuttle (high point) complete for 18-1 to 18-3, 18-14, 18-15 and 18-17 Machines, Nos. 2073, 2076, 6058 and 44001.....
6055	398	Machine Bolt-Nut Washer (Attachments and Accessories).....
*6056	—	Oscillating Shaft Crank with 460c and 1813, for 18-1 to 18-3, 18-14, 18-15 and 18-17 Machines.....
*6058	—	Shuttle Body with 398E, 2082, 2084, 2211 and two 2212, for 6028.....
6061	393	Needle Bar for 18-14 Machine.....
Nos. 6069 to 6071 for 18-1, 18-8 and 18-14 MACHINES		
6069	396	Presser Foot.....
6070	399	Roller Presser complete, $\frac{7}{8}$ in. coarse roller, Nos. 176D, 440F, 1549J, 1868, 2205, 6072, 6073, two 316F and three 1547J.....
6071	—	Roller Presser complete, $\frac{7}{8}$ in. fine roller, Nos. 176D, 440F, 1549J, 1841, 2205, 6072, 6073, two 316F and three 1547J.....
6072	399	Roller Arm for 6070 and 6071.....
6073	399	" " Bracket for 6070 and 6071.....
6083	390	Cloth Plate Bracket with two 345c, for 6494 and 6788.....
6089	400	Feed Wheel Friction Spring for 18-3, 18-6, 18-17 and 18-18 Machines.....
6334	3662	Knee Lifter Rock Shaft Hanger with two wood screws 1 in. No. 10, for 6339, obsolete.....
6337	3662	Rock Shaft Lifting Bracket with two 356c, for 6339 and 16129.....
6338	3662	Rock Shaft Lifting Bracket Hook for 6339 and 16129.....
6339	3662	Knee Lifter Rock Shaft complete for 6696, Nos. 2763, 2770, 6337, 6338, 16647 and two 6334, obsolete.....
6439	—	Foot Lifter Chain, 36 in. to 45 in., with 56864 and 56865, for 6698 and 16054.....
6439	—	Needle Bar Trip Lever Chain, 36 in. to 45 in., with 56864 and 56865, for 18-9 Machine.....

## NUMERICAL LIST OF PARTS

NO.	PLATE	NAME
*6451	—	Arm and Cylinder with 6452, 6453 and four 180b, for 18-1 and 18-2 Machines, obsolete, use 16117.....
*6452	—	Cylinder Side Plate for 6451, 6493, 6503, 6521, 6630 and 16056, obsolete.....
*6453	—	Arm Side Plate for 6451, 6493, 6503, 6521, 6630 and 16056, obsolete.....
6454	—	Cloth Plate with Bracket complete for 18-14 Machine, Nos. 6455, 16142 and two 389f.....
6455	390	Cloth Plate complete for 6454, Nos. 3286, 6456, 6799 and two 725j.....
6456	390	Cloth Plate Slide for 6455.....
6457	396	Feed Dog for 18-14 Machine.....
6458	397	“ “ Carrier for 18-1, 18-2, 18-5, 18-9 and 18-14 to 18-16 Machines.....
6459	393	Feed Regulator.....
6460	391	“ Rock Shaft for 18-1, 18-2, 18-7 and 18-8 Machines.....
*6461	392	Oscillating Rock Shaft (steel) with 4784, for 16176.....
6462	391	Oscillating Shaft for 18-1, 18-2, 18-7 and 18-8 Machines.....
6463	—	Oscillating Shaft Crank with two 457c, obsolete, use 6024.....
6464	393	Presser Bar Lifter.....
6465	398	“ “ “ Washer.....
6466	393	“ “ Spring (medium) .055 wire, for 18-1 to 18-3, 18-6 to 18-9, 18-14, 18-15, 18-17 and 18-18 Machines and obsolete for 18-5 and 18-16 Machines.....
6467	410	Presser Bar Spring (heavy) .063 wire, for 18-1 to 18-3, 18-6 to 18-9, 18-14, 18-15, 18-17 and 18-18 Machines and obsolete for 18-5 and 18-16 Machines.....
6468	393	Presser Bar Spring Bracket with 175j and two 457k, obsolete, use 6694.....
6469	397	Presser Bar Lifting Bracket Guide.....
6470	399	Shuttle Driver and Feed Lifting Cam for 18-1, 18-2 and 18-14 Machines and obsolete for 18-15 Machine.....
6471	—	Shuttle Race Cap complete for 16218 and 16227, Nos. 6472, 6800 and two 725j.....
6472	398	Shuttle Race Cap Latch for 6471, 6570, 6772, 6796 and 16164.....
6472	398	Shuttle Race Ring Latch for 6500.....
6473	396	Throat Plate for 6457.....

## NUMERICAL LIST OF PARTS

NO.	PLATE	NAME
*6474	393	Thread Take-up Lever with 1819, for 16180.....
6475	400	Thread Take-up Spring (music wire) for 413, obsolete.....
6476	400	Thread Take-up Spring with closed eye, for 413, obsolete.....
6477	398	Thread Take-up Spring Regulator Plate
6478	—	Cloth Plate with Bracket complete for 18-2 and 18-15 Machines, Nos. 6479, 16143 and two 389f.....
6479	390	Cloth Plate complete for 6478, Nos. 3286, 16032, 16034 and two 725j.....
6480	408	Feed Dog for 18-1 Machine, obsolete.....
6481	410	Oscillating Rock Shaft with 197e, 2170 and two each 2171 and 2174, for 300 and 304, for 18-1 to 18-3, 18-5 and 18-6 Machines, obsolete.....
6482	3656	Oscillating Rock Shaft with 197e, 2170 and two each 2172 and 2174, for 618 and 619, for 18-1 to 18-3, 18-5 and 18-6 Machines, obsolete.....
6483	408	Shuttle Driver and Feed Cam for 18-2 Machine, obsolete.....
6484	408	Throat Plate for 6480, obsolete.....
6485	408	Thread Take-up Spring Regulator for 18-1 to 18-3 Machines, obsolete.....
*6486	397	Needle Bar Connecting Link for 16220 and 18-9 Machine, obsolete, use 3045.....
6487	397	Needle Bar Connecting Stud with 155c, for 16220.....
6488	391	Feed Rock Shaft for 18-3 and 18-6 Machines.....
6489	392	Oscillating Rock Shaft Hinge Pin for 16212
6490	396	Feed Dog for 18-2 and 18-15 Machines, obsolete.....
6491	408	Throat Plate for 6490, for 18-2 Machine, obsolete, use 16096.....
6492	396	Throat Plate (fluted) large needle hole, for 16078.....
*6493	—	Arm and Cylinder with 6452, 6453 and four 180b, for 18-3 Machine, obsolete, use 16118.....
6494	—	Cloth Plate with Bracket complete for 18-3, 18-6, 18-17 and 18-18 Machines, Nos. 6083, 6495 and two 389f.....
6495	390	Cloth Plate complete for 6494, Nos. 3286, 6496, 6786 and two 725j.....



## NUMERICAL LIST OF PARTS

NO.	PLATE	NAME
6496	390	Cloth Plate Slide for 6495.....
6497	403	Feed Wheel for 18-3, 18-6, 18-17 and 18-18 Machines.....
6498	393	Feed Wheel Driver for 18-3, 18-6, 18-17 and 18-18 Machines.....
6499	399	Shuttle Driver for 18-3 and 18-17 Ma- chines.....
6500	403	Shuttle Race Ring complete for 6769, Nos. 6472, 16046 and two 725j.....
6501	403	Throat Ring 16047 with 665r and 6502, for 6769.....
6502	408	Throat Ring Needle Plate for 6501.....
*6503	—	Arm and Cylinder with 6452, 6453 and four 180d, for 18-7 and 18-1 Machines, obsolete, use 16121.....
6504	396	Feed Dog for 18-7 Machine.....
6505	406	“ “ Carrier for 18-7 and 18-8 Ma- chines.....
6518	3658	Roller Presser complete, 1½ in. roller, for ¾ in. to ⅝ in. gauges, for 18-5 and 18-6 Machines, Nos. 171F, 176D, 207F, 440F, 1549J, 1875, 4785, 6519, 6535, 6536, 7556, two 316F and three 1547J, obsolete
6519	3658	Roller Needle Guard (round) for 6518, obsolete.....
*6520	—	Oscillating Shaft Crank with 1813, for 6532, obsolete.....
*6521	—	Arm and Cylinder with 6452, 6453 and four 180d, for 18-5 Machine, obsolete, use 16119.....
6522	408	Feed Cover for 18-5 Machine, obsolete...
6523	3658	“ Dog, for ¾ in. to ⅝ in. gauges, for 18-5 Machine, obsolete.....
6524	400	Needle Clamp with two 50014r, for ¾ in. to ¼ in. gauges, for 16182.....
6531	391	Oscillating Shaft for 6520, for 18-5, 18-6 and 18-9 Machines, obsolete.....
6532	397	Oscillating Shaft Crank 6520 with two 462c, for 18-5, 18-6, 18-9 and 18-16 Machines, obsolete.....
6533	398	Presser Bar Stop Collar with 460c, for 18-6, 18-9 and 18-18 Machines and obsolete for 18-5 and 18-16 Machines
6534	3658	Roller Presser complete, 1½ in. roller, for 18-5 Machine, Nos. 176D, 207F, 440F, 1549J, 1875, 2205, 3223, 6535, 6536, two 316F and three 1547J, obsolete

## NUMERICAL LIST OF PARTS

NO.	PLATE	NAME
6535	404	Roller Arm for 6518, 6534, 16014, 16070 and 16082.....
6536	3658	Roller Needle Guard (flat) for 6518 and 6534, obsolete.....
6537	407	Shuttle Driver and Feed Cam for 18-5 Machine, obsolete, use 6734.....
6548	410	Shuttle Race complete for 18-5 Machine, for ¾ in. to ⅝ in. gauges, Nos. 233D, 6559, 6572, 6573, 6587 and two 102d, obsolete.....
6559	410	Shuttle Race Body (two pieces) with 6571, 6576, 16049, 16050 and two each 6574 and 6575, for 6548, obsolete.....
6570	—	Shuttle Race Cap complete for 18-6 and 18-18 Machines, Nos. 6472, 16008 and two 725j.....
*6571	—	Shuttle Race Latch for 6559, 6617 and 6653.....
6572	398	Shuttle Race Latch Pin Spring for 6548, 6606 and 6642.....
6573	400	Shuttle Race Latch Pin for 6548, 6606 and 6642.....
Nos. 6574 TO 6576 FOR 6559, 6617 AND 6653		
*6574	—	Shuttle Race Hinge.....
6575	400	“ “ “ Rivet.....
6576	396	“ “ Loop Separator.....
6587	396	“ “ Needle Plate for 6548, 6606 and 6642.....
6598	393	Tension Bracket for 6599.....
6599	—	Tension Bracket complete for 18-9 Ma- chine, Nos. 6598, two each 637c, 1560c, 2103 and four 2102.....
6600	397	Tension Releaser for 18-5, 18-6, 18-9, 18-16 and 18-18 Machines.....
6601	397	Tension Releaser Bracket with two 465c, for 18-6, 18-9 and 18-18 Machines, and obsolete for 18-5 and 18-16 Machines..
6602	398	Thread Take-up Spring Thread Guard and Thread Eyelet for 18-5, 18-6, 18-9, 18-16 and 18-18 Machines.....
6603	400	Thread Take-up Spring for 18-5, 18-6, 18-9, 18-16 and 18-18 Machines.....
6604	400	Thread Take-up Spring with closed eyelet (music wire) for 600, for 18-5 and 18-6 Machines, obsolete.....
6605	408	Feed Cover for 18-5 Machine, obsolete...

NO.	PLATE	NAME
6606	410	Shuttle Race complete for 18-5 Machine, for $\frac{1}{2}$ in. to $\frac{1}{8}$ in. gauges, Nos. 233D, 6572, 6573, 6587, 6617 and two 102D, obsolete.
6617	410	Shuttle Race Body (two pieces) with 6571, 6576, 16049, 16050 and two each 6574 and 6575, for 6606, obsolete.
6628	405	Shuttle (inside) closed eye, complete, for $\frac{1}{2}$ in. to $\frac{1}{4}$ in. gauges, for 18-5, 18-6, 18-9, 18-16 and 18-18 Machines, Nos. 112D, 466H, 2076, 2078, 2080, 2086, 2090, 2210, 3235 and 6944, obsolete, use 16206.
6629	—	Machine Base with four each 121E and wood screws $1\frac{1}{4}$ in. No. 12, for 18-1 to 18-3 and 18-5 to 18-9 Machines, obsolete.
*6630	—	Arm and Cylinder with 6452, 6453 and four 180D, for 18-6 Machine, obsolete, use 16120.
6631	407	Shuttle Driver for 18-6 Machine, obsolete, use 16048.
6642	403	Shuttle Race complete, for $\frac{1}{2}$ in. to $\frac{1}{8}$ in. gauges, for 18-6 and 18-18 Machines, Nos. 229D, 6572, 6573, 6587, 6653 and two 102D.
6653	403	Shuttle Race Body (two pieces) with 6571, 6576, 16049, 16050 and two each 6574 and 6575, for 6642.
6664	406	Shuttle, $1\frac{1}{2}$ in. diam., for 18-7 and 18-18 Machines, Nos. 2996, 6665 and 6668, obsolete, use 16023.
6665	3661	Shuttle Bobbin Case complete for 6664, Nos. 591F, 592E, 2523, 2975, 6666, 6667 and 6669, obsolete, use 16024.
6666	3661	Shuttle Bobbin Case Latch for 6665, obsolete.
6667	3661	Shuttle Bobbin Case Position Finger for 6665, obsolete.
6668	406	Shuttle Bob for 6664 and 16023.
6669	406	" Tension Spring for 6665, 16024 and 16093.
6670	406	Shuttle Driver and Feed Lifting Cam for 18-7 and 18-8 Machines.
6671	410	Shuttle Race (steel) for 6672, obsolete.
6672	—	Shuttle Race complete for 18-7 Machine, Nos. 6671, 6673, 6674 and two each 185D and 6675, obsolete, use 6764.

NO.	PLATE	NAME
6673	410	Shuttle Race Ring for 6672 and 6764, obsolete.
6674	408	Shuttle Race Thread Protector for 6672, obsolete.
6675	408	Shuttle Race Thread Protector Rivet for 6672, obsolete.
6676	396	Throat Plate, large needle hole, for 6504
6677	396	Feed Dog, for $\frac{1}{2}$ in. to $\frac{1}{4}$ in. gauges, for 18-5, 18-9 and 18-16 Machines.
6678	391	Feed Rock Shaft for 18-5 and 18-9 Machines.
6679	407	Feed Dog, for cloth, for 18-5, 18-9 and 18-16 Machines, obsolete.
6681	392	Bobbin Winder (tight wheel) complete for 2073 and 2210, for 18-1 to 18-3, 18-5, 18-6, 18-9 and 18-14 to 18-18 Machines, Nos. 286D, 2460, 2466, 2469 and 6682
6682	392	Bobbin Winder Frame for 6681 and 6686
6683	392	Bobbin Winder (loose wheel) complete for 2073 and 2210, for 18-1 to 18-3, 18-5, 18-6, 18-9 and 18-14 to 18-18 Machines, Nos. 286D, 2460, 2466, 2469 and 6684
6684	392	Bobbin Winder Frame for 6683 and 6687
6686	392	Bobbin Winder (tight wheel) complete for 2996, for 18-7 and 18-8 Machines, Nos. 286D, 2460, 2466, 2694 and 6682
6687	392	Bobbin Winder (loose wheel) complete for 2996, for 18-7 and 18-8 Machines, Nos. 286D, 2460, 2466, 2694 and 6684
6691	—	Knee Lifter complete for 18-1 to 18-3 and 18-5 to 18-8 Machines, Nos. 802D, 6692, 6703, 16129 and 16130.
6692	3655	Lifting Lever for 6691, 6698 and 16154.
6693	—	" " " 6696, obsolete, use 6692
6694	393	Presser Bar Lifting Bracket with 175J and two 457K, for 18-1 to 18-3, 18-6 to 18-9, 18-14, 18-15, 18-17 and 18-18 Machines, obsolete, use 16195.
6695	3650	Knee Lifter Pitman, length $15\frac{1}{8}$ in., for 6696, obsolete, use 6703.
6696	—	Knee Lifter complete for 18-1 to 18-3 and 18-5 to 18-8 Machines, Nos. 802D, 6339, 6693 to 6695 and 6699, obsolete, use 6691.
6697	3650	Knee Lifter Pitman, length $14\frac{1}{8}$ in., obsolete, use 6703.

NO.	PLATE	NAME
6698	—	Foot Lifter complete, for 18-1 to 18-3 and 18-5 to 18-8 Machines, Nos. 802D, 4885, 6439, 6692 and 16130.....
6699	392	Lifting Lever Spring for 6696, obsolete, use 16130.....
6700	407	Throat Plate complete for 6679, Nos. 228D, 6701 and 6793, obsolete.....
6701	407	Throat Plate Needle Plate for 6700, obsolete.....
6702	—	Cloth Plate with Bracket complete for 18-5, 18-9 and 18-16 Machines, Nos. 6717, 6719 and two 389F.....
6703	3650	Pitman, length 14½ in., for 6691 and 16044
*6704	393	Thread Take-up Lever with 1819, for 16181.....
6705	407	Throat Plate with 228D and 6706, for 6677, obsolete, use 16085.....
6706	407	Throat Plate Needle Plate for 6705, obsolete.....
6707	3677	Throat Plate with 228D and 6708, for 6677, obsolete, use 16085.....
6708	3677	Throat Plate Needle Plate for 6707, obsolete.....
6709	400	Shuttle Race Lock Pin for 6746 and 16239
6712	407	“ “ Loop Separator, ⅜ in. to ¼ in. gauges, for 18-5 Machine, obsolete
6713	407	Shuttle Race Loop Separator, ⅜ in. to ¼ in. gauges, for 18-5 Machine, obsolete
6714	410	Needle Bar for 6715, obsolete.....
6715	407	“ Clamp (screw shank) with two 336F, for 18-5 Machine, obsolete.....
6716	394	Cloth Plate for 6717.....
6717	394	Cloth Plate complete for 6702, Nos. 3286, 6716, 6718 and two 725J.....
6718	394	Cloth Plate Slide for 6717.....
6719	394	“ “ Bracket with 345C, for 6702
6734	405	Shuttle Driver and Feed Lifting Cam for 18-5, 18-9 and 18-16 Machines, obsolete, use 16213.....
6746	403	Shuttle Race complete, for ⅜ in. to ¼ in. gauges, for 18-5, 18-9 and 18-16 Machines, Nos. 6709, 6758, 16166 and two 102D.....
6758	398	Shuttle Race Lock Pin Spring for 6746 and 16239.....
6760	400	Thread Take-up Spring 6475 (heavy) obsolete, use 6475.....

NO.	PLATE	NAME
6762	403	Shuttle Race Body (steel) for 6764.....
6763	403	“ “ Ring (steel) for 6764.....
6764	—	Shuttle Race (steel) complete for 18-7 Machine, Nos. 6762, 6763, 16105 and two each 185D and 1053D.....
6768	400	Thread Take-up Spring for 18-1 to 18-3, 18-7, 18-8, 18-14, 18-16 and 18-17 Machines.....
6769	—	Throat Ring complete for 18-3 and 18-17 Machines, Nos. 6500, 6501 and two 50008J.....
6771	403	Shuttle Race Cap for 6772.....
6772	—	Shuttle Race Cap complete for 18-14 Machine, Nos. 6472, 6771 and two 725J
6785	390	Cloth Plate Bracket with 345C, for 6454, obsolete, use 16142.....
6786	390	Cloth Plate for 6495 and 6787.....
6787	—	Cloth Plate complete for 6788, Nos. 3286, 6786, 6789 and two 725J, obsolete, use 6495.....
6788	—	Cloth Plate with Bracket complete for 18-6 Machine, Nos. 6083, 6787 and two 389F, obsolete, use 6494.....
6789	—	Cloth Plate Slide for 6787, obsolete, use 6496.....
6790	394	Cloth Plate for 6791.....
6791	—	Cloth Plate with Bracket complete for 18-7 Machine, Nos. 6790, 6792 and two 389F.....
6792	394	Cloth Plate Bracket with 345C, for 6791
6793	—	Throat Plate Body for 6700, obsolete....
6795	403	Shuttle Race Cap for 6796, obsolete.....
6796	—	Shuttle Race Cap complete for 18-5, 18-9 and 18-16 Machines, Nos. 6472, 6795 and two 240D, obsolete, use 16103.....
6797	400	Thread Take-up Spring 6475, closed eye (music wire) obsolete.....
6799	390	Cloth Plate for 6455.....
6800	403	Shuttle Race Cap for 6471.....
6909	405	Shuttle (outside) closed eye, complete, for ⅜ in. to ¼ in. gauges, for 18-5, 18-6, 18-9, 18-16 and 18-18 Machines, Nos. 112E, 466C, 2076, 2080, 2210, 3238, 3241, 3242, 3383 and 6945, obsolete, use 16208

## NUMERICAL LIST OF PARTS

NO.	PLATE	NAME
6913	405	Shuttle (outside) closed eye, complete, for $\frac{1}{2}$ in. to $\frac{5}{8}$ in. gauges, for 18-5, 18-6, 18-16 and 18-18 Machines, Nos. 112E, 466c, 2076, 2080, 2210, 3232, 3238, 3241, 3242 and 6945, obsolete, use 16209
*6944	—	Shuttle (inside) Cover for 6628, obsolete
*6945	—	" (outside) Cover for 6909 and 6913, obsolete
7054	406	Oscillating Shaft Crank 7225 with two 462c, for 18-7 and 18-18 Machines
7124	3662	Rock Shaft for 16129
*7225	—	Oscillating Shaft Crank with 1813, for 7054
7393	400	Tension Releaser Collar Pin for 16006
7556	404	Roller Arm Lock Spring for 6518, 16014, 16017, 16066, 16070, 16071, 16082, 16234, 16235 and 16237
7898	3650	Pitman, length 19 in., for 16154 and 16155
8879	412	Arm Spool Pin Washer (cloth) for 18-1 to 18-3, 18-7, 18-8, 18-14, 18-15 and 18-17 Machines
8908	413	Wrench for 1520 (Attachments and Accessories)
8909	413	Wrench for 1513, 1518 and 1524 (Attachments and Accessories)
9079	2638	Pitman Rod Clamp with 354c, for 16127
9525	3657	Needle Bar Coupling Pin Lever Bell Crank Washer for 16060
10141	3661	Bobbin Winder Tension Spring for 27325
10160	3664	Needle Stop Pin for 16642
11170	3657	Presser Bar Spring Washer for 18-5 and 18-16 Machines
11241	392	Arm Spool Bracket Spool Pin Washer (cloth) for 18-5, 18-6, 18-9, 18-16 and 18-18 Machines
11241	3660	Bobbin Winder Spool Washer (cloth) for 27325
12403	400	Arm Spool Bracket Spool Pin and Thread Eyelet for 15063
12403	400	Arm Spool Pin and Thread Eyelet for 18-1 to 18-3, 18-7, 18-8, 18-14, 18-15 and 18-17 Machines
12424	3654	Oscillating Shaft Crank Slide Block Cap Screw Washer for 19390
15063	393	Arm Spool Bracket 2415 with two 12403, for 18-5, 18-6, 18-9, 18-16 and 18-18 Machines

## NUMERICAL LIST OF PARTS

NO.	PLATE	NAME
15072	3661	Bobbin Winder Bobbin Position Pin for 27538
16001	396	Feed Dog for 18-8 Machine
16002	403	Shuttle Race Body (steel) for 16004
16003	403	" " Ring (steel) for 16004
16004	—	Shuttle Race (steel) complete for 18-8 Machine, Nos. 16002, 16003 and two 185D
16005	406	Tension Releaser for 18-7 and 18-8 Machines
16006	406	Tension Releaser Collar with 460c and 7393, for 18-7 and 18-8 Machines
16007	396	Throat Plate for 16001
16008	403	Shuttle Race Cap for 6570
16010	404	Roller Needle Guard (flat) for 16014 and 16070
16013	404	Roller Needle Guard (round) for 16014 and 16070
16014	404	Roller Presser complete, $1\frac{1}{2}$ in. roller, $\frac{3}{2}$ in. face, for $\frac{1}{2}$ in. to $\frac{1}{8}$ in. gauges, for 18-5, 18-6, 18-16 and 18-18 Machines, Nos. 171F, 176D, 207F, 440F, 1549I, 1875, 4785, 6535, 7556, 16010, 16013, two 316F and three 1547J
16015	409	Roller Arm for 16017, 16066 and 16071
16016	404	" Needle Guard (round) for 16017, 16066, 16071 and 16235
16017	404	Roller Presser complete, $1\frac{1}{2}$ in. roller, $\frac{7}{2}$ in. face, for $\frac{3}{4}$ in. to $\frac{1}{4}$ in. gauges, for 18-5, 18-6, 18-16 and 18-18 Machines, Nos. 171F, 176D, 440F, 1549I, 1875, 7556, 16015, 16016, 19200, two 316F and three 1547J
16018	396	Feed Dog, for $\frac{1}{2}$ in. to $\frac{5}{8}$ in. gauges, for 18-5 and 18-16 Machines
16019	396	Throat Plate complete for 6677, for $\frac{3}{2}$ in. to $\frac{1}{4}$ in. gauges, for 18-5 Machine, Nos. 228D, 16020 and 16021, obsolete, use 16085
16020	—	Throat Plate Body for 16019, obsolete
16021	396	" " Needle Plate for 16019, obsolete
16022	398	Tension Thread Guard for 18-1 to 18-3, 18-7, 18-8, 18-14, 18-15 and 18-17 Machines
16023	406	Shuttle, $1\frac{1}{2}$ in. diam., Nos. 2996, 6668 and 16093, for 18-7 and 18-8 Machines

## NUMERICAL LIST OF PARTS

NO.	PLATE	NAME
16024	3654	Shuttle Bobbin Case complete for 16023, Nos. 591F, 592E, 2523, 2975, 6669, 16025 and 16028, obsolete, use 16093.
16025	—	Shuttle Bobbin Case Hinge, Nos. 2974, 16026 and 16027, for 16024, obsolete
16026	406	Shuttle Bobbin Case Latch for 16025, obsolete.
16027	406	Shuttle Bobbin Case Latch Lever for 16025 and 16092.
16028	406	Shuttle Bobbin Case Position Finger for 16024 and 16093.
*16029	—	Arm and Cylinder for 18-14 Machine and obsolete for 18-15 Machine.
16030	411	Arm Shaft for 18-14 to 18-18 Machines.
16031	3650	Machine Base with four each 121E and wood screws 1¼ in. No. 12.
16032	390	Cloth Plate for 6479.
16033	390	" " Bracket with 345c, for 6478, obsolete, use 16143.
16034	390	Cloth Plate Slide for 6479.
16036	411	Cylinder Side Cover.
16037	411	Feed Rock Shaft for 18-14 and 18-15 Machines.
16038	3651	Needle Bar for 18-15 Machine.
16039	411	Oscillating Shaft for 18-14 and 18-15 Machines.
16040	412	Throat Plate for 16078, for 18-15 Machine
*16041	412	Thread Take-up Lever with 1547J and 1915, for 16179.
16042	411	Lifting Lever for 16044, 16054 and 16155
16043	411	" " Spring for 16044, 16054, and 16155.
16044	—	Knee Lifter complete for 18-14 to 18-18 Machines, Nos. 802D, 6703, 16042, 16043 and 16129.
16045	412	Cylinder Oil Tube for oiling 6462, 16039, 16055, 16076, 16113, 16114 and 16169.
16046	—	Shuttle Race Ring for 6500.
16047	—	Throat Ring for 6501.
16048	405	Shuttle Driver for 18-6 and 18-18 Machines.
16049	400	Shuttle Race Hinge Pin for 6559, 6617 and 6653.
16050	400	Shuttle Race Latch Rivet for 6559, 6617 and 6653.
16051	394	Cloth Plate for 16053.
16052	394	" " Bracket with 345c, for 16053

## NUMERICAL LIST OF PARTS

NO.	PLATE	NAME
16053	—	Cloth Plate with Bracket complete for 18-8 Machine, Nos. 16051, 16052 and two 389F.
16054	—	Foot Lifter complete for 18-14 to 18-18 Machines, Nos. 802D, 4885, 6439, 16042 and 16043.
16055	391	Oscillating Shaft for 18-3 Machine.
*16056	—	Arm and Cylinder with 6452, 6453 and four 180D, for 18-9 Machines, obsolete, use 16122.
Nos. 16057 TO 16059 FOR 16065		
*16057	—	Needle Bar, for left hand needle, with 4766
*16058	—	" " " right hand needle.
16059	3653	" " Connecting Stud.
Nos. 16060 TO 16069 FOR 18-9 MACHINE		
16060	3653	Needle Bar Coupling Pin Lever Bell Crank with 9525.
16061	3653	Needle Bar Coupling Pin Lever Bell Crank Bracket.
16062	3653	Needle Bar Coupling Pin Stop Bracket.
16063	3653	" " Thread Eyelet for 16065.
16064	3653	" Clamp, for right hand needle, with 874E, for ½ in. to ¼ in. gauges, for 16065
16065	3651	Needle Bar complete, Nos. 207E, 337D, 620E, 4767, 4773, 4840, 4861 or 16064, 16057 to 16059, 16063, 16144 and two 233D.
16066	3653	Roller Presser complete, 1½ in. roller, Nos. 171F, 176D, 440F, 1549J, 1918, 7556, 16015, 16016, 19200, two 316F and three 1547J.
16067	3651	Needle Bar Trip Lever.
16068	3651	" " " " Connection.
16069	3651	" " " " Spring.
16070	3653	Roller Presser complete, 1½ in. roller, ⅝ in. face, for ½ in. to ¼ in. gauges, for 18-5 Machine, Nos. 171F, 176D, 207F, 440F, 1549J, 1917, 4785, 6535, 7556, 16010, 16013, two 316F and three 1547J, obsolete.
16071	409	Roller Presser complete, 1½ in. roller, ⅝ in. face, for ½ in. to ¼ in. gauges, for 18-5, 18-6, 18-16 and 18-18 Machines, Nos. 171F, 176D, 440F, 1549J, 1958, 7556, 16015, 16016, 19200, two 316F and three 1547J.

NO.	PLATE	NAME
16072	407	Feed Dog, for leather, for 18-5 Machine, obsolete.....
*16074	—	Arm and Cylinder for 18-16 Machine.....
16075	3651	Feed Rock Shaft for 18-16 Machine.....
16076	3651	Oscillating Shaft for 6520 for 18-16 Machine, obsolete.....
16077	3650	Drip Pan.....
16078	3675	Feed Dog for 18-2 and 18-15 Machines
16079	3653	Needle Bar Coupling Pin Lever Hub with 330D, for 18-9 Machine.....
16080	409	Roller Needle Guard (flat) for 16082, 16234 and 16237.....
16081	409	Roller Needle Guard (round) for 16082, 16234 and 16237.....
16082	409	Roller Presser complete, 1½ in. roller, ⅜ in. face, for ⅜ in. to ⅜ in. gauges, for 18-5, 18-6, 18-16 and 18-18 Machines, Nos. 171F, 176D, 207F, 440F, 1549J, 1958, 4785, 6535, 7556, 16080, 16081, two 316F and three 1547J.....
16083	—	Throat Plate Body for 16085, obsolete....
16084	409	“ “ Needle Plate for 16085, obsolete.....
16085	409	Throat Plate complete for 16018, for ⅜ in. to ⅜ in. gauges, and for 6677 for ⅜ in. to ¼ in. gauges, for 18-5, 18-9 and 18-16 Machines, Nos. 228D, 16083 and 16084, obsolete, use 16153.....
16086	3675	Feed Dog (circular feed) for 18-8 Machine
16087	3675	Throat Plate for 16086.....
16088	3676	Feed Dog, for cloth, feeding surface same as 6679, for 18-2 Machine, obsolete....
16089	3676	Throat Plate, large needle hole, for 16088, obsolete.....
16090	—	Throat Plate, small needle hole, for 16088, obsolete.....
16091	406	Shuttle Bobbin Case Latch for 16092....
16092	—	“ “ “ Hinge, Nos. 2974, 16027 and 16091, for 16093.....
16093	406	Shuttle Bobbin Case complete for 16023, Nos. 591F, 592E, 2523, 2975, 6669, 16028 and 16092.....
16094	3676	Feed Dog for 18-2 Machine.....
16095	3676	Throat Plate (fluted) needle hole drilled for No. 1 needle to locate close to the side nearest the feedway, for 16094, 16107 and 16172.....

NO.	PLATE	NAME
16096	3675	Throat Plate (not fluted) needle hole drilled for No. 2 needle to locate close to the side nearest the feedway, for 16078.....
16097	—	Throat Plate (fluted) small needle hole, for 16078.....
16098	3653	Roller Arm for 16099, 16100, 16225, 16226 and 16228.....
16099	3658	Roller Presser complete, 1¼ in. coarse roller, for 18-2, 18-3, 18-7, 18-15 and 18-17 Machines, Nos. 176D, 440F, 1549J, 1839, 2205, 4282, 16098, two 316F and three 1547J.....
16100	—	Roller Presser complete, 1¼ in. fine roller, for 18-2, 18-3, 18-7, 18-15 and 18-17 Machines, Nos. 176D, 440F, 1549J, 1869, 2205, 4282, 16098, two 316F and three 1547J.....
16101	3653	Shuttle Race Lock Pin Bushing for 18-5, 18-9 and 18-16 Machines.....
16102	3652	Arm Side Cover (front) for 18-1 to 18-3 and 18-5 to 18-9 Machines.....
16103	3654	Shuttle Race Cap for 18-5, 18-9 and 18-16 Machines.....
16104	3651	Feed Rock Shaft for 18-17 and 18-18 Machines.....
16105	3653	Shuttle Race Needle Guard for 6764.....
16106	3652	Arm Side Cover (front) for 18-14 to 18-18 Machines.....
16107	3676	Feed Dog, 10 teeth (16 teeth to the inch) for 18-2 and 18-15 Machines.....
16108	3676	Feed Dog for 18-2 Machine.....
16109	3676	Throat Plate (fluted) large needle hole, for 16108.....
16110	—	Throat Plate (fluted) small needle hole, for 16108.....
16111	3652	Oscillating Rock Shaft for 16112.....
16112	—	Oscillating Rock Shaft complete for 18-5, 18-6, 18-9, 18-16 and 18-18 Machines, Nos. 4784, 16111 and 16212.....
16113	3652	Oscillating Shaft for 18-5, 18-6 and 18-9 Machines.....
16114	3652	Oscillating Shaft for 18-16 and 18-18 Machines.....
16115	—	Oscillating Shaft Crank for 16116.....
16116	3654	Oscillating Shaft Crank complete for 18-5, 18-6, 18-9, 18-16 and 18-18 Machines, Nos. 1518E, 16115, 19390 and two 462C

NO.	PLATE	NAME
*16117	—	Arm and Cylinder for 18-1 and 18-2 Machines, obsolete.....
*16118	—	Arm and Cylinder for 18-3 Machine.....
*16119	—	“ “ “ “ 18-5 Machine.....
*16120	—	“ “ “ “ 18-6 Machine.....
*16121	—	Arm and Cylinder for 18-7 and 18-8 Machines.....
*16122	—	Arm and Cylinder for 18-9 Machine.....
*16123	—	“ “ “ “ 18-17 Machine.....
*16124	—	“ “ “ “ 18-18 Machine.....
16125	—	Throat Plate, small needle hole, for 6504
16126	3650	Lifting Lever Pitman for 16127.....
16127	—	Foot Lever complete, Nos. 5598, 9079, 16126, 24379, 24383, 24385, 24386 and two each 24384 and wood screws $\frac{3}{4}$ in. No. 6.....
16128	3662	Rock Shaft Hanger (front) with two wood screws 1 in. No. 10, for 16129.....
16129	3662	Rock Shaft complete for 6691, 16044, 16154 and 16155, Nos. 2764, 6337, 6338, 7124, 16128, 16647 and two 2770.....
16130	3652	Lifting Lever Spring for 6691, 6698 and 16154.....
16131	3675	Throat Plate (fluted) needle hole drilled for No. 2 needle to locate close to the side nearest the feedway, for 16078.....
16132	3677	Feed Dog (flat feeding surface) for $\frac{1}{2}$ in. to $\frac{5}{8}$ in. gauges, for 18-5 and 18-16 Machines, obsolete.....
16133	—	Throat Plate Body for 16135, obsolete...
16134	3677	“ “ Needle Plate for 16135, obsolete.....
16135	3677	Throat Plate complete for 16132, for $\frac{1}{2}$ in. to $\frac{5}{8}$ in. gauges, and for 16150, for $\frac{3}{2}$ in. to $\frac{1}{4}$ in. gauges, for 18-5 and 18-16 Machines, Nos. 228d, 16133 and 16134, obsolete.....
16136	3651	Tension and Needle Bar Guide Bracket for 16137.....
16137	—	Tension and Needle Bar Guide Bracket complete for 18-5, 18-6, 18-16 and 18-18 Machines, Nos. 16136, two each 637c, 1560c, 2103 and four 2102.....
16138	3659	Roller Needle Guard (round) with 242d and 16139, for 16014.....
16139	3659	Roller Needle Guard (round) Edge Guide for*16138.....

NO.	PLATE	NAME
16140	3678	Feed Dog, for cloth, for 18-2 Machine, obsolete.....
16141	3678	Throat Plate for 16140, obsolete.....
16142	3655	Cloth Plate Bracket with 1107c, for 6454
16143	3655	“ “ “ “ “ “ 6478 and 16161.....
16144	3657	Needle Bar Stop Collar, for left hand needle, for 16065.....
Nos. 16145 TO 16150 FOR 18-5 AND 18-16 MACHINES		
16145	3656	Presser Bar (hollow).....
16146	3657	“ “ Lifting Bracket with 175J and two 457K, obsolete, use 16198.....
16147	3656	Presser Bar Spring (heavy) .063 wire.....
16148	3657	“ “ Stop Collar with 1019c.....
16149	3657	Tension Releaser Bracket with two 465c
16150	3677	Feed Dog (flat feeding surface) for $\frac{3}{8}$ in. to $\frac{1}{4}$ in. gauges, for 18-5 and 18-16 Machines, obsolete.....
16151	—	Throat Plate Body for 16153.....
16152	3677	“ “ Needle Plate for 16153.....
16153	3677	Throat Plate complete for 16018, for $\frac{1}{2}$ in. to $\frac{5}{8}$ in. gauges, and for 6677, for $\frac{3}{2}$ in. to $\frac{1}{4}$ in. gauges, Nos. 228d, 16151 and 16152.....
16154	—	Knee Lifter complete for 18-1 to 18-3 and 18-5 to 18-8 Machines on Base, Nos. 802d, 6692, 7898, 16129 and 16130.....
16155	—	Knee Lifter complete for 18-14 to 18-18 Machines on Base, Nos. 802d, 7898, 16042, 16043 and 16129.....
16156	3656	Presser Bar Spring (light) .055 wire, for 18-5 and 18-16 Machines.....
*16157	—	Arm and Cylinder for 18-1 and 18-2 Machines, obsolete.....
16158	3655	Cloth Plate for 16160.....
16159	3655	“ “ Slide for 16160.....
16160	3655	Cloth Plate complete for 16161, Nos. 3286, 16158, 16159 and two 725J.....
16161	—	Cloth Plate with Bracket complete for 18-1 Machine, Nos. 16143, 16160 and two 389F.....
16162	3678	Feed Dog for 18-1 Machine.....
16163	3656	Shuttle Race Cap for 16164.....
16164	—	Shuttle Race Cap complete for 18-1 Machine, Nos. 6472, 16163 and two 725J.....

NO.	PLATE	NAME
16165	3678	Throat Plate for 16162.....
16166	403	Shuttle Race Body (two pieces) with either 813d, 814d or 815d, for 6746
16167	3657	Needle Bar Coupling Pin Lever Bell Crank Cap Screw Washer for 18-9 Machine...
16168	400	Feed Wheel Driving Spring for 18-3, 18-6, 18-17 and 18-18 Machines.....
16169	3656	Oscillating Shaft for 18-17 Machine.....
*16170	—	Arm and Cylinder for 18-1 and 18-2 Machines.....
16171	3656	Shuttle Race (steel) for 16218 and 18-1 Machine.....
16172	3676	Feed Dog, 13 teeth (22 teeth to the inch) for 18-2 and 18-15 Machines.....
*16173	—	Arm and Cylinder for 18-15 Machine....
16174	3664	Shuttle Race (steel) for 16227.....
16175	3664	“ Driver and Feed Lifting Cam for 18-15 Machine.....
16176	—	Oscillating Rock Shaft complete for 18-1 to 18-3, 18-7, 18-8, 18-14, 18-15 and 18-17 Machines, Nos. 6461 and 16212
16178	—	Needle Bar 4344 with 2273 and 4345, for 18-5, 18-6, 18-16 and 18-18 Machines
16179	—	Thread Take-up Lever 16041 with 76f, for 18-14 and 18-15 Machines.....
16180	—	Thread Take-up Lever 6474 with 76f, for 18-1 to 18-3, 18-7, 18-8 and 18-17 Machines.....
16181	—	Thread Take-up Lever 6704 with 76f, for 18-5, 18-6, 18-9, 18-16 and 18-18 Machines.....
16182	—	Needle Bar 4344 with 2273 and 6524, for 18-5, 18-6, 18-16 and 18-18 Machines
*16192	—	Oscillating Shaft Crank for 16193.....
*16193	—	Oscillating Shaft Crank complete for 18-5, 18-6, 18-9, 18-16 and 18-18 Machines, Nos. 462c, 1518e, 16192 and 19390.....
16194	3664	Presser Bar Lifting Bracket with 175j and two 457k, for 16195.....
16195	—	Presser Bar Lifting Bracket 16194 with 16196 and two 335j, for 18-1 to 18-3, 18-6 to 18-9, 18-14, 18-15, 18-17 and 18-18 Machines.....
16196	3664	Presser Bar Lifting Bracket Wearing Plate for 16195 and 16198.....

NO.	PLATE	NAME
16197	3664	Presser Bar Lifting Bracket with 175j and two 457k, for 16198.....
16198	—	Presser Bar Lifting Bracket 16197 with 16196 and two 335j, for 18-5 and 18-16 Machines.....
16202	—	Tension Screw Stud 600c with 1560c, for 16204.....
16204	—	Tension complete for 18-1 to 18-3, 18-7, 18-8, 18-14, 18-15 and 18-17 Machines, Nos. 2103, 16202 and two 2102.....
*16205	—	Shuttle (inside) Cover for 16206.....
16206	3668	Shuttle (inside) closed eye, complete, for $\frac{1}{2}$ in. to $\frac{1}{4}$ in. gauges, for 18-5, 18-6, 18-9, 18-16 and 18-18 Machines, Nos. 112e, 466c, 2076, 2078, 2080, 2086, 2090, 2210, 3235 and 16205.....
*16207	—	Shuttle (outside) Cover for 16208 and 16209.....
16208	3668	Shuttle (outside) closed eye, complete, for $\frac{3}{8}$ in. to $\frac{1}{4}$ in. gauges, for 18-5, 18-6, 18-9, 18-16 and 18-18 Machines, Nos. 112e, 466c, 2076, 2080, 2210, 3238, 3241, 3242, 3383 and 16207.....
16209	3668	Shuttle (outside) closed eye, complete, for $\frac{3}{8}$ in. to $\frac{1}{4}$ in. gauges, for 18-5, 18-6, 18-16 and 18-18 Machines, Nos. 112e, 466c, 2076, 2080, 2210, 3232, 3238, 3241, 3242 and 16207.....
16212	—	Oscillating Rock Shaft Hinge Pin 6489 with 1513j, for 16112 and 16176.....
16213	3664	Shuttle Driver and Feed Lifting Cam for 18-5, 18-9 and 18-16 Machines.....
16218	—	Shuttle Race (steel) 16171 with 6471 and two 102d, for 18-2 Machine.....
16220	—	Needle Bar Connecting Link 3045 with 377c, 1518e and 6487, for all machines except 18-9.....
16225	3666	Roller Presser complete, $1\frac{1}{4}$ in. coarse roller, for 18-2, 18-3, 18-7, 18-15 and 18-17 Machines, Nos. 176d, 440f, 1549j, 1897, 2205, 4282, 16098, two 316f and three 1547j.....
16226	—	Roller Presser complete, $1\frac{1}{4}$ in. fine roller, for 18-2, 18-3, 18-7, 18-15 and 18-17 Machines, Nos. 176d, 440f, 1549j, 1898, 2205, 4282, 16098, two 316f and three 1547j.....



## NUMERICAL LIST OF PARTS

NO.	PLATE	NAME
16227	—	Shuttle Race 16174 with 6471 and two 102d, for 18-15 Machine.....
16228	3666	Roller Presser complete, 1¼ in. coarse roller, for 18-2, 18-3, 18-7, 18-15 and 18-17 Machines, Nos. 176d, 440f, 1549j, 1923, 2205, 4282, 16098, two 316f and three 1547j.....
16230	3665	Roller Arm for 16233 and 16236.....
16231	3665	“ “ “ 16234, 16235 and 16237..
16232	3665	“ Ball, size ⅜ in., for 51833, 51835, 51842 and 51856.....
16233	3665	Roller Presser (ball bearing) complete, 1¼ in. coarse roller, ⅜ in. face, for 18-2, 18-3, 18-7, 18-15 and 18-17 Machines, Nos. 176d, 440f, 1549j, 2205, 4282, 16230, 51833, two 316f and three 1547j.....
16234	3666	Roller Presser (ball bearing) complete, 1½ in. roller, ⅝ in. face, for ⅜ in. to ⅜ in. gauges, for 18-5, 18-6, 18-16 and 18-18 Machines, Nos. 171f, 176d, 207f, 440f, 1549j, 4785, 7556, 16080, 16081, 16231, 51835, two 316f and three 1547j.....
16235	—	Roller Presser (ball bearing) complete, 1½ in. roller, ⅝ in. face, for ⅜ in. to ¼ in. gauges, for 18-5, 18-6, 18-16 and 18-18 Machines, Nos. 171f, 176d, 440f, 1549j, 7556, 16016, 16231, 19200, 51835, two 316f and three 1547j.....
16236	3665	Roller Presser (ball bearing) complete, 1¼ in. coarse roller, ⅜ in. face, for 18-2, 18-3, 18-7, 18-15 and 18-17 Machines, Nos. 176d, 440f, 1549j, 2205, 4282, 16230, 51842, two 316f and three 1547j.....
16237	3669	Roller Presser (ball bearing) complete, 1½ in. roller, ⅝ in. face, for ⅜ in. to ⅜ in. gauges, for 18-5 Machine, Nos. 171f, 176d, 207f, 440f, 1549j, 4785, 7556, 16080, 16081, 16231, 51856, two 316f and three 1547j.....
16238	3668	Shuttle Race Body (two pieces) with either 813d, 814d or 815d, for 16239..
16239	3668	Shuttle Race complete, for ⅜ in. to ⅜ in. gauges, for 18-5 and 18-16 Machines, Nos. 6709, 6758, 16238 and two 102d..

## NUMERICAL LIST OF PARTS

NO.	PLATE	NAME
Nos. 16642 to 16644 for 18-1 MACHINE		
16642	3656	Needle Bar with 10160.....
16643	3654	“ “ Thread Guard.....
16644	3654	“ Clamp with 1112f.....
16646	3662	Rock Shaft Knee Arm for 16647.....
16647	—	Rock Shaft Knee Arm complete for 6339 and 16129, Nos. 2766, 2767 and 16646
19200	404	Roller Arm Bracket for 16017, 16066, 16071 and 16235.....
19389	3654	Oscillating Shaft Crank Slide Block for 19390.....
19390	3654	Oscillating Shaft Crank Slide Block complete for 16116 and 16193, Nos. 226d, 969c, 12424 and 19389.....
24378	2637	Foot Lever with two 1157c, for 24379....
24379	2637	“ “ 24378 with 5671, 24380, 24381 and four wood screws 1 in. No. 12, for 16127.....
24380	2637	Foot Lever Bracket for 24379.....
24381	2637	“ Rest with 24382, for 24379.....
24382	2638	“ “ Pin for 24381.....
Nos. 24383 to 24386 for 16127		
24383	2637	Pitman Rod (lower) 17 in. long.....
24384	2638	“ “ “ Stop Collar with 1157c.....
24385	2637	Pitman Rod (upper) 17 in. long, with 2761
24386	2637	“ “ “ Guide Bracket with three wood screws 1 in. No. 12.....
25024	—	Belt, size ¼ in., length 68 in., with 25127, for 25273.....
25065	3667	Leg for 25273.....
25078	3667	Table Support for 25273.....
25086	3667	Wrench for 1507, 1510 and 1670, for 25273
25127	3826	Belt Hook for 25024.....
25200	3667	Wrench for 972, for 25273.....
25273	—	Stand (iron work) rocking treadle, ball bearing pitman, complete, Nos. 1059a, 25078, 25086, 25200, 25369, 46520, 46553, 46554, two 25075 and four 506a
*25360	—	Pitman Rod Ball for 46523.....
25361	3826	“ “ “ Screw Bearing for 46630
25362	3826	“ Ball, size ⅜ in., for 46520.....
25369	3810	Brace with three 46629, for 25273.....
25371	3826	Pitman Rod Ball Bushing for 46520.....

NO.	PLATE	NAME
26026	413	Screw Driver, machine (Attachments and Accessories).....
26485	413	Screw Driver, shuttle tension (Attachments and Accessories).....
27305	3660	Bobbin Winder Spindle for 27652.....
27321	3660	" " Frame for 27652 and 27653.....
27322	3661	Bobbin Winder Frame Spring for 27652 and 27653.....
27323	3660	Bobbin Winder Spool Pin for 27325.....
27324	3660	" " " Stand for 27325....
27325	3660	Bobbin Winder Spool Stand complete for 27546 and 27547, Nos. 418E, 1562D, 10141, 11241, 27323, 27324, 34358 and two each 2455 and wood screw 1 in. No. 10.....
27326	3660	Bobbin Winder Stop Latch for 27652....
27328	3660	" " " " 27653....
27538	3660	" " Spindle 27849 with 15072, 27850 and 41828, for 27653.....
27541	3660	Bobbin Winder Pulley for 27652 and 27653.....
27545	3660	Bobbin Winder Base for 27652 and 27653
27546	—	Bobbin Winder (swinging automatic, left hand) complete, for 2073 and 2210, Nos. 27325 and 27652.....
27547	—	Bobbin Winder (swinging automatic, left hand) complete for 2996, Nos. 27325 and 27653.....
27652	3660	Bobbin Winder, Nos. 35D, 1620J, 27305, 27321, 27322, 27326, 27541, 27545, 50356D and two wood screws 1 in. No. 7, for 27546.....
27653	—	Bobbin Winder, Nos. 35D, 1620J, 27321, 27322, 27328, 27538, 27541, 27545, 50356D and two wood screws 1 in. No. 7, for 27547.....
27849	—	Bobbin Winder Spindle for 27538.....
27850	—	" " " Collar for 27538
34358	3664	" " Tension Thread Guide for 27325.....
41828	—	Bobbin Winder Spindle Collar Pin for 27538.....
44001	—	Shuttle Cover 2075 with 112E, 466C, 2078, 2080, 2086 and 2090, for 6028.....

NO.	PLATE	NAME
Nos. 46506 to 46509 FOR 46520		
46506	3826	Pitman Ball Bearing Adjusting Screw Ring.....
46507	3826	Pitman Ball Bearing Adjusting Screw Ring Locking Washer (brass).....
46508	3826	Pitman Ball Bearing Ring.....
46509	3826	" " Case.....
46519	3667	Band Wheel Crank for 46520.....
46520	—	Band Wheel Crank and Pitman (ball bearing) complete for 25273, Nos. 1520R, 25371, 46506 to 46509, 46519, 46523, 46630, 46655 and six 25362....
46523	3667	Pitman Rod with 25360, for 46520.....
46550	3667	Brace (sectional) complete for 25273, Nos. 46551, 46552 and three 649R....
46551	3667	Brace Section (left) with two 46629, for 46550.....
46552	3667	Brace Section (right) with 46629, for 46550
46553	3667	Band Wheel, 12½ in. diam., with 972C, for 25273.....
46554	3667	Treadle for 25273.....
46629	—	Band Wheel Crank Screw Centre 297C with 1507R, for 25369 and 46551.....
46629	—	Treadle Screw Centre 297C with 1507R, for 25369, 46551 and 46552.....
46630	—	Pitman Rod Ball Screw Bearing 25361 with 1670R, for 46520.....
46655	3826	Pitman Ball Separator for 46520.....
50008J	412	Shuttle Race Ring Screw for 6769.....
50014F	3654	Needle Set Screw for 6524.....
50037D	3664	Shuttle Race Screw for 18-1, 18-2, 18-6, 18-15 and 18-18 Machines.....
50356D	3665	Bobbin Winder Frame Hinge Screw for 27652 and 27653.....
50553C	3665	Roller Screw for 51833, 51835, 51842 and 51856.....
51072E	401	Machine Bolt with 51581E, to secure machine to table (Attachments and Accessories).....
51581E	401	Machine Bolt Nut for 51072.....
51832	—	Roller, 1¼ in. diam., coarse, for 51833...
51833	3665	Roller (ball bearing) 1¼ in. coarse roller, ½ in. face, Nos. 1528I, 1766C, 50553C, 51832 and twenty-four 16232, for 16233
51834	—	Roller, 1½ in. diam., coarse, for 51835...

## NUMERICAL LIST OF PARTS

NO.	PLATE	NAME
51835	3666	Roller (ball bearing) 1½ in. coarse roller, Nos. 1528I, 1766c, 50553c, 51834 and twenty-four 16232, for 16234 and 16235
51841	—	Roller, 1¼ in. diam., coarse, for 51842...
51842	3665	" (ball bearing) 1¼ in. coarse roller, ½ in. face, Nos. 1528I, 1766c, 50553c, 51841 and twenty-four 16232, for 16236
51855	—	Roller, 1½ in. diam., ⅜ in. face, coarse, for 51856.....
51856	3669	Roller, 1½ in. diam., ⅜ in. face, coarse, (ball bearing) for 16237, Nos. 1528I, 1766c, 50553c, 51855 and twenty-four 16232.....
*56828	—	Thread Take-up Cam (steel) for 3182....
*56831	—	" " " " " 3280....
56848	—	Bell Crank 5596 with 5599 and 5601, for 5598.....
56864	413	Foot Lifter Chain Hook (large) for 6439..
56864	413	Needle Bar Trip Lever Chain Hook (large) for 6439.....
56865	3664	Foot Lifter Chain Hook (small) for 6439..
56865	3664	Needle Bar Trip Lever Chain Hook (small) for 6439.....
120342	413	Oiler (copper plated) with 120343 (Attachments and Accessories).....
120343	413	Oiler Spout, 3½ in. long, for 120342.....

Genuine Singer Needles and their Containers are marked with the Company's Trade Mark "SIMANCO." 1

Needles in Containers marked "For Singer Machines" are not Singer made needles. 2

8903-10

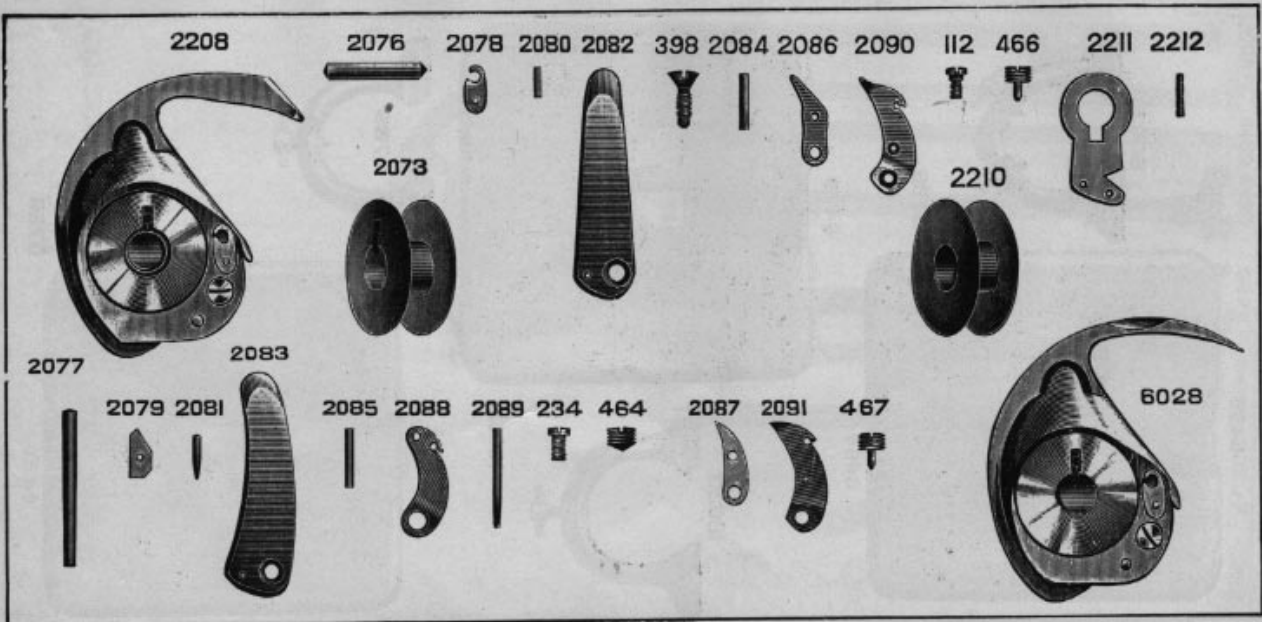

PLATE 217-FULL SIZE

PLATE 390—ONE-FOURTH SIZE

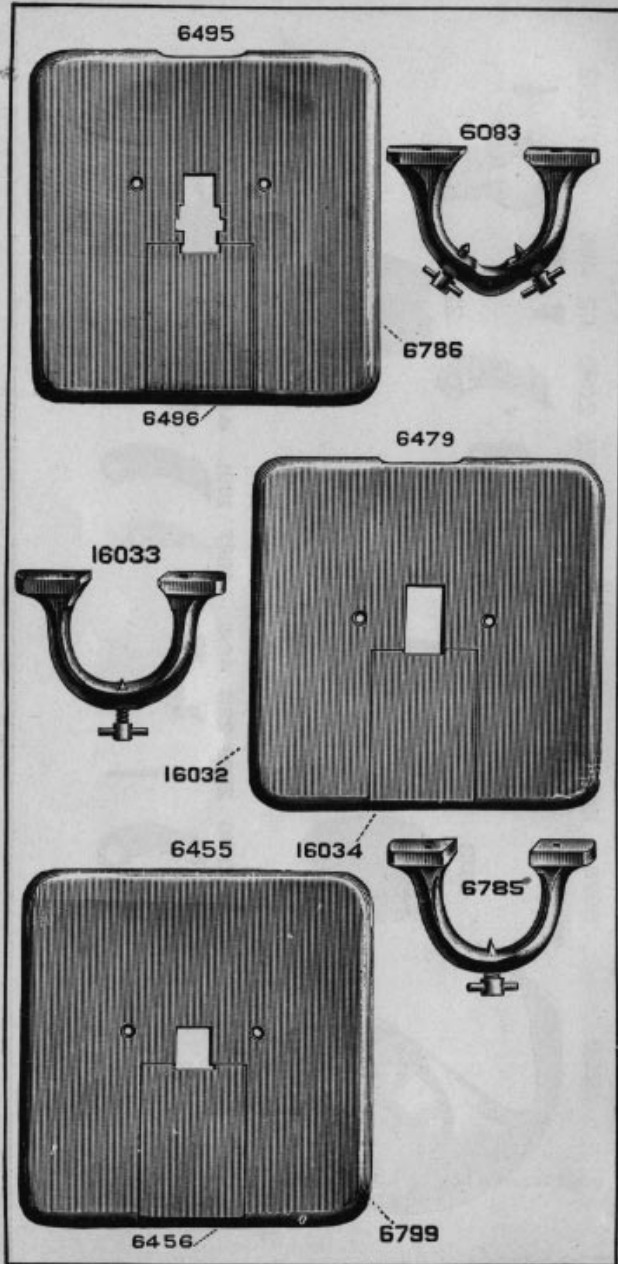

PLATE 391—ONE-FOURTH SIZE

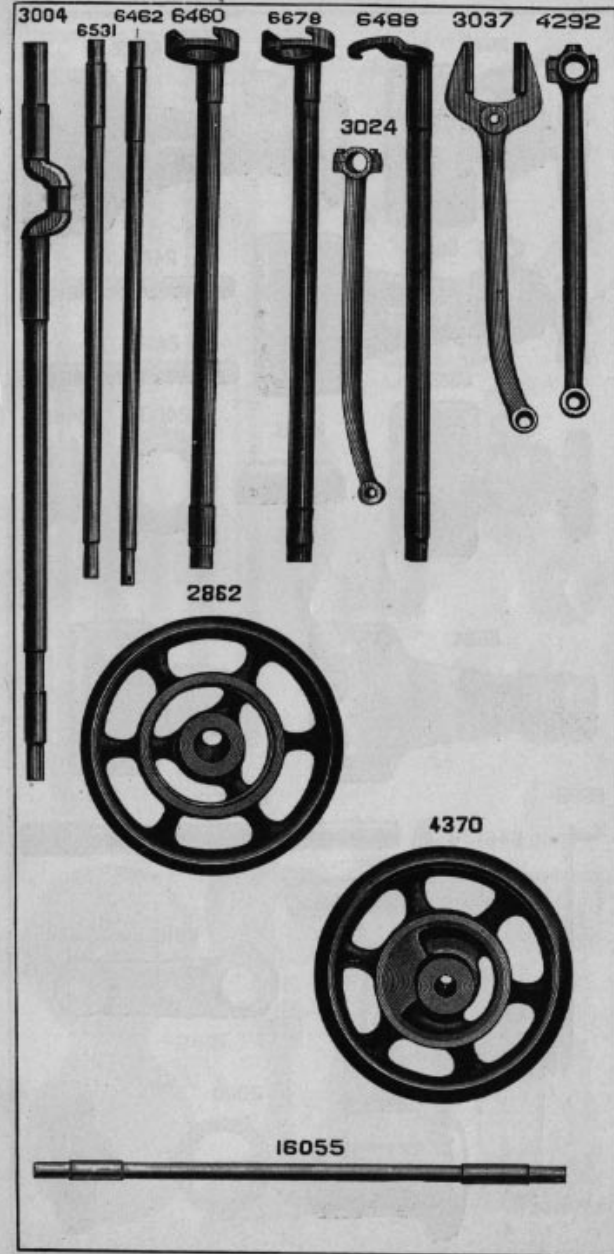

PLATE 392—ONE-HALF SIZE

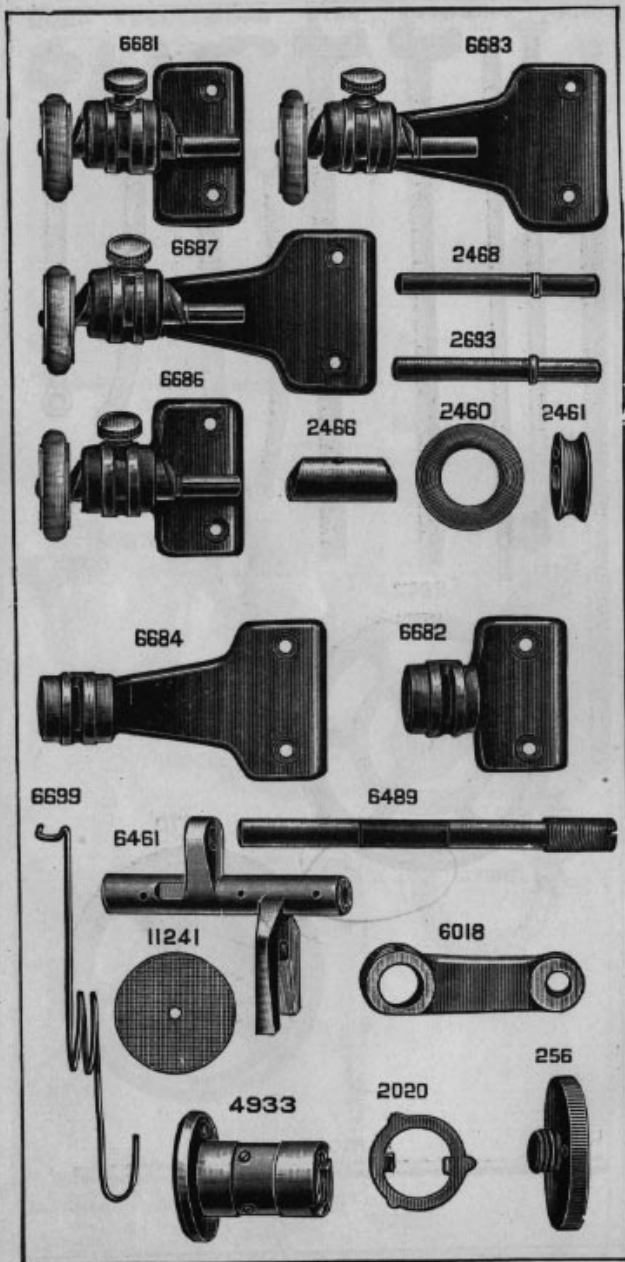

PLATE 393—ONE-HALF SIZE

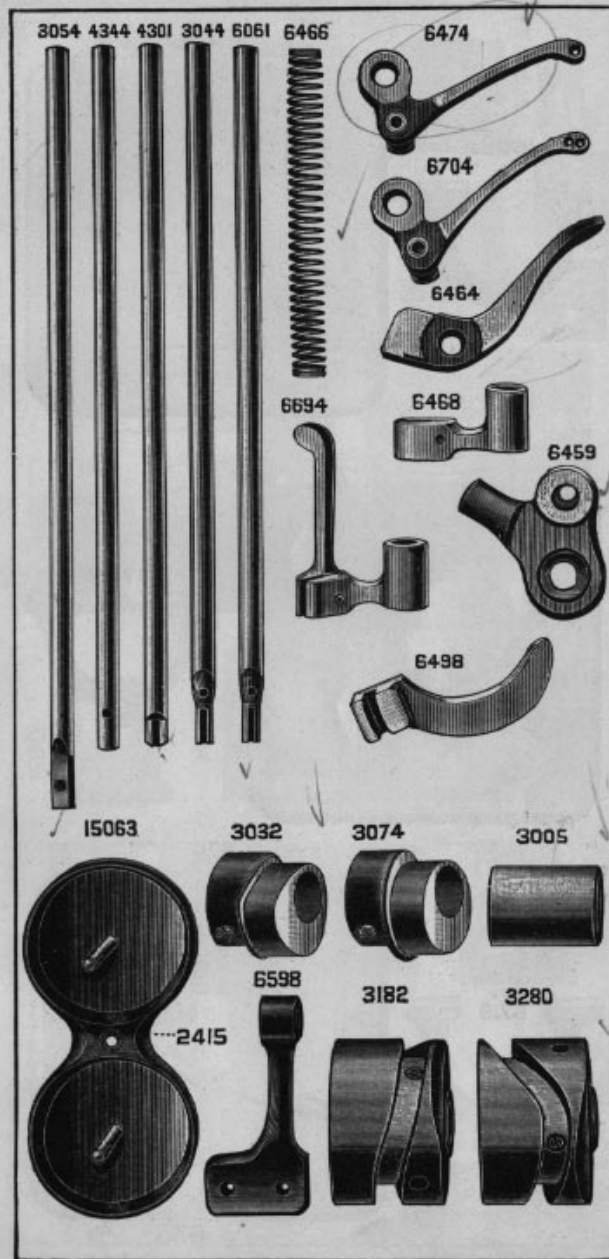

PLATE 394—ONE-FOURTH SIZE

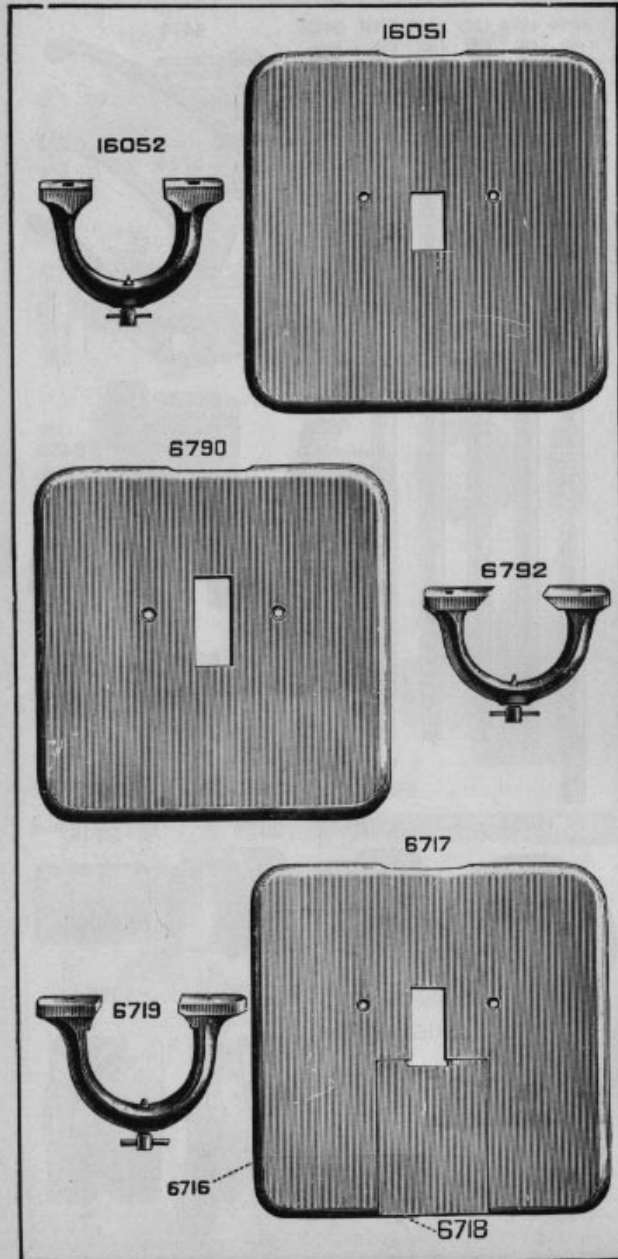

PLATE 396—FULL SIZE

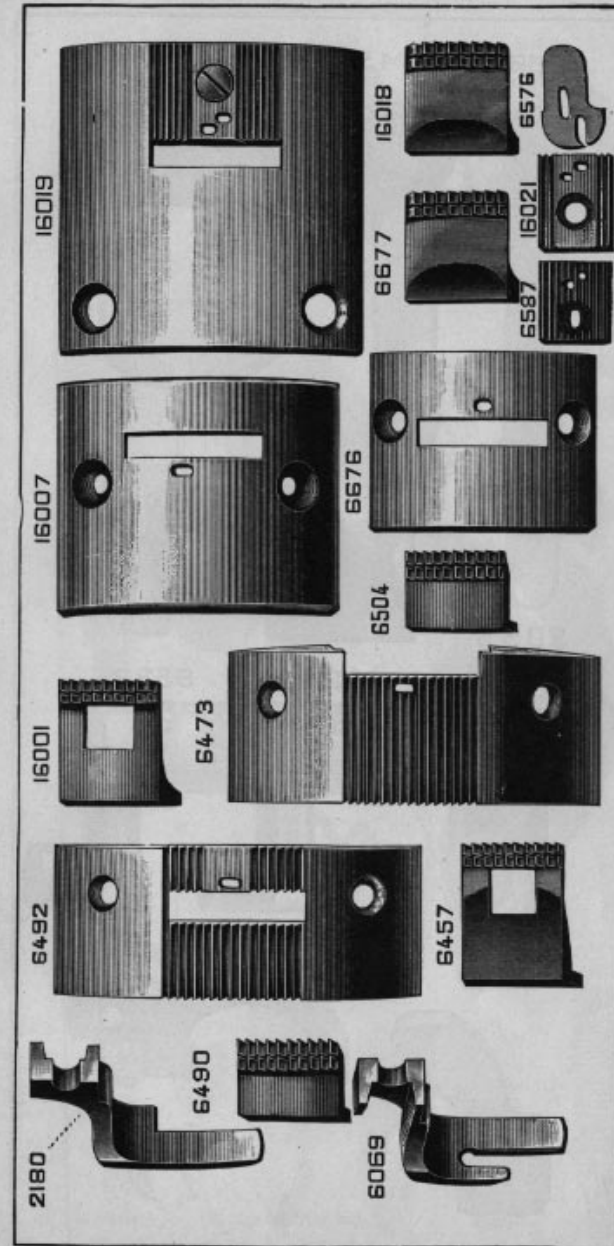



PLATE 397—FULL SIZE

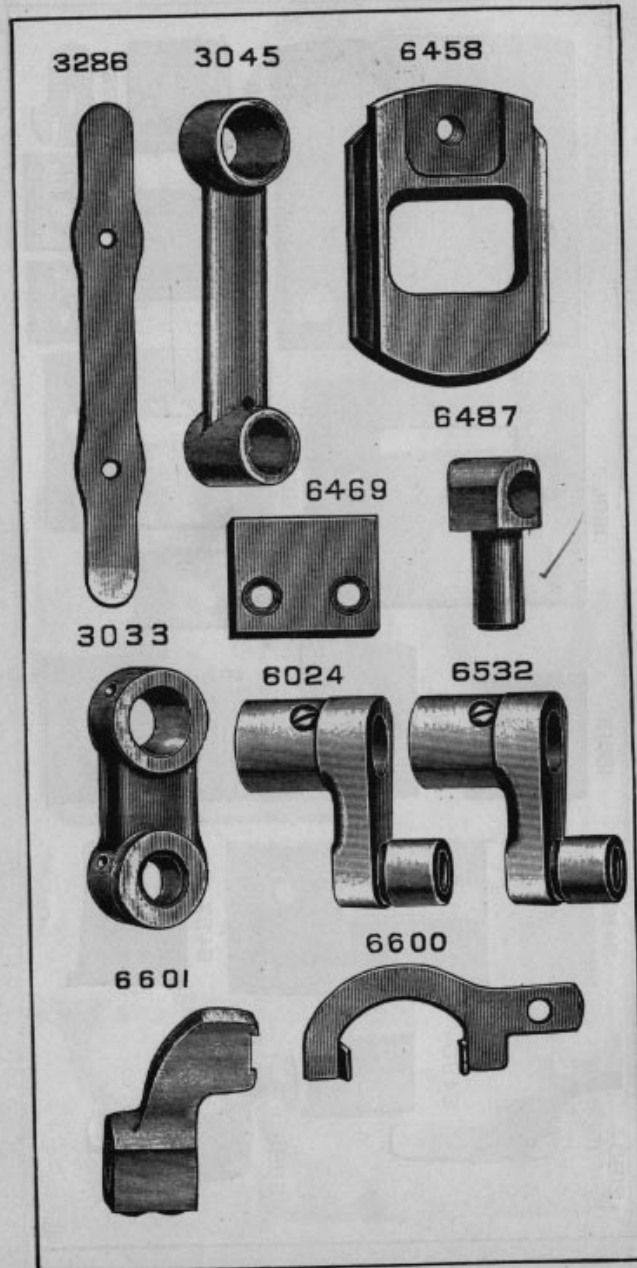

PLATE 398—FULL SIZE

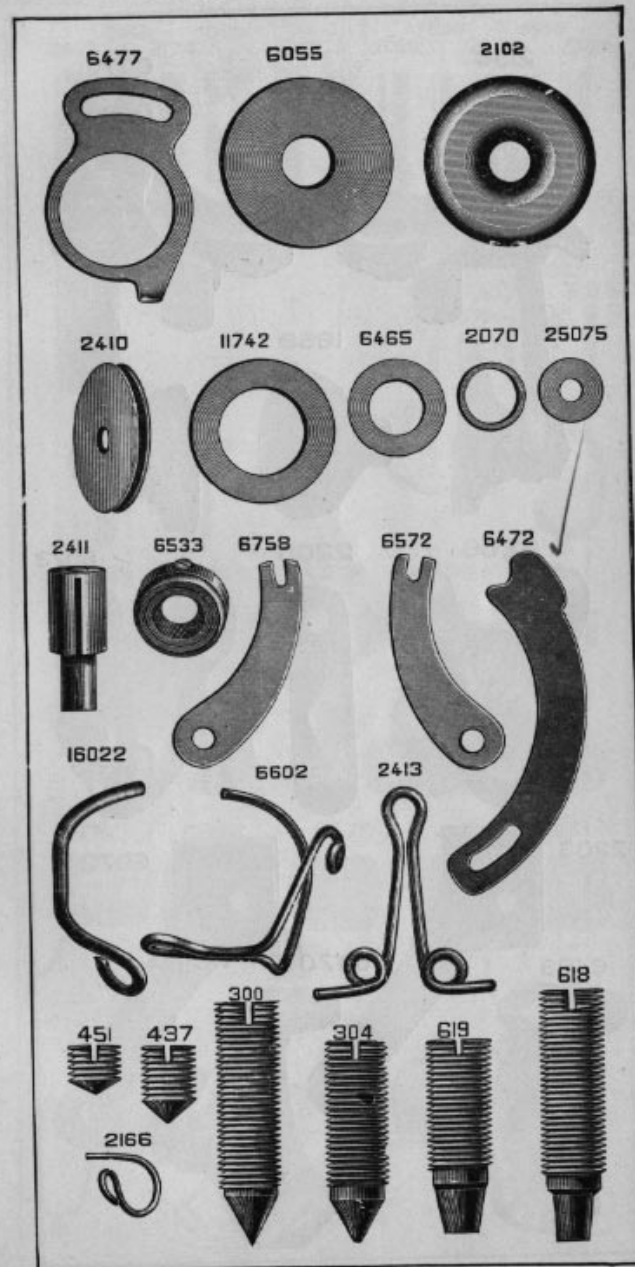



PLATE 399—FULL SIZE

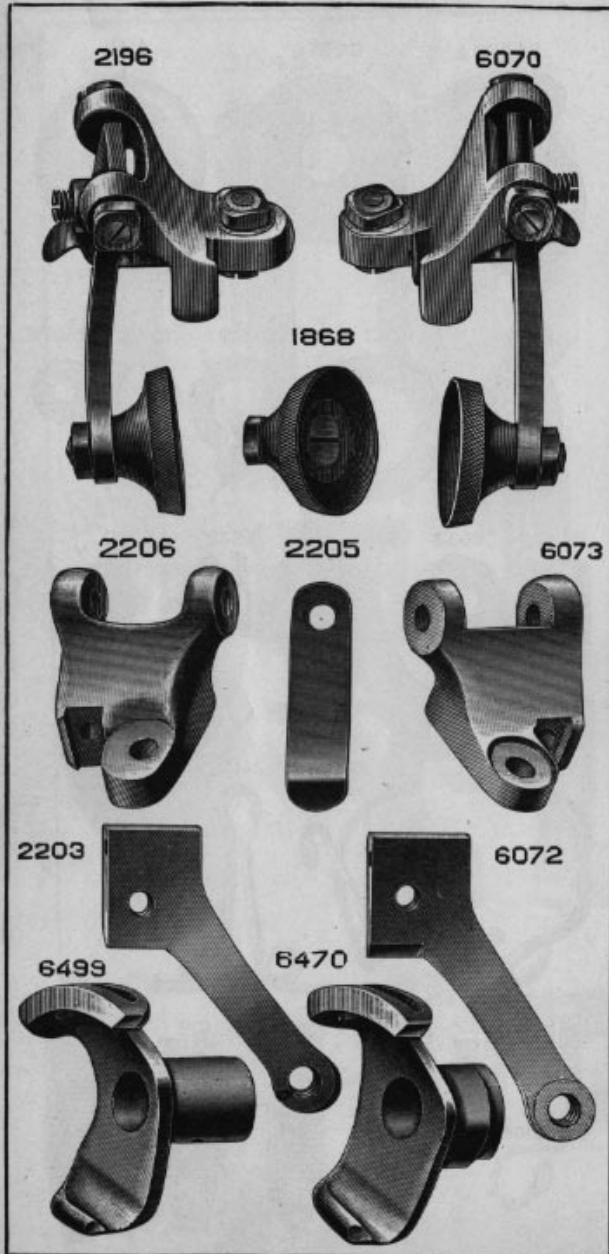

PLATE 400—FULL SIZE

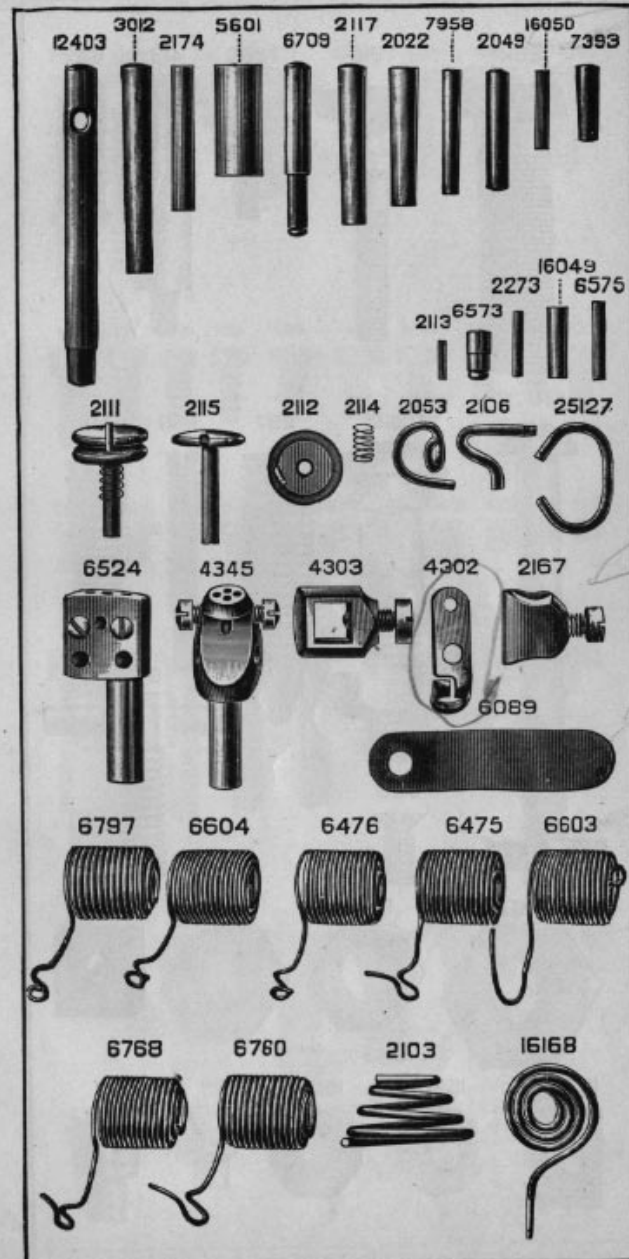

PLATE 401—FULL SIZE

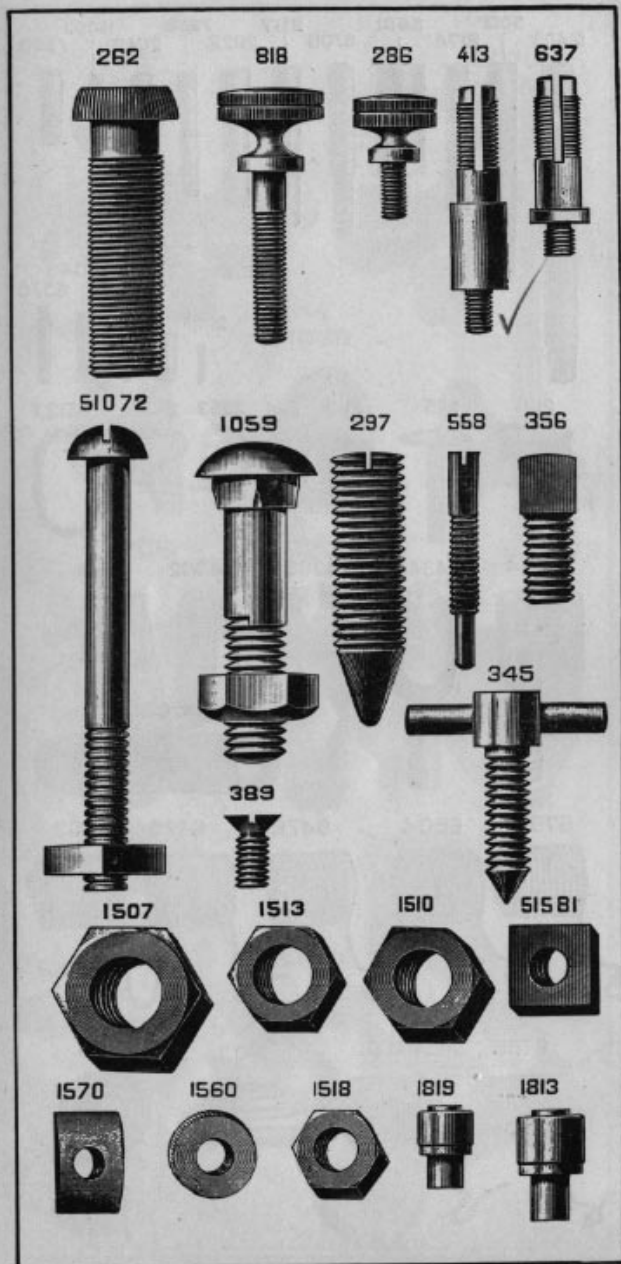

PLATE 402—FULL SIZE

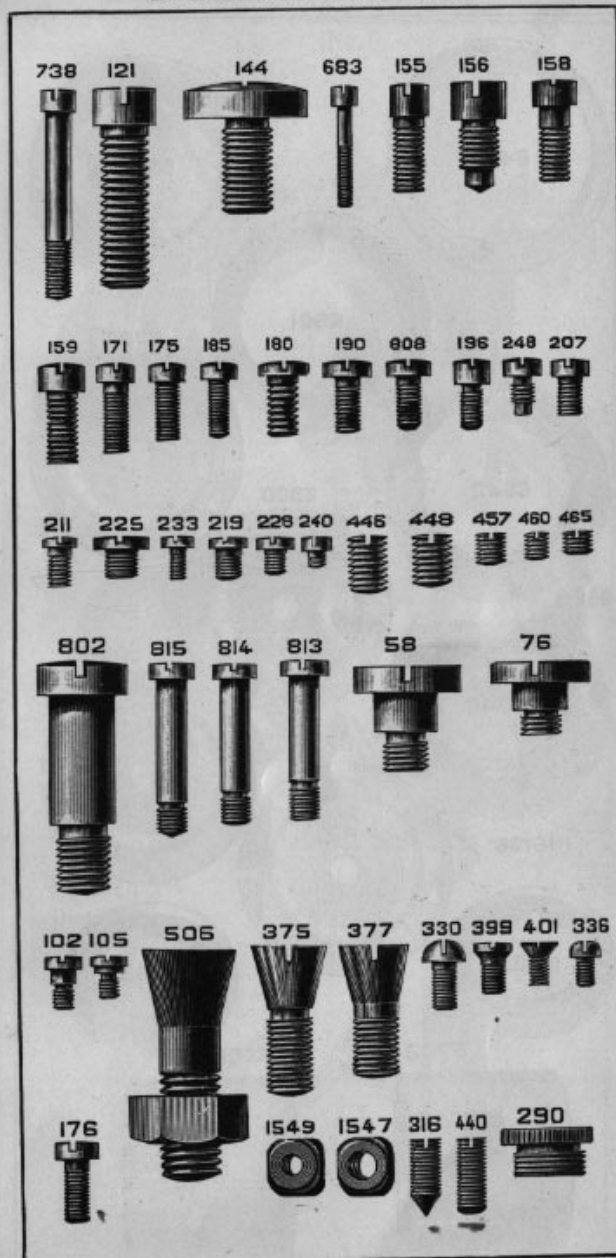

PLATE 403—ONE-HALF SIZE

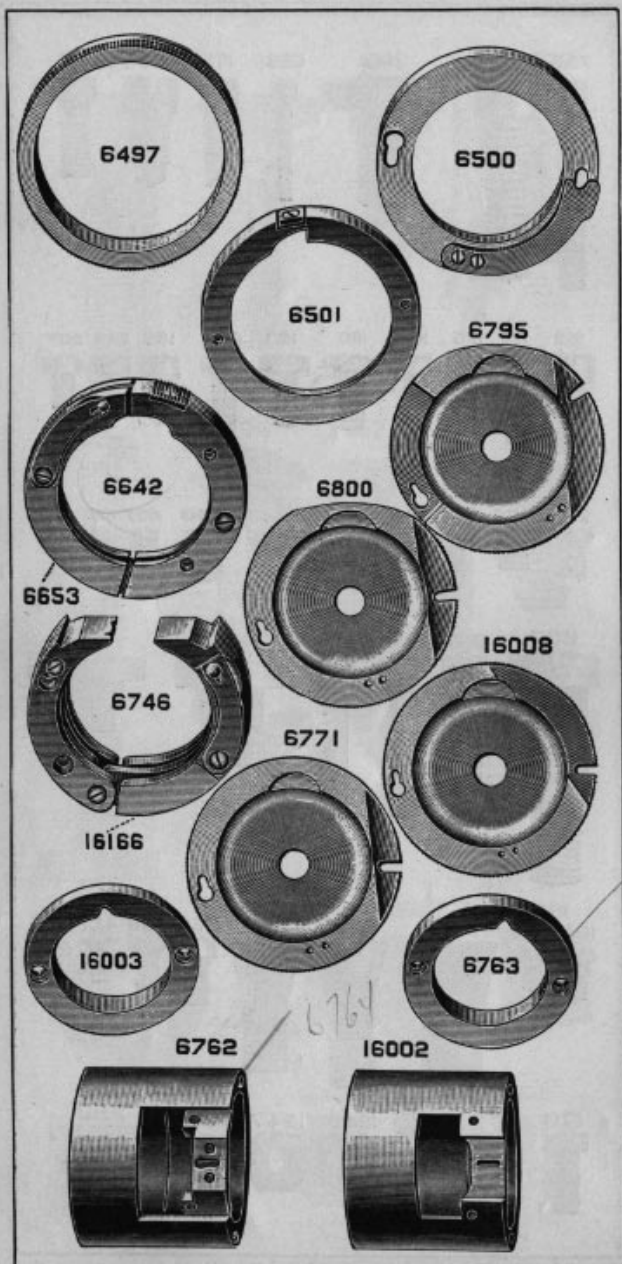
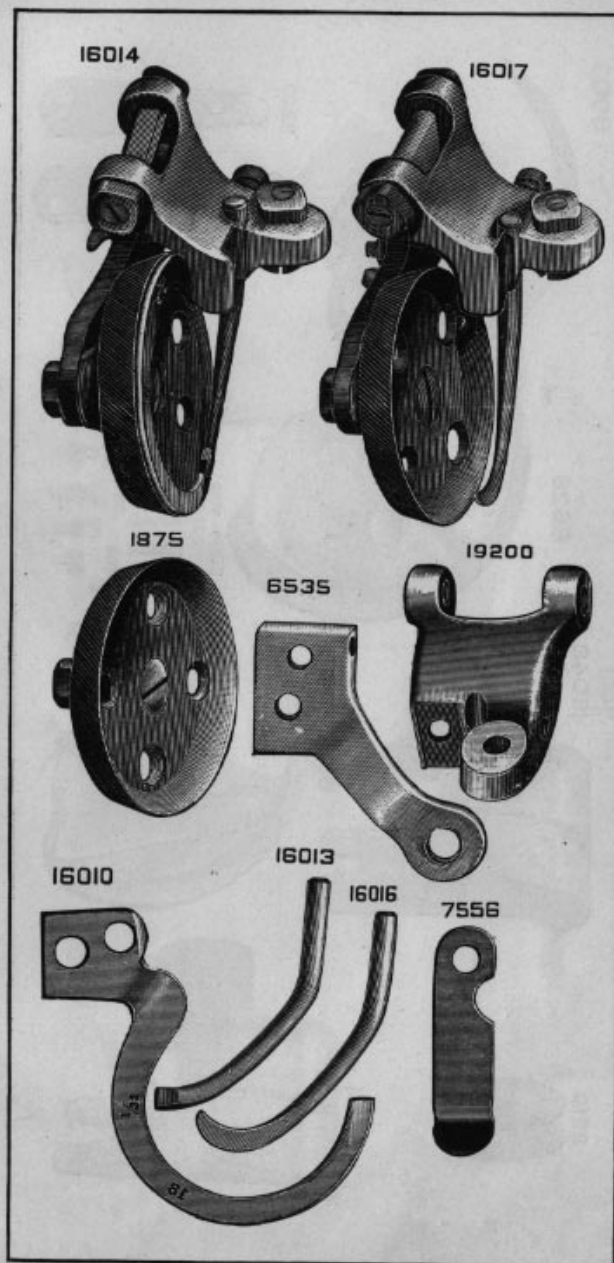

PLATE 404—FULL SIZE



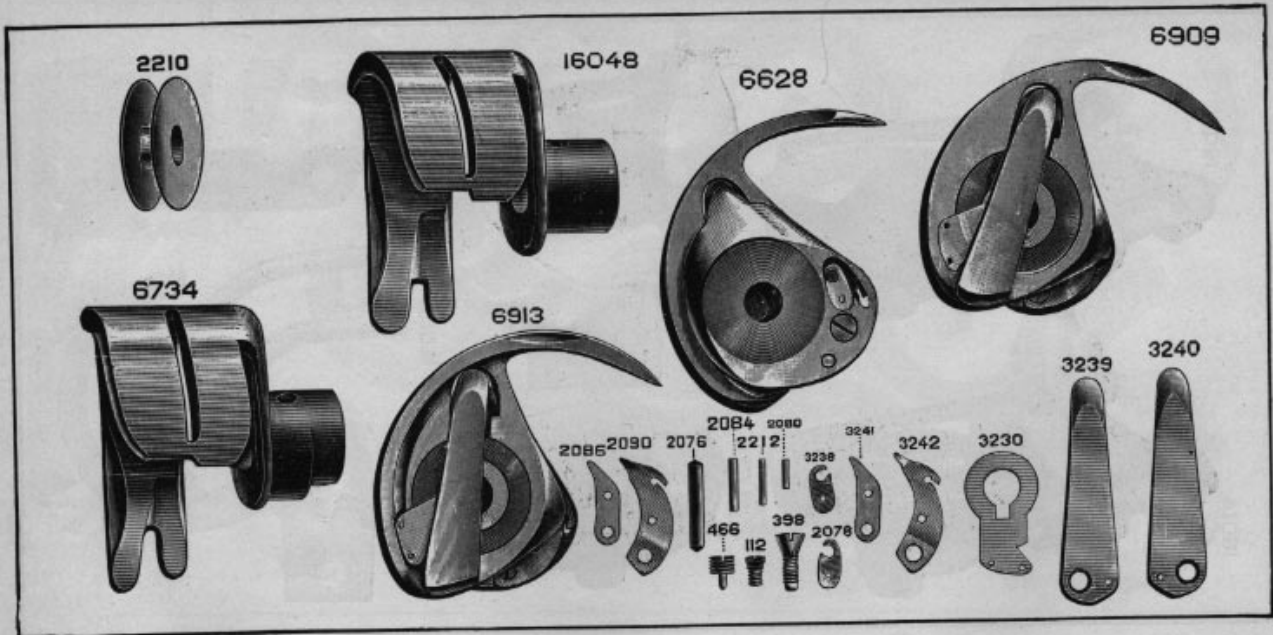

PLATE 405-FULL SIZE

PLATE 406—FULL SIZE

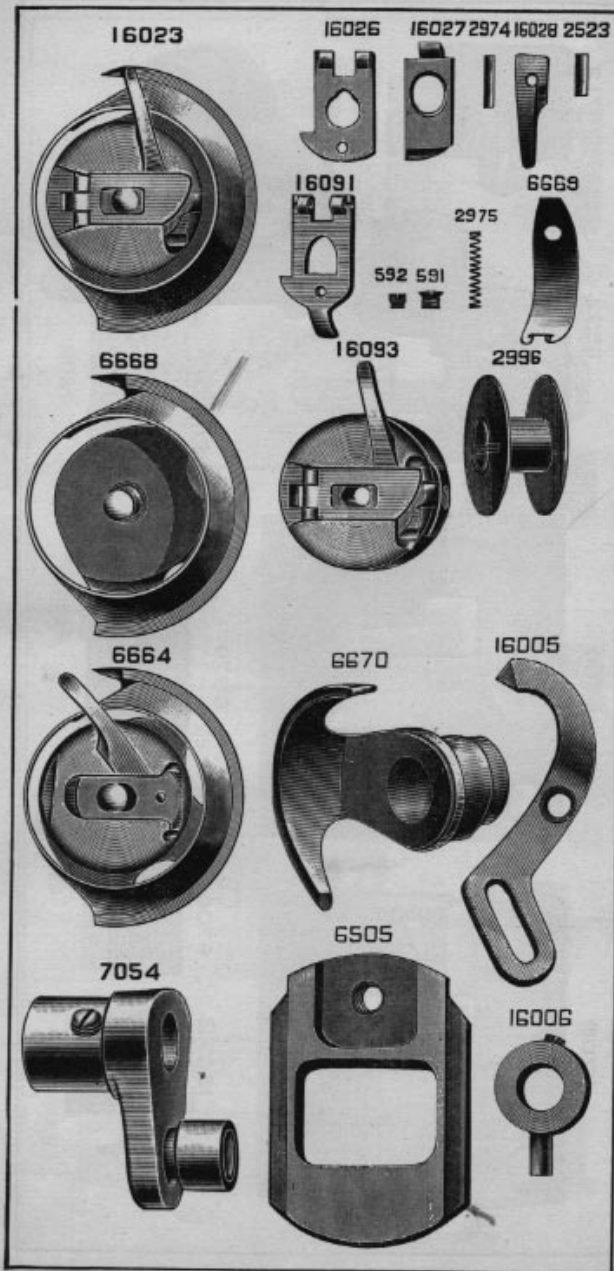



PLATE 407—FULL SIZE

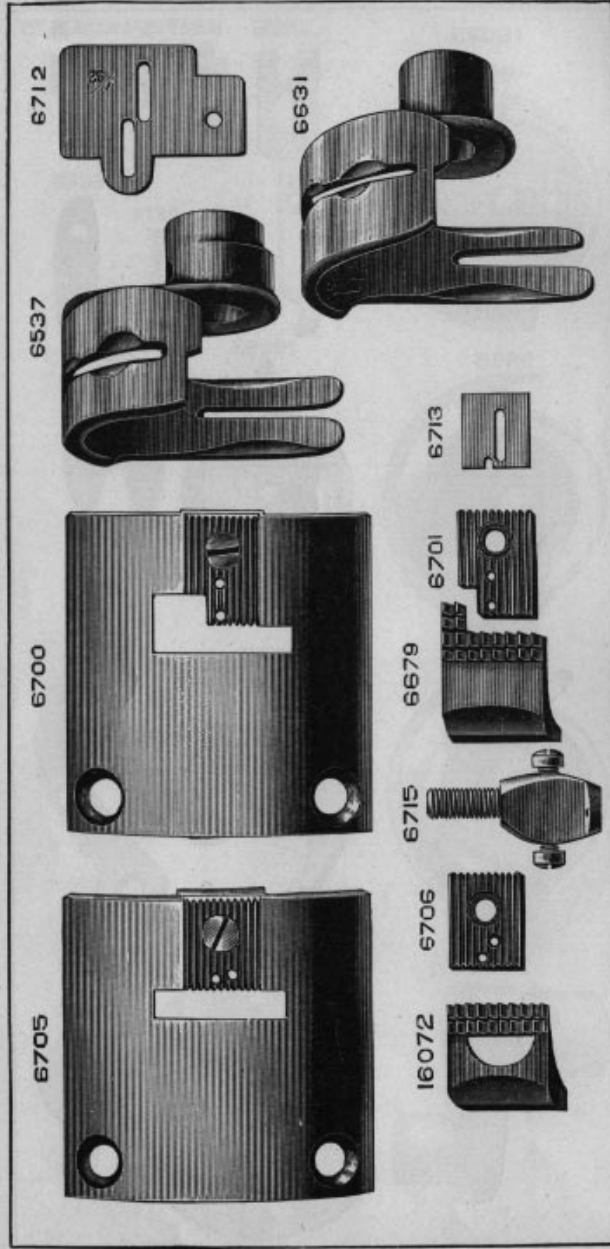

PLATE 408—FULL SIZE

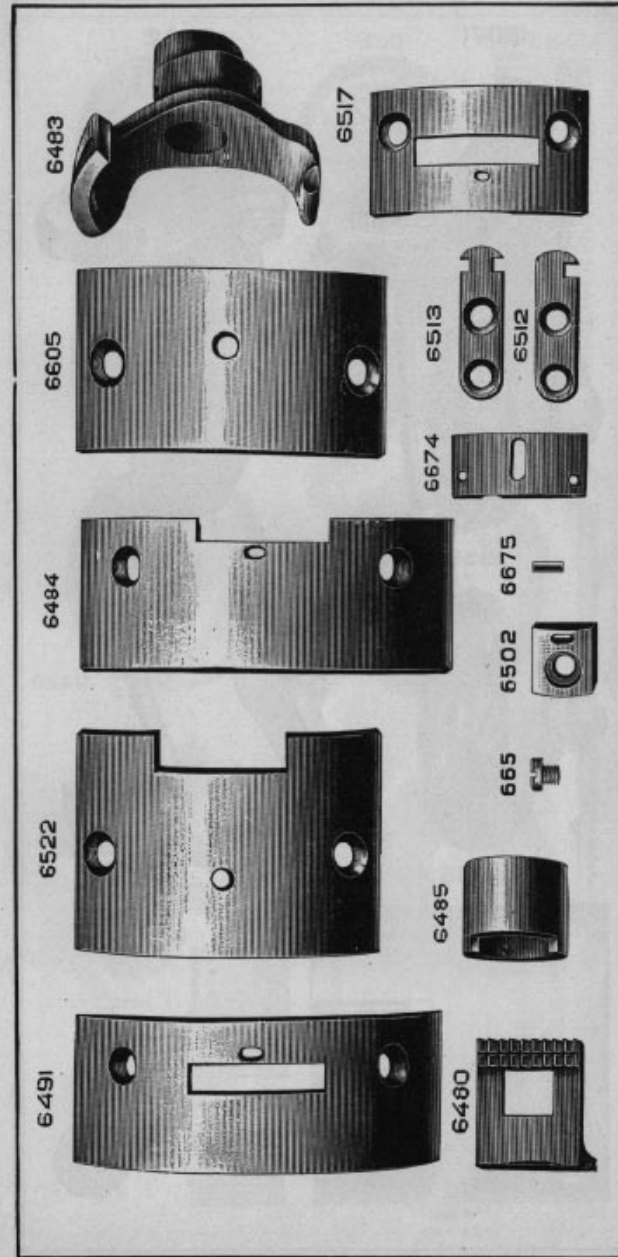

PLATE 409—FULL SIZE

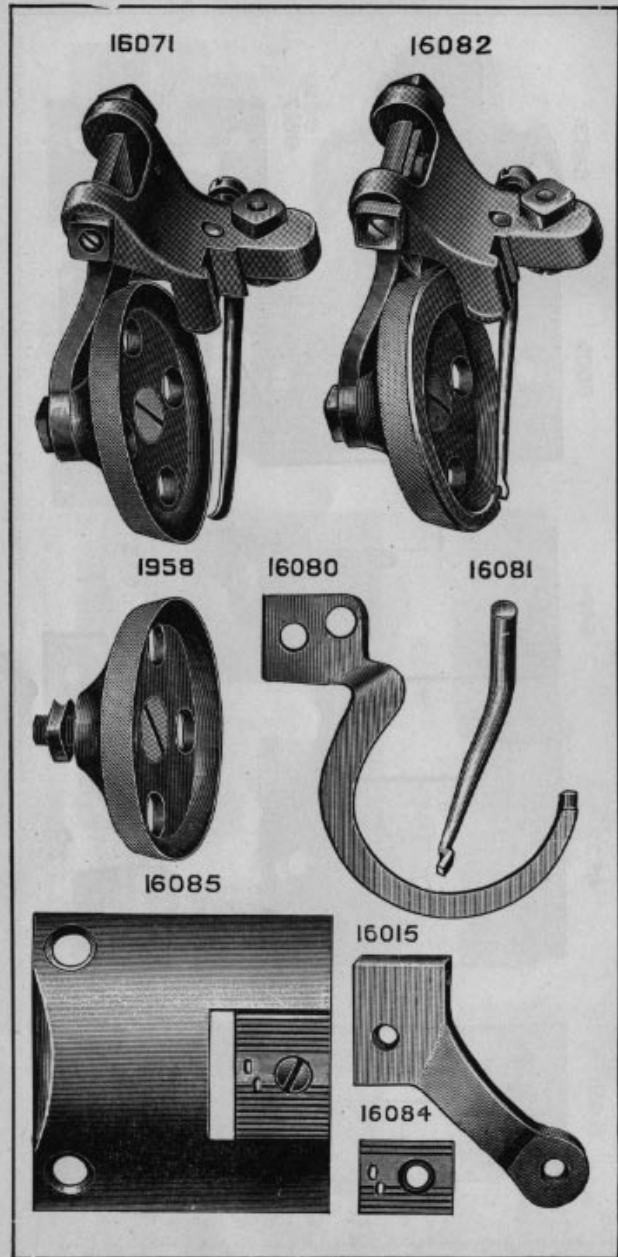

PLATE 410—ONE-HALF SIZE

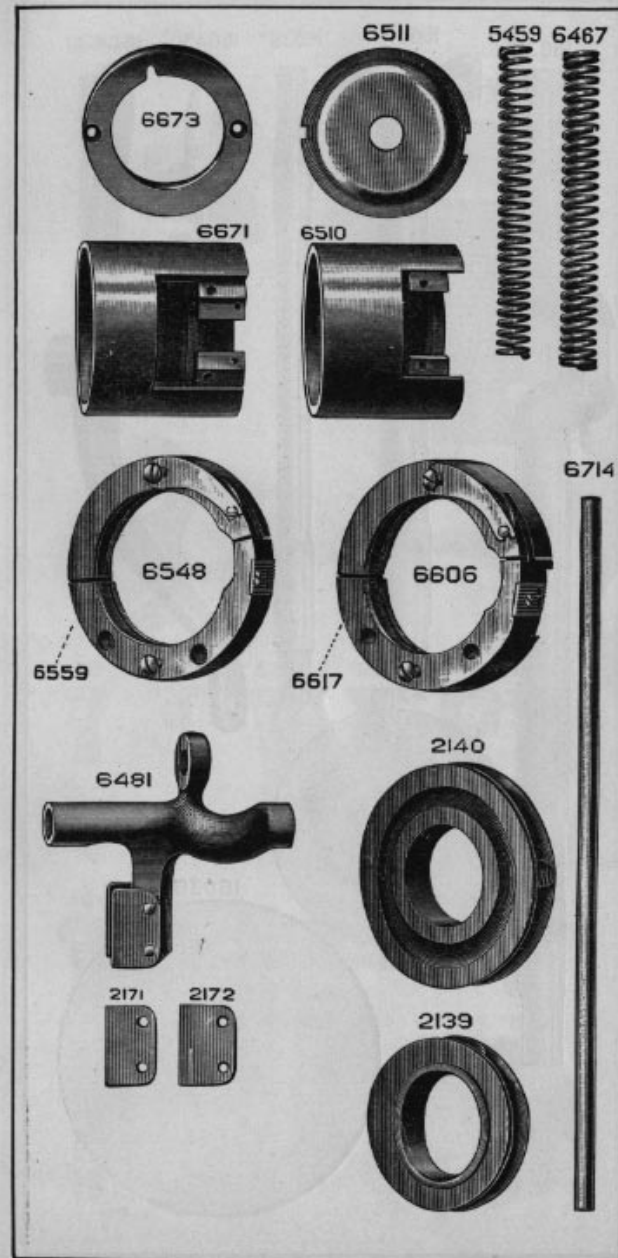

PLATE 411—ONE-HALF SIZE

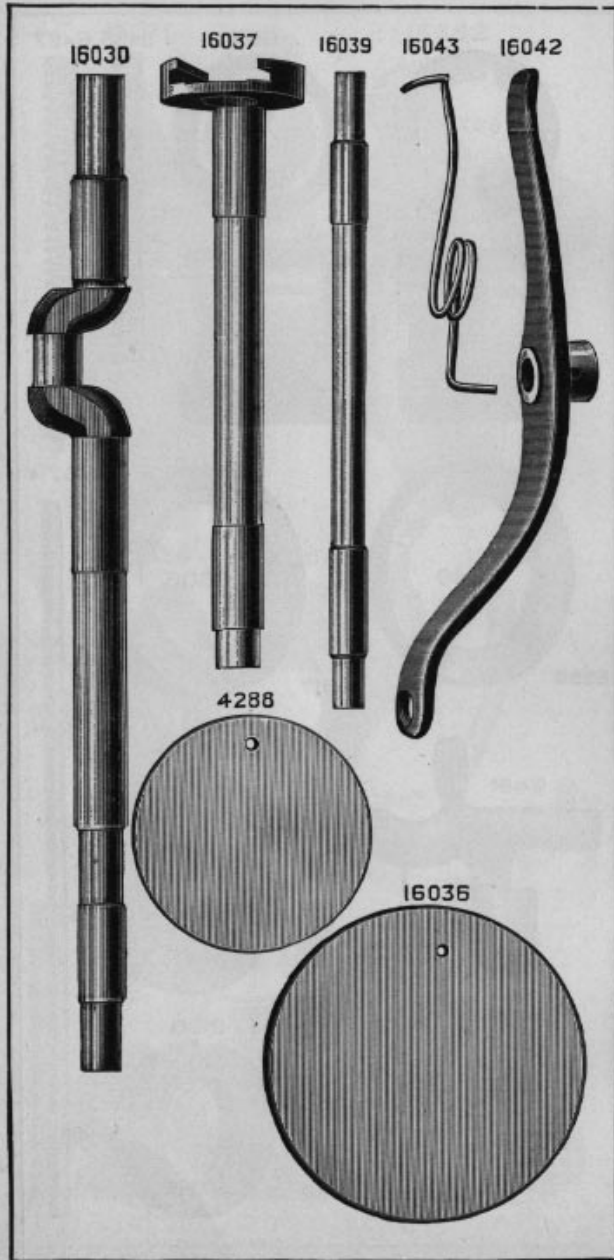

PLATE 412—FULL SIZE

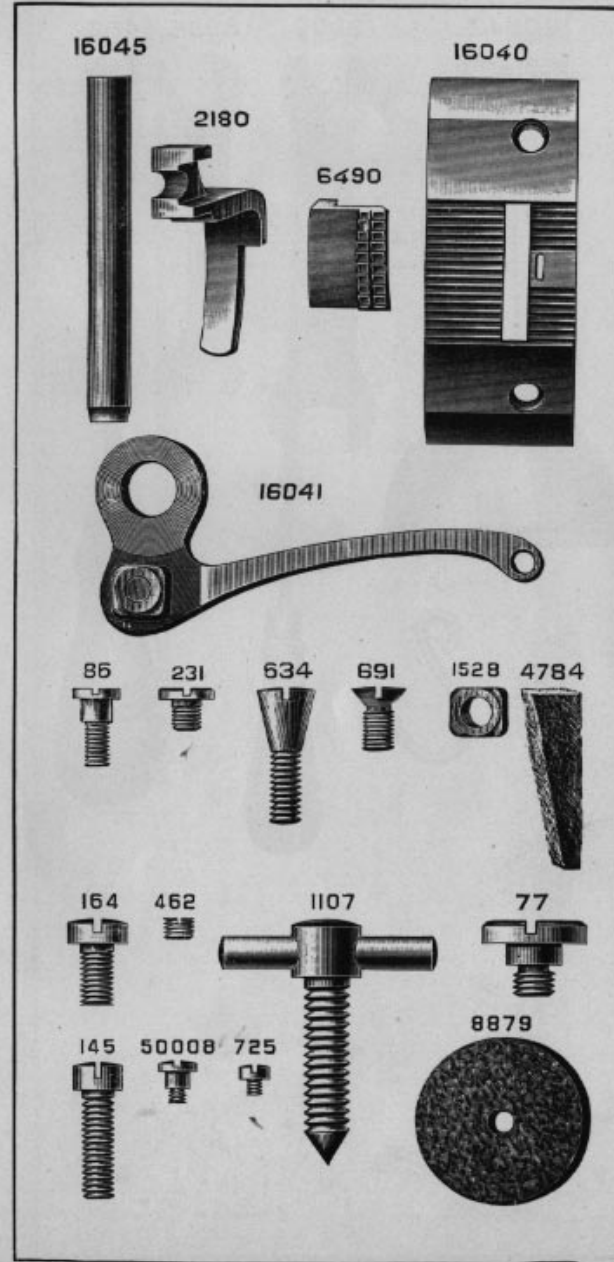



PLATE 413—ONE-HALF SIZE

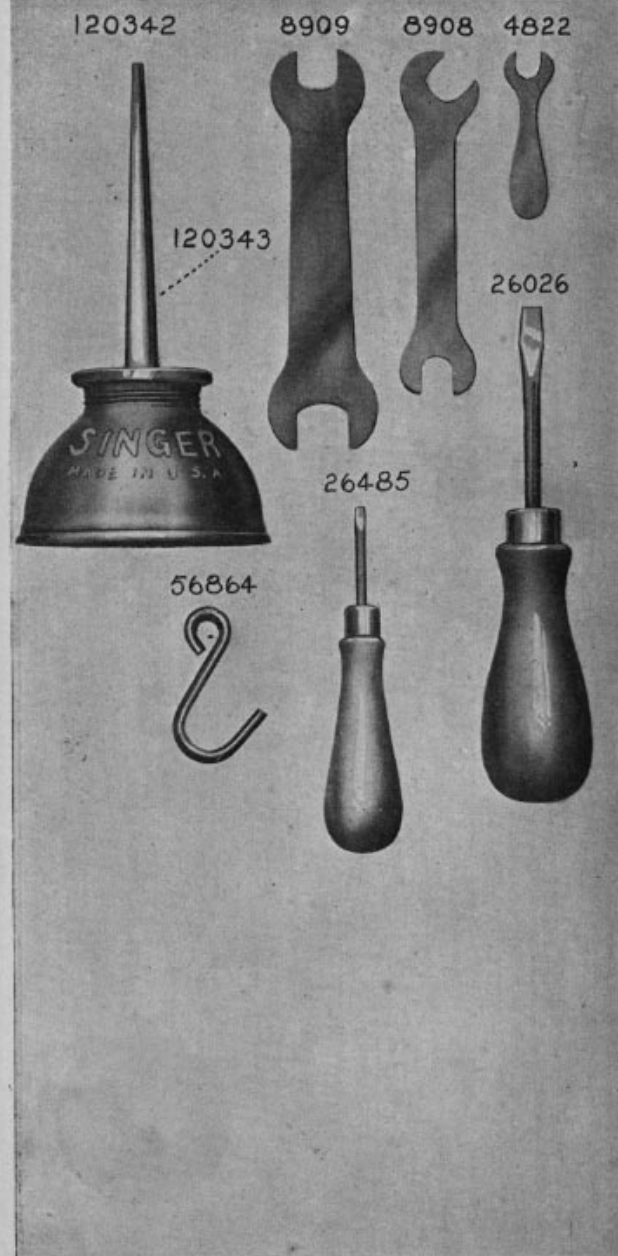

PLATE 2637—ONE-FOURTH SIZE

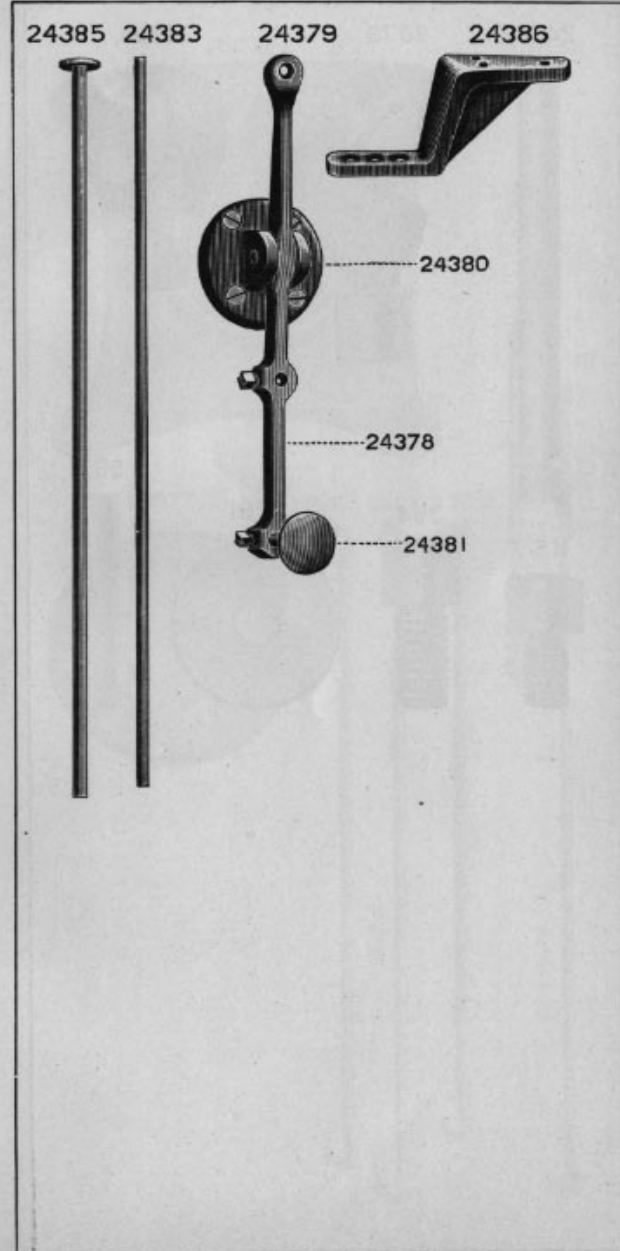

PLATE 2638—FULL SIZE

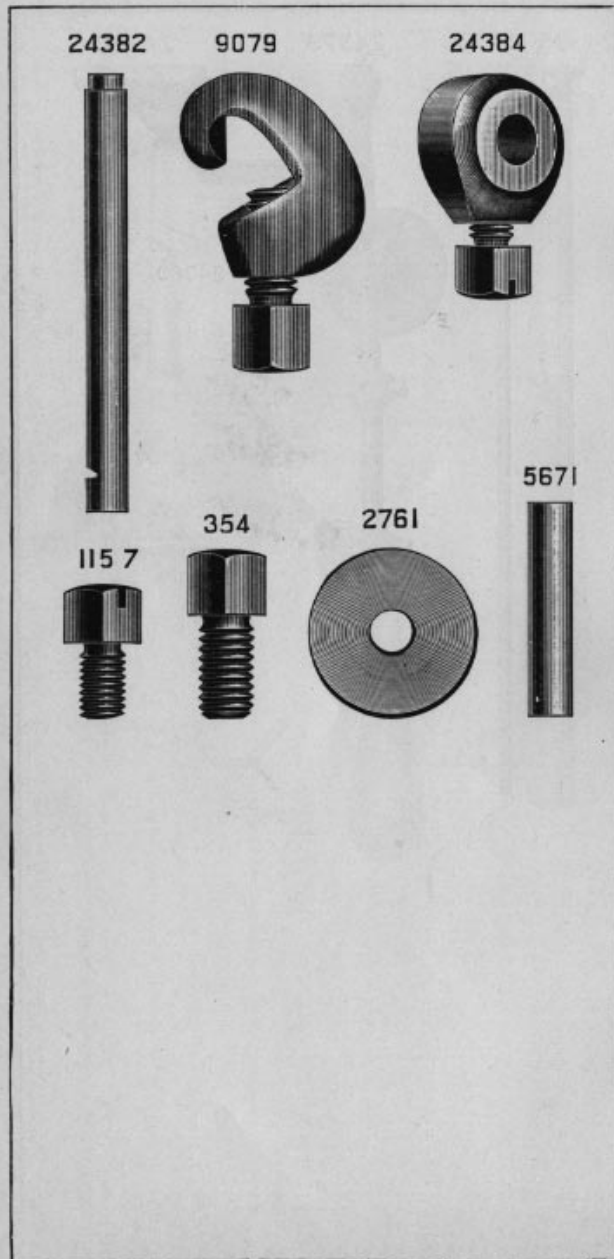

PLATE 3650—ONE-FOURTH SIZE

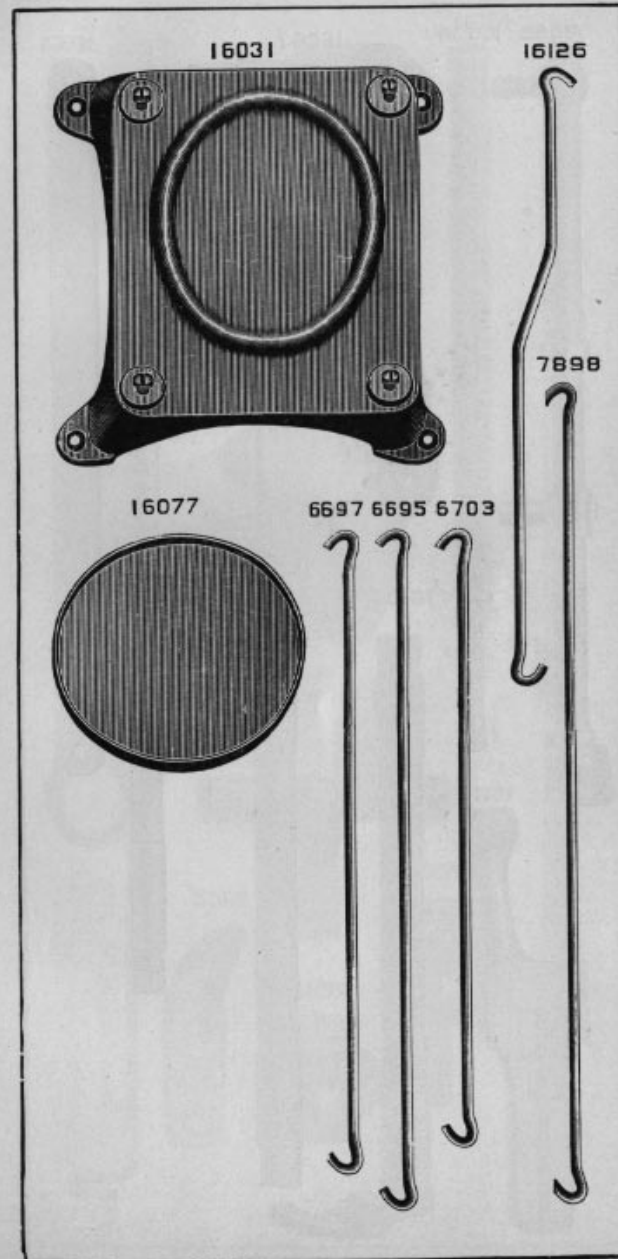

PLATE 3651—ONE-HALF SIZE

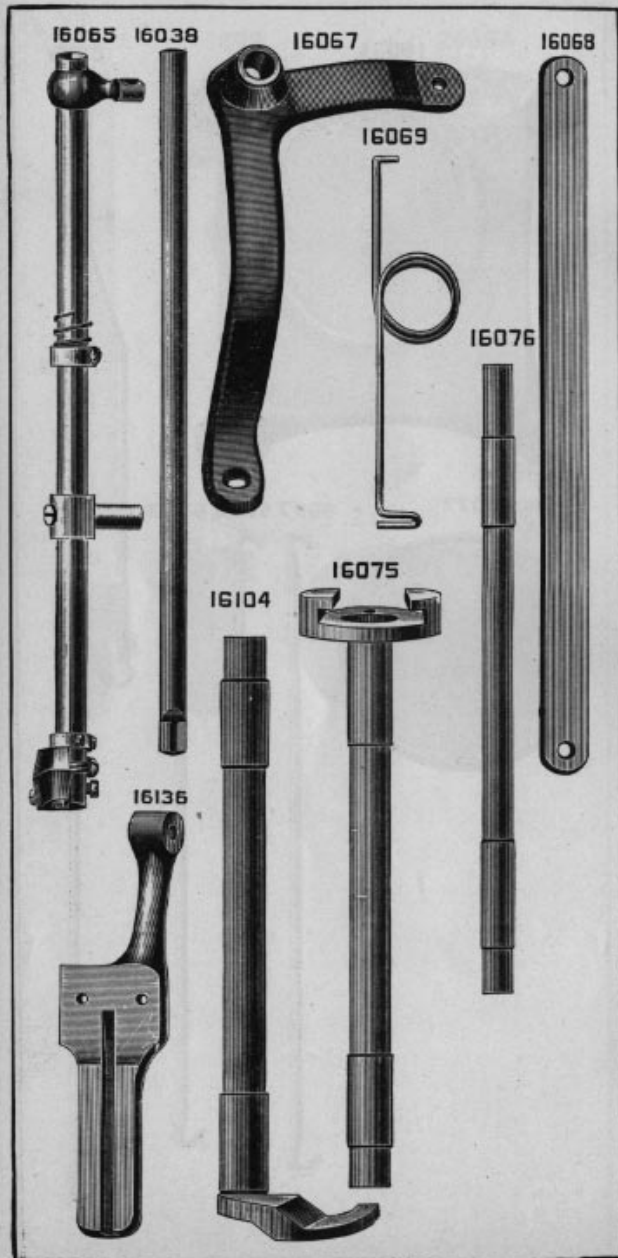

PLATE 3652—ONE-HALF SIZE

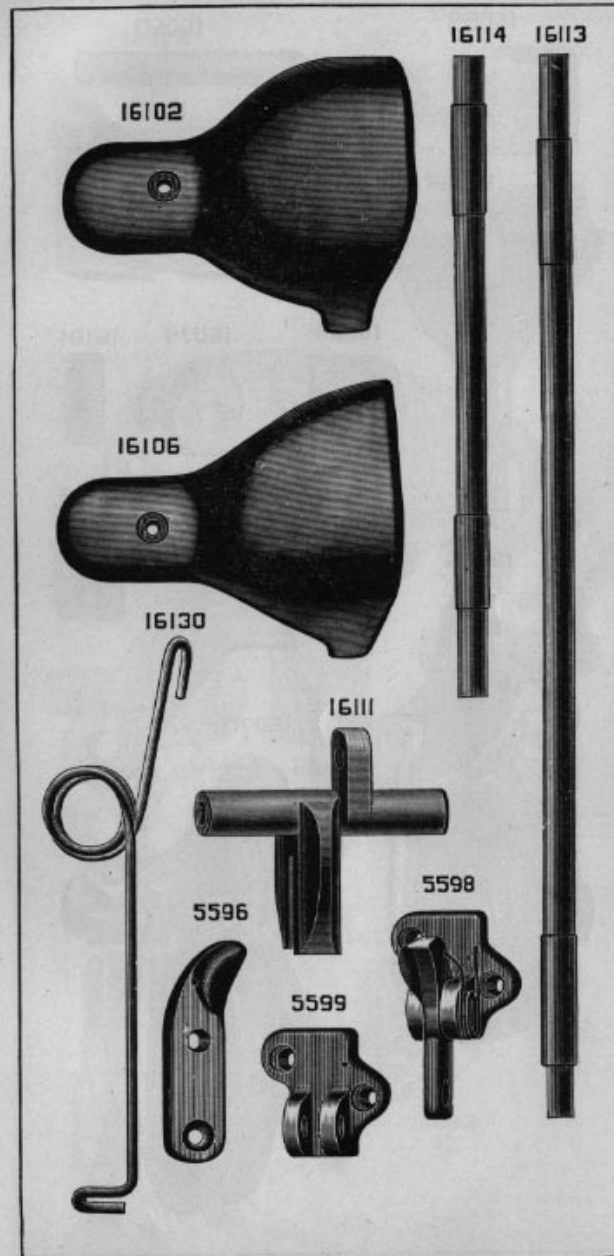

PLATE 3653—FULL SIZE

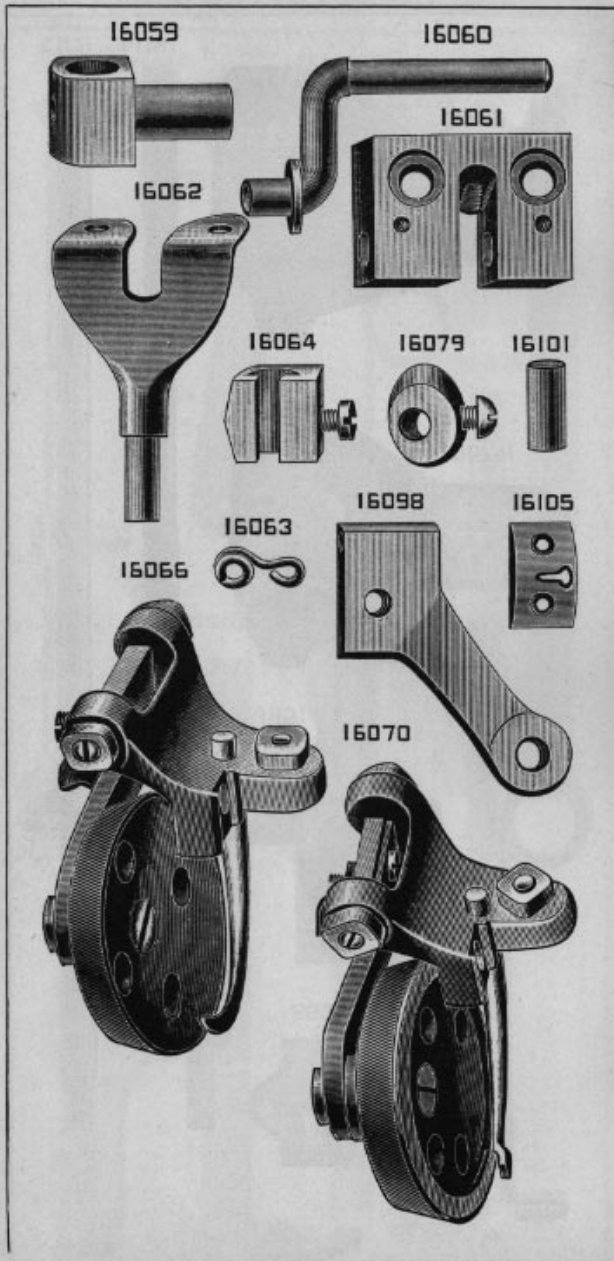

PLATE 3654—FULL SIZE

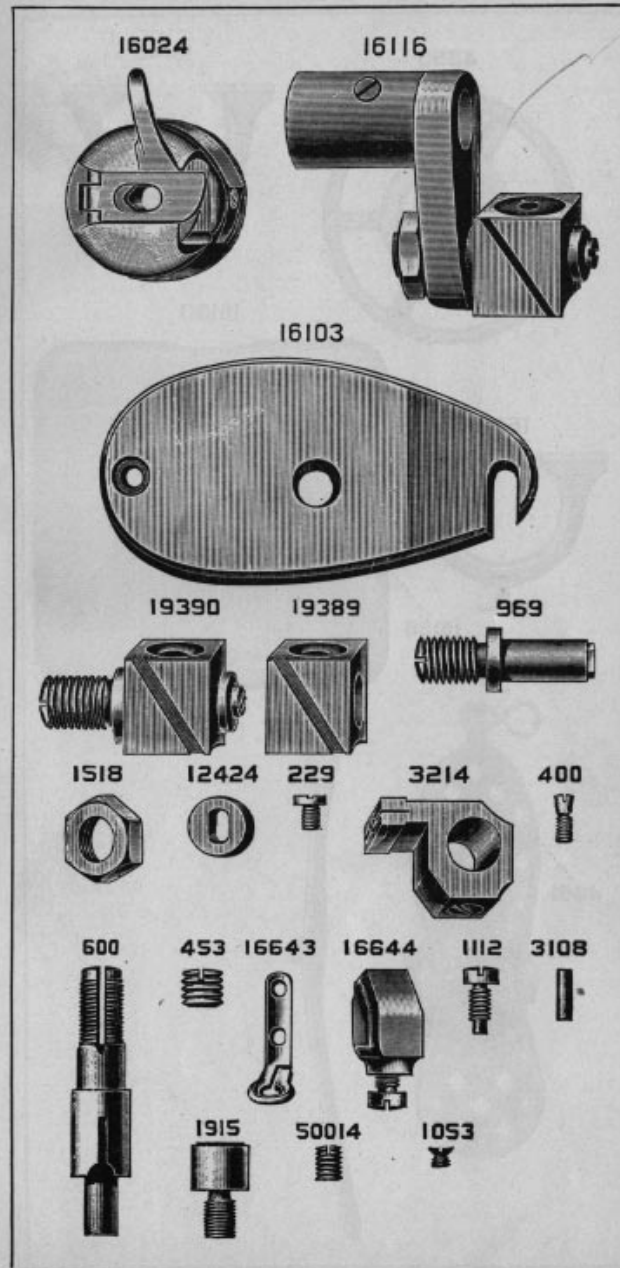



PLATE 3655—ONE-FOURTH SIZE

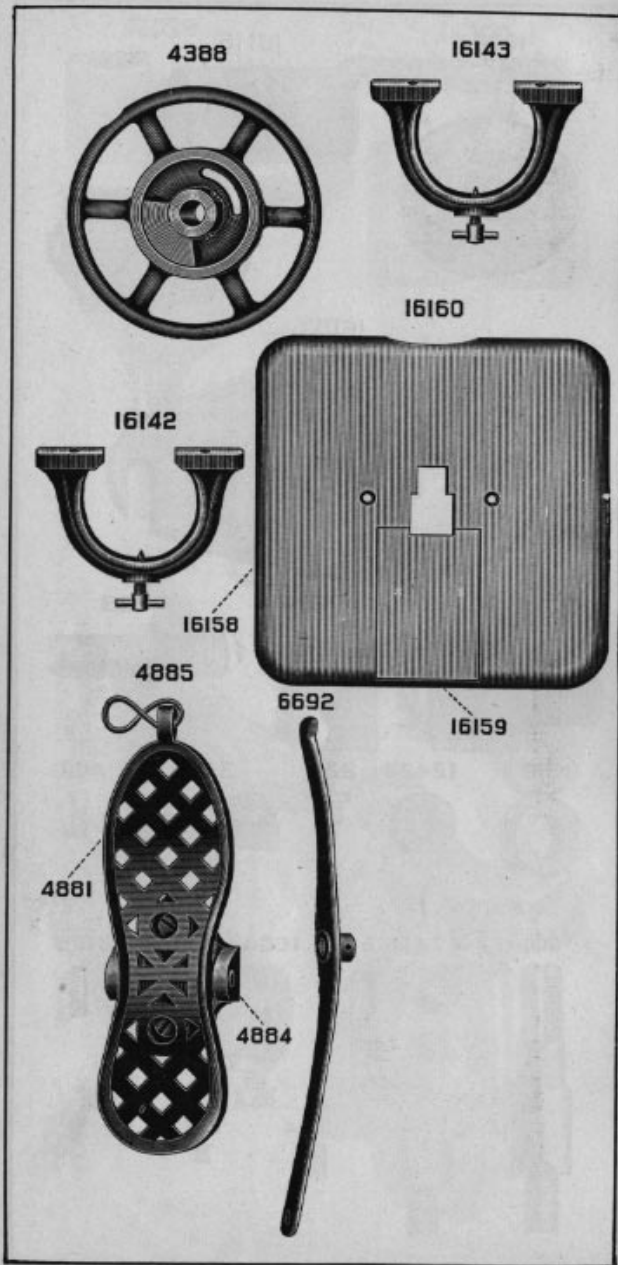

PLATE 3656—ONE-HALF SIZE

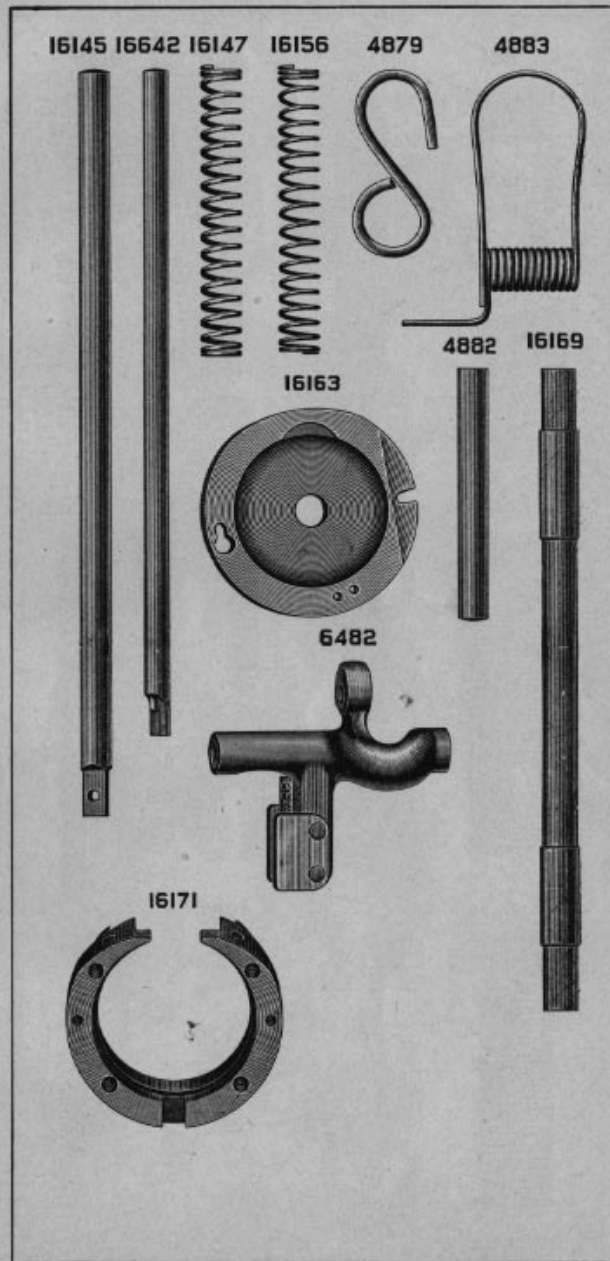

PLATE 3657—FULL SIZE

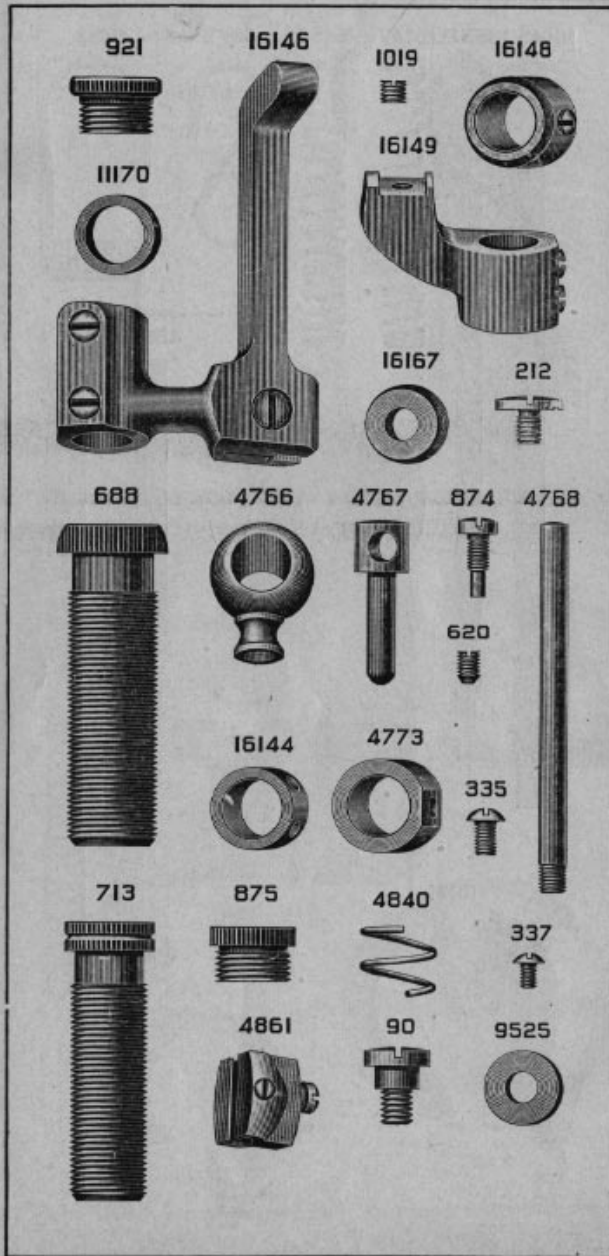

PLATE 3658—FULL SIZE

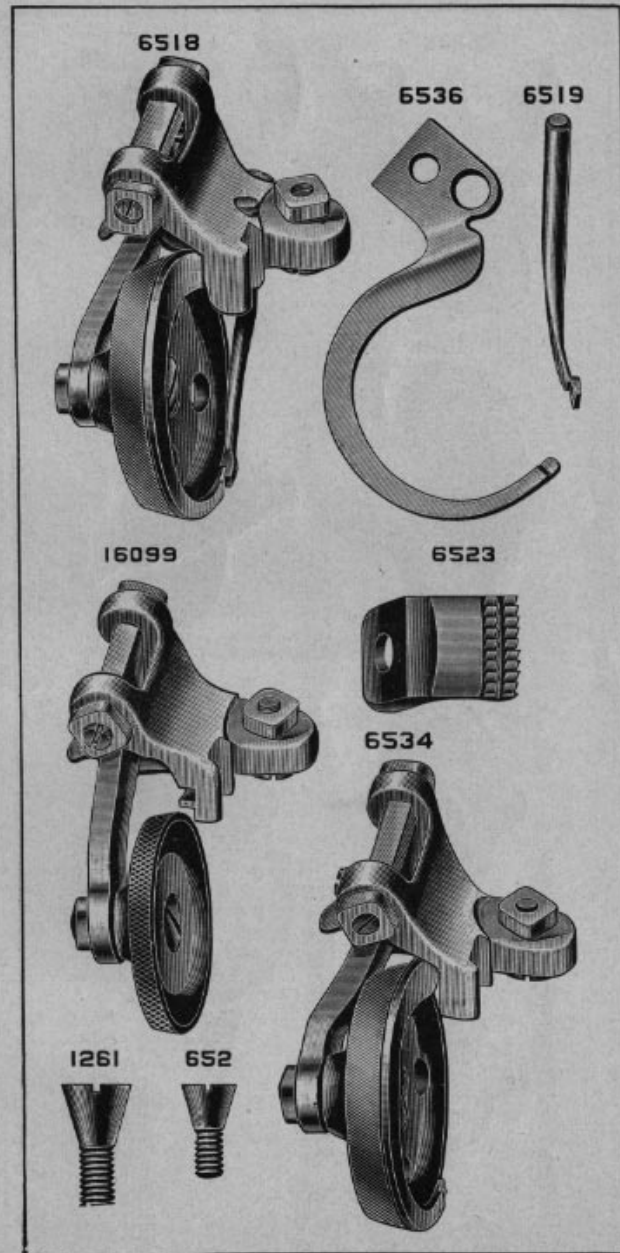

PLATE 3659—FULL SIZE

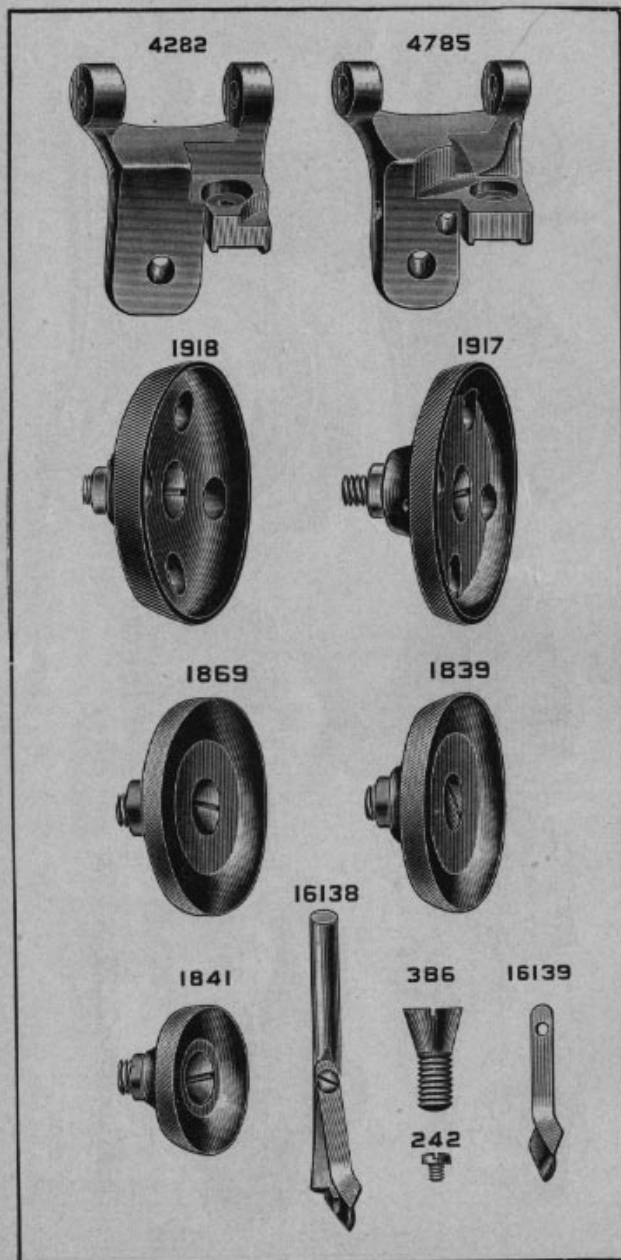

PLATE 3660—ONE-HALF SIZE

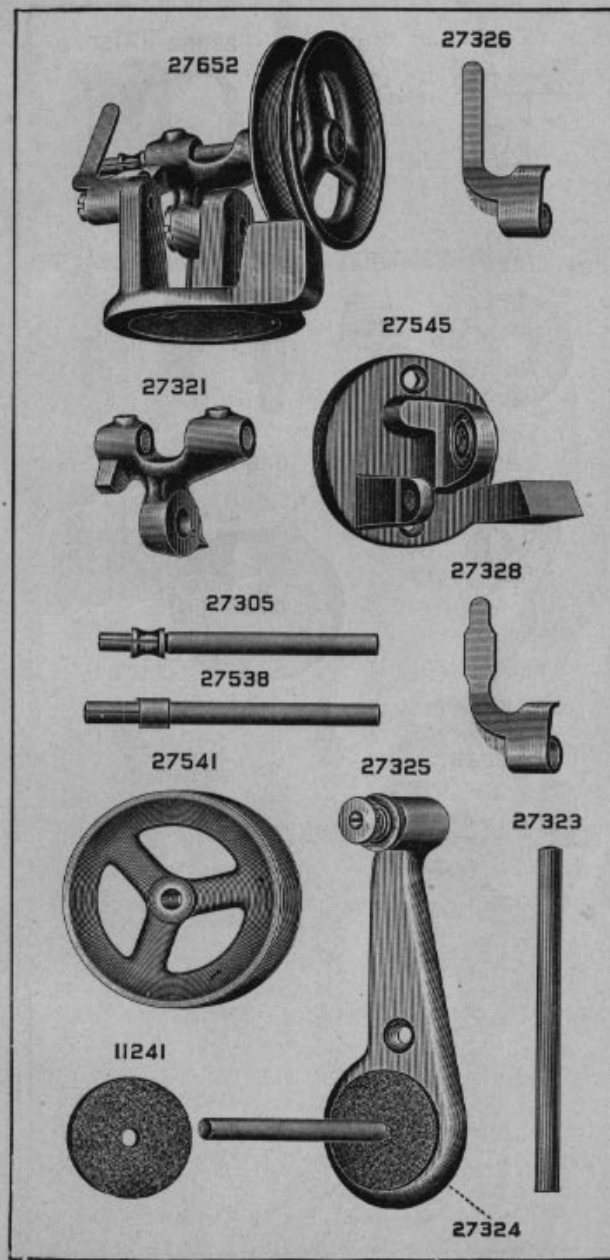

PLATE 3661—FULL SIZE

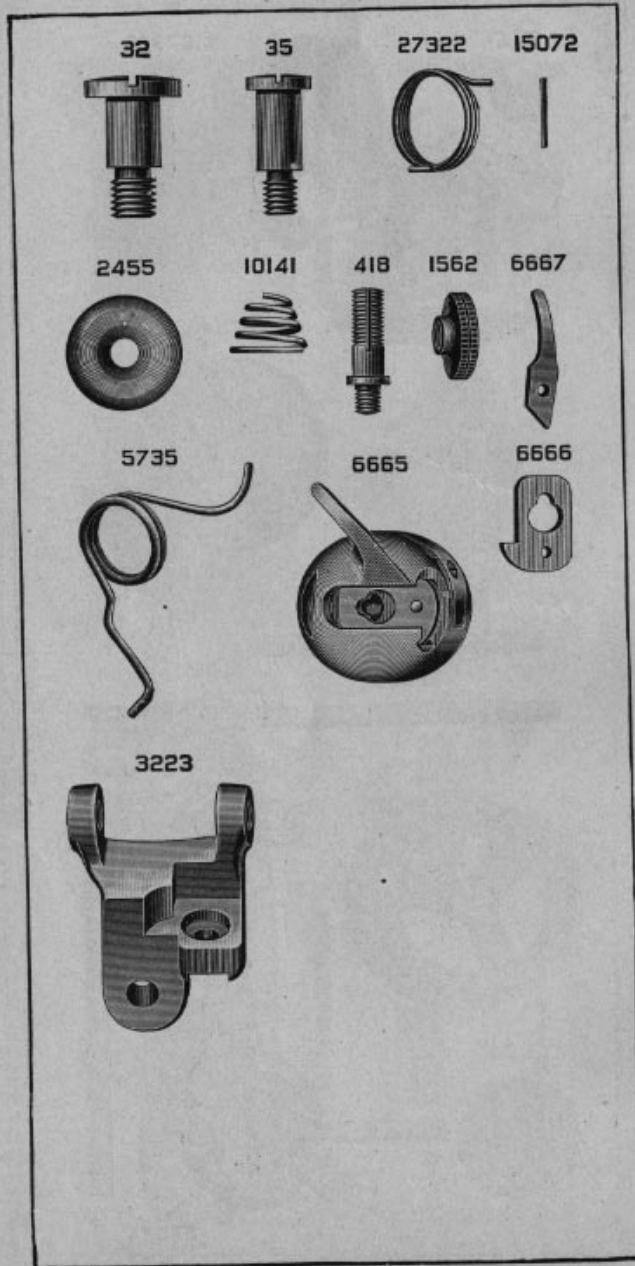

PLATE 3662—ONE-FOURTH SIZE

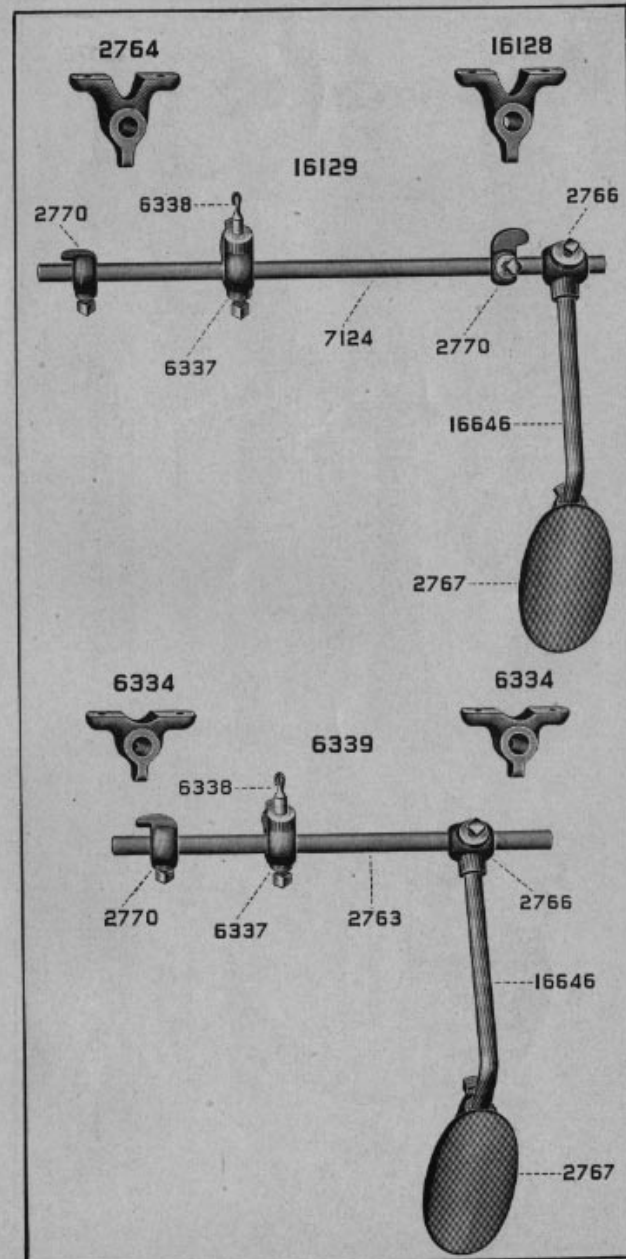
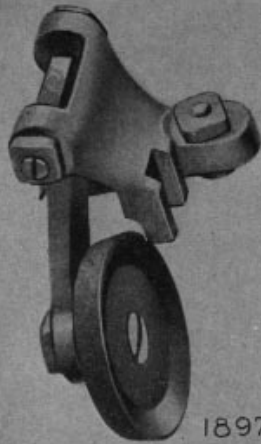



PLATE 3666—FULL SIZE

16225



16228



1897



1923



16234



51835



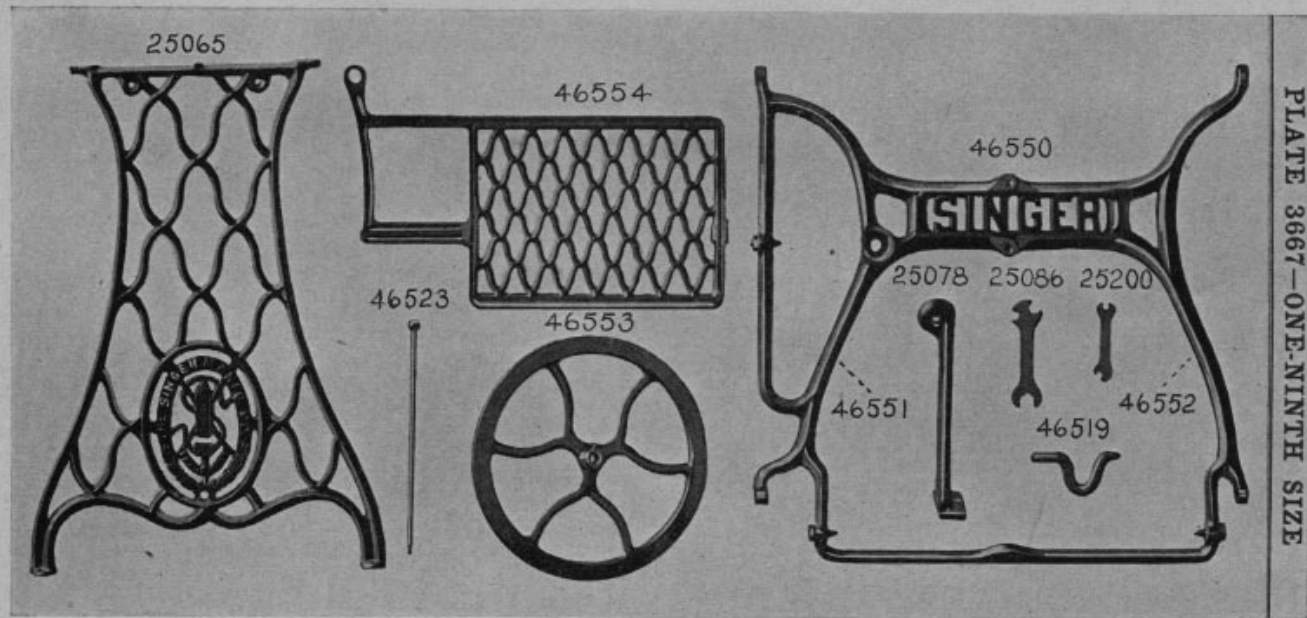
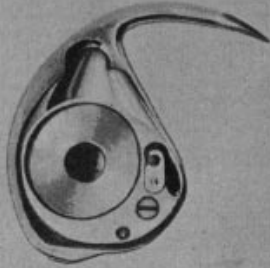
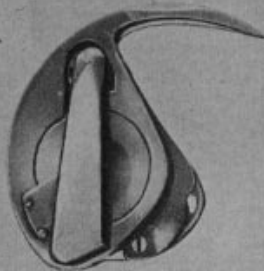

PLATE 3668—FULL SIZE

16206



16208



16209

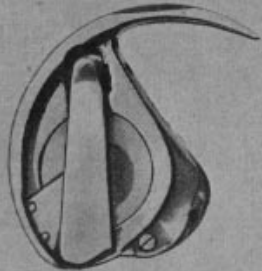

16239

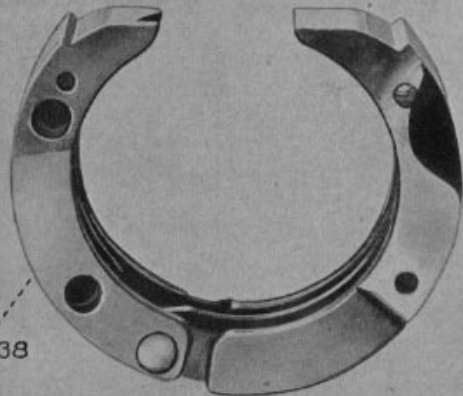

16238

PLATE 3669—FULL SIZE

16237

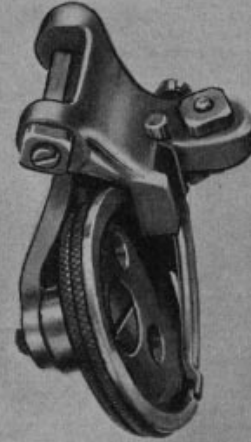

51856



145



226



3045

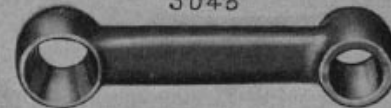

PLATE 3675—FULL SIZE

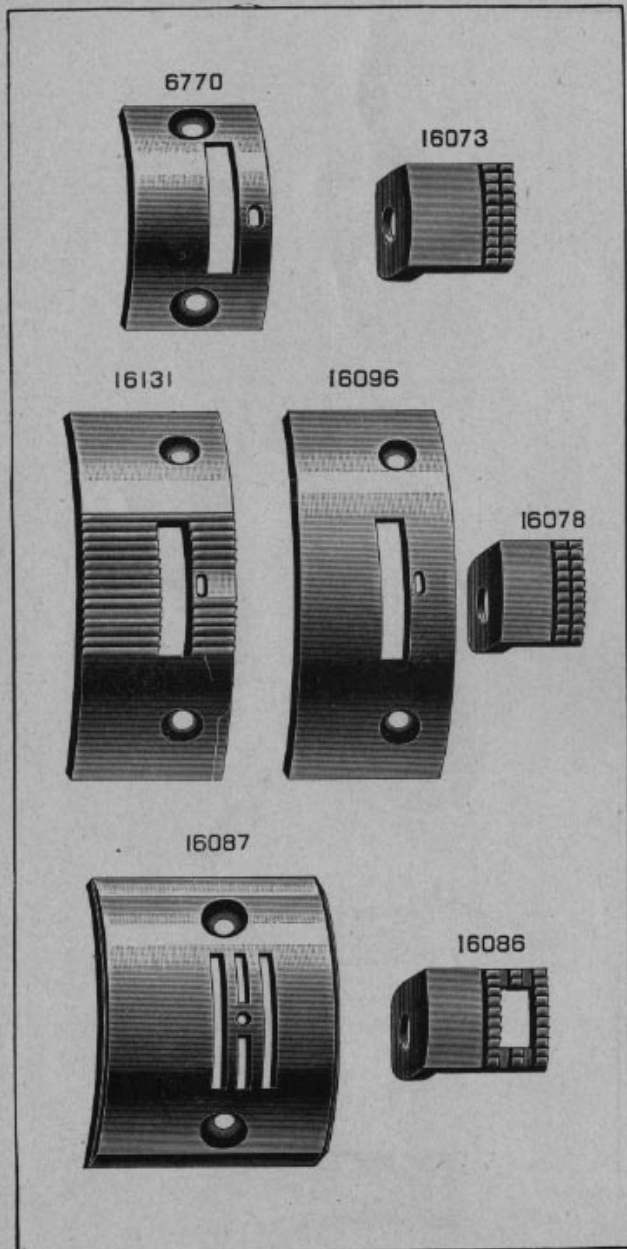

PLATE 3676—FULL SIZE

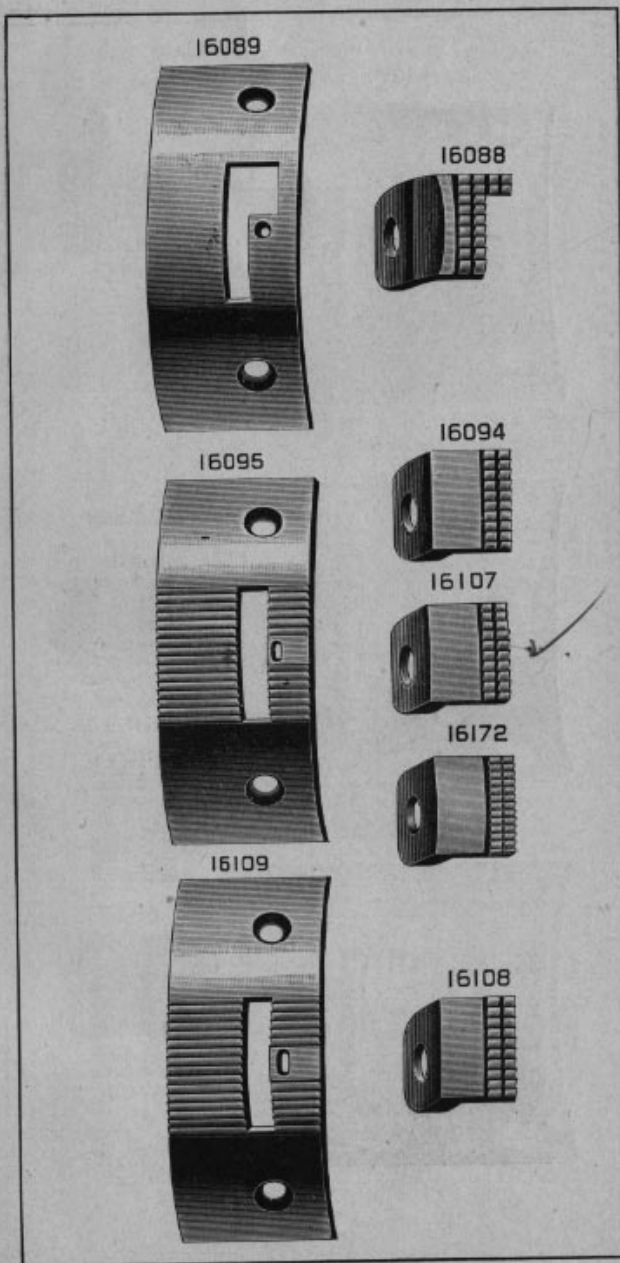

PLATE 3677—FULL SIZE

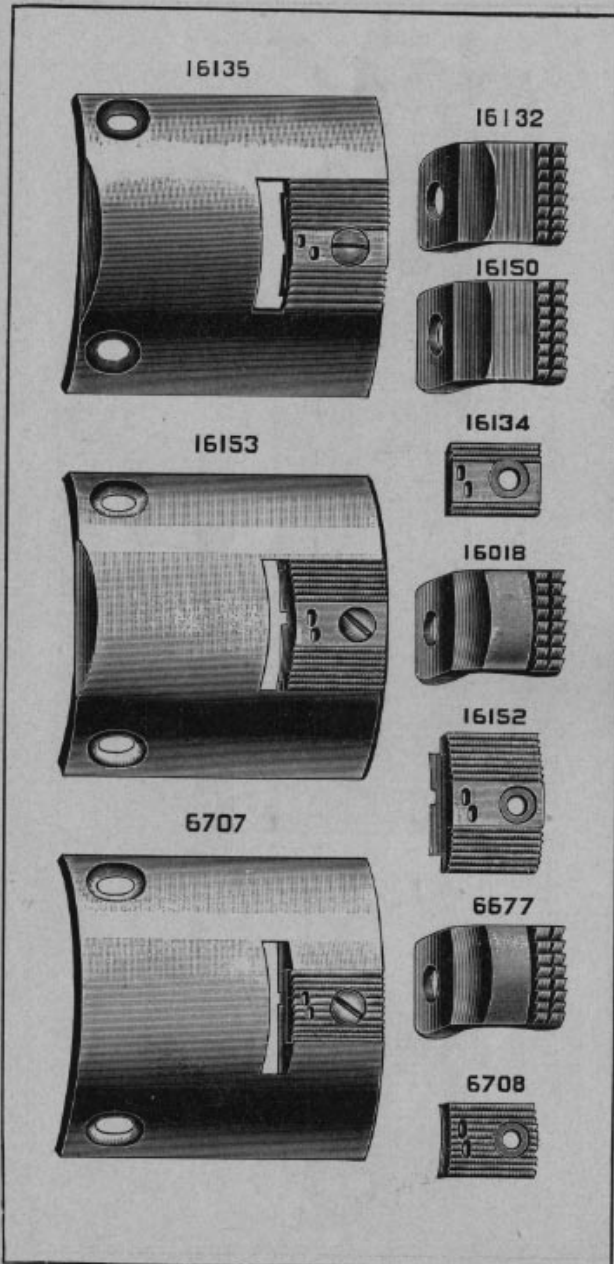
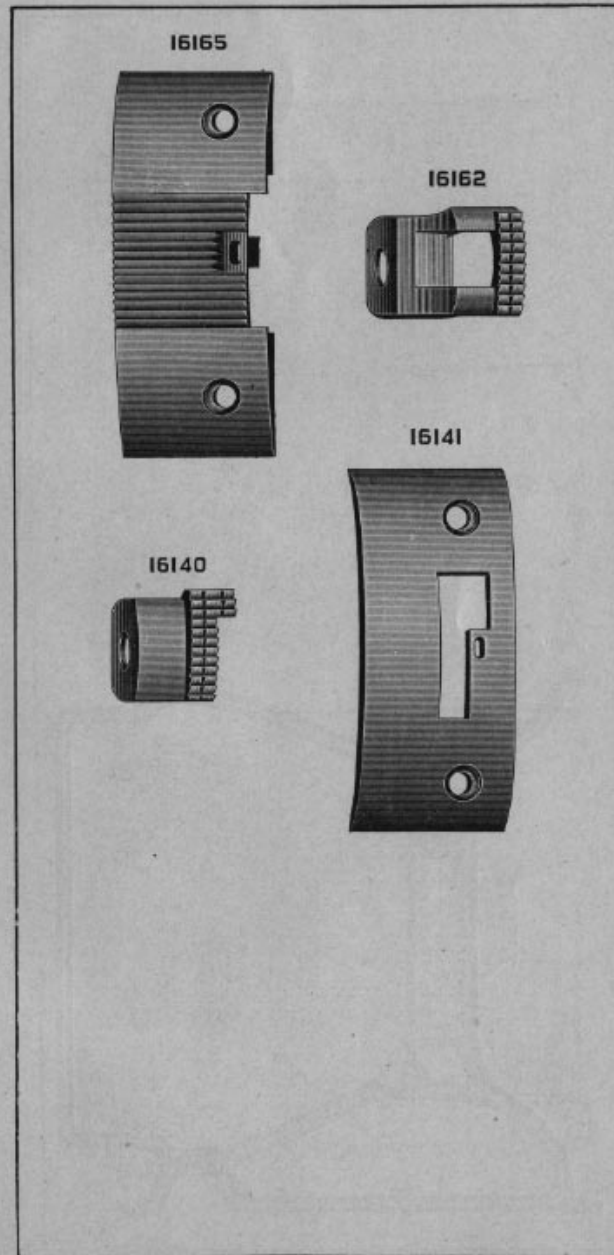

PLATE 3678—FULL SIZE





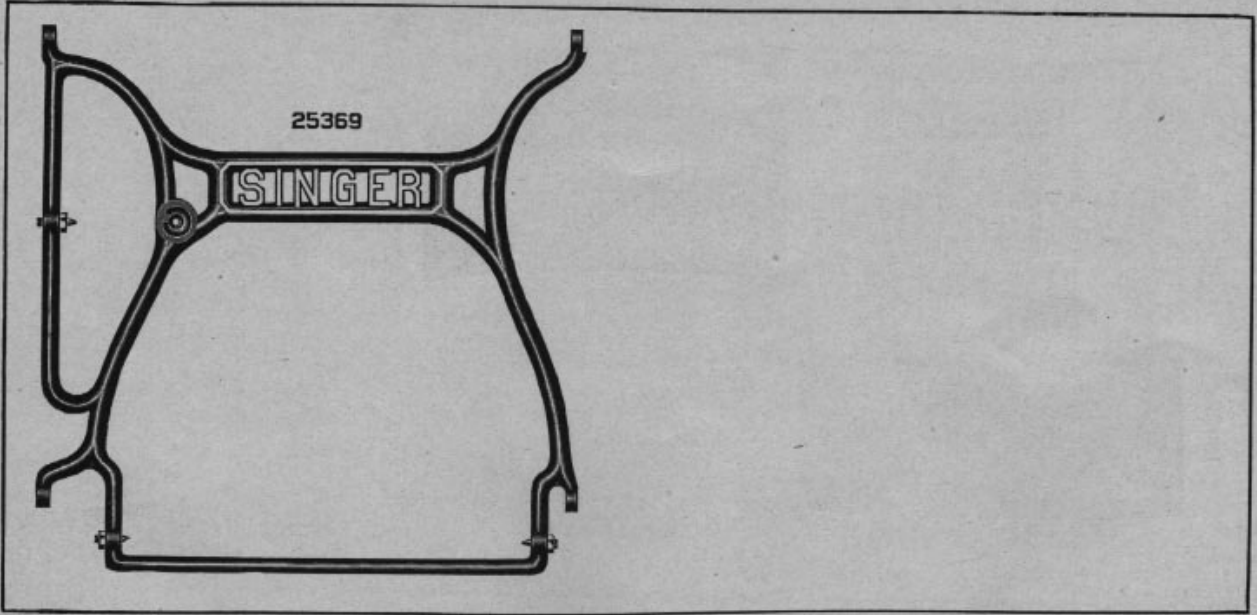

PLATE 3810—ONE-EIGHTH SIZE

PLATE 3826—FULL SIZE

46509



46506

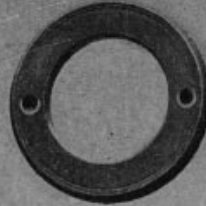

46508

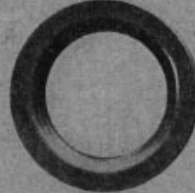

46507



46655



25362



1520



1670



25371



25361



972



25127



296



748



297



1507

