

**SINGER**  
**34K1,K5,K11**

Form K5868  
Supersedes K1549

ILLUSTRATED  
LIST OF PARTS

FOR

Class 34K Machines

(Nos. 34K1, 34K5 and 34K11)



\*\*A Trade Mark of  
THE SINGER MANUFACTURING COMPANY

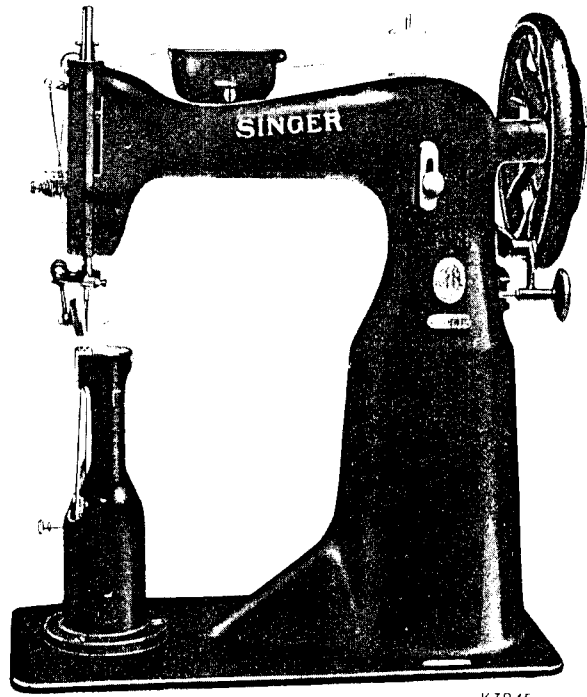

No. 34K11 Machine.

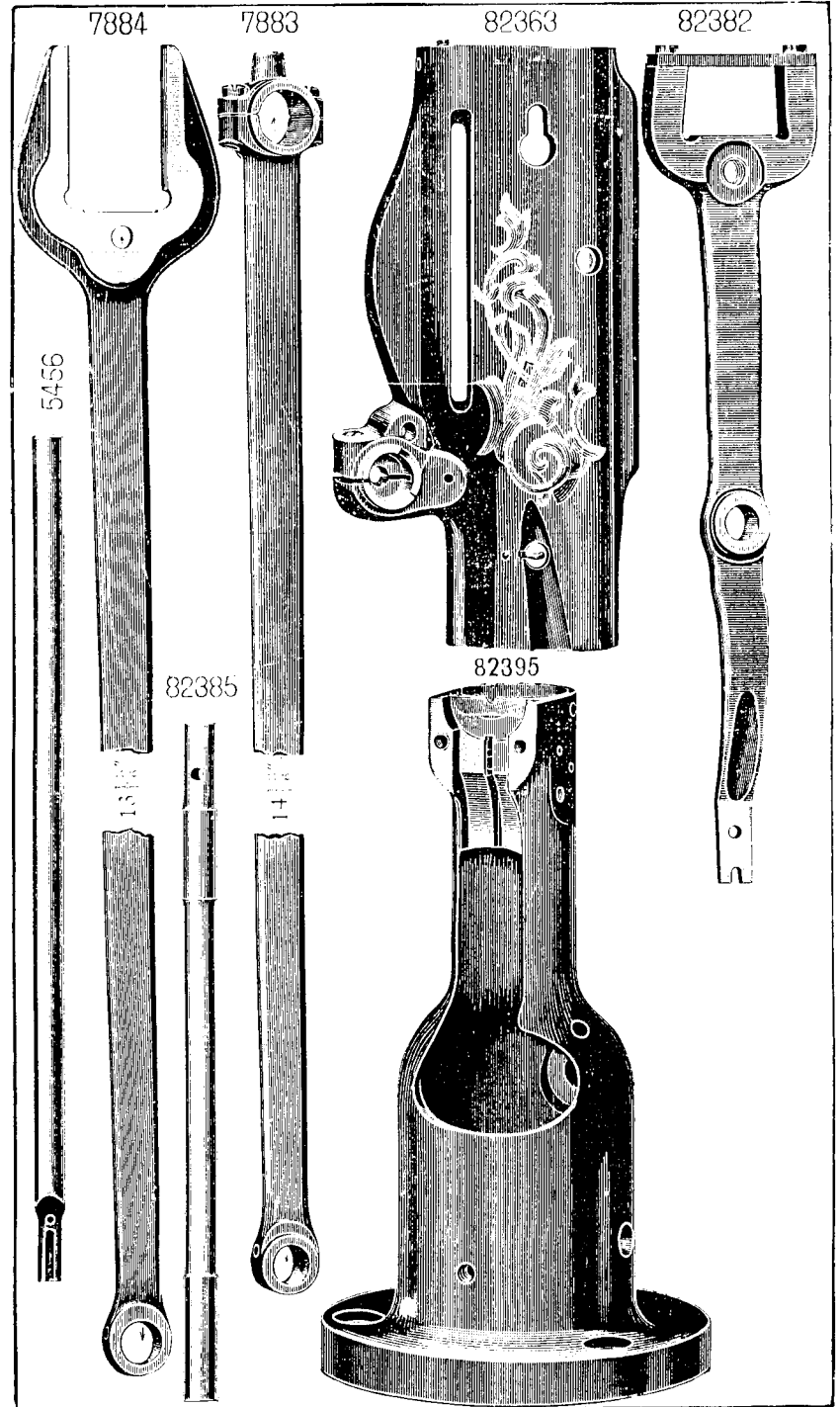

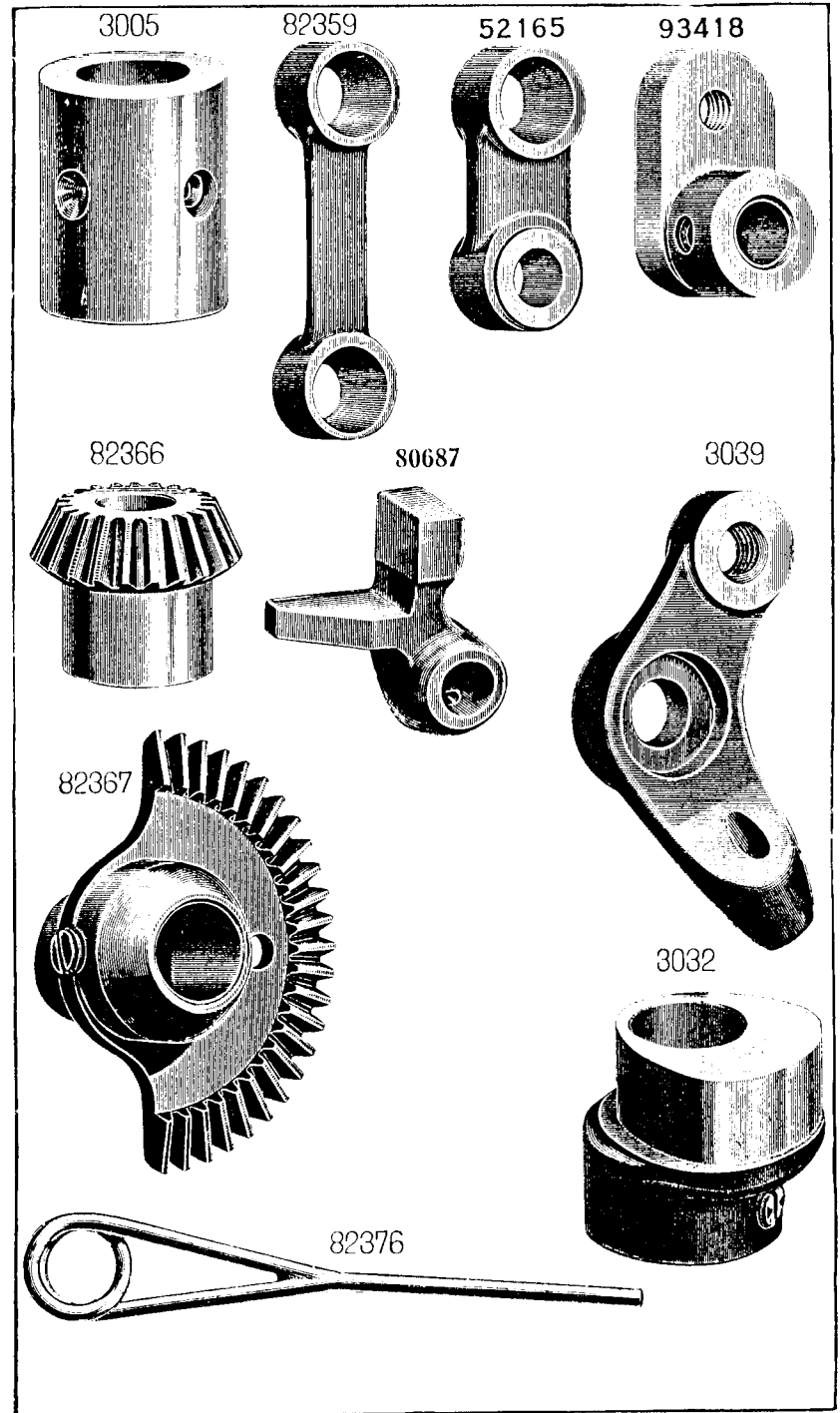
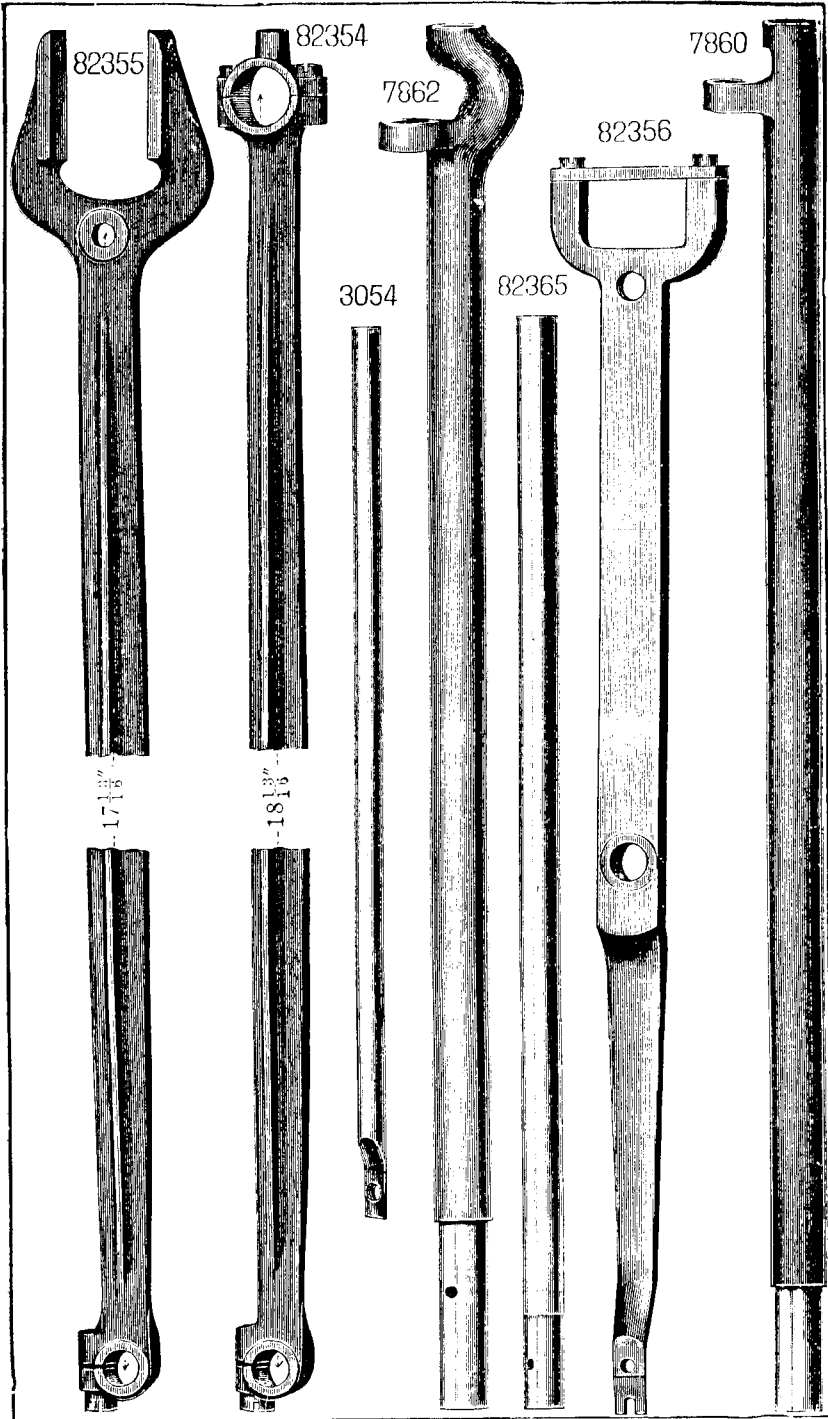

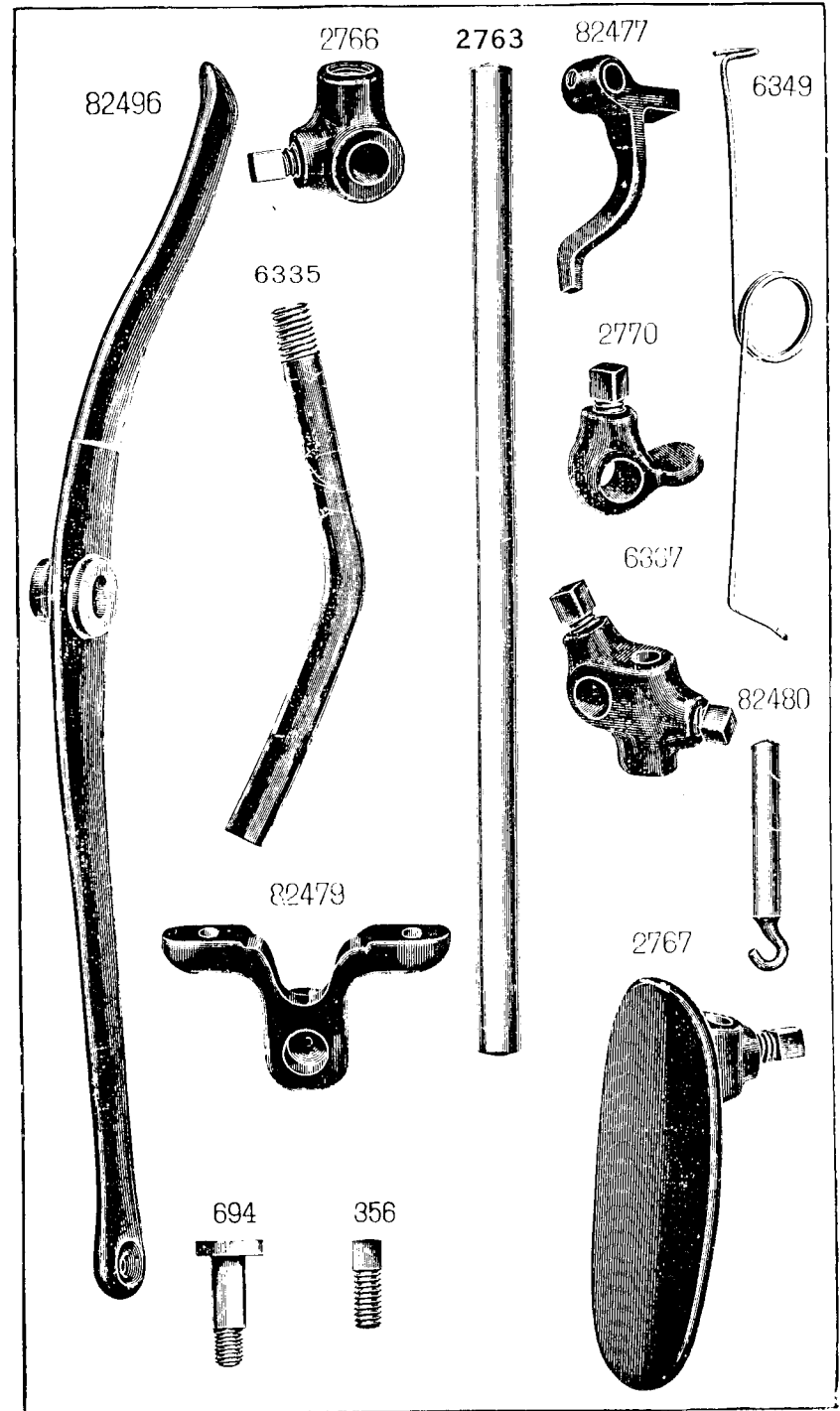
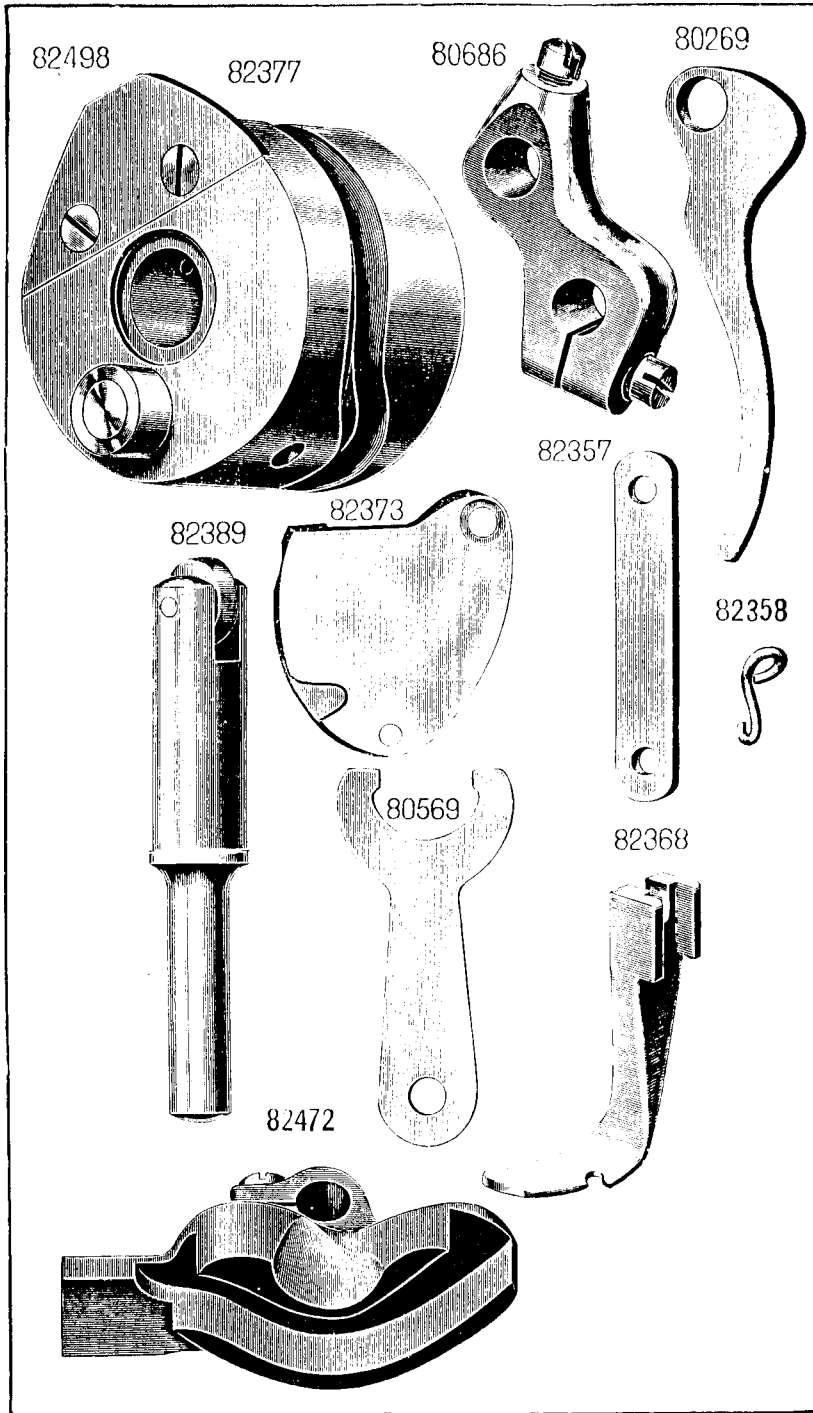

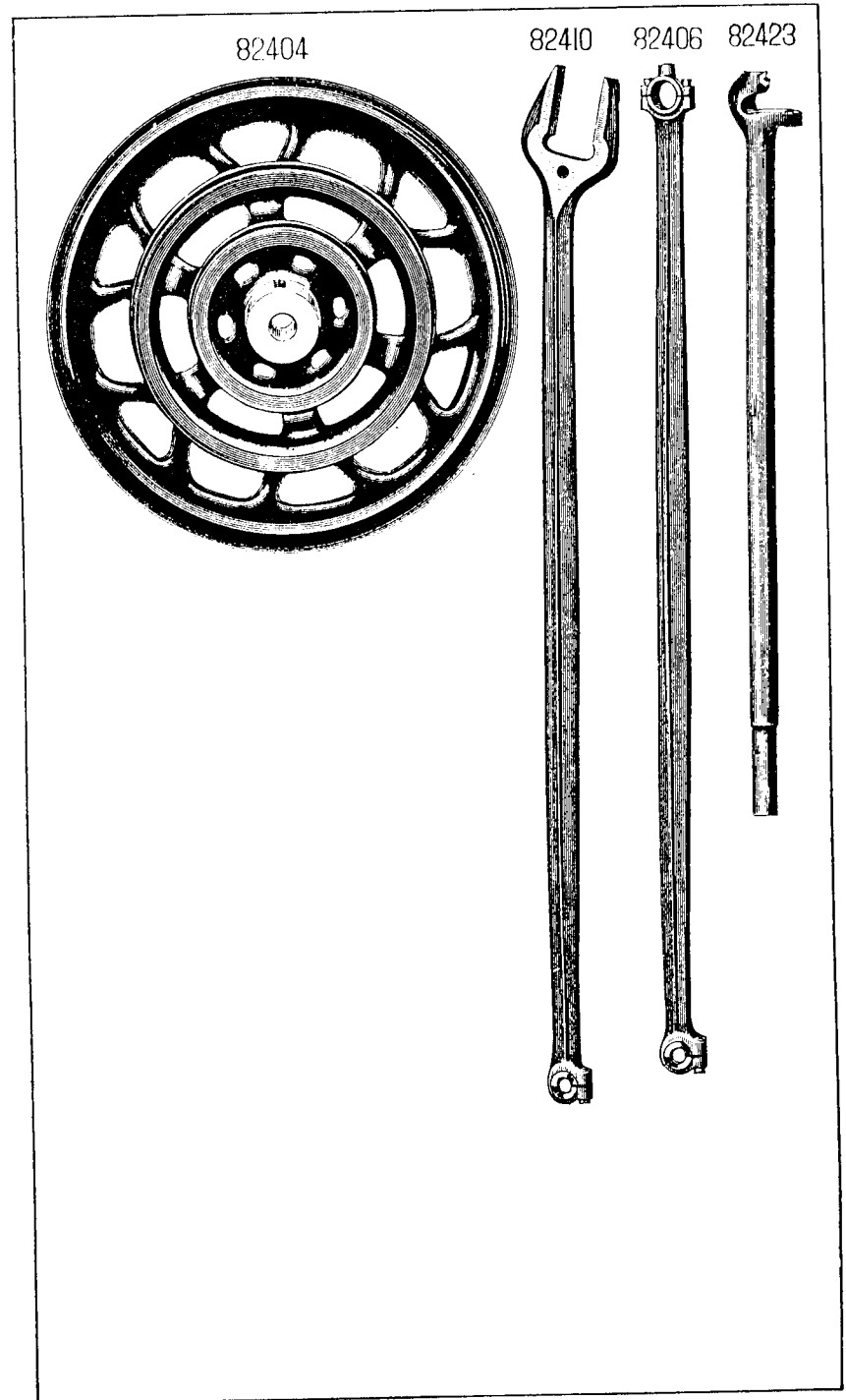
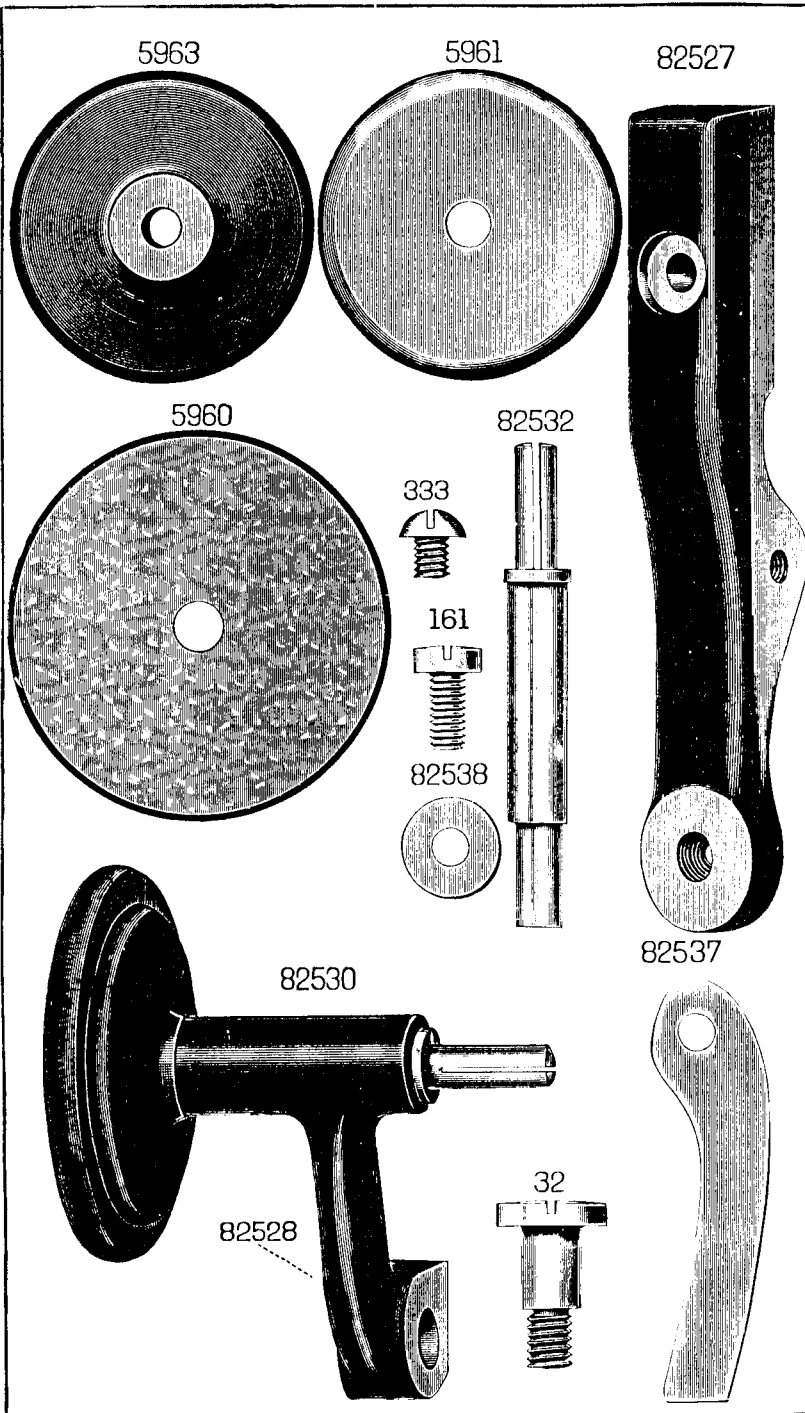

82407

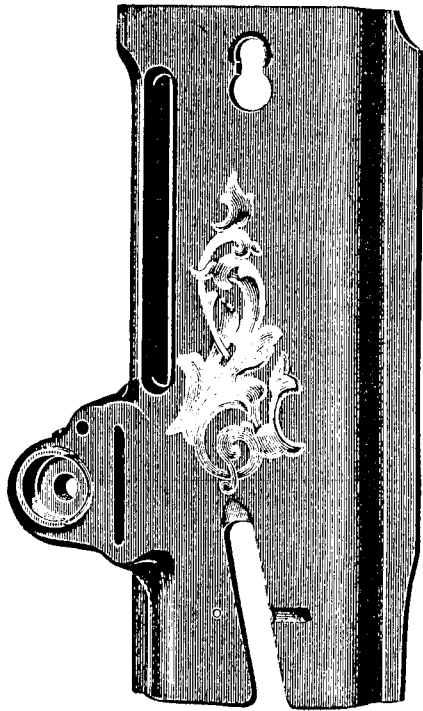

82402

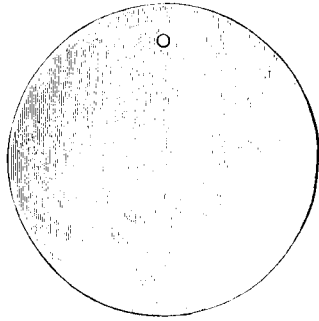

91797

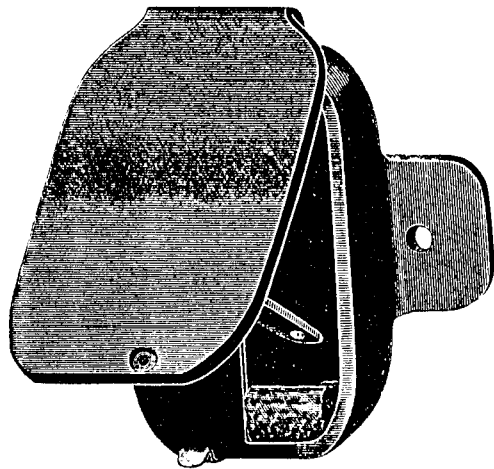

82380

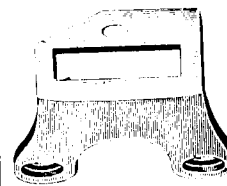

82379

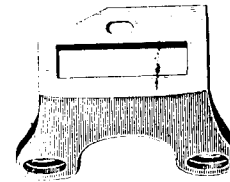

82384

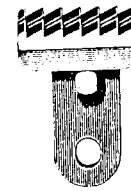

82383

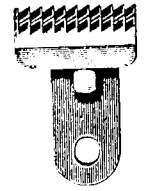

5458

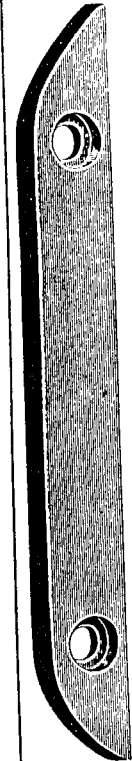

82482



82505

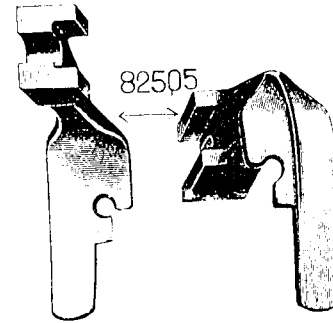

82360



82361

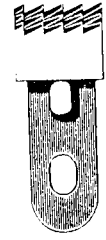

82551

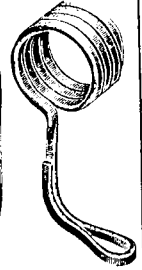

2102

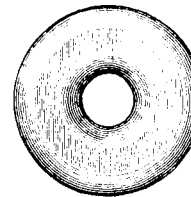

82387

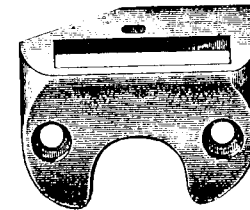

80081



2020

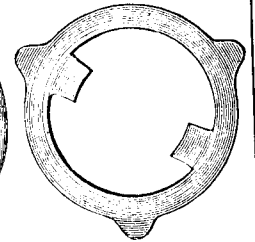

82447

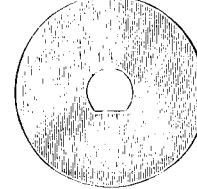

82448

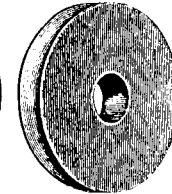

80259



82445

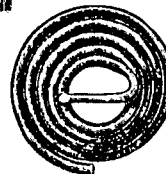

80548



2103

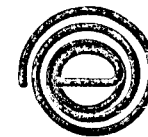

82446



82419

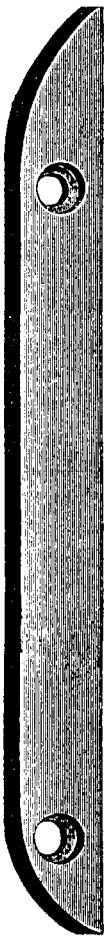

91150

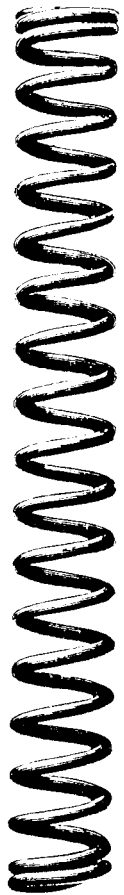

82512



82453



82513

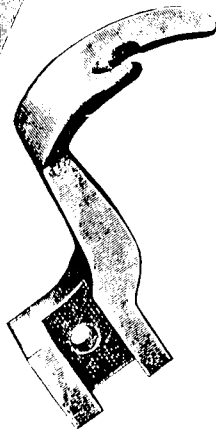

82515

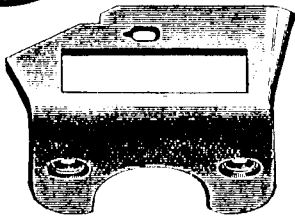

82516

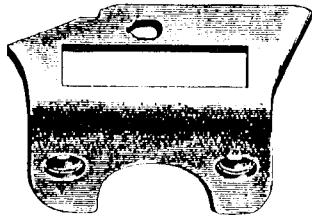

82510



82507

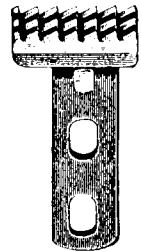

82435

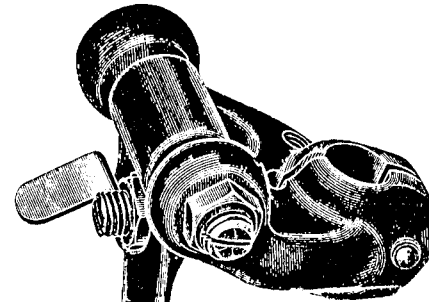

82433

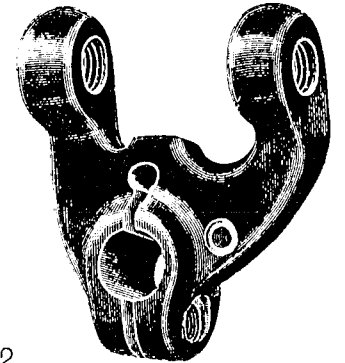

82434



82432

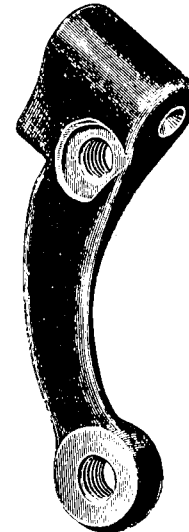
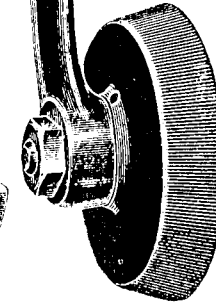

RR25

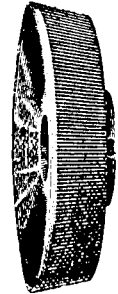

378



1520



SS329



313



430





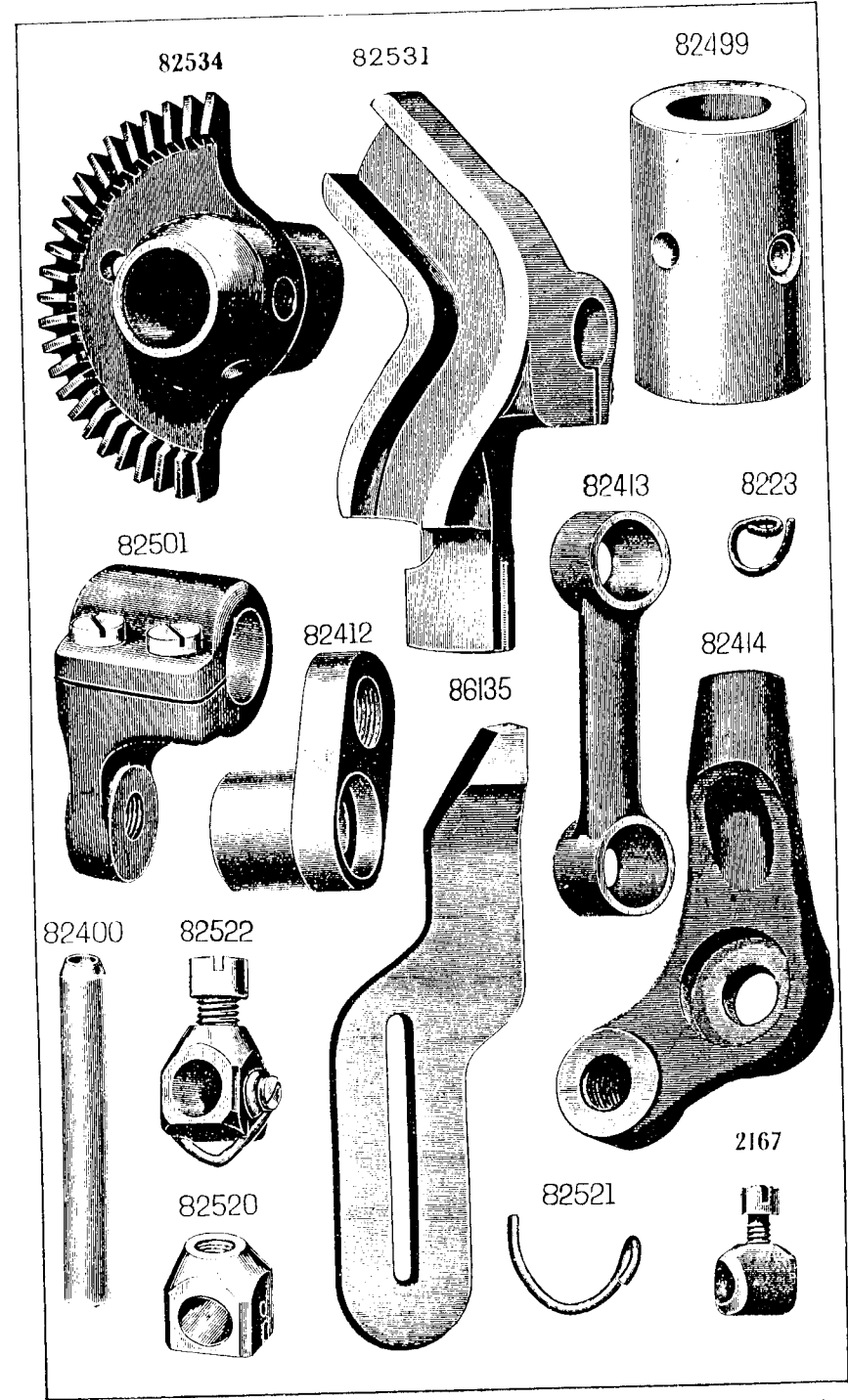
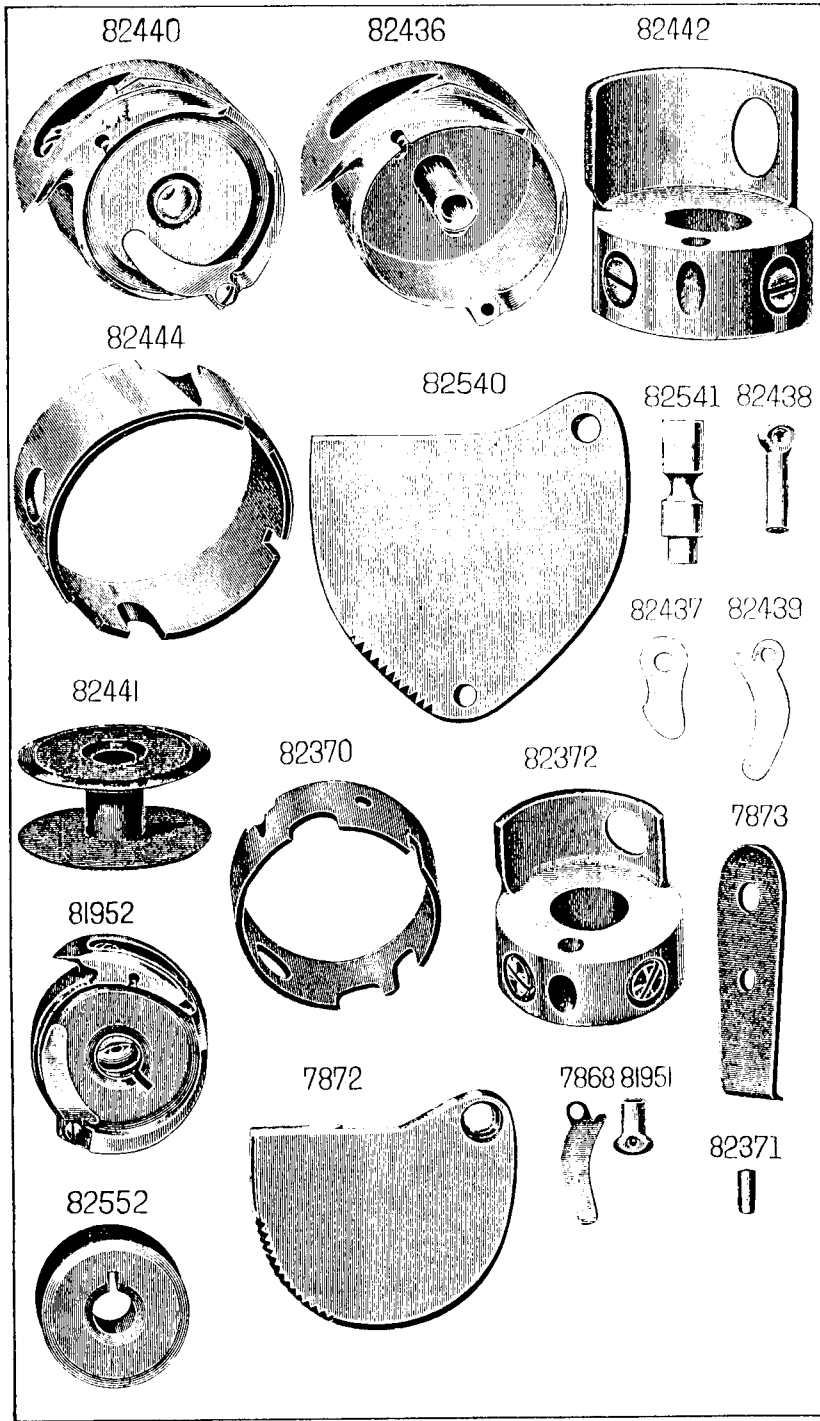

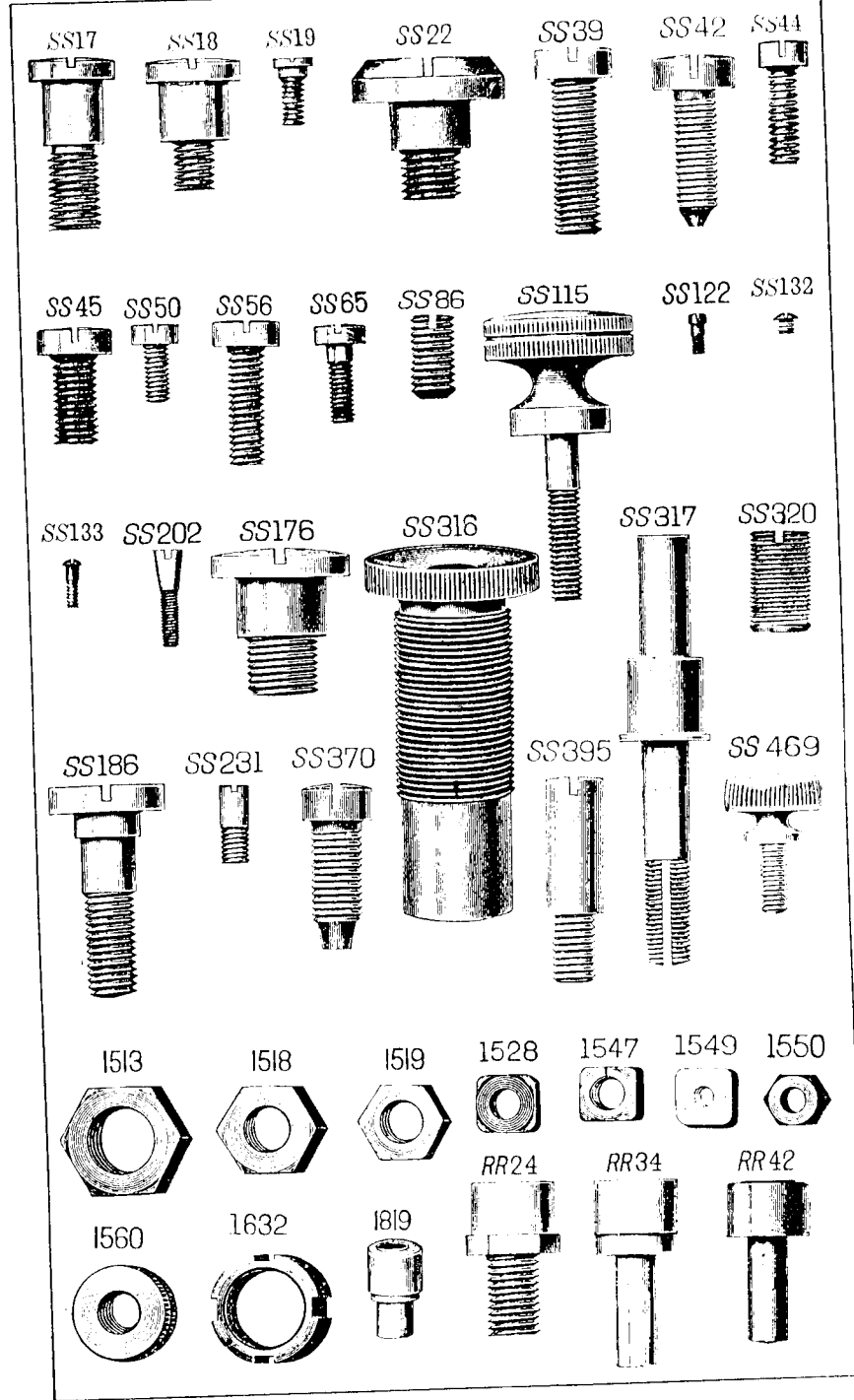
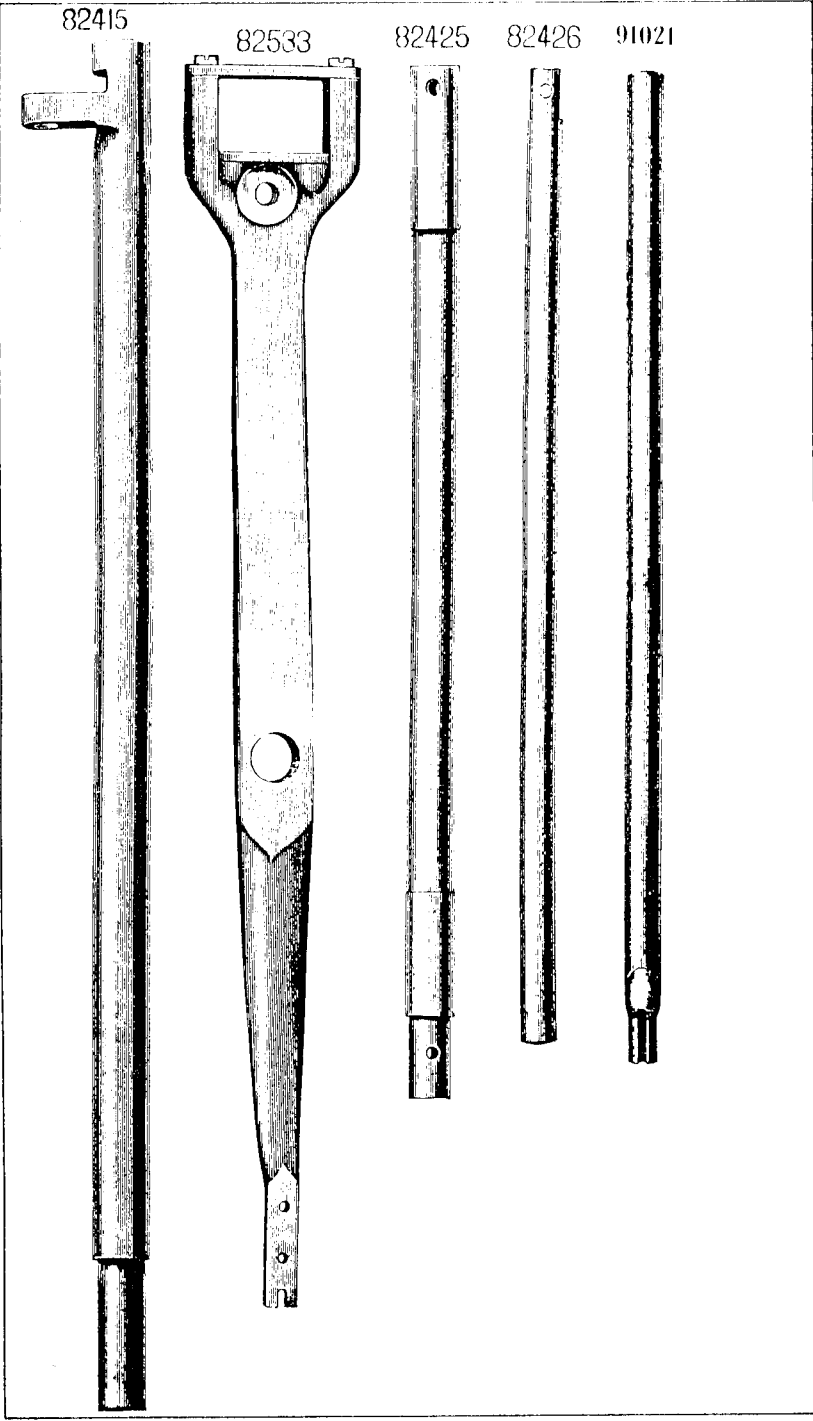

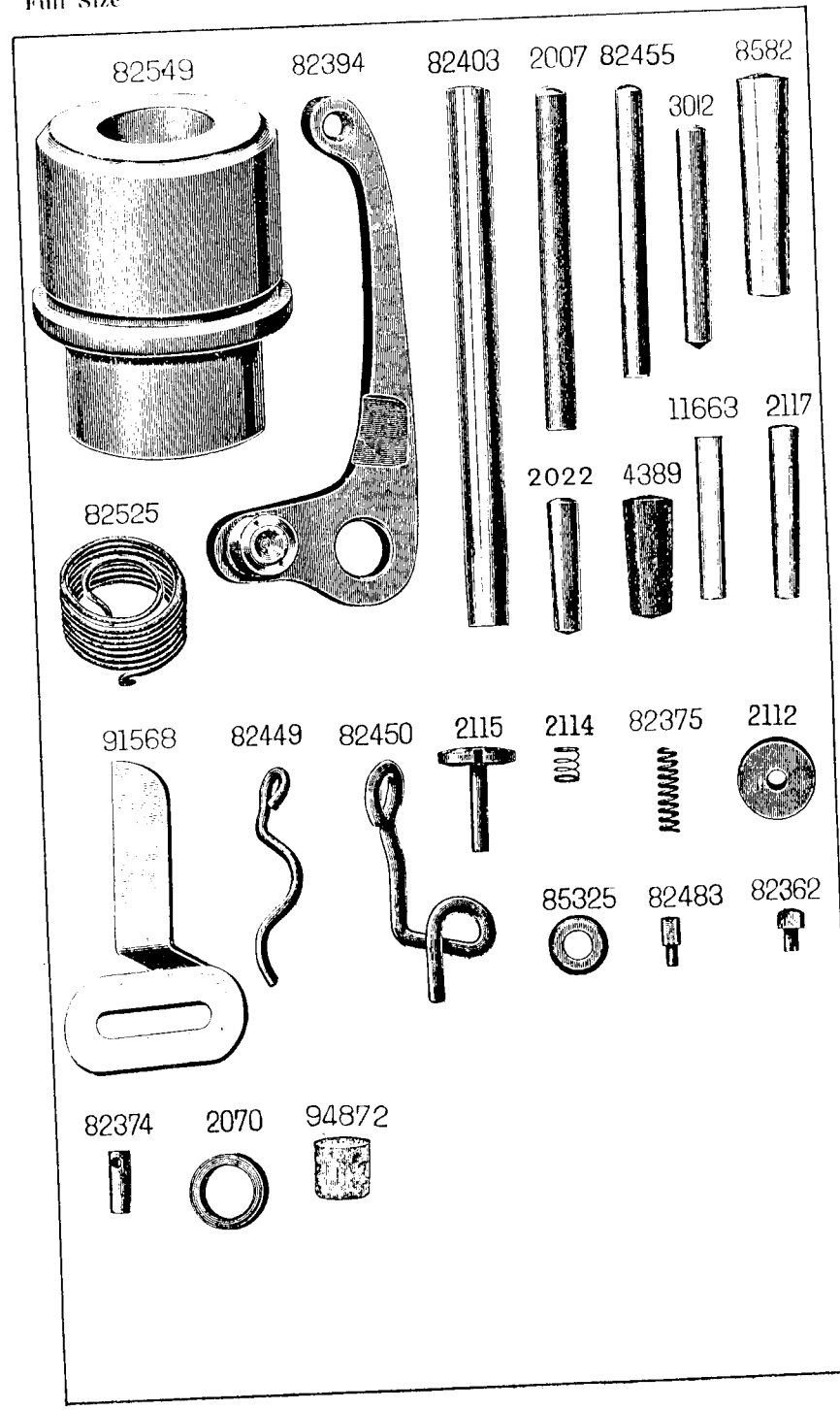
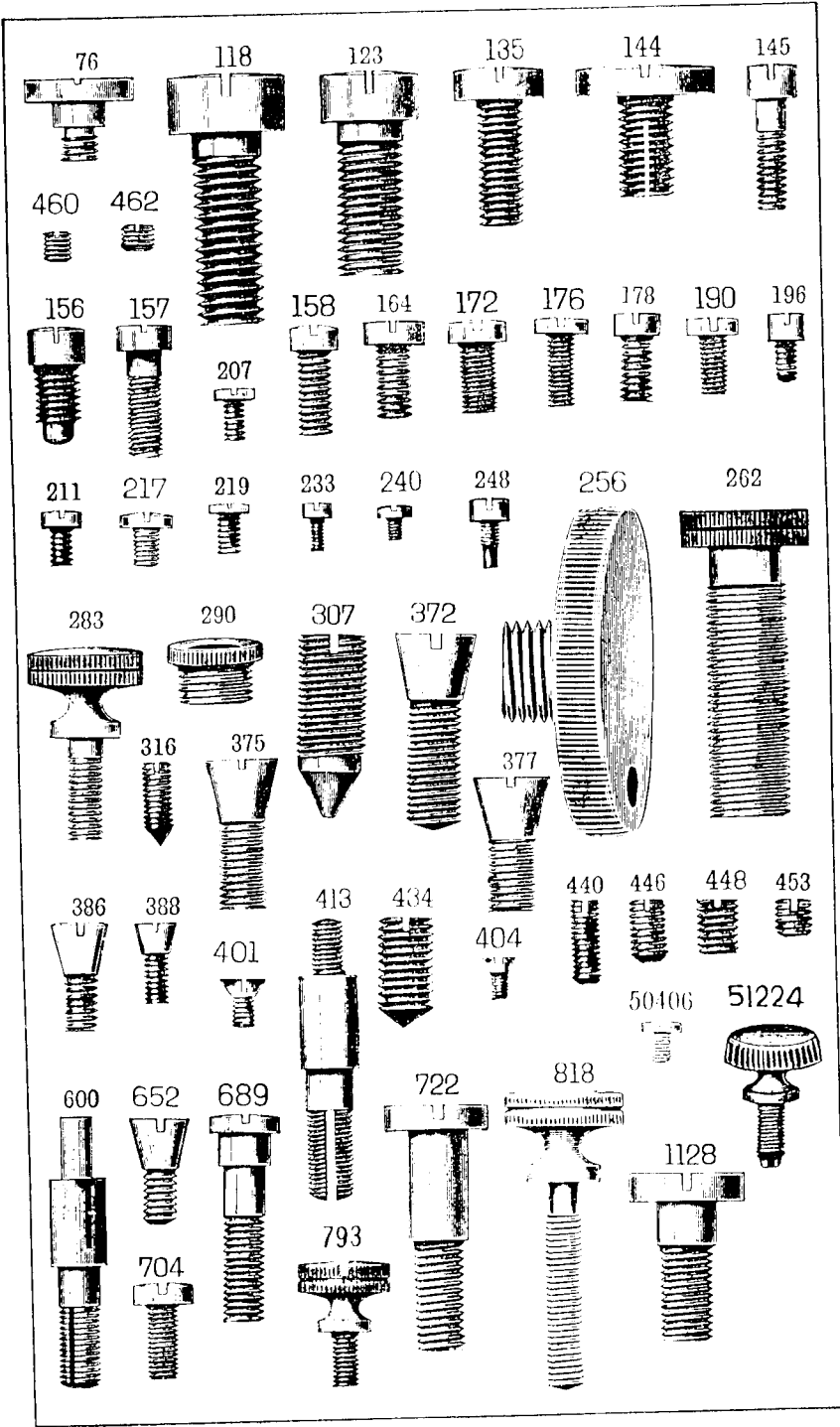

# INSTRUCTIONS FOR ORDERING

In ordering from this List, the prefix and affix letters with the part number **MUST BE** quoted exactly as they are shown in the first column.

A number always indicates the same part in whatever List it may appear, or for whatever machine.

The affix letters (where shown) indicate the style of finish, as follows:—

- A. Hardened, Polished, Nickel Plated and Buffed.
- A.A. Buffed and Chromium Plated.
- A.B. Hardened, Polished, Buffed and Chromium Plated.
- A.C. Brown Baking Enamel Finish.
- A.D. Grey Baking Enamel Finish.
- A.E. Hardened, Bright Rumbled and Nickel Plated.
- A.F. Hardened, Bright Rumbled and Nickel Plated, Bright Rumbled and Chromium Plated.
- A.J. Polished, Nickel Plated and Chromium Plated.
- A.K. Hardened, Polished, Nickel Plated and Chromium Plated.
- A.L. Heat Treated for Toughness.
  - B. Polished, Nickel Plated and Buffed.
  - C. Hardened only.
- C.R. Hardened and Merlized.
  - D. Polished only.
  - E. Soft, not Polished.
  - F. Hardened and Polished.
- F.J. Hardened, Polished and Nickel Plated.
- G. Bright Rumbled and Nickel Plated.
- H. Blued.
- J. Nickel Plated only.
- K. Hardened and Nickel Plated.
- L. Brass Plated.
- M. Oxidized.
- N. Japanned, Dull.
- P. Japanned, Bright.
- P.P. Wrinkle Finish.
- R. Merlized.
- S. Cadmium Plated.
- T. Copper Plated.
- T.A. Hardened, Polished, Copper and Nickel Plated and Buffed.
- T.B. Copper and Nickel Plated and Polished.
- T.J. Copper and Nickel Plated only.
- T.K. Hardened, Copper and Nickel Plated.
- T.E. Copper and Brass Plated.
- T.M. Copper Plated and Oxidized.
  - U. Zinc Plated.
  - V. Silver Plated.
  - W. Polished and Nickel Plated.
  - X. Black Oxide for Iron and Steel.
- X.C. Hardened and Black Oxide for Iron and Steel.
  - Y. Black Nickel Plated only.
  - Z. Chromium Plated.
- Z.A. Hardened, Polished, Nickel Plated, Buffed and Chromium Plated.
- Z.B. Polished, Nickel Plated, Buffed and Chromium Plated.
- Z.C. Hardened and Chromium Plated.
- Z.D. Polished and Chromium Plated.
- Z.G. Bright Rumbled, Nickel Plated, Bright Rumbled and Chromium Plated.
- Z.J. Nickel and Chromium Plated.
- Z.T. Copper and Chromium Plated.

Parts marked with an asterisk (\*) are furnished only when the repairs are made at Factory.

## PARTS COMPLETE

FOR

### No. 34K1 MACHINE

#### DROP FEED. PILLAR 11" HIGH. LIFTING PRESSER.

(Obsolete)

No.	Plate					
*82351		Arm with 48c, 3005 and 449	...	...	...	...
123e	2600	" Screw (3)	...	...	...	...
4389	2601	" Steady Pin (2)	...	...	...	...
12453		" Oil Tube	...	...	...	...
82352		Arm Pillar	...	...	...	...
135e	2600	" " Screw (3)	...	...	...	...
4389	2601	" " Steady Pin	...	...	...	...
283d	2600	" " Thumb Screw (only supplied when machine is fitted with Extension Table and at an extra charge).	...	...	...	...
80795		Arm Shaft for Tight Wheel Machine	...	...	...	...
80501		" " for Loose Wheel Machine	...	...	...	...
3005	242	" " Bushing (back)	...	...	...	...
448c	2600	" " " ( " ) Set Screw	...	...	...	...
449		" " " (front)	...	...	...	...
444c	2600	" " Screw for 80795	...	...	...	...
1288		Arm Side Cover	...	...	...	...
51224d	2600	" " " Thumb Screw	...	...	...	...
2007	2601	" Spool Pin	...	...	...	...
8582	2601	" Steady Pin	...	...	...	...
7370		Balance Wheel with two 448c (Tight Wheel)	...	...	...	...
80504		" " (Loose Wheel)	...	...	...	...
448c	2600	" " Set Screw	...	...	...	...
*82353		Bed	...	...	...	...
256w	2600	Clamp Stop Motion Clamp Screw	...	...	...	...
248d	2600	" " " " Stop Screw	...	...	...	...
2020	2593	" " " " Washer	...	...	...	...
*3023		" " " Flanged Bushing	...	...	...	...
4933		" " " " " with two 462al	...	...	...	...
2022	2601	" " " " " Pin	...	...	...	...
462al	2600	" " " " " Set Screw	...	...	...	...
3022		Clamp Stop Motion, complete, Nos. 248d, 256w, 2020 and 4933	...	...	...	...

## PARTS FOR No. 34KI MACHINE

No.	Plate	
82354	241	<b>Crank Connecting Rod</b> with 145c, 7927, 94872 and two 158c
145c	2600	" " " Adjusting Screw ... ..
*7927	---	" " " Cap ... ..
94872	2601	" " " " Oil Pad ... ..
158c	2600	" " " " Screw ... ..
SS17c	2599	" " " Hinge Screw ... ..
1518c	2599	" " " " " Nut ... ..
82363	240	<b>Face Plate</b> ... ..
164d	2600	" " Screw ... ..
82369	---	<b>Face Plate</b> , complete, Nos. 145c, 460c, 2111, 16202, 80081, 80259, 80548, 80688, 82358, 82363, two each 233d and 2102 for Machine without Foot or Knee Lifter ... ..
82551	---	<b>Face Plate</b> , complete, Nos. 145c, 460c, 2111, 16202, 80259, 80548, 80688, 82358, 82363, 82553, two each 233d and 2102 for Machine with Foot or Knee Lifter ... ..
3032	242	<b>Feed Cam</b> with 446c ... ..
446c	2600	" " Set Screw ... ..
52165	242	<b>Feed Connecting Link</b> ... ..
375c	2600	" " " Hinge Screw ... ..
1518c	2599	" " " " " Nut ... ..
82360	2593	<b>Feed Dog</b> (fine) with 82362 ... ..
82361	2593	" " (coarse) with 82362 ... ..
82362	2601	" " Steady Pin ... ..
219c	2600	" " Screw ... ..

*NOTE:—No. 82361 is sent with this machine unless otherwise specified on order.*

82355	241	<b>Feed Forked Connection</b> with 145c ... ..
145c	2600	" " " Adjusting Screw ... ..
SS17c	2599	" " " Hinge Screw ... ..
1518c	2599	" " " " " Nut ... ..
82356	241	<b>Feed Lever</b> with 82357 and two 176d ... ..
*82357	248	" " Cap ... ..
176d	2600	" " " Screw ... ..
93418	242	" " Connecting Crank ... ..
722d	2600	" " " Hinge Screw ... ..
82359	242	" " " Link ... ..
377c	2600	" " " Hinge Screw for 82356 ... ..
1519c	2599	" " " " " Nut for 82356 ... ..
372c	2600	" " " " " for 93418 ... ..
1518c	2599	" " " " " Nut for 93418 ... ..
SS18d	2599	" " Hinge Screw ... ..

## PARTS FOR No. 34KI MACHINE

No.	Plate	
3039	242	<b>Feed Regulator</b> ... ..
1128c	2600	" " Hinge Screw ... ..
818d	2600	" " Thumb Screw ... ..
7860	241	<b>Feed Rock Shaft</b> ... ..
82390	---	" " " 7860 with 82501 ... ..
82501	2597	" " " Crank with two 157c ... ..
157c	2600	" " " Clamping Screw ... ..
307c	2600	" " " Screw Centre ... ..
1513c	2599	" " " " " Nut ... ..
†85980	---	<b>Guide</b> ... ..
†51224d	---	" Thumb Screw ... ..
82391	---	<b>Lifting Presser Plunger</b> ... ..
82389	248	" " " 82391 with 8386 and 82392 ... ..
82392	---	" " " Roller ... ..
8386	---	" " " " Pin ... ..
80559b	---	" " " Yoke ... ..
178b	2600	" " " " Set Screw ... ..
SS14b	2599	" " " " Clamping Screw ... ..
80686b	248	" " " " 80559b with SS14b and 178b ... ..
5456	240	<b>Needle Bar</b> (for Round Shank Needle) ... ..
82472	248	" " Cam with two 172c ... ..
172c	2600	" " " Clamping Screw ... ..
5458	2593	" " " Guide ... ..
158c	2600	" " " " Screw ... ..
290c	2600	" " " Screw Bushing ... ..
2167	2597	<b>Needle Clamp</b> with 196d ... ..
196d	2600	" " Screw ... ..
8223	2597	" " Thread Eyelet ... ..
233d	2600	" " " " Screw ... ..
7862	241	<b>Oscillating Rock Shaft</b> ... ..
82367	242	" " " Feed Raising Cam Segment Gear with 446c ... ..
446c	2600	" " " " " " " " " Gear Set Screw ... ..
2117	2601	" " " " " " " " " Gear Pin ... ..
307c	2600	" " " " Screw Centre ... ..
1513c	2599	" " " " " Nut ... ..
82365	241	<b>Oscillating Shuttle Shaft</b> ... ..
82366	242	" " " Bevel Pinion Gear with 453c ... ..
453c	2600	" " " " " " " " Set Screw ... ..
11663	2601	" " " " " " " " Pin ... ..

† Only supplied when machine is fitted with Extension Table and at an extra charge.

## PARTS FOR No. 31KI MACHINE

No.	Plate					
3054	241	<b>Presser Bar</b>	...	...	...	...
80269	248	"	"	Lifter	...	...
689c	2600	"	"	"	Hinge Screw	...
1520r	2595	"	"	"	"	Nut
80687	242	"	"	Lifting Bracket with 453c	...	...
453c	2600	"	"	"	Set Screw	...
82498	248	"	"	"	Cam	...
704c	2600	"	"	"	Screw	...
290c	2600	"	"	Screw Bushing	...	...
82517	-	"	"	Spring	...	...
2070	2601	"	"	"	Washer	...
262d	2600	"	"	"	Regulating Thumb Screw	...
1632	2599	"	"	"	"	Lock Nut
80569	248	"	"	"	"	Wrench
82368	248	<b>Presser Foot</b>	...	...	...	...
82505	2593	"	"	(Ribbed on Sole)	...	...
176d	2600	"	"	Screw	...	...

NOTE. No. 82368 is sent with this machine unless otherwise specified on order.

1867	-	<b>Roller,</b>	$\frac{9}{16}$ "	Coarse, with 388d and 1550j	for 2194	...
1843	-	"	$\frac{9}{16}$ "	Fine, " 388d	" 1550j	" 2195
1868	-	"	$\frac{7}{8}$ "	Coarse, " 652d	" 1528j	" 2196
1841	-	"	$\frac{7}{8}$ "	Fine, " 652d	" 1528j	" 2197
1839	-	"	$1\frac{1}{4}$ "	Coarse, " 386d	" 1528j	" 16099
1869	-	"	$1\frac{1}{4}$ "	Fine, " 386d	" 1528j	" 16100
1870	-	"	$1\frac{1}{2}$ "	Coarse, " 386d	" 1528j	" 2200
1853	-	"	$1\frac{1}{2}$ "	Fine, " 386d	" 1528j	" 2201
2202	-	"	-	Arm for 2194 and 2195	...	...
2203	-	"	-	" " 2196	" 2197	...
16098	-	"	-	" " 16099	" 16100	...
4863	-	"	-	" " 2200	" 2201	...
440f	2600	"	-	Adjusting Screw	...	...
1547h	2599	"	-	"	"	Nut
2206	-	"	-	Bracket for 2194 to 2197	...	...
4282	-	"	-	"	"	16099 and 16100
4367	-	"	-	"	"	2200 " 2201
316f	2600	"	-	"	"	Screw Centre
1547h	2599	"	-	"	"	"
2205	-	"	-	"	"	Nut
2205	-	"	-	"	"	Lock Spring
176f	2600	"	-	"	"	Screw
1549d	2599	"	-	"	"	Nut
80107	-	<b>Wrench</b>	...	...	...	...
2194	-	<b>Roller Presser</b> , complete, $\frac{9}{16}$ " (Coarse Roller), Nos. 176f, 440f, 1549d, 1867, 2202, 2205, 2206, two 316f and three 1547h	...	...	...	...

## PARTS FOR No. 31KI MACHINE

No.	Plate					
2195	-	<b>Roller Presser</b> , complete, $\frac{9}{16}$ " (Fine Roller), Nos. 176f, 440f, 1549d, 1843, 2202, 2205, 2206, two 316f and three 1547h	...	...	...	...
2196	-	<b>Roller Presser</b> , complete, $\frac{7}{8}$ " (Coarse Roller), Nos. 176f, 440f, 1549d, 1868, 2203, 2205, 2206, two 316f and three 1547h	...	...	...	...
2197	-	<b>Roller Presser</b> , complete, $\frac{7}{8}$ " (Fine Roller), Nos. 176f, 440f, 1549d, 1841, 2203, 2205, 2206, two 316f and three 1547h	...	...	...	...
16099	-	<b>Roller Presser</b> , complete, $1\frac{1}{4}$ " (Coarse Roller), Nos. 176f, 440f, 1549d, 1839, 2205, 4282, 16098, two 316f and three 1547h	...	...	...	...
16100	-	<b>Roller Presser</b> , complete, $1\frac{1}{4}$ " (Fine Roller), Nos. 176f, 440f, 1549d, 1869, 2205, 4282, 16098, two 316f and three 1547h	...	...	...	...
2200	-	<b>Roller Presser</b> , complete, $1\frac{1}{2}$ " (Coarse Roller), Nos. 176f, 440f, 1549d, 1870, 2205, 4367, 4863, two 316f and three 1547h	...	...	...	...
2201	-	<b>Roller Presser</b> , complete, $1\frac{1}{2}$ " (Fine Roller), Nos. 176f, 440f, 1549d, 1853, 2205, 4367, 4863, two 316f and three 1547h	...	...	...	...
NOTE. Roller Presser is only supplied when specified on order and at an extra charge.						
190d	2600	<b>Roller Presser Screw</b>	...	...	...	...
388d	2600	"	Screw for 1843 and 1867	...	...	...
652d	-	"	" " 1841	" 1868	...	...
386d	2600	"	" " 1839, 1853, 1869 and 1870	...	...	...
1550j	2599	"	"	Nut for 388d	...	...
1528j	2599	"	"	"	"	386d and 652d
82552	2596	<b>Shuttle Bobbin</b> (solid, hardened)	...	...	...	...
7868	2596	"	"	Retaining Spring	...	...
SS133d	2599	"	"	"	"	Screw
81993	-	"	"	Body	...	...
81994	-	"	"	Tension Spring	...	...
SS132d	2599	"	"	"	"	Screw
81951	2596	"	"	Thread Pull-off	...	...
404d	2600	"	"	"	"	Screw
81952	2596	<b>Shuttle</b> , complete, Nos. SS132d, SS133d, 404d, 7868, 81951, 81993, 81994 and 82552	...	...	...	...
82372	2596	<b>Shuttle Carrier</b> with two 453c	...	...	...	...
453c	2600	"	"	Set Screw	...	...
82373	248	"	"	Cover	...	...
SS19d	2599	"	"	Hinge Screw	...	...
82482	2593	"	"	Latch Spring	...	...
207d	2600	"	"	"	"	Screw
85325	2601	"	"	"	"	Washer
82483	2601	"	"	"	"	Steady Pin
82374	2601	"	"	"	"	Retaining Pin
SS122e	2599	"	"	"	"	Guide Screw
82375	2601	"	"	"	"	Spring
82376	242	"	"	Lifter	...	...
82370	2596	"	"	Ring Seat	...	...
82371	2596	"	"	"	"	Fixing Pin

## PARTS FOR No. 34KI MACHINE

No.	Plate						
2102	2593	<b>Tension Disc</b>	...	...	...	...	...
80081	2593	"	Release Pin for 82369	...	...	...	...
82553	---	"	Releasing Lever for 82554	...	...	...	...
80548	2593	"	Spring	...	...	...	...
*600c	2600	"	Screw Stud	...	...	...	...
16202	---	"	" " 600c with 1560d	...	...	...	...
145e	2600	"	" " Clamping Screw	...	...	...	...
1560d	2599	"	" " Regulating Thumb Nut	...	...	...	...
82358	248	<b>Thread Guard</b>	...	...	...	...	...
233d	2600	"	" Screw	...	...	...	...
2112	2601	<b>Thread Retaining Disc</b>	with 2113	...	...	...	...
2113	---	"	" " Steady Pin	...	...	...	...
2114	2601	"	" Spring	...	...	...	...
2115	2601	"	" Stud	...	...	...	...
460c	2600	"	" " Set Screw	...	...	...	...
2111	---	<b>Thread Retainer Guide</b> ,	complete, Nos. 2112, 2114 and 2115	...	...	...	...
82378	---	<b>Thread Take-up Cam</b>	(Steel) with 446c and 453c	...	...	...	...
3012	2601	"	" " Pin	...	...	...	...
RR42	2599	"	" " Roller and Stud	...	...	...	...
453c	2600	"	" " " Set Screw	...	...	...	...
446c	2600	"	" " Set Screw	...	...	...	...
82377	248	"	" " 82378 with RR42, 82498 and two 704c	...	...	...	...
82394	2601	"	" " Lever with 1819	...	...	...	...
76d	2600	"	" " Hinge Screw	...	...	...	...
1819	2599	"	" " Roller and Stud	...	...	...	...
80259	2593	"	" " Spring...	...	...	...	...
80688	---	"	" " Regulator Plate	...	...	...	...
233d	2600	"	" " " Screw	...	...	...	...
82379	2593	<b>Throat Plate</b>	(fine)	...	...	...	...
82380	2593	"	" (coarse)	...	...	...	...
211f	2600	"	" Screw	...	...	...	...
<i>NOTE. No. 82380 is sent with this machine unless otherwise specified on order.</i>							
87346	---	<b>Drip Pan</b>	...	...	...	...	...

PARTS SPECIAL  
TO  
No. 34K5 MACHINE

DROP FEED. PILLAR 7" HIGH. LIFTING PRESSER.

This Machine is the same as No. 34KI with the following exceptions :-

No.	Plate						
82395	240	<b>Arm Pillar</b>	...	...	...	...	...
*82381	---	<b>Bed</b>	...	...	...	...	...
7883	240	<b>Crank Connecting Rod</b>	with 7927, 94872 and two 158c	...	...	...	...
372c	2600	"	" " Hinge Screw	...	...	...	...
82383	2593	<b>Feed Dog</b>	(fine) with 82362	...	...	...	...
82384	2593	"	" (coarse) with 82362	...	...	...	...
<i>NOTE. No. 82383 is sent with this machine unless other Feed Dog is specified on order.</i>							
7884	240	<b>Feed Forked Connection</b>	...	...	...	...	...
372c	2600	"	" " Hinge Screw	...	...	...	...
82382	240	<b>Feed Lever</b>	with 82357 and two 176d	...	...	...	...
82385	240	<b>Oscillating Shuttle Shaft</b>	...	...	...	...	...
7872	2596	<b>Shuttle Cover</b>	...	...	...	...	...
7873	2596	"	" Latch Spring	...	...	...	...
82374	2596	"	" " Steady Pin	...	...	...	...
82387	2593	<b>Throat Plate</b>	(fine)	...	...	...	...
82388	---	"	" (coarse)	...	...	...	...
<i>NOTE. No. 82388 is sent with this machine unless otherwise specified on order.</i>							

## PARTS COMPLETE FOR No. 34K11 MACHINE

### DROP FEED. PILLAR 11" HIGH. LARGE SHUTTLE FOR HEAVY WORK.

No.	Plate	
*82396	-	<b>Arm</b> with 446c, 82499 and 82549 ... ..
118c	2600	" Screw (3) ... ..
8582	2601	" Steady Pin (2) ... ..
82542		<b>Arm Pillar</b> ... ..
135e	2600	" " Screw (3) ... ..
8582	2601	" " Steady Pin (2) ... ..
283d	2600	" " Thumb Screw <i>(only supplied when machine is fitted with Extension Table and at an extra charge).</i>
82545	-	<b>Arm Shaft</b> ... ..
82499	2597	" " Bushing (back) ... ..
446c	2600	" " " ( " ) Set Screw ... ..
82549	2601	" " " (front) ... ..
82400	2597	" " Oil Tube ... ..
144c	2600	" " Screw ... ..
82402	2592	<b>Arm Side Cover</b> ... ..
51224d	2600	" " " Thumb Screw ... ..
82403	2601	" Spool Pin ... ..
82404	2591	<b>Balance Wheel</b> (two speed) with two 434c ... ..
434c	2600	" " Set Screw ... ..
*82405		<b>Bed</b> ... ..
82406	2591	<b>Crank Connecting Rod</b> with SS44c, 7927, 94872 and two 158c
SS44c	2599	" " " Adjusting Screw ... ..
*7927	-	" " " Cap ... ..
94872	2601	" " " Oil Pad ... ..
158e	2600	" " " Screw ... ..
SS17c	2599	" " " Hinge Screw ... ..
1518e	2599	" " " " Nut ... ..
82407	2592	<b>Face Plate</b> ... ..
SS45d	2599	" " Screw ... ..
82408		<b>Face Plate</b> , complete, Nos. SS50f, 233d, 446c, 82407, 82449, 82450, 82455, 82502, 82503, 82525 and 82551 ... ..
3032	242	<b>Feed Cam</b> with 446c ... ..
446c	2600	" " Set Screw ... ..

## PARTS FOR No. 34K11 MACHINE

No.	Plate	
52165	242	<b>Feed Connecting Link</b> ... ..
375c	2600	" " " Hinge Screw ... ..
1518c	2599	" " " " Nut ... ..
82507	2591	<b>Feed Dog</b> (three rows of teeth) with 82362 ... ..
217f	2600	" " Screw ... ..
82362	2595	" " Steady Pin ... ..
82410	2591	<b>Feed Forked Connection</b> with SS44c ... ..
SS44c	2599	" " " Adjusting Screw ... ..
SS17c	2599	" " " Hinge Screw ... ..
1518c	2599	" " " " Nut ... ..
82533	2598	<b>Feed Lever</b> with 82357, 82535, two each 176d and 401e ... ..
*82535		" " Cam Bearing Strip ... ..
401e	2600	" " " " Screw ... ..
*82357	248	" " Cap ... ..
176d	2600	" " " Screw ... ..
82412	2597	" " Connecting Crank ... ..
722d	2600	" " " " Hinge Screw ... ..
82413	2597	" " " Link ... ..
377c	2600	" " " " Hinge Screw for 82533 ... ..
1519c	2599	" " " " Nut for 82533 ... ..
375c	2600	" " " " for 82412 ... ..
1518c	2599	" " " " Nut for 82412 ... ..
SS176d	2599	" " Hinge Screw ... ..
82414	2597	<b>Feed Regulator</b> ... ..
1128c	2600	" " Hinge Screw ... ..
SS115d	2599	" " Thumb Screw ... ..
82415	2598	<b>Feed Rock Shaft</b> ... ..
82416		" " " 82415 with 82501 ... ..
82501	2597	" " " Crank with two 157c ... ..
157c	2600	" " " " Clamping Screw ... ..
307c	2600	" " " Screw Centre ... ..
1513c	2599	" " " " Nut ... ..
*86135	2597	<b>Guide</b> ... ..
*793d	2600	" Thumb Screw ... ..
91021	2598	<b>Needle Bar</b> ... ..
82531	2597	" " Cam with SS202c and two 704c ... ..
SS202c	2599	" " " Adjusting Screw ... ..
704c	2600	" " " Clamping Screw ... ..
82419	2591	" " " Guide ... ..
158c	2600	" " " Screw ... ..
KK31	2599	" " " Roller and Stud ... ..

\* Only supplied when machine is fitted with Extension Table and Work Plate, and at an extra charge.



## PARTS FOR No. 34KH MACHINE

No.	Plate	
82520	2597	<b>Needle Clamp</b> ... ..
156f	2600	" " Set Screw ... ..
82521	2597	" " Thread Eyelet ... ..
50406d	2600	" " " " Screw ... ..
82522	2597	<b>Needle Clamp</b> 82520 with 156f, 50406d and 82521 ... ..
82423	2591	<b>Oscillating Rock Shaft</b> ... ..
82534	2597	" " " Feed Raising Cam Segment Gear with 446c
446c	2600	" " " " " " " " " " Set Screw
2117	2601	" " " " " " " " " " Pin
307c	2600	" " " " " " " " " " Screw Centre ... ..
1513e	2599	" " " " " " " " " " Nut ... ..
82425	2598	<b>Oscillating Shuttle Shaft</b> ... ..
82366	242	" " " Bevel Pinion Gear with 453c
453c	2600	" " " " " " " " " " Set Screw ... ..
11663	2601	" " " " " " " " " " Pin ... ..
82426	2598	<b>Presser Bar</b> with Square End ... ..
82512	2594	" " " Lifter ... ..
SS186d	2599	" " " " " " " " " " Hinge Screw ... ..
1518c	—	" " " " " " " " " " Nut ... ..
82547	—	" " " Lifting Bracket with two 446c
82548	—	" " " " " " " " " " 82547 with 82510 and two 190f ... ..
91568	2601	" " " " " " " " " " Automatic Thread Controller
207f	2600	" " " " " " " " " " " " Screw
446c	2600	" " " " " " " " " " Set Screw ... ..
82510	2594	" " " " " " " " " " Tension Release ... ..
190f	2600	" " " " " " " " " " " " Binding Screw ... ..
SS316	2599	" " " Screw Bushing ... ..
91150	2594	" " " Spring ... ..
†82513	2594	<b>Presser Foot</b> ... ..
SS65f	2599	" " " Screw ... ..
RR25	2595	<b>Roller</b> ( $1\frac{1}{2}$ " diam. $\times$ $\frac{5}{16}$ " face) with 378c and 1520r ... ..
82432	2595	" Arm ... ..
82433	2595	" " Bracket ... ..
430c	2595	" " " Adjusting Screw ... ..
1520r	2595	" " " " " " " " " " Nut ... ..
SS329c	2595	" " " Clamping Screw ... ..
82434	2595	" " Lock Spring ... ..
SS50c	2599	" " " " " " " " " " Screw ... ..
313c	2595	" " " Screw Centre ... ..
1519c	2599	" " " " " " " " " " Nut ... ..

†NOTE.—No. 82513 and SS65c are only supplied with this Machine when specified on order and at an extra charge.

## PARTS FOR No. 34KH MACHINE

No.	Plate	
378c	2595	<b>Roller Bearing Screw</b> ... ..
1520r	2595	" " " Nut ... ..
82435	2595	<b>Roller Presser</b> , complete, ( $1\frac{1}{2}$ " $\times$ $\frac{5}{16}$ " Nos. RR25, SS50c, SS329c, 430c, 1520r, 82432 to 82434, two each 313c and 1519c
82411	2596	<b>Shuttle Bobbin</b> ... ..
82439	2596	" " Retaining Spring ... ..
SS133d	2599	" " " " " " " " " " Screw ... ..
82436	2596	<b>Shuttle Body</b> ... ..
82437	2596	" Tension Spring ... ..
240d	2600	" " " " " " " " " " Screw ... ..
82438	2596	" Thread Pull-off ... ..
404d	2600	" " " " " " " " " " Screw ... ..
82440	2596	<b>Shuttle</b> , complete, Nos. SS133d, 240d, 404d, 82436 to 82439 and 82441
82442	2596	<b>Shuttle Carrier</b> with SS86c and 446c ... ..
446c	2600	" " Set Screw ... ..
SS86c	2599	" " Timing Screw ... ..
82540	2596	<b>Shuttle Cover</b> ... ..
82541	2596	" " Hinge Pin ... ..
SS231e	2599	" " " " " " " " " " Position Screw ... ..
82544	—	" " " 82540 with 82541 ... ..
82374	2601	" " Retaining Pin ... ..
SS122e	2599	" " " " " " " " " " Guide Screw ... ..
82375	2601	" " " " " " " " " " Spring ... ..
82376	242	" Lifter ... ..
82444	2596	" Ring Seat ... ..
82371	2596	" " " " " " " " " " Fixing Pin ... ..
SS317e	2599	<b>Tension Screw Stud</b> ... ..
446c	2600	" " " " " " " " " " Set Screw ... ..
1560d	2599	" " " " " " " " " " Regulating Thumb Nut ... ..
82445	2593	" Spring ... ..
82446	2593	" Washer (Felt) ... ..
82447	2593	" " (Steel) ... ..
82448	2593	" Wheel ... ..
82502	—	<b>Tension</b> , complete, Nos. SS317e, 1560d, 82445, 82448, two each 82446 and 82447 ... ..
82551	2593	<b>Thread Controlling Lever</b> ... ..
82525	2601	" " " Spring ... ..
82455	2601	" " " " " " " " " " Stop Pin ... ..
82450	2601	<b>Thread Eyelet</b> ... ..
SS50f	2599	" " " Screw ... ..
82449	2601	<b>Thread Guard</b> ... ..
233d	2600	" " " Screw ... ..

## PARTS FOR No. 34K11 MACHINE

No.	Plate				
2102	2593	<b>Thread Retainer Disc</b>	...	...	...
*413e	2600	"	"	Screw Stud	...
33892	---	"	"	"	413e with 1560d
1560d	2599	"	"	"	Regulating Thumb Nut
2103	2593	"	"	Spring...	...
82503	---	<b>Thread Retainer</b> , complete, Nos. 2103, 33892 and two 2102	...	...	...
82546	---	<b>Thread Take-up Cam</b> with SS320c and SS370c	...	...	...
SS320c	2599	"	"	"	Set Screw
453c	2600	"	"	"	for RR34
SS370c	2599	"	"	"	Timing Screw
82452	---	<b>Thread Take-up Lever</b>	...	...	...
SS22f	2599	"	"	"	Hinge Screw
RR24	2599	"	"	"	Roller and Stud
1519e	2599	"	"	"	" " " Nut
82453	2594	"	"	"	82452 with RR24 and 1519e
82515	2594	<b>Throat Plate</b> (fine needle hole)	...	...	...
82516	2594	"	"	"	(coarse needle hole)
211f	2600	"	"	"	Screw
<i>NOTE. No. 82516 is sent with this machine unless otherwise specified on order.</i>					
91796	---	<b>Oil Box</b>	...	...	...
82459	---	"	"	"	Cover
82460	---	"	"	"	Hinge Pin
80106	---	"	"	"	Latch Spring
219f	2600	"	"	"	" " " Screw
82462	---	"	"	"	" " " Washer
82463	---	"	"	"	Oil Pad (Cloth)
SS50f	2599	"	"	"	" " " Screw
82462	---	"	"	"	" " " Washer
SS395f	2599	"	"	"	Stud Screw
SS42f	2599	"	"	"	Set Screw
91797	2592	<b>Oil Box</b> , complete, Nos. SS50f, 219f, 80106, 82459, 82460, 82463, 91796 and two 82462	...	...	...
SS39d	2599	<b>Oil Box Screw</b> (to attach to machine)	...	...	...
82550	---	<b>Drip Pan</b>	...	...	...

## Accessories

(FOR GREAT BRITAIN)

## ACCESSORIES supplied with Nos. 34K1 and 34K5 Machines

No.	Plate				
82552	2596	Bobbins (2)	...	...	...
---	---	Instruction Book	...	...	...
84112	---	Machine Button with 84151 and wood screw, 1" No. 9, R.H.B.	...	...	...
84151	---	Machine Button Washer (Leather)	...	...	...
12405	---	Machine Rest (Felt) (4)	...	...	...
28084	---	" " Nails (4)	...	...	...
36569	---	Oiler	...	...	...
25537	---	Screw Driver (machine)	...	...	...
120378	---	" " (shuttle tension)	...	...	...
80107	---	Wrench for 1528, 1547 and 1550	...	...	...
80569	248	" for 1632	...	...	...

## ACCESSORIES supplied with No. 34K11 Machine

No.	Plate				
82441	2596	Bobbins (2)	...	...	...
---	---	Instruction Book	...	...	...
84118	---	Machine Button with 84151 and wood screw, 1 1/4" No. 9, R.H.B.	...	...	...
84151	---	Machine Button Washer (Leather)	...	...	...
36569	---	Oiler	...	...	...
11831	---	Screw Driver (machine)	...	...	...
120378	---	" " (shuttle tension)	...	...	...

## Bobbin Winders

### BOBBIN WINDER (Eccentric) for Nos. 34K1 and 34K5 Machines

No.	Plate	
80817	—	Eccentric
SS469d	2599	" Thumb Screw
80791	—	Frame
SS56d	2599	" Screw
2460	—	Friction Ring (Rubber)
80981	—	Pulley
82466	—	Spindle
82467	—	" 82466 with 80873 and 80981
80873	—	" Collar
82469	—	Bobbin Winder, complete, Nos. SS469d, 2460, 80791, 80817 and 82467

### BOBBIN WINDER (Friction) for No. 34K11 Machine

No.	Plate	
82527	746	Bracket
SS56d	2599	" Screw
82528	746	Frame
32d	746	" Hinge Screw
5960	746	Friction Wheel (Leather)
5961	746	" " Washer
333r	746	" " " Screw
82532	746	Spindle with 15072
15072	—	" Bobbin Position Pin
5963	746	" Flange
82530	746	Frame, complete, Nos. 333r, 5960, 5961, 5963, 82528 and 82532
82537	746	Spring
161d	746	" Screw
82538	746	" " Washer
82526	—	Bobbin Winder, complete, Nos. 32d, 161d, 82527, 82530, 82537 and 82538

## Knee Lifter FOR No. 34K1 Machine

No.	Plate	
82496	251	Arm Lever
82474	—	" " Connecting Chain
694d	251	" " Hinge Screw
6349	251	" " Spring
2767	251	Knee Plate with 356c
356c	251	" " Set Screw
6335	251	" " Arm
2766	251	" " " Bracket with 356c
356c	251	" " " " Set Screw
82477	251	Presser Bar Bracket with 453c
453c	2600	" " " Set Screw
2763	251	Rock Shaft
82478	—	" " 2763 with 2766, 2767, 2770, 6335, 6337 and 82480
82479	251	" " Bracket
—	—	" " " Wood Screw, 1" No. 10
6337	251	" " Lifting Bracket with two 356c
356c	251	" " " " Set Screw
82480	251	" " " " Hook
2770	251	" " Stop Dog with 356c
356c	251	" " " " Set Screw
82475	—	Knee Lifter, complete, Nos. 694d, 6349, 82474, 82477, 82478, 82496, two 82479 and four wood screws, 1" No. 10

## Knee Lifter FOR No. 34K5 Machine

This Knee Lifter is the same as 82475 with the following exceptions:—

No.	Plate	
82497	—	Arm Lever Connecting Chain
82481	—	Knee Lifter, complete, Nos. 694d, 6349, 82477, 82478, 82496, 82497, two 82479 and four wood screws, 1" No. 10