

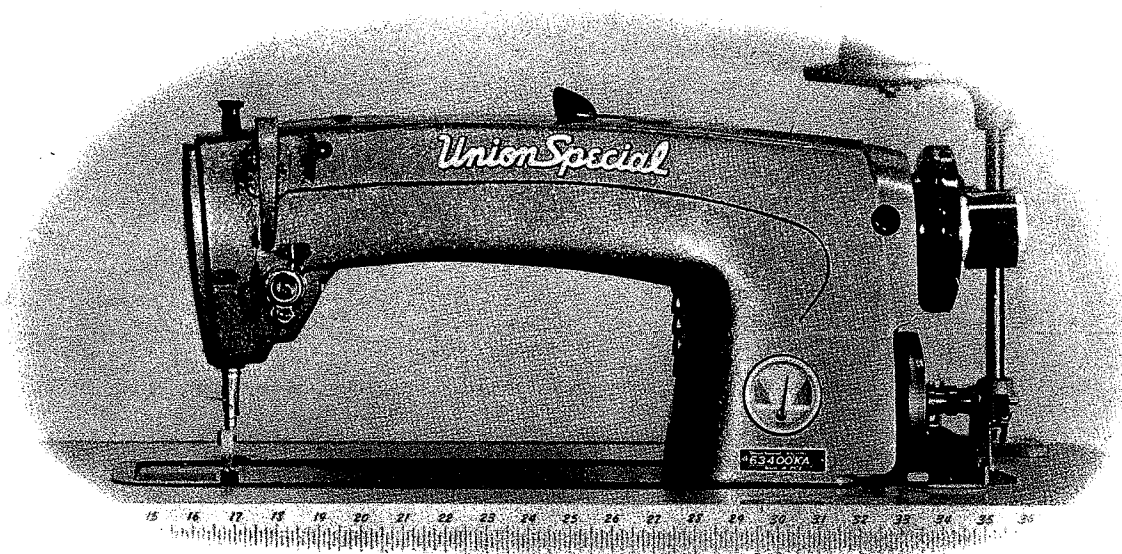

Union Special[®]
LEWIS[®] • COLUMBIA[®]

INDUSTRIAL
SEWING
MACHINES

STYLES
63400 KA
63400 KB



CLASS 63400

STREAMLINED
HIGH SPEED LOCKSTITCH MACHINES
WITH
"KLIPP-IT"[®]
THREAD UNDERTRIMMER

CATALOG
No.
121 KA
Fourth
Edition

UNION SPECIAL CORPORATION

CHICAGO

Catalog No. 121 KA
(Supplement to Catalog No. 121 M)

I N S T R U C T I O N S

F O R

A D J U S T I N G A N D O P E R A T I N G

L I S T O F P A R T S

C L A S S 6 3 4 0 0

S t r e a m l i n e d L o c k s t i t c h

S t y l e s

6 3 4 0 0 K A 6 3 4 0 0 K B

F o u r t h E d i t i o n

C o p y r i g h t 1 9 6 7 & 1 9 7 8

b y

U n i o n S p e c i a l C o r p o r a t i o n
R i g h t s R e s e r v e d i n A l l C o u n t r i e s

UNION SPECIAL CORPORATION

INDUSTRIAL SEWING MACHINES

CHICAGO

P r i n t e d i n U . S . A .

March, 1981

IDENTIFICATION OF MACHINES

Each UNION SPECIAL machine is identified by a Style number which is stamped into the name plate on the machine. Style numbers are classified as standard and special. Standard Style numbers have one or more letters suffixed, but never contain the letter "Z". Example: "Style 63400 KA". Special Style numbers contain the letter "Z". When only minor changes are made in a standard machine, a "Z" is suffixed to the Standard Style number. Example: "Style 63400 KAZ".

Styles of machines similar in construction are grouped under a class number which differs from the style number, in that it contains no letters. Example: "63400".

APPLICATION OF CATALOG

This catalog is a supplement to Catalog No. 121 M and should be used in conjunction therewith. Only those parts which are used on Styles 63400 KA and KB, but not used on Styles 63400 A or B are illustrated and listed at the back of this book. For clarity, certain 63400 A or B parts are shown in phantom to help locate the 63400 KA and KB parts.

Opposite the illustration page, parts are identified by detail number, part number, description, and amount required.

NOTE: When ordering repair parts always use the part number listed in the second column.

Adjusting and operating instructions for Styles 63400 KA and KB are similar to those in Catalog No. 121 M for Styles 63400 A and B respectively. The only instructions included in this catalog are the ones that are different from Styles 63400 A and B, or are additional instructions that pertain specifically to Styles 63400 KA and KB.

The catalog applies specifically to the Standard Styles of machines as listed herein. It can also be applied with discretion to some Special Styles of machines in this class. Reference to direction, such as right, left, front, back, etc., are given from the operator's position while seated at the machine. Operating direction of handwheel is toward the operator.

STYLES OF MACHINES

High Speed Streamlined Long Arm Lockstitch Machines, with Thread Undertrimmer and Thread Wiper, Prepared for Needle Positioner, One Needle, Light, Medium and Heavy Duty, Drop Feed, Rotary Hook, Horizontal Hook Shaft, Push Button Stitch Regulator, Stitch Length Indicator, One Reservoir Enclosed Automatic Lubricating System, Head Oil Siphon, Adjustable Hook Oil Control, Automatic Head Oiling, Needle Bearing Adjustable Feed Eccentric, Needle Bearings for Take-up Lever and Needle Bar Driving Link, Feed Timing on Lower Main Shaft, Maximum Work Space to Right of Needle Bar 11 1/8 inches (282.58 mm).

63400 KA For miscellaneous plain seaming operations on light and medium weight work, 1 9/64 inch (28.98 mm) needle bar travel. Type 183 GXS or 183 GYS needle. Specify presser foot, throat plate, feed dog, stitches per inch, thread size, needle type and size, attachments and guides. Maximum recommended speed 5500 R.P.M. - depending on operation.

63400 KB For miscellaneous plain seaming operations on medium and medium heavy weight work, 1 13/64 inch (30.56 mm) needle bar travel. Type 180 GXS or 180 GYS needle. Specify presser foot, throat plate, feed dog, stitches per inch, thread size, needle type and size, attachments and guides. Maximum recommended speed 5500 R.P.M. - depending on operation.

NEEDLES

Each needle has both a type and size number. The type number denotes the kind of shank, point, length, groove, finish and other details. The size number, stamped on the needle shank, denotes largest diameter of the blade measured across the eye. Collectively, the type number and the size number represent the complete symbol.

Needle Type 180 GXS or 180 GYS is recommended for Style 63400 KB and needle Type 183 GXS or 183 GYS is recommended for Style 63400 KA. Their description and the sizes available are listed below.

<u>Type No.</u>	<u>Description and Sizes</u>
180 GXS	Round shank, round point, lockstitch, short length, ball eye, single groove, wide angle groove, struck groove, deep spot, ball point, chromium plated - sizes 075/029, 080/032, 090/036, 100/040, 110/044, 125/049, 140/054, 150/060.
180 GYS	Round shank, round point, lockstitch, short length, ball eye, single groove, wide angle groove, struck groove, deep spot, chromium plated - sizes 075/029, 080/032, 090/036, 100/040, 110/044, 125/049, 140/054, 150/060.
183 GXS	Round shank, round point, lockstitch, extra short length, ball eye, single groove, wide angle groove, struck groove, deep spot, ball point, chromium plated - sizes 065/025, 075/029, 080/032, 090/036, 100/040, 110/044.
183 GYS	Round shank, round point, lockstitch, extra short length, ball eye, single groove, wide angle groove, struck groove, deep spot, chromium plated - sizes 075/029, 080/032, 090/036, 100/040, 110/044.

To have needle orders promptly and accurately filled, an empty package, a sample needle, or the type and size number should be forwarded. Use description on label. A complete order would read: "1000 Needles, Type 180 GXS, Size 080/032".

Selection of proper needle size should be determined by the size of thread used. Thread should pass freely through the needle eye in order to produce a good stitch formation.

SELECTING THE SIZE OF THE NEEDLE

The strength requirement of the seam produced is largely dependent upon the size of the thread employed. The quality of the work desired is largely dependent upon the size of the needle employed.

SELECTING THE SIZE OF THE NEEDLE (Continued)

The following table shows the preferred size of needle for a given size and kind of thread. The choice, however, should give consideration to factors referred to previous paragraph, which may dictate the selection of a needle size slightly larger or smaller than the size specified.

<u>Cotton Thread Size</u>	<u>Mercerized Thread Size</u>	<u>Needle Size</u>
0	-	150/060
30	B	140/054 to 150/060
36	A	125/049 to 140/054
40	A	110/044 to 125/049
50	0	110/044 to 125/049
60	00	100/040 to 110/044
70	000	090/036 to 100/040
80	0000	080/032 to 090/036
90	0000	080/032 to 090/036
100	-	075/029 to 080/032

IDENTIFYING PARTS

Where the construction permits, each part is stamped with its part number. Parts too small for a complete catalog stamping are identified by letter symbols which distinguish one part from another that is similar in appearance.

Part numbers represent the same part, regardless of the catalog in which they appear.

IMPORTANT! ON ALL ORDERS, PLEASE INCLUDE PART NAME AND STYLE OF MACHINE FOR WHICH PART IS ORDERED.

ORDERING OF REPAIR PARTS

The arrangement of this catalog is to facilitate easy and accurate ordering of replacement parts for Styles 63400 KA and 63400 KB.

Two exploded view plates cover the differences between the Standard Styles listed in this catalog and Styles 63400 A and B covered in Catalog No. 121 M. Each plate presents a sector of the machine, parts being aligned as in their assembled position. On the page opposite the illustration will be found a listing of the parts with their part numbers, descriptions and the number of pieces required in the particular view being shown. Following the exploded view plates, are plates covering the throat plate, feed dog, and presser foot combinations available for these machines.

Numbers in the first column are reference numbers only, and merely indicate the position of the part in the illustration. Reference numbers should never be used in ordering parts. Always use the part number listed in the second column. Each exploded view plate carries a reference number for each available for safe.

ORDERING OF REPAIR PARTS (Continued)

Sub-assemblies, which are sold complete, or by separate part, are in bracket or a solid line box on the picture plate. Component parts of sub-assemblies, which can be furnished for repairs, are indicated by indenting their descriptions under the description of the main sub-assembly. Example:

34	29480 FM	Rotary Tension Release Solenoid Assembly-----	1
35	63458 H	Rotary Solenoid Cover-----	1
36	660-360	Rotary Solenoid-----	1
37	670 G-18	Female Connector Sleeve, green-----	2
38	670 G-23	Male Wire Terminal-----	2
39	660-347	Solenoid Lead Cover-----	1

In those cases where a part is common to all of the machines covered by this catalog, no specific usage will be mentioned in the description. However, when the parts for the various machines are not the same, the specific usage will be mentioned in the description, and, if necessary, the difference will be shown in the illustration.

USE GENUINE REPAIR PARTS

Success in the operation of these machines can be secured only with genuine UNION SPECIAL Repair Parts as furnished by the Union Special Corporation, its subsidiaries and authorized distributors. They are designed according to the most approved scientific principles, and are made with utmost precision. Maximum efficiency and durability are assured.

TERMS

Prices are strictly net cash and subject to change without notice. All shipments are forwarded f.o.b. shipping point. Parcel Post shipments are insured unless otherwise directed. A charge is made to cover the postage and insurance.

INSTALLING

CAUTION! When unpacking, DO NOT lift machine out of box by placing one hand on handwheel. Using both hands on bed casting, lift gently.

Before leaving factory, each UNION SPECIAL machine is sewed off, inspected and carefully packed. After the machine and accessories have been removed from the packing box, the following steps should be followed:

PREPARATION OF MACHINE FOR INSTALLATION

A bag of assembly parts, consisting of one frame thread eyelet, one eyelet attaching screw, one extra bobbin, two hinge studs, two screws for holding miscellaneous attachment to the bed plate, one synchronizer bracket, one synchronizer lead wire clamp, one screw for synchronizer lead wire clamp and three clamps for tension release solenoid lead wire.

Insert hinge studs in holes provided for them in rear of cloth plate. Assemble the upper frame eyelet (A, Fig. 2 A) to top of arm.

STANDARD ACCESSORIES

Included also with each machine is a box of STANDARD ACCESSORIES—containing one bobbin winder assembly, the machine mounting frame, one oil drain jar and its clamp spring, one knee lifter assembly and its rubber pad, bed positioning spring and screw, four isolator pads and clips, and one machine rest pin. These parts are essential when setting up the machine.

TABLE TOPS

Lockstitch machines are installed in table tops, prepared with cut-out, so that the bed plate is FLUSH with the top of the machine mounting frame.

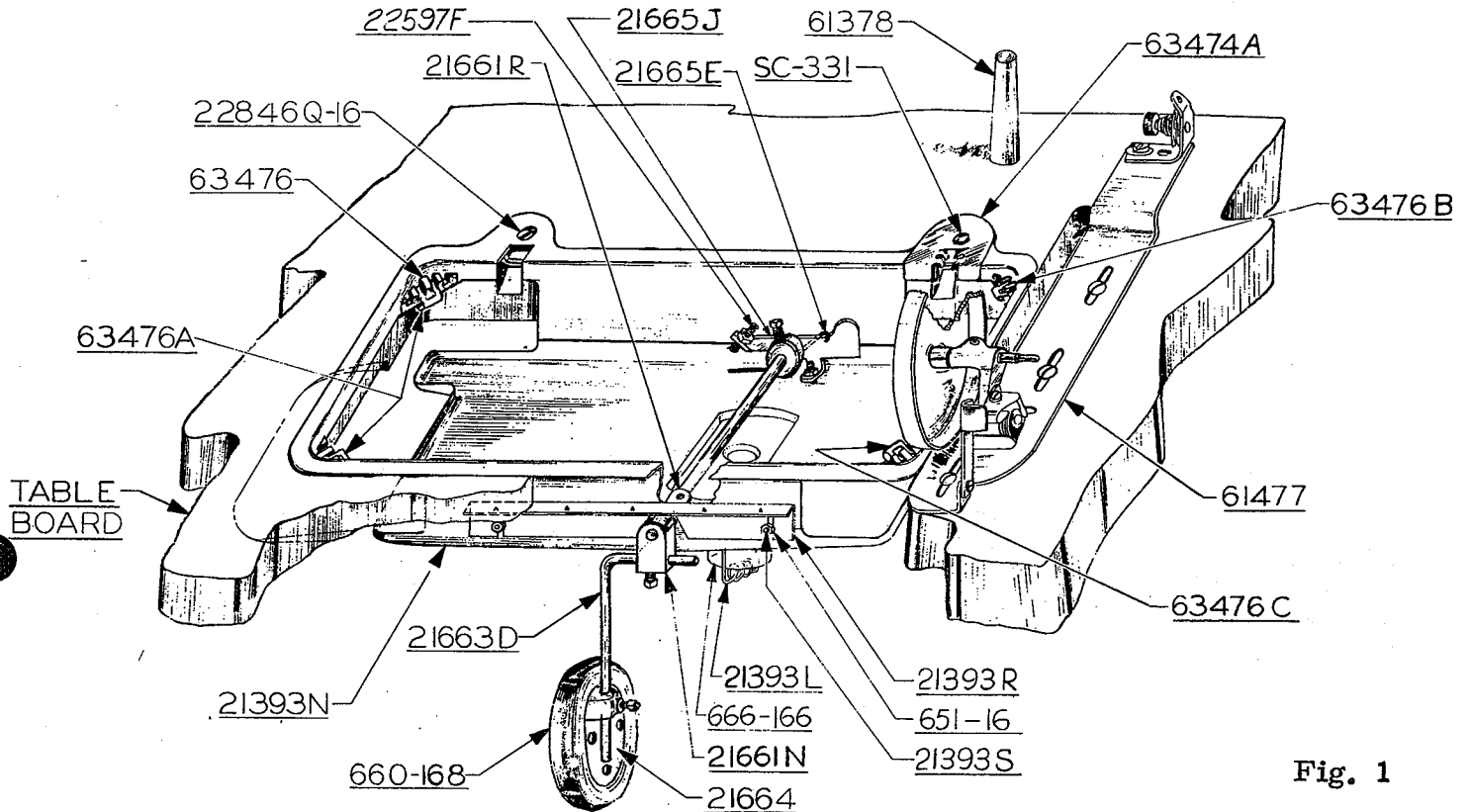

Fig. 1

MACHINE MOUNTING FRAME INSTALLATION

On a suitable tableboard, place machine mounting frame (21393 N) in the machine cut-out with the hinge lugs to the rear (Fig. 1). Insert the countersunk wood screw through left hinge pad and tighten securely. Assemble bed positioning spring (63474A) over right hinge pad; insert round head wood screw and tighten securely. Assemble the retaining plate (21393 R) to outside front of pan section, as shown, and snug up nuts lightly.

Place sewing head in the frame mounting, and after being sure there is about 1/16 inch (1.59 mm) clearance between the cloth plate edge and the frame sides, rap the retaining plate smartly upward with a hammer to insure a good grip on the underside of the board and tighten locking nuts securely.

Tip the machine back against the rest pin, and assemble the knee press assembly as shown. All end play of the cross shaft should be taken up by the cone bearings, but must not bind.

MACHINE MOUNTING FRAME INSTALLATION (Continued)

Before the machine is put into production, the bell crank (21665 J) of the knee lifter rod should be adjusted. The left stop screw (22597 F) should be set so that the maximum lift of the presser bar and its parts do not interfere with moving parts within the head. This may be done by setting the stop screw so that the presser bar raises approximately 5/16 inch (7.94 mm).

BOBBIN WINDER

The bobbin winder should be secured to the table top so that its pulley will be located directly in front of the sewing machine belt and will bear against the belt when in operation. The base of the winder has two elongated attaching holes, which allow the mechanism to be moved closer to or farther away from belt as needed. The pulley of the winder, when in operation, should exert only enough pressure against the belt to wind the bobbin. Regulation and operation of the bobbin winder is described under "Winding the Bobbin", under OPERATOR'S INSTRUCTIONS in Catalog No.121M.

BELTS

These machines are equipped to use either #1 "Vee" or round belts.

THREADING

Thread machine as indicated in Fig. 2A. Threading at check spring has been enlarged for clarity. Needle is threaded from left to right.

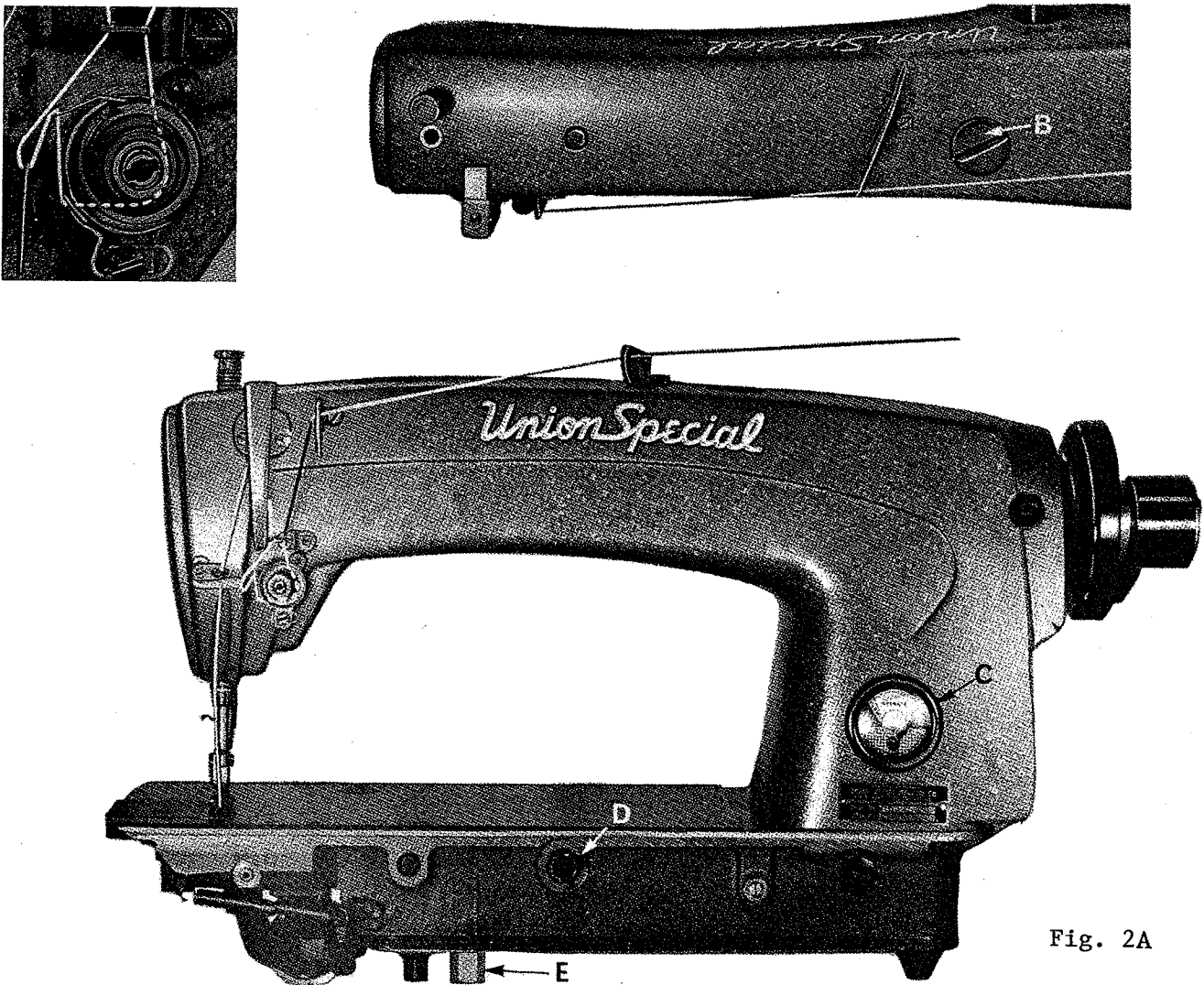

Fig. 2A

OILING

CAUTION! Oil has been drained from the main reservoir before shipment and the reservoir must be filled before starting to operate.

Fill main reservoir at plug screw (B, Fig. 2A) and check oil level at gauge (C); oil is at maximum level when needle is in yellow band marked "FULL". Oil should be added when needle is in yellow band marked "LOW". Use a stainless water-white straight mineral oil of a Saybolt viscosity of 90 to 125 seconds at 100° Fahrenheit in the main reservoir. This is equivalent to Union Special specification No. 175.

Oil may be drained from main reservoir by removing plug screw (E, Fig. 2A).

The quantity of oil supplied to the hook is controlled by dial (D). Turning the dial in the direction of the arrow (counterclockwise) increases the oil flow and in a clockwise direction decreases the flow of oil.

It is recommended that a new machine, or one that has been out of service for a long period, be lubricated by removing the head cover and oiling the moving parts. After oiling, replace head cover as no further hand oiling will be required. Run machine slowly for several minutes to distribute oil to the various parts. Full speed operation can then be expected without damage.

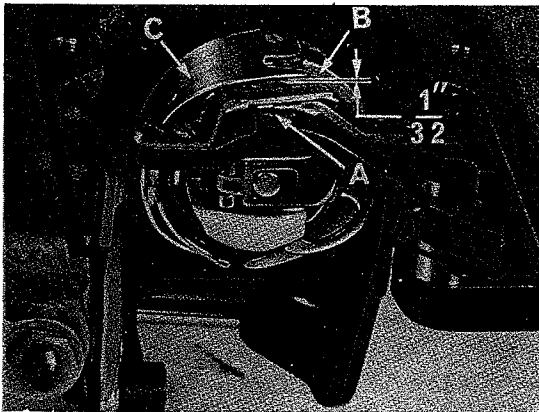

Fig. 12 A

INSTRUCTIONS FOR MECHANICS

The adjusting instructions for Styles 63400 KA and KB are the same as for Styles 63400 A and B respectively, covered in Catalog No. 121 M, with the following exceptions and additions. The instructions that are different from the ones covered in Catalog No. 121 M, the headings will indicate the page it can be found in that catalog.

PRESSER BAR CONNECTION (Page 15)

The presser bar connection (A, Fig. 16 A) should be set so that it is about $7/16$ inch (11.11 mm) above the lower presser bar bushing (Fig. 16 A). This is accomplished by tipping the machine back against the rest pin, loosening the lock nut (A, Fig. 15) and relocating the stop screw (B) on the lifter lever bell crank (C). By turning the stop screw to the right or left, the proper setting of the presser bar connection is accomplished. Tighten the lock nut (A) to lock the stop screw in place.

PRESSER BAR GUIDE (Page 16)

When locating the presser bar guide (B, Fig. 16 A), the presser foot must rest directly against the throat plate with the feed dog in its lowest position. The guide is set properly when there is a $1/16$ inch (1.59 mm) space between guide (B) and presser bar connection (A, Fig. 16 A).

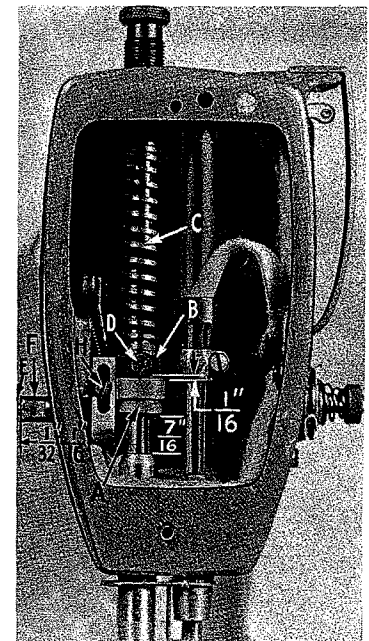

Fig. 16 A

PRESSER BAR GUIDE (Page 16 Continued)

To obtain this setting, remove the pressure from the presser spring (C) and loosen set screw (D). Tap on presser foot to insure its being down on the throat plate. Set the guide to the 1/16 inch (1.59 mm) dimension, center the foot by turning it so that the needle enters the middle of its slot and retighten screw (D) in guide. Now, apply pressure to the presser foot by turning the regulator (A, Fig. 10) clockwise.

Set the needle thread take up wire (A, Fig. 16B) so that the underside of the wire is 4 3/4 inches (120.65 mm) above the throat plate.

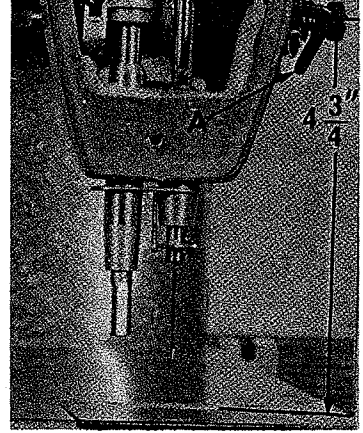

Fig. 16 B

TENSION RELEASE (Page 17)

1. Set the tension assembly so that the tension discs are centered on the check spring eyelet (A, Fig. 18 A).
2. Solenoid plunger pin (E, Fig. 16 A) must touch tension release pin and the end of solenoid plunger pin must protrude a minimum of 1/32 inch (.79 mm) to a maximum of 1/16 inch (1.59 mm). If adjustment is required move tension post assembly in or out by loosening set screw located under machine arm and moving stop screw (B, Fig. 18 A) as required.
3. Tension release solenoid is secured to flat of bushing (F, Fig. 16 A) with a set screw in bracket. Solenoid plunger pin (E) is to have approximately .005 inch (.127 mm) clearance between it and the tension release pin without thread in the tension disc.

This can be accomplished by placing a .005 inch (.127 mm) spacer between the head of solenoid plunger pin and the end of tension release pin. The tension release solenoid should then be slipped onto bushing and moved in until it contacts the solenoid plunger pin. Care should be taken not to exert too much pressure thereby opening the tension disc. After tightening set screw remove spacer.

4. The manual tension release cam (G, Fig. 16 A) should be set so that it will not release thread tension when the presser foot is raised for back tacking.

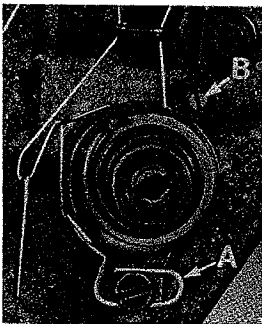

Fig. 18 A

The tension release cam can be positioned by loosening screw (H) and then raising or lowering to suit the sewing conditions. The average tension release point is between 1/4 to 5/16 inch (6.35 to 7.94 mm) of presser foot lift above the throat plate. Tighten screw securely.

NOTE: Head oiler bracket must locate the needle bar link oil wick in the center of the slot in the connecting rod. The wick must contact the needle bearings. Check the oil gauge to be sure it reads full and operates freely.

TRIMMER ADJUSTMENTS

Remove the positioning finger and knife assembly from machine and proceed as follows:

1. There should be no shake or bind in lower knife pivot carrier (A, Fig. 28). This adjustment can be made by loosening screw (B) on the pivot release lever (C) and taking up the excessive end play or relieving the bind as the case may be.
2. Position upper knife (D) parallel with the left side of the arm of the positioning finger. Check to see that the lower knife is parallel with the upper knife. If this is not so, loosen the finger set screw (E) and turn the eccentric bushing (F) until the knives are parallel. A good starting point would be to have the pin hole in the eccentric bushing (F) located approximately 90° to the right side of the arm of the positioning finger (Fig. 30).

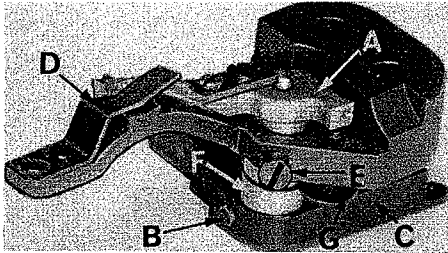

Fig. 28

Adjust lower knife until it just contacts the upper knife. To adjust the lower knife, turn flange screw (G) clockwise to lower knife and counterclockwise to raise it.

CAUTION: Be sure bushing is not turned while making this adjustment or parallel adjustment will have to be checked.

The lower knife (A, Fig. 29) in its extreme left position should not extend beyond the left side of the arm of the positioning finger (B). As the lower knife moves to the right, the run out of the cutting edge (C) must coincide at a point of the positioning finger as indicated at point (D). To make these adjustments, loosen screws (A, Fig. 30) and position knife.

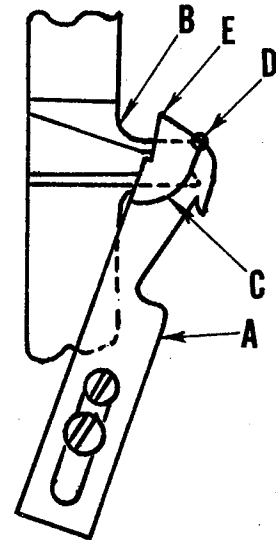

Fig. 29

3. Assemble positioning finger and knife assembly into machine. Adjust the bobbin case holder positioning finger and knife assembly by turning the bobbin case holder until the finger recess is at the top. Place the projection (A, Fig. 12A) on the positioning finger into the bobbin case holder recess (B) and tighten the finger and knife assembly attaching screws securely, allowing 1/32 inch (.79 mm) clearance between the outside edge of projection and the inside edge of bobbin case recess (Fig. 12A).

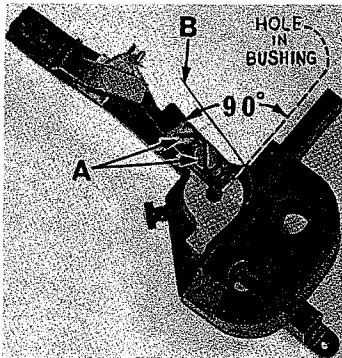

Fig. 30

(A, Fig. 32) is in position.

4. Locate the cutting solenoid bracket (A, Fig. 31) as far forward as possible and parallel with the line of feed. With the cutting solenoid lever (B) contacting the cutting solenoid plunger (C), adjust the pivot release lever (D), so that there is a 1/32 inch (.79 mm) clearance to be maintained when knife return spring

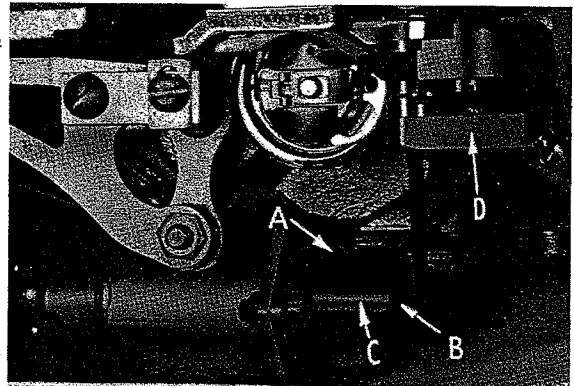

Fig. 31

TRIMMER ADJUSTMENTS (Continued)

5. Adjust the lower knife stop screw (B, Fig. 32) so when the lower knife is in its extreme right hand position, the left corner (E, Fig. 29) is in line with the left side of the needle slot in the bobbin case holder.

CAUTION: Be sure cutting solenoid lever contacts the lower knife stop when making this adjustment. Also be sure knife does not hit the hook point.

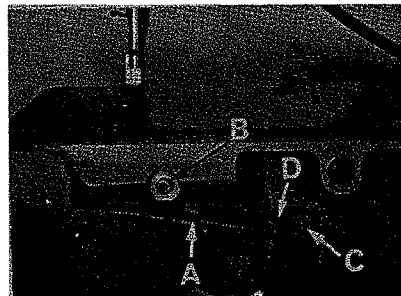

Fig. 32

6. Be sure the spring retainer wire (B, Fig. 30) contacts the bobbin case holder when the lower knife is in its extreme right hand position. If the spring wire does not make contact, bend retainer wire to suit.

NOTE: If positioning finger assembly or cutting solenoid bracket are removed from machine or position changed, check step 5.

7. Knife return spring (A, Fig. 32) to have proper tension to cut threads. To adjust tension of knife return spring loosen screw (C) and move tension spring bracket (D) to the right to increase tension or to the left to decrease the tension.

THREAD WIPER ADJUSTMENTS

1. Rotate thread wiper mounting collar (63470 H) and adjust thread wiper guide (63470 P), so that the hook catches the needle thread when the take-up is at the top of its stroke.
2. Thread wiper lever (63470 E) must return with a snap when released.
3. Form thread wiper wire (63470 F) for free movement in thread wiper guide (63470 P).

CAUTION! Thread wiper hook must not prevent solenoid from returning to its stop. Move thread wiper guide (63470 P) so that hook does not stop against plastic tube. Be sure to loosen set screws when adjusting thread wiper lever. Premature failure of solenoid will result if it is not allowed to return completely.

ADJUSTING INSTRUCTIONS

FOR

TELEDYNE AMCO

Variostop

ALL ELECTRICAL WIRES AND MOTOR CABLES MUST BE FASTENED SECURELY TO THE UNDERSIDE OF THE TABLE BOARD WITH CABLE CLAMPS PROVIDED.

THIS PLANOGRAPH SHOWS THE INSTALLATION OF ELECTRICAL COMPONENT PARTS ON 63400KA & KB MACHINES WITH #800YP-362 NEEDLE POSITIONER.

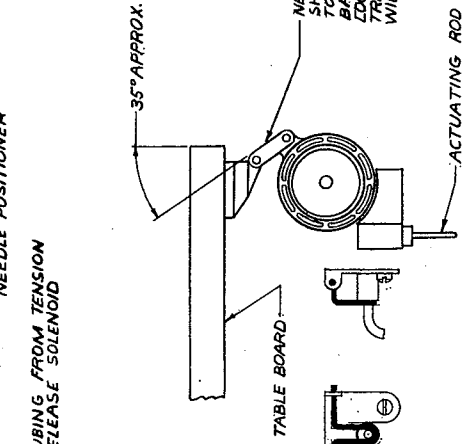
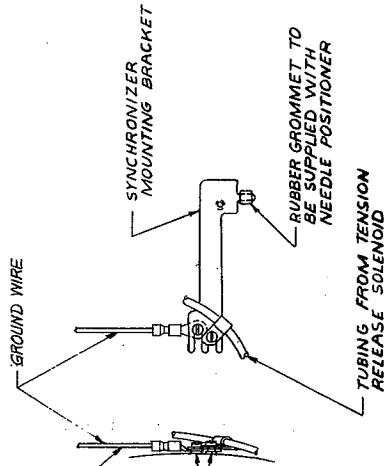
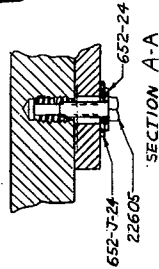
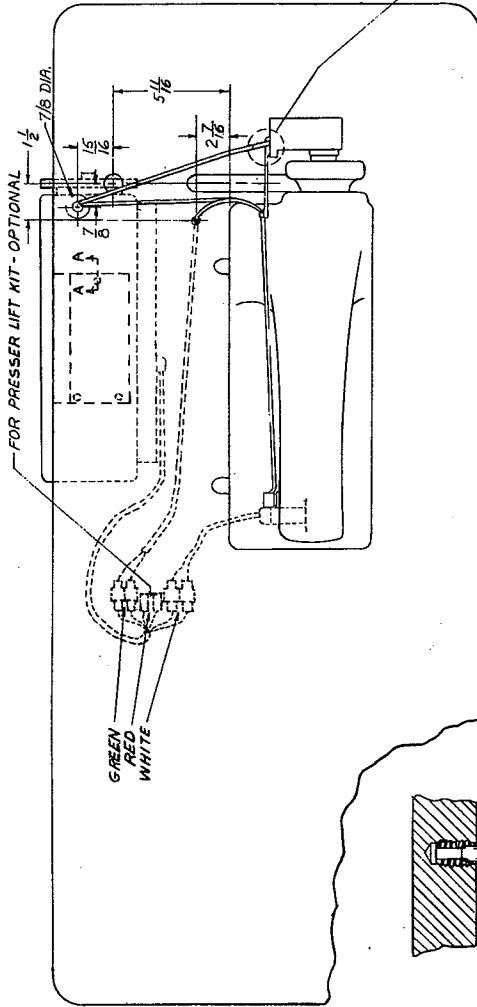
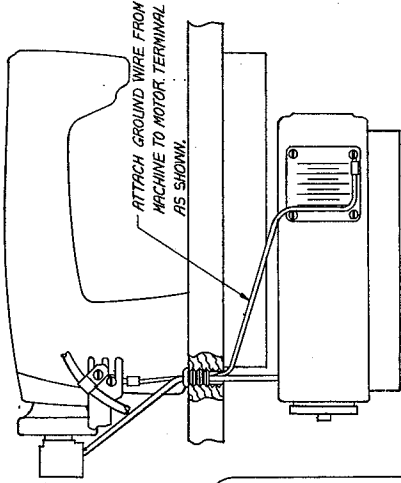

NEEDLE POSITIONER HINGE BRACKET SHOULD BE SET TO ANGLE SHOWN TO ALLOW MACHINE TO BE TILTED BACK TO REST POSITION. LOCATE NEEDLE POSITIONER OVER TREADLE SO THE ACTUATING ROD WILL BE PULLED IN A STRAIGHT LINE.

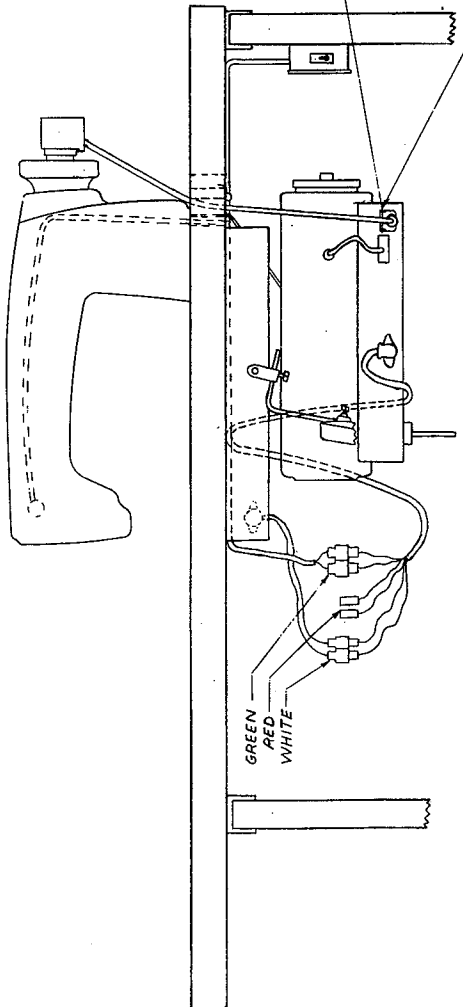

ENLARGED VIEW OF THE ELECTRICAL CONNECTIONS FOR THE TENSION RELEASE SOLENOID AND THE THREAD CUTTING SOLENOID.

PRINTED IN U.S.A.

Fig. 1A

Assemble needle positioner motor to underside of tableboard as shown in Figure 1A.

TRANSFORMER CONNECTIONS

1. Measure line voltage with voltmeter.
2. Disconnect unit from power source.
3. Remove bottom cover from control box.

CAUTION: Transformer taps (A, Fig. 33) are very flexible and care should be taken when removing or replacing connectors (B or C).

NOTE: Dummy connector (B) MUST remain on the transformer tap marked 175-199 when not being used, to prevent any possible damage to unit.

4. Connector and lead (C) must be connected to the proper transformer tap corresponding to line voltage. Example: If line voltage measures 219 VAC, (C) should be connected to the tap marked 215-229 as shown. Should line voltage measure between 175-199 VAC, remove dummy connector (B) and connect (C) to tap.

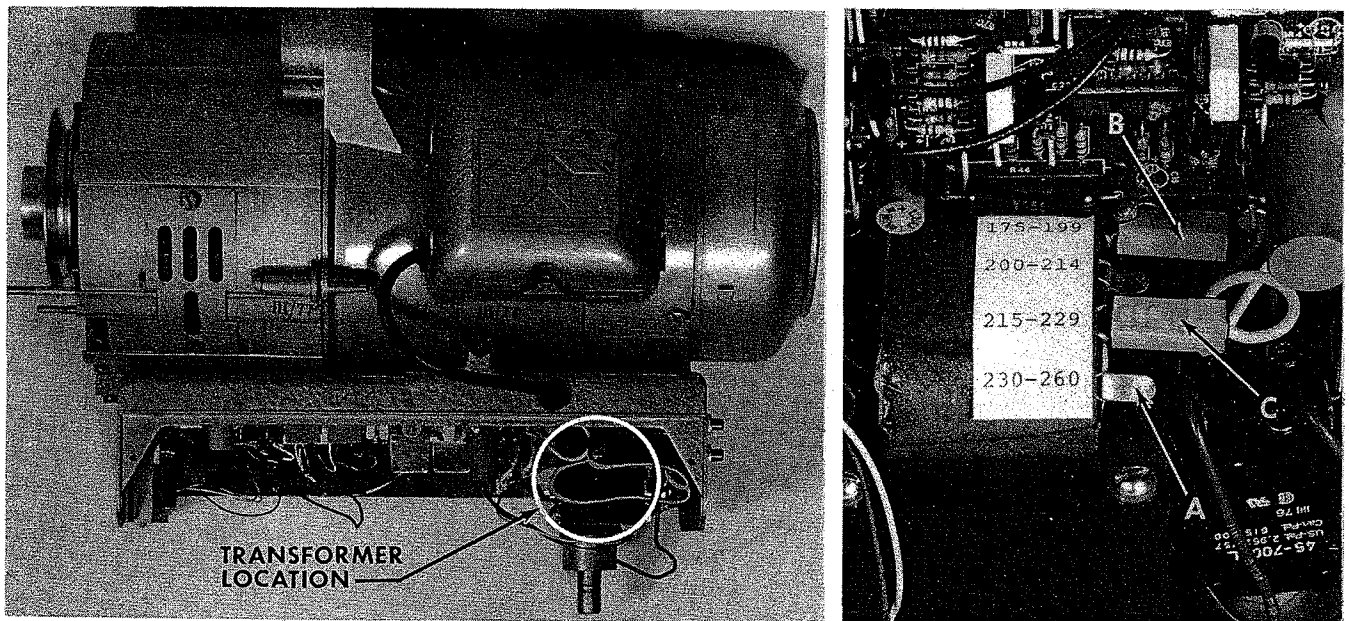

Fig. 33

MACHINE SPEED

The following chart should be used for selecting the correct motor pulley size for the desired machine speed, before proceeding to adjustments described under "POSITIONING RPM'S FOR THREAD TRIMMING".

<u>MACHINE SPEED</u>	<u>60 CYCLE ONLY PULLEY SIZE (U.S. PART NO.)</u>
3900 RPM	28602 AR-21
4100 RPM	28602 AR-22
4300 RPM	28602 AR-23
4700 RPM	28602 AR-25
4900 RPM	28602 AR-26
5200 RPM	28602 AR-28
5600 RPM	28602 AR-30

WORKING FUNCTIONS

Sewing by activating the sewing machine pedal forward from the normal position. Stopping in the first position by heeling the pedal to the neutral position. The second position along with the trimmer and thread wiper is achieved by heeling the pedal.

WORKING FUNCTIONS (Continued)

CONTROL PANEL

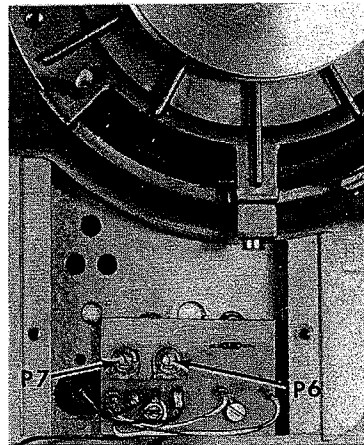
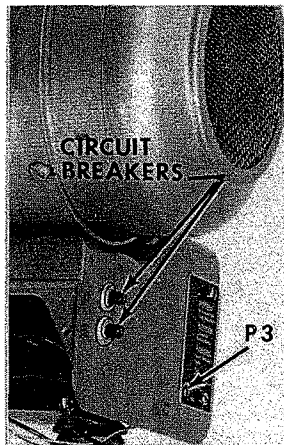
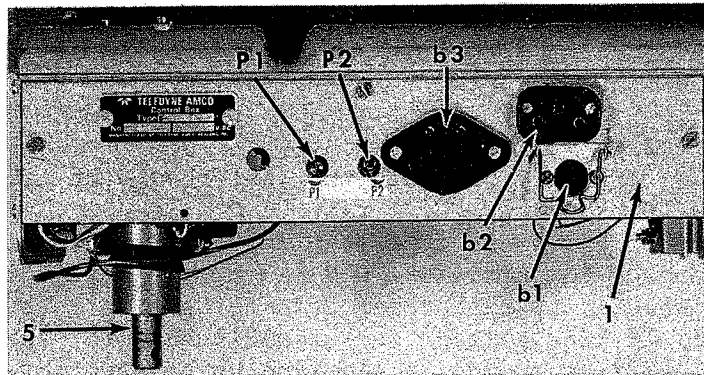

- 1 - Control box
- 5 - Actuating shaft
- b1 - Synchronizer receptacle
- b2 - Clutch and brake
- b3 - Accessory Connections
Thread trimmer 1 & 2
Thread wiper 1 & 3
Foot lift 9 & 10
24 vdc, 0.5A 6 & 10 (10=+)

Fig. 34

- P1 - Potentiometer for setting positioning speed
 - P2 - Potentiometer for setting intermediate speeds
 - P3 - Potentiometer for limiting top speed
 - P6 - Potentiometer for adjusting thread tension release
 - P7 - Potentiometer for adjusting presser foot lift
- Both P6 and P7 are accessible by removing cover on right side of control box.

POSITIONING RPM'S FOR THREAD TRIMMING

Independent of motor rpm or pulley diameter, adjustable via potentiometer P1 (Fig. 34) should be adjusted to 200 RPM. Setting beyond this speed will lead to malfunctioning of thread trimmer mechanism.

INTERMEDIATE SPEED RANGES

P2 - Intermediate speeds 2 to 9. These speeds cannot be independently adjusted. They can be either condensed or expanded. P2 turned to the left stop will condense the speeds leaving a larger rpm difference between step 9 and step 10. This should be adjusted according to the sewing requirements.

P3 - Maximum speed limitation. By turning P3 against the left stop, step 10 is reduced to that of step 9. Further adjustment is then controlled by the setting of P2.

NOTE: Maximum speed adjustment is recommended only for exceptional cases such as operator training, not for continued use.

THREAD TENSION RELEASE & PRESSER FOOT LIFT

Adjustment for the length of thread tension release is controlled via potentiometer P6 (Fig. 34). The potentiometer should be set so that the tension discs are open until the trim knife has finished cutting.

Adjustment for the presser foot signal after trimming is controlled via potentiometer P7 (Fig. 34) and should be adjusted so that the foot lifts after the thread wiper has returned to its rest position.

NOTE: This adjustment is only necessary for machines equipped with a pneumatic presser foot lift kit.

INSTALLATION OF SYNCHRONIZER

Attach the synchronizer mounting bracket (63495 R), ground wire, clamp and tubing from tension release solenoid to the back of machine, as shown in Figure 1A. Place rubber grommet over the end of synchronizer mounting bracket. Assemble synchronizer onto the adaptor of handwheel assembly, aligning the slot of front bearing plate over grommet on synchronizer bracket to stabilize same and tighten the two set screws in synchronizer. Tighten screws holding the synchronizer bracket, securely. (Position of the synchronizer on handwheel adaptor is of no importance).

SETTING THE SYNCHRONIZER

NOTE: These settings are made looking from the right end of machine.

NEEDLE-DOWN POSITION

With power off, turn the handwheel in operating direction until hook is at loop taking time, with needle on upstroke. Rotate the needle-down disc (A, Fig. 35) until its opening is centered in the synchronizer head.

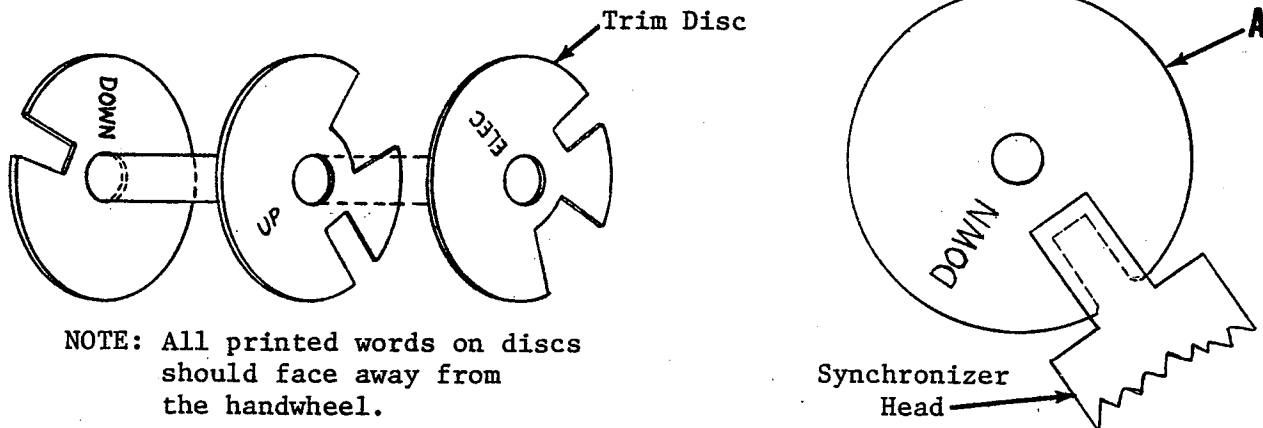

Fig. 35

NEEDLE-UP POSITION

With power off, turn the handwheel in operating direction until thread take-up is 1/8 inch (3.18 mm) before top dead center, OR leading edge of the first screw (A, Fig. 36) in the hook deflector (B) aligns with front edge of positioning finger (C) with needle in the up position. Rotate the needle-up disc (D) until its smaller opening is centered in the synchronizer head.

NEEDLE-UP POSITION (Continued)

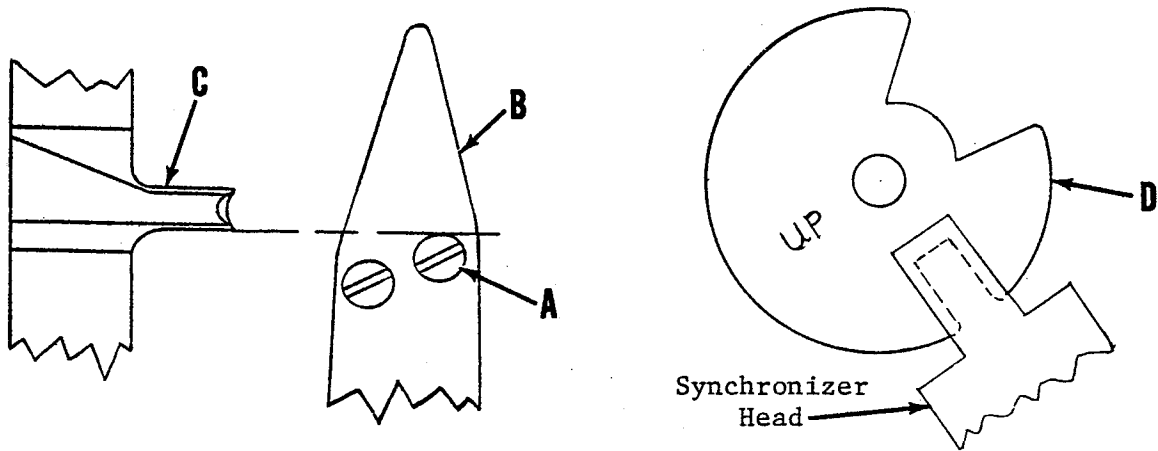

Fig. 36

TRIM

With power off, turn the handwheel in operating direction until tip of finger of the hook thread deflector (A, Fig. 37) is 1/32 inch (.79 mm) to the rear of the rear edge of positioning finger (B), with needle on upstroke. Rotate the trim disc (C) until the trailing edge of its smaller opening coincides with the left corner of the synchronizer head (Fig. 37). Since the "needle-up" and "trim" discs are in constant contact, recheck NEEDLE-UP POSITION.

NOTE: If needle thread tail is not long enough for proper starting, rotate trim disc (C) in a clockwise direction, gradually, until proper tail length is acquired. Recheck NEEDLE-UP POSITION.

CAUTION: If machine is equipped with an electric "Klipp-It" thread trimmer, the trim disc must be marked ELEC

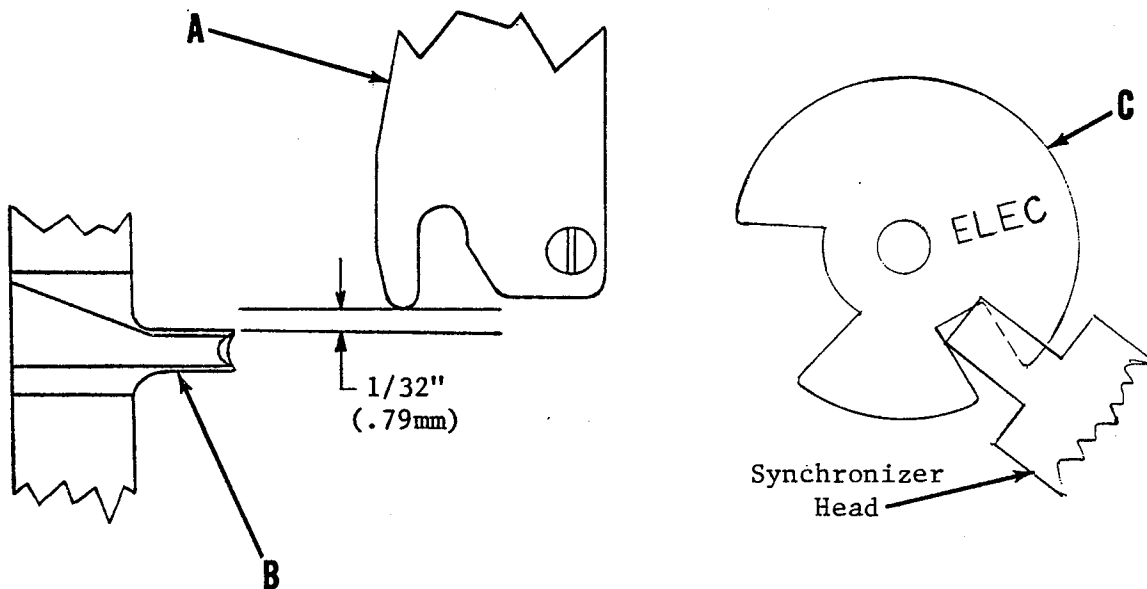
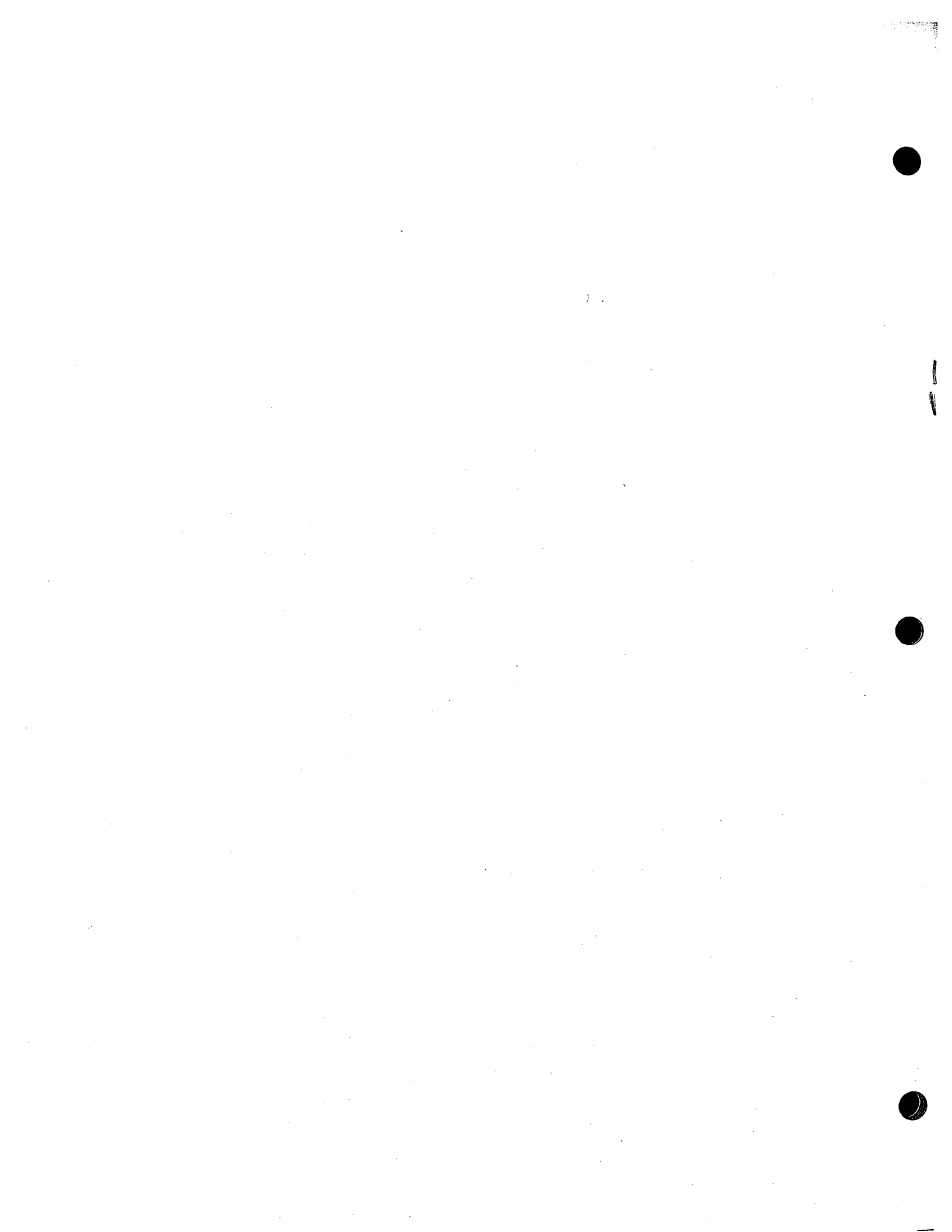

Fig. 37

TRIMMER TROUBLESHOOTING

Condition	Causes	Cures
Both threads not cut	Circuit breakers in control box not open	Reset circuit breakers
	Solenoid not working	Check lead connections Make continuity check
	Lower knife not moving far enough to the right	Reset stop screw
	Lower knife too far forward, wipes threads behind knife	Relocate knife. Check for nicks on radius
	Lower knife too far back, threads slip off when knife returns	Relocate knife
Needle thread not cut, but bobbin thread cut	Spring retainer wire not contacting bobbin case holder when in catching position	Bend spring retainer wire to suit.
	Lower knife does not move far enough to right	Adjust stop screw to standard setting. Check position of solenoid. Operate machine with belt off, to determine if solenoid pivot lever is contacting stop screw and then reposition solenoid if necessary
	Hook No. 29474 R or S used	Use only No. 29474 T hook
Bobbin thread not cut, but needle thread cut	Bobbin thread not threaded thru in bobbin case	Thread properly
	Needle hole in throat plate is too big or has been altered	Use throat plate with smaller needle hole, if available
Lower knife does not return all the way	Not enough tension on lower knife return spring. Dense material and rough thread will require more tension on knife return spring	Increase tension on lower knife return spring by moving bracket to the right
	Lower knife rubbing hook point	Raise lower knife
Needle thread tears and leaves random lengths of starting tail	Too much knife return spring tension and excessive friction in needle thread eyelets and in thread pull-off at cone	Unthread some of the eyelets to the right of the tension post. Decrease tension on knife return spring slightly. Check thread pull-off at cones
	Tension disc not open	Check setting of tension release solenoid and electrical operation of this solenoid
Needle unthreads when starting	Needle thread take-up not positioned properly at top of stroke	Check position of needle thread take-up. Must be within 1/8 inch (3.18 mm) of the top of its upstroke
	Needle hole in throat plate is too big	Use throat plate with smaller needle hole, if available
	Bobbin thread too short	See bobbin thread breaks
Bobbin thread breaks	Overspin on bobbin thread	Check wind of bobbin and fit of bobbin in bobbin case holder
	Too much knife return spring tension	Decrease tension on knife return spring slightly, by moving bracket to the left
	Sharp edges on T.C.S. of lower knife. (Front, point and back edges are the T.C.S. of lower knife)	Stone sharp edges of T.C.S. of lower knife. (Front, point and back edges are the T.C.S. of lower knife)

NOTE: Refer to Amco Variostop Catalog furnished with each needle positioner for guardian maintenance and other information regarding the needle positioner and electrical circuitry.



ADJUSTING INSTRUCTIONS

FOR

QUICK STOP

ELECTRO DRIVE and NEEDLE POSITIONER

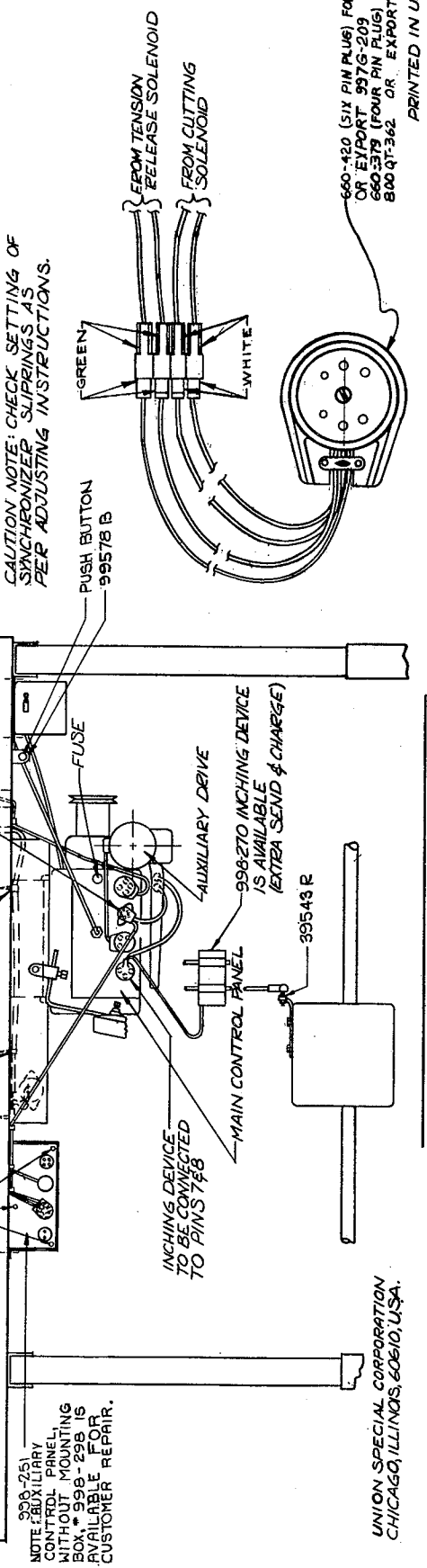
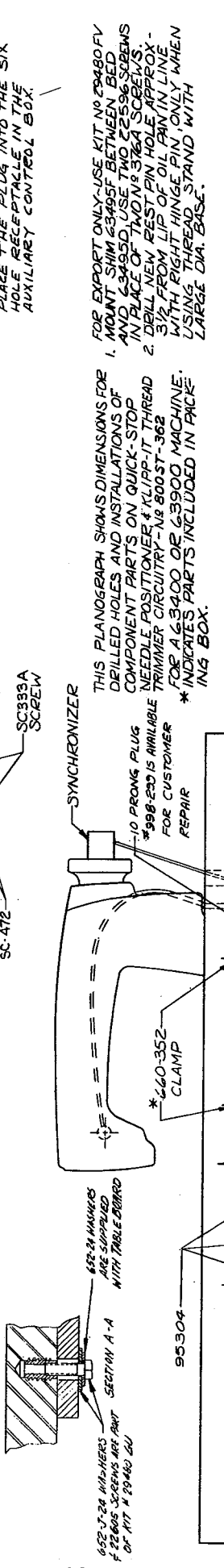
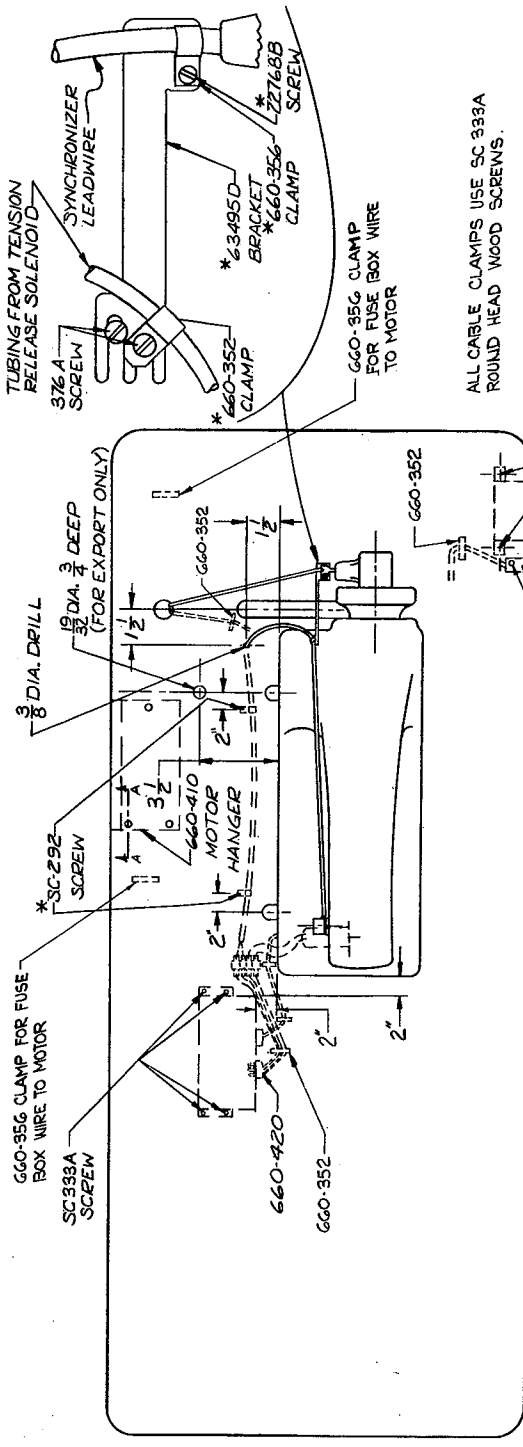

FOR EXPORT ONLY-USE KIT NO 29480 FV MOUNT SHIM #3495F BETWEEN BED AND #3495D. USE TWO #22605 SCREWS IN PLACE OF TWO #16 376 A SCREWS

2. DRILL NEW BEST PIN HOLE APPROX. 3 1/2" FROM TIP OF OIL FLOW IN LINE WITH RIGHT HINGE PIN, ONLY WHEN USING THREAD STAND WITH LARGE DIA. BASE.

660-420 (SIX PIN PLUG) FOR USE ON 800ST-362 OR EXPORT 997G-209 OR 997G-210. 660-378 (FOUR PIN PLUG) FOR USE ON 800QT-362 OR EXPORT 997G-200.

PRINTED IN U.S.A.

Fig. 1B

SYNCHRONIZER ADJUSTMENTS

The synchronizer is composed of three slip rings and four carbon brushes. The hub, band (A, Fig. 38) is fixed on the synchronizer and controls the "cutting mechanism". Band (B) is adjustable by means of screw (C) and controls the "needle-up" position. Band (D) is also adjustable by means of screw (C) and controls the "needle-down" position.

SETTING THE SYNCHRONIZER

Assemble the brush holder and bracket to the machine as shown in Fig. 1B and the synchronizer to the handwheel adapter. Do not tighten screws (E, Fig. 38) in the synchronizer hub, band (A) at this time. Loosen screw (C) so that bands (B and D) may be moved freely.

NOTE: The following settings should be made with the motor switch turned off, needle on the downstroke, with the hook point at 9:00 o'clock.

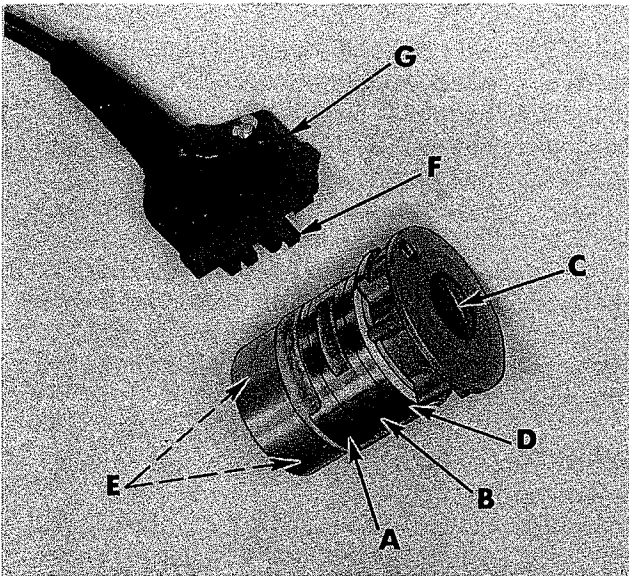

Fig. 38

Figure 39 is provided to show dimensional relationships for setting the bands of the synchronizer. A plastic rule may be used for making these settings as compared to the sketch in Fig. 39. Visualize from the operator's position while seated at the machine, placing the top edge of sketch (Fig. 39) over the top of the bands until contact is made FLUSH with the edge of the brushes (NOT THE BRUSH HOLDER) and proceed as follows:

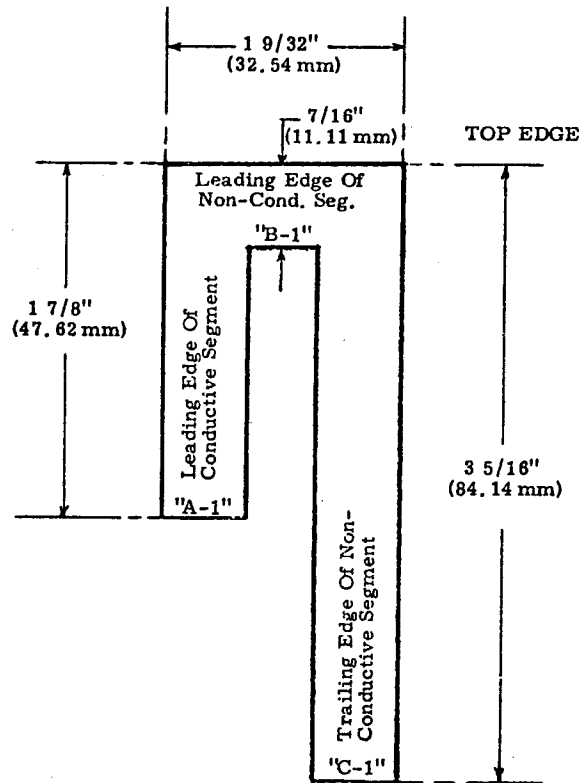

Fig. 39

SETTING THE SYNCHRONIZER (Continued)

Rotate hub, band (A, Fig. 38) of the synchronizer in the operating direction until the LEADING EDGE of its CONDUCTING segment aligns with ("A-1", Fig. 39) $1 \frac{7}{8}$ inches (47.62 mm). Secure the synchronizer to the handwheel adapter in this position by screws (E).

Rotate band (B, Fig. 38) in the operating direction until the LEADING EDGE of its NON-CONDUCTING segment aligns with ("B-1", Fig. 39) $\frac{7}{16}$ inch (11.11 mm). WHILE HOLDING BAND (B) IN THIS POSITION, rotate band (D) in the operating direction until the TRAILING EDGE of its NON-CONDUCTING segment aligns with ("C-1", Fig. 39) $3 \frac{5}{16}$ inches (84.14 mm).

WHILE HOLDING BANDS (B and D) IN THIS POSITION, tighten screw (C) securely.

With bands (A, B and D) set to their respective positions, the relationship between the "cutting mechanism", "needle-up" position and the "needle-down" position has now been acquired.

Each of the settings can be checked as follows:

NEEDLE-DOWN SETTING

With the power off, remove the throat plate and turn the handwheel in the operating direction until the needle has reached its lowest position; continue to turn the handwheel in the operating direction until the hook point has passed the needle by approximately $\frac{5}{64}$ inch (1.98 mm). At this point, the NON-CONDUCTING segment of band (D, Fig. 38) should be on brush (F).

NEEDLE-UP SETTING

With the power off, turn the handwheel in the operating direction until the hook point is at 9:00 o'clock, with needle on its downstroke. At this point, the LEADING EDGE of the NON-CONDUCTING segment of band (B) should have passed the top of the brush holder (G) by approximately $\frac{1}{4}$ inch (6.35 mm).

CLUTCH ADJUSTMENTS

Clutch free play should normally be .020 - .028 inch (.508 - .711 mm), but care must be taken to assure that the clutch is never engaged at any time with the brake. Adjustment can be accomplished by removing spacers as required, located between the motor and the clutch. Two .012 inch (.305 mm) and one .020 inch (.508 mm) spacers have been provided for this purpose.

If the clutch arm is in braking position, the "V" belt pulley must be braked firmly. When lifting the clutch arm, a position at which the "V" belt pulley can be rotated freely without the clutch or brake engaging must be obtained. If the clutch arm is lifted in excess of .010 inch (.254 mm), the clutch disc should engage the flywheel disc, which is clearly recognizable when turning the "V" belt pulley.

INCHING SWITCH

Inching Device No. 998-270 is an extra send and charge item. Refer to Fig. 1B for location and Fig. 40 for wiring connections.

PUSHBUTTON FUNCTION

If the pushbutton, which is mounted on the front edge of the table board, is depressed, the cutter band of the synchronizer is interrupted. Therefore, when the treadle is heeled while the pushbutton is depressed, the needle will position up without trimming. This enables the operator to readjust or realign the garment with the needle out of the work, but without having trimmed the threads.

MOTOR AND CLUTCH ARM ADJUSTMENTS

Before starting to operate, check the main supply voltage with the motor wiring. The terminal strip of the motor is designed to accommodate connection for 200 volts, three phase A.C. See Quick Stop Catalog.

The clutch arm should point in the direction of the pitman rod, when possible. This can be accomplished by loosening the three socket head screws on the motor plate, reposition the clutch arm as required, retighten screws.

CLUTCH AND MICRO SWITCH ADJUSTMENTS

Adjustment of the micro switch, located on the right hand side of the clutch arm, which actuates the magnetic clutch, should be made as follows; with the treadle in "rest position". Turn the set screw (A, Fig. 41) in a clockwise direction until the switch closes and the auxiliary control starts running. Now, turn the set screw in a counterclockwise direction to the position where the auxiliary control stops running. Continue to turn the set screw counterclockwise 1/2 to 1 complete revolution to obtain the correct setting of the switch.

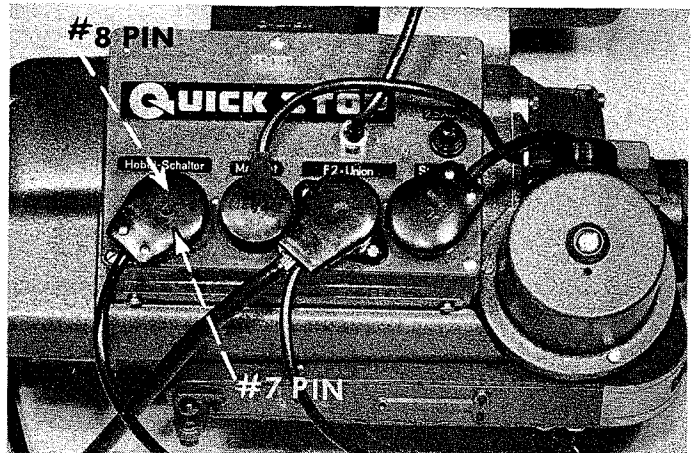
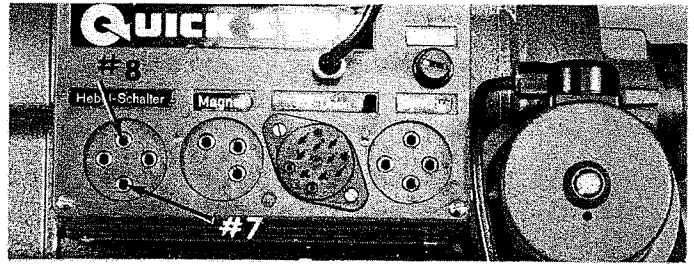

Fig. 40

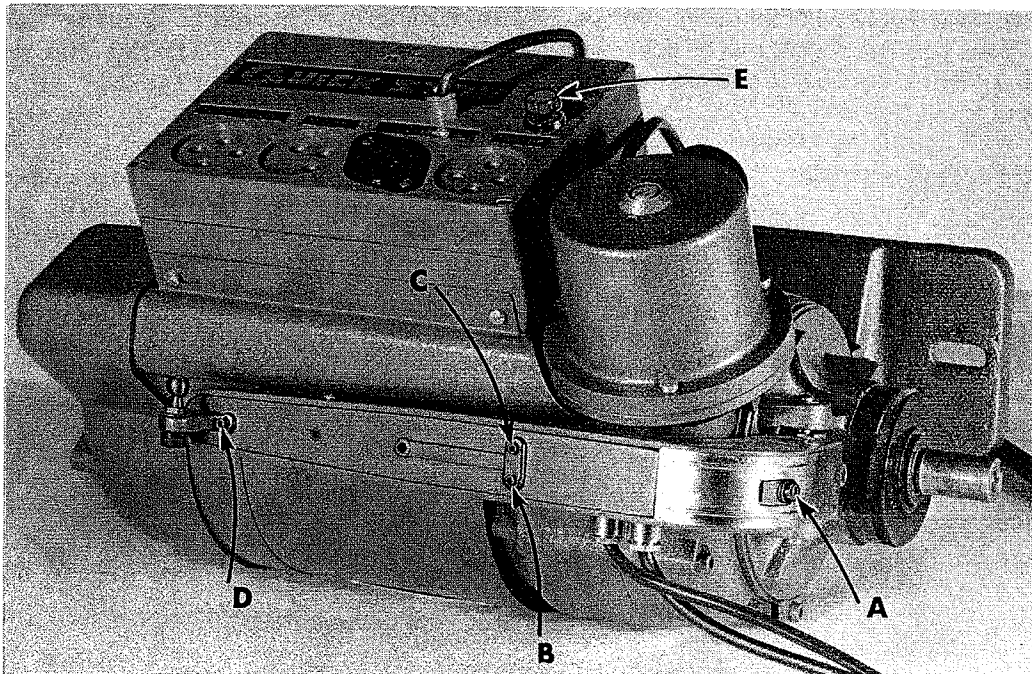

Fig. 41

CLUTCH AND MICRO SWITCH ADJUSTMENTS (Continued)

Adjustment of the micro switch, located to the rear on the underside of the clutch arm, which actuates the up and trim position, should be made as follows:

Be sure that all connections are plugged into the main control panel. Run machine a short distance and stop with treadle in rest position. Needle should position down. Heel treadle and needle should position up and trim.

However, if the needle travels right through the down position to the up and trim position, this indicates micro switch is open. Screw (B, Fig. 41) should be turned clockwise until micro switch is closed when treadle is in rest position.

However, if the needle only positions down and will not position up and trim when treadle is heeled, this indicates micro switch is open. Turn screw (B) counterclockwise to the point where the micro switch is closed when the treadle is in the rest position, and open when the treadle is heeled.

A method for making this unit a one position, positioner (either up or down) is as follows:

If the down only position is desired, turn screw (B, Fig. 41) clockwise until micro switch is closed when treadle is in the rest position.

If the up only position is desired, turn screw (B) counterclockwise until micro switch remains open.

Screw (C, Fig. 41) is for adjustment of the micro switch which activates an automatic presser foot lifting mechanism. This assist is not available at the present time. It should be remembered not to turn this screw all the way in as it will affect the function of screw (B).

Screw (D, Fig. 41) should have only enough tension on the spring to return the treadle to the rest position after it has been heeled.

FUSING THE POWER PACK

This unit incorporates a 2 1/2 AMP, 250 V fuse as a safety feature located at (E, Fig. 41).

SYNCHRONIZER ADJUSTMENT

Position speed should be kept between 180-200 R.P.M. The following chart is set up to give you the correct pulley sizes for 50 and 60 cycle. If 180-200 R.P.M. positioning speed is not maintained, trimmer may not work correctly.

Machine Speed	Cycle	SPEED VS CYCLES	
		Amco Motor Pulley Part Number	Quick Stop Positioning Pulley Part Number for 180-200 R.P.M.
5500	60	634	995-254-37
	50	643	995-254-37
5000	60	632	995-254-42
	50	640	995-254-42
4500	60	630	995-254-46
	50	635	995-254-46
4000	60	626	995-254-50
	50	632	995-254-50
3500	60	623	995-254-61
	50	626	995-254-61

QUICK-STOP TROUBLESHOOTING

NOTE: If difficulties in needle positioning are encountered, check circuitry for the positioner on the motor control panel only.

Condition	Causes	Cures
Unit does not position	Blown fuse	Replace fuse
	Synchronizer plug not connected	Plug in synchronizer plug into the right socket of main motor control panel
	Synchronizer leads not connected to plug	Check leads continuity between brush holder and plug
Machine stops in up position only with treadle in rest position	Micro switch in clutch arm not opening	Turn the setscrew which is located in the clutch arm to the rear of the motor, in a clockwise direction until the machine stops needle down after sewing.
Machine will not stop after sewing and continues to rotate at inching speed	Microswitch on right side of clutch arm not adjusted properly	Adjust screw on right side of clutch arm in a counterclockwise direction until machine stops, and then make one more turn
	Microswitch defective	Replace microswitch
Unit does not trip but positions up	Defective push button	Replace push button
Solenoids do not energize	Blown fuse in main control panel	Replace fuse
	Synchronizer not adjusted properly	Readjust synchronizer per instructions
	Relay 4 not energizing due to bent contacts	Reshape contacts of Relay 3
Machine stop down only	Microswitch in clutch arm closed at all times. Defective microswitch	Replace microswitch
Unit positioner up and trims and thread pulls out of needle	Tension opening late	Relay 4 is sticking. Replace board
Too much pull lever clearance.	Ball head screw of the pull lever worn out, or bore of the sliding sleeve sluggish.	Renew ball head screw or turn sliding sleeve around 120 degrees for new bore. Sliding sleeve has 3 bores.

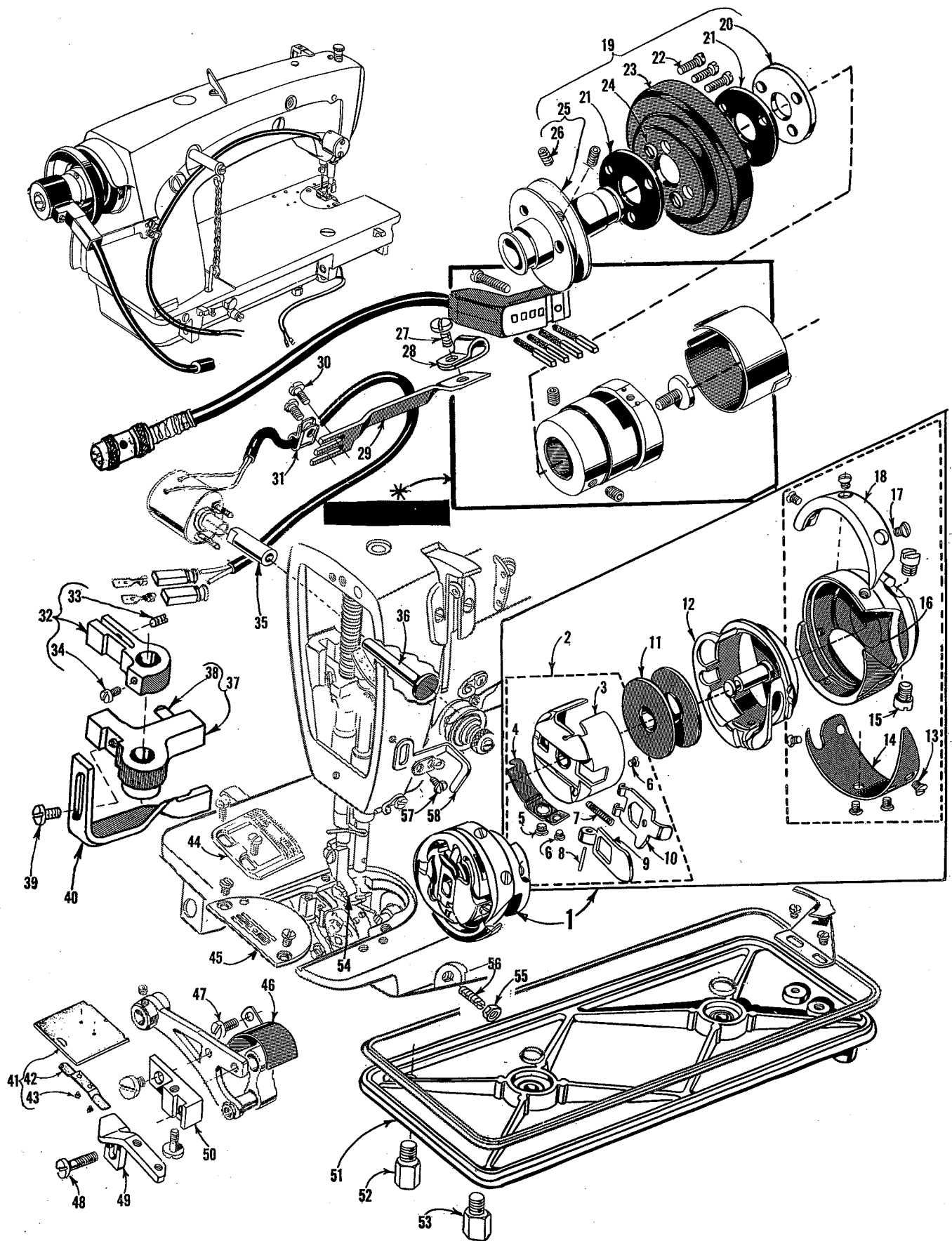

ROTATING HOOK ASSEMBLY, NEEDLE POSITIONER ASSEMBLY,
HANDWHEEL ASSEMBLY AND MISCELLANEOUS PARTS

Ref. No.	Part No.	Description	Amt. Req.
1	29474 T	Rotating Hook Assembly-----	1
2	63913 A	Bobbin Case Assembly-----	1
† -	63913 B	Bobbin Case Assembly-----	1
3	63913	Bobbin Case-----	1
4	61414 C	Bobbin Case Tension Spring-----	1
5	22716 B	Tension Regulating Screw-----	1
6	22564 E	Screw-----	2
7	61216 N	Bobbin Case Latch Spring-----	1
8	61216	Bobbin Case Latch Hinge Pin-----	1
9	61415 A	Bobbin Case Latch Lever-----	1
10	61415	Bobbin Case Latch-----	1
11	61212	Bobbin-----	1
12	63414	Bobbin Case Holder-----	1
13	22716 A	Screw-----	4
14	63410	Hook Thread Deflector-----	1
15	22569 H	Screw-----	2
16	63408	Hook-----	1
17	22716 H	Screw-----	3
18	61411 A	Hook Thread Retainer-----	1
19	63421 A	Handwheel Assembly-----	1
20	61321 L	Retainer Plate-----	1
21	61421 E	Handwheel Isolator-----	2
22	22574 C	Screw-----	3
23	61421 BC	Handwheel-----	1
24	660-254 D	Isolator Washer-----	3
25	63421 C	Pulley-----	1
26	22894 V	Set Screw-----	2
27	J87 J	Screw, for synchronizer lead wire clamp-----	1
28	660-356	Synchronizer Lead Wire Clamp-----	1
29	63495 D	Synchronizer Bracket-----	1
30	376 A	Screw, for synchronizer bracket-----	2
31	660-352	Tension Release Solenoid Lead Clamp-----	3
32	63459 A	Presser Bar Guide-----	1
33	73 C	Set Screw-----	1
34	22570	Screw-----	1
35	63492 E	Bushing, for tension release plunger pin-----	1
36	63492 D	Tension Release Plunger Pin-----	1
37	63458 B	Tension Release Bushing and Guide-----	1
38	660-219 B	Roll Pin-----	1
39	22513	Screw-----	1
40	63458 D	Tension Release Cam-----	1
41	63402 B	Bed Slide-----	1
42	61273	Bed Slide Spring-----	1
43	91 A	Screw-----	2
44		Feed Dog (See Pages 33 and 35)-----	1
45		Throat Plate (See Pages 33 and 35)-----	1
46	63432 E	Oil Shield-----	1
47	18-768	Drive Screw-----	1
48	22874 J	Screw, for feed dog holder and feed dog holder support-----	2
49	63439 A	Feed Dog Holder-----	1
50	63439 B	Feed Dog Holder Support-----	1
51	63982 C	Oil Reservoir Cover-----	1
52	22571 G	Plug Screw-----	1
53	22841 K	Stud Screw-----	1
54		Presser Foot (See Page 37)-----	1
55	41071 G	Nut-----	1
56	HS82	Screw-----	1
57	22766	Screw-----	1
58	63970 A	Needle Thread Pull-up Bracket-----	1
*	800 XT-362	Needle Positioner Assembly, complete, although only the synchronizer is shown-----	1
*	800 YP-362	Needle Positioner Assembly, complete, (not shown)-----	1

* Refer to insert sheet with needle positioner for repair parts and order under the Union Special number, if available. Also refer to insert sheet for guardian maintenance and other information regarding the needle positioner and electrical circuitry.

† Available as an extra send and charge item, component parts are the same as 63913 A except for one each Nos. G22564 F, G22716 B, G61414 C and two No. G22564 E.

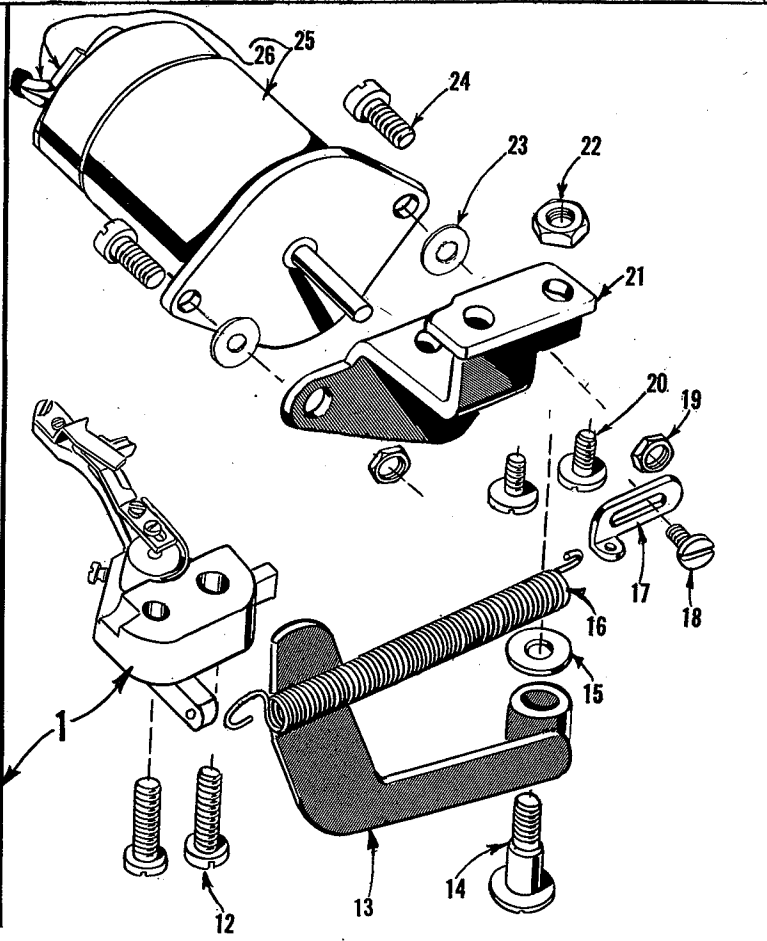
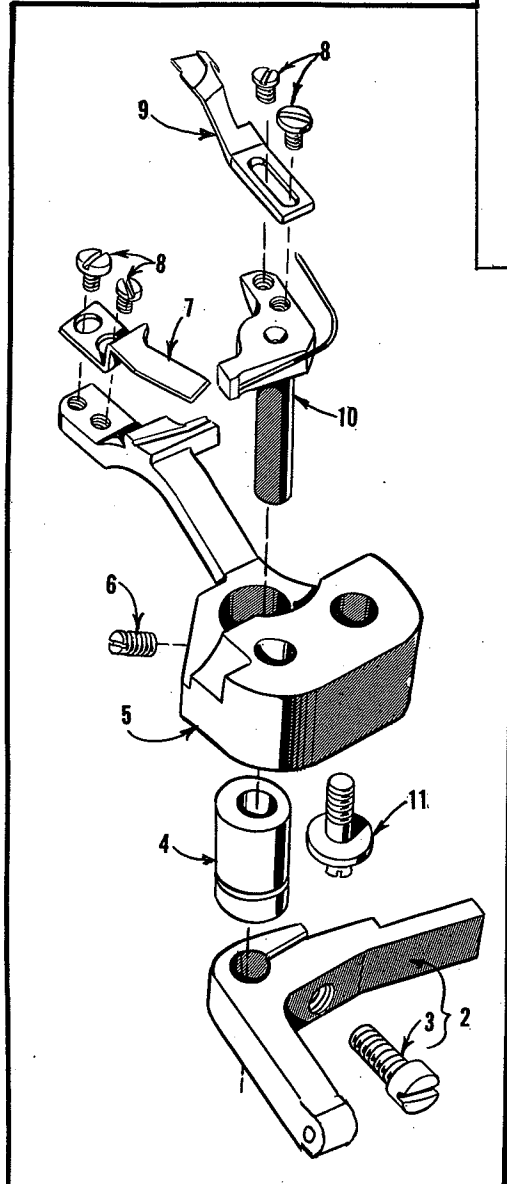
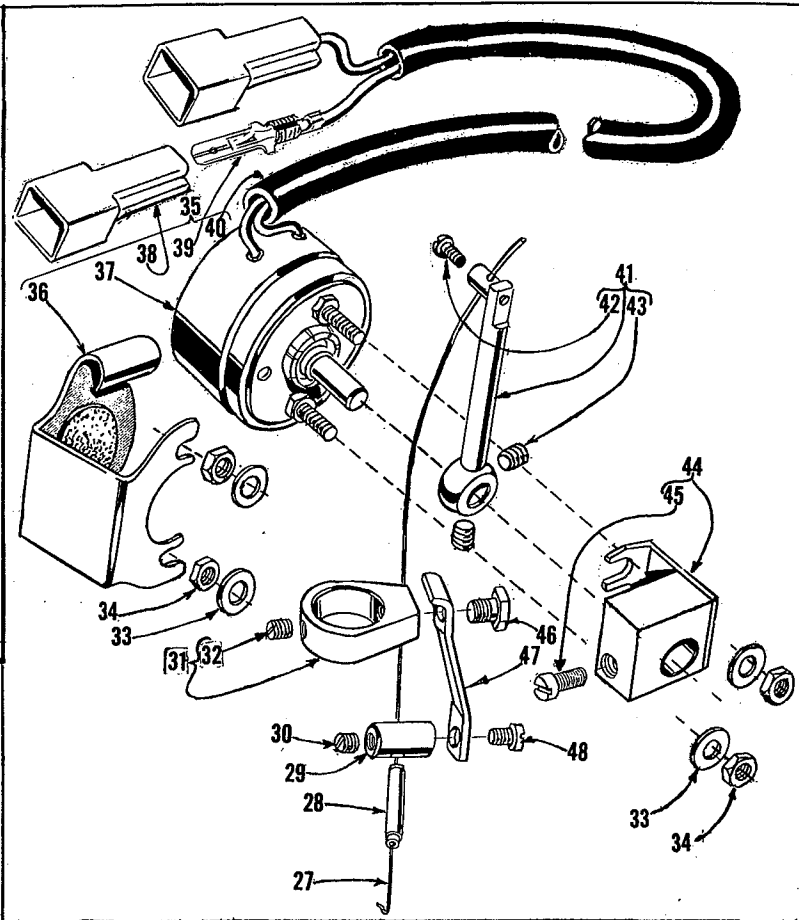
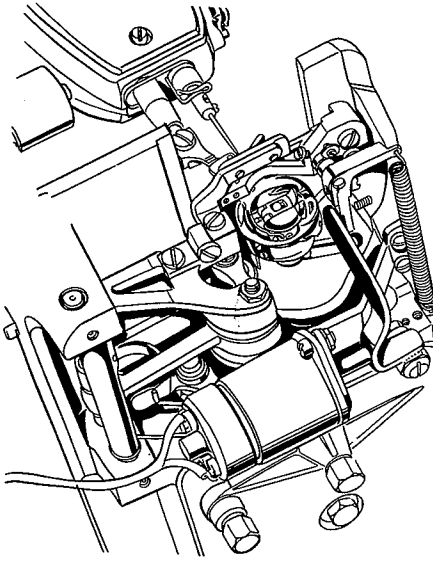

THREAD WIPER, CUTTING SOLENOID, TENSION RELEASE
SOLENOID, MOUNTING BRACKET, BOBBIN CASE HOLDER
POSITIONING FINGER AND KNIFE ASSEMBLY

Ref. No.	Part No.	Description	Amt. Req.
1	29475 BG	Bobbin Case Holder Positioning Finger and Knife Assembly-----	1
2	63495 C	Pivot Release Lever-----	1
3	22585 R	Screw-----	1
4	G61441 KX	Eccentric Bushing-----	1
5	G61414 KX	Positioning Finger, marked "A"-----	1
6	77	Screw-----	1
7	G61470 KX	Upper Knife, marked "GB"-----	1
8	73 A	Screw, for knives-----	4
9	G61449 KX	Lower Knife and Thread Holder, marked "GA"-----	1
10	63450	Lower Knife Carrier, marked "D"-----	1
11	22863 B	Screw, for adjusting eccentric bushing-----	1
12	22874	Screw, for positioning finger and knife assembly-----	2
13	63495 G	Cutting Solenoid Lever-----	1
14	22777 C	Screw, for cutting solenoid lever-----	1
15	61434 G	Washer-----	1
16	63495 B	Knife Return Spring-----	1
17	63495 E	Return Spring Positioner-----	1
18	22585 A	Screw, for return spring positioner-----	1
19	12982	Nut-----	2
20	22585 B	Screw, for cutting solenoid mounting bracket-----	2
21	63495 H	Mounting Bracket, for cutting solenoid-----	1
22	18	Nut, for cutting solenoid lever screw-----	1
23	61434 G	Washer, for Style 63400 KB only-----	1
24	22517	Screw, for cutting solenoid-----	2
25	660-354	Cutting Solenoid-----	1
26	670 E-8	Hook-up Wire, for cutting solenoid-----	2
27	63470 F	Thread Wiper Wire-----	1
28	63470 P	Needle Thread Wiper Guide-----	1
29	63470 N	Needle Thread Wiper Guide Holder-----	1
30	22743	Set Screw-----	1
31	63470 H	Thread Wiper Mounting Collar-----	1
32	22743	Set Screw-----	1
33	660-113	Washer, brass-----	4
34	651 J-12	Nut-----	4
35	29480 FM	Rotary Tension Release Solenoid Assembly-----	1
36	63458 H	Rotary Solenoid Cover-----	1
37	660-360	Rotary Solenoid-----	1
38	670 G-18	Female Connector Sleeve, green-----	2
39	670 G-23	Male Wire Terminal-----	2
40	660-347	Solenoid Lead Cover-----	1
41	63470 E	Thread Wiper Lever-----	1
42	22738	Screw-----	1
43	22894 Y	Set Screw-----	2
44	63470 T	Thread Wiper Solenoid Mounting Bracket-----	1
45	22596 D	Set Screw-----	1
46	79048	Screw-----	1
47	63470 G	Needle Thread Wiper Bracket-----	1
48	22513	Screw-----	1

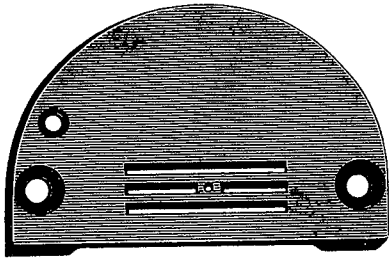

61224 C
Specify Diameter
of Needle Hole

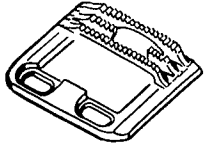

63405 K

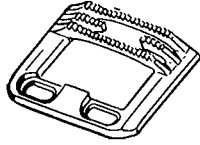

63405 G

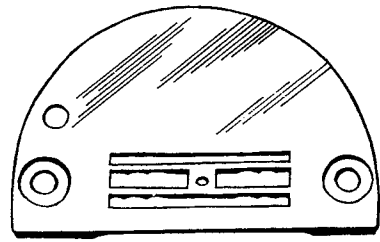

61224 F
Specify Diameter
of Needle Hole

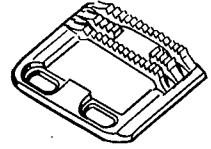

63405 E

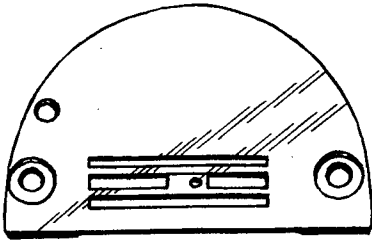

61424 Y
Specify Diameter
of Needle Hole

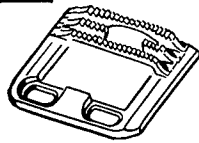

63405 D

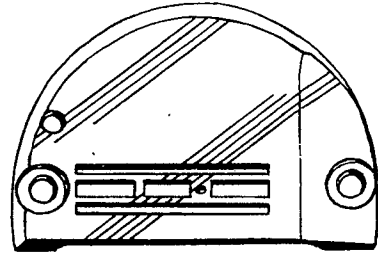

61424 AB
Specify Diameter
of Needle Hole

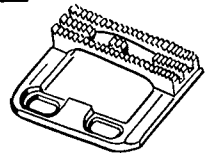

63405 F

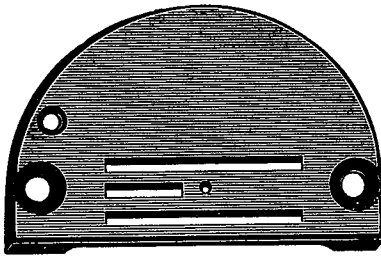

61324 A
Specify Diameter
of Needle Hole

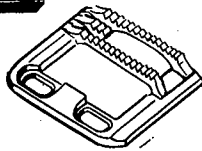

63405 M

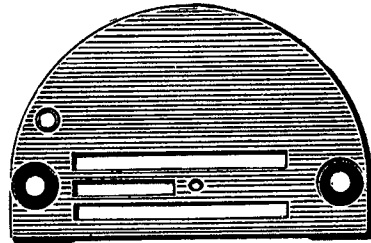

61324 C
Specify Diameter
of Needle Hole

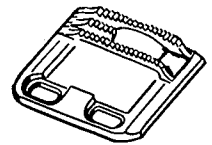

63405 N

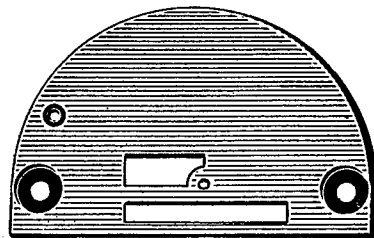

61324 B
Specify Diameter
of Needle Hole

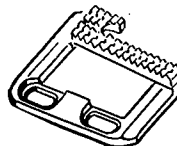

63405 J

THROAT PLATE AND FEED DOG COMBINATIONS

<u>Part No.</u>	<u>Description</u>
61224 C-043	With .043 inch (1.09 mm) needle hole, for seaming and hemming silk and rayon; .063 inch (1.59 mm) needle hole, for seaming dresses; also in sizes .073 and .083 inch (1.85 and 2.11 mm) needle holes, for seaming work shirts and dress pants; feed dog Nos. 63405 G, 63405 K; presser feet Nos. 61220 C, 61220 J, 61320 AB, .085 inch (2.11 mm) thick. Stitch Range 6 to 18 S.P.I.
61224 F-063	With .063 inch (1.59 mm) needle hole, for setting pockets of dress shirts, also in sizes .083 and .093 inch (2.11 and 2.36 mm) needle holes, for work shirts; feed dog No. 63405 E, presser feet Nos. 61320 AH, 61320 AJ, .085 inch (2.16 mm) thick. Stitch Range 6 to 18 S.P.I.
61324 A-063	With .063 inch (1.59 mm) needle hole, for miscellaneous operations on pants, dungarees and overalls; also in size .093 inch (2.36 mm) needle hole; feed dog No. 63405 M; presser foot No. 61220 P, .125 inch (3.18 mm) thick. Stitch Range 6 to 18 S.P.I.
61324 B-063	With .063 inch (1.59 mm) needle hole, for edge stitching on suit coats and vests; also in sizes .073, .083 and .093 inch (1.85, 2.11 and 2.36 mm) needle holes; feed dog No. 63405 J; presser foot No. 61320, .085 inch (2.16 mm) thick. Stitch Range 6 to 18 S.P.I.
61324 C-083	With .083 inch (2.11 mm) needle hole, for hemming work pants; also in size .093 inch (2.36 mm) needle hole, for hemming high back overall suspenders; feed dog No. 63405 N; presser foot No. 61320 C, .125 inch (3.18 mm) thick. Stitch Range 6 to 18 S.P.I.
61424 Y-053	With .053 inch (1.37 mm) needle hole, for seaming and hemming shirts; also in sizes .063 and .073 inch (1.59 and 1.85 mm) needle holes; feed dog No. 63405 D; presser foot No. 61220 J, .085 inch (2.16 mm) thick. Stitch Range 7 1/2 to 18 S.P.I.
61424 AB-053	With .053 inch (1.37 mm) needle hole, for miscellaneous seaming operations on medium weight wash and wear materials; also in size .063 inch (1.59 mm) needle hole; feed dog No. 63405 F; presser foot No. 61420 BV, .125 inch (3.18 mm) thick. Stitch Range 7 1/2 to 18 S.P.I.
63405 D	Marked "JB", teeth cut 22 per inch (1.15 mm per tooth), for seaming and hemming shirts; throat plate No. 61424 Y-053; presser foot No. 61220 J.
63405 E	Marked "HX", teeth cut 16 per inch (1.59 mm per tooth), for setting pockets on shirts; throat plate No. 61224 F-063; presser feet Nos. 61320 AH, 61320 AJ.
63405 F	Marked "CU", teeth cut 22 per inch (1.15 mm per tooth), for miscellaneous seaming operations on medium weight wash and wear materials; throat plate No. 61424 AB-053; presser foot No. 61420 BV.
63405 G	Marked "HW", teeth cut 22 per inch (1.15 mm per tooth), for plain seaming and hemming on dress shirts, blouses, dresses and other light material; throat plate No. 61224 C-043; presser feet Nos. 61220 C, 61220 J, 61320 AB.
63405 J	Marked "CW", teeth cut 16 per inch (1.59 mm per tooth), for edge stitching on suit coats and vests; throat plate No. 61324 B-063; presser foot No. 61320.
63405 K	Marked "HU", teeth cut 16 per inch (1.59 mm per tooth), for plain seaming on work shirts, dress and semi-dress pants; throat plate No. 61224 C-073, presser feet Nos. 61220 C, 61220 J, 61320 AB.
63405 M	Marked "HY", teeth cut 14 per inch (1.81 mm per tooth), for miscellaneous operations on work pants, dungarees and overalls, throat plate No. 61324 A-063; presser foot No. 61220 P.
63405 N	Marked "HZ", teeth cut 14 per inch (1.81 mm per tooth), for hemming high back overall suspenders; throat plate No. 61324 C-083; presser foot No. 61320 C.

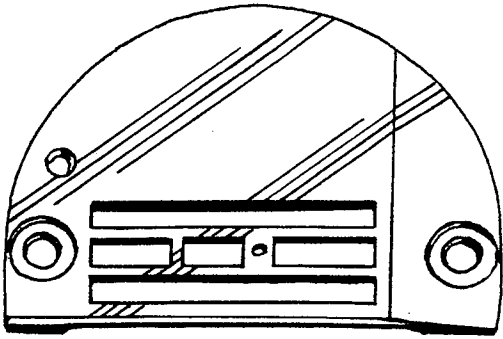

61424 AA-063
Specify Diameter
of Needle Hole

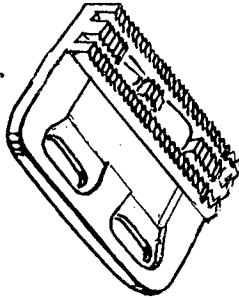

63405 AA

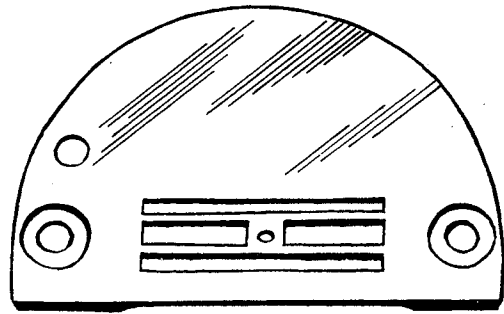

61424 AT-053

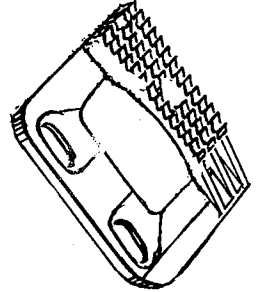

63405 V

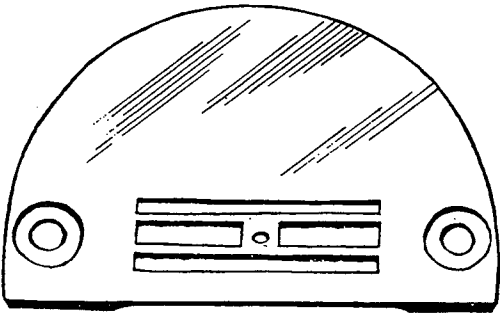

61324 L-093

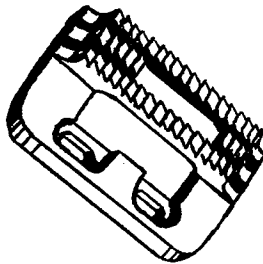

63405 AC

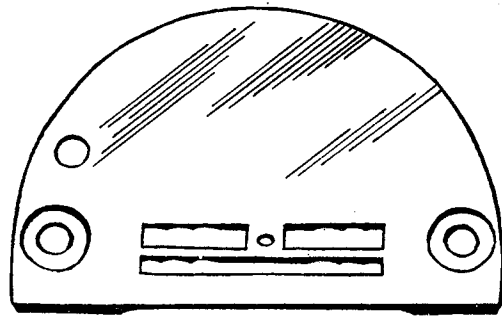

61424 AU-053

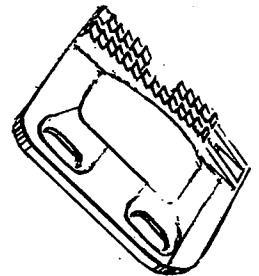

63405 W

THROAT PLATE AND FEED DOG COMBINATIONS

<u>Part No.</u>	<u>Descriptions</u>
61324 L-093	With .093 inch (2.36 mm) needle hole, for seaming heavy coats and trousers, also in size .063 inch (1.59 mm) needle hole; feed dog No. 63405 AC, presser foot No. 61320 S, .085 inch (2.16 mm) thick. Stitch Range 6 to 18 S.P.I.
61424 AA-063	With .063 inch (1.59 mm) needle hole, for miscellaneous seaming operations on medium weight wash and wear materials, also in size .053 inch (1.37 mm) needle hole; feed dog No. 63405 AA, presser foot No. 61420 BU, .125 inch (3.18 mm) thick. Stitch Range 9 to 18 S.P.I.
61424 AT-053	With .053 inch (1.37 mm) needle hole, for top stitching collars made of wash and wear material; feed dog No. 63405 V, presser foot No. 61420 CN, .085 inch (2.16 mm) thick. Stitch Range 10 to 18 S.P.I.
61424 AU-053	With .053 inch (1.37 mm) needle hole, for top stitching collars made of wash and wear material; feed dog No. 63405 W, presser foot No. 61420 CP, .085 inch (2.16 mm) thick. Stitch Range 11 to 18 S.P.I.
63405 V	Marked "EC", teeth cut 22 per inch (1.15 mm per tooth), for top stitching collars made of wash and wear material; throat plate No. 61424 AT-053, presser foot No. 61420 CN.
63405 W	Marked "ED", teeth cut 22 per inch (1.15 mm per tooth), for top stitching collars made of wash and wear material; throat plate No. 61424 AU-053, presser foot No. 61420 CP.
63405 AA	Marked "ET", teeth cut 22 per inch (1.15 mm per tooth), for miscellaneous seaming operations on medium weight wash and wear materials; throat plate No. 61424 AA-063, presser foot No. 61420 BU.
63405 AC	Marked "PW", teeth cut 12 per inch, (2.13 mm per tooth), for seaming heavy coats and trousers; throat plate No. 61324 L-093, presser foot No. 61320 S.

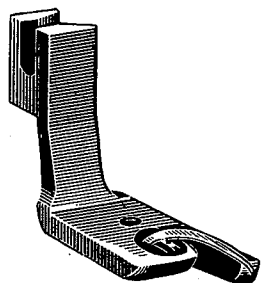

61220 C
Specify Width

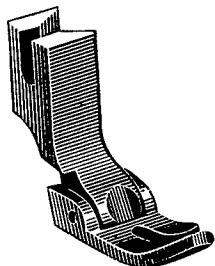

61220 J

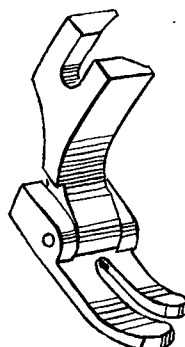

61220 P

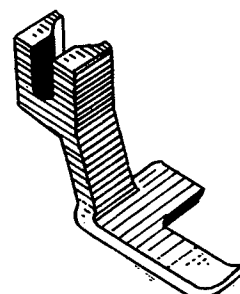

61300

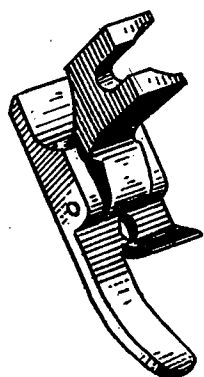

61320 C

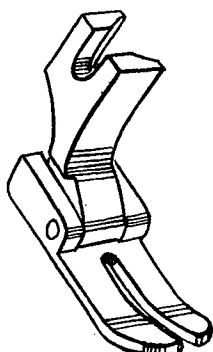

61320 S

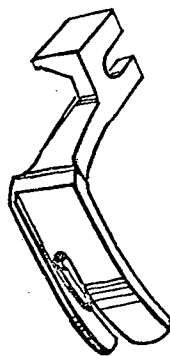

61320 AB

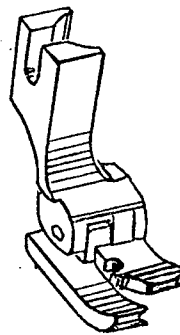

61320 AH

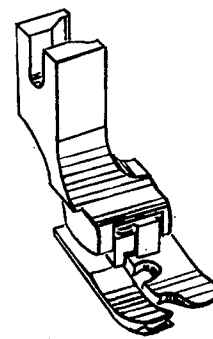

61320 AJ

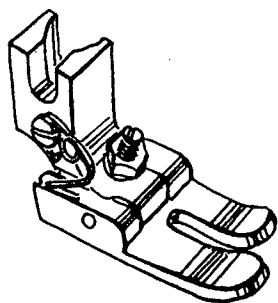

61420 BU

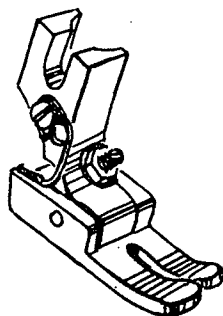

61420 BV

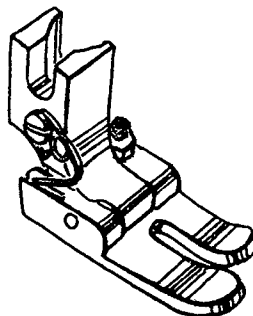

61420 CN

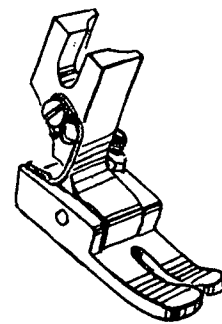

61420 CP

PRESSER FEET

<u>Part No.</u>	<u>Description</u>
61220 C-1/8	For hemming shirts, 1/8 inch (3.18 mm) hem; feed dog Nos. 63405 G, 63405 K; throat plate No. 61224 C-043 (scroll No. 61230-5/32)
61220 C-5/32	For hemming shirts, 5/32 inch (3.97 mm) hem; feed dog Nos. 63405 G, 63405 K; throat plate No. 61224 C-043 (scroll No. 61230-5/32)
61220 C-3/16	For hemming shirts, 3/16 inch (4.76 mm) hem; feed dog Nos. 63405 G, 63405 K; throat plate No. 61224 C-043 (scroll No. 61230-5/32)
61220 C-1/4	For hemming shirts, 1/4 inch (6.35 mm) hem; feed dog Nos. 63405 G, 63405 K; throat plate No. 61224 C-043 (scroll No. 61230-5/32)
61220 J	For seaming light and medium weight woven materials; has spring for raising toe; feed dog Nos. 63405 D, 63405 G, 63405 K; throat plate Nos. 61224 C-043, 61424 Y-053 (spring No. 61230 AK, shank No. 61330, hinge pin No. 61330 B-31, bottom No. 61330 Z)
61220 P	For miscellaneous operations on medium weight materials; has spring for raising toe, feed dog No. 63405 M; throat plate No. 61324 A-063 (spring No. 51930, shank No. 61330, hinge pin No. 61330 B-35, bottom No. 61330 AG)
61320	For edge stitching on suit coats and vests; feed dog No. 63405 J; throat plate No. 61324 B-063
61320 C	For hemming high back overall suspenders; feed dog No. 63405 N; throat plate No. 61324 C-083 (shank No. 61330, bottom No. 61330 C, hinge pin No. 61330 B-39)
61320 S	For seaming heavy coats and trousers; feed dog No. 63405 AC, throat plate No. 61324 L-093 (shank No. 61330, bottom No. 61330 T, hinge pin No. 61330 B-39)
61320 AB	For edge stitching on pants flies, guide 1/16 inch (1.59 mm) to right of needle; feed dog Nos. 63405 G, 63405 K; throat plate No. 61224 C-073
61320 AH	For edge stitching shirt pockets, left side yielding; feed dog No. 63405 E; throat plate No. 61224 F-063 (spring No. 51930, hinge pin No. 61330 B-31, bottom No. 61330 AM, yielding section, left No. 61330 AN, shank No. 61330 AP)
61320 AJ	For edge stitching shirt pockets, left side yielding; feed dog No. 63405 E, throat plate No. 61224 F-063 (spring No. 51930, shank No. 61230 X, hinge pin No. 61330 B-35, bottom No. 61330 AR, yielding section, right No. 61330 AS)
61420 BU	For miscellaneous seaming operations on medium weight wash and wear materials; feed dog No. 63405 AA, throat plate No. 61424 AA-063 (screw No. 226, hinge adjusting screw No. 22565 E, nut No. 51430 F, shank No. 61430 AA, bottom No. 61430 AB, spring No. 61430 BB)
61420 BV	For miscellaneous seaming operations on wash and wear shirts and pants; feed dog No. 63405 F; throat plate No. 61424 AB-053 (screw No. 226, hinge adjusting screw No. 22565 E, nut No. 51430 F, shank No. 61430 AA, bottom No. 61430 AC, spring No. 61430 BB)
61420 CN	For top stitching collars made of wash and wear materials; feed dog No. 63405 V, throat plate No. 61424 AT-053 (screw No. 226, hinge adjusting screw No. 22565 D, nut No. 51430 F, shank No. 61430 CM, bottom No. 61430 CN, spring No. 61430 BB)
61420 CP	For top stitching collars made of wash and wear materials; feed dog No. 63405 W, throat plate No. 61424 AU-053 (screw No. 226, hinge adjusting screw No. 22565 D, nut No. 51430 F, shank No. 61430 CM, bottom No. 61430 CP, spring No. 61430 BB)

Union Special Wants to Help You Cut Sewing Machine Maintenance Costs

Union Special is offering two practical systems to help pinpoint and reduce your sewing machine maintenance costs: a record keeping system to help spot machines requiring abnormally high maintenance, and a parts inventory system to speed routine repairs.

Machine Maintenance Records

Repair-prone machines or inexperienced competent operators can eat up your maintenance dollars in short order. To help spot these problems, Union Special suggests two variations of a simple maintenance record keeping system using cards provided by Union Special.

The first system utilizes a "Machine Maintenance Record" card (Form 237) for each sewing machine in a plant. When a repair is required, the card is pulled from the file and the repair date, parts used, and their cost are entered in the spaces provided and the card is refiled.

**FORM 237—
Machine Maintenance
Record card**

The second system is normally used when more detailed information on repair costs is desired. Two record cards are used: a "Repair Request Card" (Form 234), and a "Machine Repair Record" (Form 233). When a machine requires service, the forelady or foreman fills out the top of a "Repair Request Card" and gives it to a mechanic. He fills in the time the repair work is started, the parts used and their cost,

and the completion time. This data is then transferred to the permanent "Machine Repair Record" kept in the office.

Whichever system is used, management now has an invaluable tool to reduce needless maintenance costs.

Repair Part Inventories

While record keeping tells management which machines require abnormally high maintenance, it does little to help reduce the downtime caused by routine repairs. To alleviate this situation, Union Special recommends that manufacturers establish a formal parts inventory system for each type of sewing machine they operate.

Excessive machine downtime and wasted hours by mechanics can be eliminated with an orderly in-plant inventory of the most commonly needed parts. There is no longer a need to cannibalize other machines for spare parts. Long waits for deliveries are avoided and machine downtime is kept to a minimum. The cost of a parts inventory is small when the overall savings are considered.

**FORM 233—
Machine Repair Record card**

**FORM 234—
Repair Request Card**

For free sample copies of the machine record cards and spare part inventory lists for a variety of the most popular machines, contact your local Union Special Representative or write direct to Union Special.

Union Special

Style 63400 KB

Suggested Minimum Spare Parts List

Part Number	Description	Minimum Quantity Per 5 Machines	Part Number	Description	Minimum Quantity Per 5 Machines
61220 J	Presser foot (depending on operation)	1	29486 L	Take up lever and needle bar link assembly	1
22775	Presser foot attaching screw	2	22562 B	Needle bar clamp screw	2
22768	Feed dog screws	2	29475 BG	Bobbin case holder positioning finger and knife assembly	1
63405 D	Feed dog (depending on operation)	1	G 61449 KX	Lower knife and thread holder	4
61424 Y	Throat plate (depending on operation)	1	73 A	Knife attaching screws	6
376	Throat plate screws	4	G 61470 KX	Upper knife	4
180 GXS	Needles (specify size)	100	63450 A	Thread retaining wire for knife carrier	4
22874 J	Feed dog holder screw	4	29480 FM	Rotary tension release solenoid assembly	1
29474 T	Sewing hook assembly	1	660-360	Rotary solenoid	1
61212	Bobbin	2	63470 F	Thread wiper wire	2
63913 A	Bobbin case assembly	1	22513	Screw for wiper bracket	4
61414 C	Bobbin case tension spring	2	63492	Tension post eyelet	1
22716 B	Tension spring regulating screw	6	660-367	Spring and brush	1
22564 E	Tension spring attaching screw	4	22775 A	Screw	1
63414	Bobbin case holder	1	61411 A	Hook thread retainer	1
22716 H	Hook thread retaining screw	4	29484	Screw assortment	1
61210 B	Hook thread deflector	1			
22716 A	Screws for hook thread deflector	6			
90	Screw for upper thread eyelets	2			
63453	Check spring	2			
22768 A	Needle screw	4			
Optional Parts					
	63913-B	Magnetic bobbin case assembly			1
	G 61414-C	Bobbin case tension spring			2
	G 22716-B	Tension spring regulating screw			2
	G 22564-F	Tension spring attaching screw			2

*The parts and quantities listed above are intended to assist you in setting up the initial inventory of spare parts. An efficient inventory can only be established according to actual usage. The nature of the sewing operation will determine actual usage.

Helpful, authoritative information on the most efficient types of equipment for making virtually any machine sewed article is available from Union Special Sales Promotion Department. Among the many interesting, illustrated bulletins that are available without obligation are the following:

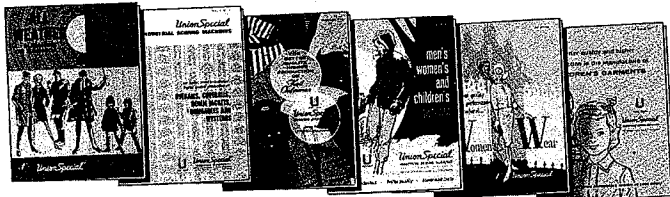

- No. 240, "Men's, Women's, Children's Footwear"
- No. 249, "Rainwear"
- No. 250, "Men's Dress Shirts"
- No. 251, "Service Shirts and Pants"
- No. 252, "Men's Shorts and Pajamas"
- No. 253, "Overalls, Coveralls, and Dungarees"
- No. 254, "Men's Knit Underwear"
- No. 256, "Knit Outerwear"
- No. 259, "Men's Sports Shirts"
- No. 260, "Work Gloves"
- No. 262, "Cotton, Burlap, Jute, and Multiwall Paper Bags"
- No. 263, "Men's Clothing"
- No. 264, "Men's Women's, Children's Jackets"
- No. 265, "Women's Wear"
- No. 266, "Women's Wear And High Fashion"
- No. 267, "Corsets, Girdles, Brassieres"
- No. 268, "Children's Wear"
- No. 269, "Mattresses, Slip Covers, Furniture Upholstery"
- No. 271, "Awnings, Canopies, Tents, Tarps"
- No. 273, "Curtains & Drapes"
- No. 610, "Klipp-it"
- No. 710, "MCS ForMation Unit"
- No. 730, "MCS Automatic Dual Underfront Shirt Hemmer"
- No. 740, "MCS Automatic Rib-Knit Cuff Machine"
- No. 750, "Fusing Presses"
- No. 1100, "Lewis Blindstitch, Chainstitch, Lockstitch, Machines"
- No. 1105, "Button Sewers—Ticket Tackers"
"Columbia Blindstitch, Saddle Stitch, and Tie Closing Machines"
- No. 1500, "Alteration Department Machines"

**HERE ARE HELPFUL
BULLETINS and CATALOGS
TO HELP YOU SOLVE
SEWING PROBLEMS**



**UNION SPECIAL
CORPORATION**



Union Special[®]
INDUSTRIAL SEWING MACHINES

UNION SPECIAL maintains sales and service facilities throughout the world. These offices will aid you in the selection of the right sewing equipment for your particular operation. Union Special representatives and service men are factory trained and are able to serve your needs promptly and efficiently. Whatever your location, there is a Union Special Representative to serve you. Check with him today.

ATLANTA, GA.

BOSTON, MASS.

CHICAGO, ILL.

DALLAS, TEXAS

LOS ANGELES, CAL.

NEW YORK, N. Y.

PHILADELPHIA, PA.

MONTREAL, CANADA

TORONTO, CANADA

BRUSSELS, BELGIUM

LEICESTER, ENGLAND

LONDON, ENGLAND

PARIS, FRANCE

STUTT GART, GERMANY

Representatives and distributors in all important industrial cities throughout the world.

UNION SPECIAL CORPORATION