

Form 8654
(520)
Printed in U.S.A.

LIST OF PARTS

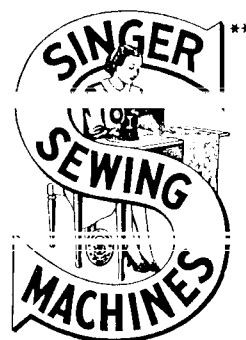

SINGER^{**} MACHINES

Nos. 114-3 and 114-4

THE SINGER MANUFACTURING COMPANY

**A Trade Mark of THE SINGER MANUFACTURING COMPANY

INSTRUCTIONS FOR OILING

To ensure easy running and prevent unnecessary wear of the parts which are in movable contact, the machine requires oiling and when in continuous use, "TYPE B" or "TYPE D" OIL, sold by Singer Sewing Machine Company, should be applied at least twice each day to all oil holes marked "OIL".

"TYPE D" OIL should be used when an oil is desired which will produce a minimum of stain on fabrics, even after a long period of storage.

INDEX

	PAGE
ACCESSORIES.....	18
MACHINE No. 114-3.....	7
" " 114-4.....	18
NUMERICAL LIST OF PARTS.....	23
OBSOLETE PARTS.....	21
PROTECTOR.....	19
STARTING LEVER AND FOOT LIFTER PARTS.....	20
TABLE BELT GUIDE.....	20
THREAD UNWINDER.....	20

INSTRUCTIONS FOR ORDERING

In ordering from this list, use **ONLY** the part NUMBER in the **FIRST** column.

The number stamped on a Sewing Machine part is in every case the number of the single part only.

Every combination of parts sent out as such has its specific number, which, although not stamped on the parts, must be used when ordering the combination.

Each number always indicates the **SAME PART** in whatever list it appears, or for whatever machine.

The letters after some of the numbers indicate the style of finish only, as follows:

- A. Hardened, Polished and Plated.
- B. Polished and Plated
- C. Hardened only.
- D. Polished only.
- E. Soft, not Polished.
- F. Hardened and Polished.
- G.
- H. Blued
- J. Plated only.
- K. Hardened and Plated.
- L. Brass or Gilt.
- M. Oxidized.
- P. Japanned.
- R. Parkerized.

These letters **MUST BE USED** when they appear in the list, and **AFTER** the number *as* in the list.

In this series

1 to 1500 and 50001 to 51500 are Screw Numbers.

1501 to 1800 are Nut Numbers.

1801 to 2000 are Roller Numbers.

2001 to 50000 and 52001 and upward are numbers of Machine Parts.

The figures in the second column refer only to the plates, illustrating the parts, and are **NOT TO BE USED** in ordering.

Parts marked with an asterisk (*) are furnished only when repairs are made at factory.

SINGER Needles should be used
in SINGER Machines
These Needles and their Containers
are marked with the
Company's Trade Mark **SINGER**. 1

Needles in Containers marked
"FOR SINGER MACHINES"
are **NOT SINGER** made needles. 2

LIST OF PARTS COMPLETE

FOR

MACHINE No. 114-3

FOR SEWING TWO OR FOUR-HOLE BUTTONS ON SHIRTS, WAISTS AND UNDERWEAR. SMALL BUTTONS ONLY. MAKES TWO PARALLEL BARS IN FOUR-HOLE BUTTONS. MAKES FOURTEEN STITCHES INCLUDING THE FASTENING STITCHES.

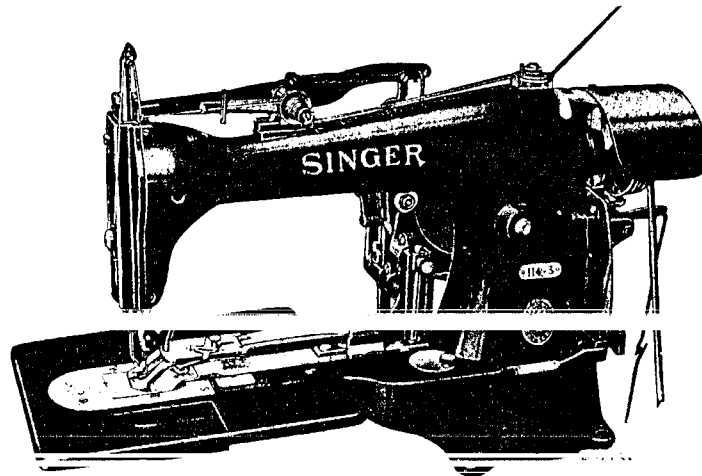

MACHINE No. 114-3

NO.	PLATE	NAME
*59701	—	Arm with 4449, 59767 and two 164E....
16532	6976	" Dowel Pin.....
4448	6976	" Oil Tube, for intermediate bearing..
56015	6976	" " " " oiling 59705 and 59706.
880E	6998	" Screw.....
59702	6975	" Shaft (horizontal).....
17703	6981	" " " Bushing (back)...
50333c	6998	" " " " " Ad- justing Screw.....
1036c	6976	Arm Shaft (horizontal) Bushing (back) Adjusting Screw Nut.....
*4449	—	Arm Shaft (horizontal) Bushing (front)...
59703	6976	" " " Gear with two 1036c.....
1036c	6976	Arm Shaft (horizontal) Gear Set Screw...
59704	6976	" " (upright).....
59705	6976	" " " Bushing (lower)....
435c	7015	" " " " " Set Screw.....
59706	6976	Arm Shaft (upright) Bushing (upper)....
448c	6992	" " " " " Set Screw.....
59707	6976	Arm Shaft (upright) Gear (lower) with two 1253c.....
1253c	6976	Arm Shaft (upright) Gear (lower) Set Screw.....
59708	6976	Arm Shaft (upright) Gear (upper) with two 1253c.....
1253c	6976	Arm Shaft (upright) Gear (upper) Set Screw.....
18498	6975	Belt Cover.....
59795	6977	" " Bracket with 184E and 59796.
184E	6998	" " " Screw Stud.....
59796	6988	" " " Stud.....

NO.	PLATE	NAME
217D	6998	Belt Cover Screw.....
39222	6977	" Shifter.....
39223	6976	" " Clamp.....
1255D	6976	" " " Screw.....
39238	3747	Button Clamp (left) with 9311 and 17723
39239	3747	" " (right) with 9311 and 17723.....
39240	3747	Button Clamp Arm with 17714 and 63788
17710	6978	" " " Hinge Plate.....
1176D	6978	" " " " " Screw....
63788	7015	" " " Hook.....
1175E	6978	" " Hinge Screw.....
59710	6979	" " Lifter.....
176D	7009	" " " Screw.....
39241	6978	" " Pressure Spring.....
17713	6978	" " " " Bracket
1177D	6978	" " " " " Screw.....
17714	6978	Button Clamp Pressure Spring Guide Block.....
1178D	6978	Button Clamp Pressure Spring Screw....
17717	6979	" " " Lever.....
50237F	6979	" " " " H i n g e Screw.....
1180D	6979	Button Clamp Spreader Lever Locking Thumb Screw.....
17718	6979	Button Clamp Spreader Lever Locking Thumb Screw Washer.....
1182E	6978	Button Clamp Spreader Screw.....
39243	6978	" " " Spring.....
207F	6978	" " " " S c r e w
7071	6990	" " " " " Washer.....
17720	6979	Button Clamp Spreader Steady Pin.....
39244	3747	" " Spring (left) for flat buttons.....
39245	3747	Button Clamp Spring (right) for flat buttons.....
39246	6978	Button Clamp Spring (left) for stud back buttons.....
39247	6978	Button Clamp Spring (right) for stud back buttons.....
229D	6978	Button Clamp Spring Screw.....
9311	3747	" " " Steady Pin.....
39248	6979	" " Stop with two 17720.....
1183D	6979	" " " Screw.....

NO.	PLATE	NAME
17723	6979	Button Clamp Stud.....
39249	3751	Button Clamp (universal) complete, for 10 to 50 line thin buttons, Nos. 207F, 1180D, 1182E, 7071, 17717, 17718, 39238 to 39240, 39242, 39243, 39244 or 39246, 39245 or 39247, 39248, 50237F and two each 229D, 1175E and 1183D.....
*62180	—	Cloth Plate with 62181.....
*62181	—	" " Button Tray.....
62102	6980	" " Guide Block (left).....
742F	6980	" " " " " Screw....
1547D	6980	" " " " " " Nut
62103	6980	" " " " (right).....
3021	6980	" " " " Rivet....
190D	6990	" " Screw.....
62104	6980	" " Stop.....
26770	6980	" " " Rivet.....
62182	6975	Cloth Plate complete, Nos. 742F, 1547D, 26770, 62102 to 62104, 62180 and two 3021.....
*62177	—	Cylinder.....
62183	7014	" Bottom Cover.....
62108	6981	" End Cover.....
62184	—	" " " 62108 with 1034D, 62111 to 62113, 62183, 62185 and four 1477D.....
62185	6980	Cylinder End Cover Bracket.....
62111	6980	" " " " " hinge pin....
1477D	6980	" " " " " Screw.....
62112	6980	" " " Hinge.....
1477D	6980	" " " " " Screw.....
62113	6980	" " " Spring.....
1034D	6980	" " " " " Screw.....
62114	6980	" Top Cover.....
286D	6980	" " " Thumb Screw.....
59711	6981	Face Plate.....
59712	—	Face Plate complete, Nos. 208D, 9544, 9545, 59711 and two each 229D, 2107 and 9543.....
164D	6990	Face Plate Screw.....
2107	6980	" " Thread Guard.....
229D	6978	" " " " " Screw.....
9543	6980	" " " Nipper Disc.....
9544	6980	" " " " " C o v e r
208D	6980	" " " " " " " Screw.....
9545	6980	Face Plate Thread Nipper Disc Spring...

NO.	PLATE	NAME
62115	6982	Feed Across Connection Adjusting Stud
1649c	6982	" " " " " "
		Nut (left).....
1650c	6982	Feed Across Connection Adjusting Stud
		Nut (right).....
62116	6982	Feed Across Knuckle Joint.....
17728	6982	" " " " Connection
1184e	6982	" " " " " "
		Hinge Screw.....
59713	6984	Feed Across Lever with 1185c and 50150c
17730	6982	" " " Ball Stud.....
1185c	6982	" " " " " Set Screw...
59714	—	Feed Across Lever complete, Nos. 59713, 59715 and 59721.....
59715	6983	Feed Across Lever Extension with 1952 and 51814.....
59716	6983	Feed Across Lever Extension Disengaging Eccentric.....
59717	6983	Feed Across Lever Extension Disengaging Eccentric Connection.....
999b	6983	Feed Across Lever Extension Disengaging
59718	6983	Feed Across Lever Extension Disengaging Eccentric Connection Spring.....
193b	6983	Feed Across Lever Extension Disengaging Eccentric Connection Spring Screw....
2273	6983	Feed Across Lever Extension Disengaging Eccentric Pin.....
59719	6983	Feed Across Lever Extension Disengaging Eccentric Shaft.....
59720	6983	Feed Across Lever Extension Disengaging Handle.....
2273	6983	Feed Across Lever Extension Disengaging Handle Pin.....
51814	6983	Feed Across Lever Extension Guiding Roller and Screw Stud.....
59721	6983	Feed Across Lever Extension Hinge Pin
50150c	6991	" " " " " "
		Set Screw.....
62195	7014	Feed Across Lever Extension Position Arm
2022	6983	" " " " " "
		Pin.....
59723	6983	Feed Across Lever Extension Position Arm Support.....

NO.	PLATE	NAME
1404d	6983	Feed Across Lever Extension Position Arm Support Screw.....
9525	6983	Feed Across Lever Extension Position Arm Support Screw Washer.....
1952	6983	Feed Across Lever Extension Roller and Stud.....
430c	6994	Feed Across Lever Extension Stop Screw
1520e	6994	" " " " " "
		Nut.....
59724	6987	Feed Across Lever Hinge Stud.....
160d	6998	" " " " " Clamping Screw.....
62118	6985	Feed Across Lever Plate with 17741.....
62119	6985	" " " " Cover.....
1094F	6985	" " " " Screw.....
55300	6985	" " " " Steady Pin.....
17733	6982	" " " " Socket Bearing.....
17734	6982	" " " " " Block (two pieces).....
145F	6982	Feed Across Lever Socket Bearing Block Set Screw.....
		Set Screw Nut.....
62120	6984	Feed Across Regulator.....
1187E	6982	" " " " Adjusting Screw Stud.....
1875	6982	Feed Across Regulator Adjusting Screw Stud Nut.....
17738	6982	Feed Across Regulator Adjusting Screw Stud Nut Washer.....
17739	6982	Feed Across Regulator Adjusting Screw Stud Sleeve.....
1188d	6998	Feed Across Regulator Hinge Screw.....
62121	6985	" " " " Link.....
50324E	6985	" " " " " Screw Stud
1655E	6985	" " " " " " "
		Nut.....
14017	6985	Feed Across Regulator Link Screw Stud Nut Washer.....
17741	6985	Feed Across Regulator Link Stud.....
62196	7013	" Cam with two 1192c and three each 190b, 208b, 227b, 17874 and 62138....
18415	6987	Feed Cam Driving Worm with 1441c and 1442c.....
1442c	6987	Feed Cam Driving Worm Position Screw.
1441c	6987	" " " " " Set Screw.....

NO.	PLATE	NAME
17797	6977	Feed Cam Driving Worm Wheel with 453c.....
3012	6988	Feed Cam Driving Worm Wheel Pin.....
453c	6987	" " " " " " Set Screw
18384	6988	" " Pin.....
1192c	6987	" " Set Screw.....
59728	6989	" " Shaft.....
1653c	6999	" " " Nut.....
59729	6988	" Plate (thick).....
17923	6988	" " (thin).....
*18445	6989	" " Carrier Bar.....
62123	—	" " " " 18445 with 934D, 1094F, 1195E, 17743, 18368, 62118, 62119, two 55300 and four 17806.....
59730	6987	Feed Plate Carrier Bar Pivot Block.....
50306D	6987	" " " " " " Screw
18368	6987	" " " " Plate.....
934D	6987	" " " " " " Screw.....
1654c	6988	" " Nut.....
17806	6988	" " Position Stud.....
1195E	6988	" " Screw Stud.....
62117	6984	" " Bracket with 17732 and three 160D.....
*17732	—	Feed Regulator Bracket Cap.....
160D	6998	" " " " " " Screw.....
1177D	6978	" " " " " " Screw.....
17744	6987	" " Hinge Stud.....
17743	6987	" " Post.....
1953	6988	" " Roller and Screw Stud with 1655c and 14017.....
1655c	6985	Feed Regulator Roller and Screw Stud Nut.....
14017	6985	Feed Regulator Roller and Screw Stud Nut Washer.....
1190c	6987	Feed Regulator Stop Screw.....
17745	6987	" " Swivel.....
1191D	6987	" " Thumb Screw.....
59731	6990	Knife.....
62124	6975	" Bar with 62130 and two 3021.....
62125	6990	" " Cap.....
164D	6990	" " " Screw.....
62126	6990	" " Connection with 17917.....
190D	6990	" " " Screw.....
17915	6990	" " " Slide Block.....

NO.	PLATE	NAME
17917	—	Knife Bar Connection Slide Block 17915 with 17916.....
17916	6990	Knife Bar Connection Slide Block Stud..
59734	6990	" " Driving Lever with 223F and 59735.....
1382F	6998	Knife Bar Driving Lever Hinge Screw
1681c	6999	" " " " " " " " Nut.....
59735	6990	Knife Bar Driving Lever Lock Stud.....
223F	6990	" " " " " " " " Screw
62127	6990	" " Guide.....
1235F	6990	" " " Screw.....
8734	7015	" " Retaining Spring.....
62192	7015	" " " " Bracket.....
62128	6990	" Holder with 59739.....
62129	6990	" " Cap with 59739.....
691F	6990	" " " Screw.....
59739	6990	" " " Stud.....
62130	6990	" " Connection.....
3021	6980	" " " Rivet.....
59739	6990	" " Stud.....
62179	7015	Looper with 34418.....
*59742	—	" Collar.....
59743	6991	" Driving Shaft.....
62131	6991	" " " Bushing.....
52045	6992	" " " " " Packing (cotton).....
1148c	7015	Looper Driving Shaft Bushing Set Screw.
59745	6991	" " " Collar with two 465c.....
465c	6991	Looper Driving Shaft Collar Set Screw...
59746	6991	" " " Coupling with two 50150c.....
50150c	6991	Looper Driving Shaft Coupling Set Screw
59707	6976	" " " Gear with two 1253c.....
59747	6992	Looper Driving Shaft Gear Cover.....
190D	6990	" " " " " " Screw.
1253c	6976	" " " " " Set Screw....
59748	6991	" " " " Universal Joint....
50150c	6991	" Set Screw.....
59749	6989	" Shaft with 50150c and 59742....
59745	6991	" " Collar with two 465c.....
465c	6991	" " " Set Screw.....
59746	6991	" " Coupling with two 50150c..

NO.	PLATE	NAME
50150c	6991	Looper Shaft Coupling Set Screw.....
62197	7015	" " Ball with two 624c.....
62132	6991	" " " Connection with 59752 and two 171E.....
*59752	—	Looper Shaft Ball Connection Cap.....
171E	6991	" " " " " Screw.....
62133	6991	" " " " Stud (ec- centric).....
1095F	6991	Looper Shaft Ball Connection Stud Cap Screw.....
1259c	6991	Looper Shaft Ball Connection Stud Set Screw.....
624c	6991	Looper Shaft Ball Set Screw.....
62134	6991	" " Slide Block.....
62135	6991	" " " " Cap.....
1186c	6991	" " " " " Screw.....
34418	6991	" Washer.....
62198	7014	Needle Bar with 1072F.....
39203	6992	" " Connecting Link.....
377c	6992	" " " " Hinge Screw.....
1518E	6992	" " " " " " " " Nut.....
2052	6992	Needle Bar Connecting Stud with 155c..
155c	6992	" " " " " Set Screw...
59757	6992	" " Crank Wheel with 448c and 1293c.....
1293c	6992	Needle Bar Crank Wheel Position Screw.
448c	6992	" " " " " Set Screw.....
59758	6993	" Guard.....
59759	6993	" " Cam with two 465c.....
465c	6991	Needle Bar Cam Set Screw.....
2273	6983	" " Pin.....
59760	6989	" " Shaft.....
59761	6993	" " " Collar with two 465c
465c	6991	" " " " " Set Screw....
59762	6993	" " " Crank with 51812 and two 465c.....
51812	6993	Needle Guard Shaft Crank Roller and Stud.....
465c	6991	Needle Guard Shaft Crank Set Screw....
59763	6993	" " " End Bearing.....
59764	6989	" " " " " Bracket
2022	6983	" " " " " " " Dowel Pin.....
965D	6993	Needle Guard Shaft End Bearing Bracket Screw.....

NO.	PLATE	NAME
1480H	6993	Needle Guard Shaft End Bearing Cap Screw.....
59765	6993	Needle Guard Shaft Spring.....
59766	6993	" " " " Collar with 624c.....
624c	6991	Needle Guard Shaft Spring Collar Set Screw.....
233D	6995	Needle Guard Shaft Spring Screw.....
1072F	6993	" Set Screw.....
2058	6989	Presser Bar.....
17841	6992	" " Collar with two 196F.....
196F	6992	" " " Set Screw.....
17842	6992	" " Guide Bracket with 453c....
453c	6987	" " " " " Set Screw....
17843	6981	" " Lifting Lever.....
59767	6996	" " " " Bracket.....
164E	6990	" " " " " Screw.
1201D	6996	" " " " Hinge Screw...
17845	6984	" " " " Rod.....
17846	—	" " " " " Chain....
8414	6989	" " Spring.....
17848	6977	" " Bushing.....
2269	6994	" " " Position Pin.....
1202D	6998	" " Cap Screw.....
17942	6977	" (tight) 2 $\frac{7}{8}$ in. diam., with 2269...
2022	6982	" " Pin.....
17955	—	Pulleys complete Nos. 1202D, 1206C, 17848, 17854, 17941 and 17942.....
17853	6994	Starting Lever.....
1262c	6998	" " Hinge Screw.....
1662c	6999	" " " " Nut.....
17886	6984	" " Pitman.....
17854	6994	Stop Cam.....
17855	6994	" " Interlocking Rod.....
62136	6977	" " " " Case with 59771 and two 193F.....
59769	6977	Stop Cam Interlocking Rod Case Bracket
62137	—	Stop Cam Interlocking Rod Case Bracket complete, Nos. 1182E, 1196c, 1204E, 1254c, 1262c, 1318D, 1508E, 1662c, 17853, 17855, 17859, 17861 to 17864, 17872, 17873, 39222, 39223, 39343, 39344, 59769, 62136 and two each 898D, 1186F and 1255D.....
21828	6976	Stop Cam Interlocking Rod Case Bracket Dowel Pin.....

NO.	PLATE	NAME
50372D	7015	Stop Cam Interlocking Rod Case Bracket Screw.....
1204E	6998	Stop Cam Interlocking Rod Case Hinge Screw.....
17859	6977	Stop Cam Interlocking Rod Case Socket Joint.....
898D	6998	Stop Cam Interlocking Rod Case Socket Joint Cap Screw.....
39343	6981	Stop Cam Interlocking Rod Case Spring (flat).....
430c	6994	Stop Cam Interlocking Rod Case Spring Adjusting Screw.....
1520E	6994	Stop Cam Interlocking Rod Case Spring Adjusting Screw Nut.....
39344	6994	Stop Cam Interlocking Rod Case Spring Bracket with 430c and 1520E.....
1186F	6991	Stop Cam Interlocking Rod Case Spring Bracket Screw.....
17861	6994	Stop Cam Interlocking Rod Case Stop Stud.....
1254c	6998	Stop Cam Interlocking Rod Case Stop Stud.....
1508E	6999	Stop Cam Interlocking Rod Case Stop Stud Screw Bushing Lock Nut.....
17862	6994	Stop Cam Interlocking Rod Case Stop Stud Spring.....
59771	6994	Stop Cam Interlocking Rod Case Wearing Block.....
193F	6983	Stop Cam Interlocking Rod Case Wearing Block Screw.....
17863	6994	Stop Cam Interlocking Rod Spring.....
17864	6994	" " " " Stop.....
1318D	6994	" " " " " Screw..
3012	6988	" " Pin.....
1206c	6994	" " Screw.....
2102	6995	Tension Disc.....
1560c	6995	" Regulating Thumb Nut.....
50148c	6995	" Screw Stud.....
42336	6995	" Spring.....
13915	6995	" " Bushing.....
10145	6995	" Thread Guide.....
59772	6995	Thread Eyelet (head of arm).....
233D	6995	" " " " " Set Screw..
1743D	6979	" Nipper Adjusting Thumb Nut...
59773	6995	" " Body.....
624c	6991	" " " Set Screw.....
59774	6995	" " Cam with two 50150c....

NO.	PLATE	NAME
50150c	6991	Thread Nipper Cam Set Screw.....
2921	6995	" " Disc.....
12162	6995	" " " Guide Pin.....
62169	6979	" " " Spring.....
59775	6995	" " Eyelet.....
1527D	6995	" " Lock Nut.....
59776	6995	" " Stud with 13538.....
13538	6995	" " " Position Pin.....
13539	6995	" " " Roller.....
13540	6995	" " " " Pin.....
2026	6995	" " " Spring.....
59777	—	Thread Nipper Stud complete, Nos. 13539, 13540 and 59776.....
59778	—	Thread Nipper complete, Nos. 1527D, 1743D, 2026, 59773, 59775, 59777, 62169 and two 2921.....
62138	6987	Thread Pull-off Cam.....
208D	6980	" " " Screw (large).....
227D	7015	" " " " (small).....
59780	6996	" " Driving Lever.....
1196c	6998	" " " " H i n g e Screw.....
59781	6996	Thread run-on Driving Lever Spring....
59782	6996	" " Lever.....
59783	6996	" " " Bushing.....
1445H	6996	" " " " Screw....
59784	6996	" " " Connection.....
50111D	6996	" " " " H i n g e Screw (driving lever end).....
50111D	6996	Thread Pull-off Lever Connection Hinge Screw (lever end).....
59785	6996	Thread Pull-off Regulator.....
62170	—	" Take-up Body with 62172.....
42808	6979	" " Roller.....
62171	6979	" " " Cap.....
337D	6979	" " " " Screw.....
62172	6979	" " " Pin.....
62173	6979	Thread Take-up complete, Nos. 337D, 42808, 62170 and 62171.....
691F	6990	Thread Take-up Screw.....
39452	6979	" Wiper Body.....
39453	6979	" " " Finger.....
330D	6979	" " " " Screw.....
1207D	6979	" " " Hinge Screw.....
59787	6979	" " " Support.....
641D	6979	" " " " Set Screw..
39455	6979	" " " Wire.....

NO.	PLATE	NAME
39456	6979	Thread Wiper Body Wire Clamp.....
1302d	6979	“ “ “ “ “ Screw..
62139	7016	Throat Plate.....
62199	7016	“ “ Needle Guard.....
206d	7016	“ “ “ “ Screw.....
691f	6990	“ “ Screw.....
17872	6994	Trip Lever.....
1196c	6998	“ “ Hinge Screw.....
17873	6994	“ “ Spring.....
1182e	6978	“ “ “ Screw.....
17874	6987	Tripping Point.....
190d	6990	“ “ “ Screw.....

MACHINE No. 114-4

FOR SEWING TWO OR FOUR-HOLE BUTTONS ON SHIRTS, WAISTS AND UNDERWEAR. SMALL BUTTONS ONLY. MAKES TWO PARALLEL BARS IN FOUR-HOLE BUTTONS. MAKES TWENTY-ONE STITCHES INCLUDING THE FASTENING STITCHES.

This machine is the same as No. 114-3 with the following exception:

NO.	PLATE	NAME
62200	7015	Feed Cam with two each 190d, 208d, 207e, 1199c, 17874 and 62128, in place of 62196.....

ACCESSORIES

NO.	PLATE	NAME
59797	7005	Button Tray with two wood screws 1¼ in. No. 14.....
18419	—	Cylinder Base Plate with two 453c.....
18420	7006	“ “ “ Hinge Connection.....
18423	7006	“ “ “ “ “ “ Hinge Pin.....
453c	6987	Cylinder Base Plate Hinge Connection Hinge Pin Set Screw.....
18424	7005	Cylinder Base Plate (hinged) complete, Nos. 18419, two each 18420, 18423, three wood screws 1¼ in. No. 12 and four 134d.....
134d	—	Cylinder Base Plate Screw.....

NO.	PLATE	NAME
35565	7007	Oiler (copper plated) with 36566.....
36566	7007	“ Spout, 9 in. long, with 120117.....
120117	7014	“ “ Washer (leather).....
11831	7007	Screw Driver (large).....
26026	7007	“ “ (small).....
4822	7007	Wrench for 1528 and 1547.....
10875	7007	“ “ 1518, 1520, 1649, 1650 and 1662.....
17905	7007	Wrench for 1176, 1178, 1654, 1655, 1676 and 1681.....
25200	7007	Wrench for 1527.....
27662	7007	“ “ 1254 and 1508.....

PROTECTOR

NO.	PLATE	NAME
39489	7008	Arm with 39490.....
160c	7009	“ Clamping Screw.....
39490	—	Blade.....
39491	7008	Bracket with two each 426c and 448c....
426c	7009	“ Adjusting Screw.....
39492	7009	Crank with 160c.....
39493	7009	“ Bracket with 1120c and two 454c.....
454c	7009	“ “ Set Screw.....
52598	7009	“ Hinge Stud.....
1120c	7009	“ “ “ Set Screw.....
39494	7008	Rod.....
15261	7009	“ Collar with 237F.....
237F	7009	“ “ Set Screw.....
39495	7009	“ Connection.....
176d	7009	“ “ Screw.....
1099F	7009	“ Screw Stud.....
39496	7008	“ Sleeve.....
448c	7009	“ “ Set Screw.....
39497	7009	“ Spring.....
15261	7009	“ “ Collar with 237F.....
237F	7009	“ “ “ Set Screw.....
39498	—	Protector (front of needle) complete, Nos. 1099F, 39489, 39491 to 39497, 52598 and two each 176d, 15261 and 50351d.....

PLATE 2836—ONE-FOURTH SIZE

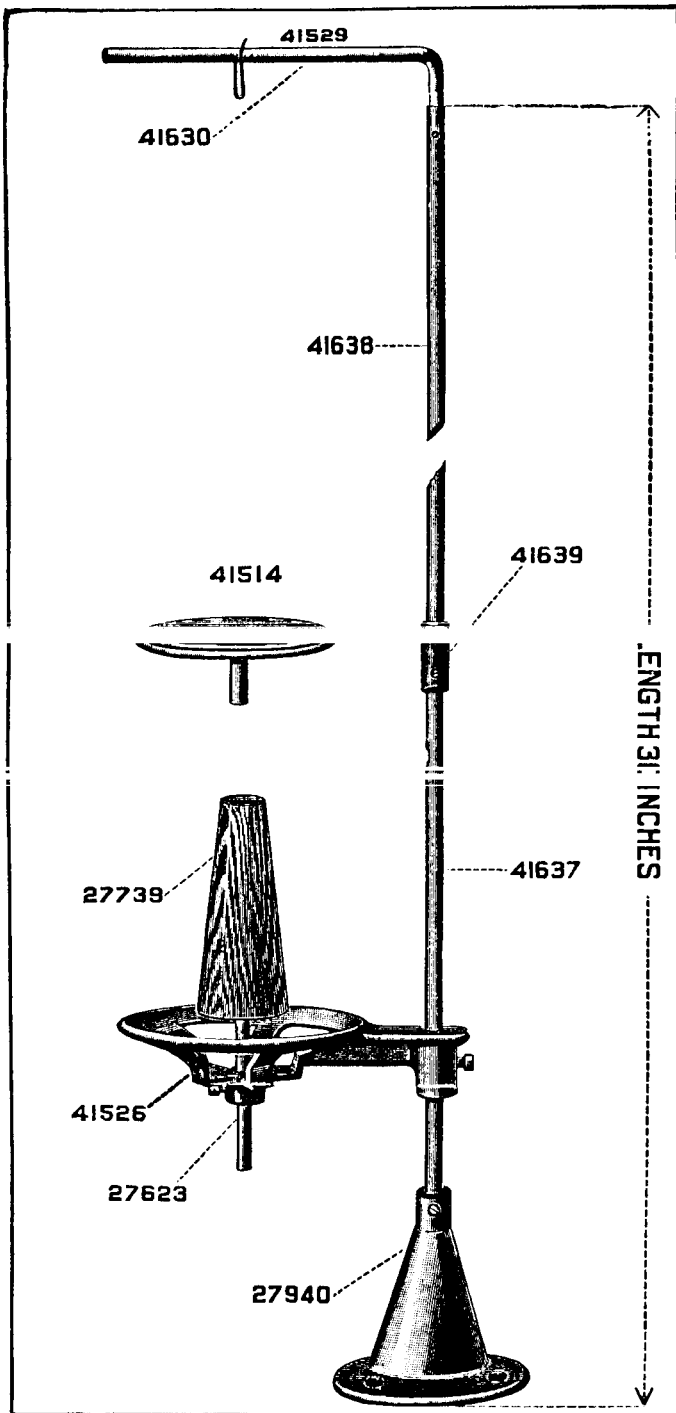

PLATE 3747—FULL SIZE

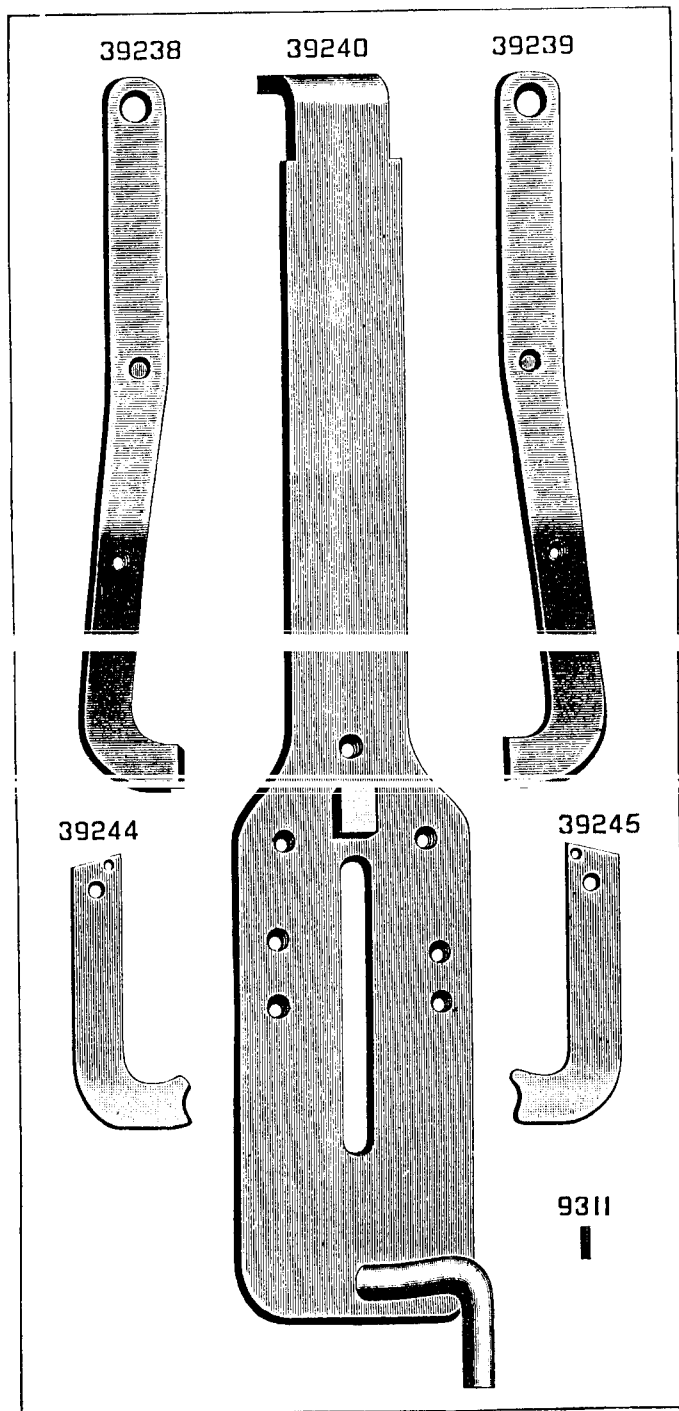

PLATE 3751—FULL SIZE

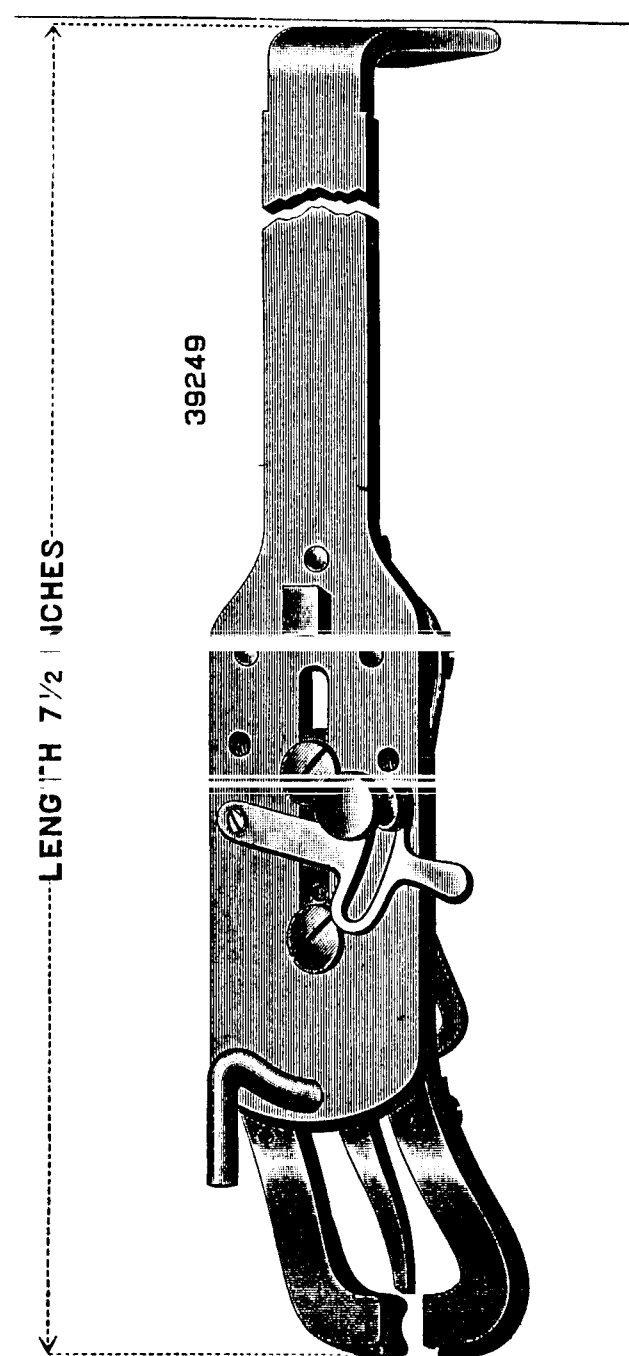
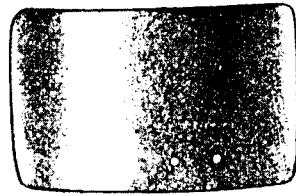

PLATE 6975—ONE-FOURTH SIZE

59702



18498



62124



62105

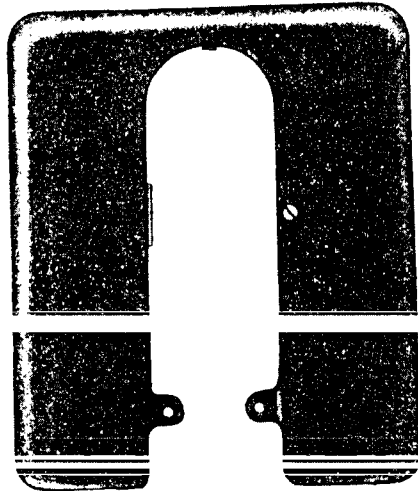

62182

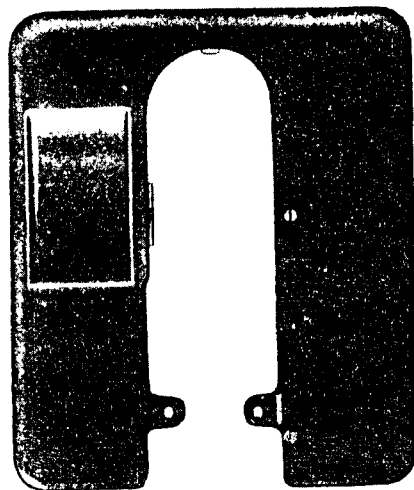
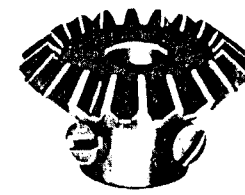

PLATE 6976—FULL SIZE

59704



59708



59703

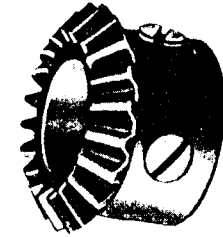

59706



1036



39223



1253



4449



1055



59705



56015



59707



16532



21828



PLATE 6977—ONE-HALF SIZE

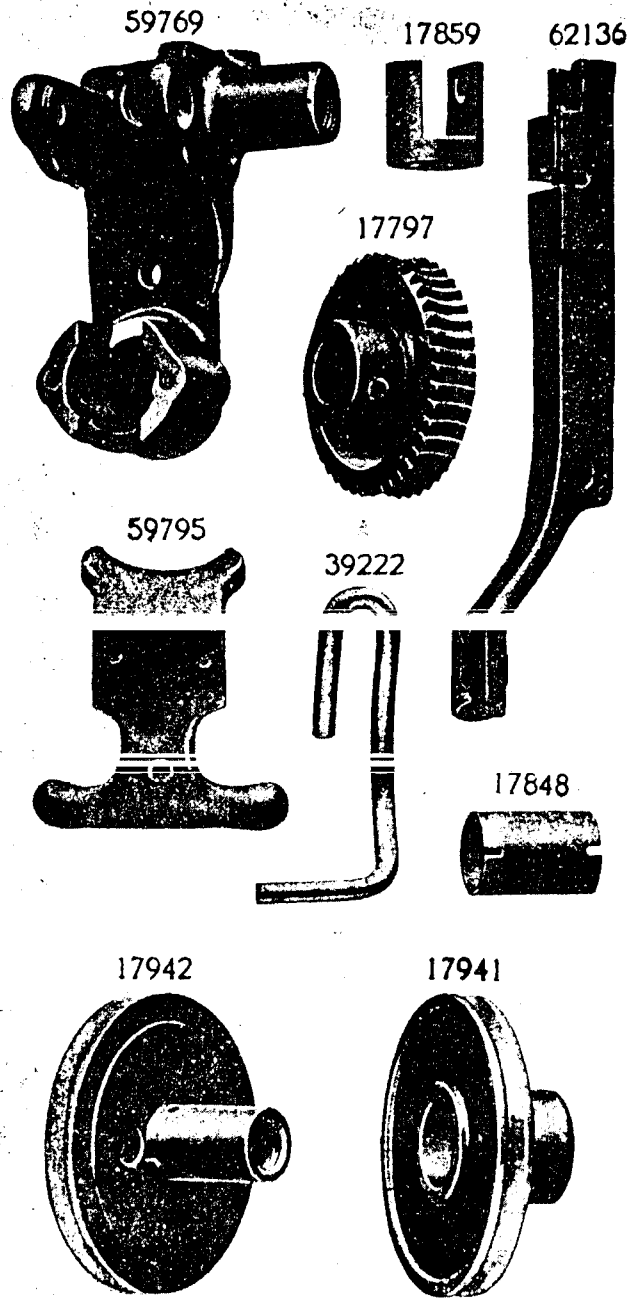

PLATE 6978—FULL SIZE

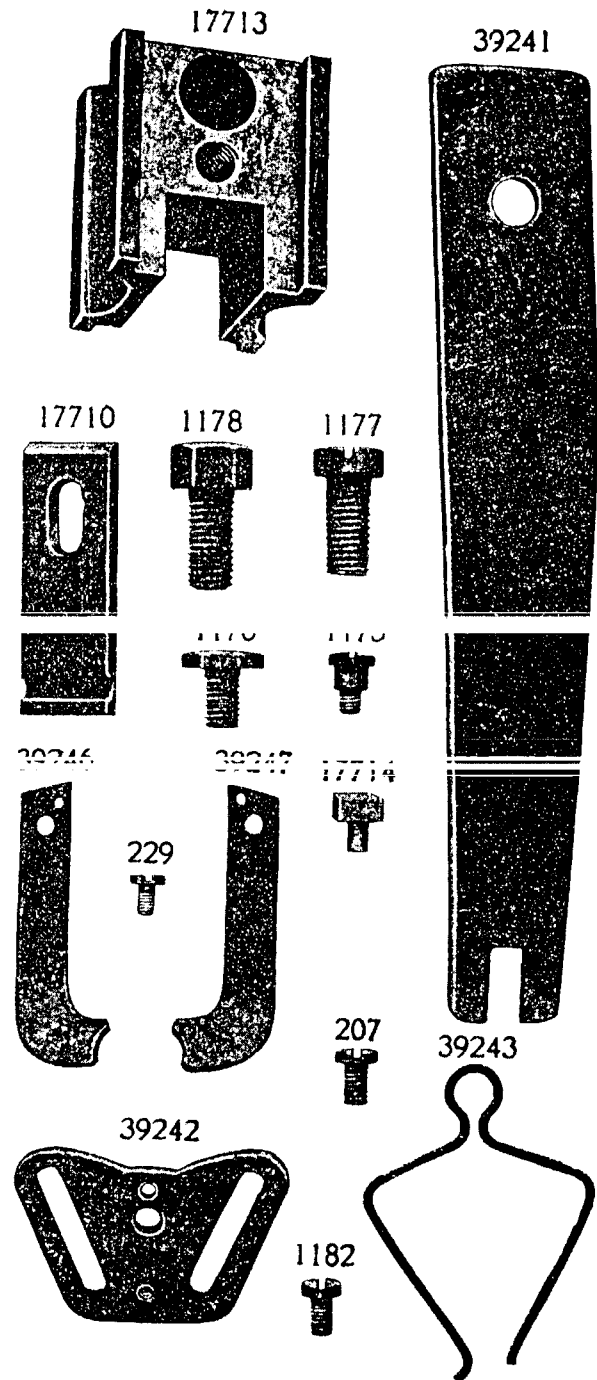

PLATE 6979—FULL SIZE

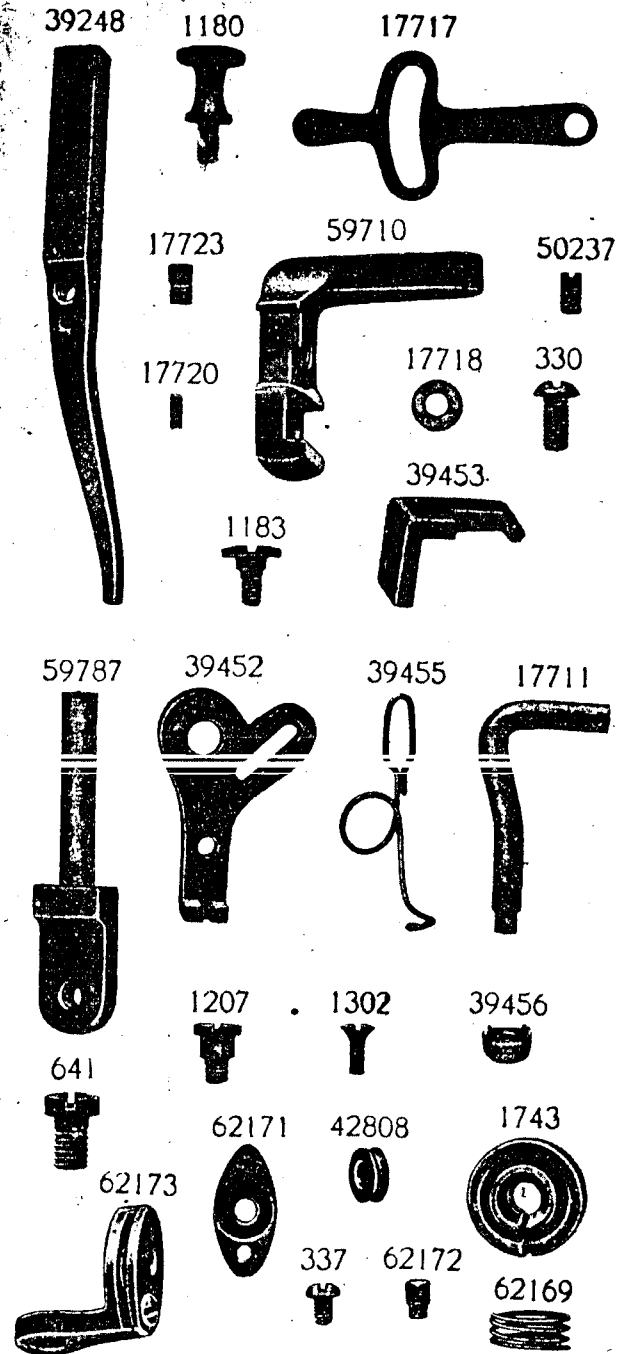

PLATE 6980—FULL SIZE

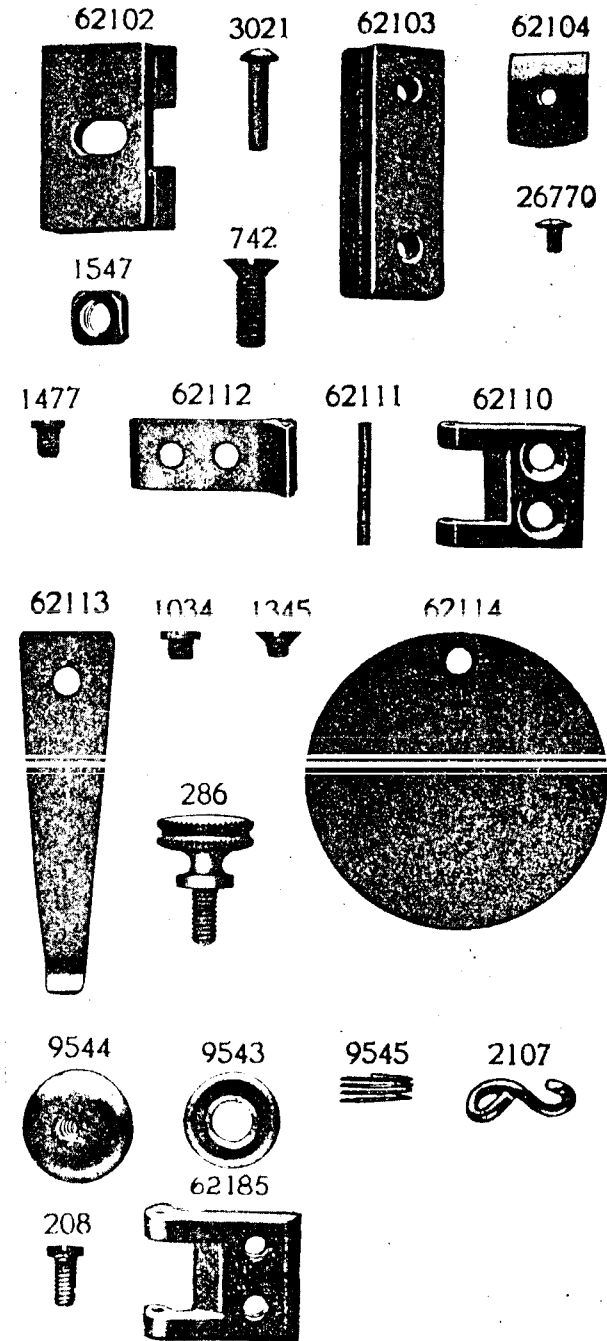

PLATE 6981—ONE-HALF SIZE

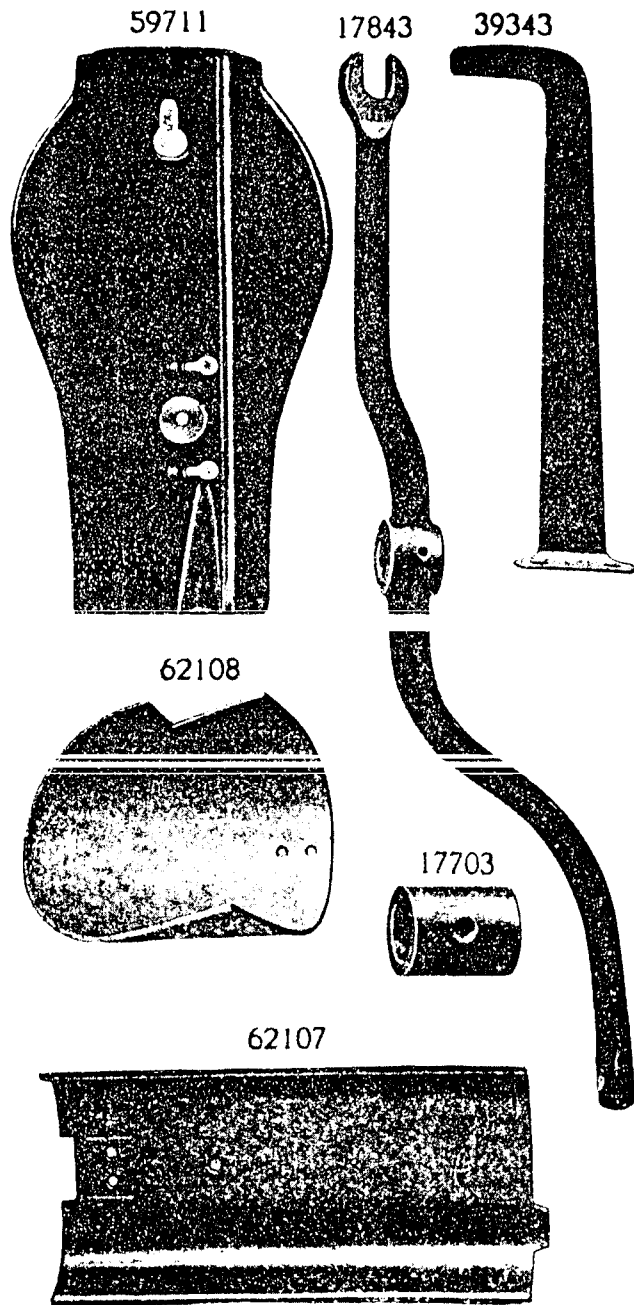

PLATE 6982—FULL SIZE

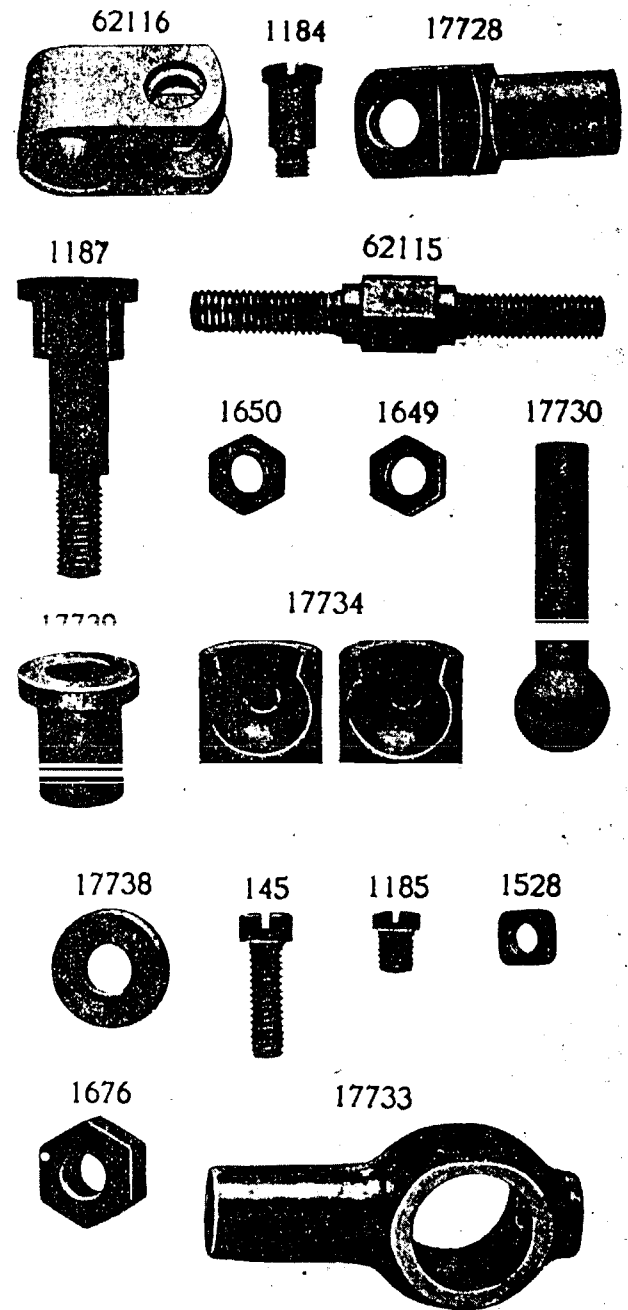

PLATE 6983—FULL SIZE

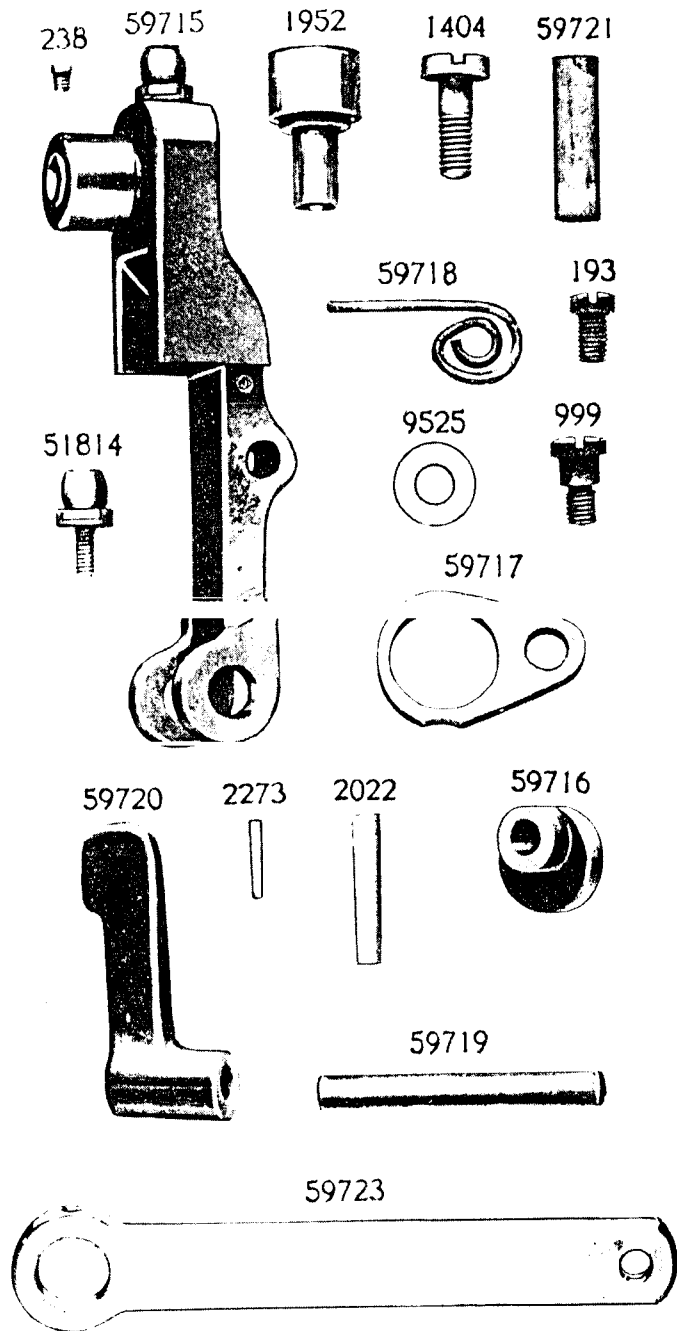

PLATE 6984—ONE-HALF SIZE

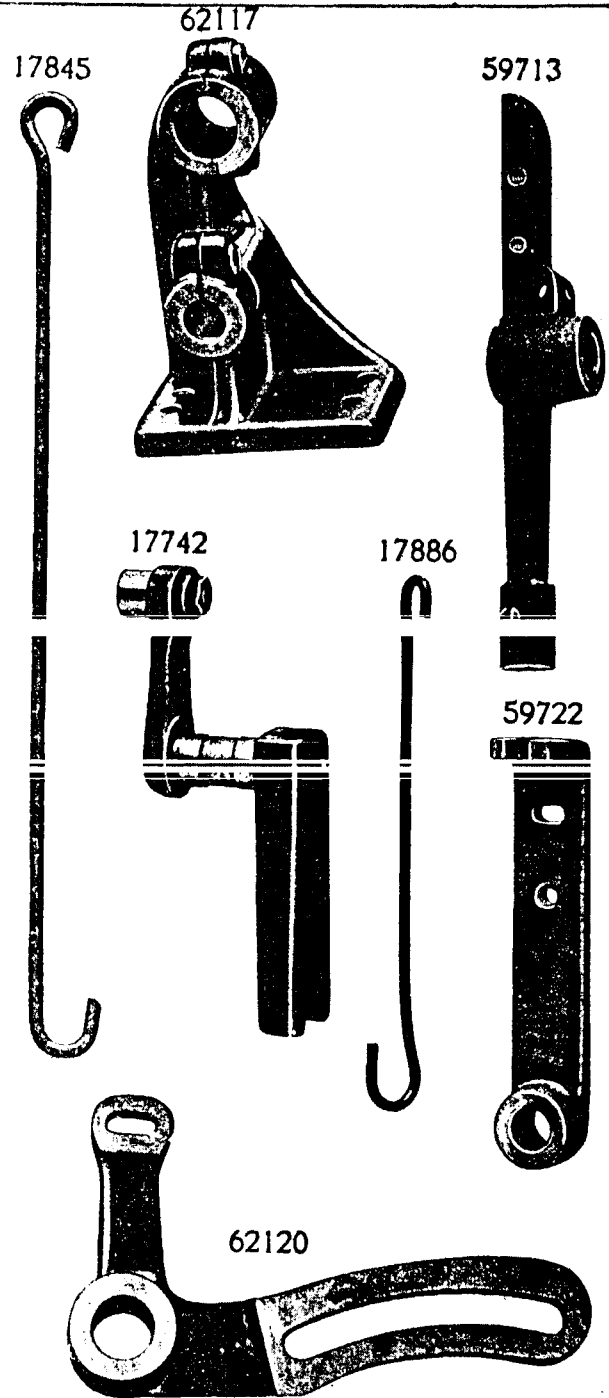

PLATE 6985—FULL SIZE

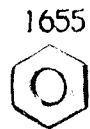
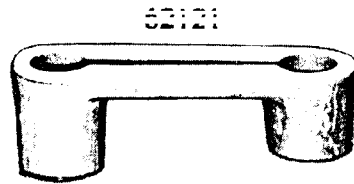
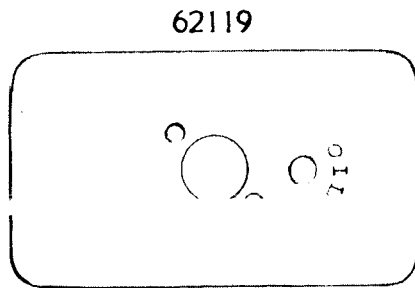
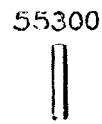
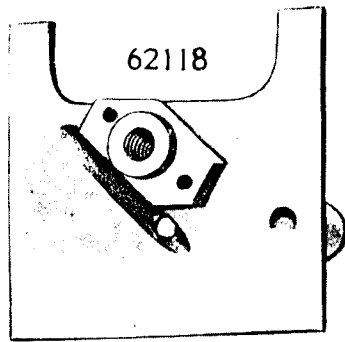
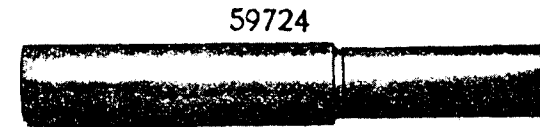
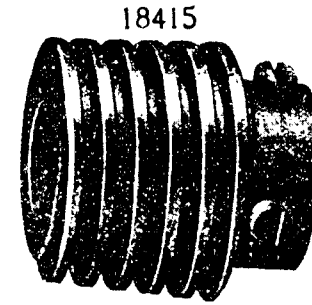

PLATE 6987—FULL SIZE



17743



1191



17744



17745



1190

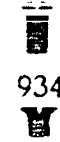

59730



50306



934



18368

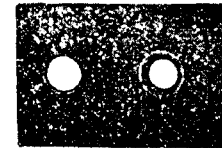

17874



62138



PLATE 6988—FULL SIZE

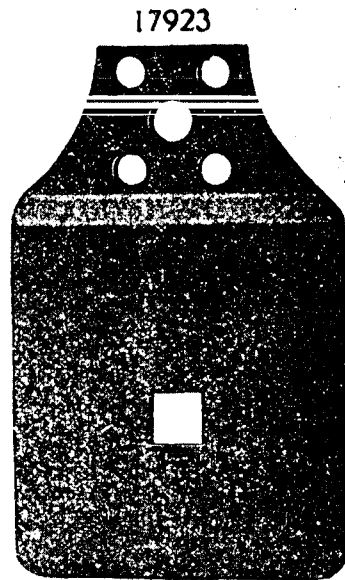
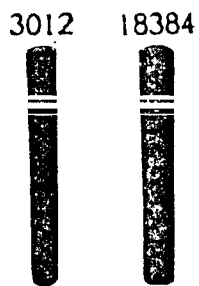
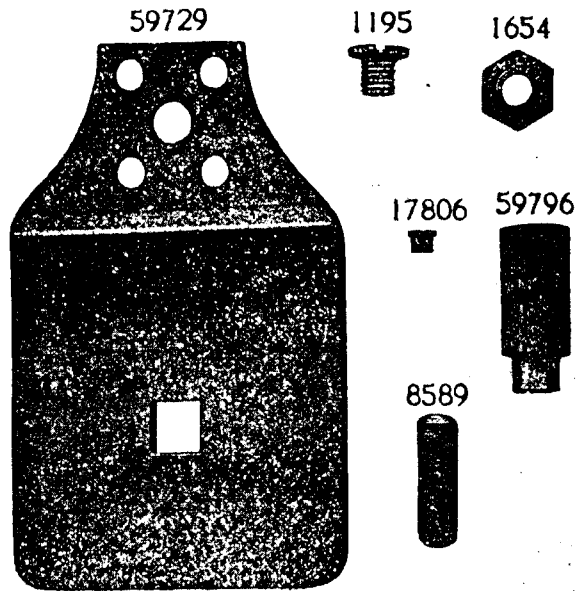

PLATE 6989—ONE-HALF SIZE

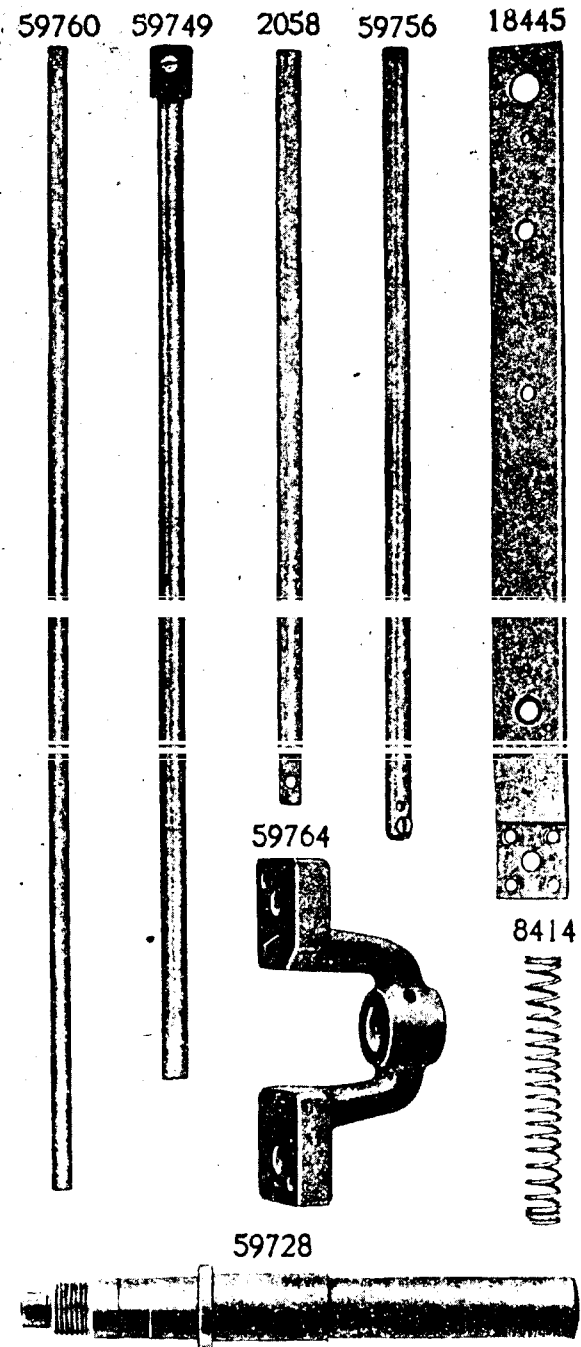

PLATE 6990—FULL SIZE

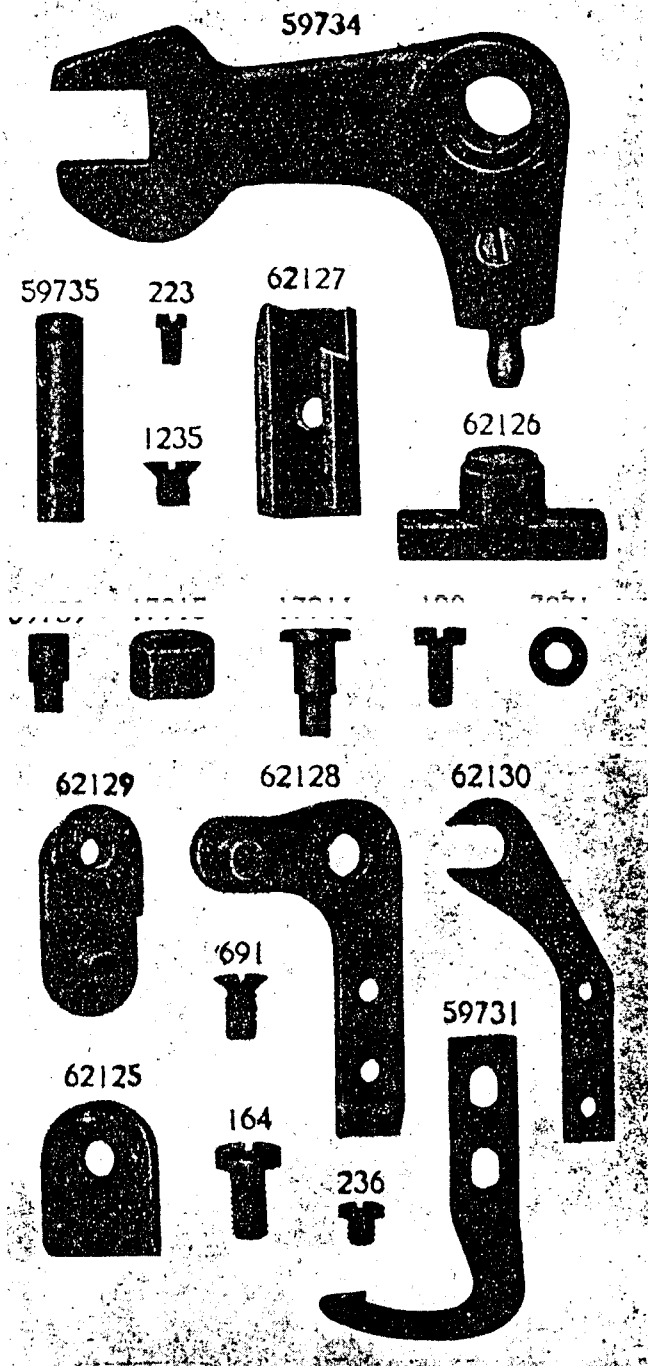

PLATE 6991—FULL SIZE

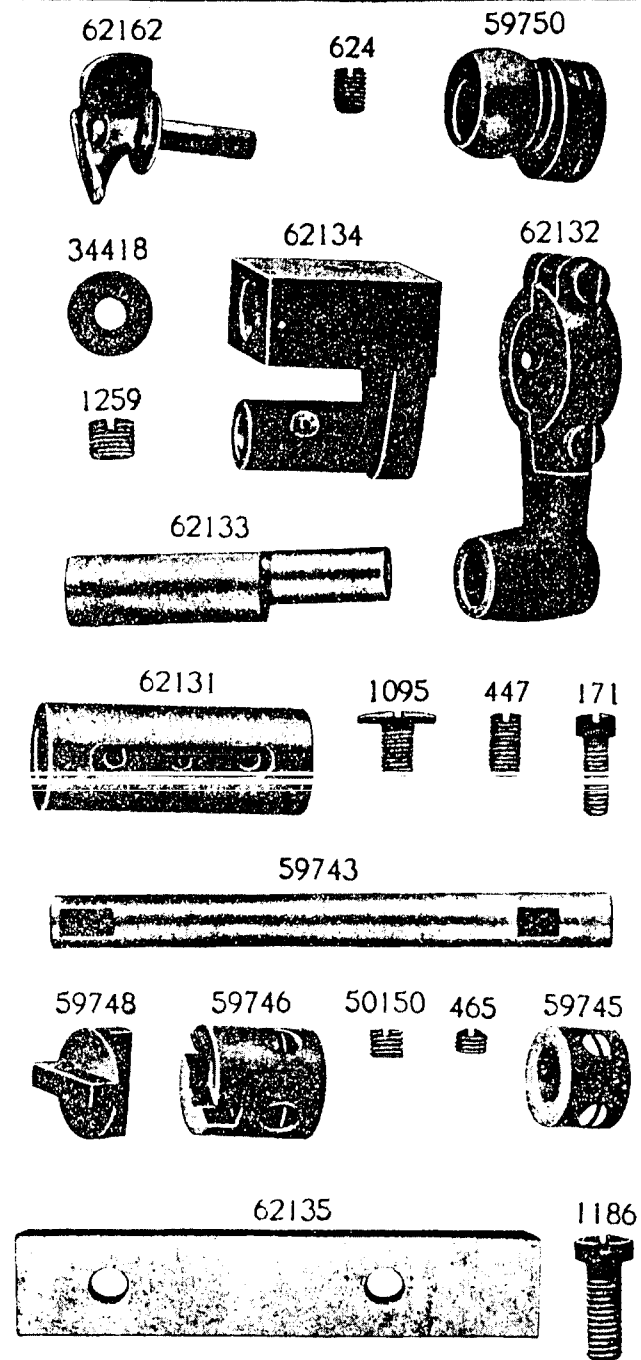
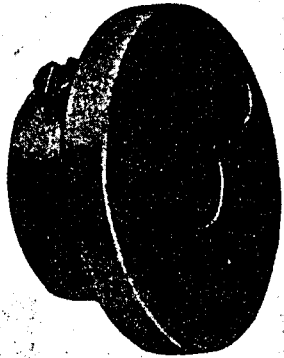

PLATE 6992—FULL SIZE

59757



1293



17841



448



196



377



39203



2052

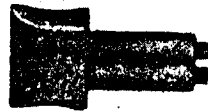

17842



52045

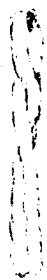

59747

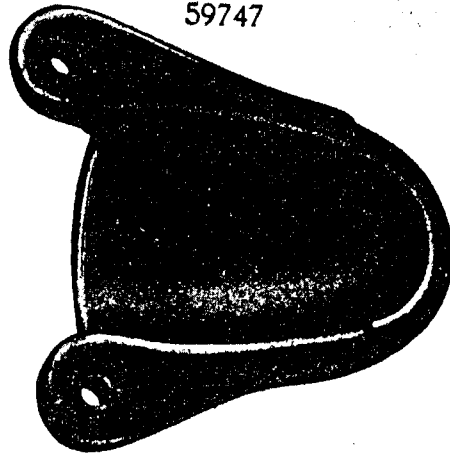

PLATE 6993—FULL SIZE

59758



59759



59761



59762



51812



59766



965



59765



59763

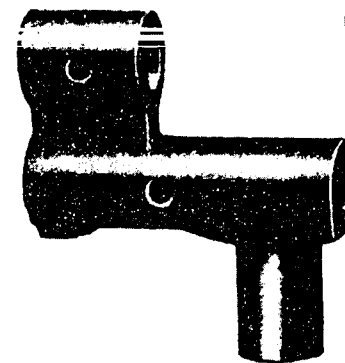

1480



1072



59789

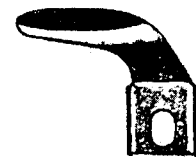

59786



59741

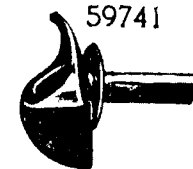

PLATE 6994—FULL SIZE

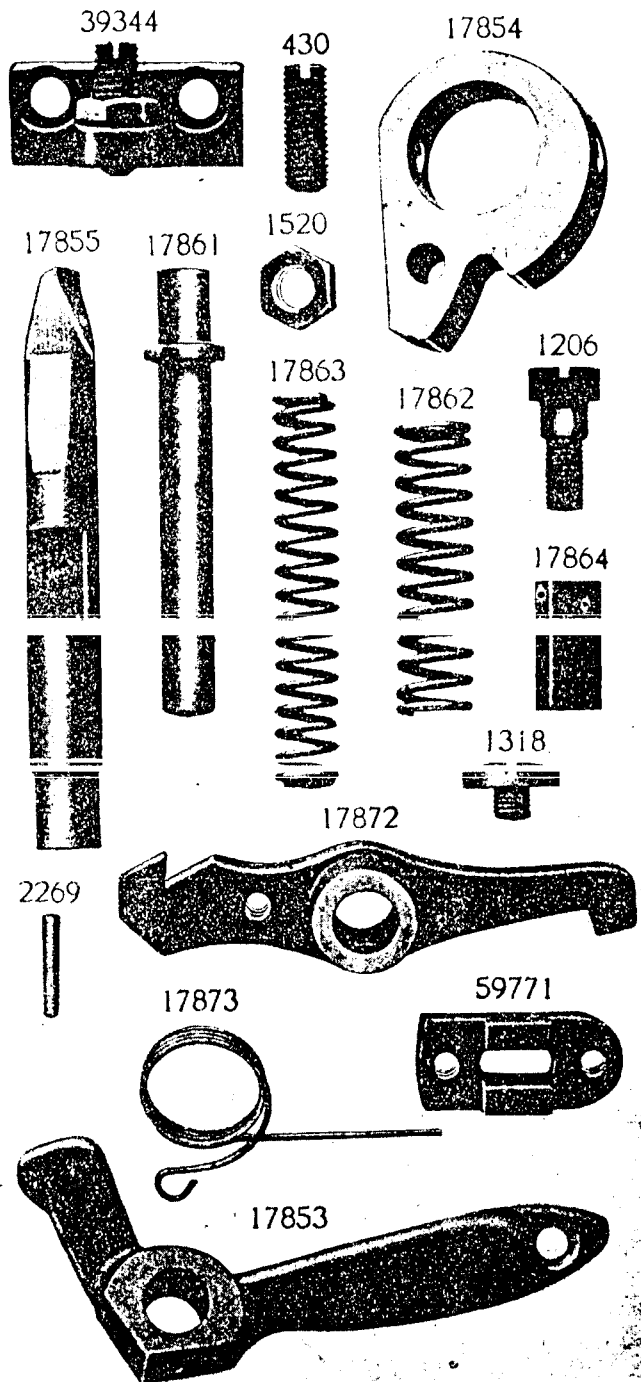

PLATE 6995—FULL SIZE

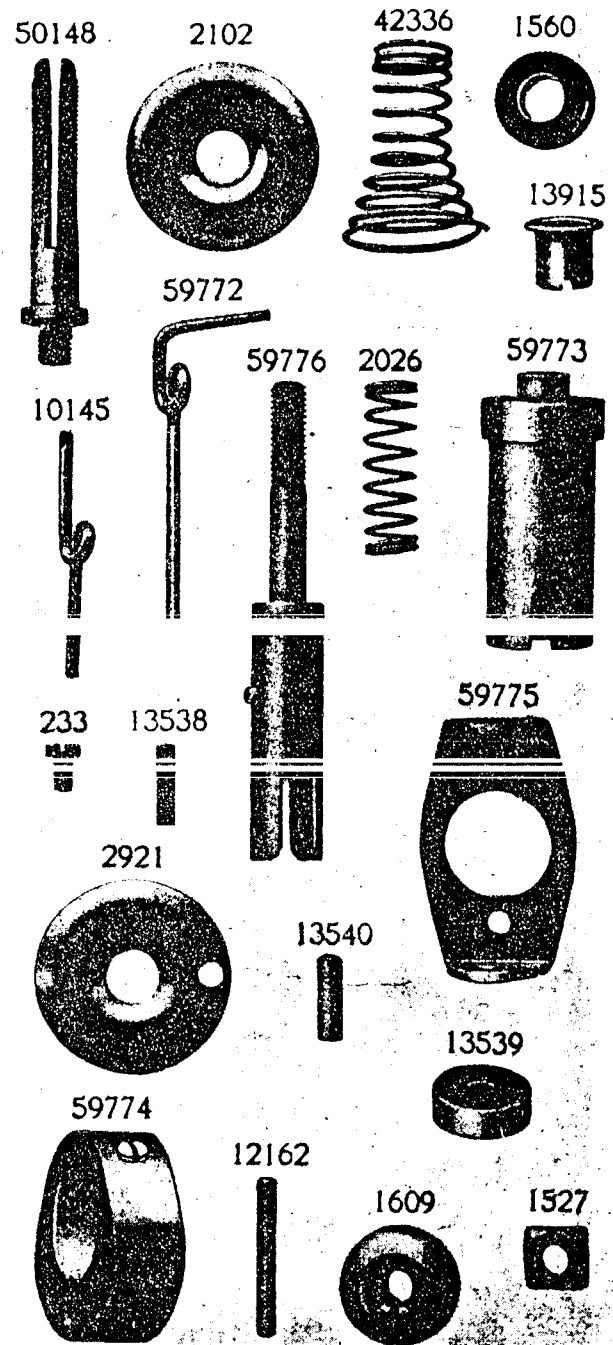

PLATE 6996—FULL SIZE

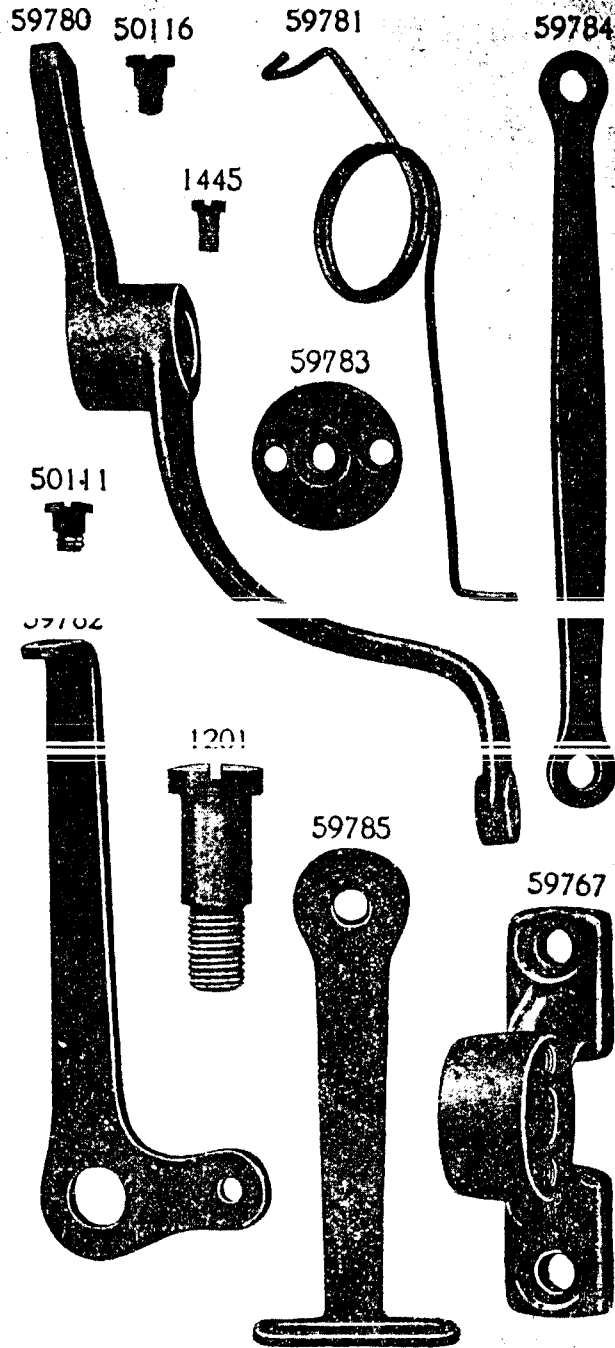

PLATE 6998—FULL SIZE

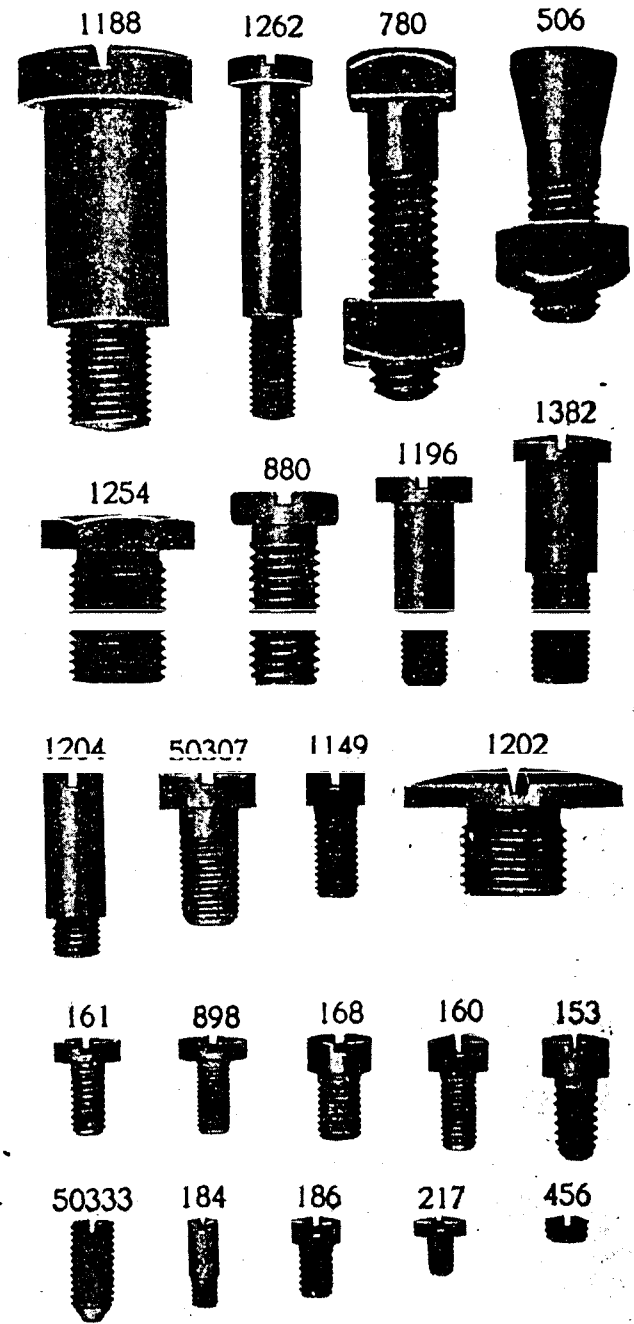

PLATE 6999—FULL SIZE

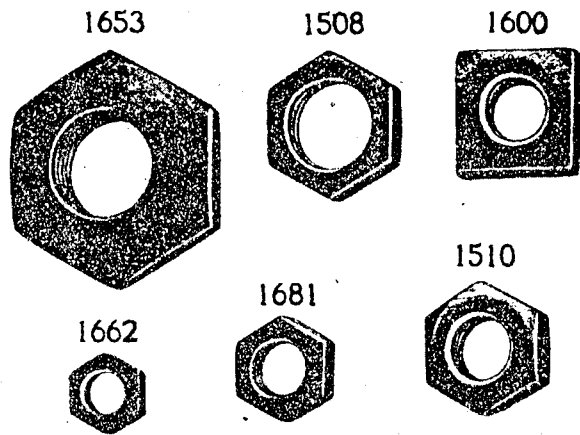

PLATE 7005—ONE-FOURTH SIZE

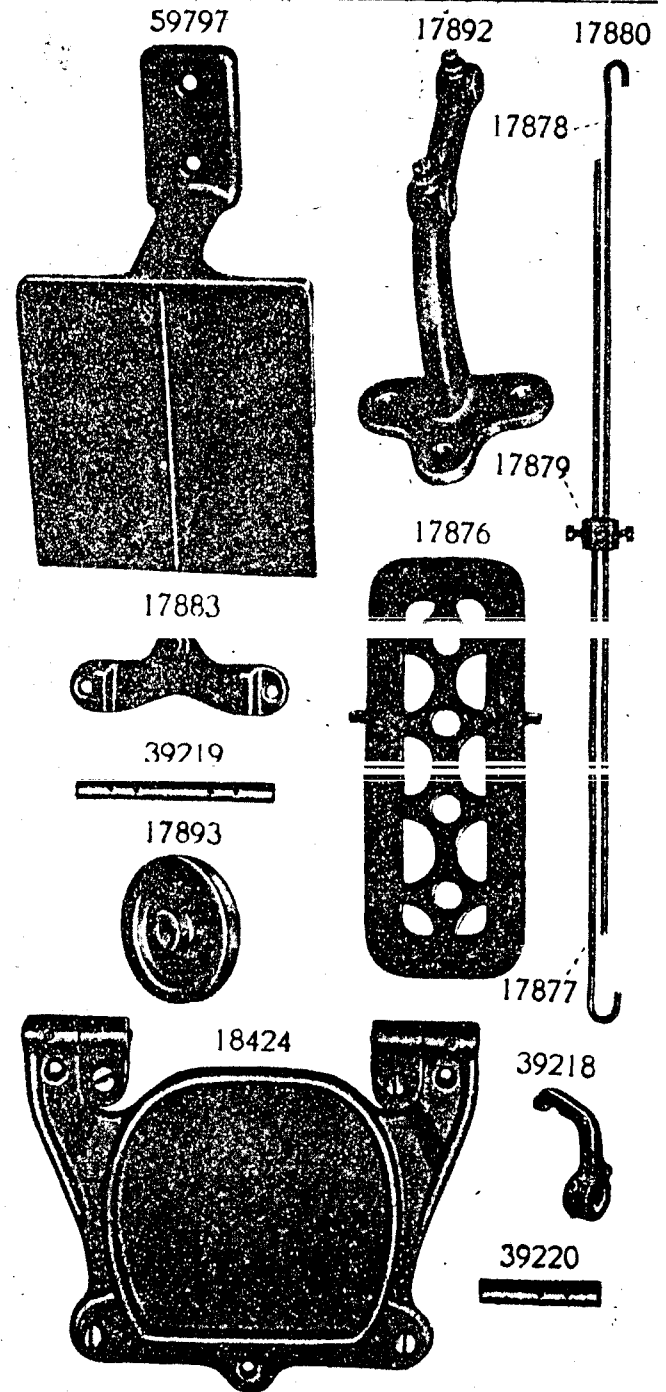

PLATE 7006—FULL SIZE

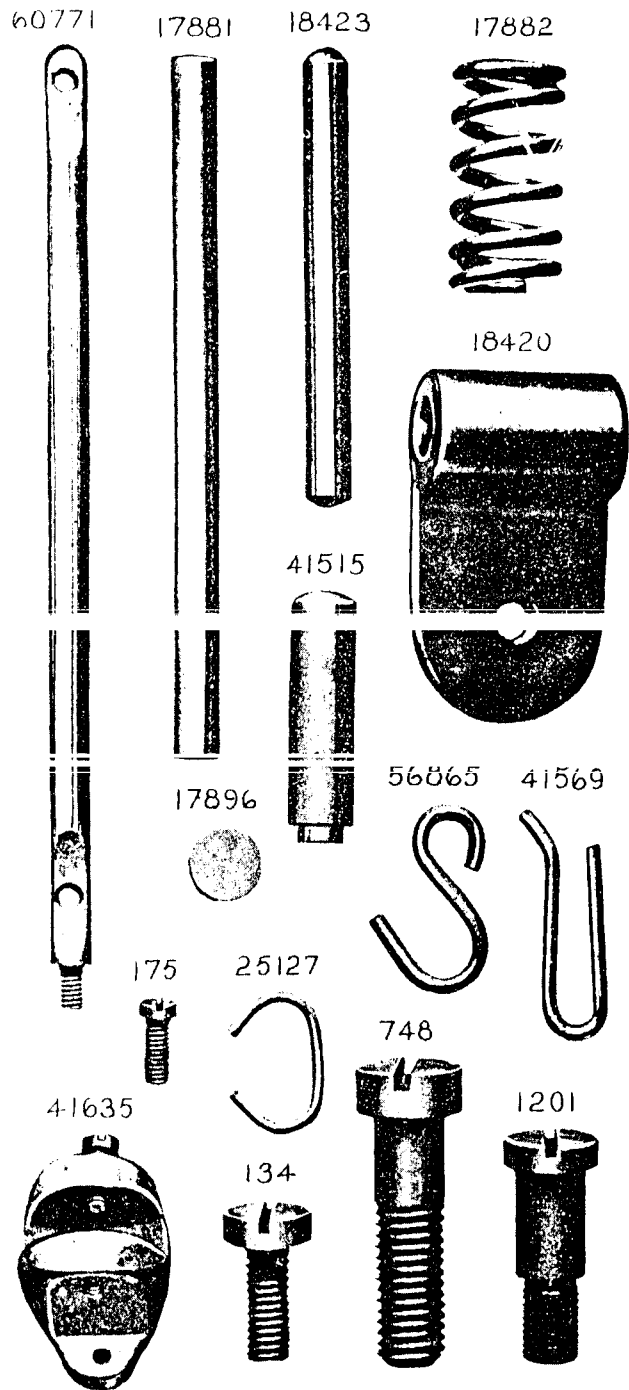

PLATE 7007—ONE-HALF SIZE

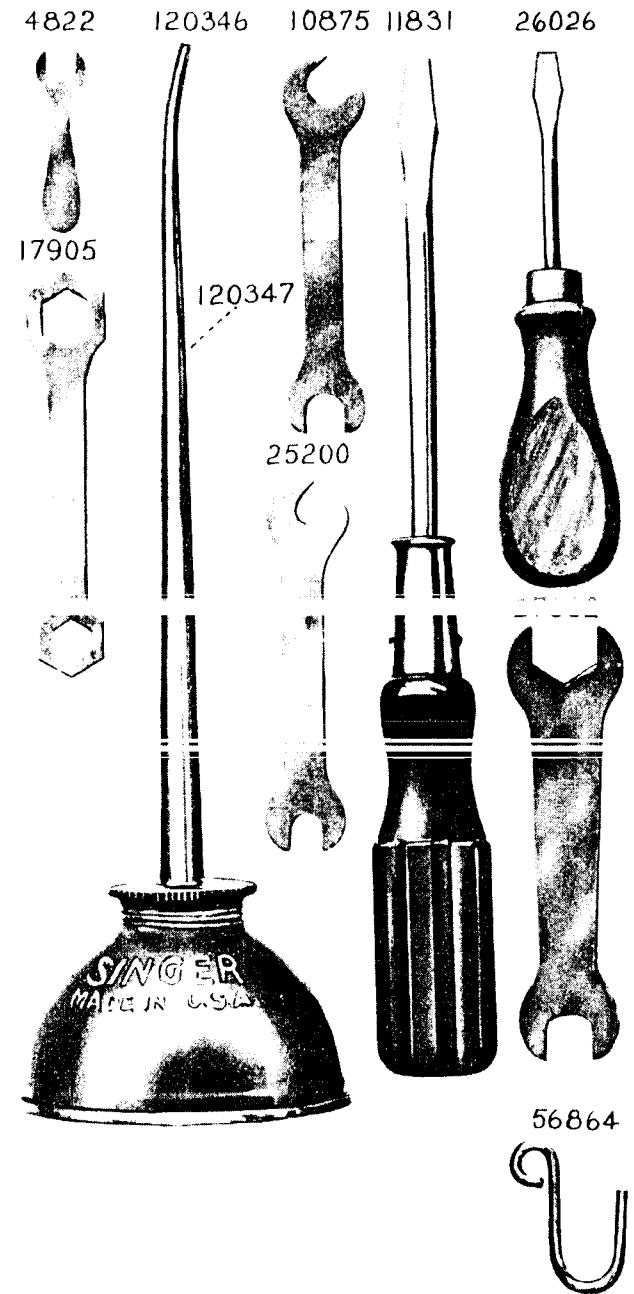

PLATE 7008--ONE-HALF SIZE

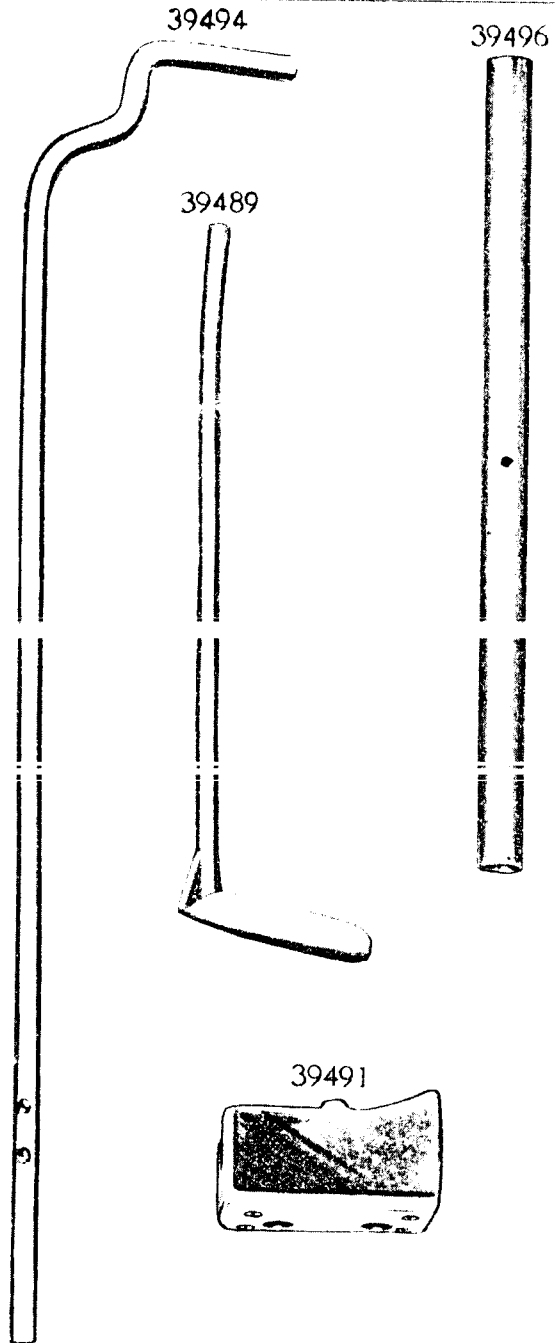

PLATE 7009--FULL SIZE

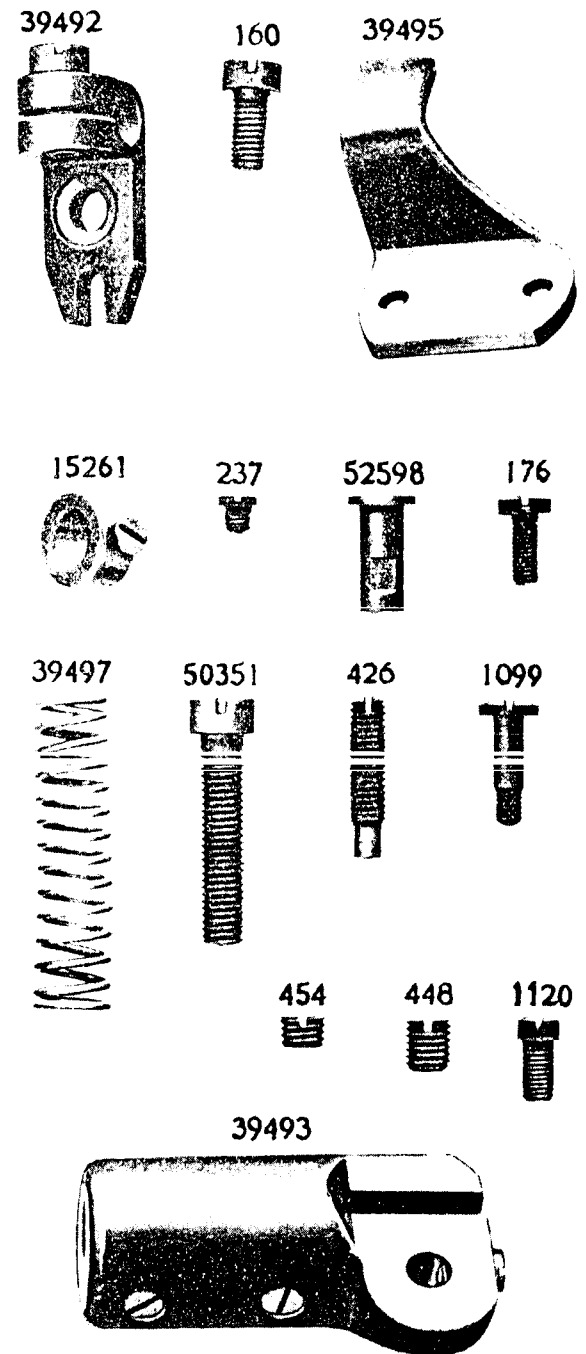

PLATE 7013—ONE-HALF SIZE

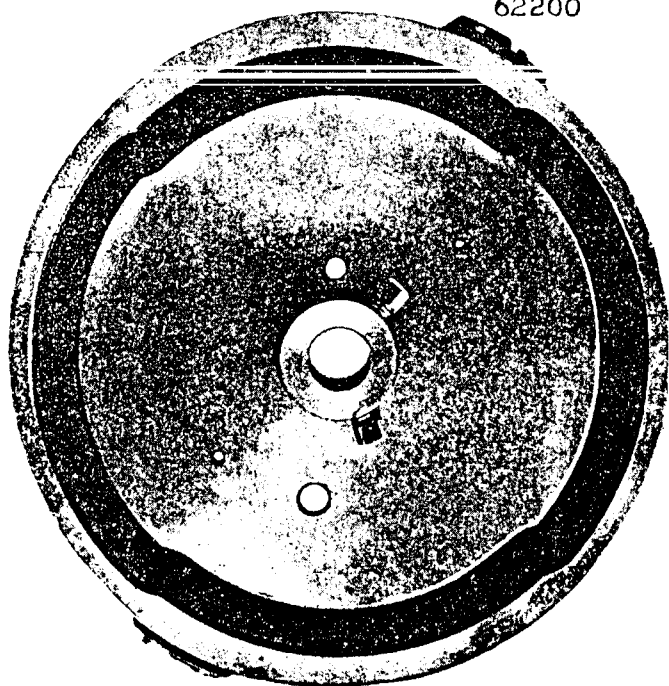
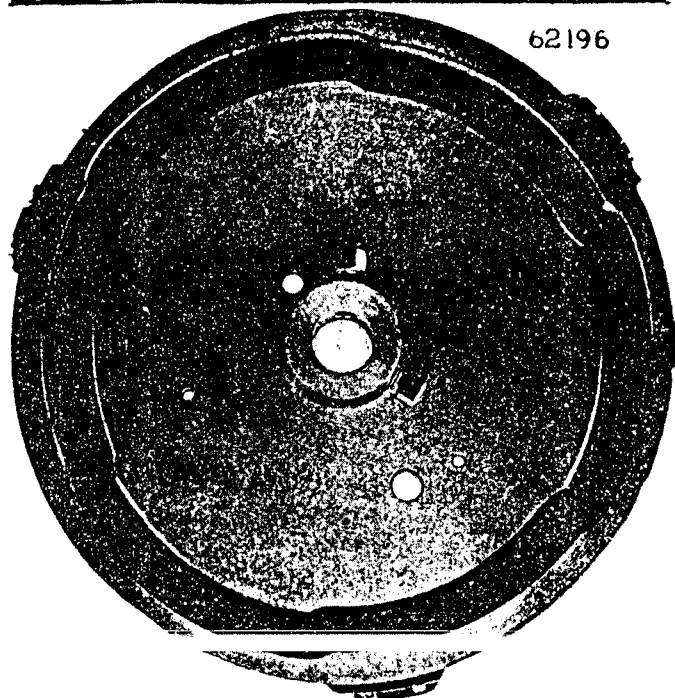
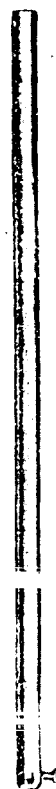

PLATE 7014—ONE-HALF SIZE

62198

62183



62195

120117



PLATE 7015—FULL SIZE

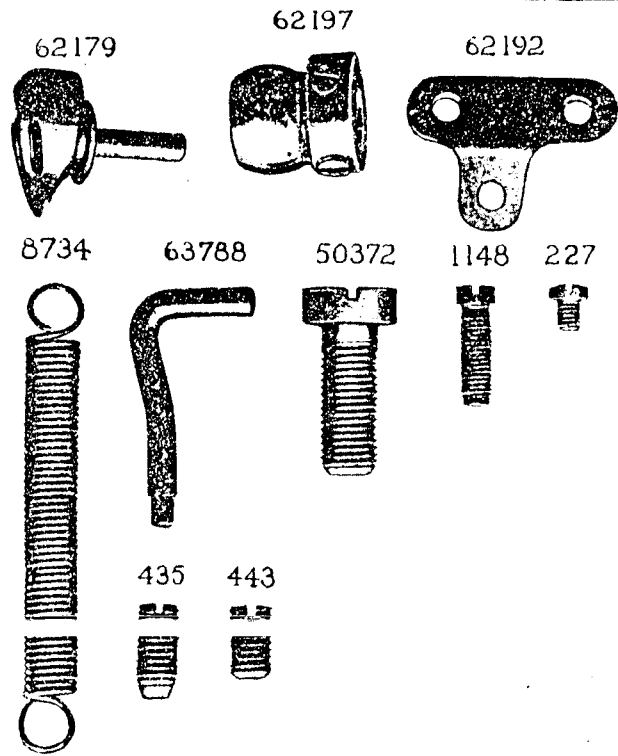

PLATE 7016—FULL SIZE

