

Form 20638
(153)
Printed in U. S. A.

HISTORICAL COPY

DO NOT REMOVE

LIST
OF
PARTS



SINGER
MACHINES

Nos. 251-1, 251-2 and 251-3

THE SINGER MANUFACTURING COMPANY

**A Trade Mark of THE SINGER MANUFACTURING COMPANY

INSTRUCTIONS FOR OILING

Before starting the machine, fill the oil reservoir in the base to the HIGH MARK with "TYPE A" or "TYPE C" OIL, sold by Singer Sewing Machine Company, as instructed in Form 20548.

The reservoir holds approximately 1½ pints.

When in operation, the oil level in the reservoir should be inspected at least twice a month or as often as is necessary to keep it from going below the LOW MARK in the reservoir. Refill to HIGH MARK with "TYPE A" OIL.

"TYPE C" OIL is to be used, when an oil is desired which will produce a minimum of stain, even after a long period of storage.

Copyright, U. S. A., 1939, 1941, 1947 and 1953 by
The Singer Manufacturing Company
All Rights Reserved for All Countries

INDEX

	Page
Accessories	16
Binders	16 To 18
Bobbin Winders	19 To 20
Corder (Adjustable)	20
Edge Folder on Shank	20
Edge Folder with Strip Folder on Shank	21
Edge Guide (Roller)	21
Face Plate Thread Lubricator	21
Finger Guards	21 To 22
Fittings	32 To 37
Hemmers	22 To 25
Knee Lifter	26
Machine 251-1	7
Machine 251-2	14
Machine 251-3	15
Machine Base and Oil Reservoir	26
Machine Base and Oil Reservoir Frame	26
Needle Threader	27
Numerical List of Parts	39
Piping Attachment	27
Presser Feet	27 To 29
Presser Feet for Slide Fasteners	29
Presser Foot and Extensions	28
Quilters	29
Rufflers	30
Strip Folder on Shank with Hemmer	31
Thread Unwinder	31
Tucker (Long Arm)	31

INSTRUCTIONS FOR ORDERING

In ordering from this list, use ONLY the part NUMBER in the FIRST column.

The number stamped on a Sewing Machine Part is in every case the number of the single part only.

Every combination of parts sent out as such has its specific number, which, although not stamped on the parts, must be used when ordering the combination.

Each number always indicates the SAME PART in whatever list it appears, or for whatever machine.

The letters after some of the numbers indicate the style of finish only, as follows:

- A—Hardened, Polished, Nickel Plated and Buffed
- A.A—Buffed and Chromium Plated
- A.B—Hardened, Polished, Buffed and Chromium Plated
- A.C—Brown Baking Enamel Finish
- A.D—Gray Baking Enamel Finish
- A.E—Hardened, Bright Rumbled and Nickel Plated
- A.F—Hardened, Bright Rumbled, Nickel Plated, Bright Rumbled and Chromium Plated
- A.G—Alumilite, Plain
- A.H—Alumilite, Dyed
- A.J—Polished, Nickel Plated and Chromium Plated
- A.K—Hardened, Polished, Nickel Plated and Chromium Plated
- A.L—Heat Treated for Toughness
 - B—Polished, Nickel Plated and Buffed
 - C—Hardened Only
- C.R—Hardened and Merlized
 - D—Polished Only
 - E—Soft, Not Polished
 - F—Hardened and Polished
- F.J—Hardened, Polished and Nickel Plated
 - G—Bright Rumbled and Nickel Plated
 - H—Blued
 - J—Nickel Plated Only
 - K—Hardened and Nickel Plated
 - L—Brass Plated
 - M—Oxidized
 - N—Japanned, Dull
 - P—Japanned, Bright
- P.P—Wrinkle Finish
 - R—Merlized
 - S—Cadmium Plated
 - T—Copper Plated
- T.A—Hardened, Polished, Copper and Nickel Plated and Buffed
- T.B—Copper and Nickel Plated and Polished
- T.J—Copper and Nickel Plated Only
- T.K—Hardened, Copper and Nickel Plated
- T.L—Copper and Brass Plated
- T.M—Copper Plated and Oxidized

INSTRUCTIONS FOR ORDERING—Continued

- U—Zinc Plated
- V—Silver Plated
- W—Polished and Nickel Plated
- X—Black Oxide, for Iron and Steel
- X.C—Hardened and Black Oxide, for Iron or Steel
- Y—Black Nickel Plated Only
- Z—Chromium Plated
- Z.A—Hardened, Polished, Nickel Plated, Buffed and Chromium Plated
- Z.B—Polished, Nickel Plated, Buffed and Chromium Plated
- Z.C—Hardened and Chromium Plated
- Z.D—Polished and Chromium Plated
- Z.G—Bright Rumbled, Nickel Plated, Bright Rumbled and Chromium Plated
- Z.J—Nickel and Chromium Plated
- Z.T—Copper and Chromium Plated

These letters MUST BE USED when they appear in the list; and AFTER the number as in the list.

In this series:

1 to 1500, 50001 to 51500 and 140001 to 142000 are Screw Numbers

1501 to 1800 and 51501 to 51800 are Nut Numbers

1801 to 2000 and 51801 to 52000 are Roller Numbers

2001 to 50000 and 52001 to 140000 and 142001 to 190000 are Sewing Machine Parts, 190001 and upward are numbers of Electrical Parts.

The figures in the second column refer only to the plates, illustrating the parts, and are NOT TO BE USED in ordering.

Parts marked with an asterisk (*) are furnished only when repairs are made at factory.

SINGER Needles should be used
in SINGER Machines
These Needles and their Containers
are marked with the
Company's Trade Mark "SIMANCO.**" ¹

Needles in Containers marked
"FOR SINGER MACHINES"
are NOT SINGER made needles. ²

LIST OF PARTS COMPLETE
FOR

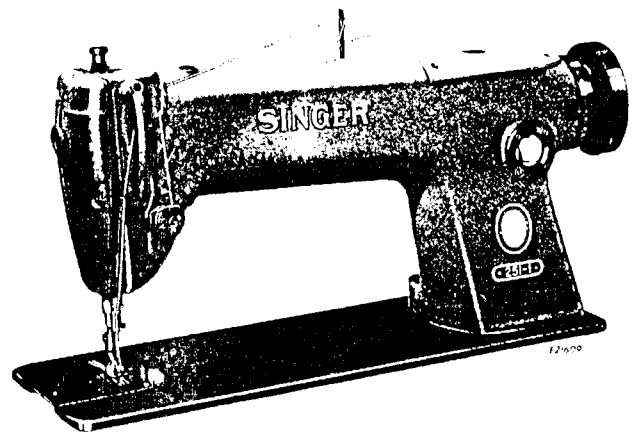

MACHINE No. 251-1

FOR SEWING LIGHT TO MEDIUM WEIGHT FABRICS, HIGH SPEED, LOCK STITCH, DROP FEED. NEEDLE BAR STROKE 1 9/64 INCHES. PRESSER BAR LIFT 9/32 INCH. MAXIMUM LENGTH OF STITCH 7 TO THE INCH. SPEED UP TO 5000 R.P.M., ACCORDING TO THE MATERIAL BEING STITCHED.

No.	Plate	Name
*147001	Arm	NOTE: Due to the accuracy required for gear alignment, Arm cannot be supplied separately and can only be sent out as a unit, Arm and Bed assembled.
8582	8214	Arm Dowell Pin (2)
143002	8214	Arm Hole Plug (top of arm) for plugging hole used to assemble take-up oil wicks
146552	8214	Arm Screw (back)
146552	8214	Arm Screw (front)
140315E	8214	Arm Screw Stud (back) (2)
147004	8214	Arm Shaft (horizontal) with Needle Bar Crank and 140640E
143008	8214	Arm Shaft (horizontal) Bushing (center)
140296AL	8214	Arm Shaft (horizontal) Bushing (center) Set Screw
147112	8214	Arm Shaft (horizontal) Flanged Bushing (back)
146790	8214	Arm Shaft (horizontal) Flanged Bushing (back) Oil Sump Tube
207E	8214	Arm Shaft (horizontal) Flanged Bushing (back) Oil Sump Tube Holder Screw
140297AL	8214	Arm Shaft (horizontal) Flanged Bushing (back) Set Screw
147005	8214	Arm Shaft (horizontal) Flanged Bushing (front)
140279AL	8214	Arm Shaft (horizontal) Flanged Bushing (front) Set Screw
144D	8214	Arm Shaft (horizontal) Screw (back)
140640E	8214	Arm Shaft (horizontal) Screw Plug (front)
147109	8214	Arm Shaft (horizontal) Screw Plug (front) Washer (fiber)

No.	Plate	Name
143013	8214	Arm Shaft (upright)
1259AL	8214	Arm Shaft (upright) Bevel Gear (lower) Set Screw (2)
1259AL	8214	Arm Shaft (upright) Bevel Gear (upper) Set Screw (2)
143016	8214	Arm Shaft (upright) Bushing (lower)
140298AL	8214	Arm Shaft (upright) Bushing (lower) Set Screw
147111	8214	Arm Shaft (upright) Bushing (upper)
50504C	8214	Arm Shaft (upright) Bushing (upper) Set Screw
147007	8217	Arm Side Shield
147008	8217	Arm Side Shield Wick
16709	8217	Arm Side Shield Wick Spring Holder
147010	8217	Arm Side Shield complete, Nos. 16709, 147007 and 147008
217X	8217	Arm Side Shield Screw (2)
52239	8219	Arm Spool Pin and Thread Eyelet
8879	8219	Arm Spool Pin Washer (cloth)
147011	8221	Arm Top Cover for 147013 (Aluminum)
147012	8222	Arm Top Cover for 147014 (Aluminum)
147013	Arm Top Cover with Stitch Regulator Plunger complete, Nos. 64519, 146511, 147011 and 147105
147014	Arm Top Cover with Stitch Regulator Plunger complete, when a longer Spool Pin (3-1/2 in. long) is required, Nos. 64519, 143244, 146511, 147012 and 147105
147015	8221	Arm Top Cover Gasket
51369R	8221	Arm Top Cover Screw (4)
143244	8222	Arm Top Cover Spool Pin with Spool Rest, 3-1/2 in. long
147105	8221	Arm Top Cover Stitch Regulator Plunger
140607X	8221	Arm Top Cover Stitch Regulator Plunger Hole Plug Screw for plugging the plunger hole when the Plunger is removed to prevent tampering with the stitch set
64519	8221	Arm Top Cover Stitch Regulator Plunger Spring
146511	8221	Arm Top Cover Stitch Regulator Plunger Stop Ring
*147017	Bed
NOTE: Due to the accuracy required for gear alignment, Bed cannot be supplied separately and can only be sent out as a unit, Arm and Bed assembled.		
143024	8214	Bed Hole Plug
143268	8214	Bed Leg (back)
1518J	8214	Bed Leg (back) Nut (2)
12431X	8223	Bed Slide
4307	8223	Bed Slide Spring
725X	8223	Bed Slide Spring Screw (2)
12432	8223	Bed Slide complete, Nos. 4307, 12431X and two 725X
143373	8219	Bell Crank
143374	8219	Bell Crank Bracket
158R	8219	Bell Crank Bracket Screw (2)
143104	8219	Bell Crank Hinge Pin
143375	Bell Crank complete, Nos. 143104, 143373 and 143374
143292	Combination of Feed and Stitch Regulator Parts, Nos. 143040, 143049, 143087, 143123, 143134, and 143294
147096	8226	Face Plate (Aluminum)
147019	8226	Face Plate Gasket
152J	8226	Face Plate Screw (lower) (3)
738J	8226	Face Plate Screw (upper)
147021	8227	Feed Bar with Slide Block and 147094
147115	Feed Bar 147021 with 147032
147022	8227	Feed Bar Carrier with two each 158E and 176E
158E	8227	Feed Bar Carrier Clamping Screw (2)
147023	8227	Feed Bar Carrier Hinge Pin
176E	8227	Feed Bar Carrier Hinge Pin Clamping Screw (2)
143031	8227	Feed Bar Carrier Oil Wick
143032	8227	Feed Bar Carrier Oil Wick Holder
147024	Feed Bar Carrier Oil Wick Holder 143032 with 143031

No.	Plate	Name
228E	8227	Feed Bar Carrier Oil Wick Holder Screw (2)
147094	8227	Feed Bar Slide Block Oil Wick
147034	8227	Feed Bar Slide Block Oil Wick for 147036
147035	8227	Feed Bar Slide Block Oil Wick Holder
147036	Feed Bar Slide Block Oil Wick Holder 147035 with 147034
50579J	8227	Feed Bar Slide Block Oil Wick Holder Screw
149031	8223	Feed Dog, 19 teeth (22 teeth to the inch) for 52033
50117AL	8223	Feed Dog Screw (2)
143123	8214	Feed Eccentric with 1375AL and two 1036AL
1375AL	8214	Feed Eccentric Body Position Screw
1036AL	8214	Feed Eccentric Body Set Screw (2)
140256AL	8214	Feed Eccentric Stop Screw (7 stitch)
140257AL	8214	Feed Eccentric Stop Screw (5-1/2 stitch)
140258AL	8214	Feed Eccentric Stop Screw (14 stitch)
NOTE: No. 140256AL is regularly furnished with this Machine.		
140333AL	8214	Feed Lifting Eccentric Position Screw
1259AL	8214	Feed Lifting Eccentric Set Screw
147025	8227	Feed Lifting Rock Shaft
147030	Feed Lifting Rock Shaft Nos. 197E, 140359E, 143236, 147025, 147038, 147039, 147047 and two 147037
143052	8227	Feed Lifting Rock Shaft and Feed Rock Shaft Oil Wick Holder
197E	8227	Feed Lifting Rock Shaft and Feed Rock Shaft Oil Wick Holder Screw
147028	8227	Feed Lifting Rock Shaft Bushing (2)
447AL	8227	Feed Lifting Rock Shaft Bushing Set Screw (2)
143039	8227	Feed Lifting Rock Shaft Cap
223E	8227	Feed Lifting Rock Shaft Cap Screw (2)
147029	8227	Feed Lifting Rock Shaft Collar with two 460AL (2)
460AL	8227	Feed Lifting Rock Shaft Collar Set Screw (4)
143040	8214	Feed Lifting Rock Shaft Connecting Rod
140230C	8214	Feed Lifting Rock Shaft Connecting Rod Hinge Screw
1518J	8214	Feed Lifting Rock Shaft Connecting Rod Hinge Screw Nut
147031	8227	Feed Lifting Rock Shaft Crank (back) with 966E
966E	8227	Feed Lifting Rock Shaft Crank (back) Clamping Screw
147032	8227	Feed Lifting Rock Shaft Crank (front) with 157J
157J	8227	Feed Lifting Rock Shaft Crank (front) Clamping Screw
140359E	8227	Feed Lifting Rock Shaft Oil Plug Screw
143236	8227	Feed Lifting Rock Shaft Oil Plug Screw Washer (fiber)
147038	8227	Feed Lifting Rock Shaft Oil Wick (long)
147037	8227	Feed Lifting Rock Shaft Oil Wick (short) (2)
147039	8227	Feed Lifting Rock Shaft Oil Wick
147047	8227	Feed Lifting Rock Shaft Oil Wick Clamping Plate
197E	8227	Feed Lifting Rock Shaft Oil Wick Clamping Plate Screw
147040	8227	Feed Rock Shaft
147041	Feed Rock Shaft Nos. 197E, 140359E, 143236, 147039, 147040, 147046, 147047 and two 147045
147042	8227	Feed Rock Shaft Bushing (back)
447AL	8227	Feed Rock Shaft Bushing (back) Set Screw
147043	8227	Feed Rock Shaft Bushing (front)
447AL	8227	Feed Rock Shaft Bushing (front) Set Screw
143048	8227	Feed Rock Shaft Cap
223E	8227	Feed Rock Shaft Cap Screw (2)
147029	8227	Feed Rock Shaft Collar with two 460AL
460AL	8227	Feed Rock Shaft Collar Set Screw (2)
143049	8214	Feed Rock Shaft Connecting Rod
140230C	8214	Feed Rock Shaft Connecting Rod Hinge Screw
1518J	8214	Feed Rock Shaft Connecting Rod Hinge Screw Nut
147044	8227	Feed Rock Shaft Crank with 157J
157J	8227	Feed Rock Shaft Crank Clamping Screw
140359E	8227	Feed Rock Shaft Oil Plug Screw
143236	8227	Feed Rock Shaft Oil Plug Screw Washer (fiber)
147046	8227	Feed Rock Shaft Oil Wick (long)

No.	Plate	Name
147045	8227	Feed Rock Shaft Oil Wick (short) (2)
147039	8227	Feed Rock Shaft Oil Wick
147047	8227	Feed Rock Shaft Oil Wick Clamping Plate
197E	8227	Feed Rock Shaft Oil Wick Clamping Plate Screw
147016	8221	Machine Driving Pulley, small rim diameter (disc power) "V" belt groove with two 51283AL, for regular work
		NOTE: No 147016 is regularly furnished with this Machine.
147110	8222	Machine Driving Pulley, large rim diameter (disc power) "V" belt groove, outside diam. of belt groove 2.9 in. with two 51283AL, for heavy work
51283AL	8221	Machine Driving Pulley Set Screw (2)
143335	8228	Needle Bar (hollow) with 140239AL
143336	8228	Needle Bar Bushing (lower)
1133E	8228	Needle Bar Bushing (lower) Set Screw
52171	8228	Needle Bar Bushing (lower) Thread Eyelet
143324	8228	Needle Bar Bushing (upper)
1133E	8228	Needle Bar Bushing (upper) Set Screw
147049	8228	Needle Bar Connecting Link
147050		Needle Bar Connecting Link 147049 with 143326
140231C	8228	Needle Bar Connecting Link Cap Screw
143056	8228	Needle Bar Connecting Link Roller Bearing (18)
143326	8228	Needle Bar Connecting Stud with 207E
207E	8228	Needle Bar Connecting Stud Clamping Screw
147053	8217	Needle Bar Connecting Stud Oil Wick
143058	8228	Needle Bar Connecting Stud Slide Block
140542AL	8214	Needle Bar Crank Position Screw
143196	8217	Needle Bar Oil Wick
140239AL	8228	Needle Set Screw
146591	8231	Oil Flow Body
143061	8231	Oil Flow Body Gasket (2)
143062	8231	Oil Flow Window
143063	8231	Oil Flow Window Cap
50257J	8231	Oil Flow Window Cap Screw (4)
143370	8231	Oil Lead
51369E	8231	Oil Lead Screw
143064	8231	Oil Pipe for 147106
143384	8231	Oil Pipe for oiling Rotating Hook Shaft (front) Bearing
143065	8231	Oil Pipe Clamping Sleeve
143066	8231	Oil Pipe Clamping Sleeve Nut
147106	8231	Oil Pipe complete from Oil Pump to Arm Shaft (horizontal) Center Bearing, Nos. 143064, 143065 and 143066
143387		Oil Pipe 143384 with 143124 for oiling Rotating Hook Shaft Front Bearing
143124	8231	Oil Pipe Clamping Sleeve
143125	8231	Oil Pipe Clamping Sleeve Nut
143126	8231	Oil Pipe Clamping Sleeve Nut Adaptor for 143070
143070	8231	Oil Pump (centrifugal) Body with 143126
143071	8231	Oil Pump (centrifugal) Body Position Pin (2)
157E	8231	Oil Pump (centrifugal) Body Screw (3)
143072	8231	Oil Pump (centrifugal) Cover
143073	8231	Oil Pump (centrifugal) Impeller
50123E	8214	Oil Pump (centrifugal) Impeller Locking Screw
143074	8231	Oil Pump (centrifugal) Screen
143075	8231	Oil Pump (centrifugal) Screen Frame
189E	8231	Oil Pump (centrifugal) Screen Frame Screw (4)
147107	8217	Oil Removing Wick (head end)
146745	8217	Oil Removing Wick (head end) Holder Body
147108		Oil Removing Wick (head end) Holder Body 146745 with 146698 and 147107
140553E	8217	Oil Removing Wick (head end) Holder Body Hinge Screw
146700	8217	Oil Removing Wick (head end) Holder Body Stop and Spring Clip
228E	8217	Oil Removing Wick (head end) Holder Body Stop and Spring Clip Screw

No.	Plate	Name
146698	8217	Oil Removing Wick (head end) Holder Body Spring
147054	8217	Oil Removing Wick (head end) Hinge Plate and Cover
147055	8217	Oil Removing Wick (head end) Hinge Plate and Cover Gasket
1364X	8217	Oil Removing Wick (head end) Hinge Plate and Cover Screw (4)
147056	8217	Oil Removing Wick (head end) Holder Body complete, Nos. 228E, 140553E, 146698, 146700, 146745, 147054 and 147107
143197	8214	Oil Wick, for oiling Take-up Lever, Needle Bar Connecting Link, Take-up Link and Take-up Lever Hinge Bearing
143077	8214	Oil Wick Holder complete, Nos. 143197 and 143200
140232J	8214	Oil Wick Holder Screw
143200	8214	Oil Wick Oil Leader (wick)
147057	8228	Presser Bar (hollow)
147058	8228	Presser Bar Bushing (lower)
1133E	8228	Presser Bar Bushing (lower) Set Screw
147059	8228	Presser Bar Guide Bracket with 208AL and 140608AL
140608AL	8228	Presser Bar Guide Bracket Clamping Screw
147060	8219	Presser Bar Lifter
	8219	Presser Bar Lifter Hinge Screw
147027	8219	Presser Bar Lifting Lever with 448AL
143108	8219	Presser Bar Lifting Lever Connecting Rod
1611J	8219	Presser Bar Lifting Lever Connecting Rod Nut
1611J	8219	Presser Bar Lifting Lever Connecting Rod Nut Lock Nut
143191	8219	Presser Bar Lifting Lever Connecting Rod Oil Mist Retaining Disc (felt)
143109	8219	Presser Bar Lifting Lever Connecting Rod Swivel
802X	8219	Presser Bar Lifting Lever Hinge Screw
147061	8228	Presser Bar Lifting Lever Link
147062	8219	Presser Bar Lifting Lever Pin
448AL	8219	Presser Bar Lifting Lever Pin Set Screw
146610	8219	Presser Bar Lifting Lever Spring
147063	8228	Presser Bar Spring
62527	8223	Presser Foot Hinge Pin
62925	8223	Presser Foot Plate
62926	8223	Presser Foot Shank
26231	8223	Presser Foot Spring
62927	8223	Presser Foot (spring hinged) complete, Nos. 26231, 62527, 62925 and 62926
140390AL	8223	Presser Foot Screw
147091	8228	Pressure Regulating Thumb Screw and Presser Bar Guide
143340	8232	Rotating Hook with 143301 and three 1253AL
143341	8232	Rotating Hook 143340 with 143351, 270083 and four 1053E
143342	8232	Rotating Hook 143341 with 40274, 143346 and three 1367E
143343		Rotating Hook 143341 with 40274 and three 1367E
143344	8232	Rotating Hook 143342 with 52237
40264	8232	Rotating Hook Bobbin
52235	8232	Rotating Hook Bobbin Case
52236		Rotating Hook Bobbin Case 52235 with 591F, 1380E and 40394
40392	8232	Rotating Hook Bobbin Case Latch
125320	8232	Rotating Hook Bobbin Case Latch Lever
2974	8232	Rotating Hook Bobbin Case Latch Lever Fulcrum Pin
2975	8232	Rotating Hook Bobbin Case Latch Spring
592E	8232	Rotating Hook Bobbin Case Latch Stop Screw
40393	8232	Rotating Hook Bobbin Case Latch Hinge, Nos. 2974, 40392 and 125320
591F	8232	Rotating Hook Bobbin Case Tension Regulating Screw
40394	8232	Rotating Hook Bobbin Case Tension Spring
1380E	8232	Rotating Hook Bobbin Case Tension Spring Screw

No.	Plate	Name
52237	8232	Rotating Hook Bobbin Case complete, Nos. 592E, 2975, 40393 and 52236
143345	Rotating Hook Bobbin Case 52237 with 143346
143346	8232	Rotating Hook Bobbin Case Holder
147064	8232	Rotating Hook Bobbin Case Holder Position Bracket
704J	8232	Rotating Hook Bobbin Case Holder Position Bracket Screw
140551C	8232	Rotating Hook Oil Flow Regulating Thumb Screw
143383	8232	Rotating Hook Oil Flow Regulating Thumb Screw Spring
233E	8232	Rotating Hook Oil Flow Regulating Thumb Screw Spring Screw
143301	8232	Rotating Hook Oil Wick (felt)
40274	8232	Rotating Hook Section
1367E	8232	Rotating Hook Section Screw (3)
1253AL	8232	Rotating Hook Set Screw (3)
143347	8232	Rotating Hook Shaft with 143350
143348	Rotating Hook Shaft 143347 with 143133
1259AL	8232	Rotating Hook Shaft Bevel Gear Set Screw (2)
143082	8232	Rotating Hook Shaft Bushing (back)
140259AL	8232	Rotating Hook Shaft Bushing (back) Set Screw
143382	8232	Rotating Hook Shaft Bushing (front)
1285AL	8232	Rotating Hook Shaft Bushing (front) Set Screw
143042	8232	Rotating Hook Shaft Oil Filter Wick
143349	8232	Rotating Hook Shaft Oil Filter Wick Holder
143350	8232	Rotating Hook Shaft Oil Filter complete, Nos. 143042 and 143349
143133	8232	Rotating Hook Shaft Oil Retainer Collar with two 50429AL
50429AL	8232	Rotating Hook Shaft Oil Retainer Collar Set Screw (2)
270083	8232	Rotating Hook Thread Guard
1053E	8232	Rotating Hook Thread Guard Screw (4)
143351	8232	Rotating Hook Wiper
147066	8233	Set of Mated Gears complete for Lower Shaft, consisting of Arm Shaft (upright) Bevel Gear (upper) left hand spiral and Rotating Hook Shaft Bevel Gear, left hand spiral
143294	8233	Set of Mated Gears complete for Upper Shaft, consisting of Arm Shaft (upright) Bevel Gear (lower) right hand spiral and Feed Lifting Eccentric and Arm Shaft (horizontal) Bevel Gear, right hand spiral
147067	8228	Slack Thread Regulator
208AL	8228	Slack Thread Regulator Set Screw
147092	8221	Stitch Length Indicator Plate
402J	8221	Stitch Length Indicator Plate screw
143085	8214	Stitch Regulator
143134	Stitch Regulator 143085 with 140549E, 143086 and 143378
143086	8214	Stitch Regulator Locking Slide
143087	8214	Stitch Regulator Locking Slide Ratchet Wheel
143088	8214	Stitch Regulator Locking Slide Ratchet Wheel Pin
143378	8214	Stitch Regulator Locking Slide Spring
140549E	8214	Stitch Regulator Locking Slide Spring Screw
2102	8219	Tension Disc (2)
1560C	8219	Tension Regulating Thumb Nut
32572	8219	Tension Releasing Disc
147068	8219	Tension Releasing Lever
12398	8219	Tension Releasing Lever Hinge Pin
32574	8219	Tension Releasing Pin
12329	8219	Tension Releasing Spring
2103	8219	Tension Spring
50304C	8219	Tension Stud
52098	Tension Stud 50304C with 1560C
50305C	8219	Tension Stud Set Screw
52397	8219	Tension complete, Nos. 2103, 32572, 32574, 52083, 52098, 52394 and two 2102
147090	8219	Thread Eyelet (side of arm)

No.	Plate	Name
147069	8219	Thread Guard (side of arm)
52454	8219	Thread Retainer
624AL	8219	Thread Retainer Set Screw
147089	8228	Thread Take-up complete, Nos. 143098, 147075, 147080, 147093 and eighteen 143056
143093	8228	Thread Take-up Crank
147093	Thread Take-up Crank 143093 with 140231C, 143058, 147050 and eighteen 143056
140609AL	8214	Thread Take-up Crank Clamping Screw
147070	8214	Thread Take-up Crank Clamping Screw Hole Plug Gasket
140610X	8214	Thread Take-up Crank Clamping Screw Hole Plug Screw
1036AL	8214	Thread Take-up Crank Set Screw
143241	8214	Thread Take-up Crank Wearing Plate
147100	8228	Thread Take-up Lever with 147079
14.071	Thread Take-up Lever 147100 with 143093, 143098 and eighteen 143056
147076	8226	Thread Take-up Lever Guard
147077	8226	Thread Take-up Lever Guard Gasket
152X	8226	Thread Take-up Lever Guard Screw (2)
52023	8228	Thread Take-up Lever Hinge Stud
147072	8228	Thread Take-up Lever Link
147073	8228	Thread Take-up Lever Link Hinge Stud
147074	8228	Thread Take-up Lever Link Hinge Stud Oil Wick
435AL	8228	Thread Take-up Lever Link Hinge Stud Set Screw
147075	Thread Take-up Lever Link Hinge Stud 147073 with 147074
147078	8217	Thread Take-up Lever Oil Guard with 143196 and 147053
217E	8217	Thread Take-up Lever Oil Guard Screw
143056	8228	Thread Take-up Lever Roller Bearing (18)
143098	8228	Thread Take-up Lever Roller Bearing Retaining Washer
147079	8228	Thread Take-up Lever Thread Eyelet Bushing
147080	Thread Take-up Lever complete, Nos. 52023, 147072 and 147100
52394	8219	Thread Take-up Spring
52083	8219	Thread Take-up Spring Regulator with 50305C
448AL	8219	Thread Take-up Spring Regulator Set Screw
52032XC	Throat Plate (large needle hole) for 149031
52033XC	8223	Throat Plate (small needle hole) for 149031
691XC	8223	Throat Plate No. 52033 is sent with this Machine unless otherwise specified.
	8223	Throat Plate Screw (2)

SINGER Needles should be used
in SINGER Machines
These Needles and their Containers
are marked with the
Company's Trade Mark "SIMANCO.**" 1

Needles in Containers marked
"FOR SINGER MACHINES"
are NOT SINGER made needles. 2

MACHINE No. 251-2

FOR SEWING LIGHT TO MEDIUM HEAVY FABRICS. HIGH SPEED, LOCK STITCH, DROP FEED. NEEDLE BAR STROKE 1 13/64 INCHES. PRESSER BAR LIFT 5/16 INCH. MAXIMUM LENGTH OF STITCH 5 1/2 TO THE INCH. SPEED UP TO 5000 R.P.M., ACCORDING TO THE MATERIAL BEING STITCHED.

This Machine is the same as the 251-1 Machine,
with the following exceptions:

No.	Plate	Name
147082	8215	Arm Shaft (horizontal) with Needle Bar Crank and 140640E, in place of 147004
147085	8218	Arm Side Shield, in place of 147007
147086	8218	Arm Side Shield complete, Nos. 16709, 147008 and 147085, in place of 147010
149319	8224	Feed Dog, 19 teeth (16 teeth to the inch) for 127320 and 127321, in place of 149031
140257AL	8215	Feed Eccentric Stop Screw (5½ stitch) in place of 140256AL
143321	8229	Needle Bar (hollow) in place of 143335
143322	Needle Bar 143321 with 143386, for size 16 x 257 needle
147113	8229	Needle Bar Bushing (lower) in place of 143336
147114	8229	Needle Bar Bushing (lower) Thread Eyelet, in place of 52171
143327	8229	Needle Bar Thread Guard for 143386
665J	8229	Needle Bar Thread Guard Screw for 143386
143386	Needle Clamp 143328 with 665J and 143327
143328	8229	Needle Clamp with 140119AL, for 143386
140119AL	8229	Needle Clamp Screw for 143328
143151	8215	Oil Wick Holder complete, Nos. 143197 and 143200, in place of 143077
7298	8224	Presser Foot Hinge Pin for 19336
19334	8224	Presser Foot Plate for 19336
19335	8224	Presser Foot Shank for 19336
19336	8224	Presser Foot (hinged) complete, Nos. 7298, 19334 and 19335, in place of 62927
127320XC	Throat Plate (large needle hole) for 149319 in place of 52032
NOTE: Throat Plate No. 127320 is sent with this Machine unless otherwise specified.		
127321XC	8224	Throat Plate (small needle hole) for 149319 in place of 52033

MACHINE No. 251-3

FOR SEWING LIGHT TO HEAVY WEIGHT FABRICS. HIGH SPEED, LOCK STITCH, DROP FEED. NEEDLE BAR STROKE 1 7/16 INCHES. PRESSER BAR LIFT 3/8 INCH. MAXIMUM LENGTH OF STITCH 5 1/2 TO THE INCH. SPEED UP TO 4300 R.P.M., ACCORDING TO THE MATERIAL BEING STITCHED.

This Machine is the same as the 251-1 Machine,
with the following exceptions:

No.	Plate	Name
147082	8216	Arm Shaft (horizontal) with Needle Bar Crank and 140640E, in place of 147004
147085	8218	Arm Side Shield, in place of 147007
147086	8218	Arm Side Shield complete, Nos. 16709, 147008 and 147085, in place of 147010
149174	8225	Feed Dog, 17 teeth (14 teeth to the inch) for 143175, in place of 149031
140257AL	8216	Feed Eccentric Stop Screw (5½ stitch) in place of 140256AL
143321	8230	Needle Bar (hollow) in place of 143335
143322	Needle Bar 143321 with 143386, for size 16 x 257 needle
147113	8230	Needle Bar Bushing (lower) in place of 143336
147114	8230	Needle Bar Bushing (lower) Thread Eyelet, in place of 52171
143327	8230	Needle Bar Thread Guard for 143386
665J	8230	Needle Bar Thread Guard Screw for 143386
143386	Needle Clamp 143328 with 665J and 143327, for 143322
143328	8230	Needle Clamp with 140119AL, for 143386
140119AL	8230	Needle Clamp Screw
143147	8216	Oil Wick Holder complete, Nos. 143197 and 143200, in place of 143077
62527	8225	Presser Foot Pin for 127234
127233	8225	Presser Foot Plate for 127234
52390	8225	Presser Foot Shank for 127234
26231	8225	Presser Foot Spring for 127234
127234	8225	Presser Foot (spring hinged) complete, Nos. 26231, 52390, 62527 and 127233, in place of 62927
147087	8220	Tension Releasing Lever, in place of 147068
147098	8230	Thread Take-up complete, Nos. 143098, 147075, 147080, 147099 and eighteen 143056, in place of 147089
143246	8230	Thread Take-up Crank, in place of 143093
147099	Thread Take-up Crank 143246 with 140231C, 143058, 147050 and eighteen 143056, in place of 147093
147097	Thread Take-up Lever 147100 with 143098, 143246 and eighteen 143056, in place of 147071
143175XC	8225	Throat Plate for 149174, in place of 52033

Binder (Transverse) with Throw-out Arm

For Folded or Unfolded Bias Binding

(with tape reel)

For General Work

for 3/4 in., 7/8 in. and 1 in. Tape

No.	Plate	Name
121732	8237	Binder (transverse).....
121735	8237	Binder Releasing Lever.....
724F	8237	Binder Releasing Lever Hinge Screw.....
121736	8237	Binder Releasing Lever Spring.....
192349	8237	Binder Releasing Lever Spring Position Stud.....
1443J	8237	Binder Screw (2).....
121733	8237	Binder Throw-out Arm with 192349.....
124964	8237	Binder Throw-out Arm Bracket Rivet (2).....
940F	8237	Binder Throw-out Arm Hinge Screw.....
35610	8237	Binder Washer.....
149738	8237	Feed Dog, 17 teeth (16 teeth to the inch).....
121169	8237	Presser Foot.....
120536	8237	Tape Reel Disc with 120538 and 120539.....
120538	8237	Tape Reel Disc Stud (wood).....
120539	8237	Tape Reel Disc Stud Sleeve (brass).....
120740	8237	Tape Reel Pin 120775 with 42290.....
120775	8237	Tape Reel Pin.....
42290	8237	Tape Reel Pin Washer.....
121938XC	8237	Throat Plate with two 124964.....
121737	8237	Binder (transverse) with Throw-out Arm complete, for 3/4 in., 7/8 in. and 1 in. tape, Nos. 724F, 940F, 35610, 120536, 120740, 121169, 121732, 121733, 121735, 121736, 121938XC, 149738 and two 1443J.....

Binder and Piping Attachment

120532	22920	Binder (transverse) on Shank.....
51097J	22920	Binder (transverse) on Shank Thumb Screw.....
3146	22920	Binder (transverse) on Shank Thumb Screw Washer.....
149603	22920	Feed Dog, 20 teeth (16 teeth to the inch) for 120741.....
120737	22920	Piping Attachment with 217J.....
217J	22920	Piping Attachment Adjusting Screw.....
190J	22920	Piping Attachment Screw (2).....
7071	22920	Piping Attachment Screw Washer (2).....
120738	22920	Presser Foot.....
120739	22920	Tape Guide.....
120535	22920	Tape Reel Arm with 23263 and 120537.....
23263	22920	Tape Reel Arm Pin.....
51097J	22920	Tape Reel Arm Thumb Screw.....
120536	22920	Tape Reel Disc with 120538 and 120539 (2).....
120537	22920	Tape Reel Disc Pin.....
120538	22920	Tape Reel Disc Stud (wood) (2).....
120539	22920	Tape Reel Disc Stud Sleeve (brass) (2).....
120775	22920	Tape Reel Pin.....
120740	22920	Tape Reel Pin 120775 with 42290.....
42290	22920	Tape Reel Pin Washer.....
120741XC	22920	Throat Plate with 43525.....
43525	22920	Throat Plate Stud.....
120742	22920	Binding and Piping Attachment complete, Nos. 3146, 120532, 120535, 120737, 120738, 120739, 120740, 120741XC, 149603 and two each 190J, 7071, 51097J and 120536.....

BOBBIN WINDERS**Bobbin Winder**

(Swinging Automatic Right Hand)

For Power Table

For "V" Belt Drive

No.	Plate	Name
259428	23253	Brake (leather).....
259429	23253	Brake Clamp.....
200113F	23253	Brake Clamp Screw.....
259662	23253	Bobbin Winder and Tension Bracket Base.....
225453	23253	Frame with 202277 and 259660.....
225454	23253	Frame Hinge Pin.....
202277	23253	Frame Oil Packing (wick).....
259660	23253	Frame Oil Well Washer.....
225455	23253	Frame Spring.....
225456	23253	Frame Spring Plunger.....
259461	23253	Pulley with 200380C.....
200380C	23253	Pulley Set Screw.....
225381	23253	Spindle.....
225444	23253	Stop Latch.....
200056E	23253	Stop Latch Screw.....
225458	23253	Stop Latch Thumb Lever.....
225459	23253	Stop Latch Thumb Lever Hinge Stud.....
225459	23253	Stop Latch Thumb Lever Joint Stud.....
202478	23253	Stop Latch Trip Lever.....
200299B	23253	Stop Latch Trip Lever Hinge Screw.....
225461	23253	Tension Bracket with 201499B.....
200082D	23253	Tension Bracket Screw.....
228026	23253	Tension Bracket Screw Washer.....
2102	23253	Tension Disc (2).....
13710	23253	Tension Spring.....
201499B	23253	Tension Stud.....
201572B	23253	Tension Stud Thumb Nut.....
225462	23253	Tension Bracket complete, Nos. 13710, 201572B, 225461 and two 2102.....
259462	23253	Bobbin Winder complete, for "V" belt, Nos. 200056E, 200082D, 200113F, 200299B, 202478, 225381, 225444, 225453, 225454, 225455, 225456, 225458, 225462, 228026, 259428, 259429, 259461, 259662 and two each 225459 and wood screws 3/4 in. No. 12 R.H.....

Bobbin Winder

(For Round Belt)

259428	23253	Brake (leather).....
259429	23253	Brake Clamp.....
200113F	23253	Brake Clamp Screw.....
259430	23253	Bobbin Winder and Tension Bracket Base.....
225453	23253	Frame with 202277 and 259660.....
225454	23253	Frame Hinge Pin.....
202277	23253	Frame Oil Packing (wick).....
259660	23253	Frame Oil Well Washer.....
225455	23253	Frame Spring.....
225456	23253	Frame Spring Plunger.....
225368	23253	Pulley with 200380C.....
200380C	23253	Pulley Set Screw.....
225381	23253	Spindle.....
225444	23253	Stop Latch.....

No.	Plate	Name
200056E	23253	Stop Latch Screw
225458	23253	Stop Latch Thumb Lever
225459	23253	Stop Latch Thumb Lever Hinge Stud
225459	23253	Stop Latch Thumb Lever Joint Stud
202478	23253	Stop Latch Trip Lever
200299B	23253	Stop Latch Trip Lever Hinge Screw
225461	23253	Tension Bracket with 201499B
200082D	23253	Tension Bracket Screw
228026	23253	Tension Bracket Screw Washer
2102	23253	Tension Disc (2)
13710	23253	Tension Spring
201499B	23253	Tension Stud
201572B	23253	Tension Stud Thumb Nut
225462	23253	Bobbin Winder Tension Bracket complete, Nos. 13710, 201572B, 225461 and two 2102
259431	23253	Bobbin Winder complete, Nos. 200056E, 200082D, 200113F, 200299B, 202478, 225368, 225381, 225444, 225453, 225454, 225455, 225456, 225458, 225462, 228026, 259428, 259429, 259430 and two each 225459 and wood screws 3/4 in. No. 12 R.H.B.

CORDER (ADJUSTABLE)

For Short Turns or Cushions

When Ordering State Size or Furnish Sample Cord

26795	23228	Cord Guide
26796	23228	Cord Guide Arm
1044D	23228	Cord Guide Arm Hinge Screw
120206	23228	Cord Guide Bed with 457AL
457AL	23228	Cord Guide Bed Leveling Screw
190J	23228	Cord Guide Screw
120207	23228	Corder complete, Nos. 190J, 1044D, 26795, 26796 and 120206
149446	23228	Feed Dog, spiked teeth, 13 teeth (10 teeth to the inch) for 121447
120208	23228	Presser Foot (grooved)
121447XC	23228	Throat Plate for 149446

EDGE FOLDERS**Edge Folder on Shank**

For Collar Banding

35175	23300	Edge Folder on Shank
149450	23300	Feed Dog, 11 teeth (18 teeth to the inch) for 12464
35176	23300	Presser Foot
12464XC	23300	Throat Plate (large needle hole) for 149450

Edge Folder with Strip Folder on Shank

For French Button Facing

For No. 251-1 Machine

No.	Plate	Name
160335	8238	Edge Folder with Strip Folder on Shank
160336	8238	Feed Dog, 15 teeth (16 teeth to the inch) for 160341
160337	8238	Presser Foot Edge Guide (left hand)
337J	8238	Presser Foot Edge Guide (left hand) Screw (2)
26276		Presser Foot Hinge Pin
160338	8238	Presser Foot Marker Guide (right hand)
337J	8238	Presser Foot Marker Guide (right hand) Screw (2)
160339	8238	Presser Foot Plate
160406	8238	Presser Foot Shank
2656		Presser Foot Spring
160340	8238	Presser Foot (spring hinged) complete, Nos. 2656, 26276, 160337, 160338, 160339, 160406 and four 337J
160341XC	8238	Throat Plate, for 160336

EDGE GUIDE (ROLLER)

36185	23300	Edge Guide Arm with 1988
36186	23300	Edge Guide Arm Friction Washer
1425D	23300	Edge Guide Arm Hinge Screw
1988	23300	Edge Guide Arm Roller and Screw Stud
36187	23300	Edge Guide Bed with four 465F
465F	23300	Edge Guide Bed Leveling Screw (4)
36188	23300	Edge Guide (roller) complete, Nos. 1425D, 36185, 36186 and 36187

FACE PLATE THREAD LUBRICATOR

241755	8239	Face Plate Thread Lubricator Oil Pad (felt)
147119	8239	Face Plate Thread Lubricator Oil Pad Holder
147116		Face Plate Thread Lubricator Oil Pad 147119 with 62827, 24039 and 241755
240439	8239	Face Plate Thread Lubricator Oil Pad Retainer
17822	8239	Face Plate Thread Lubricator Oil Reservoir Rivet
8068	8239	Face Plate Thread Lubricator Oil Reservoir Rivet Washer (inside)
124371	8239	Face Plate Thread Lubricator Oil Reservoir Rivet Washer (outside)
62827	8239	Face Plate Thread Lubricator Oil Wick
147117	8239	Face Plate Thread Lubricator complete, Nos. 7071, 8068, 17822, 124371 and 147116
147118	8239	Face Plate Thread Lubricator 147117 with 738J and 143264
143264	8239	Face Plate Thread Lubricator Adaptor
738J	8239	Face Plate Thread Lubricator Adaptor Screw
7071	8239	Face Plate Thread Lubricator Adaptor Screw Washer

FINGER GUARDS

121326	23227	Finger Guard
36819	23227	Finger Guard Friction Washer
36820	23227	Finger Guard Holder with 196J
196J	23227	Finger Guard Holder Set Screw

No.	Plate	Name
26605XC	23255	Throat Plate (large needle hole) for 149603
26606XC	Throat Plate (small needle hole) for 149603, for 251-2 and 251-3 Machines
120991	23255	Hemmer on Shank, for 1/16 in. to 1/4 in. hem
120367	23255	Hemmer on Shank for handkerchief work, for 1/16 in. to 1/4 in. hem

For Hemming Bottoms of Pajamas and Shorts

For No. 251-1 Machine

149603	8240	Feed Dog, 20 teeth (16 teeth to the inch) for 26605
160325	8240	Hemmer on Shank
28972	8240	Hemmer on Shank Holder
35610	8240	Hemmer on Shank Holder Friction Washer
940W	8240	Hemmer on Shank Holder Hinge Screw
120427	8240	Hemmer on Shank Holder Shank
51224W	8240	Hemmer on Shank Thumb Screw
7071	8240	Hemmer on Shank Thumb Screw Washer
160326	8240	Hemmer on Shank (adjustable hinged) complete, for 3/8 in. to 5/8 in. hem, Nos. 940W, 7071, 28972, 35610, 51224W, 120427 and 160325
NOTE: When ordering No. 160326, size of hem must be stated.		
26276	8240	Presser Foot Hinge Pin
160322	8240	Presser Foot Plate
160323	8240	Presser Foot Shank
160324	8240	Presser Foot (hinged) complete, Nos. 26276, 160322 and 160323
26605XC	8240	Throat Plate (large needle hole) for 149603

For Hemming Handkerchiefs and Slips

149163	24353	Feed Dog, 16 teeth (16 teeth to the inch) for 143277
62527	24353	Presser Foot Hinge Pin
160328	24353	Presser Foot Plate
160329	24353	Presser Foot Shank
26231	Presser Foot Spring
160330	24353	Presser Foot (spring hinged) complete, Nos. 26231, 62527, 160328 and 160329
160327	24353	Scroll Hemmer on Shank, for 1/8 in. hem
143277XC	24353	Throat Plate (small needle hole) for 149163

For Hemming Pillow Cases

149603	23233	Feed Dog, 20 teeth (16 teeth to the inch) for 26605 and 26606
121665	23233	Hemmer Scroll (lower) on Shank with 337B, 36696 and 121667
121667	23233	Hemmer Scroll (lower) Spring
36696	23233	Hemmer Scroll (lower) Spring Lock Pin
337B	23233	Hemmer Scroll (lower) Spring Position Screw
121666	23233	Hemmer Scroll (upper)
121668	23233	Hemmer on Shank complete, for 3/4 in. to 2 in. hem, Nos. 121665 and 121666
121669	23233	Hemmer Scroll (lower) on Shank with 337B, 36696 and 121667

No.	Plate	Name
121670	23233	Hemmer Scroll (upper)
121671	23233	Hemmer on Shank complete, for 2 1/16 in. to 4 in. hem, Nos. 121669 and 121670
35063	23233	Presser Foot
26605XC	23233	Throat Plate (large needle hole) for 149603
26606XC	Throat Plate (small needle hole) for 149603, for 251-2 and 251-3 Machines

For Hemming Sheets

149031	8243	Feed Dog, 19 teeth (22 teeth to the inch) for 52033, for 251-1 Machine
149462	8244	Feed Dog, 19 teeth (22 teeth to the inch) for 143243, for 251-2 and 251-3 Machines
1499J	8243	Hemmer Screw (2)
121672	8243	Hemmer on Shank
121673	8243	Hemmer Throw-out Arm with 35522
35522	8243	Hemmer Throw-out Arm Pin
121674	8243	Hemmer complete on Throw-out Arm, for 1 in. to 1 15/16 in. hem, Nos. 121672, 121673 and two 1499J
NOTE: When ordering No. 121674, state width of hem.		
1499J	8243	Hemmer Screw (2)
121675	8243	Hemmer on Shank
121676	8243	Hemmer Throw-out Arm with 35522
35522	8243	Hemmer Throw-out Arm Pin
121677	8243	Hemmer complete on Throw-out Arm for 2 in. to 3 in. hem, Nos. 121675, 121676 and two 1499J
NOTE: When ordering No. 121677, state width of hem.		
121678	8243	Hemmer Tension Spring
121679	Hemmers complete for 1 in. to 3 in. hem, Nos. 24J, 39026, 121674, 121677 and 121678
NOTE: When ordering No. 121679, state width of hem.		
24J	8243	Hemmer Hinge Screw
39026	8243	Hemmer Hinge Screw Washer
121841	23257	Hemmer on Shank, for 3/4 in. to 1 in. hem
121842	23257	Hemmer on Shank, for 2 1/16 in. to 3 in. hem
121888	23257	Hemmer on Shank, for 3 1/16 in. to 4 in. hem
121980	24353	Hemmer on Shank, for 1 1/16 in. to 2 in. hem
1443B	23257	Hemmer Screw (2)
35063	23263	Presser Foot, for use with 121841, 121842 and 121888
121680	8243	Presser Foot, for use with 121679 and 121980
143243XC	8244	Throat Plate, for 149462, for 251-2 and 251-3 Machines
52033XC	8243	Throat Plate (small needle hole) for 149031, for 251-1 Machine

KNEE LIFTER

No.	Plate	Name
143179	8245	Bell Crank Plunger
143280	23284	Rock Shaft
143302	Rock Shaft 143280 with 143281, 143286 and 143287
143281	23284	Rock Shaft Crank with 140351AL and 143282
140350C	23284	Rock Shaft Crank Adjusting Screw
143282	Rock Shaft Crank Adjusting Screw 140350C with 51649J
51649J	23284	Rock Shaft Crank Adjusting Screw Lock Nut
140351AL	23284	Rock Shaft Crank Clamping Screw
143283	23284	Rock Shaft Knee Arm
143284	23284	Rock Shaft Knee Arm Hub with 356C and 140351AL
140351AL	23284	Rock Shaft Knee Arm Hub Clamping Screw
356C	23284	Rock Shaft Knee Arm Set Screw
143285	Rock Shaft Knee Arm complete, Nos. 2767, 143283 and 143284
2767	23284	Rock Shaft Knee Arm Plate with 356C
356C	23284	Rock Shaft Knee Arm Plate Set Screw
143286	23284	Rock Shaft Spring
143287	23284	Rock Shaft Stop Dog with 140351AL
140351AL	23284	Rock Shaft Stop Dog Clamping Screw
143288	23284	Rock Shaft complete, Nos. 143285 and 143302
147104	Knee Lifter complete, Nos. 802X, 143108, 143109, 143179, 143191, 143288, 143375, 146610, 147027, 147061, 147062 and two each 158R and 1611J

MACHINE BASE AND OIL RESERVOIR

143256	8245	Machine Base and Oil Reservoir
143257	8245	Machine Base and Oil Reservoir Gasket (cork)
50741E	8245	Machine and Machine Base and Oil Reservoir Screw (for shipping purposes only)
140343E	8245	Machine and Machine Base and Oil Reservoir Screw Hole Plug Screw
143359	8245	Machine Base and Oil Reservoir Screw Retainer (for shipping purposes only)
143360	8245	Machine Base and Oil Reservoir Screw Cotter Pin (for shipping purposes only)

MACHINE BASE AND OIL RESERVOIR FRAME

143306	23290	Machine Base and Oil Reservoir Frame, Nos. two 16555, four each 9374, 24106 and six each 143260 and wood screws 1 1/4 in. No. 12 F.H.
51088R	23290	Machine Base and Oil Reservoir Frame Bolt with 51581R (4)
51581R	23290	Machine Base and Oil Reservoir Frame Bolt Nut (4)
40282	23290	Machine Base and Oil Reservoir Frame Bolt Nut Washer (4)
24106	23290	Machine Base and Oil Reservoir Frame Cushion (left) (4)
9374	23290	Machine Base and Oil Reservoir Frame Cushion Pin (4)
16555	23290	Machine Base and Oil Reservoir Frame Hinge Plate (2)
143260	23290	Machine Base and Oil Reservoir Frame Hinge Plate Rivet (6)
135167	23290	Tucker Base Block (wood) 6 in. diam. 1 1/2 in. thick
143307	Machine Base and Oil Reservoir Frame complete with Long Arm Tucker, Nos. 36395 (with three wood screws 3 in. No. 12 F.H., in place of three wood screws 1 1/4 in. No. 10 F.H.) 135167, 143306 and four each 40282 and 51088R

NEEDLE THREADER

No.	Plate	Name
121846	23257	Needle Threader Hook (3)
140157J	23257	Needle Threader Hook Screw
121845	23257	Needle Threader complete, Nos. 140157J and three 121846

PIPING ATTACHMENT

149253	8246	Feed Dog, 16 teeth (16 teeth to the inch) for 44255 and 44256
1443J	8246	Piping Attachment Screw
35245	8246	Piping Attachment with 1443J, for piping house dresses
52056	8246	Presser Foot
44256XC	8246	Throat Plate (large needle hole) for 149253
44255XC	Throat Plate (small needle hole) for 149253, for 251-2 and 251-3 Machines

PRESSER FEET

36464	23236	Presser Foot Spring Guide
665J	23236	Presser Foot Spring Guide Screw
36465	23236	Presser Foot (right hand spring guide) with 665J and 36464 for 1/32 in. to 3/8 in. stitching margin
NOTE: When ordering No. 36464 or No. 36465, state required distance from edge of goods to seam.		
12335	23236	Presser Foot (narrow)
12435	23236	Presser Foot with 228J (with needle hole on right hand side) for 3/32 in. stitching margin
160346	23300	Presser Foot with 228J (with needle hole on right hand side) for 3/64 in. stitching margin
160347	23300	Presser Foot with 228J (with needle hole on right hand side) for 1/64 in. stitching margin
160348	23300	Presser Foot with 228J (with needle hole on left hand side) for 1/32 in. stitching margin
228J	23236	Presser Foot Extension Screw
36714	23236	Presser Foot with 233D
36715	23236	Presser Foot Guide (right) with 36716
233D	23236	Presser Foot Guide Set Screw
36716	23236	Presser Foot Guide Stud
36717	23236	Presser Foot complete, with adjustable Guide (right) Nos. 36714 and 36715
36773	23236	Presser Foot for braiding
35528	23236	Presser Foot (wide)
120828	23236	Presser Foot (single toe) for gathering, for fine work
121763	23236	Presser Foot with hemmer with Yielding Top Scroll for margins up to 9/32 in.
20343	23236	Presser Foot with guide on bottom to the right of needle hole
12462	23236	Presser Foot for 1/8 in. to 1 in. stitching margin
12463	23236	Presser Foot with Strip Guide
36654	23236	Presser Foot for tucking shirt bosoms
40315	23236	Presser Foot for long stitch, for general work
40322	23236	Presser Foot (narrow)
26276	23236	Presser Foot Hinge Pin
20133	23236	Presser Foot Plate
19223	23236	Presser Foot Shank
20134	23236	Presser Foot (hinged) complete for 3/16 in. to 1/4 in. stitching margin for collar and cuff work, Nos. 19223, 20133 and 26276

QUILTERS

No.	Plate	Name
120482		Quilter Guide Bracket 120481 with 120483 and two 209AL
120483	23268	Quilter Guide Disengaging Sleeve
120484	23268	Quilter Guide Disengaging Sleeve Spring
602J	23268	Quilter Guide Disengaging Sleeve Spring Screw
209AL	23268	Quilter Guide Set Screw
120485	23268	Quilter complete, Nos. 602J, 120479, 120480, 120482 and 120484

RUFFLERS

121116	8246	Driving Lever
51371K	8246	Driving Lever Adjusting Thumb Screw (lower)
560B	8246	Driving Lever Adjusting Thumb Screw (upper)
120812	8246	Driving Lever Bushing
120813	8246	Driving Lever Friction Washer
51219F	8246	Driving Lever Hinge Screw
1700J	8246	Driving Lever Hinge Screw Nut
121117	8246	Frame
36637	8246	Frame Spring Plate
36638	8246	Ribbon Guide
240B	8246	Ribbon Guide Screw
121118	8246	Ruffling Blade
121119	8246	Ruffling Blade Holder
121120		Ruffling Blade Holder 121119 with 121118 and two 120829
36641	8246	Ruffling Blade Holder Guide
36642	8246	Ruffling Blade Holder Guide Rivet
51221F	8246	Ruffling Blade Holder Hinge Screw
1772J	8246	Ruffling Blade Holder Hinge Screw Nut
121121	8246	Ruffling Blade Lever with 560B and 51371K
120829	8246	Ruffling Blade Rivet (2)
36644	8246	Separating Blade
120830	8246	Separating Blade Holder
121501		Separating Blade Holder 120830 with 36644 and two 120829
36646	8246	Separating Blade Holder Friction Spring
36647	8246	Separating Blade Holder Hinge Stud
36648	8246	Separating Blade Holder Stop Stud
120829	8246	Separating Blade Rivet (2)
36644	8246	Shirring Blade
120818	8246	Shirring Blade Holder
120819	8246	Shirring Blade Holder 120818 with 36644 and two 120829
120829	8246	Shirring Blade Rivet (2)
121123	8246	Ruffler complete, Nos. 240B, 1700J, 1772J, 36637, 36638, 36641, 36642, 36646, 36647, 36648, 51219F, 51221F, 120812, 120813, 121116, 121117, 121120, 1211121 and 121501
121451	8246	Ruffler 121123 with 1981, 51272C and 120819, for 251-1 Machine
1981	8246	Ruffler Roller
51272C	8246	Ruffler Roller Stud and Needle Clamping Screw
160449	8247	Ruffler 121123 with 120819 and 160448, for 251-2 and 251-3 Machines
160448	8247	Needle Clamp with 50203F
50203F	8247	Needle Clamp Screw

STRIP FOLDER ON SHANK WITH HEMMER

For Attaching Button Stays on Shirt Fronts

For No. 251-1 Machine

No.	Plate	Name
149481	8248	Feed Dog, 17 teeth (16 teeth to the inch) for 12483
160334	8248	Presser Foot with Edge Guide on left hand side
160333	8248	Strip Folder on Shank with Hemmer
12483XC	8248	Throat Plate, for 149481

THREAD UNWINDER

(For Two Spools or Two Large Cones of Thread)

228692	23289	Spool Pin (2)
201528X	23289	Spool Pin Nut (2)
228693	23289	Spool Pin Washer (2)
225257	23289	Spool Rest with 201018C and two each 201528X, 228692 and 228693
150203	23289	Spool Rest Cushion (felt) (2)
225388	23289	Spool Rest Rod
200383C	23289	Spool Rest Rod Set Screw
201018C	23289	Spool Rest Set Screw
259658	23289	Spool Stand with 200383C
225391	23289	Thread Guide (2)
201696J	23289	Thread Guide Lock Nut
225326	23289	Thread Guide Position Cup
225324	23289	Thread Guide Rod with 208AL and 225322
208AL	23289	Thread Guide Rod Screw
225322	23289	Thread Guide Rod Washer
225258	23289	Thread Unwinder complete, Nos. 201696J, 225257, 225324, 225326, 225338, 259658, two each 150203, 225391 and three wood screws 7/8 in. No. 12 F.H.
27739	23289	Thread Cone (wood) for large cones
225390	23289	Thread Cone Holder, for inverted cones

NOTE: No. 27739 and 225390 are used with, but not included in 225258.

TUCKER (LONG ARM)

36387	23260	Space Guide
35510	23260	Space Guide Base with 35512, 35514 and two 1426E
402J	23260	Space Guide Base Screw (2)
35511	23260	Space Guide Indicator
35512	23260	Space Guide Pin
35513	23260	Space Guide Stop (left)
35514	23260	Space Guide Stop (left) Guide Pin
1426E	23260	Space Guide Stop (left) Screw Stud
1657W	23260	Space Guide Stop (left) Thumb Nut
17718	23260	Space Guide Stop (left) Thumb Nut Washer
35515	23260	Space Guide Stop (right)
1426E	23260	Space Guide Stop (right) Screw Stud
1657W	23260	Space Guide Stop (right) Thumb Nut
17718	23260	Space Guide Stop (right) Thumb Nut Washer
50053W	23260	Space Guide Thumb Screw
36388	23260	Space Guide complete, Nos. 35510, 35511, 35513, 35515, 36387, 50053W and two each 1657W and 17718
35517	23260	Tuck Guide Arm
1177J	23260	Tuck Guide Arm Screw (2)

TUCKER (LONG ARM)

No.	Plate	Name
35518	23260	Tuck Guide Base
50134E	23260	Tuck Guide Base Screw Stud
36389	23260	Tuck Guide Bracket
307C	23260	Tuck Guide Bracket Screw Center (2)
56814	23260	Tuck Guide Bracket Screw Center 307C with 1513J (2)
1513J	23260	Tuck Guide Bracket Screw Center Nut (2)
36390	23260	Tuck Guide Bracket Spring
36391	23260	Tuck Guide Bracket Spring Plate
9D	23260	Tuck Guide Bracket Spring Screw
423AL	23260	Tuck Guide Bracket Stop Screw
1520J	23260	Tuck Guide Bracket Stop Screw Nut
36392	23260	Tuck Guide Frame
36393	23260	Tuck Guide Frame Spring
1510E	23260	Tuck Guide Frame Spring Nut
35524	23260	Tuck Guide Frame Spring Washer
803C	23260	Tuck Guide Frame Stop Screw
1520J	23260	Tuck Guide Frame Stop Screw Nut
35511	23260	Tuck Guide Indicator
35525	23260	Tuck Guide Plate
1115F	23260	Tuck Guide Screw (2)
36394	23260	Tuck Guide complete, Nos. 9D, 423AL, 803C, 1510E, 35511, 35517, 35518, 35524, 35525, 36389, 36390, 36391, 36392, 36393, 50134E, two each 1115F, 1177J, 1520J, 56814 and three wood screws 1 1/4 in. No. 10
36395	23260	Tucker (long arm) complete, Nos. 35528, 36388, 36394 and two 402J
35528	23260	Presser Foot (wide) for 36395

FITTINGS

Boston

149481	23282	Feed Dog, 17 teeth (16 teeth to the inch) for 12482
62527	23282	Presser Foot Hinge Pin
62925	23282	Presser Foot Plate
62926	23282	Presser Foot Shank
26231	23282	Presser Foot Spring
62927	23282	Presser Foot (spring hinged) complete, Nos. 26231, 62527, 62925 and 62926
12482XC	23282	Throat Plate for 149481

For Button Stays

149603	23282	Feed Dog, 20 teeth (16 teeth to the inch) for 26605 and 26606
121653	23282	Hemmer on Shank for 5/16 in. to 1 1/8 in. hem
7298	23282	Presser Foot Hinge Pin
120143	23282	Presser Foot Plate
19335	23282	Presser Foot Shank
120144	23282	Presser Foot (hinged) complete, Nos. 7298, 19335 and 120143
26605XC	23282	Throat Plate (large needle hole) for 149603
26606XC	23282	Throat Plate (small needle hole) for 149603, for 251-2 and 251-3 Machines

For Chaining-off

No.	Plate	Name
149057	24353	Feed Dog, 21 teeth (22 teeth to the inch) for 142060 and 142061
149062	24353	Feed Dog, 17 teeth (18 teeth to the inch) for 142060 and 142061
142061XC	24353	Throat Plate (large needle hole) for 149057 and 149062
142060XC	24353	Throat Plate (small needle hole) for 149057, for 251-1 Machine

For Collar Work

(First Stitching)

149164	8241	Feed Dog, 16 teeth (16 teeth to the inch) for 1/8 in. stitch for 52190 and 143278
52189	8241	Presser Foot (solid) for 52190
52190XC	8241	Throat Plate for 149164, for 251-1 Machine
143278XC	8242	Throat Plate for 149164, for 251-2 and 251-3 Machines

For Collar Work

(Second Stitching)

For No. 251-1 Machine

149646	8249	Feed Dog, 12 teeth (16 teeth to the inch) for 121649
121647	8249	Presser Foot with 121648 and two 337J, for 3/16 in., 7/32 in., 1/4 in., 9/32 in. and 5/16 in. stitching margin
121648	8249	Presser Foot Edge Guide, for 3/16 in., 7/32 in., 1/4 in., 9/32 in. and 5/16 in. stitching margin, for 121647
337J	8249	Presser Foot Edge Guide Screw (2)
121649XC	8249	Throat Plate for 149646

For Collar and Cuff Work

For No. 251-1 Machine

149163	8249	Feed Dog, 16 teeth (16 teeth to the inch) for 1/16 in. stitch for 20123
149164	8249	Feed Dog, 16 teeth (16 teeth to the inch) for 1/8 in. stitch for 20123
52188	8249	Presser Foot (solid) for cuff work
52189	8249	Presser Foot (solid) for collar work
20123XC	8249	Throat Plate for 149163 and 149164

For Cuff Work

For No. 251-1 Machine

149164	8249	Feed Dog, 16 teeth (16 teeth to the inch) for 1/8 in. stitch for 52190
52188	8249	Presser Foot (solid) for 52190
52190XC	8249	Throat Plate for 149164

For Curtain Work

No.	Plate	Name
149165	23263	Feed Dog, 18 teeth (14 teeth to the inch) for 143169
26276	23263	Presser Foot Hinge Pin
143166	23263	Presser Foot Plate
143167	23263	Presser Foot Shank
52544	23263	Presser Foot Spring
143168	23263	Presser Foot (spring hinged) complete, Nos. 26276, 52544, 143166 and 143167
143169XC	23263	Throat Plate (large needle hole) for 149165

For Darning

160342	23285	Presser Foot
12298XC	23285	Throat Plate (large needle hole)
12422XC	23285	Throat Plate (small needle hole)

For General Work

149174	23263	Feed Dog, 17 teeth (14 teeth to the inch) for 143175
143175XC	23263	Throat Plate (large needle hole) for 149174
149031	8223	Feed Dog, 19 teeth (22 teeth to the inch) for 52032 and 52033
62527	8223	Presser Foot Hinge Pin
62925	8223	Presser Foot Plate
62926	8223	Presser Foot Shank
26231	8223	Presser Foot Spring
62927	8223	Presser Foot (spring hinged) complete, for 52031 to 52033, Nos. 26231, 62527, 62925 and 62926
52032XC		Throat Plate (large needle hole) for 149031
52033XC	8223	Throat Plate (small needle hole) for 149031 for 251-1 Machine
62527	8225	Presser Foot Hinge Pin
127233	8225	Presser Foot Plate
52390	8225	Presser Foot Shank
26231	8225	Presser Foot Spring
127234	8225	Presser Foot (spring hinged) complete, Nos. 26231, 52390, 62527 and 127233
131256	23285	Presser Foot Hinge Pin
127257	23285	Presser Foot Plate
127258	23285	Presser Foot Shank with 665J
665J	23285	Presser Foot Shank Adjusting Screw
127259	23285	Presser Foot Thread Cutter
239E	23285	Presser Foot Thread Cutter Screw
127260	23285	Presser Foot (hinged) complete with Thread Cutter, Nos. 239E, 127257, 127258, 127259 and 131256
149319	8224	Feed Dog, 19 teeth (16 teeth to the inch) for 127320 and 127321
127320XC		Throat Plate (large needle hole) for 149319
127321XC	8224	Throat Plate (small needle hole) for 149319, for 251-2 Machine
149446	23266	Feed Dog, spiked teeth 13 teeth (10 teeth to the inch) for 20356 and 20357
20356XC	23266	Throat Plate (large needle hole) for 149446
20357XC		Throat Plate (small needle hole) for 149446, for 251-2 and 251-3 Machines
149158	23266	Feed Dog, 15 teeth (14 teeth to the inch) for 44162
26276	23266	Presser Foot Hinge Pin
44159	23266	Presser Foot Plate

No.	Plate	Name
44160	23266	Presser Foot Shank
44161	23266	Presser Foot (hinged) complete for 44162 and 149158, Nos. 26276, 44159 and 44160
44162XC	23266	Throat Plate for 149158

For Hemming Handkerchiefs

For No. 251-1 Machine

160319	8250	Edge Guide on Shank (adjustable) for turning cloth upward to feed into Hemmer (foot) No. 160321
149031	8250	Feed Dog, 19 teeth (22 teeth to the inch) for 52033
6267		Hemmer Folder
25888		Hemmer Tongue
NOTE: When ordering No. 6267 or No. 25888, state width of hem and number of Hemmer for which required.		
160321	8250	Hemmer (foot) with 6267, 25888, 160320 and two 234E, for 1/16 in. hem
160320	8250	Hemmer (foot) Extension Guide
234E	8250	Hemmer (foot) Extension Guide Screw (2)
52033XC	8250	Throat Plate (small needle hole) for 149031

For Leather Work

For Nos. 251-2 and 251-3 Machines

149436	8251	Feed Dog, 11 teeth (18 teeth to the inch) for 20192
19441	8251	Presser Bar (hollow)
19464	8251	Presser Bar complete, Nos. 190J, 19441, 19442, 19443 and 24445
51901	8251	Roller, 7/8 in. diam., 1/8 in. face (fine) ball bearing complete, Nos. 1528J, 201699F, 350104F and twenty-eight 206417
62855	8251	Roller Arm
19442	8251	Roller Arm Bracket
19443	8251	Roller Arm Bracket Position Collar with 456AL
456AL	8251	Roller Arm Bracket Position Collar Set Screw
987E	8251	Roller Arm Bracket Screw Stud
19444	8251	Roller Arm Bracket Spring
19445	8251	Roller Arm Bracket Spring Pin
19446	8251	Roller Arm Bracket Spring Stud
24445	8251	Roller Arm Bracket Spring Stud complete, Nos. 987E, 19444, 19445 and 19446
206417	8251	Roller Ball, 1/16 in. diam. (28)
201699F	8251	Roller Ball Retaining Nut
350104F	8251	Roller Screw
1528J	8251	Roller Screw Nut
62861	8251	Roller Presser (ball bearing) complete, 7/8 in. fine roller with roller set 1/8 in. beyond center of needle, Nos. 51901 and 62855
190J	8251	Roller Presser Screw
20192XC	8251	Throat Plate for 149436

For Shirt Work

149170	23266	Feed Dog, 16 teeth (16 teeth to the inch) for 143171 and 143222
149249	8241	Feed Dog, 18 teeth (18 teeth to the inch) for 143171 and 143222

No.	Plate	Name
149250	8241	Feed Dog, 20 teeth (20 teeth to the inch) for 143171 and 143222
143171XC	23266	Throat Plate (large needle hole) for 149170, 149249 and 149250
143222XC	8241	Throat Plate (small needle hole) for 149170, 149249 and 149250, for 251-1 Machine
149603	23224	Feed Dog, 20 teeth (16 teeth to the inch) for 19336, 26605 and 26606
7298	23224	Presser Foot Hinge Pin
19334	23224	Presser Foot Plate
19335	23224	Presser Foot Shank
19336	23224	Presser Foot (hinged) complete, for 26605, 26606 and 149603, Nos. 7298, 19334 and 19335
26605XC	23224	Throat Plate (large needle hole) for 19336 and 149603
26606XC	Throat Plate (small needle hole) for 19336 and 149603, for 251-2 and 251-3 Machines

For Shoulder Joinings

149603	23224	Feed Dog, 20 teeth (16 teeth to the inch) for 26605 and 26606
121662	23224	Joining Attachment with 121844, for 121663
121844	Joining Attachment Shank
121663	23224	Presser Foot for 121662
26605XC	23224	Throat Plate (large needle hole) for 149603
26606XC	Throat Plate (small needle hole) for 149603, for 251-2 and 251-3 Machines

For Single Needle Felling on Slips

For No. 251-1 Machine

149315	8240	Feed Dog, 13 teeth (16 teeth to the inch) for 160317
160316	8240	Hemmer (foot) with 6267 and 121981, for 1/8 in. hem
6267	Hemmer Folder
121981	Hemmer Tongue

NOTE: When ordering No. 6267 or No. 121981, state width of hem and number of Hemmer for which required.

160317XC	8240	Throat Plate (small needle hole) for 149315
----------	------	---

For Sleeve Plackets (Facing)

121655	23225	Binder on Shank
149603	23225	Feed Dog, 20 teeth (16 teeth to the inch) for 26605 and 26606
121656	23225	Presser Foot for 1/4 in. to 1 1/4 in. hem
26605XC	23225	Throat Plate (large needle hole) for 149603
26606XC	Throat Plate (small needle hole) for 149603, for 251-2 and 251-3 Machines

For Tailor Work

149252	23224	Feed Dog, 12 teeth (12 teeth to the inch) for 44255 and 44256
149253	23224	Feed Dog, 16 teeth (16 teeth to the inch) for 44255 and 44256
149357	23285	Feed Dog, 13 teeth (12 teeth to the inch) for 160358

For Tailor Work

No.	Plate	Name
36574	23224	Presser Foot for 36575
36575	23224	Presser Foot 36574 with 36576 and two 50202J, for 44255, 44256, 149252 and 149253
36576	23224	Presser Foot Finger Guard for 36575
50202J	23224	Presser Foot Finger Guard Screw for 36575 (2)
44256XC	23224	Throat Plate (large needle hole) for 149252 and 149253
44255XC	Throat Plate (small needle hole) for 149252 and 149253, for 251-2 and 251-3 Machines
160358XC	23285	Throat Plate for 149357
149136	23225	Feed Dog, 15 teeth (16 teeth to the inch) for 12142, 20458 and 44137
12142	23225	Presser Foot for 44137 and 149136
20458	23225	Presser Foot for 44137 and 149136
44137XC	23225	Throat Plate for 12142, 20458 and 149136
149462	23226	Feed Dog, 19 teeth (22 teeth to the inch) for 52463
52463XC	23226	Throat Plate for 149462

For Yoking

121658	23226	Edge Folder with Edge Guide on Shank, for 121660
149603	23226	Feed Dog, 20 teeth (16 teeth to the inch) for 26605 and 26606
7298	23226	Presser Foot Hinge Pin
121659	23226	Presser Foot Plate
19223	23226	Presser Foot Shank
121660	23226	Presser Foot (hinged) complete, for 121658, Nos. 7298, 19223 and 121659
26605XC	23226	Throat Plate (large needle hole) for 149603
26606XC	Throat Plate (small needle hole) for 149603, for 251-2 and 251-3 Machines

SINGER Needles should be used
in SINGER Machines
These Needles and their Containers
are marked with the
Company's Trade Mark "SIMANCO.**" 1

Needles in Containers marked
"FOR SINGER MACHINES"
are NOT SINGER made needles. 2

NUMERICAL LIST OF PARTS

No.	Plate	Name
9D	23260	Tucker Tuck Guide Bracket Spring Screw for 36394
24J	8243	Hemmer Hinge Screw for 121679
69XC	8219	Presser Bar Lifter Hinge Screw
144D	8214	Arm Shaft (horizontal) Screw (back)
152J	8226	Face Plate Screw (lower) 3
152X	8226	Thread Take-up Lever Guard Screw (2)
157J	8227	Feed Lifting Rock Shaft Crank (front) Clamping Screw for 147032
157J	8227	Feed Rock Shaft Crank Clamping Screw for 147044
157E	8231	Oil Pump (centrifugal) Body Screw (3)
158R	8219	Bell Crank Bracket Screw for 147104 (2)
158E	8227	Feed Bar Carrier Clamping Screw for 147022 (2)
176E	8227	Feed Bar Carrier Hinge Pin Clamping Screw for 147022 (2)
189E	8231	Oil Pump (centrifugal) Screen Frame Screw (4)
190J	23226	Binder Ribbon Tension Screw for 26250
190J	23228	Cordler Cord Guide Screw for 120207
190J	22920	Piping Attachment Screw for 120742 (2)
190J	8251	Roller Presser Screw for 19464
193J	23227	Binder Folder Screw for 28776
196J	23227	Finger Guard Holder Set Screw for 36820
197E	8227	Feed Lifting Rock Shaft and Feed Rock Shaft Oil Wick Holder Screw
197E	8227	Feed Lifting Rock Shaft Oil Wick Clamping Plate Screw for 147030
197E	8227	Feed Rock Shaft Oil Wick Clamping Plate Screw for 147041
207E	8214	Arm Shaft (horizontal) Flanged Bushing (back) Oil Sump Tube Holder Screw
207F	23226	Binder Folder Screw for 26250
207E	8228	Needle Bar Connecting Stud Clamping Screw for 143326
207J	23268	Quilter Guide Holder Set Screw for 25992
207J	23268	Quilter Guide Set Screw for 25992
208AL	8228	Slack Thread Regulator Set Screw for 147059
208AL	23289	Thread Unwinder Thread Guide Rod Screw for 225324
209AL	23268	Quilter Guide Bracket Set Screw for 120482
209AL	23268	Quilter Guide Set Screw for 120482
217X	8217	Arm Side Shield Screw (2)
217J	22920	Piping Attachment Adjusting Screw for 120737
217E	8217	Thread Take-up Lever Oil Guard Screw
223E	8227	Feed Lifting Rock Shaft Cap Screw (2)
223E	8227	Feed Rock Shaft Cap Screw (2)
228E	8227	Feed Bar Carrier Oil Wick Holder Screw (2)
228E	8217	Oil Removing Wick (head end) Holder Body Stop and Spring Clip Screw for 147056
228J	23236	Presser Foot Extension Screw for 12435, 20157, 160346, 160347 and 160348
228J		Presser Foot Strip Gauge Screw for 139618
233J	23227	Binder Ribbon Tension Screw for 28776 (2)
233D	23236	Presser Foot Guide Set Screw for 36714
233E	8232	Rotating Hook Oil Flow Regulating Thumb Screw Spring Screw
234E	8250	Hemmer (foot) Extension Guide Screw for 160321 (2)
236J	23227	Finger Guard Screw for 121562 (2)
239E	23285	Presser Foot Thread Cutter Screw for 127260
240B	8246	Ruffler Ribbon Guide Screw for 121123
307C	23260	Tucker Tuck Guide Bracket Screw Center for 56814 (2)
337B	23233	Hemmer Scroll (lower) Spring Position Screw for 121665 and 121669
337J	8249	Presser Foot Edge Guide Screw for 121647 (2)
337J	8238	Presser Foot Edge Guide (left hand) Screw for 160340 (2)

NUMERICAL LIST OF PARTS

No.	Plate	Name
337B	24356	Presser Foot Graduated Adjustable Guide Clamp Screw for 121949
337J	8238	Presser Foot Marker Guide (right hand) Screw for 160340 (2)
356C	23284	Knee Lifter Rock Shaft Knee Arm Set Screw for 143284
356C	23284	Knee Lifter Rock Shaft Knee Arm Plate Set Screw for 2767
402J	8221	Stitch Length Indicator Plate Screw
402J	23260	Tucker Space Guide Base Screw for 36395 (2)
423AL	23260	Tucker Tuck Guide Bracket Stop Screw for 36394
435AL	8228	Thread Take-up Lever Link Hinge Stud Set Screw
447AL	8227	Feed Lifting Rock Shaft Bushing Set Screw (2)
447AL	8227	Feed Rock Shaft Bushing (back) Set Screw
447AL	8227	Feed Rock Shaft Bushing (front) Set Screw
448AL	8219	Presser Bar Lifting Lever Pin Set Screw for 147027
448AL	8219	Thread Take-up Spring Regulator Set Screw
456AL	8251	Roller Arm Bracket Position Collar Set Screw for 19443
457AL	23228	Corder Cord Guide Bed Leveling Screw for 120206
460AL	8227	Feed Lifting Rock Shaft Collar Set Screw for 147029 (4)
460AL	8227	Feed Rock Shaft Collar Set Screw for 147029 (2)
465F	23300	Edge Guide Bed Leveling Screw for 36187 (4)
560B	8246	Ruffler Driving Lever Adjusting Thumb Screw (upper) for 121121
590J	8241	Hemmer Adjusting Screw for 35540 (2)
591F	8232	Rotating Hook Bobbin Case Tension Regulating Screw for 52236
592E	8232	Rotating Hook Bobbin Case Latch Stop Screw for 52237
602J	23268	Quilter Guide Disengaging Sleeve Spring Screw for 120485
624AL	8219	Thread Retainer Set Screw
665J	8229	Needle Bar Thread Guard Screw for 143386
665J	23285	Presser Foot Shank Adjusting Screw for 127258
665J	24355	Presser Foot Spring Guide Screw for 28726, 28909, 36465 and 139630
691XC	8223	Throat Plate Screw (2)
704J	8232	Rotating Hook Bobbin Case Holder Position Bracket Screw
724F	8237	Binder Releasing Lever Hinge Screw for 121737
725X	8223	Bed Slide Spring Screw for 12432 (2)
738J	8226	Face Plate Screw (upper)
738J	8239	Face Plate Thread Lubricator Adaptor Screw for 147118
802X	8219	Presser Bar Lifting Lever Hinge Screw for 147104
803C	23260	Tucker Tuck Guide Frame Stop Screw for 36394
940F	8237	Binder Throw-out Arm Hinge Screw for 121737
940W	8240	Hemmer on Shank Holder Hinge Screw for 160326
966E	8227	Feed Lifting Rock Shaft Crank (back) Clamping Screw for 147031
987E	8251	Roller Arm Bracket Screw Stud for 24445
1036AL	8214	Feed Eccentric Body Set Screw for 143123 (2)
1036AL	8214	Thread Take-up Crank Set Screw
1044D	23228	Corder Cord Guide Arm Hinge Screw for 120207
1053E	8232	Rotating Hook Thread Guard Screw for 143341 (4)
1115F	23260	Tucker Tuck Guide Screw for 36394 (2)
1133E	8228	Needle Bar Bushing (lower) Set Screw
1133E	8228	Needle Bar Bushing (upper) Set Screw
1133E	8228	Presser Bar Bushing (lower) Set Screw
1177J	23260	Tucker Tuck Guide Arm Screw for 36394 (2)
1253AL	8232	Rotating Hook Set Screw for 143340 (3)
1259AL	8214	Arm Shaft (upright) Bevel Gear (lower) Set Screw (2)
1259AL	8214	Arm Shaft (upright) Bevel Gear (upper) Set Screw (2)
1259AL	8214	Feed Lifting Eccentric Set Screw
1259AL	8232	Rotating Hook Shaft Bevel Gear Set Screw (2)
1285AL	8232	Rotating Hook Shaft Bushing (front) Set Screw
1364X	8217	Oil Removing Wick (head end) Hinge Plate and Cover Screw (4)

NUMERICAL LIST OF PARTS

No.	Plate	Name
1367E	8232	Rotating Hook Section Screw for 143342 and 143343 (3)
1375AL	8214	Feed Eccentric Body Position Screw for 143123
1380E	8232	Rotating Hook Bobbin Case Tension Spring Screw for 52236
1425D	23300	Edge Guide Arm Hinge Screw for 36188
1426E	23260	Tucker Space Guide Stop (left) Screw Stud for 35510
1426E	23260	Tucker Space Guide Stop (right) Screw Stud for 35510
1443J	8237	Binder Screw for 121737 (2)
1443B	8241	Hemmer Screw for 35540 and for use with 121679, 121841, 121842, 121888 and 121980
1443J	8246	Piping Attachment Screw for 35245
1499J	8243	Hemmer Screw for 121674 and 121677 (2)
1510E	23260	Tucker Tuck Guide Frame Spring Nut for 36394
1513J	23260	Tucker Tuck Guide Bracket Screw Center Nut for 56814 (2)
1518J	8214	Bed Leg (back) Nut (2)
1518J	8214	Feed Lifting Rock Shaft Connecting Rod Hinge Screw Nut
1518J	8214	Feed Rock Shaft Connecting Rod Hinge Screw Nut
1520J	23260	Tucker Tuck Guide Bracket Stop Screw Nut for 36394
1520J	23260	Tucker Tuck Guide Frame Stop Screw Nut for 36394
1528J	8251	Roller Screw Nut for 51901
1560C	8219	Tension Regulating Thumb Nut for 52098
1611J	8219	Presser Bar Lifting Lever Connecting Rod Nut for 147104
1611J	8219	Presser Bar Lifting Lever Connecting Rod Nut Lock Nut for 147104
1657W	23260	Tucker Space Guide Stop (left) Thumb Nut for 36388
1657W	23260	Tucker Space Guide (right) Thumb Nut for 36388
1700J	8246	Ruffler Driving Lever Hinge Screw Nut for 121123
1772J	8246	Ruffler Ruffling Blade Holder Hinge Screw Nut for 121123
1981	8246	Ruffler Roller for 121451
1988	23300	Edge Guide Arm Roller and Screw Stud, for 36185
2102	23253	Bobbin Winder Tension Disc for 225462 (2)
2102	8219	Tension Disc for 52397 (2)
2103	8219	Tension Spring for 52397
2656		Presser Foot Spring for 160340
2767	23284	Knee Lifter Rock Shaft Knee Arm Plate with 356C, for 143285
2974	8232	Rotating Hook Bobbin Case Latch Lever Fulcrum Pin for 40393
2975	8232	Rotating Hook Bobbin Case Latch Spring for 52237
3146	8235	Binder Thumb Screw Washer for 121168 and 121871
3146	22920	Binder (transverse) on Shank Thumb Screw Washer for 120742
4307	8223	Bed Slide Spring for 12432
6267		Hemmer Folder (soft) for 160316, 160321 and 160343
		NOTE: When ordering No. 6267, state width of hem and number of Hemmer for which required.
7071	23226	Binder Folder Screw Washer for 26250 and 28776
7071	23226	Binder Ribbon Tension Screw Washer for 26250
7071	8239	Face Plate Thread Lubricator Adaptor Screw Washer for 147117
7071	8240	Hemmer on Shank Thumb Screw Washer for 160326
7071	22920	Piping Attachment Screw Washer for 120742 (2)
7298	8224	Presser Foot Hinge Pin for 19336, 20361, 120144 and 121660
8068	8239	Face Plate Thread Lubricator Oil Reservoir Rivet Washer (inside) for 147117
8582	8214	Arm Dowel Pin (2)
8879	8219	Arm Spool Pin Washer (cloth)
8879	8235	Tape Reel Disc Pin Washer (cloth) for 121412
8908	8234	Wrench (accessories)
9374	23290	Machine Base and Oil Reservoir Frame Cushion Pin for 143306 (4)
11140	8234	Wrench (accessories)

No.	Plate	Name
12142	23225	Presser Foot for 44137 and 149136
12298XC	23285	Throat Plate (large needle hole) for darning, for 160342
12329	8219	Tension Releasing Spring
12335	23236	Presser Foot (narrow)
12361	8234	Machine Hinge Connection (accessories) 2
12398	8219	Tension Releasing Lever Hinge Pin
12422XC	23285	Throat Plate (small needle hole) for darning, for 160342
12431X	8223	Bed Slide for 12432
12432	8223	Bed Slide complete, Nos. 4307, 12431X and two 725X
12435	23236	Presser Foot with 228J (with needle hole on right hand side) for 3/32 in. stitching margin
12462	23236	Presser Foot for 1/8 in. to 1 in. stitching margin
12463	23236	Presser Foot with Strip Guide
12464XC	23300	Throat Plate (large needle hole) for 35175, 35176 and 149450
12482XC	23282	Throat Plate for 62927 and 149481 (Boston)
12483XC	8248	Throat Plate for 149481, 160333 and 160334, for 251-1 Machine
13710	23253	Bobbin Winder Tension Spring for 225462
16555	23290	Machine Base and Oil Reservoir Frame Hinge Plate for 143306 (2)
16709	8217	Arm Side Shield Wick Spring Holder for 147010 and 147086
17718	23260	Tucker Space Guide Stop (left) Thumb Nut Washer for 36388
17718	23260	Tucker Space Guide Stop (right) Thumb Nut Washer for 36388
17822	8239	Face Plate Thread Lubricator Oil Reservoir Rivet for 147117
19223	23226	Presser Foot Shank for 20134 and 121660
19334	8224	Presser Foot Plate for 19336
19335	8224	Presser Foot Shank for 19336, 20361 and 120144
19336	8224	Presser Foot (hinged) complete, for 251-2 Machine, Nos. 7298, 19334 and 19335
19441	8251	Presser Bar (hollow) for 19464
19442	8251	Roller Arm Bracket for 19464
19443	8251	Roller Arm Bracket Position Collar with 456AL, for 19464
19444	8251	Roller Arm Bracket Spring for 24445
19445	8251	Roller Arm Bracket Spring Pin for 24445
19446	8251	Roller Arm Bracket Spring Stud for 24445
19464	8251	Presser Bar complete, for leather work, for 62861, for 251-2 and 251-3 Machines, Nos. 190J, 19441, 19442, 19443 and 24445
20123XC	8241	Throat Plate for 35540, 40318, 52188, 52189, 149163 and 149164, for 251-1 Machine
20133	23236	Presser Foot Plate for 20134
20134	23236	Presser Foot (hinged) complete, for 3/16 in. to 1/4 in. stitching margin, for collar and cuff work, Nos. 19223, 20133 and 26276
20150	24355	Presser Foot, for general work and binding
20155	23236	Presser Foot Plate for 20157
20156	23236	Presser Foot Shank for 20157
20157	23236	Presser Foot (hinged) complete. Nos. 228J, 20155, 20156 and 62527
20192XC	8251	Throat Plate for 62861 and 149436, for leather work, for 251-2 and 251-3 Machines
20343	23236	Presser Foot with guide on bottom to the right of needle hole
20356XC	23266	Throat Plate (large needle hole) for 149446
20357XC		Throat Plate (small needle hole) for 149446, for 251-2 and 251-3 Machines
20360	23236	Presser Foot Plate for 20361
20361	23236	Presser Foot (hinged) plain bottom complete, Nos. 7298, 19335 and 20360

No.	Plate	Name
20458	23225	Presser Foot for 44137 and 149136
23263	22920	Tape Reel Arm Pin for 120535
23263	8235	Tape Reel Arm Steady Pin for 121412
24106	23290	Machine Base and Oil Reservoir Frame Cushion (felt) for 143306 (4)
24445	8251	Roller Arm Bracket Spring Stud complete, for 19464, Nos. 987E, 19444, 19445 and 19446
24726	24355	Presser Foot Plate for 24728
24727	24355	Presser Foot Shank for 24728
24728	24355	Presser Foot (hinged) with right hand strip guide complete, for 1/32 in. to 1/2 in. stitching margin, Nos. 24726, 24727 and 26276
		NOTE: When ordering No. 24728 state stitching margin for which required.
25721	23226	Binder Folder for 26250
25722	23226	Binder Ribbon Tension for 26250
25878	8234	Edge Guide (accessories)
25888		Hemmer Tongue for 160321 and 160343
		NOTE: When ordering No. 25888, state width of hem and number of Hemmer for which required.
25983	23226	Presser Foot for 26250
25992	23268	Quilter Guide Holder with two 207J, for 28660
26231	8223	Presser Foot Spring for 62927, 127234 and 160330
26250	23226	Binder (English) complete, for 1/4 in. to 9/16 in. binding, Nos. 190J, 207F, 25721, 25722, 25983, 121445XC, 149444 and two 7071
26276	23236	Presser Foot Hinge Pin for 20134, 24728, 44161, 143168, 160324, 160340 and 160355
26279	23236	Presser Foot Extension, 1/16 in., for use with 20157
26280	23236	Presser Foot Extension, 1/8 in. for use with 20157
26281	23236	Presser Foot Extension, 1/4 in. for use with 20157
26282	23236	Presser Foot Extension, 3/8 in. for use with 20157
26283	23236	Presser Foot Extension, 1/2 in. for use with 20157
26605XC	23228	Throat Plate, large needle hole, for 19336, 28627, 28628, 35063, 35066, 35208, 52055, 120144, 121653, 121655, 121656, 121658, 121660, 121662, 121663, 121668, 121671, 149603, 160324 and 160326
26606XC		Throat Plate, small needle hole, for 19336, 28627, 28628, 35063, 35066, 35208, 35236, 52055, 120144, 121653, 121655, 121656, 121658, 121660, 121662, 121663, 121668, 121671 and 149603, for 251-2 and 251-3 Machines
26650	24355	Presser Foot, for braiding
26795	23228	Corder Cord Guide for 120207
26796	23228	Corder Cord Guide Arm for 120207
27739	23289	Thread Unwinder Thread Cone (wood) for large cones, for 225258
		NOTE: No. 27739 is used with, but not included in 225258.
28334	23227	Binder Folder for 28776
28337	23227	Binder Ribbon Tension for 28776
28622	24355	Presser Foot, grooved to left of needle hole
28627	23255	Hemmer on Shank, for 1/8 in. to 5/8 in. hem, for 26605, 26606, 28628, 35066 and 149603
28628	23255	Presser Foot for 3/8 in. to 5/8 in. margin, in steps of 1/32 in. for 26605, 26606, 28627 and 149603
28659	23268	Quilter Guide for 28660
28660	23268	Quilter complete, Nos. 25992 and 28659
28676	23227	Presser Foot for 28776
28725	24355	Presser Foot Spring Guide for 28726
28726	24355	Presser Foot (right hand spring guide) with 665J and 28725, for 1/32 in. to 1/4 in. margin
		NOTE: When ordering No. 28725 or No. 28726 state required distance from edge of material to seam.

NUMERICAL LIST OF PARTS

No.	Plate	Name
28775XC	23227	Throat Plate for 28776
28776	23227	Binder (English) complete for Heavy Work, Nos. 193J, 7071, 28334, 28337, 28676, 28775XC, 149370 and two 233J
28908	24355	Presser Foot Spring Guide for 28909
28909	24355	Presser Foot (left hand spring guide) with 665J and 28908, for 1/32 in. to 1/4 in. stitching margin
NOTE: When ordering No. 28908 or No. 28909 state required distance from edge of material to seam.		
28972	8240	Hemmer on Shank Holder for 160326
32572	8219	Tension Releasing Disc for 52397
32574	8219	Tension Releasing Pin for 52397
35003	24356	Presser Foot Graduated Adjustable Guide (long, left) for 121949
35004	24356	Presser Foot Graduated Adjustable Guide (long, right) for 121949
35005	24356	Presser Foot Graduated Adjustable Guide (short, right) for 121949
35063	23263	Presser Foot, for 26605, 26606, 35236, 52033, 121668, 121670, 121841, 121842, 121888, 143243, 149031 and 149462
35066	23255	Presser Foot, for 1/8 in. to 1 1/16 in. sizes from 1/8 in. to 1/4 in. in steps of 1/32 in. and above 1/4 in. to 1 1/16 in. in steps of 1/16 in., for 26605, 26606, 28627 and 149603
35135	24356	Presser Foot Graduated Adjustable Guide Clamp for 121949
35136	24356	Presser Foot Graduated Adjustable Guide Clamp Lever for 121949
35175	23300	Edge Folder on Shank for collar banding, for 12464, 35176 and 149450
35176	23300	Presser Foot for 12464, 35175 and 149450
35208	23228	Binder on Shank to turn in both edges, for bias or straight binding, for skirts, wrappers, shirt waists, etc. for 26605, 26606, 52055 and 149603
35236	23263	Hemmer on Shank, for 7/6 in. to 1 in. hem, for 26605, 25606, 35063 and 149603
35245	8246	Piping Attachment with 1443J, for piping house dresses, for 44255, 44256, 52056 and 149253
35510	23260	Tucker Space Guide Base with 35512, 35514 and two 1426E, for 36388
35511	23260	Tucker Space Guide Indicator for 36388
35511	23260	Tucker Tuck Guide Indicator for 36394
35512	23260	Tucker Space Guide Pin for 35510
35513	23260	Tucker Space Guide Stop (left) for 36388
35514	23260	Tucker Space Guide Stop (left) Guide Pin for 35510
35515	23260	Tucker Space Guide Stop (right) for 36388
35517	23260	Tucker Tuck Guide Arm for 36394
35518	23260	Tucker Tuck Guide Base for 36394
35522	8243	Hemmer Throw-out Arm Pin for 121673 and 121676
35524	23260	Tucker Tuck Guide Frame Spring Washer for 36394
35525	23260	Tucker Tuck Guide Plate for 36394
35528	23260	Presser Foot (wide) for 36395
35540	8241	Hemmer on Shank complete with right hand lower guide for lace, for 20123, 40318, 143277 and 149163, Nos. 1443B, 35926, 35927 and two 590J
35610	8237	Binder Washer for 121737
35610	8240	Hemmer on Shank Holder Friction Washer for 160326
35682	23230	Hemmer (foot) for 1/8 in. hem, with guide on bottom, to right of needle hole
35710	23230	Hemmer (foot) for 3/32 in. hem, with guide on bottom, to right of needle hole
35926	8241	Hemmer for 35540

NUMERICAL LIST OF PARTS

No.	Plate	Name
35927	8241	Hemmer Shank for 35540
35997	23230	Hemmer (foot) for 3/16 in. hem, with guide on bottom to right of needle hole
36069	24355	Presser Foot, grooved to left of needle hole
36072	23230	Hemmer (foot) for 1/4 in. hem, with guide on bottom to the right of needle hole
36122	23230	Hemmer (foot) for 7/32 in. hem
36185	23300	Edge Guide Arm with 1988, for 36188
36186	23300	Edge Guide Arm Friction Washer for 36188
36187	23300	Edge Guide Bed with four 465F, for 36188
36188	23300	Edge Guide (roller) complete, Nos. 1425D, 36185, 36186 and 36187
36309	23230	Hemmer (foot) for 7/32 in. hem, with guide on bottom to the right of needle hole
36387	23260	Tucker Space Guide for 36388
36388	23260	Tucker Space Guide complete, for 36395, Nos. 35510, 35511, 35513, 35515, 36387, 50053W and two each 1657W and 17718
36389	23260	Tucker Tuck Guide Bracket for 36394
36390	23260	Tucker Tuck Guide Bracket Spring for 36394
36391	23260	Tucker Tuck Guide Bracket Spring Plate for 36394
36392	23260	Tucker Tuck Guide Frame for 36394
36393	23260	Tucker Tuck Guide Frame Spring for 36394
36394	23260	Tucker Tuck Guide complete for 36395, Nos. 9D, 423AL, 803C, 1510E, 35511, 35517, 35518, 35524, 35525, 36389, 36390, 36391, 36392, 36393, 50134E, two each 1115F, 1177J, 1520J, 56814 and three wood screws 1 1/4 in. No. 10
36395	23260	Tucker (long arm) complete, Nos. 35528, 36388, 36394 and two 402J
36413	23230	Hemmer (foot) plain bottom, for 1/16 in. hem
36414	23230	Hemmer (foot) plain bottom, for 3/32 in. hem
36416	23230	Hemmer (foot) plain bottom, for 3/16 in. hem
36464	23236	Presser Foot Spring Guide for 36465
36465	23236	Presser Foot (right hand spring guide) with 665J and 36464, for 1/32 in. to 3/8 in. stitching margin
NOTE: When ordering No. 36464 or No. 36465, state required distance from edge of goods to seam.		
36480	23230	Hemmer (foot) plain bottom, for 3/16 in. hem
36524	23230	Hemmer (foot) for 5/32 in. hem, with guide on bottom, to right of needle hole
36574	23224	Presser Foot for 36575
36575	23224	Presser Foot 36574 with 36576 and two 50202J for 44255, 44256, 149252, 149253, 149357 and 160358, for tailor work
36576	23224	Presser Foot Finger Guard for 36575
36637	8246	Ruffler Frame Spring Plate for 121123
36638	8246	Ruffler Ribbon Guide for 121123
36641	8246	Ruffler Ruffling Blade Holder Guide for 121123
36642	8246	Ruffler Ruffling Blade Holder Guide Rivet for 121123
36644	8246	Ruffler Separating Blade for 121501
36644	8246	Ruffler Shirring Blade for 120819
36646	8246	Ruffler Separating Blade Holder Friction Spring for 121123
36647	8246	Ruffler Separating Blade Holder Hinge Stud for 121123
36648	8246	Ruffler Separating Blade Holder Stop Stud for 121123
36654	23236	Presser Foot for tucking shirt bosoms
36696	23233	Hemmer Scroll (lower) Spring Lock Pin for 121665 and 121669
36696	24356	Presser Foot Graduated Adjustable Guide Clamp Steady Pin for 121948
36714	23236	Presser Foot with 233D, for 36717
36715	23236	Presser Foot Guide (right) with 36716, for 36717
36716	23236	Presser Foot Guide Stud for 36715

NUMERICAL LIST OF PARTS

No.	Plate	Name
36717	23236	Presser Foot complete, with Adjustable Guide (right), Nos. 36714 and 36715
36773	23236	Presser Foot for braiding
36819	23227	Finger Guard Friction Washer for 121327
36820	23227	Finger Guard Holder with 196J for 121327
39026	8243	Hemmer Hinge Screw Washer for 121679
40264	8232	Rotating Hook Bobbin (3)
40274	8232	Rotating Hook Section for 143342 and 143343
40282	23290	Machine Base and Oil Reservoir Frame Bolt Nut Washer for 143307 (4)
40315	23236	Presser Foot for long stitch, for general work
40316	8241	Presser Foot Plate for 40318
40317	8241	Presser Foot Shank for 40318
40318	8241	Presser Foot (hinged) complete, for lace running, for 20123, 35540, 143277 and 149163, Nos. 40316, 40317 and 62527
40322	23236	Presser Foot (narrow)
40392	8232	Rotating Hook Bobbin Case Latch for 40393
40393	8232	Rotating Hook Bobbin Case Latch Hinge for 52237, Nos. 2974, 40392 and 125320
40394	8232	Rotating Hook Bobbin Case Tension Spring for 52236
41564	8234	Machine Rest Pin (wood) Accessories
42290	8237	Tape Reel Pin Washer for 120740
43525	8235	Binder Steady Pin for 160496 and 160497
43525	22920	Throat Plate Stud for 120741
44137XC	23225	Throat Plate for 12142, 20458 and 149136
44159	23266	Presser Foot Plate for 44161
44160	23266	Presser Foot Shank for 44161
44161	23266	Presser Foot (hinged) complete, for 44162 and 149158, Nos. 26276, 44159 and 44160
44162XC	23266	Throat Plate for 44161 and 149158
44255XC		Throat Plate (small needle hole) for 35245, 36575, 52056, 149252 and 149253, for 251-2 and 251-3 Machines
44256XC	8246	Throat Plate (large needle hole) for 35245, 36575, 52056, 149252 and 149253
50053W	23260	Tucker Space Guide Thumb Screw for 36388
50117AL	8223	Feed Dog Screw (2)
50123E	8214	Oil Pump (centrifugal) Impeller Locking Screw
50134E	23260	Tucker Tuck Guide Base Screw Stud for 36394
50190J	8234	Edge Guide Thumb Screw (Accessories)
50202J	23224	Presser Foot Finger Guard Screw for 36575 (2)
50203F	8247	Ruffler Needle Clamp Screw for 160448
50257J	8231	Oil Flow Window Cap Screw (4)
50302J	23227	Finger Guard Holder Set Screw for 120858
50304C	8219	Tension Stud for 52098
50305C	8219	Tension Stud Set Screw for 52083
50316J	23227	Finger Guard Screw for 121327
50429AL	8232	Rotating Hook Shaft Oil Retainer Collar Set Screw for 143133 (2)
50504C	8214	Arm Shaft (upright) Bushing (upper) Set Screw
50579J	8227	Feed Bar Slide Block Oil Wick Holder Screw
50741E	8245	Machine and Machine Base and Oil Reservoir Screw (for shipping purposes only)
51088R	23290	Machine Base and Oil Reservoir Frame Bolt with 51581R, for 143307 (4)
51097J	8235	Binder Thumb Screw for 121168 and 121871
51097J	22920	Binder (transverse) on Shank Thumb Screw for 120742
51097J	8235	Tape Reel Arm Thumb Screw for 120742, 121168 and 121871
51219F	8246	Ruffler Driving Lever Hinge Screw for 121123
51221F	8246	Ruffler Ruffling Blade Holder Hinge Screw for 121123
51224W	8240	Hemmer on Shank Thumb Screw for 160326
51272C	8246	Ruffler Roller Stud and Needle Clamping Screw for 121451

NUMERICAL LIST OF PARTS

No.	Plate	Name
51283AL	8221	Machine Driving Pulley Set Screw for 147016 and 147110 (2)
51369R	8221	Arm Top Cover Screw (4)
51369E	8231	Oil Lead Screw
51371K	8246	Ruffler Driving Lever Adjusting Thumb Screw (lower) for 121121
51581R	23290	Machine Base and Oil Reservoir Frame Bolt Nut for 51088R (4)
51649J	23284	Knee Lifter Rock Shaft Crank Adjusting Screw Lock Nut for 143282
51901	8251	Roller, 7/8 in. diam. 1/8 in. face (fine) ball bearing complete, for 62861, Nos. 1528J, 201699F, 350104F and twenty-eight 206417
52023	8228	Thread Take-up Lever Hinge Stud for 147080
52032XC		Throat Plate (large needle hole) for 121798, 121801, 121802, 121803, 121804, 121848 and 149031
52033XC	8223	Throat Plate (small needle hole) for 149031, for 251-1 Machine and for 121679, 121680, 160319 and 160321
NOTE: Throat Plate No. 52033 is regularly furnished with 251-1 Machine.		
52055	23228	Presser Foot for 35208
52056	8246	Presser Foot for 35245, 44255, 44256 and 149253
52083	8219	Thread Take-up Spring Regulator with 50305C, for 52397
52098		Tension Stud 50304C with 1560C, for 52397
52171	8228	Needle Bar Bushing (lower) Thread Eyelet for 251-1 Machine
52188	8249	Presser Foot for cuff work, for 20123, 52190, 149163 and 149164, for 251-1 Machine
52189	8241	Presser Foot (solid) for collar work, (first stitching) for 20123, 52190, 143278, 149163 and 149164
52190XC	8241	Throat Plate for collar work (first stitching) for 52188, 52189 and 149164, for 251-1 Machine
52235	8232	Rotating Hook Bobbin Case for 52236
52236		Rotating Hook Bobbin Case 52235 with 591F, 1380E, and 40394, for 52237
52237	8232	Rotating Hook Bobbin Case complete, for 143344 and 143345, Nos. 592E, 2975, 40393 and 52236
52239	8219	Arm Spool Pin and Thread Eyelet
52390	8225	Presser Foot Shank for 127234
52394	8219	Thread Take-up Spring for 52397
52397	8219	Tension complete, Nos. 2103, 32572, 32574, 52083, 52098, 52394 and two 2102
52454	8219	Thread Retainer
52463XC	23226	Throat Plate for 149462
52544	23263	Presser Foot Spring for 143168
56814		Tucker Tuck Guide Bracket Screw Center 307C with 1513J for 36394 (2)
62527	8223	Presser Foot Hinge Pin for 20157, 40318, 62927, 121946, 127234 and 160330
62827	8239	Face Plate Thread Lubricator Oil Wick for 147116
62855	8251	Roller Arm for 62861
62861	8251	Roller Presser (ball bearing) complete, 7/8 in. fine roller with rallet set 1/8 in. beyond center of needle, for leather work, for 19464, 20192 and 149436, for 251-2 and 251-3 Machines, Nos. 51901 and 62855
62925	8223	Presser Foot Plate for 62927
62926	8223	Presser Foot Shank for 62927
62927	8223	Presser Foot (spring hinged) complete, for 251-1 Machine and for 12482 and 149481 (Boston) Nos. 26231, 62527, 62925 and 62926
NOTE: 62927 is regularly furnished with 251-1 Machine.		
64519	8221	Arm Top Cover Stitch Regulator Plunger Spring for 147013 and 147014
120143	23282	Presser Foot Plate for 120144

No.	Plate	Name
120144	23282	Presser Foot (hinged) complete, for button stays, for 26605, 26606, 121653 and 149603, Nos. 7298, 19335 and 120143
120206	23228	Corder Card Guide Bed with 457AL, for 120207
120207	23228	Corder (adjustable) complete, for 120208, 121447 and 149446, for short turns or cushions, Nos. 190J, 1044D, 26795, 26796 and 120206
120208	23228	Presser Foot (grooved) for 120207, 121447 and 149446
120367	23255	Hemmer on Shank for handkerchief work, for 1/16 in. to 1/4 in. hem
120427	8240	Hemmer on Shank Holder Shank for 160326
120440	8234	Screw Driver (Accessories)
120479	23268	Quilter Guide (left) for 120485
120480	23268	Quilter Guide (right) for 120485
120481	23268	Quilter Guide Bracket for 120482
120482	Quilter Guide Bracket 120481 with 120483 and two 209AL, for 120485
120483	23268	Quilter Guide Disengaging Sleeve for 120482
120484	23268	Quilter Guide Disengaging Sleeve Spring for 120485
120485	23268	Quilter complete, Nos. 602J, 120479, 120480, 120482 and 120484
120532	22920	Binder (transverse) on Shank for 120742
120535	22920	Tape Reel Arm with 23263 and 120537, for 120742
120536	8235	Tape Reel Disc with 120538 and 120539, for 120742, 121168, 121737 and 121871
120537	8235	Tape Reel Disc Pin for 120535 and 121412
120538	8235	Tape Reel Disc Stud (wood) for 120536
120539	8235	Tape Reel Disc Stud Sleeve (brass) for 120536
120737	22920	Piping Attachment with 217J, for 120742
120738	22920	Presser Foot for 120742
120739	22920	Tape Guide for 120742
120740	8237	Tape Reel Pin 120775 with 42290, for 120742 and 121737
120741XC	22920	Throat Plate with 43525, for 120742
120742	22920	Binding and Piping Attachment complete, Nos. 3146, 120532, 120535, 120737, 120738, 120739, 120740, 120741XC, 149603 and two each 190J, 7071, 51097J and 120536
120775	8237	Tape Reel Pin for 120740
120803	23230	Hemmer (foot) for 1/8 in. hem
120804	23230	Hemmer (foot) for 5/32 in. hem
120805	23230	Hemmer (foot) for 3/16 in. hem
120806	23230	Hemmer (foot) for 1/4 in. hem
120807	23230	Hemmer (foot) for 5/16 in. hem
120812	8246	Ruffler Driving Lever Bushing for 121123
120813	8246	Ruffler Driving Lever Friction Washer for 121123
120818	8246	Ruffler Shirring Blade Holder for 120819
120819	8246	Ruffler Shirring Blade Holder 120818 with 36644 and two 120829, for 121451 and 160449
120828	23236	Presser Foot (single toe) for gathering, for fine work
120829	8246	Ruffler Ruffling Blade Rivet for 121120 (2)
120829	8246	Ruffler Separating Blade Rivet for 121501 (2)
120829	8246	Ruffler Shirring Blade Rivet for 120819 (2)
120830	8246	Ruffler Separating Blade Holder for 121501
120837	23230	Hemmer (foot) plain bottom, for 1/8 in. hem, slotted for lace
120838	Hemmer Tongue for 160331
	NOTE:	When ordering No. 120838, state width of hem and number of Hemmer for which required.
120843	Hemmer Tongue for 160344
	NOTE:	When ordering No. 120843, state width of hem and number of Hemmer for which required.
120858	23227	Finger Guard Holder with 50302J, for 121562
120898	23230	Hemmer (foot) for 1/16 in. to 1/8 in. hem, for China Silk, etc.

No.	Plate	Name
120911	23230	Hemmer (foot with shell hemmer) for 5/32 in. to 1/4 in. hem, for China Silk, etc.
120938	23230	Hemmer (foot) for 3/32 in. hem
120939	Hemmer Folder for 121798, 160318, 160331 and 160344
	NOTE:	When ordering No. 120939, state width of hem and number of Hemmer for which required.
120991	23255	Hemmer on Shank, for 1/6 in. to 1/4 in. hem
121116	8246	Ruffler Driving Lever for 121123
121117	8246	Ruffler Frame for 121123
121118	8246	Ruffler Ruffling Blade for 121120
121119	8246	Ruffler Ruffling Blade Holder for 121120
121120	Ruffler Ruffling Blade Holder 121119 with 121118 and two 120829, for 121123
121121	8246	Ruffler Ruffling Blade Lever with 560B and 51371K, for 121123
121123	8246	Ruffler complete, for 121451 and 160449, Nos. 2408, 1700J, 1772J, 36637, 36638, 36641, 36642, 36646, 36647, 36648, 51219F, 51221F, 120812, 120813, 121116, 121117, 121120, 121121 and 121501
121167	8235	Binder Folder on Shank for 121168 and 121871
121168	8235	Binder (transverse) on Shank complete, for 251-2 and 251-3 Machines, for folded and unfolded bias binding, with tape reel, for general work, for 3/4 in., 7/8 in. and 1 in. tape, Nos. 3146, 120536, 121167, 121169, 121412, 149397, 160496 and two 51097J
121169	8235	Presser Foot for 121168, 121737 and 121871
121326	23227	Finger Guard for 121327
121327	23227	Finger Guard (metal) complete, Nos. 36819, 36820, 50316J and 121326
121412	8235	Tape Reel Arm with 8879, 23263 and 120537, for 121168 and 121871
121445XC	23226	Throat Plate for 26250
121447XC	23228	Throat Plate for 120207, 120208 and 149446
121451	8246	Ruffler 121123 with 1981, 51272C and 120819, for 251-1 Machine
121501	Ruffler Separating Blade Holder 120830 with 36644 and two 120829, for 121123
121507	23227	Finger Guard for 121562
121562	23227	Finger Guard (wire) complete, Nos. 120858, 121507 and two 236J
121647	8249	Presser Foot with 121648 and two 337J, for 3/16 in., 7/32 in., 1/4 in., 9/32 in. and 5/16 in. Stitching Margin, for collar work (second stitching), for 121649 and 149646, for 251-1 Machine
121648	8249	Presser Foot Edge Guide, for 3/16 in., 7/32 in., 1/4 in., 9/32 in. and 5/16 in. Stitching Margin for 121647
121649XC	8249	Throat Plate, for 121647 and 149646, for collar work (second stitching) for 251-1 Machine
121653	23282	Hemmer on Shank for 5/16 in. to 1 1/8 in. hem, for button stays, for 26605, 26606, 120144 and 149603
121655	23225	Binder on Shank for sleeve plackets (facing) for 26605, 26606, 121656 and 149603
121656	23225	Presser Foot for 1/4 in. to 1 1/4 in. hem, for 26605, 26606, 12655 and 149603, for sleeve plackets (facing)
121658	23226	Edge Folder with Edge Guide on Shank for 26605, 26606, 121660 and 149603, for yoking
121659	23226	Presser Foot Plate for 121660
121660	23226	Presser Foot (hinged) complete, for 26605, 26606, 121658 and 149603, for yoking, Nos. 7298, 19223 and 121659
121662	23224	Joining Attachment with 121844, for 26605, 26606, 121663 and 149603, for shoulder joinings
121663	23224	Presser Foot for 26605, 26606, 121662 and 149603, for shoulder joinings

NUMERICAL LIST OF PARTS

No.	Plate	Name
121665	23233	Hemmer Scroll (lower) on Shank with 337B, 36696 and 121667, for 121668
121666	23233	Hemmer Scroll (upper) for 121668
121667	23233	Hemmer Scroll (lower) Spring for 121665 and 121669
121668	23233	Hemmer on Shank complete, for 3/4 in. to 2 in. hem, for hemming Pillow Cases, for 26605, 26606, 35063 and 149603, Nos. 121665 and 121666
121669	23233	Hemmer Scroll (lower) on Shank with 337B, 36696 and 121667, for 121671
121670	23233	Hemmer Scroll (upper) for 121671
121671	23233	Hemmer on Shank complete, for 2 1/16 in. to 4 in. hem, for hemming Pillow Cases, for 26605, 26606, 35063 and 149603, Nos. 121669 and 121670
121672	8243	Hemmer on Shank for 121674
121673	8243	Hemmer Throw-out Arm with 35522, for 121674
121674	8243	Hemmer complete on Throw-out Arm, for 1 in. to 1 15/16 in. hem, for hemming Sheets, for 121679, Nos. 121672, 121673 and two 1499J
		NOTE: When ordering No. 121674, state width of hem.
121675	8243	Hemmer on Shank for 121677
121676	8243	Hemmer Throw-out Arm with 35522, for 121677
121677	8243	Hemmer complete on Throw-out Arm, for 2 in. to 3 in. hem, for hemming Sheets, for 121679, Nos. 121675, 121676 and two 1499J
		NOTE: When ordering No. 121677, state width of hem.
121678	8243	Hemmer Tension Spring for 121679
121679		Hemmers complete for 1 in. to 3 in. hem, for hemming Sheets, for 52033, 121680, 143243, 149031 and 149462, Nos. 24J, 39026, 121674, 121677 and 121678
		NOTE: When ordering No. 121679, state width of hem.
121680	8243	Presser Foot for 52033, 121679, 121980, 143243, 149031 and 149462
121732	8237	Binder (transverse) for 121737
121733	8237	Binder Throw-out Arm with 192349, for 121737
121735	8237	Binder Releasing Lever for 121737
121736	8237	Binder Releasing Lever Spring for 121737
121737	8237	Binder (transverse) with Throw-out Arm complete, for folded or unfolded bias binding, with tape reel, for general work, for 3/4 in., 7/8 in. and 1 in. tape, Nos. 724F, 940F, 35610, 120536, 120740, 121169, 121732, 121733, 121735, 121736, 121938XC, 149738 and two 1443J
121741	8234	One Quart Can filled with light grade oil (Accessories)
121759XC	23230	Throat Plate (small needle hole) for 121760 and 149758
121760	23230	Hemmer (foot) for hemming shirts for 1/8 in. hem for 121759 and 149758
121761	23230	Hemmer (foot) with 121981 for hemming shirts for 1/8 in. hem
121762	23230	Hemmer (foot) with 121981, for 5/32 in. hem
121763	23236	Presser Foot with hemmer with Yielding Top Scroll for margins up to 9/32 in.
121798	23255	Hemmer (foot) with 120939 and 121981, for 1/8 in. hem, for hemming shirts, for 52032 and 149031
121801	23255	Hemmer (foot) with 121981, for 1/8 in. hem, for hemming shirts, for 52032 and 149031
121802	23255	Hemmer (foot) with 121981, for 5/32 in. hem, for hemming shirts, for 52032 and 149031
121803	23255	Hemmer (foot) with 121982, wide folder for 3/16 in. hem, for hemming shirts, for 52032 and 149031
121804	23255	Hemmer (foot) with 121982, narrow folder for 3/16 in. hem, for hemming shirts, for 52032 and 149031
121841	23257	Hemmer on Shank, for 3/4 in. to 1 in. hem, for hemming Sheets, for 35063, 52033, 143243, 149031 and 149462.

NUMERICAL LIST OF PARTS

No.	Plate	Name
121842	23257	Hemmer on Shank, for 2 1/16 in. to 3 in. hem, for hemming Sheets, for 35063, 52033, 143243, 149031 and 149462
121844		Joining Attachment Shank for 121662
121845	23257	Needle Threader complete, Nos. 140157J and three 121846
121846	23257	Needle Threader Hook for 121845 (3)
121848	23257	Hemmer (foot) with 121983 for 3/32 in. hem for hemming Shirts, for 52032 and 149031
121871	8236	Binder (transverse) on Shank complete, for 251-1 Machine, for folded, or unfolded bias binding, with tape reel, for general work, for 3/4 in., 7/8 in. and 1 in. tape, Nos. 3146, 120536, 121167, 121169, 121412, 149397, 160497 and two 51097J
121888	23257	Hemmer on Shank, for 3 1/16 in. to 4 in. hem, for hemming Sheets, for 35063, 52033, 143243, 149031 and 149462
121938XC	8237	Throat Plate with two 124964, for 121737
121939	24356	Presser Foot, for No. 3 Slide Fastener for stitching either at the right or the left of the Slide Fastener
121940	24356	Presser Foot, for No. 3 and No. 5 Slide Fastener, for stitching at the right of the Slide Fastener
121941	24356	Presser Foot, for No. 5 Slide Fastener, for stitching at the right or left of the Slide Fastener, for heavy woolen suiting and dresses
121942	24356	Presser Foot, for No. 3 and No. 5 Slide Fastener, for stitching at the left of the Slide Fastener
121943	24356	Presser Foot Plate for 121946
121944	24356	Presser Foot Shank for 121946
121945		Presser Foot Spring for 121946
121946	24356	Presser Foot complete, for No. 5 Slide Fastener, for stitching at the right or left of the Slide Fastener, for crossing seams, Nos. 62527, 121943, 121944 and 121945
121947	24356	Presser Foot, for No. 3 and No. 5 Slide Fastener, for stitching at the right of the Slide Fastener, for handbags, pocketbooks, etc.
121948	24356	Presser Foot with 36696, for 121949
121949	24356	Presser Foot with Graduated Adjustable Guide complete for No. 3 and No. 5 Slide Fastener, for making various margins up to 1/2 in. between the Slide Fastener and the line of stitching, Nos. 337B, 35003, 35004, 35005, 35135, 35136 and 121948
121950	24356	Presser Foot with toes turned up close to needle hole, for No. 3 Slide Fastener
121951	24356	Presser Foot, for No. 3 and No. 5 Slide Fastener, for stitching material with a heavy nap
121952	24356	Presser Foot, for No. 5 Slide Fastener, for stitching woolen suiting material
121980	24353	Hemmer on Shank, for 1 1/16 in. to 2 in. hem, for hemming Sheets, for 52033, 121680, 143243, 149031 and 149462
121981		Hemmer Tongue for 121761, 121762, 121798, 121801, 121802 and 160316
		NOTE: When ordering No. 121981, state width hem and number of Hemmer for which required.
121982		Hemmer Tongue for 121803 and 121804
121983		Hemmer Tongue for 121848
		NOTE: When ordering Nos. 121981, 121982 and 121983, state width of hem and number of Hemmer for which required.
124371	8239	Face Plate Thread Lubricator Oil Reservoir Rivet Washer (outside) for 147117
124964	8237	Binder Throw-out Arm Bracket Rivet for 121938XC (2)
125320	8232	Rotating Hook Bobbin Case Latch Lever for 40393

NUMERICAL LIST OF PARTS

No.	Plate	Name
147090	8219	Thread Eyelet (side of arm)
147091	8228	Pressure Regulating Thumb Screw and Presser Bar Guide
147092	8221	Stitch Length Indicator Plate
147093	Thread Take-up Crank 143093 with 140231C, 143058, 147050 and eighteen 143056, for 147089
147094	8227	Feed Bar Slide Block Oil Wick for 147021
147096	8226	Face Plate (Aluminum)
147097	Thread Take-up Lever 147100 with 143098, 143246 and eighteen 143056, for 251-3 Machine
147098	8230	Thread Take-up complete, for 251-3 Machine, Nos. 143098, 147075, 147080, 147099 and eighteen 143056
147099	Thread Take-up Crank 143246 with 140231C, 143058, 14705C and eighteen 143056, for 147098
147100	8228	Thread Take-up Lever with 147079, for 147071 and 147097
147104	Knee Lifter complete, Nos. 802X, 143108, 143109, 143179, 143191, 143288, 143375, 146610, 147027, 147061, 147062, and two each 158R and 1611J
147105	8221	Arm Top Cover Stitch Regulator Plunger for 147013 and 147014
147106	8231	Oil Pipe complete from Oil Pump to Arm Shaft (horizontal) Center Bearing, Nos. 143064, 143065 and 143066
147107	8217	Oil Removing Wick (head end) for 147056 and 147108
147108	Oil Removing Wick (head end) Holder Body 146745 with 146698 and 147107
147109	8214	Arm Shaft (horizontal) Screw Plug (front) Washer (fiber)
147110	8222	Machine Driving Pulley, large rim diameter, (disc power) "V" belt groove, outside diameter of belt groove 2.9 in. with two 51283 AL, for heavy work
147111	8214	Arm Shaft (upright) Bushing (upper)
147112	8214	Arm Shaft (horizontal) Flanged Bushing (back)
147113	8229	Needle Bar Bushing (lower) for 251-2 and 251-3 Machines
147114	8229	Needle Bar Bushing (lower) Thread Eyelet for 251-2 and 251-3 Machines
147115	Feed Bar 147021 with 147032
147116	Face Plate Thread Lubricator Oil Pad 147119, with 62827, 240439 and 241755, for 147117
147117	8239	Face Plate Thread Lubricator complete, for 147118, Nos. 7071, 8068, 17822, 124371 and 147116
147118	8239	Face Plate Thread Lubricator 147117 with 738J and 143264
147119	8239	Face Plate Thread Lubricator Oil Pad Holder for 147116
149031	8223	Feed Dog, 19 teeth (22 teeth to the inch) for 35063, 52032, 52033, 121674, 121677, 121680, 121798, 121801, 121802, 121803, 121804, 121841, 121842, 121848, 121888, 121980, 160319 and 160321
149057	24353	Feed Dog, 21 teeth (22 teeth to the inch) for 142060 and 142061, for Chaining-off
149062	24353	Feed Dog, 17 teeth (18 teeth to the inch) for 142060 and 142061, for Chaining-off
149136	23225	Feed Dog, 15 teeth (16 teeth to the inch) for 12142, 20458 and 44137
149158	23266	Feed Dog, 15 teeth (14 teeth to the inch) for 44161 and 44162
149163	8241	Feed Dog, 16 teeth (16 teeth to the inch) for 20123, 35540, 40318, 52188, 52189, 143277, 160327 and 160330
149164	8241	Feed Dog, 16 teeth (16 teeth to the inch) for 1/8 in. stitch, for 20123, 52188, 52189 and 52190
149165	23263	Feed Dog, 18 teeth (14 teeth to the inch) for 143168 and 143169, for curtain work
149170	23266	Feed Dog, 16 teeth (16 teeth to the inch) for 143171 and 143222, for shirt work

NUMERICAL LIST OF PARTS

No.	Plate	Name
149174	8225	Feed Dog, 17 teeth (14 teeth to the inch) for 143175, for 251-3 Machine
149249	8241	Feed Dog, 18 teeth (18 teeth to the inch) for 143171 and 143222, for shirt work
149250	8241	Feed Dog, 20 teeth (20 teeth to the inch) for 143171 and 143222, for shirt work
149252	23224	Feed Dog, 12 teeth (12 teeth to the inch) for 36575, 44255 and 44256
149253	8246	Feed Dog, 16 teeth (16 teeth to the inch) for 35245, 36575, 44255, 44256 and 52056
149315	8240	Feed Dog, 13 teeth (16 teeth to the inch) for 160317 and 160318, for 251-1 Machine
149319	8224	Feed Dog, 19 teeth (16 teeth to the inch) for 127320 and 127321, for 251-2 Machine
149357	23285	Feed Dog, 13 teeth (12 teeth to the inch) for 36575 and 160358
149370	23227	Feed Dog, 15 teeth (16 teeth to the inch) for 28776
149397	8235	Feed Dog, 17 teeth (16 teeth to the inch) for 121168 and 121871
149436	8251	Feed Dog, 11 teeth (18 teeth to the inch) for 20192 and 62861, for leather work, for 251-2 and 251-3 Machines
149444	23226	Feed Dog, 13 teeth (16 teeth to the inch) for 26250
149446	23228	Feed Dog, spiked teeth, 13 teeth (10 teeth to the inch) for 20356, 20357, 120207, 120208 and 121447
149450	23300	Feed Dog, 11 teeth (18 teeth to the inch) for 12464, 35175 and 35176
149462	8244	Feed Dog, 19 teeth (22 teeth to the inch) for 35063, 52463, 121674, 121677, 121680, 121841, 121842, 121888, 121980 and 143243
149474	8240	Feed Dog, 14 teeth (16 teeth to the inch) for 160331 and 160332 for 251-1 Machine
149481	8248	Feed Dog, 17 teeth (16 teeth to the inch) for 12483, 160333 and 160334, for 251-1 Machine and for 12482 and 62927 (Boston)
149603	23228	Feed Dog, 20 teeth (16 teeth to the inch) for 19336, 26605, 26606, 28627, 28628, 35063, 35066, 35208, 35236, 52055, 120144, 121653, 121655, 121656, 121658, 121660, 121662, 121663, 121668, 121671, 160324 and 160326
149646	8249	Feed Dog, 17 teeth (16 teeth to the inch) for 121647 and 121649, for collar work (second stitching) for 251-1 Machine
149738	8237	Feed Dog, 17 teeth (16 teeth to the inch) for 121737
149758	23230	Feed Dog, 13 teeth (16 teeth to the inch) for 121759 and 121760
150203	23289	Thread Unwinder Spool Rest Cushion (felt) for 225258 (2)
160316	8240	Hemmer (foot) with 6267 and 121981, for 1/8 in. hem, for 149315 and 160317, for single needle felling on slips, for 251-1 Machine
160317XC	8240	Throat Plate for 149315, 160316 and 160318, for 251-1 Machine
160318	8240	Hemmer (foot) with 120929, for 1/8 in. hem, for hemming shirts, for 149315 and 160317, for 251-1 Machine
160319	8250	Edge Guide on Shank (adjustable) for turning cloth upward to feed into Hemmer (foot) No. 160321, for hemming handkerchiefs, for 52033, 149031 and 160321, for 251-1 Machine
160320	8250	Hemmer (foot) Extension Guide for 160321
160321	8250	Hemmer (foot) with 6267, 25888, 160320 and two 234E, for 1/16 in. hem, for 52033, 149031 and 160319, for hemming handkerchiefs, for 251-1 Machine
160322	8240	Presser Foot Plate for 160324
160323	8240	Presser Foot Shank for 160324

No.	Plate	Name
160324	8240	Presser Foot (hinged) complete for 26605, 149603 and 160326, for hemming bottoms of pajamas and shorts, for 251-1 Machine, Nos. 26276, 160322 and 160323
160325	8240	Hemmer on Shank for 160326
160326	8240	Hemmer of Shank (adjustable, hinged) complete for 3/8 in. to 5/8 in. hem, for hemming bottoms of pajamas and shorts, for 251-1 Machine for 26605, 149603 and 160324, Nos. 940W, 7071, 28972, 35610, 51224W, 120427 and 160325
NOTE: When ordering No. 160326, size of hem must be stated.		
160327	24353	Scroll Hemmer on Shank, for hemming handkerchiefs and slips, for 1/8 in. hem, for 143277, 149163 and 160330
160328	24353	Presser Foot Plate for 160330
160329	24353	Presser Foot Shank for 160330
160330	24353	Presser Foot (spring hinged) complete, for 143277, 149163 and 160327, Nos. 26231, 62527, 160328 and 160329
160331	8240	Hemmer (foot) with 120838 and 120939, for 3/16 in. hem, with guide on bottom to right of needle hole, for hemming shirt centers, for 251-1 Machine
160332XC	8240	Throat Plate for 149474, 160316 and 160331, for 251-1 Machine
160333	8248	Strip Folder on Shank with Hemmer for attaching button stays on shirt fronts, for 12483, 149481 and 160334
160334	8248	Presser Foot with Edge Guide on left hand side, for attaching button stays on shirt fronts, for 12483, 149481 and 160333, for 251-1 Machine
160335	8238	Edge Folder with Strip Folder on Shank for French button facing, for 251-1 Machine, for 160336, 160340 and 160341
160336	8238	Feed Dog, 15 teeth (16 teeth to the inch) for 160341, for 251-1 Machine, for use with Edge Folder No. 160335
160337	8238	Presser Foot Edge Guide (left hand) for 160340
160338	8238	Presser Foot Marker Guide (right hand) for 160340
160339	8238	Presser Foot Plate, for 160340
160340	8238	Presser Foot (spring hinged) complete, for 160335, for 251-1 Machine, Nos. 2656, 26276, 160337, 160338, 160339, 160406 and four 337J
160341XC	8238	Throat Plate for 160336, for 251-1 Machine, for use with Edge Folder No. 160335
160342	23285	Presser Foot for darning, for 12298 and 12422
160343	23300	Hemmer (foot) with 6267 and 25888 (plain bottom, taper hem groove) for 1/16 in. hem
160344	23300	Hemmer (foot) with 120843 and 120939, for 1/16 in. hem
160345	24355	Presser Foot (blank)
NOTE: No. 160345 is furnished soft for grooving to suit cord.		
160346	23300	Presser Foot with 228J (with needle hole on right hand side) for 3/64 in. stitching margin
160347	23300	Presser Foot with 228J (with needle hole on right hand side) for 1/64 in. stitching margin
160348	23300	Presser Foot with 228J (with needle hole on left hand side) for 1/32 in. stitching margin
160349	24355	Presser Foot, for binding
160350	24355	Presser Foot, for 3/32 in. to 5/8 in. stitching margin
NOTE: When ordering No. 160350, state margin required.		
160351	24355	Presser Foot, for binding
160352	24355	Presser Foot, for binding
160353	24355	Presser Foot Plate for 160355
160354	24355	Presser Foot Shank for 160355
160355	24355	Presser Foot (hinged) complete, for binding, Nos. 26276, 160353 and 160354
160356	24355	Presser Foot, for French braiding with groove on bottom to right of needle hole and braid slot on top

No.	Plate	Name
160358XC	23285	Throat Plate for 36575 and 149357, for tailor work
160406	8238	Presser Foot Shank for 160340
160448	8247	Ruffler Needle Clamp with 50203F, for 160449
160449	8247	Ruffler 121123 with 120819 and 160448, for 251-2 and 251-3 Machines
160496	8235	Throat Plate with 43525, for 121168
160497	8236	Throat Plate with 43525, for 121871
192349	8237	Binder Releasing Lever Spring Position Stud for 121733
200056E	23253	Bobbin Winder Stop Latch Screw for 259431 and 259462
200082D	23253	Bobbin Winder Tension Bracket Screw for 259431 and 259462
200113F	23253	Bobbin Winder Brake Clamp Screw for 259431 and 259462
200299B	23253	Bobbin Winder Stop Latch Trip Lever Hinge Screw for 259431 and 259462
200380C	23253	Bobbin Winder Pulley Set Screw for 225368 and 259461
200383C	23289	Thread Unwinder Spool Rest Rod Set Screw for 259658
201018C	23289	Thread Unwinder Spool Rest Set Screw for 225257
201499B	23253	Bobbin Winder Tension Stud for 225461
201528X	23289	Thread Unwinder Spool Pin Nut for 225257 (2)
201572B	23253	Bobbin Winder Tension Stud Thumb Nut for 225462
201696J	23289	Thread Unwinder Thread Guide Lock Nut for 225258
201699F	8251	Roller Ball Retaining Nut for 51901
202277	23253	Bobbin Winder Frame Oil Packing (wick) for 225453
202478	23253	Bobbin Winder Stop Latch Trip Lever for 259431 and 259462
206417	8251	Roller Ball, 1/16 in. diam., for 51901 (28)
225257	23289	Thread Unwinder Spool Rest with 201018C, and two each 201528X, 228692 and 228693, for 225258
225258	23289	Thread Unwinder complete, for two spools or two large cones of thread, Nos. 201696J, 225257, 225324, 225326, 225388, 259658, two each 150203, 225391 and three wood screws 7/8 in. No. 12 F.H.
225322	23289	Thread Unwinder Thread Guide Rod Washer for 225324
225324	23289	Thread Unwinder Thread Guide Rod with 208AL and 225322, for 225258
225326	23289	Thread Unwinder Thread Guide Position Cup for 225258
225368	23253	Bobbin Winder Pulley with 200380C, for 259431
225381	23253	Bobbin Winder Spindle for 259431 and 259462
225388	23289	Thread Unwinder Spool Rest Rod for 225258
225390	23289	Thread Unwinder Thread Cone Holder, for inverted cones for 225258
NOTE: No. 225390 is used with, but not included in No. 225258.		
225391	23289	Thread Unwinder Thread Guide for 225258 (2)
225444	23253	Bobbin Winder Stop Latch for 259431 and 259462
225453	23253	Bobbin Winder Frame with 202277 and 259660, for 259431 and 259462
225454	23253	Bobbin Winder Frame Hinge Pin for 259431 and 259462
225455	23253	Bobbin Winder Frame Spring for 259431 and 259462
225456	23253	Bobbin Winder Frame Spring Plunger for 259431 and 259462
225458	23253	Bobbin Winder Stop Latch Thumb Lever for 259431 and 259462
225459	23253	Bobbin Winder Stop Latch Thumb Lever Hinge Stud for 259431 and 259462
225459	23253	Bobbin Winder Stop Latch Thumb Lever Joint Stud for 259431 and 259462
225461	23253	Bobbin Winder Tension Bracket with 201499B, for 225462
225462	23253	Bobbin Winder Tension Bracket complete, for 259431 and 259462, Nos. 13710, 201572B, 225461 and two 2102
228026	23253	Bobbin Winder Tension Bracket Screw Washer for 259431 and 259462
228476	8234	Screw Driver (Accessories)

No.	Plate	Name
228692	23289	Thread Unwinder Spool Pin for 225257 (2)
228693	23289	Thread Unwinder Spool Pin Washer for 225257 (2)
240439	8239	Face Plate Thread Lubricator Oil Pad Retainer for 147116
241755	8239	Face Plate Thread Lubricator Oil Pad (felt) for 147116
259428	23253	Bobbin Winder Brake (leather) for 259431 and 259462
259429	23253	Bobbin Winder Brake Clamp for 259431 and 259462
259430	23253	Bobbin Winder and Tension Bracket Base for 259431
259431	23253	Bobbin Winder, (round belt) complete, Nos. 200056E, 200082D, 200113F, 200299B, 202478, 225368, 225381, 225444, 225453, 225454, 225445, 225456, 225458, 225462, 228026, 259428, 259429, 259430 and two each 225459 and wood screws 3/4 in. No. 12 R.H.B.
259461	23253	Bobbin Winder Pulley with 200380C, for 259462
259462	23253	Bobbin Winder (swinging automatic, right hand) complete, for Power Table "V" Belt drive, Nos. 200056E, 200082D, 200113F, 200299B, 202478, 225381, 225444, 225453, 225454, 225455, 225456, 225458, 225462, 228026, 259428 259429, 259461, 259662 and two each 225459 and wood screws 3/4 in. No. 12 R.H.
259477	8234	Screw Driver, 5 in. long (Accessories)
259658	23289	Thread Unwinder Spool Stand with 200383C, for 225258
259660	23253	Bobbin Winder Frame Oil Well Washer for 225453
259662	23253	Bobbin Winder and Tension Bracket Base for 259462
270083	8232	Rotating Hook Thread Guard for 143341
350104F	8251	Roller Screw for 51901

SINGER Needles should be used in SINGER Machines
 These Needles and their Containers are marked with the Company's Trade Mark "SIMANCO.**" 1

Needles in Containers marked "FOR SINGER MACHINES" are NOT SINGER made needles. 2

8214-1/3

251-1

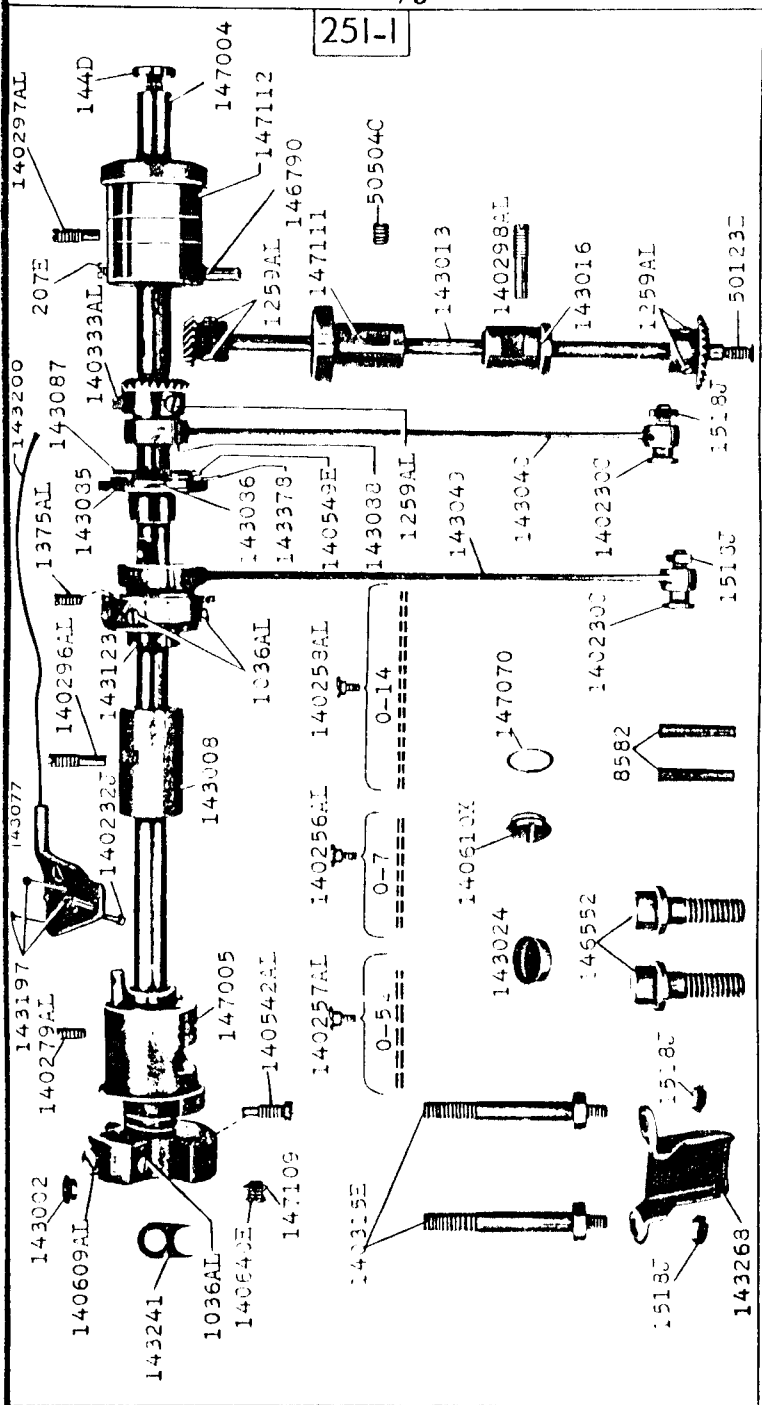

8217-1/2

251-1

147010

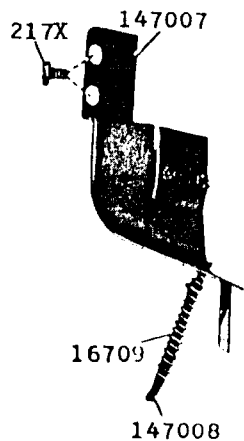

147078

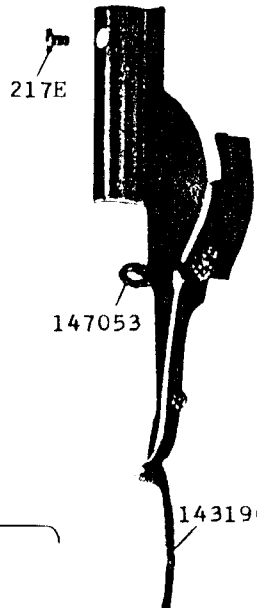

1364X 147056

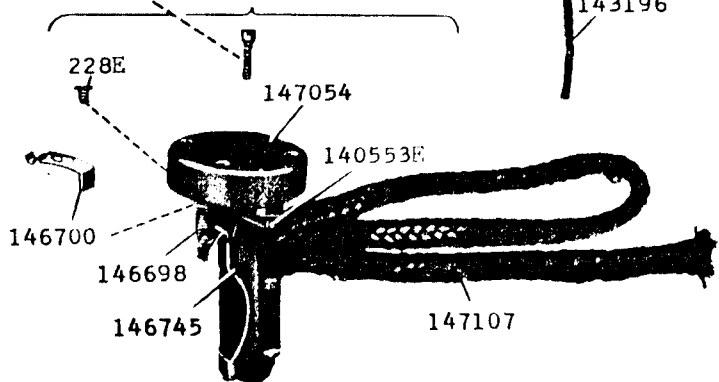

143196

147055



8218-1/2

251-2, 251-3

147086

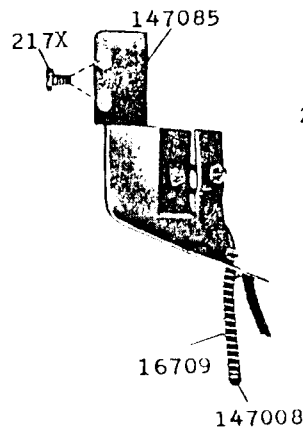

147078

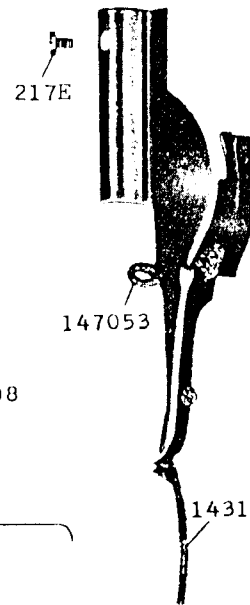

1364X 147056

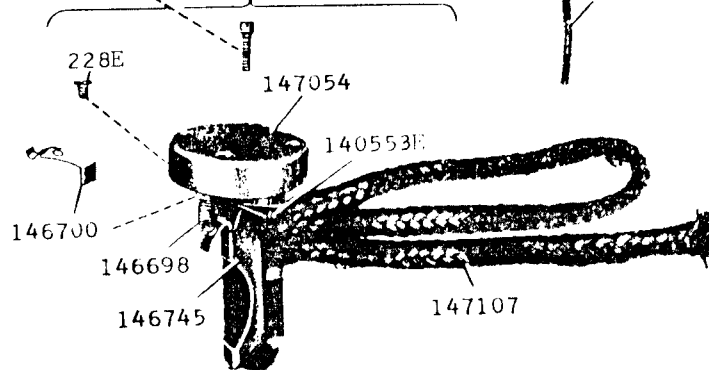

143196

147055



8221-1/2

147016

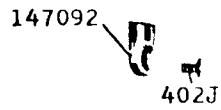
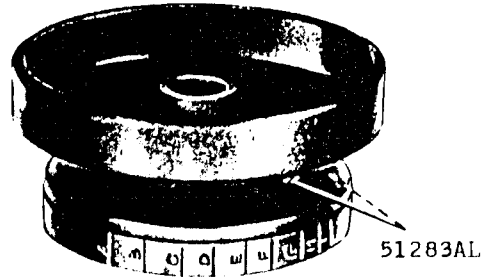

147011

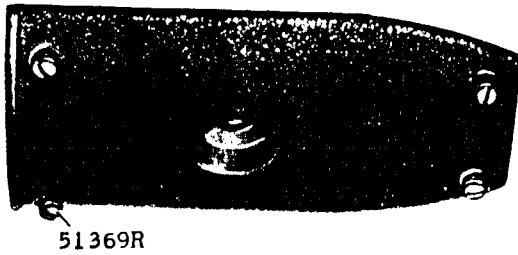

51369R

147015

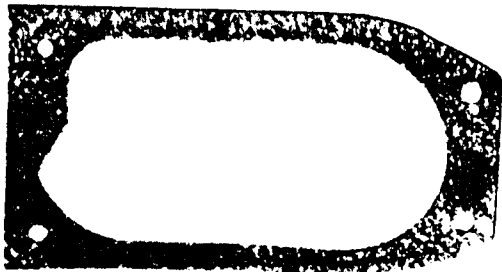

8222-1/2

147110

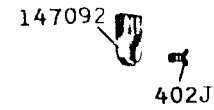
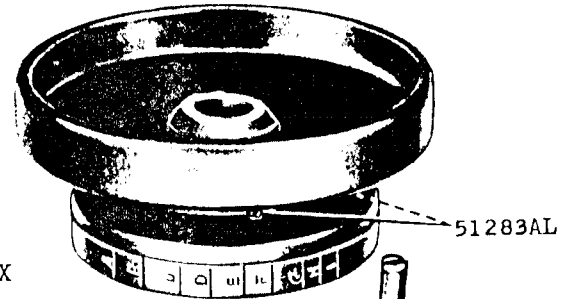

143244

147012

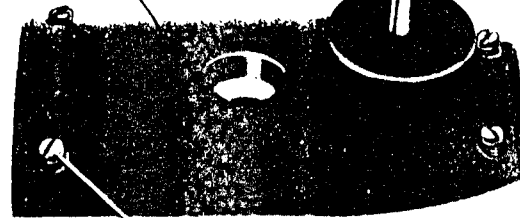

51369R

147015

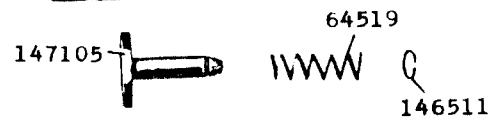
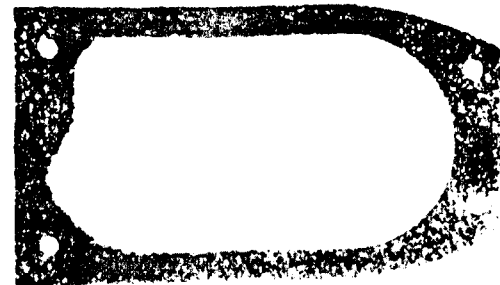

8223-2/3

251-1

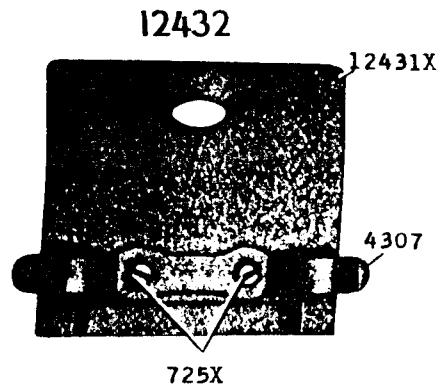
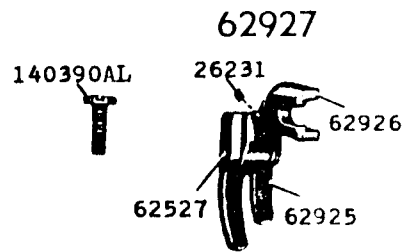
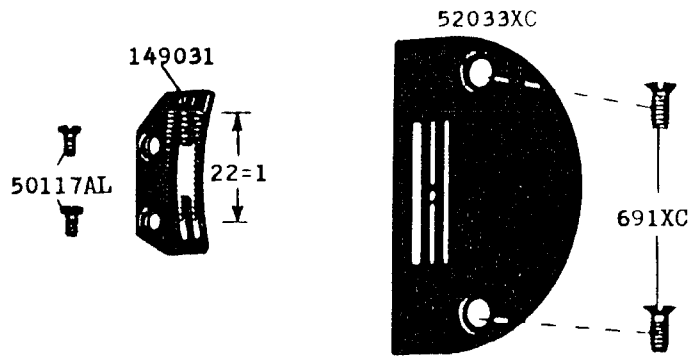

8224-2/3

251-2

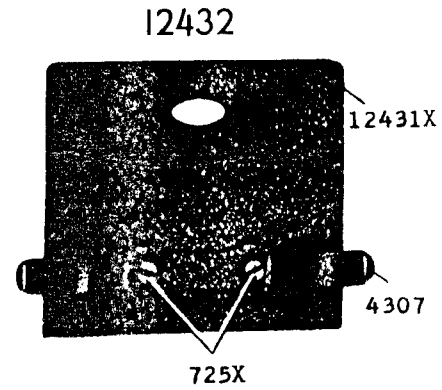
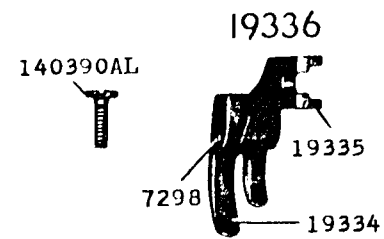
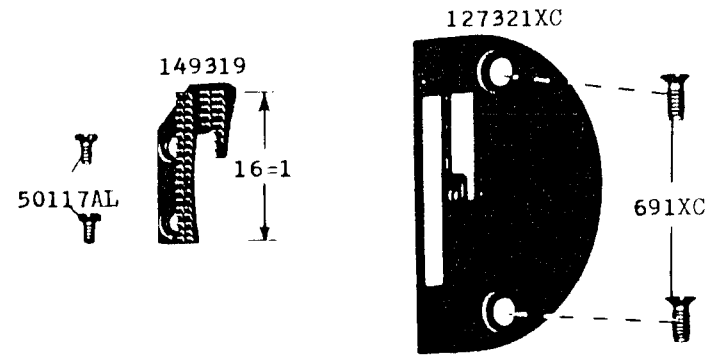

8225-2/3

251-3

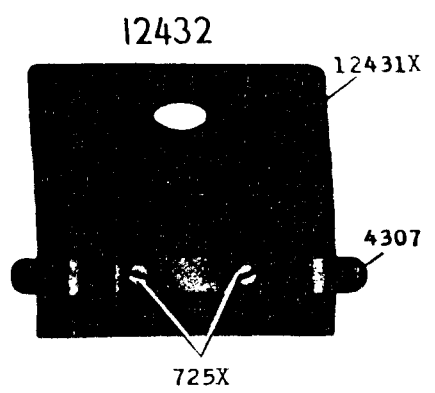
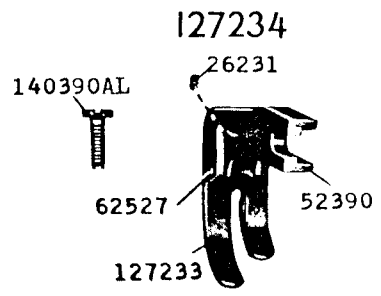
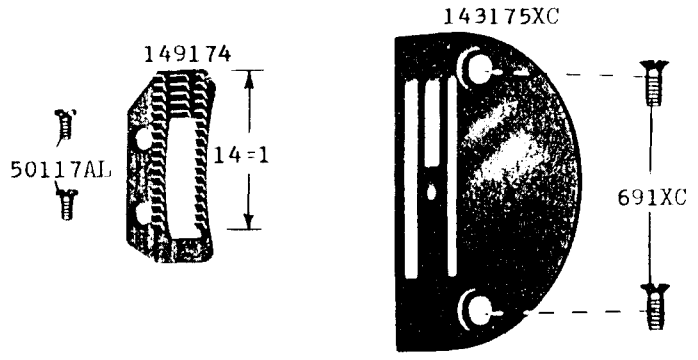

8226-1/2

251 #
25107
o/b/m

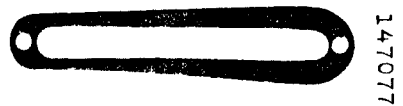
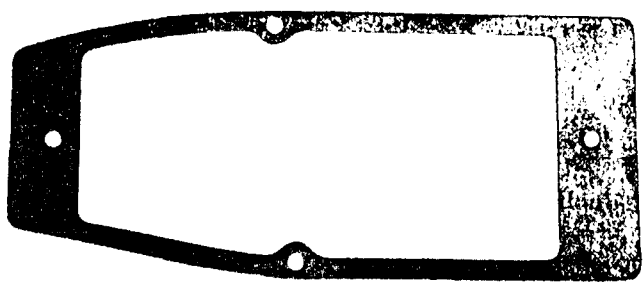
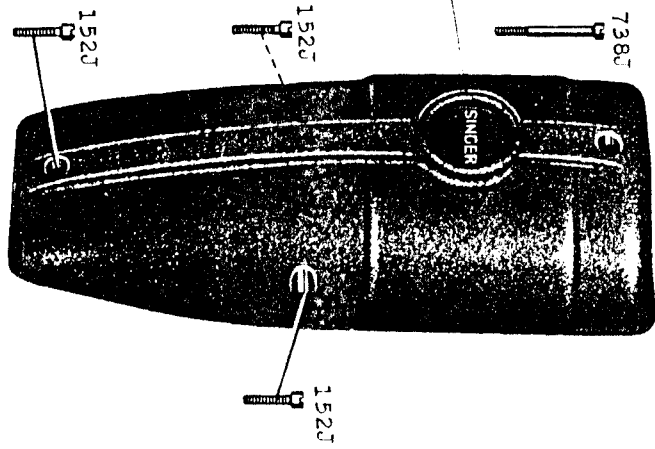

8229-1/2

251-2

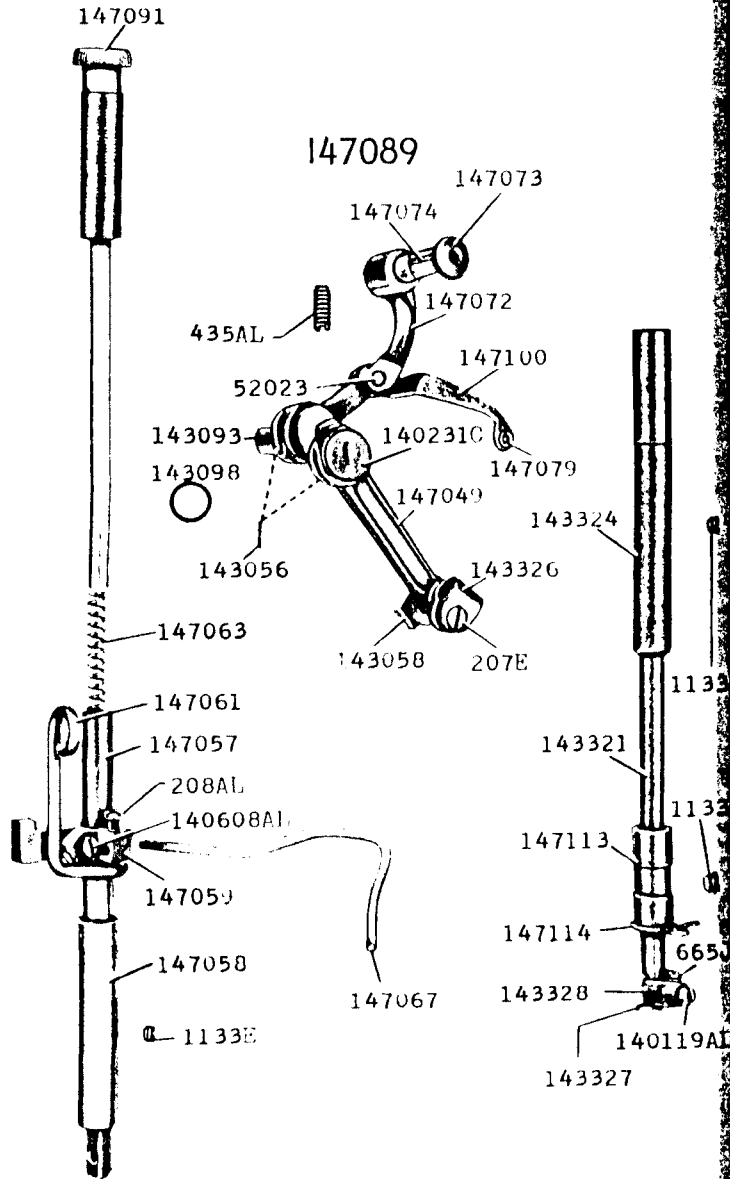

8230-1/2

251-3

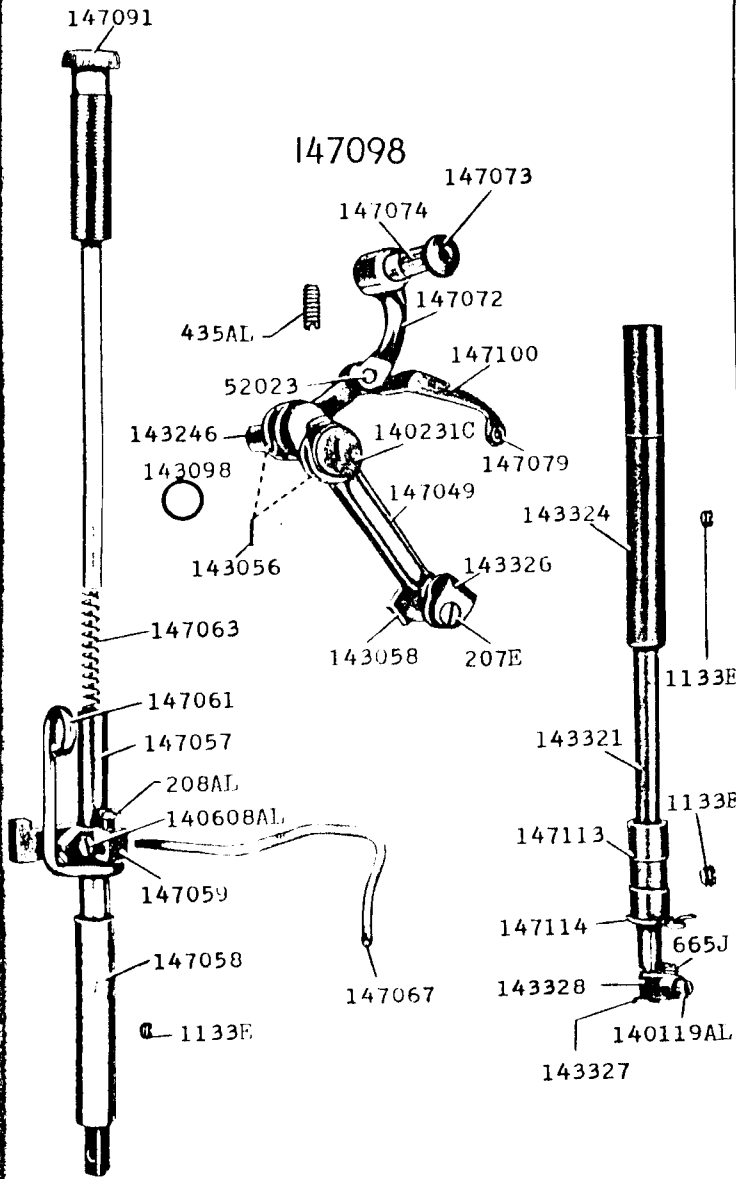

8231-1/2

8232-1/2

147106

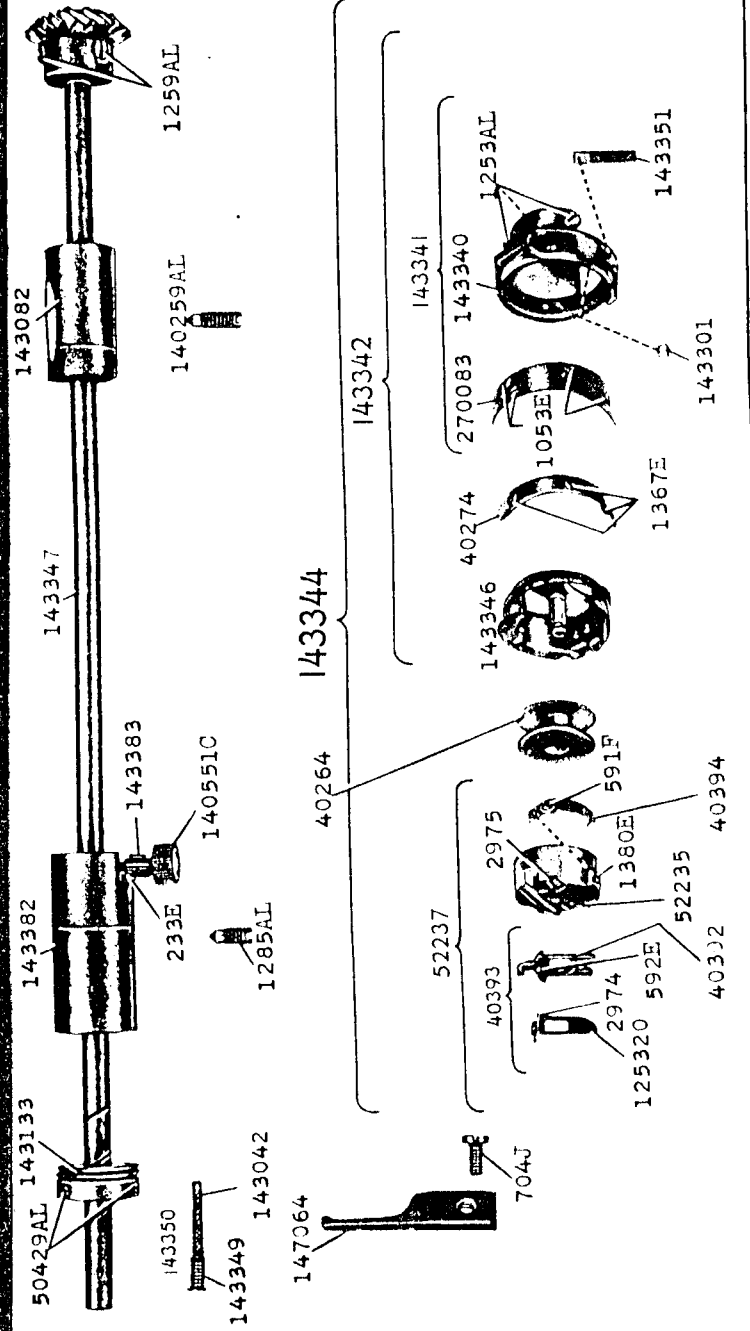
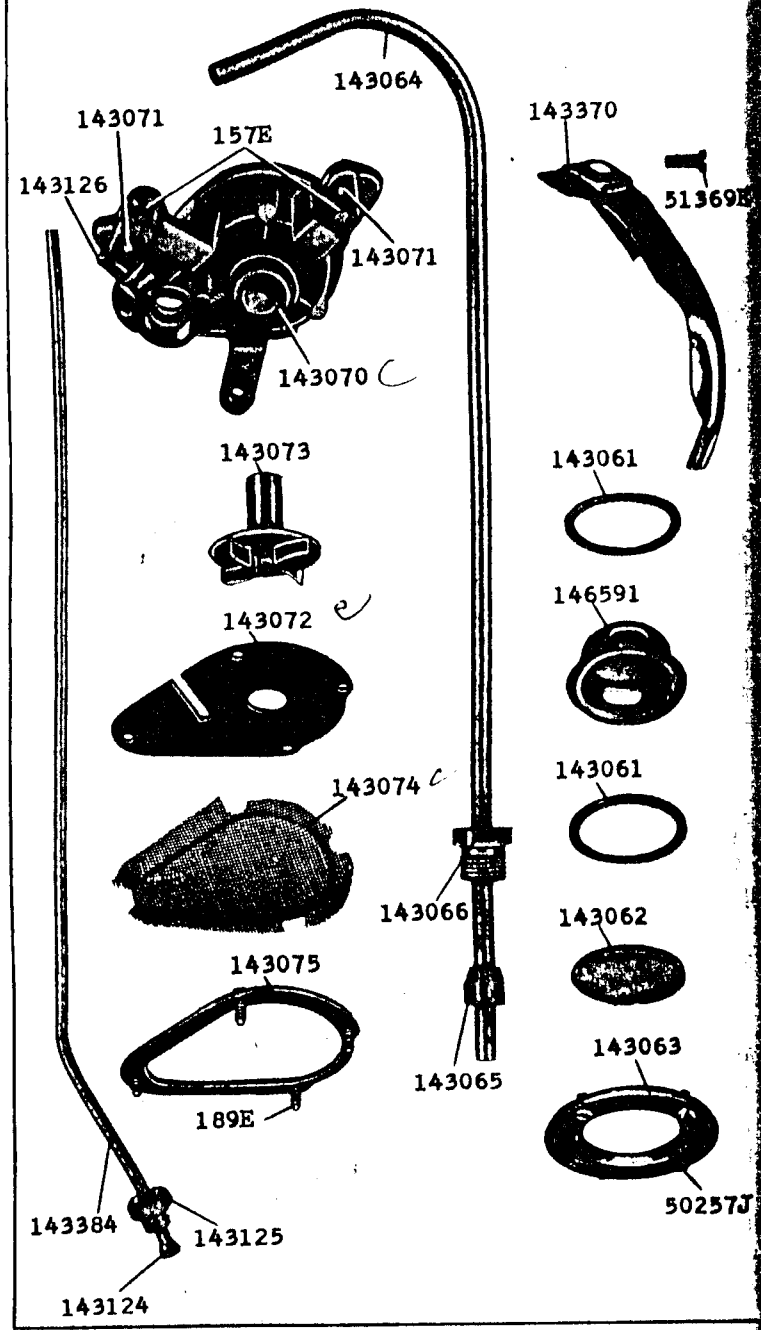

8233-2/3

143294

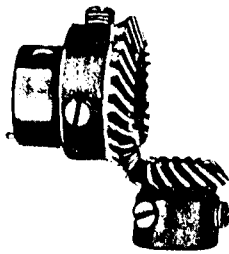

147066



8234-2/3

121741

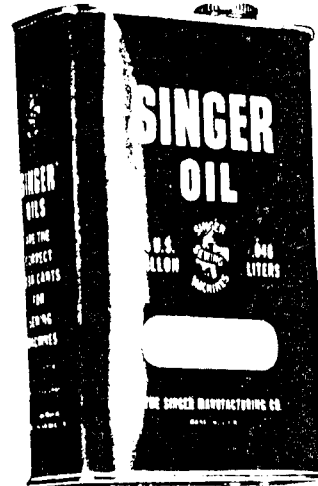

228476



259477



120440



50190J

25878

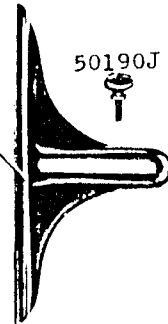

12361



143308



146057

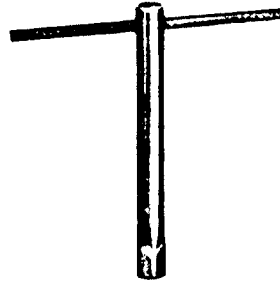

8908



11140



41564



8235-2/3

251-2, 251-3

121168

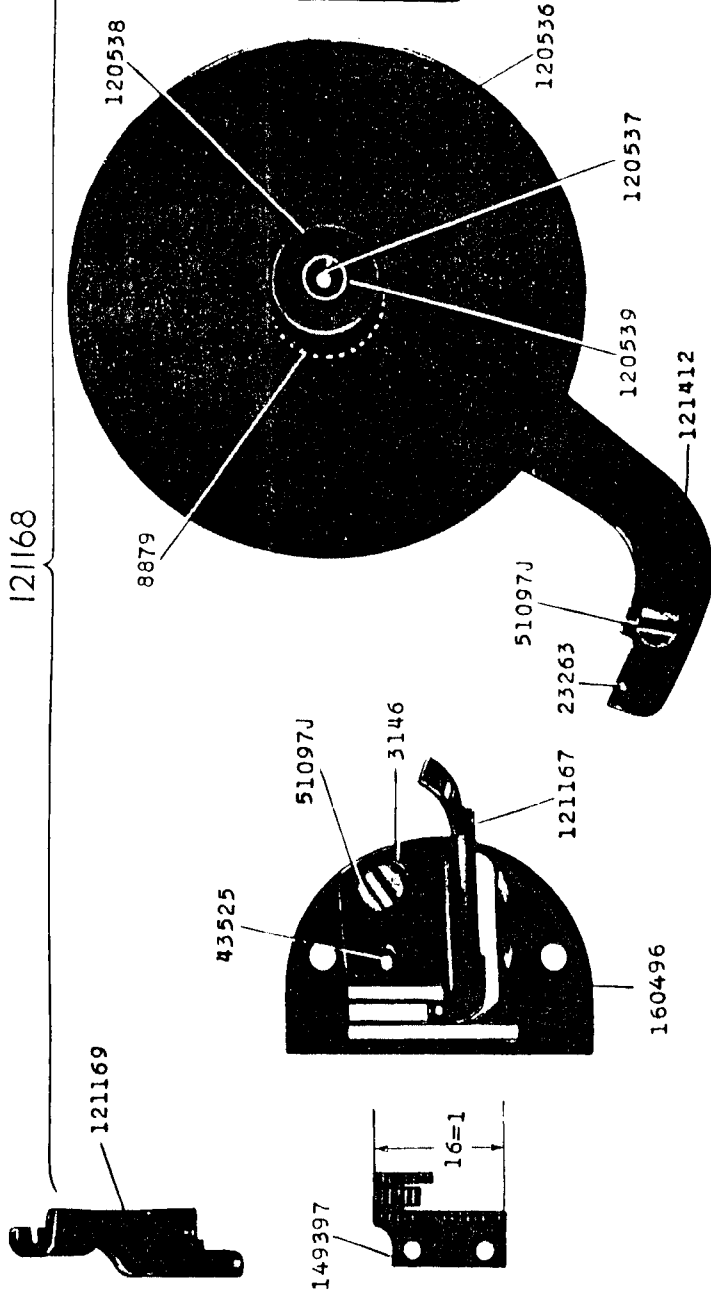

8236-2/3

251-1

121871

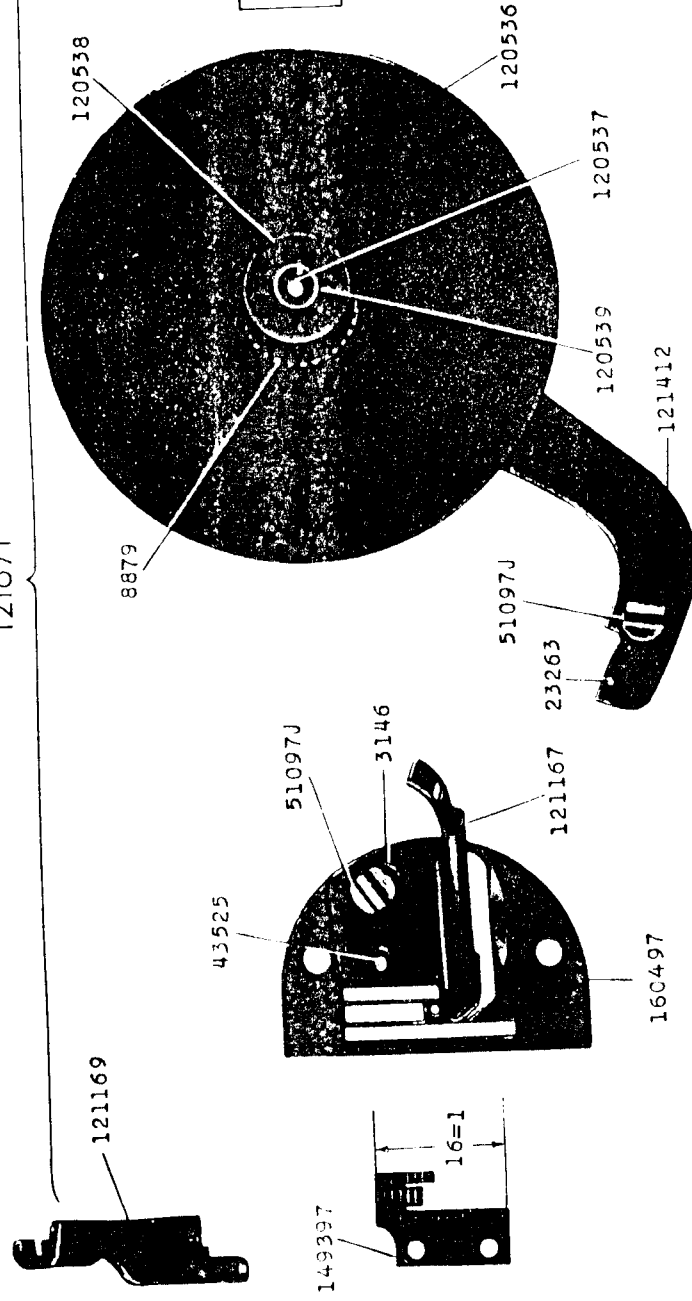

8239-2/3

147118

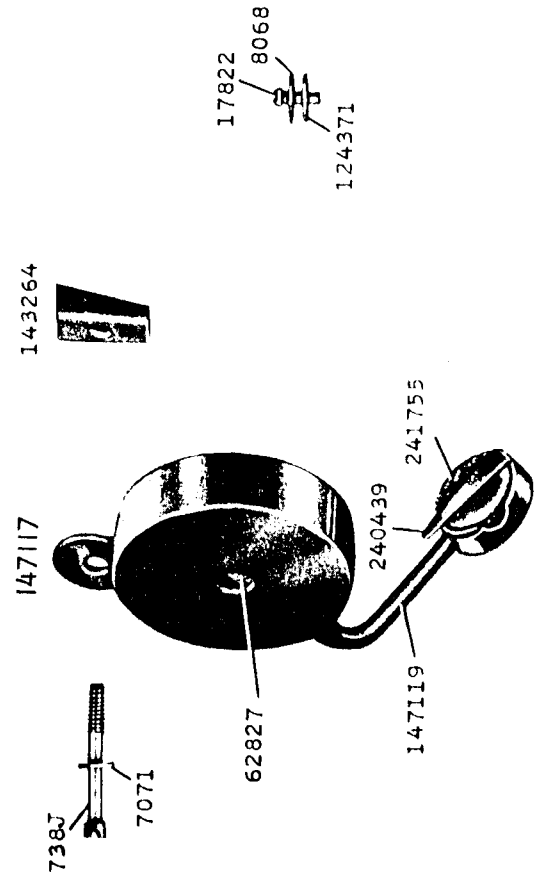

8240-2/3

251-1

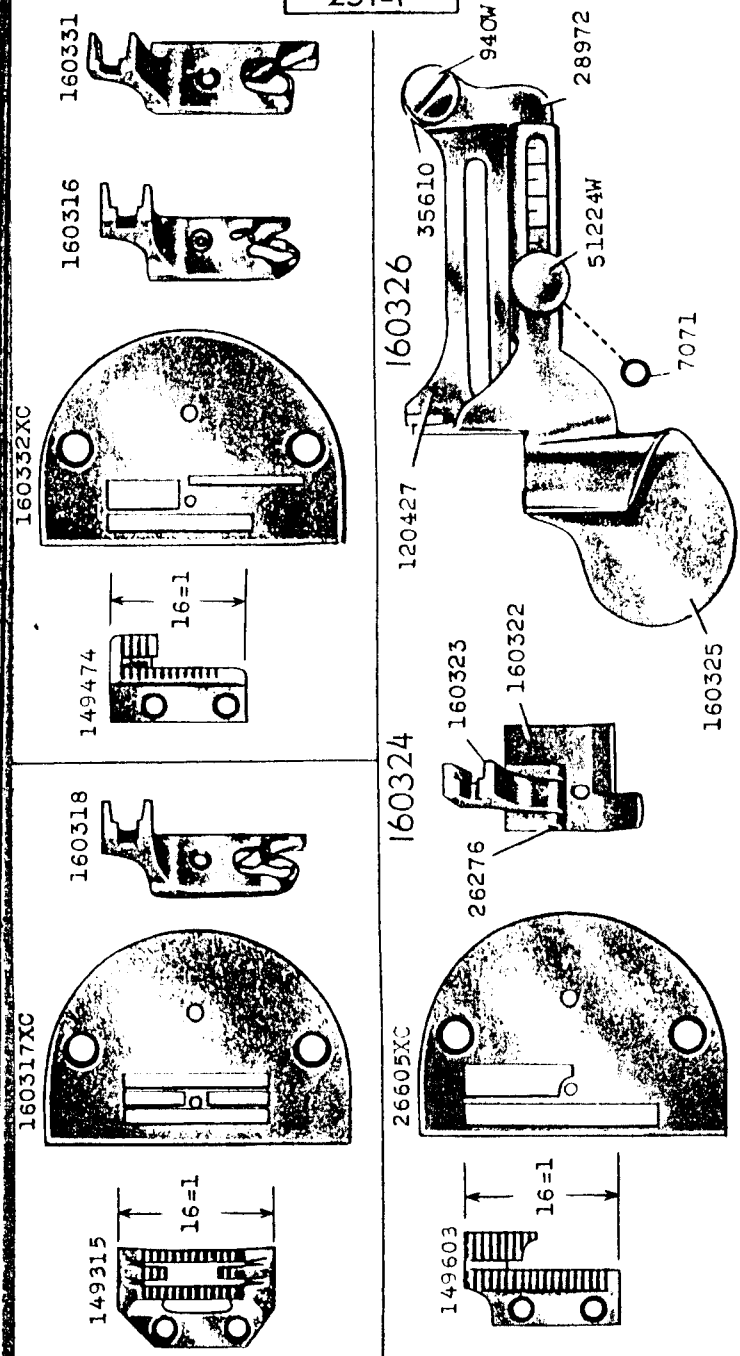

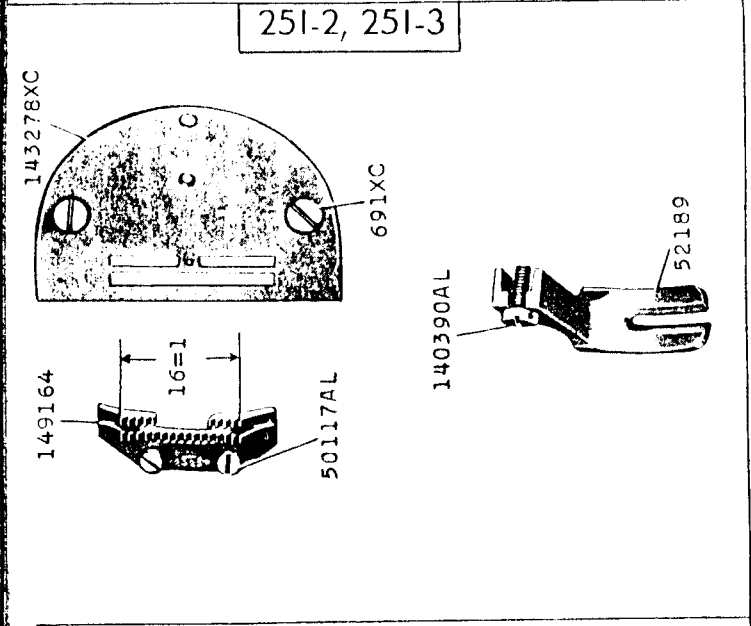
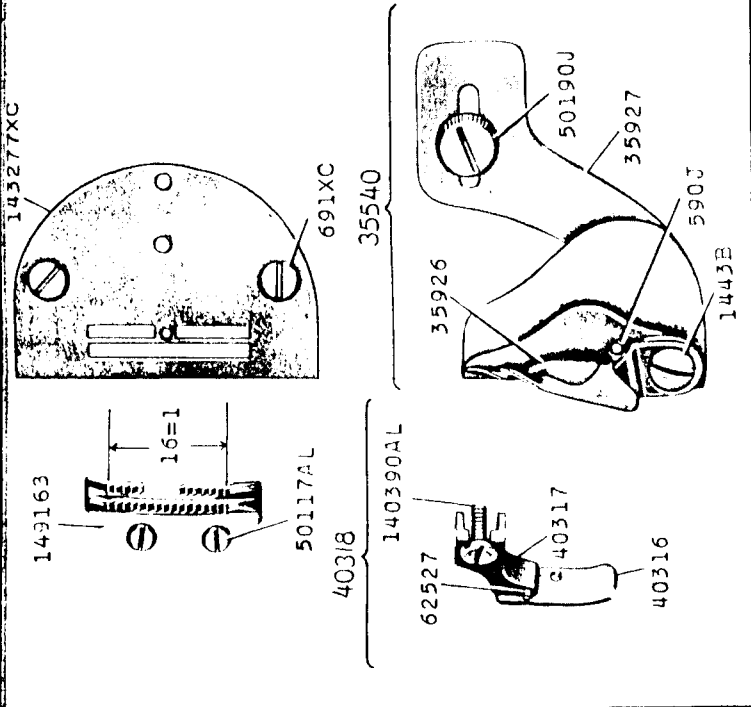
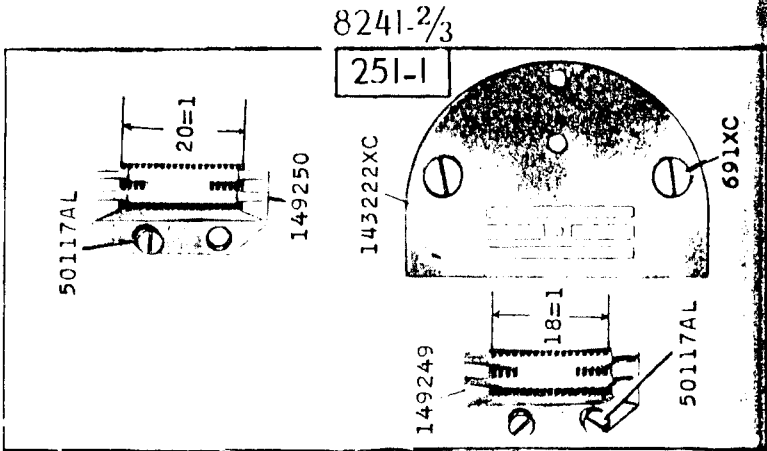
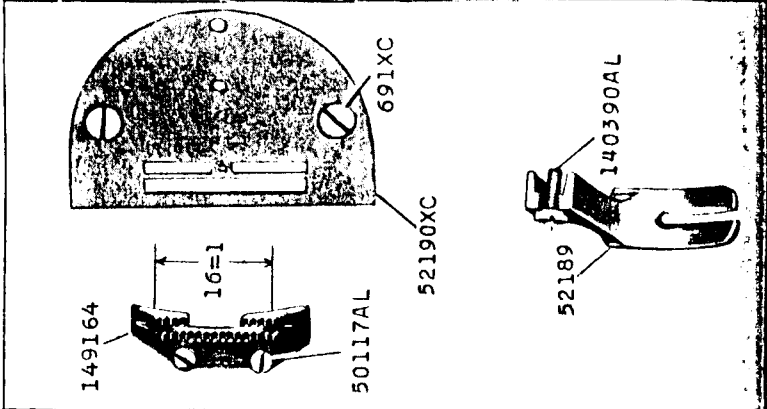
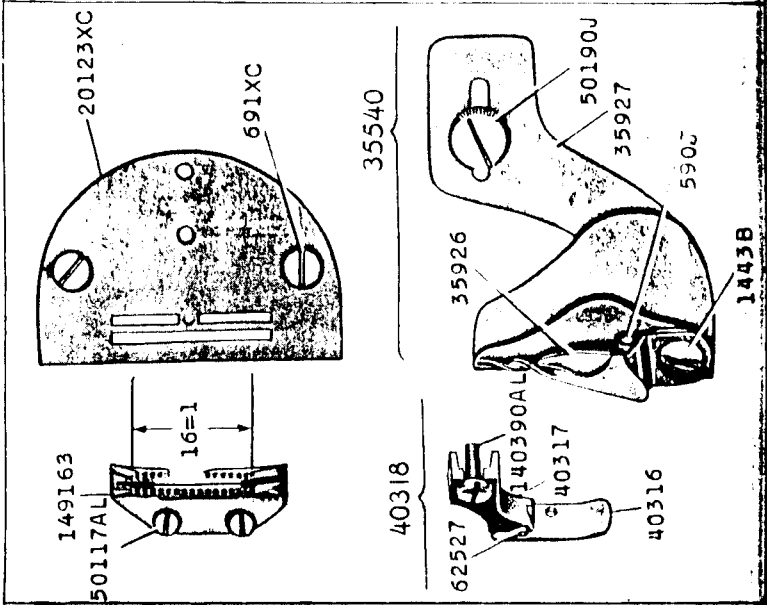

8243-2/3

8244-2/3

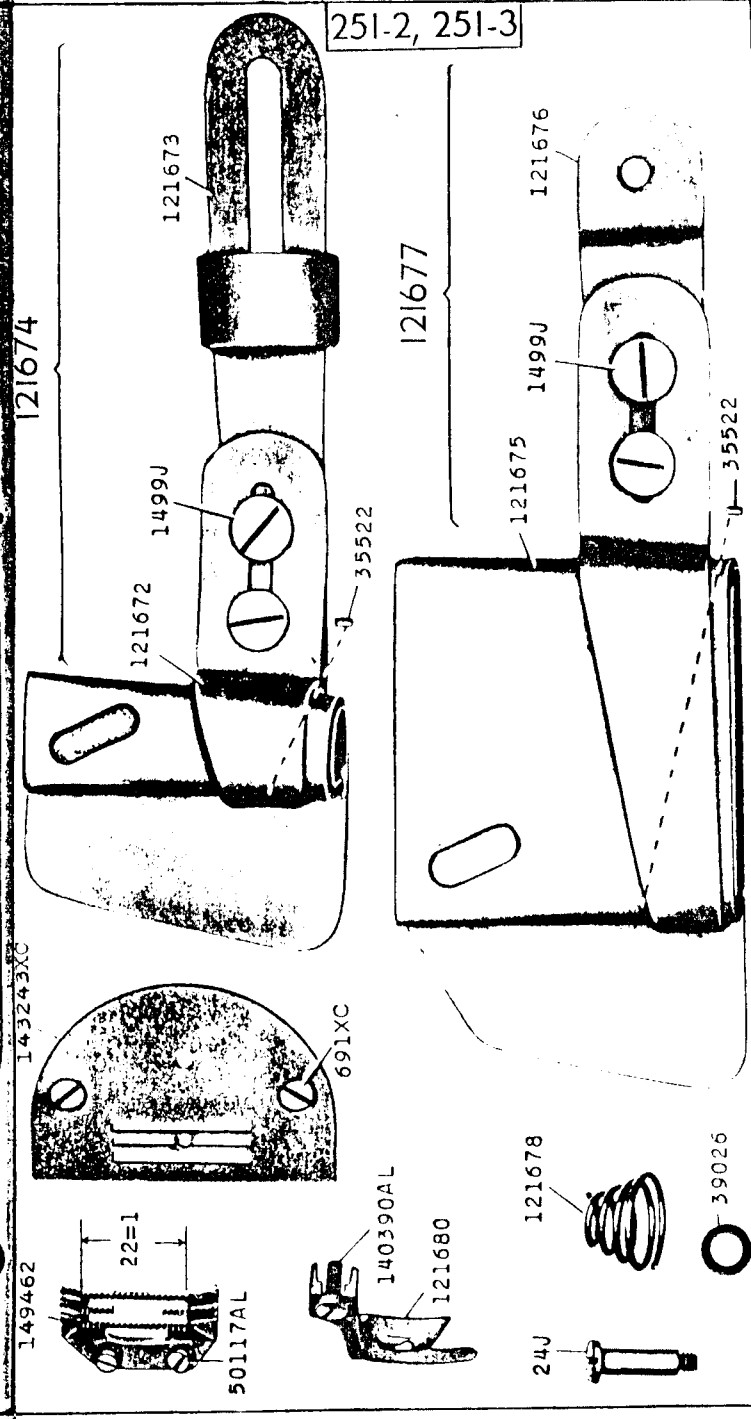
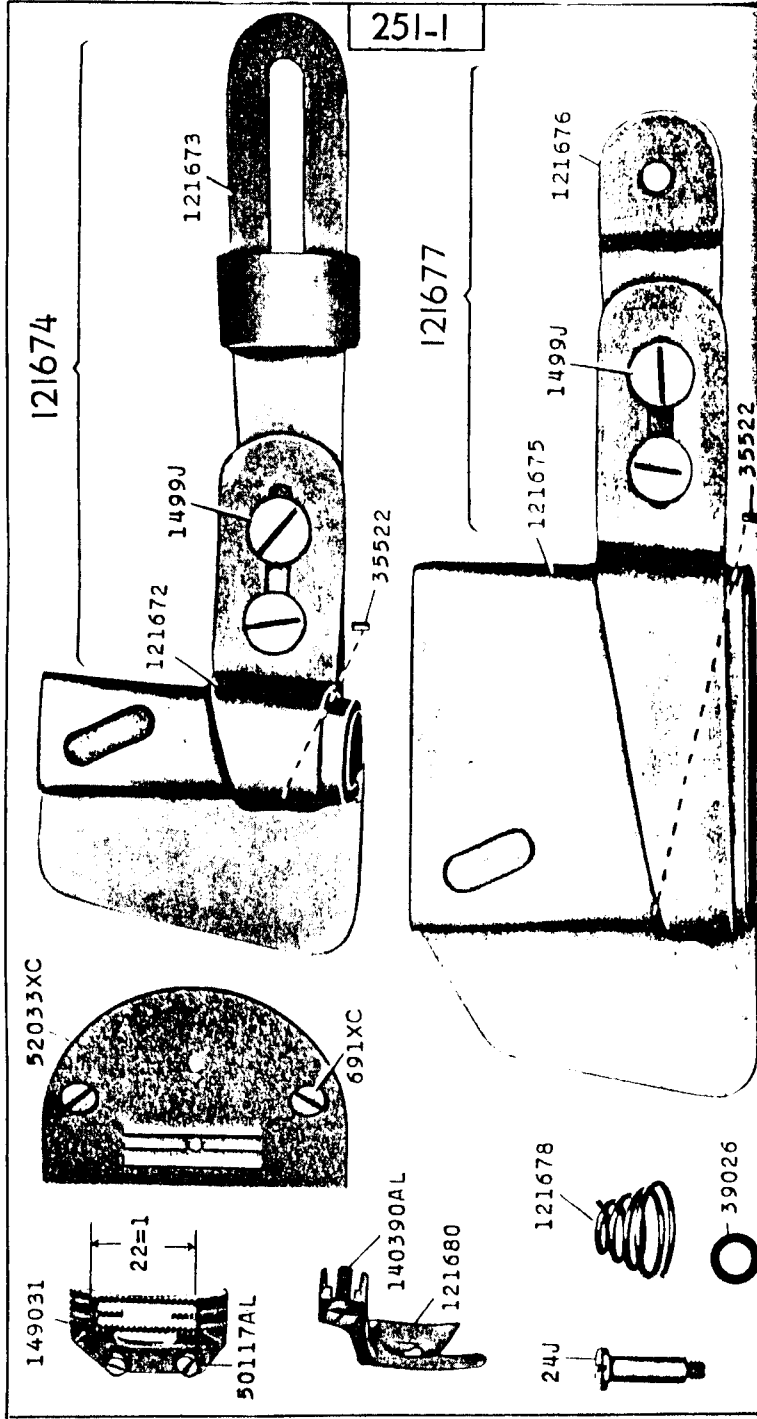

251-1

251-2, 251-3

8247-2/3

251-2, 251-3

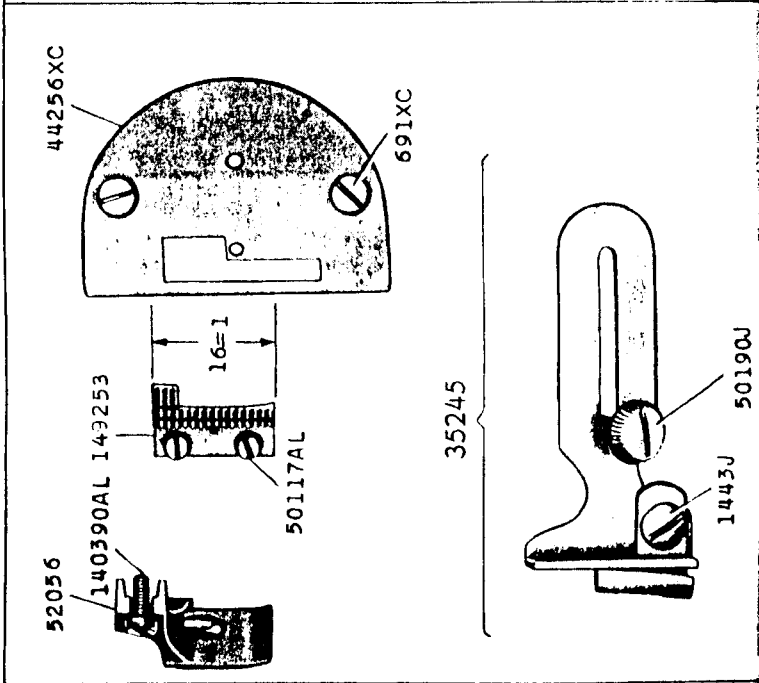
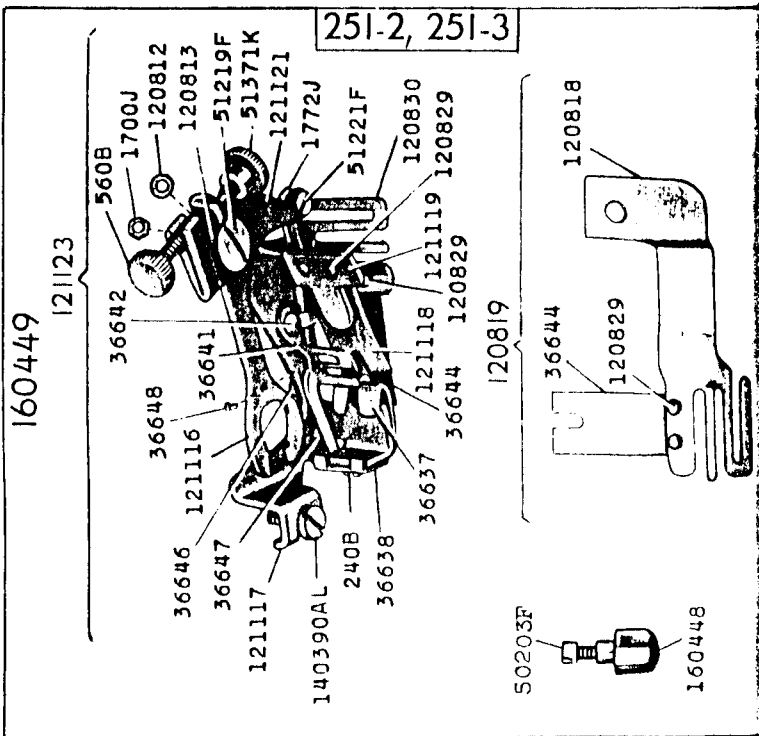

8248-2/3

251-1

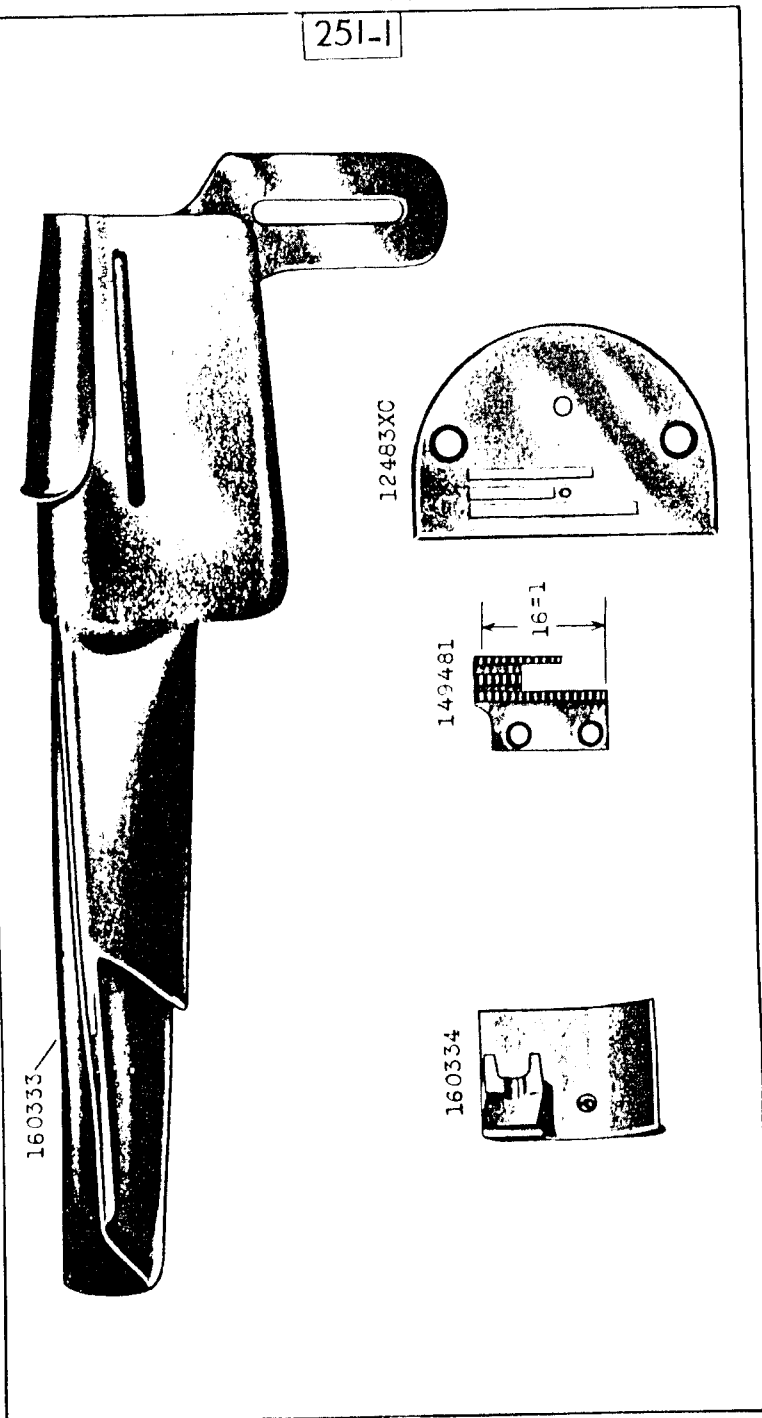

8249-2/3

251-1

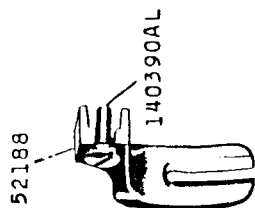
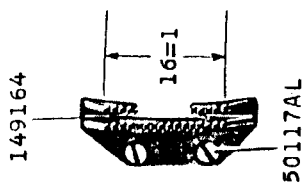
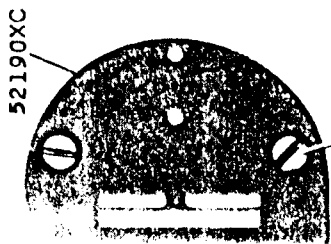
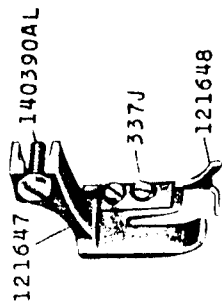
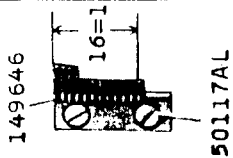
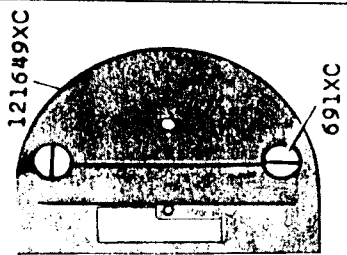
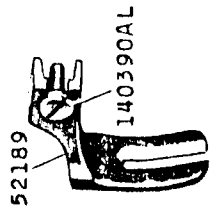
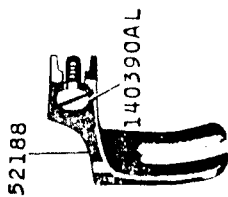
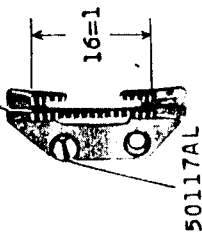
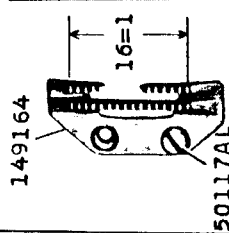
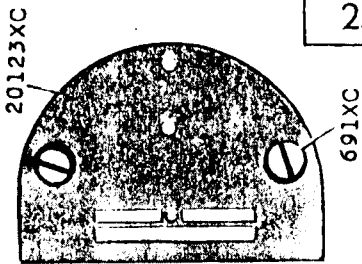

8250-2/3

251-1

160321

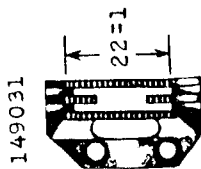
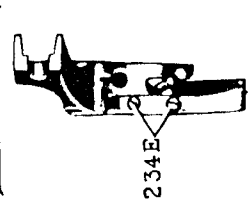

52033XC

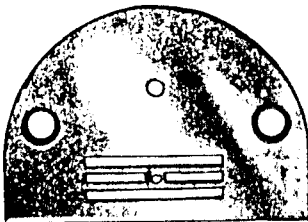

160319

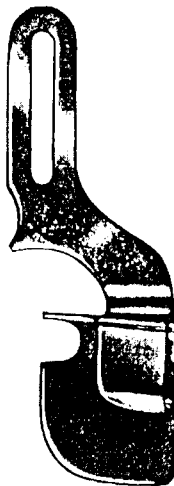

8251-2/3

19464

251-2, 251-3

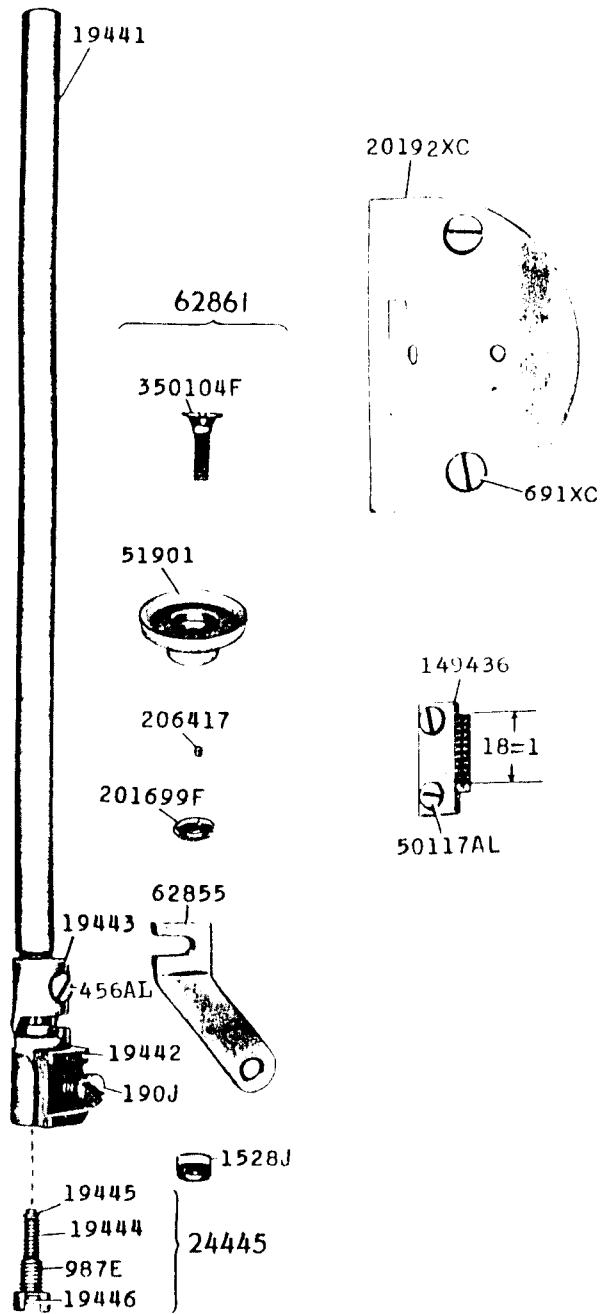

22920 - 2/3

120742

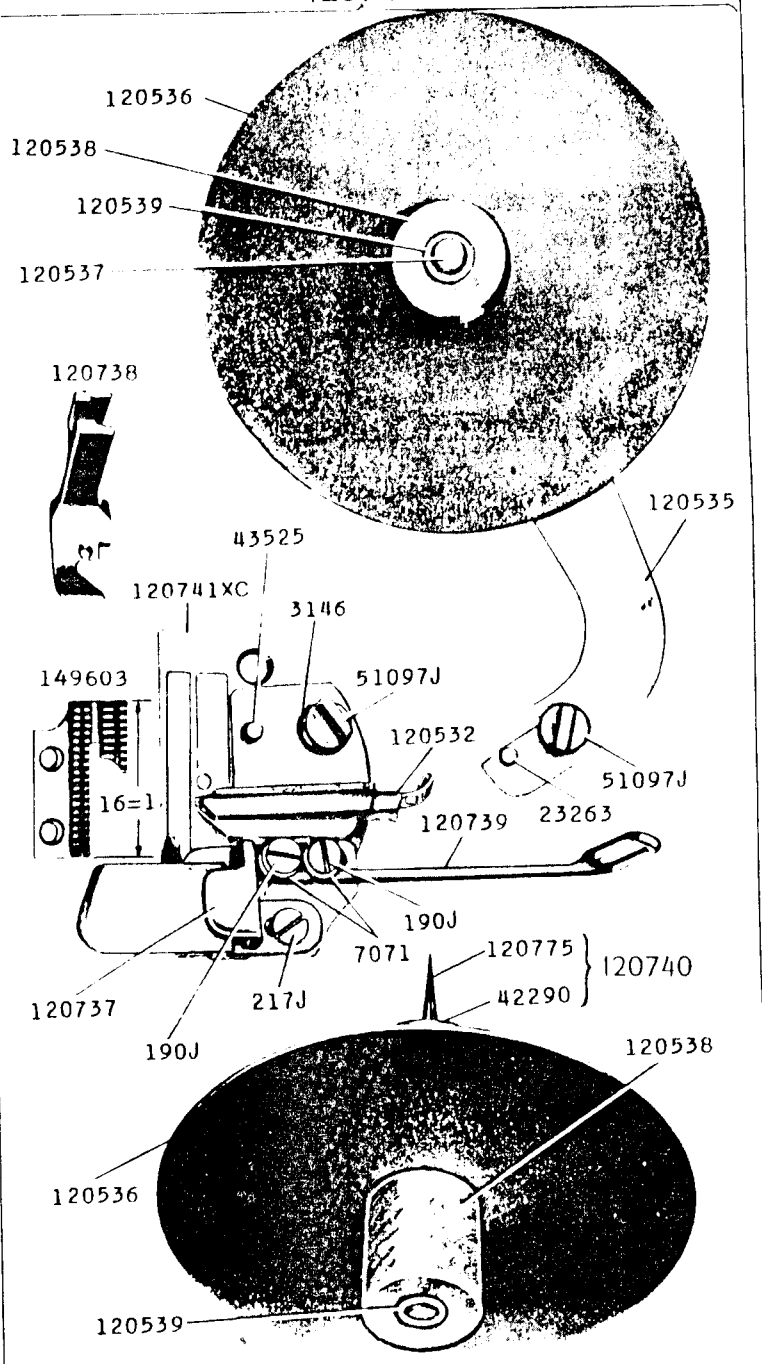

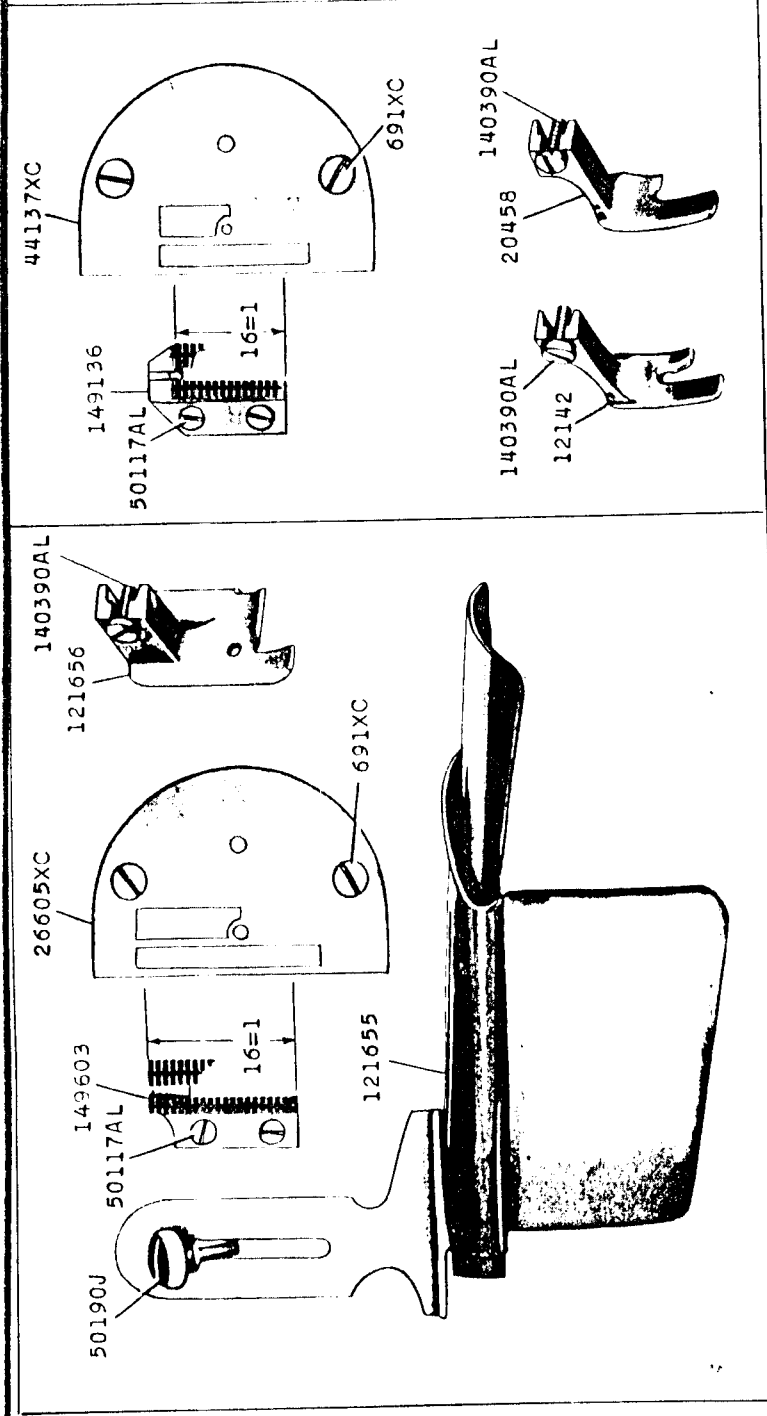
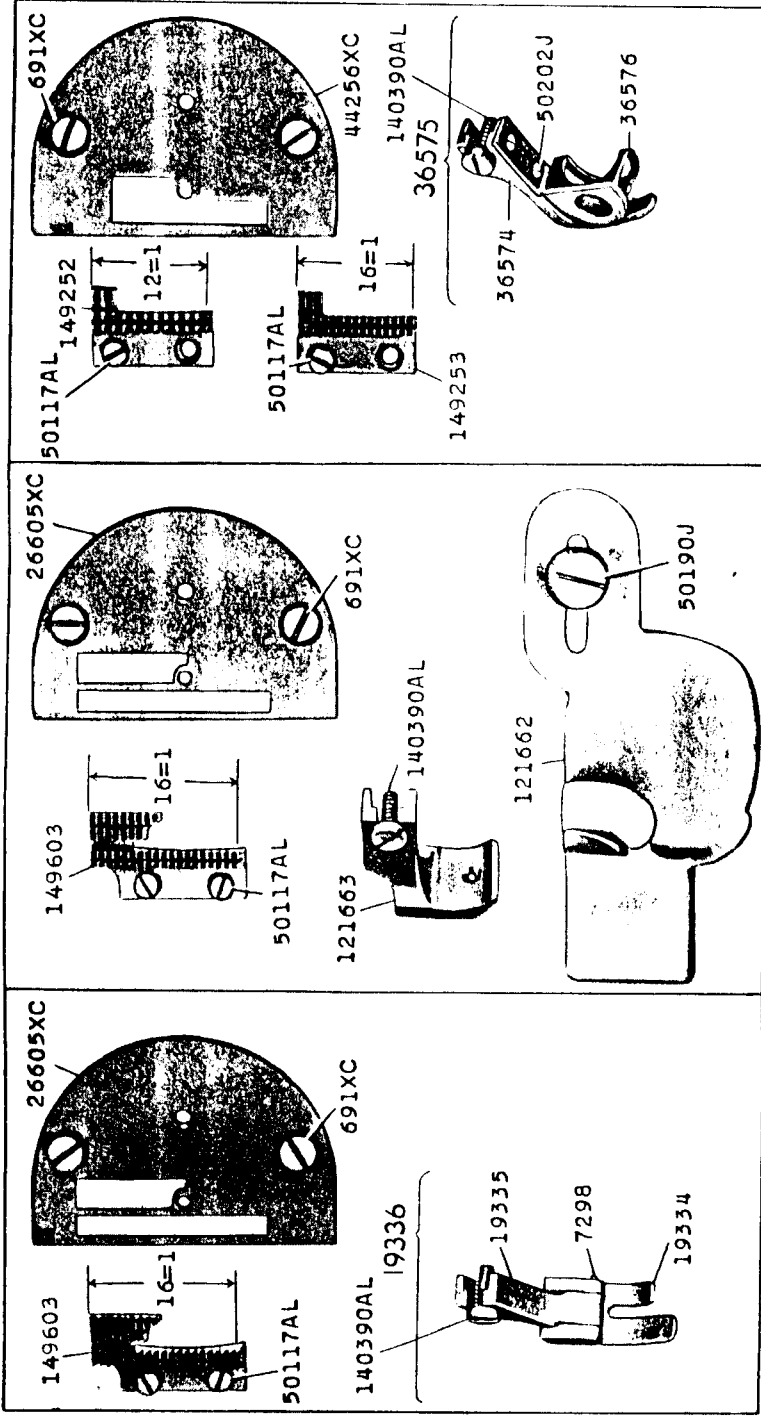

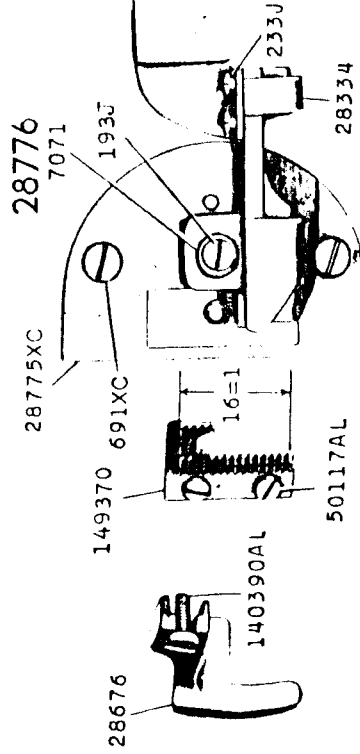
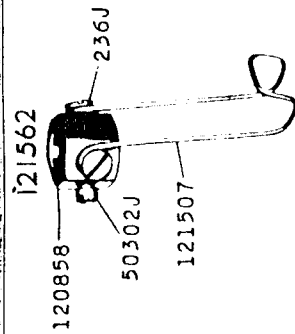
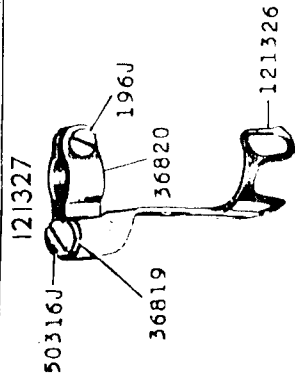
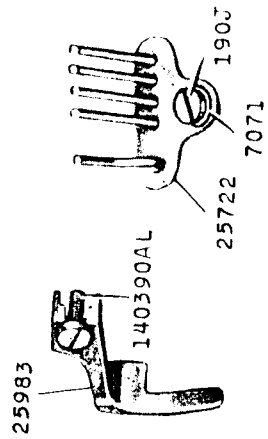
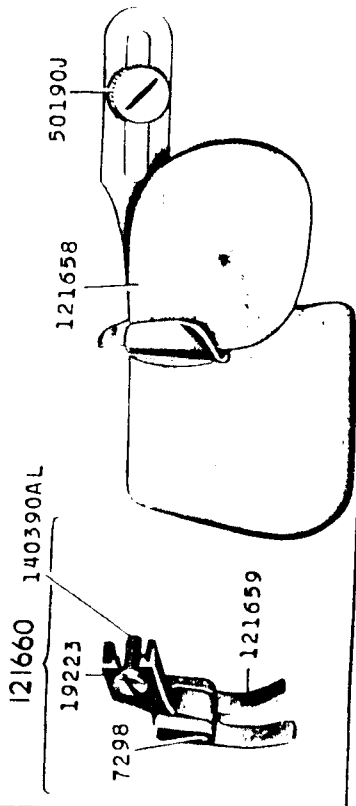
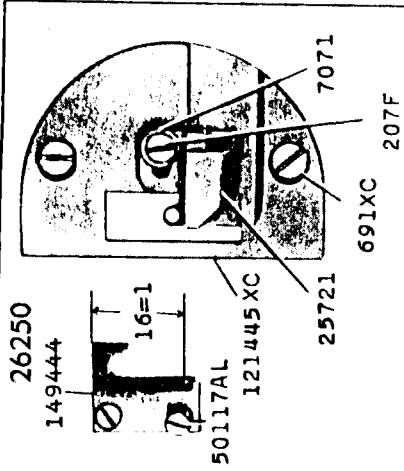
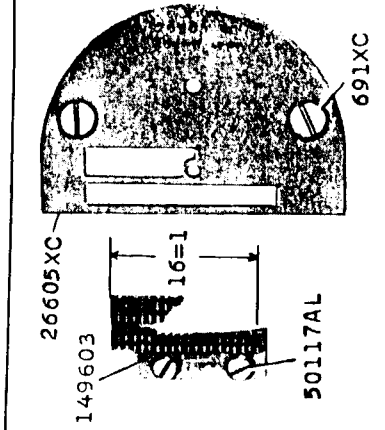
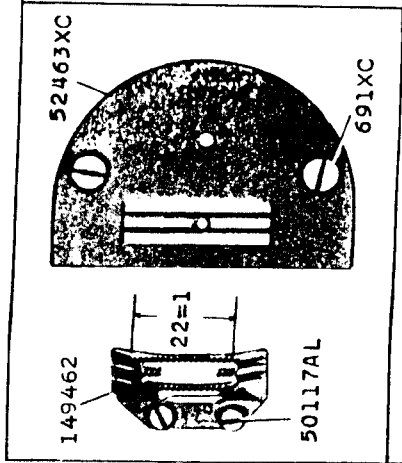

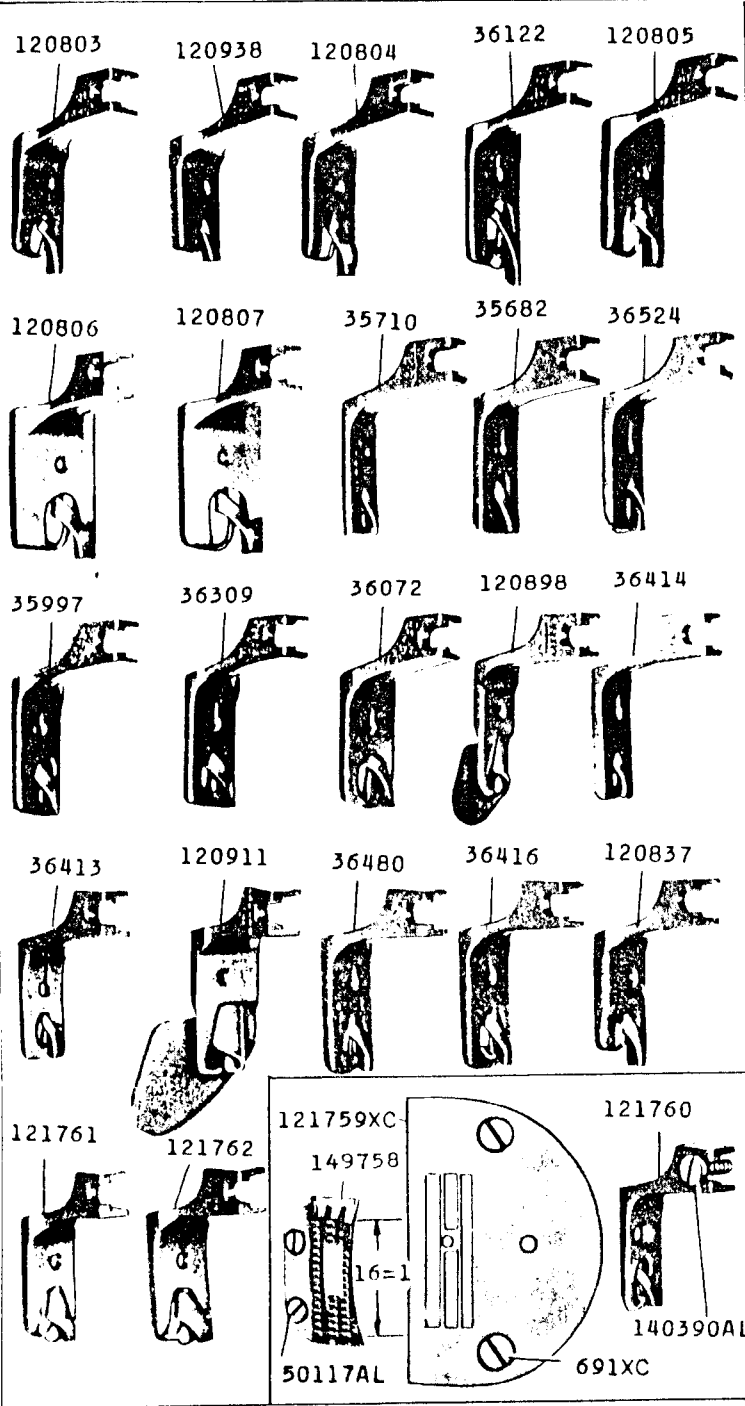
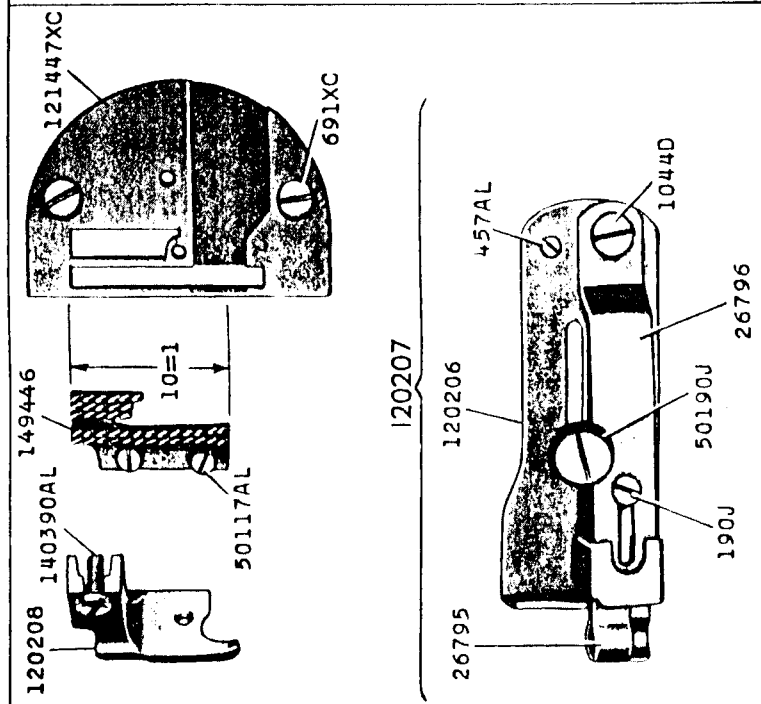
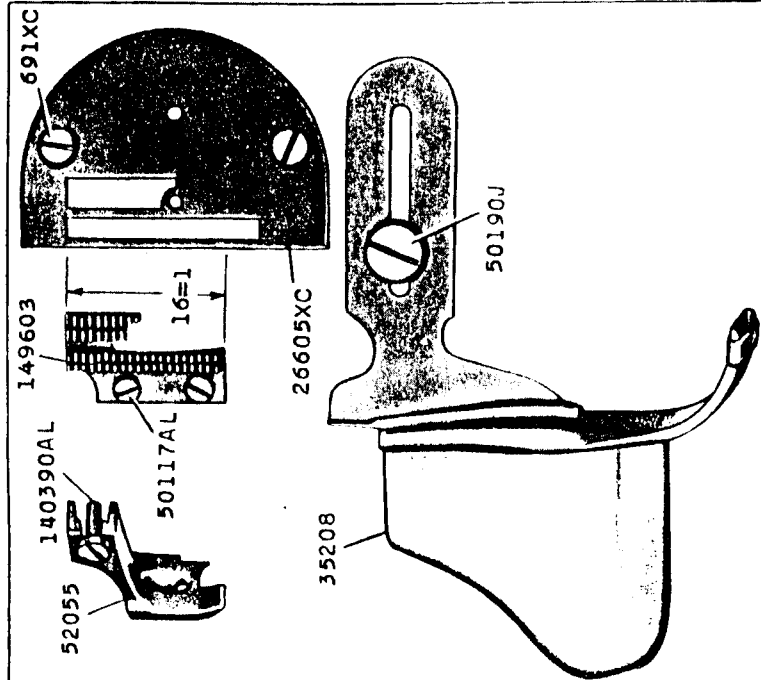

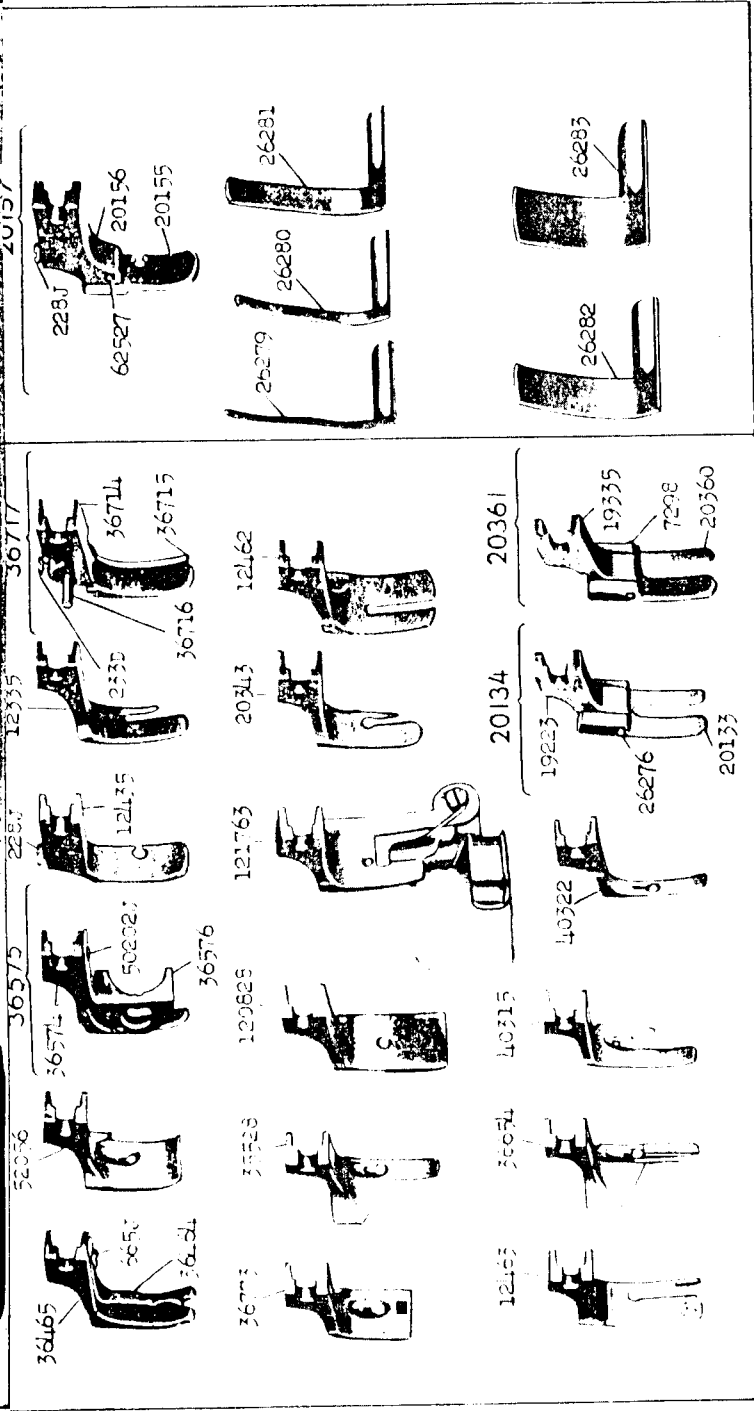
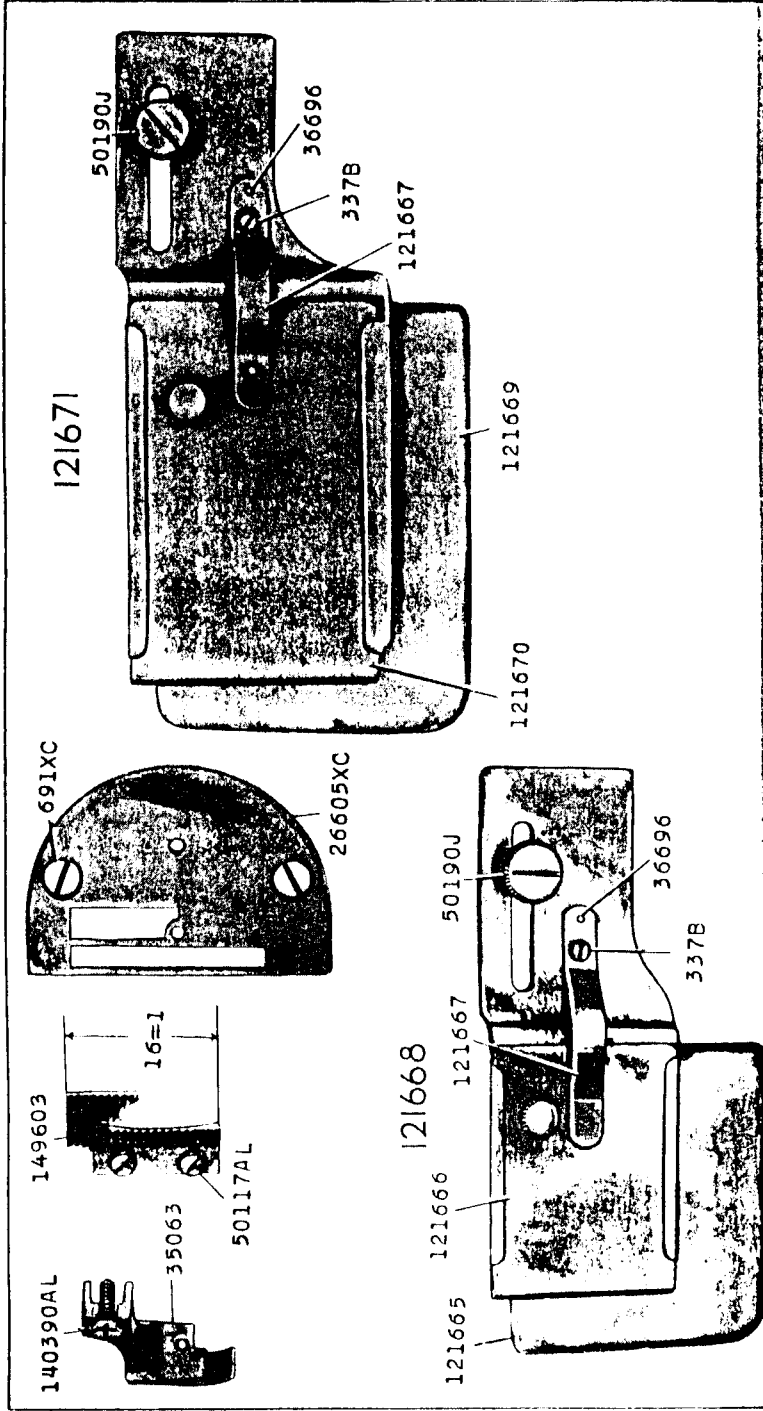

23253 - 3/8

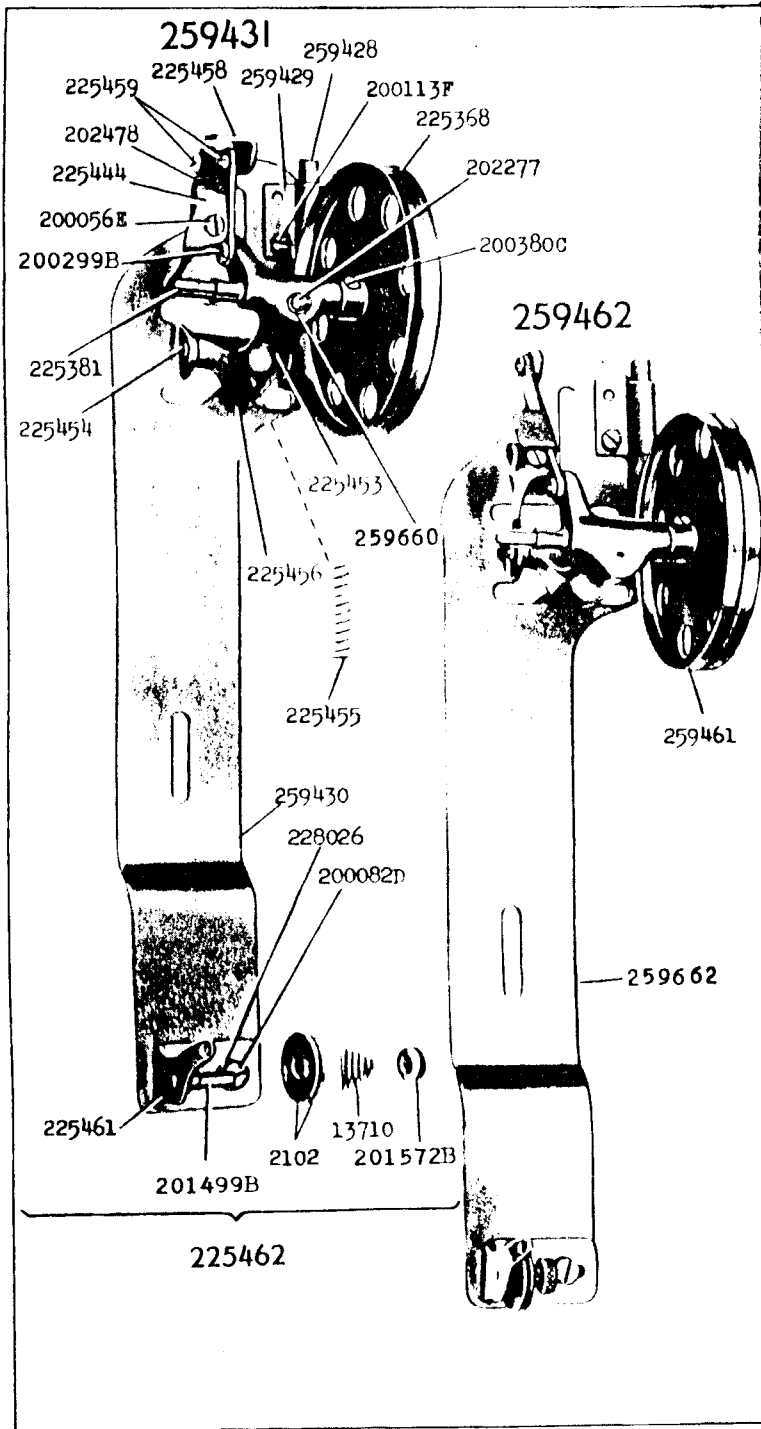

23255 - 2/3

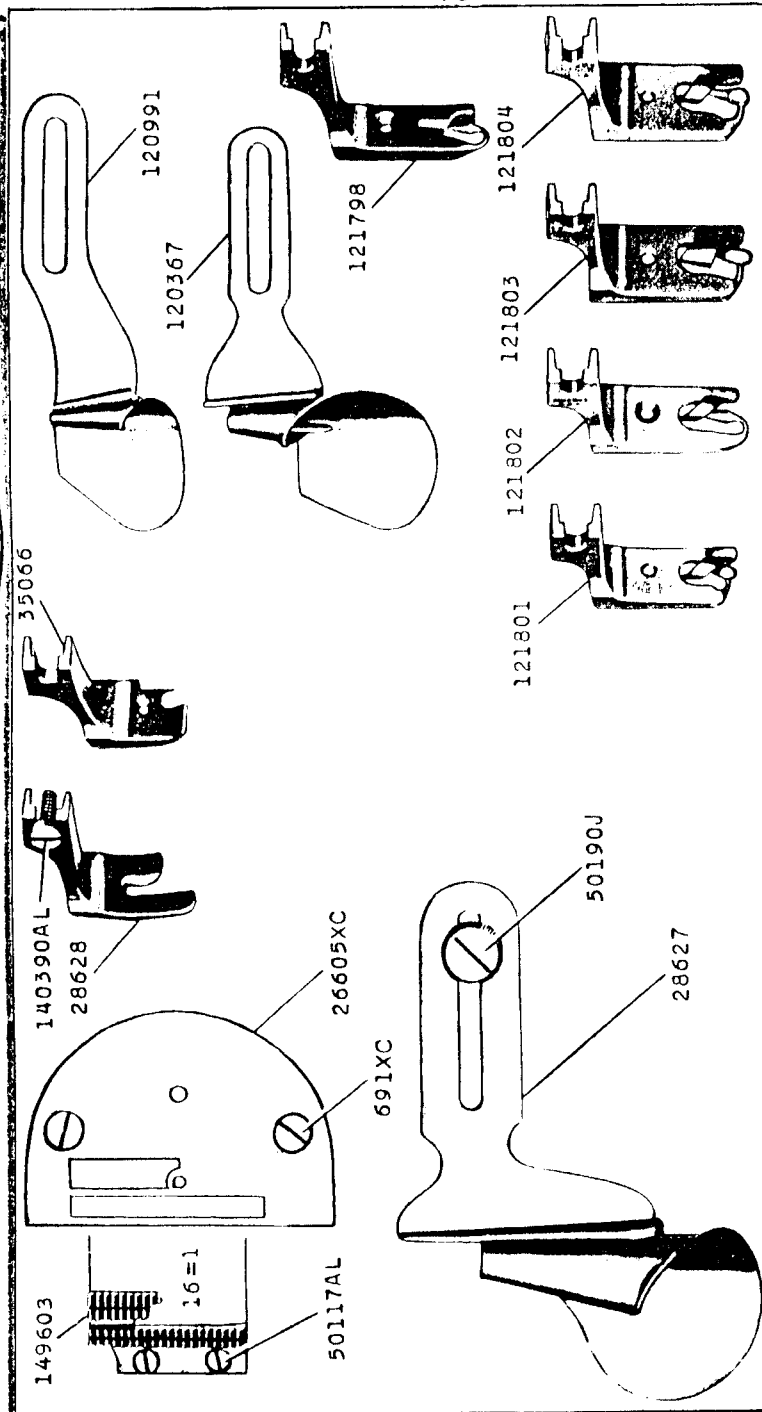

23257 - 2/3

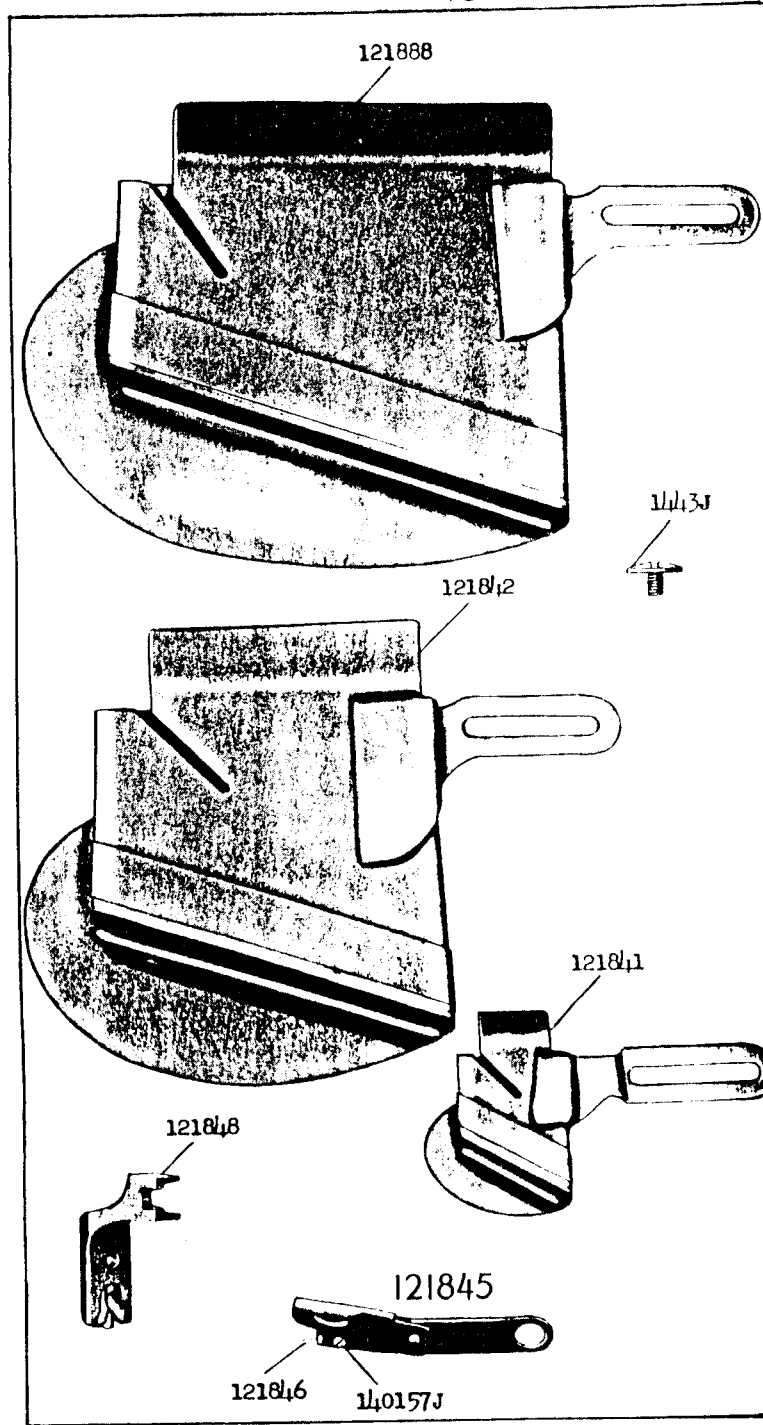

23260 - 1/3

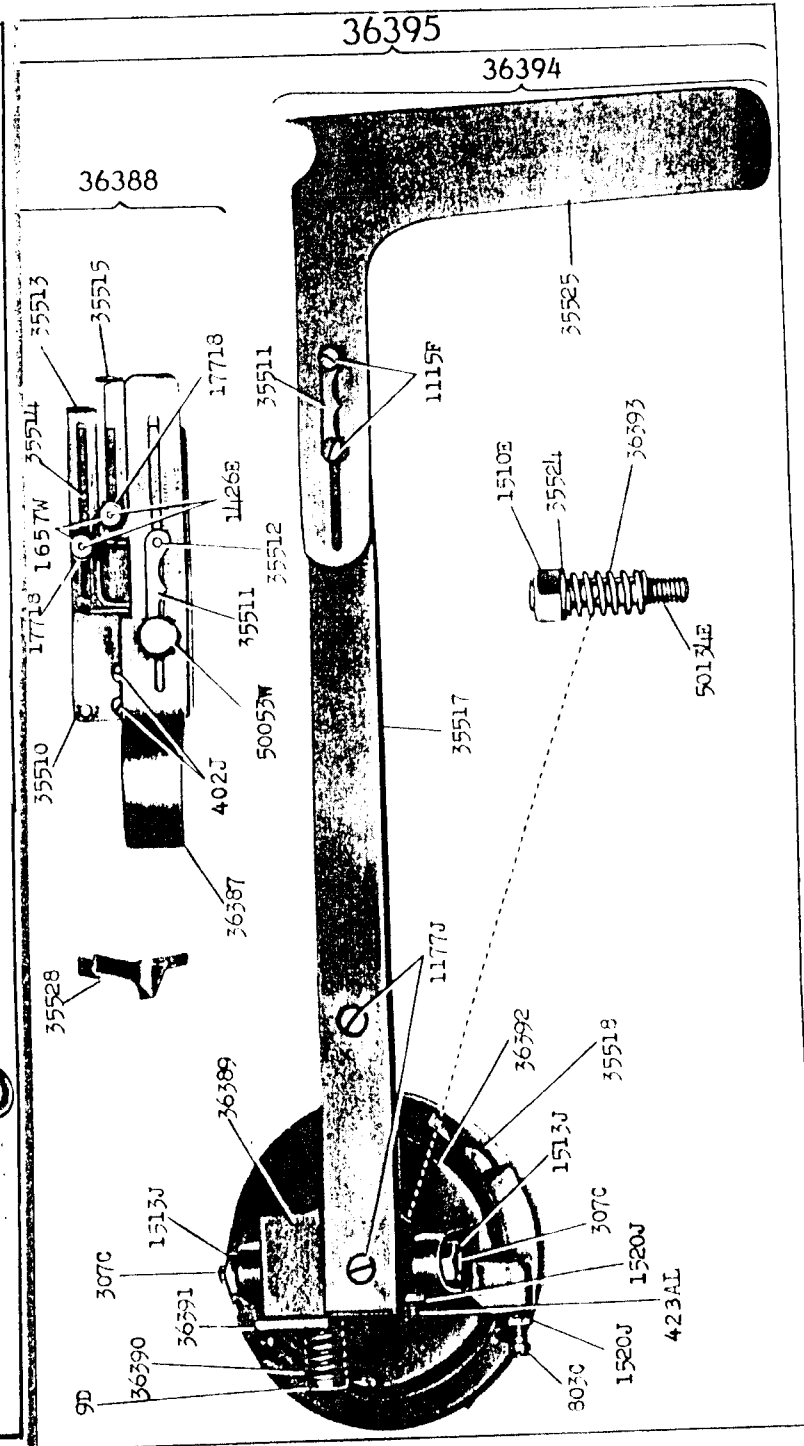

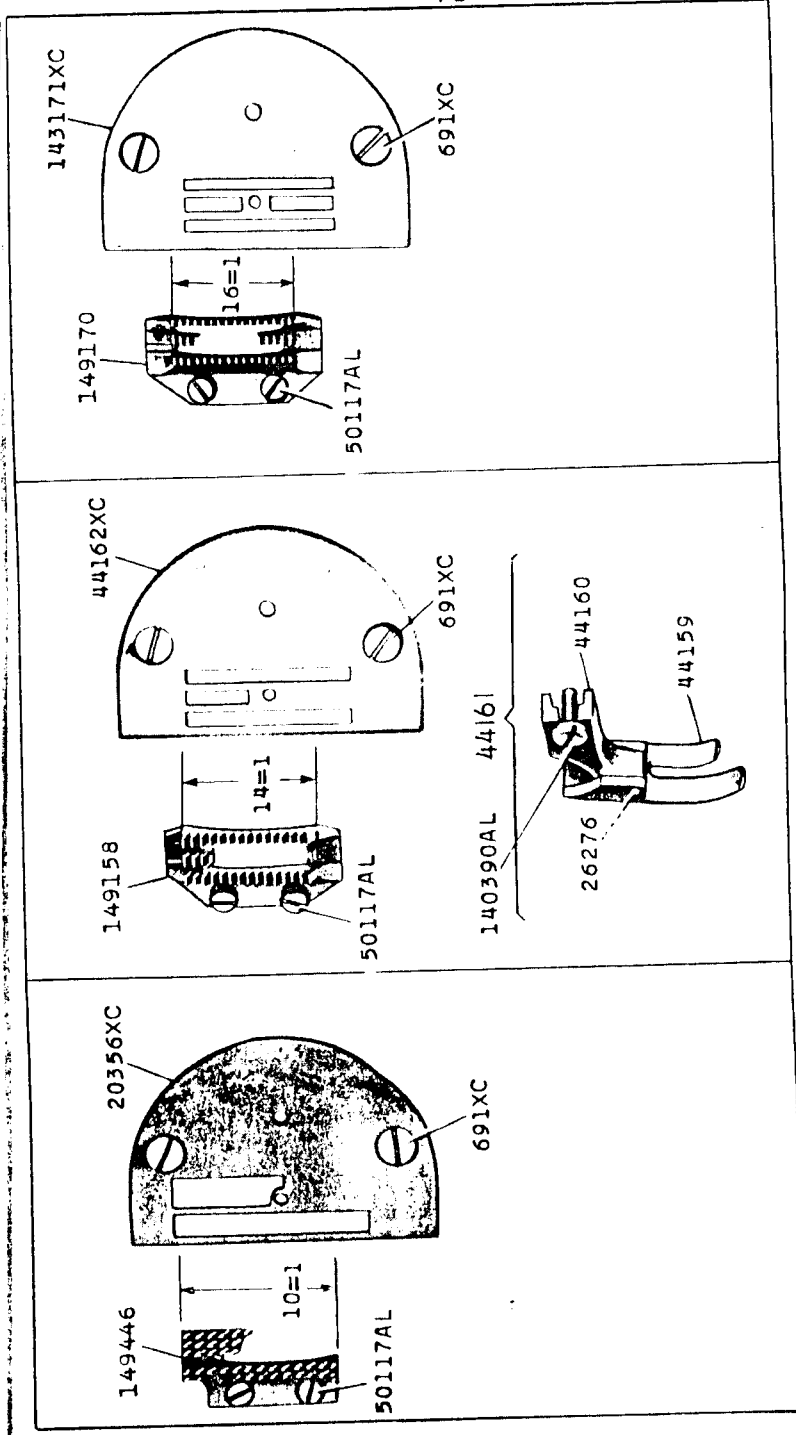
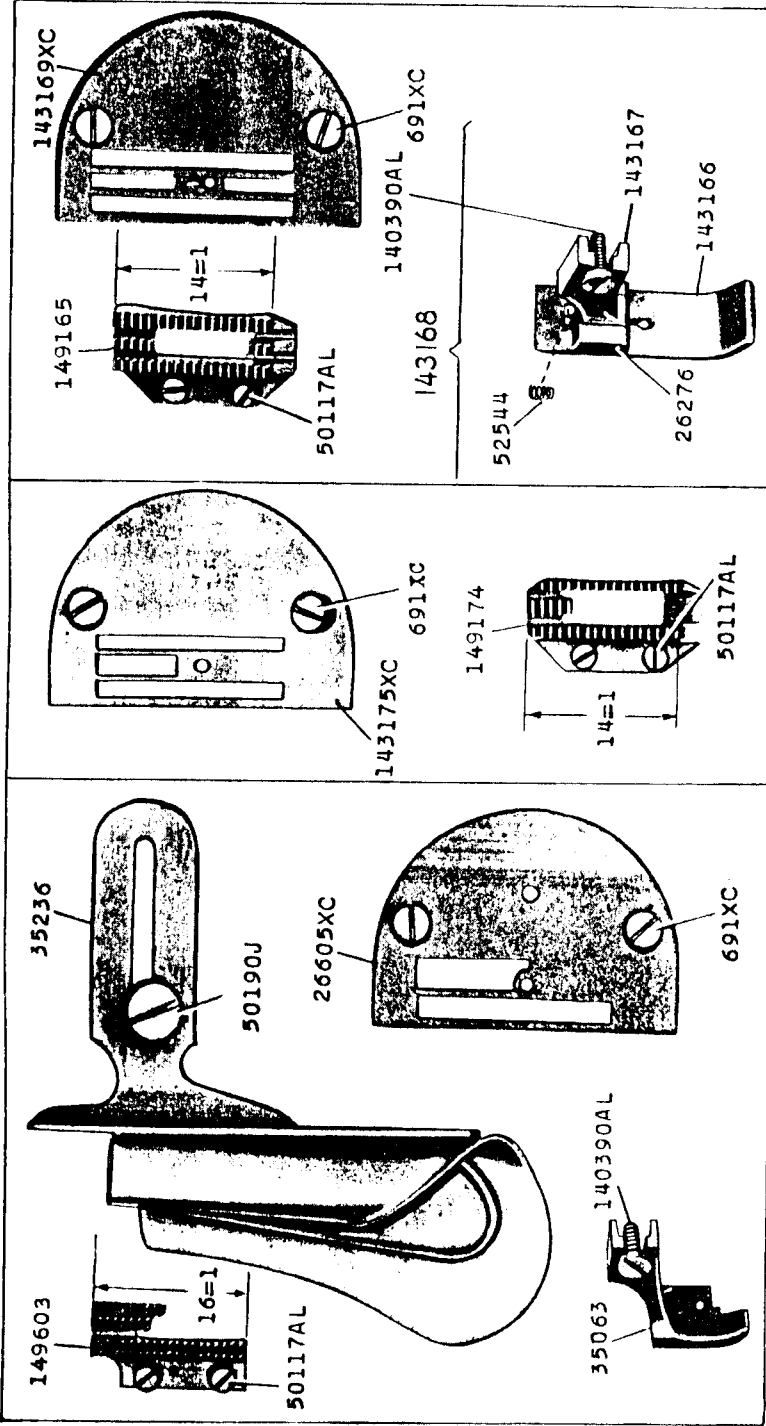

23268-2/3

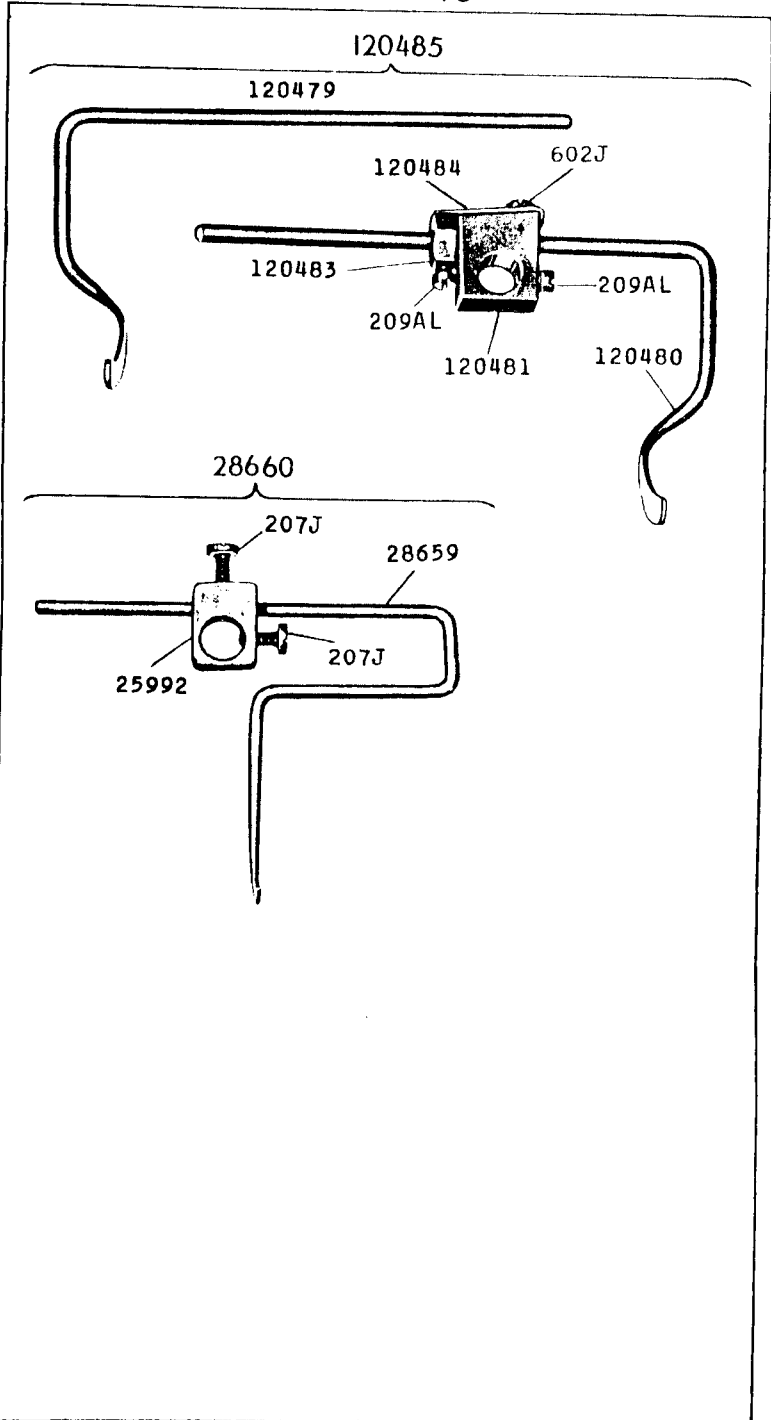

23282 - 1/2

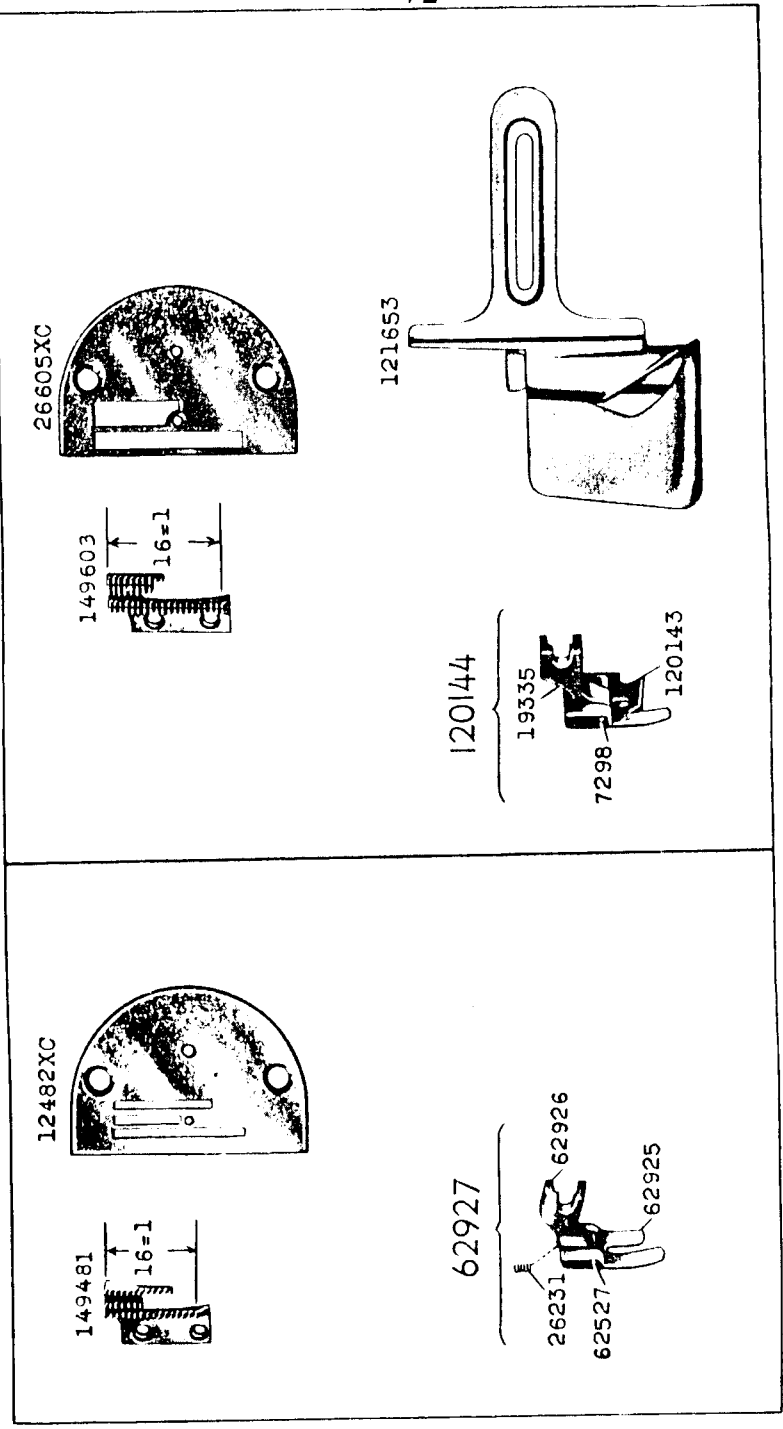

23284 - 1/2

143288

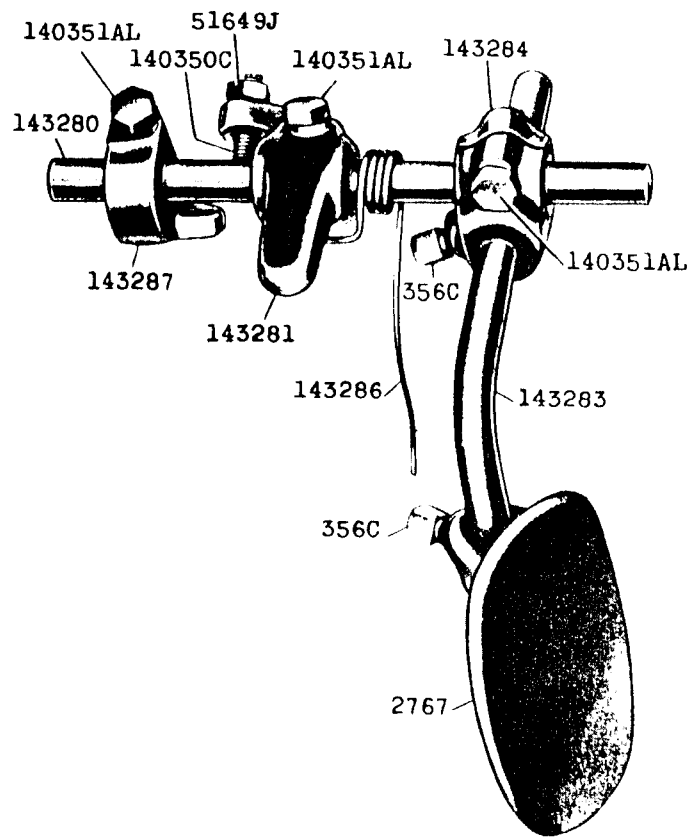

23285 - 2/3

160358XC

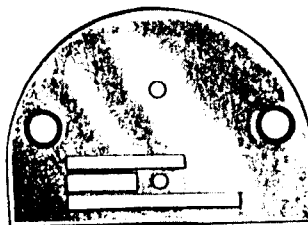

149357

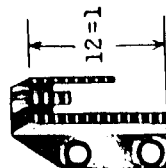

127260

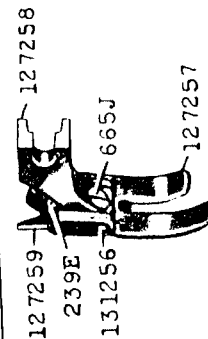

12422XC

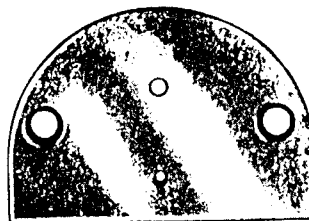

12298XC

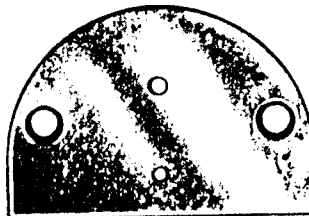

160342

