

# PFAFF

## 918

Unterklassen-Ausstattung

Subclass parts

Composition des sous-classes

Composición de las subclases



**Table of subclasses**  
**Table des sous-classes**  
**Tabla de subclases** PFAFF 918

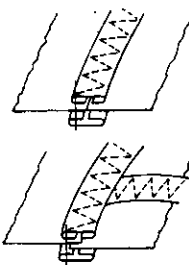



Unterklasse Subclass Sous-classe Subclase	-6/01 (-900/..)	-45/12-915/05 (-900/..)	-45/12-915/05 (-900/..)	-45/12-915/05	-47/12-944/01 (-900/..)
Arbeitsgang Operation Opération Operación	Für allgemeine Näharbeiten. Standardform des Teilesatzes. For ordinary sewing operations. Standard parts set. Travaux d'utilité courante. Jeu de pièces standard. Para trabajos de costura en general. Juego de piezas estándar.				
Ausführung Model Version Tipo de máquina	A; B	B	B	B/CN	C
Nadelabstand in mm Needle gauge in mm Ecartement des aiguilles en mm Distancia entre agujas en mm		4,5	6,0	6,0	
Überstichbreite in mm Stitch width in mm Jetée de l'aiguille en mm Anchura del zigzag en mm	10,0				8,0
Nadelstange Needle bar Barre à aiguille Barra de aguja	91-168 019-91	91-167 537-91	91-167 537-91	91-167 537-91	91-167 845-91
Stoffschieber <sup>[4]</sup> Feed dog Griffe Transportador inferior	91-047 559-04	91-047 570-04	91-047 678-04	91-047 678-04	91-059 640-04
Stichplatte <sup>[4]</sup> Needle plate Plaque à aiguille Placa de aguja	91-058 089-24	91-058 253-04 <sup>[10/2]</sup>	91-058 254-04	91-058 844-04	91-158 430-04
Stichplatteneinsatz Needle plate insert Applique de plaque Aplicue de la placa de aguja		91-026 904-14 <sup>[21/2]</sup>	91-026 904-14 <sup>[21/2]</sup>	91-058 636-04 x 4,0 <sup>[95/8]</sup>	
Rollfuß <sup>[4]</sup> Roller presser Pied à roulette Pie rodante		91-057 012-93 <sup>[10/2]</sup>	91-057 012-93 <sup>[10/2]</sup>	91-057 007-93	91-157 928-93
Nähfuß <sup>[4]</sup> Presser foot Pied presseur Pie prensatelas	91-055 106-23 <sup>[11/2]</sup>				
Kordelführung Cording guide Guide-cordonnet Guía para cordoncillo				91-129 955-25	
Führungsbügel Guide wire Passe-fil Guía de alambre				91-057 193-04	
Bandrollenträger Tape reel bracket Plateau dérouleur Portarrollos				91-129 730-70/895	
Stichlockerungsfinger Thread loosening finger Doigt tire-fil Dedo para dar más hilo a la puntada					91-156 052-91
Lineal Edge guide Guide-droit Guía recta					91-156 186-15

Table of subclasses  
 Table des sous-classes  
 Tabla de subclases PFAFF 918

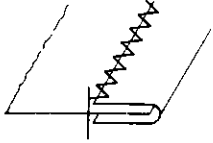
Unterklasse Subclass Sous-classe Subclase	-49/01 (-900/..)	-61/02 (-900/..)	-72/21 (-900/..)	-716/04-6/01 (-900/..)	-716/06-6/01 (-900/..)
Arbeitsgang Operation Opération Operación					
Ausführung Model Version Tipo de máquina	A; B	B	A; B	AN 2.5; BN 2.5	AN 2.5; BN 2.5
Überstichbreite in mm Stitch width in mm Jetée de l'aiguille en mm Anchura del zigzag en mm	10,0	10,0	8,0	8,0	10,0
Nadelstange Needle bar Barre à aiguille Barra de aguja	91-168 019-91	91-168 019-91	91-168 019-91	91-168 019-91	91-168 019-91
Stoffschieber [4] Feed dog Griffe Transportador inferior	91-047 649-04	91-047 559-04	91-047 642-04	91-047 643-04	91-047 645-04
Stichplatte [4] Needle plate Plaque à aiguille Placa de aguja	91-058 380-04	91-058 089-24	91-058 374-03	91-058 207-24	91-058 208-24
Stichplatteneinsatz Needle plate insert Applique de plaque Aplicue de la placa de aguja	91-158 185-15				
Nähfuß [4] Presser foot Pied presseur Pie prensatelas	91-055 530-03	91-055 106-23 [11/2]	91-055 530-03	91-055 106-23 [11/2]	91-055 106-23
Träger Bracket Support Soporte		91-056 021-21			
Kopfplatte Face plate Plaque frontale Placa frontal		91-168 461-71/893			
Zwischenplatte Distance plate Plaque intermédiaire Placa intermedia		91-268 014-71/893			
Bandführung Tape guide Guide-ruban Guiacintas		91-043 408-23 [5]	91-053 228-21		
Bandtrommel Tape reel Tambour-dérouleur Tambor-portacintas		91-056 758-70/895	91-041 644-70/895		

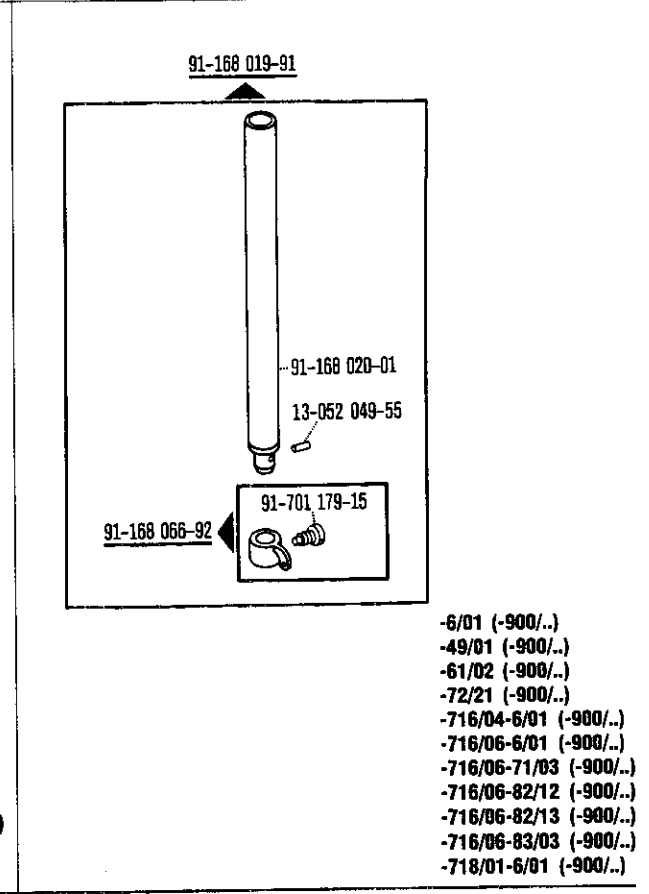
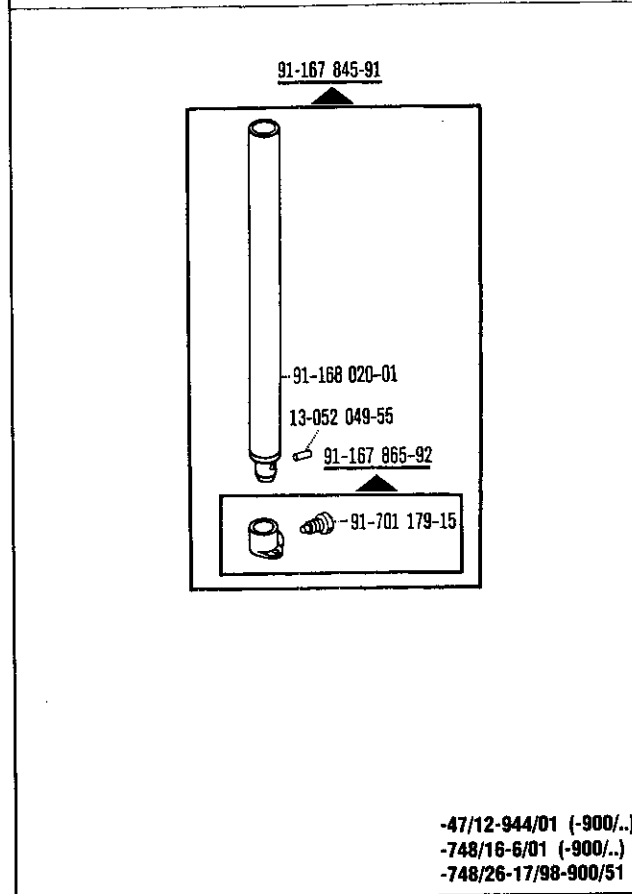
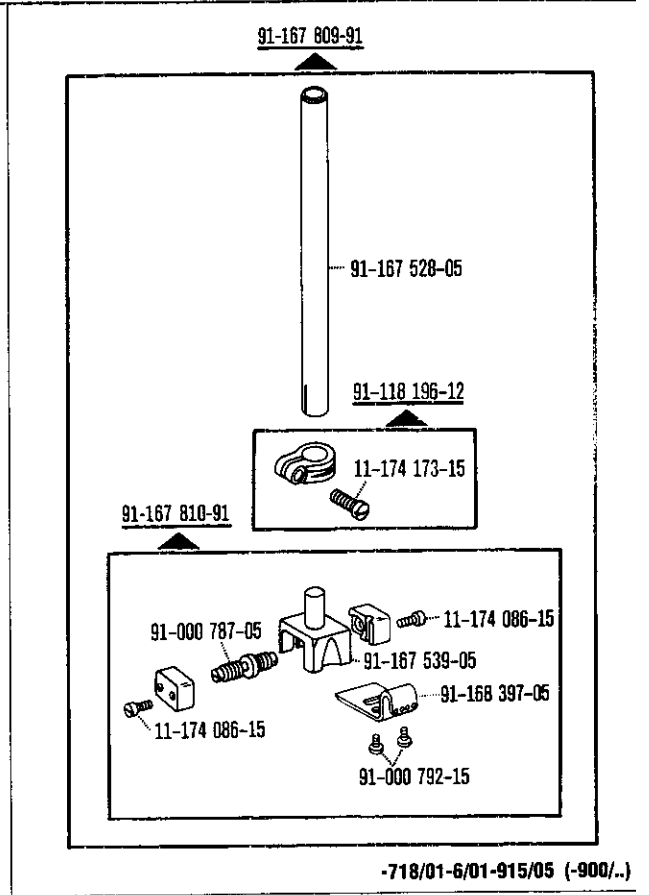
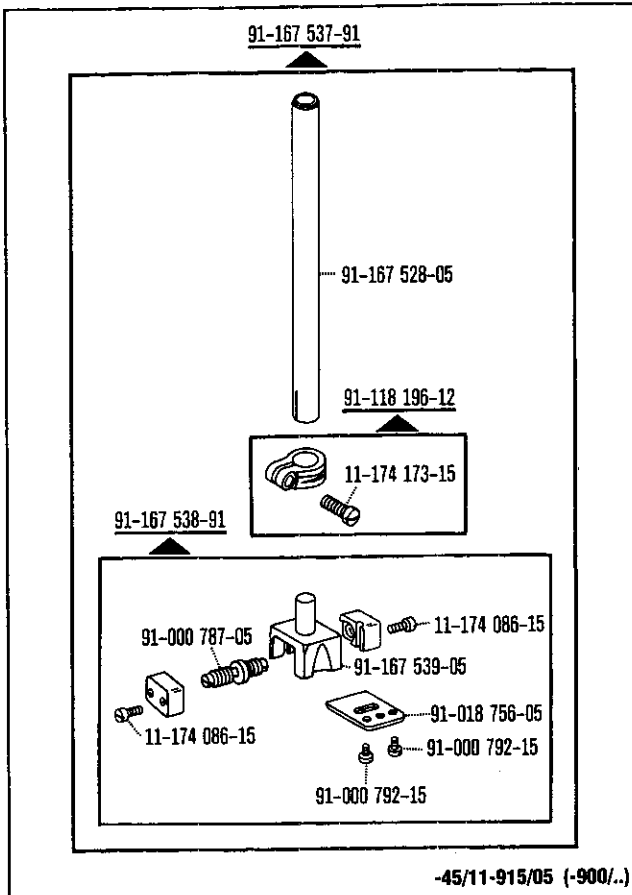
☐ siehe Erläuterungen Register [A]-[E]  
 see explanations in section [A]-[E]  
 voir légende registre [A]-[E]  
 ver explicaciones del registro [A]-[E]


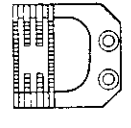

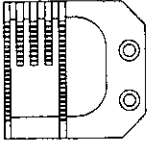

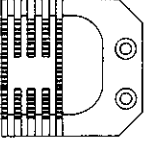

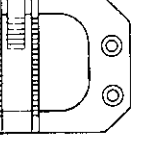

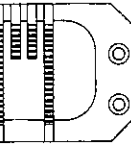

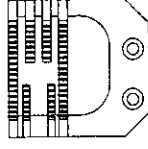

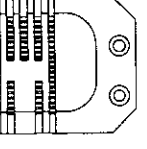

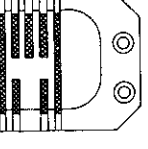

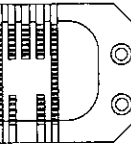

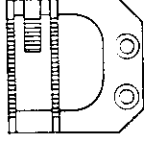


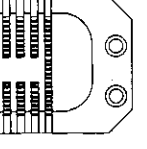

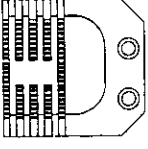


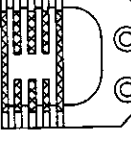

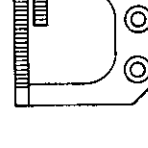

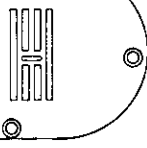

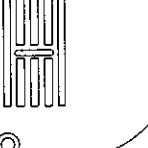
**Table of subclasses**  
**Table des sous-classes**  
**Tabla de subclases** PFAFF 918

Unterklasse Subclass Sous-classe Subclase	-716/06-71/03 (-900/..)	-716/06-82/12 (-900/..)	-716/06-82/13 (-900/..)	-716/06-83/03 (-900/..)	-718/01-6/01 (-900/..)
Arbeitsgang Operation Opération Operación					Zum Herstellen von Zier- nähten. For making fancy seams. Coutures d'ornementation. Para costura de adorno.
Ausführung Model Version Tipo de máquina	AN 2.5; BN 2.5	AN 2.5; BN 2.5	AN 2.5; BN 2.5	AN 2.5; BN 2.5	AN 2.5; BN 2.5
Überstichbreite in mm Stitch width in mm Jetée de l'aiguille en mm Anchura del zigzag en mm	10,0	10,0	10,0	10,0	10,0
Nadelstange Needle bar Barre à aiguille Barra de aguja	91-168 019-91	91-168 019-91	91-168 019-91	91-168 019-91	91-168 019-91
Stoffschieber <sup>4</sup> Feed dog Griffe Transportador inferior	91-047 365-04	91-047 857-04 <sup>60</sup> 91-059 467-04 <sup>60</sup>	91-047 857-04 <sup>60</sup> 91-059 467-04 <sup>60</sup>	91-047 857-04 <sup>60</sup> 91-059 467-04 <sup>60</sup>	91-047 646-04
Stichplatte <sup>4</sup> Needle plate Plaque à aiguille Placa de aguja	91-058 440-04	91-058 089-24	91-058 089-24	91-058 089-24	91-058 208-24
Nähfuß <sup>4</sup> Presser foot Pied presseur Pie prensatelas	91-055 704-03 <sup>5</sup> <sup>11/2</sup>	91-154 477-93 <sup>15/1</sup> <sup>15</sup> = 5,0 - 25,0 mm	91-154 477-93 <sup>15/1</sup> <sup>15</sup> = 5,0 - 25,0 mm	91-154 477-93 <sup>15/1</sup> <sup>15</sup> = 5,0 - 25,0 mm	91-055 528-23
Apparat <sup>5</sup> Attachment Appareil Aparato	91-056 082-23 91-056 086-93 91-056 090-25 91-056 091-23	91-050 716-93 <sup>60/3</sup> 91-156 676-93 <sup>60/4</sup>	91-050 716-93	91-156 489-93	
Träger Bracket Support Soporte	91-056 116-93 <sup>95/8</sup>	91-156 634-90 ▲	91-156 634-90		
Kopfplatte Face plate Plaque frontale Placa frontal	91-168 461-71/893		91-168 461-71/893		
Zwischenplatte Distance plate Plaque intermédiaire Placa intermedia	91-268 014-71/893		91-268 014-71/893		
Bandführung Tape guide Guide-ruban Guiacintas	91-053 228-91		91-156 458-93	91-156 267-91	
Bandtrommel Tape reel Tambour-dérouleur Tambor-portacintas	91-040 207-70/895 91-041 644-70/895	91-056 758-70/895	91-056 758-70/895	91-156 255-71/895	
Platte und Feder Plate an spring Plaque et ressort Placa y muelle		91-170 363-15 91-170 364-15	91-170 363-15 91-170 364-15		

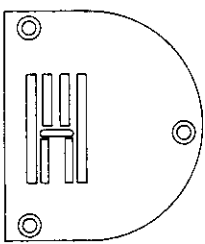
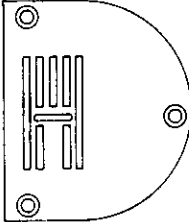
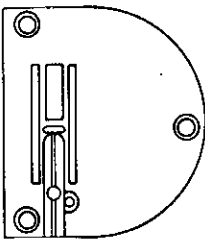
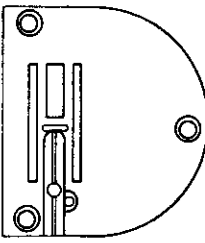
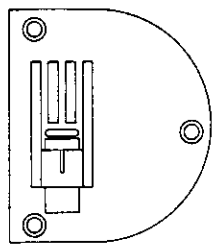
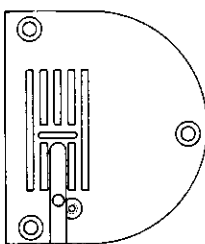
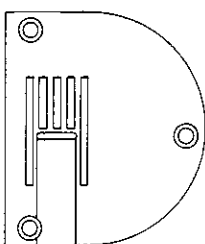
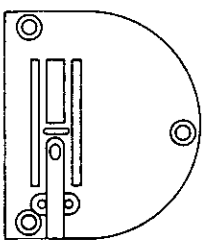
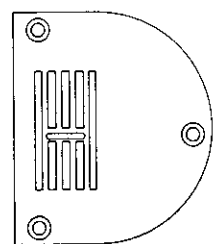
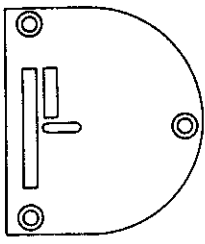

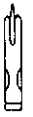

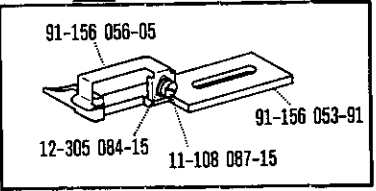
**Table of subclasses**  
**Table des sous-classes**  
**Tabla de subclases**      **PFAFF 918**

Unterklasse Subclass Sous-classe Subclase	-718/01-6/01-915/05 (-900/..)	-748/16-6/01 (-900/..)	-748/26-17/98-900/51
Arbeitsgang Operation Opération Operación	Zum Herstellen von Doppelziernähten bzw. Zweifarbzierenähten. For making twin fancy seams or two-colour fancy seams. Coutures d'ornementation à deux aiguilles ou à deux couleurs. Para costuras de adorno dobles o a dos colores.	Für allgemeine Näharbeiten mittels Standard-teilesatz. Die Maschine ist mit Walzentransport-Einrichtung ausgestattet. For general sewing operations with standard part set. The machine is equipped with puller feed. Pour les coutures d'utilité courante par jeu de pièces standard. La machine est équipée d'un puller. Para trabajos de costura en general mediante juego de piezas estándar. La máquina va equipada con un puller.	
Ausführung Model Version Tipo de máquina	AN 2,5; BN 2,5	C	B
Nadelabstand in mm Needle gauge in mm Ecartement des aiguilles en mm Distancia entre agujas en mm	6,0		
Überstichbreite in mm Stitch width in mm Jetée de l'aiguille en mm Anchura del zigzag en mm		10,0	6,0
Nadelstange Needle bar Barre à aiguille Barra de aguja	91-167 809-91	91-168 845-91	91-167 845-91
Stoffschieber [4] Feed dog Griffe Transportador inferior	91-047 646-04	91-059 088-04	91-047 343-04
Stichplatte [4] Needle plate Plaque à aiguille Placa de aguja	91-058 208-24	91-058 891-04	91-058 034-24
Nähfuß [4] Presser foot Pied presseur Pie prensatelas	91-055 528-23	91-055 106-03	91-155 342-03
Apparat [5] Attachment Appareil Aparato			99-117 939-91
Träger Bracket Support Soporte			99-117 940-25

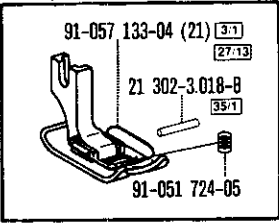
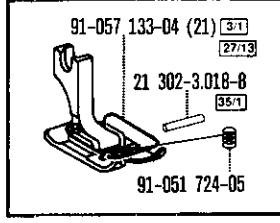
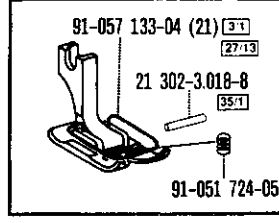
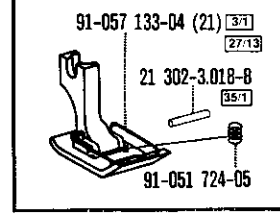
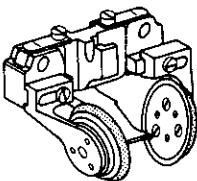
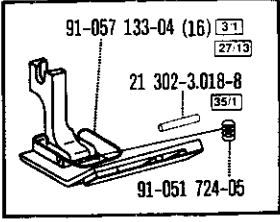
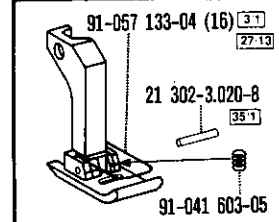
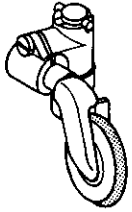

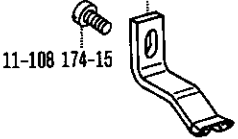
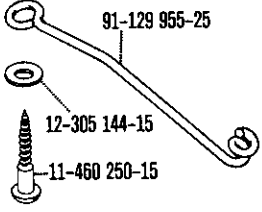
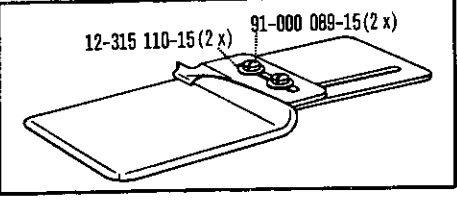
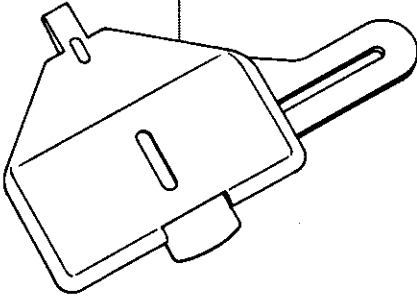


<p>91-047 343-04 </p>  <p>-748/26-17/98-900/51-...</p>	<p>91-047 365-04 </p>  <p>-716/06-71/03 (-900/..)</p>	<p>91-047 559-04 </p>  <p>-6/01 (-900/..) -61/02 (-900/..)</p>	<p>91-047 570-04 </p>  <p>-45/12-915/05 (-900/..)</p>
<p>91-047 642-04 </p>  <p>-72/21 (-900/..)</p>	<p>91-047 643-04 </p>  <p>-716/04-6/01 (-900/..)</p>	<p>91-047 645-04 </p>  <p>-716/06-6/01 (-900/..)</p>	<p>91-047 646-04 </p>  <p>-718/01-6/01 (-900/..) -718/01-6/01-915/05 (-900/..)</p>
<p>91-047 649-04 </p>  <p>-49/01 (-900/..)</p>	<p>91-047 678-04 </p>  <p>-45/12-915/05 (-900/..) -45/12-915/05 B/CN</p>	<p>91-047 857-04  </p>  <p>-716/06-82/12 (-900/..) -716/06-82/13 (-900/..) -716/06-83/03 (-900/..)</p>	<p>91-059 088-04 </p>  <p>-748/16-6/01 (-900/..)</p>
<p>91-059 467-04  </p>  <p>-716/06-82/12 (-900/..) -716/06-82/13 (-900/..) -716/06-83/03 (-900/..)</p>	<p>91-059 640-04 </p>  <p>-47/12-944/01 (-900/..)</p>	<p>91-058 034-24 </p>  <p>-748/26-17/98-900/51</p>	<p>91-058 089-24 </p>  <p>-6/01 (-900/..) -61/02 (-900/..) -716/06-82/12 (-900/..) -716/06-82/13 (-900/..) -716/06-83/03 (-900/..)</p>

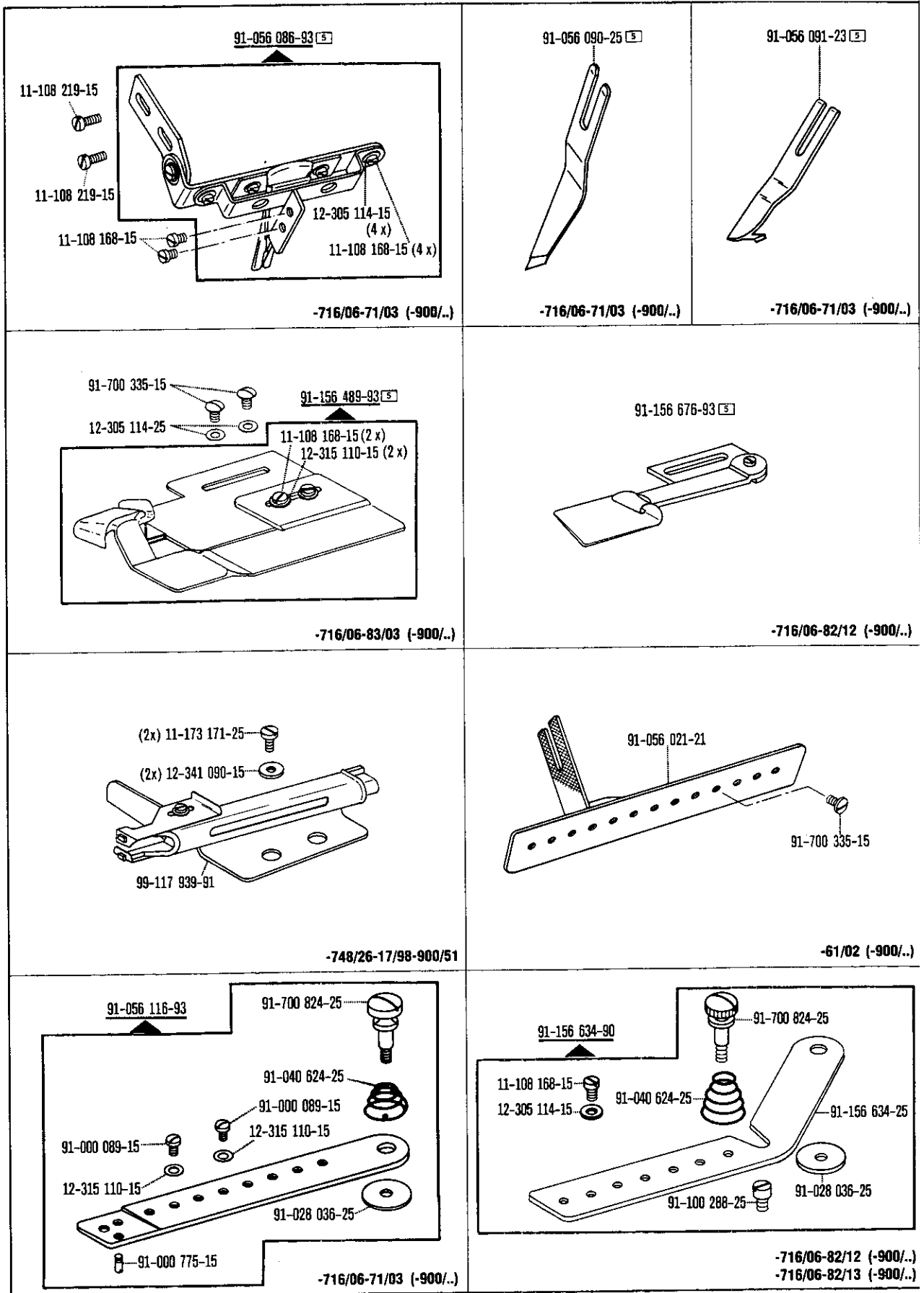
Gauge parts  
 Organes de couture  
 Organos de costura PFAFF 918

<p>91-058 207-24 </p>  <p>-716/04-6/01 (-900/..)</p>	<p>91-058 208-24 </p>  <p>-716/06-6/01 (-900/..)              -718/01-6/01 (-900/..)              -718/01-6/01-915/05 (-900/..)</p>	<p>91-058 253-04  </p>  <p>-45/12-915/05 (-900/..)</p>	<p>91-058 254-04 </p>  <p>-45/12-915/05 (-900/..)</p>
<p>91-058 374-03 </p>  <p>-72/21 (-900/..)</p>	<p>91-058 380-04 </p>  <p>-49/01 (-900/..)</p>	<p>91-058 440-04 </p>  <p>-716/06-71/03 (-900/..)</p>	<p>91-058 844-04 </p>  <p>-45/12-915/05</p>
<p>91-058 891-04 </p>  <p>-748/16-6/01 (-900/..)</p>	<p>91-158 430-04 </p>  <p>-47/12-944/01 (-900/..)</p>	<p>91-026 904-14 </p>  <p>91-100 265-15</p> <p>-45/12-915/05 (-900/..)</p>	<p>91-058 636-04 x 4,0 </p>  <p>91-100 265-15</p> <p>-45/12-915/05</p>
<p>91-158 185-15</p>  <p>91-100 265-15</p> <p>-49/01 (-900/..)</p>	<p>91-156 052-91</p>  <p>91-156 056-05              91-156 053-91              12-305 084-15              11-108 087-15</p> <p>11-108 174-15 (2 x)              12-315 110-15 (2 x)</p> <p>-47/12-944/01 (-900/..)</p>		

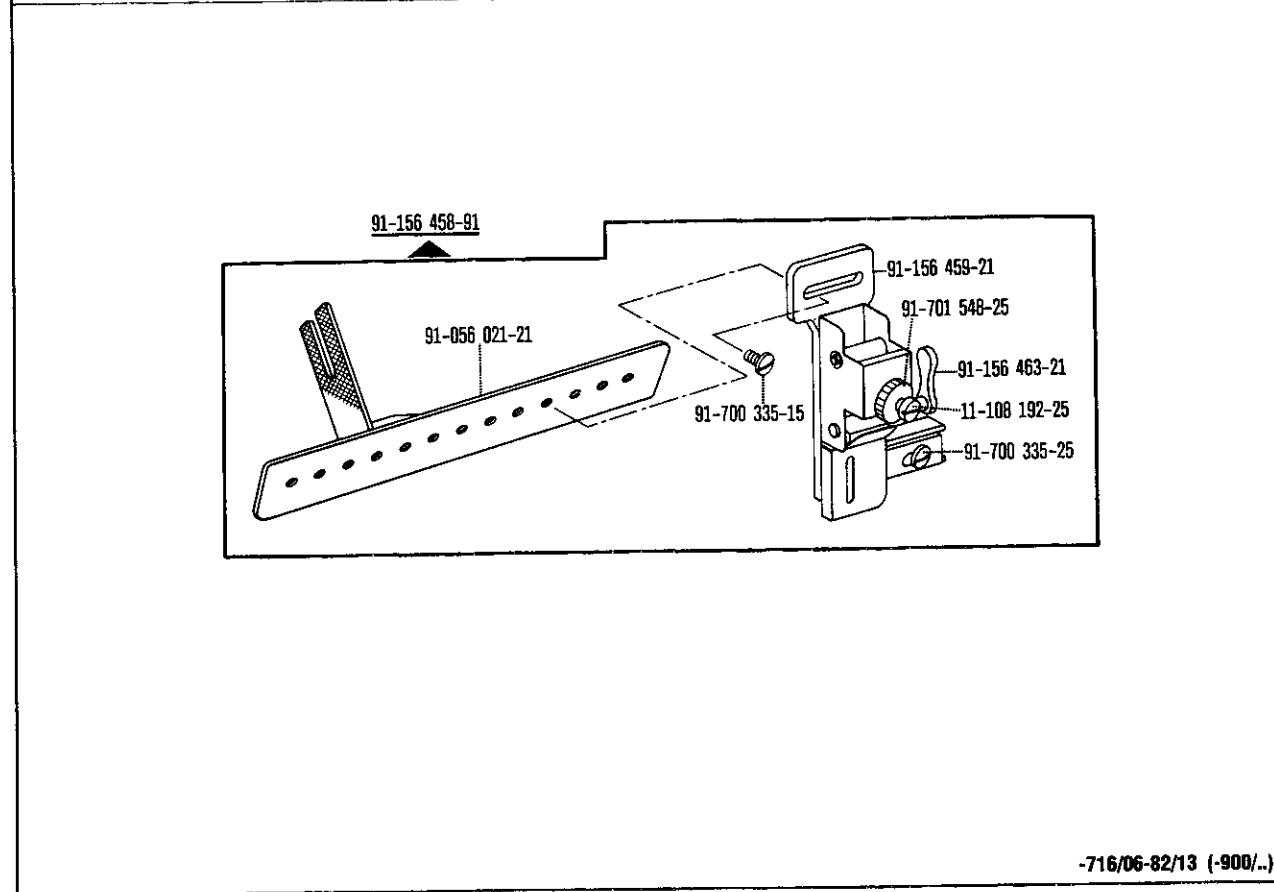
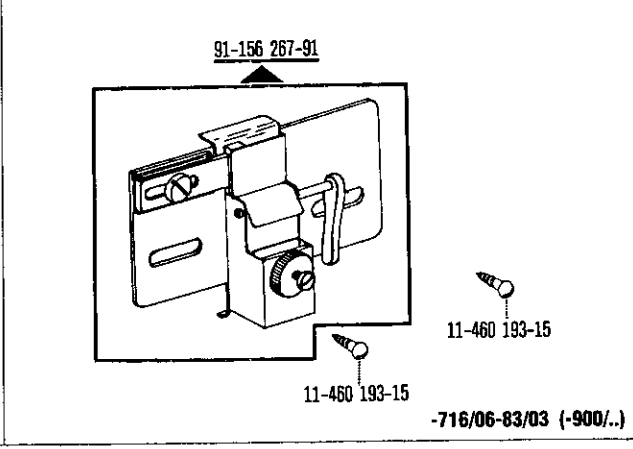
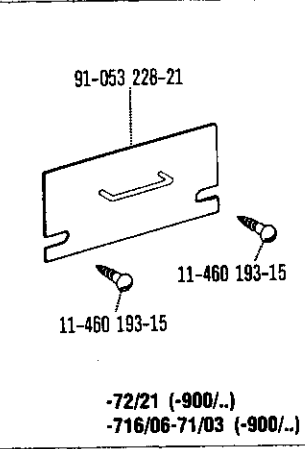
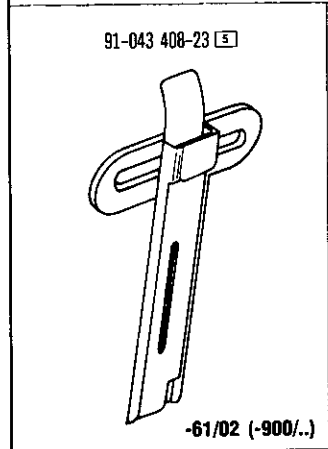
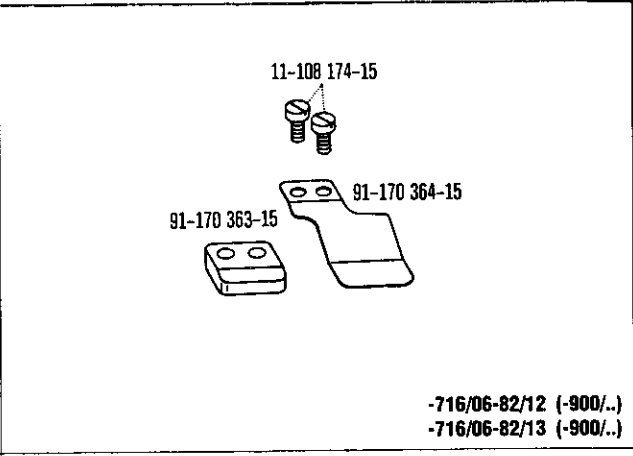
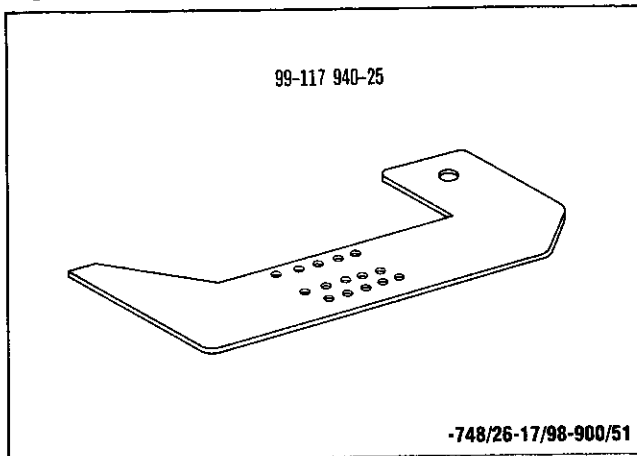


<p>91-055 106-23 <span style="border: 1px solid black; padding: 0 2px;">4</span> <span style="border: 1px solid black; padding: 0 2px;">11/2</span></p>  <p>-6/01 (-900/..)          -61/02 (-900/..)          -716/04-6/01 (-900/..)          -716/06-6/01 (-900/..)          -748/16-6/01 (-900/..)</p>	<p>91-055 528-23 <span style="border: 1px solid black; padding: 0 2px;">4</span></p>  <p>-718/01-6/01 (-900/..)          -718/01-6/01-915/05 (-900/..)</p>	<p>91-055 530-03 <span style="border: 1px solid black; padding: 0 2px;">4</span></p>  <p>-49/01 (-900/..)          -72/21 (-900/..)</p>	<p>91-055 704-03 <span style="border: 1px solid black; padding: 0 2px;">4</span> <span style="border: 1px solid black; padding: 0 2px;">5</span> <span style="border: 1px solid black; padding: 0 2px;">11/2</span></p>  <p>-716/06-71/03 (-900/..)</p>
<p>91-057 012-93 <span style="border: 1px solid black; padding: 0 2px;">4</span> <span style="border: 1px solid black; padding: 0 2px;">10/2</span></p>  <p>-45/12-915/05 (-900/..)</p>	<p>91-154 477-93 <span style="border: 1px solid black; padding: 0 2px;">4</span> <span style="border: 1px solid black; padding: 0 2px;">15/1</span>  <span style="border: 1px solid black; padding: 0 2px;">15</span> = 5,0 - 25,0 mm</p>  <p>-716/06-82/12 (-900/..)          -716/06-82/13 (-900/..)          -716/06-83/03 (-900/..)</p>	<p>91-155 342-03 <span style="border: 1px solid black; padding: 0 2px;">4</span></p>  <p>-748/26-17/98-900/51</p>	<p>91-157 928-93 <span style="border: 1px solid black; padding: 0 2px;">4</span></p>  <p>-47/12-944/01 (-900/..)</p>
<p>91-156 186-15</p>  <p>-47/12-944/01 (-900/..)</p>	<p>91-057 193-04 <span style="border: 1px solid black; padding: 0 2px;">19/2</span></p>  <p>-45/12-915/05</p>	 <p>-45/12-915/05</p>	
<p>91-050 716-93 <span style="border: 1px solid black; padding: 0 2px;">5</span></p>  <p>-716/06-82/12 (-900/..)          -716/06-82/13 (-900/..)</p>	<p>91-056 082-23 <span style="border: 1px solid black; padding: 0 2px;">5</span></p>  <p>-716/06-71/03 (-900/..)</p>		

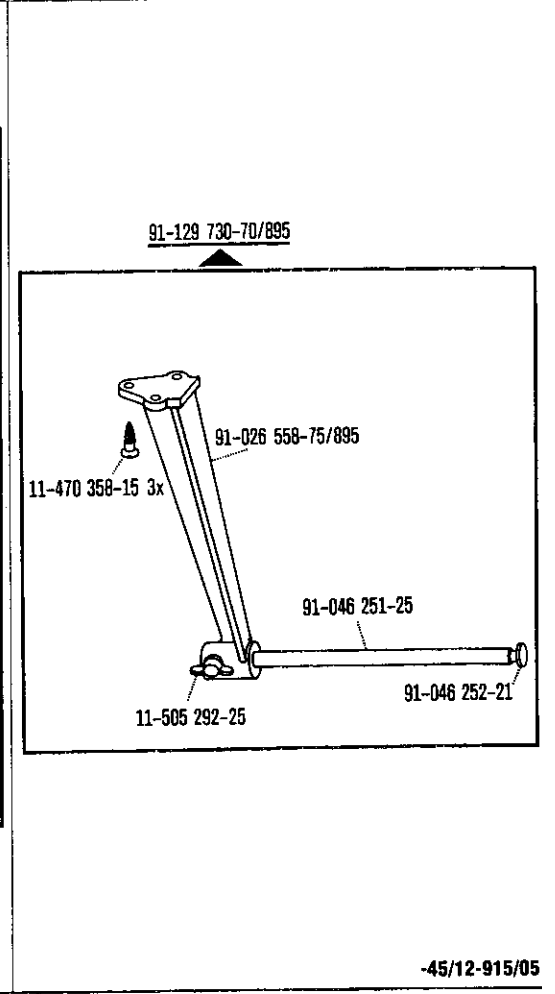
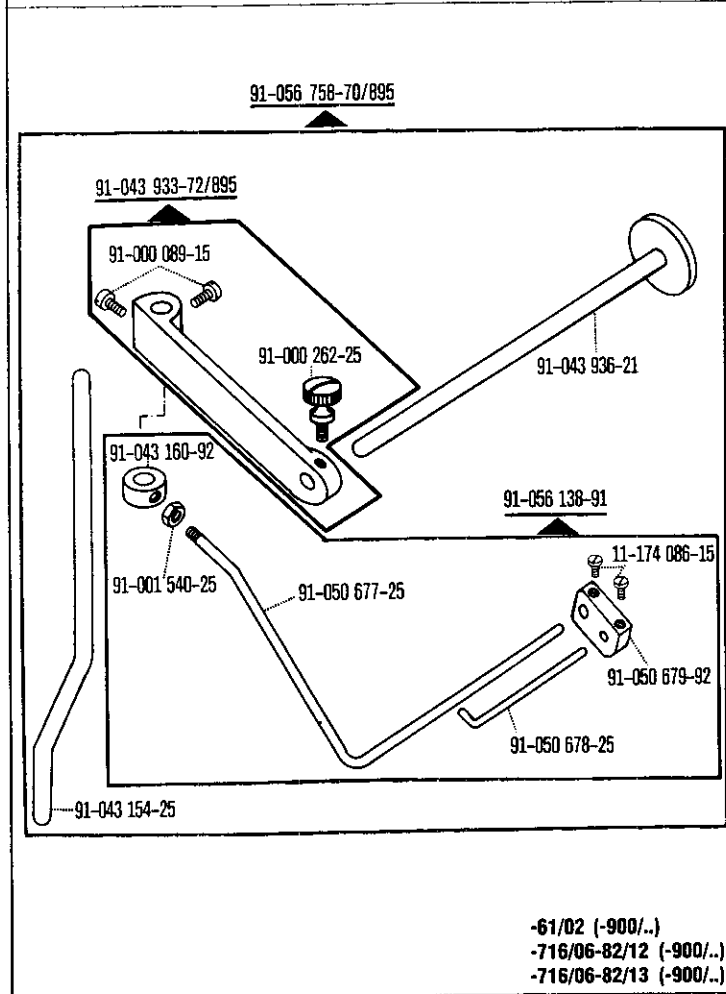
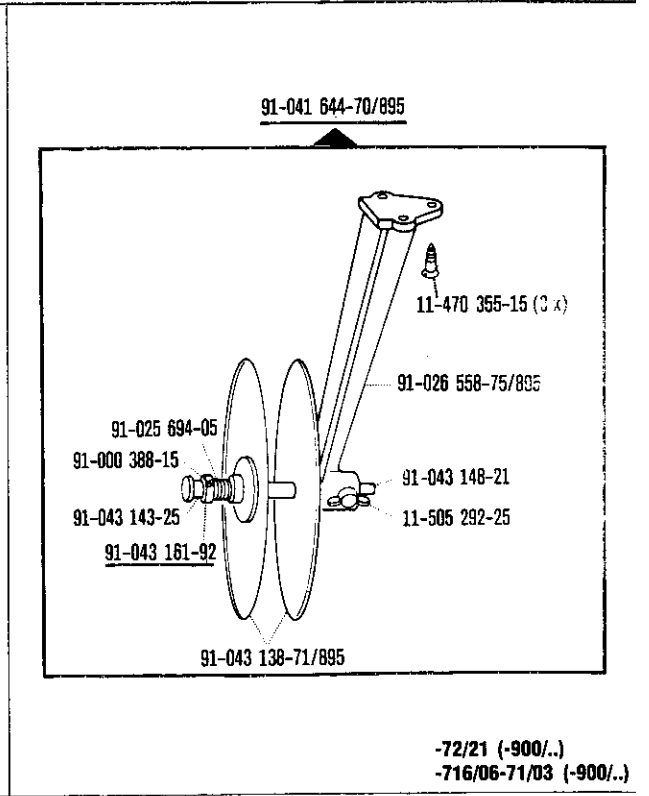
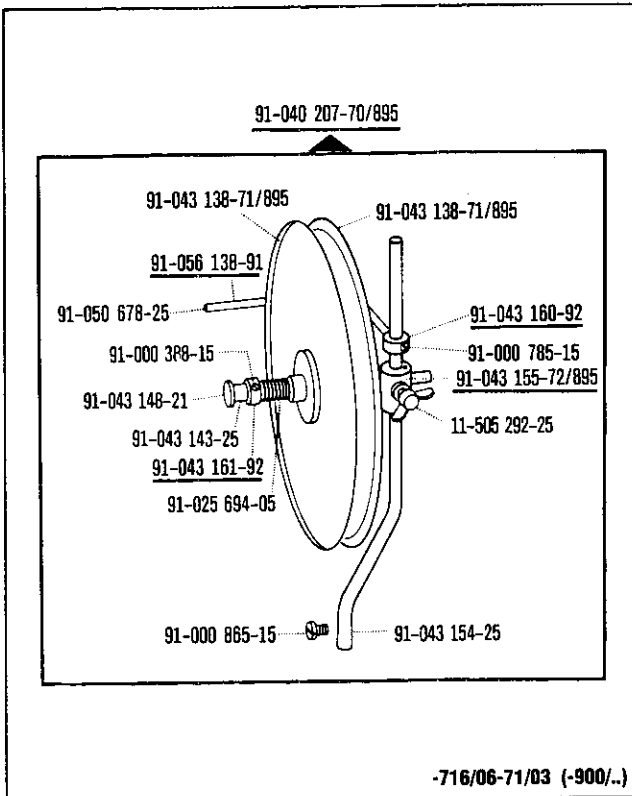
Gauge parts  
 Organes de couture  
 Organos de costura PFAFF 918



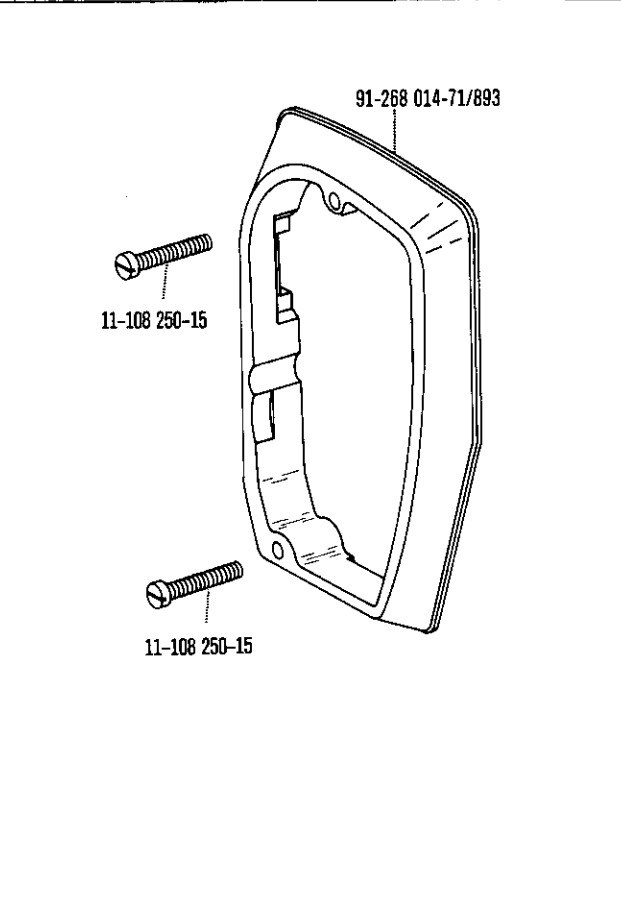
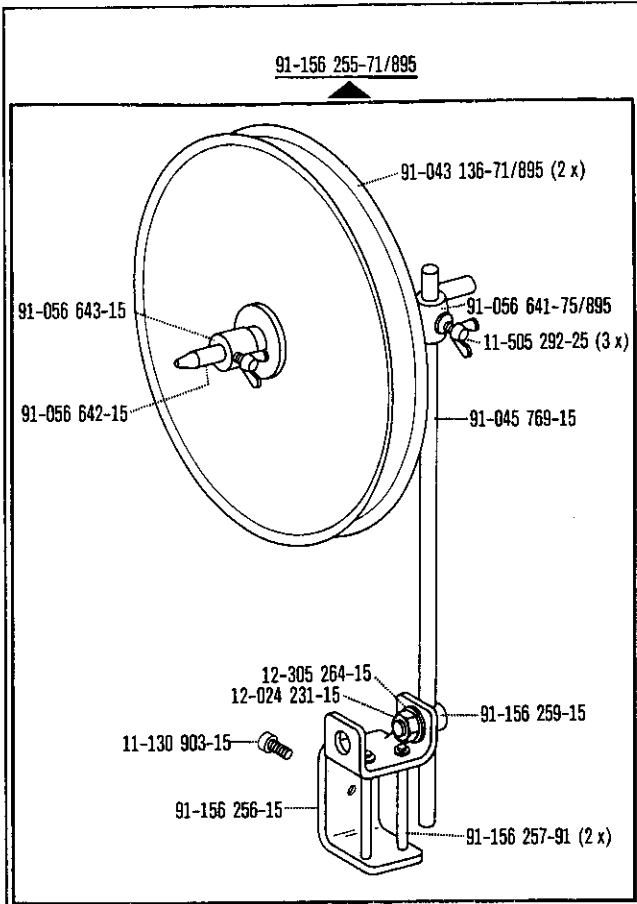
Gauge parts  
 Organes de couture  
 Organos de costura PFAFF 918



☐ siehe Erläuterungen Register [A]-[E]  
 see explanations in section [A]-[E]  
 voir légende registre [A]-[E]

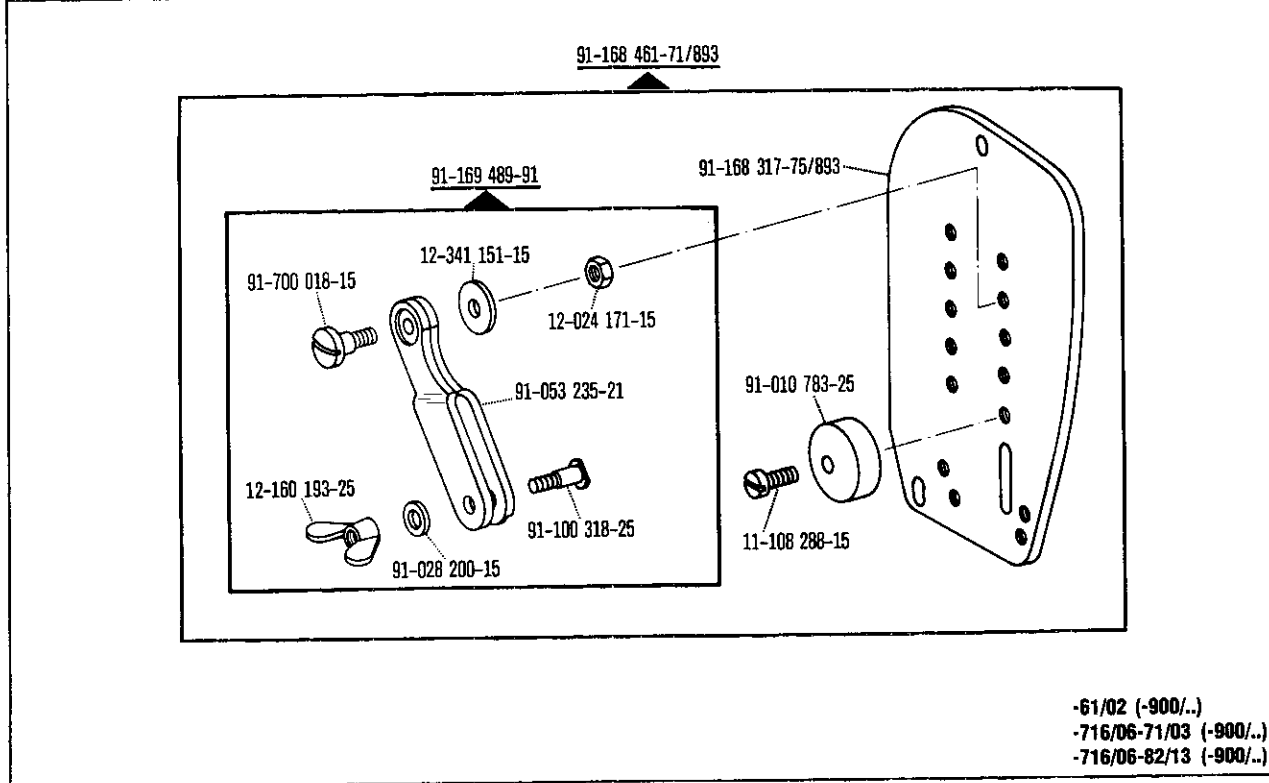


Gauge parts  
 Organes de couture  
 Organos de costura PFAFF 918



-716/06-83/03 (-900/..)

-61/02 (-900/..)  
 -716/06-71/03 (-900/..)  
 -716/06-82/13 (-900/..)



-61/02 (-900/..)  
 -716/06-71/03 (-900/..)  
 -716/06-82/13 (-900/..)

☐ siehe Erläuterungen Register [A]-[29]  
 see explanations in section [A]-[29]  
 voir légende registre [A]-[29]

**PFAFF**