

Singer 7-22

Singer 7-24

Price List of Parts

DO NOT INCREASE

Numbers

7-22 AND 7-24

Machines.



THE SINGER MANUFACTURING COMPANY.

ORIGINAL COPY
List of Parts
DO NOT REMOVE
NUMBERS

7-22 AND 7-24

MACHINES.

INDEX.

	PAGE
No. 7-22 Machine.....	4
No. 7-24 ".....	11
Accessories.....	10 & 19
Belt Shifter.....	10 & 19
Bobbin Winder.....	20
Numerical List.....	21

In ordering from this list, use **ONLY** the **PART** number, in the first column.

Each number always indicates the **SAME PART** in whatever list it appears, or for whatever machine

The letters after some of the numbers indicate the style of finish only, as follows :

- A. Hardened, Polished and Plated.
- B. Polished and Plated.
- C. Hardened only.
- D. Polished "
- E. Soft, not Polished.

These letters **MUST BE USED** when they appear in the list, and **AFTER** the number, as in the list.

In this series

1 to 1500 are Screw Numbers.

1501 " 1800 " Nut "

1801 " 2000 " Roller "

2001 and upward are numbers of Machine Parts.

The figures in the second column refer only to the plates, illustrating the parts, and are **NOT TO BE USED** in ordering.

Parts marked with an asterisk (*) are furnished only when repairs are made at factory.

PARTS COMPLETE FOR
7-22 MACHINE.

TWO SHUTTLES, DROP FEED, ADJUSTABLE PRESSER, EITHER
VIBRATING OR STATIONARY, BELT SHIFTER.

No.	Plate	Name.	Each.	Old No.
* 19555	—	Arm.....	18 50	—
8702	887	" Dowel Pin.....	15	3
872	900	" Screw.....	10	—
11878	838	" Shaft.....	7 00	—
11854	830	" " Bushing.....	75	5
437c	899	" " " Set Screw.....	04	—
11913	825	" Side Cover.....	25	—
65d	899	" " " Screw.....	15	—
11350	896	Balance Wheel with two 354c.....	1 75	6
354c	899	" " Set Screw.....	06	—
* 19556	—	Bed.....	18 50	—
11361	894	" Foot Bracket (left).....	10	—
11360	894	" " " (right).....	10	—
507E	898	" " " Bolt with 1515.....	02	—
1515	890	" " " " Nut.....	01	—
19557	863	Cloth Plate.....	1 25	—
389	901	" " Screw.....	04	—
11363	825	Crank Connecting Rod.....	1 25	206
* 11364	—	" " " Cap.....	—	—
145E	899	" " " " Screw... ..	04	—
565c	898	" " " " Hinge Screw	15	—
1513	890	" " " " " " "	—	—
		Nut.....	05	—
19558	863	Face Plate.....	2 00	—
161d	901	" " Screw.....	04	—
19596	—	" " complete, Nos. 19558 with 190, 910c, 11867, 11868, 11873, 11874, 11875, 19582, 19583, 19590 and two each 164d and 8800.....	6 25	—
19559	873	Feed Bar.....	2 25	—
807c	898	" " Screw Centre.....	06	—
1513	890	" " " " Nut.....	05	—
11867	830	" Cam with two 445c.....	1 00	12
445c	900	" " Set Screw.....	08	—
11868	830	" Connecting Link.....	35	16
565c	898	" " " " Hinge Screw..	15	—
1513	890	" " " " " " "	—	—
		Nut.....	05	—
19560	868	Feed Dog.....	3 00	—
When ordering 19560, give gauge required.				
381d	899	Feed Dog Screw.....	06	—
11870	825	" Forked Connection.....	1 75	207
565c	898	" " " " Hinge Scr.	15	—

No.	Plate	Name	Each	Old No.
1513	890	Feed Forked Connection Hinge Scr, Nut.....	05	—
11371	825	Feed Lifting Rock Shaft.....	1 40	31
19561	—	" " " " 11371 with 19562.....	3 40	—
19562	865	Feed Lifting Rock Shaft Crank with 135d and 1861.....	2 00	—
135d	899	Feed Lifting Rock Shaft Crank Clamp- ing Screw.....	05	—
1861	862	Feed Lifting Rock Shaft Crank Roller and Stud.....	35	—
564c	898	Feed Lifting Rock Shaft Scr. Centre.	12	—
1508	890	" " " " " " "	—	—
		Nut.....	06	—
11375	830	Feed Regulator.....	60	208
568E	898	" " Hinge Screw.....	15	—
254d	902	" " Thumb Screw.....	40	—
11370	825	" Rock Shaft.....	1 40	21A
11377	—	" " " 11376 with 11379	2 00	20
11379	893	" " " Crank with 453c	60	22
2117	890	" " " " Pin.....	01	23
453c	899	" " " " Set Scr..	02	—
564c	898	" " " " Screw Centre... ..	12	—
1508	890	" " " " " " Nut	06	—
25881	894	Guide.....	40	34
254d	902	" Thumb Screw.....	40	—
11522	855	Lifting Presser Bar.....	1 00	300
11523	856	" " " Bell Crank.....	1 50	307
11524	856	" " " " " " A d- justing Link.....	1 50	356
11525	—	Lifting Presser Bar Bell Crank Ad- justing Link 11524 with 1518, 1828 and 2718.....	1 80	308
611d	—	Lifting Presser Bar Bell Crank Ad- justing Link Adjusting Screw.....	12	—
8d	898	Lifting Presser Bar Bell Crank Ad- justing Link Hinge Screw.....	20	—
1828	899	Lifting Presser Bar Bell Crank Ad- justing Link Roller and Screw 372c	25	—
372c	898	Lifting Presser Bar Bell Crank Ad- justing Link Roller Screw.....	12	—
1518	890	Lifting Presser Bar Bell Crank Ad- justing Link Roller Screw Nut....	04	—
2718	897	Lifting Presser Bar Bell Crank Ad- justing Link Roller Scr. Nut Washer	01	309
11526	889	Lifting Presser Bar Bell Crank Con- nection Stud.....	75	—
11527	—	Lifting Presser Bar Bell Crank Con- nection Stud 11526 with 164d, 11528 and two 858c.....	95	310
164d	899	Lifting Presser Bar Bell Crank Con- nection Stud Screw.....	04	—

No.	Plate	Name	Each	Old No.
11528	862	Lifting Presser Bar Bell Crank Connection Stud Screw Washer.....	15	811
858c	900	Lifting Presser Bar Bell Crank Connection Stud Set Screw.....	03	—
11867	857	Lifting Presser Bar Lifter.....	1	00
11531	881	“ “ “ “ Bracket..	1	25 805
2117	890	“ “ “ “ “	01	23
11868	860	Lifting Presser Bar Lifter Hinge Pin	10	—
910c	900	“ “ “ “ “	03	—
11409	827	Lifting Presser Bar Spring.....	15	50
11869	860	“ “ “ “ Adjusting	1	00
523c	901	Block with 523c.....	18	—
19563	848	Lifting Presser Bar Spring Adjusting Block Set Screw.....	1	00
19564	869	Needle Bar.....	80	—
566c	898	“ “ Connecting Link.....	15	—
1513	890	“ “ “ “ Hinge Screw.....	05	—
19565	869	Needle Bar Connecting Link Hinge Screw Nut.....	1	25
129d	901	Needle Bar Connecting Stud Clamping Screw.....	04	—
445c	900	Needle Bar Connecting Stud Set Scr.	03	—
257d	902	“ “ Screw Bushing.....	2	50
19566	865	“ “ Clamp with two 207.....	01	—
When ordering 19566, give gauge required.				
2369	889	Needle Clamp Pin.....	02	—
207	901	“ Set Screw.....	80	—
11497	—	Oil Cup.....	25	—
11917	—	“ “ Cover.....	02	—
9084	889	“ “ “ Hinge Pin.....	04	296
2205	887	“ “ “ Latch Spring.....	02	—
207	901	“ “ “ “ “ Screw..	03	297
8953	—	“ or Wax Stripper (felt).....	05	—
11919	888	“ Cup Thread Eyelet.....	05	—
185d	999	“ “ Screw.....	01	—
5480	887	“ or Wax Stripper Washer (steel) for 11497.....	08	—
11918	888	Oil or Wax Stripper Washer (steel) for 11917.....	02	—
207	901	Oil or Wax Stripper Washer Screw..	1	75
11921	825	“ Cup complete, Nos. 2205, 5480, 9084, 11497, 11917, 11918, 11919, two 8953 and three 207.....	1	25
11841	827	Oscillating Rock Shaft (steel).....	75	256
11398	827	“ “ “ Hinge Pin	06	—
1508	890	“ “ “ “ “	06	—

No.	Plate	Name	Each	Old No.
622c	899	Oscillating Rock Shaft Hinge Pin Scr. Bearing.....	15	—
1508	890	Oscillating Rock Shaft Hinge Pin Scr. Bearing Nut.....	01	—
11165	897	Oscillating Rock Shaft Oil Pad.....	2	75
11842	—	“ “ “ “ 11841 with 622c, 11165, 11398 and two 1508....	1	25
19567	863	Oscillating Shaft.....	30	—
11848	—	“ “ Crank.....	75	—
11849	830	“ “ “ “ 11848 with 453c, 1513 and 1885.....	01	23
2117	890	Oscillating Shaft Crank Pin.....	40	—
1885	900	“ “ “ “ Roller & Scr. Stud.....	05	—
1513	890	Oscillating Shaft Crank Roller and Screw Stud Nut.....	08	—
190	899	Oscillating Shaft Crank Roller Cap Screw.....	02	—
5968	887	Oscillating Shaft Crank Roller Cap Screw Washer.....	02	—
453c	899	Oscillating Shaft Crank Set Screw...	6	00
19568	866	Shuttle (cylinder), 3-in. diam. (inside), with 11910.....	When ordering 19568, give gauge required.	
19569	866	Shuttle (cylinder), 3-in. diam. (outside), with 11910... ..	25	—
11910	833	Shuttle Bobbin (solid and hardened).	2	50
19570	867	“ “ Cylinder for 19568.....	2	50
19571	867	“ “ “ “ 19569.....	02	63
8961	890	“ “ “ “ Hinge Pin.....	15	—
14529	889	“ “ “ “ Latch for 19568....	15	—
11853	833	“ “ “ “ “ 19569....	01	—
12002	838	“ “ “ “ Pin.....	08	—
11854	833	“ “ “ “ Spring.....	02	—
590x	901	“ “ “ “ “ Screw..	5	00
19572	864	“ “ “ “ “ Driver with 448c.....	When ordering 19572, give gauge required.	
12591	879	Shuttle Driver Pin.....	08	—
448c	900	“ “ “ “ Set Screw.....	2	75
19573	867	“ “ “ “ Frame for 19568.....	2	75
19574	867	“ “ “ “ “ 19569.....	1	00
19575	864	“ “ “ “ Race Back (inside).....	1	00
19576	864	“ “ “ “ “ (outside).....	01	—
11833	889	“ “ “ “ Dowel Pin.....	25	—
19577	864	“ “ “ “ Spring.....	15	—
82d	901	“ “ “ “ “ Screw....	5	00
19578	864	“ “ “ “ “ Body.....	10	—
12591	879	“ “ “ “ “ Dowel Pin.....	06	—
123x	901	“ “ “ “ “ Screw.....	06	—

No.	Plate	Name	Each	Old No.
19579	—	Shuttle Race complete, Nos. 19575, 19576, two each 32D, 19577 and four 11833.....	7	50
When ordering 19579, give gauge required.				
778C	901	Shuttle Tension Regulating Screw....	05	—
19580	866	" " Spring for 19568.....	40	—
19581	866	" " " " 19569.....	40	—
8879	887	Tension Friction Washer (felt). Old No. 171, No. 5 Machine.....	01	—
11043	897	Tension Friction Washer (steel)....	03	—
1560	890	" Regulating Thumb Nut....	04	—
8905	887	" " " " " " Washer.....	01	361
850D	902	Tension Screw Stud.....	25	—
8791	888	" Spring.....	10	320
11044	897	" Wheel.....	75	—
19582	885	" (wheel) complete, Nos. 850D, 1560, 8791, 8905, 11043, two 11044 and three 8879.....	2	00
19588	869	Thread Eyelet for 19596.....	05	—
19584	869	" " (double) for 19555.....	25	—
166D	899	" " Screw.....	07	—
11873	860	" Guard for 19596.....	03	—
19585	869	" Retainer Bracket.....	1	50
180D	901	" " " Screw.....	03	—
2102	888	" " Disc.....	05	84
1560	890	" " Regulating Thumb Nut.....	04	—
8905	887	Thread Retainer Regulating Thumb Nut Washer.....	01	361
915D	903	Thread Retainer Screw Stud.....	15	—
2103	888	" " Spring.....	03	85
19586	865	" " Thread Guide Pin.....	05	—
19587	—	" " complete, Nos. 19585, 19586, two each 1560, 2103, 8905 and four 2102.....	1	90
11428	827	Thread Take-up Cam (steel) with 434C	5	00
8873	887	" " " Pin.....	05	81
434C	899	" " " Set Screw.....	04	—
19588	—	" " Lever.....	1	40
19589	864	" " " 19588 with 1518 and 1845.....	1	75
567D	898	Thread Take-up Lever Hinge Screw.....	15	—
1845	899	" " " Roller and Scr. Stud.....	30	—
1518	890	Thread Take-up Lever Roller and Screw Stud Nut.....	04	—
11874	857	Thread Take-up Spring.....	15	—
164D	899	" " " Scr.....	04	—
8800	890	" " " Washer.....	06	90

No.	Plate	Name	Each	Old No.
11875	857	Thread Take-up Spring Regulator....	60	—
164D	899	" " " " " Scr.....	04	—
8800	890	" " " " " Washer.....	06	90
19590	865	Thread Take-up Spring Thread Guard	05	—
190	899	" " " " " Screw.....	03	—
19591	—	Throat Plate Body.....	1	40
19592	868	" " Needle Hole Strip.....	60	—
401D	899	" " " " " Scr.....	02	—
19593	868	" " complete, Nos. 19591, with two 19592 and four 401D.....	2	50
When ordering 19591, 19592 or 19593, give gauge required.				
381D	899	Throat Plate Screw.....	06	—
19594	—	Vibrating Presser Bar.....	1	00
11559	859	" " " Cap Bracket (upper).....	50	335
11560	859	Vibrating Presser Bar Cap Bracket (lower).....	50	336
128E	901	Vibrating Presser Bar Cap Bracket Screw (inside).....	04	—
612E	—	Vibrating Presser Bar Cap Bracket Screw (outside).....	06	—
11561	859	Vibrating Presser Bar Guide Bracket	2	00
2049	853	" " " " " Pin.....	01	236
681D	862	Vibrating Presser Bar Hinge Screw..	08	—
11563	862	" " " Spring Stud..	40	337
190	899	" " " " " Screw.....	03	—
11564	862	Vibrating Presser Bar Spring Stud	02	338
11565	859	Vibrating Presser Bar Stop complete, Nos. 682D, 3146, 11566 and 11567..	40	341
11566	862	Vibrating Presser Bar Stop Block...	25	342
3146	889	" " " " " Washer (front).....	01	343
11567	862	Vibrating Presser Bar Stop Block Washer (inside).....	01	344
682D	862	Vibrating Presser Bar Stop Thumb Screw.....	10	—
19595	884	Vibrating Presser Foot.....	2	50
164D	899	" " " " " Screw.....	04	—

ACCESSORIES.

No.	Plate.	Name.	Each.	Old No.
25957	895	Oiler with 4½-in. spout, Old No. 570, A. & A.....	12	—
25958	—	Oiler Spout, 4½-in. Old No. 571, A. & A.....	04	—
26026	895	Screw Driver. Old No. 893, A. & A.	10	—
11831	895	" " 5-in. blade.....	20	—
8908	894	Wrench for 354c.....	10	351
8909	894	" " 1513 and 1518.....	15	352
8910	894	" " 1508.....	25	—

BELT SHIFTER PARTS.

No.	Plate.	Name.	Each.	Old No.
11446	890	Cord Eyelet.....	04	106
11447	874	" Pulley.....	35	107
567D	898	" " Screw.....	15	—
5667	—	Foot Lever.....	15	—
5669	—	" " Bracket.....	10	—
6439	—	" " Chain (length, 36 to 45 inches).....	20	—
In ordering No. 6439, state length required.				
5671	897	Foot Lever Hinge Pin.....	01	—
5672	895	" " Lifting Spring.....	03	—
5668	895	" " 5667 with 5669 and 5671..	40	—
11940	896	Fork.....	75	—
434c	899	" Set Screw.....	04	—
11941	896	Frame with 8804 and two 434c.....	1	75
8804	892	" Handle.....	30	101
11450	828	Guide Rod.....	30	108
2117	890	" " Pin.....	01	23
11943	896	Pulley (fast) with two 354c.....	1	10
354c	899	" " Set Screw.....	06	—
11944	896	" (loose).....	1	00
11459	897	" " Collar with two 448c... ..	25	98
448c	900	" " " Set Screw.....	03	—
11451	828	Slide Rod.....	75	102
11453	887	" " Collar with two 448c.....	25	103
448c	900	" " " Set Screw.....	03	—
2117	890	" " Pin.....	01	23
11942	828	" " Spring.....	15	—
11453	887	" " Collar with two 448c... ..	25	103
448c	900	" " " Set Screw.... ..	03	—
11945	—	Belt Shifter complete, Nos. 567D, 5668, 5672, 6439, 11446, 11447, 11450, 11451, 11459, 11940 to 11944, two each 2117 and 11453.....	7	50

PARTS COMPLETE FOR**7-24 MACHINE.**

FOR BUFF WHEELS NOT MORE THAN ½-INCH THICK, WITH ATTACHMENT FOR MAKING CIRCULAR ROWS OF STITCHES AND AUTOMATICALLY CHANGING FROM EACH FINISHED ROW TO THE BEGINNING OF THE NEXT.

No.	Plate.	Name.	Each.	Old No.
* 19555	—	Arm.....	18	50
8702	887	" Dowel Pin.....	15	3
872E	900	" Screw.....	10	—
11878	888	" Shaft.....	7	00
11854	830	" " Bushing.....	75	5
437c	899	" " Set Screw.....	04	—
11913	825	" Side Cover.....	25	—
65D	899	" " " Screw.....	15	—
8708	827	" Spool Pin.....	05	72
11856	896	Balance Wheel with two 354c.....	1	75
354c	899	" " Set Screw.....	06	—
* 19597	—	Bed.....	18	50
19598	—	" Extension with 19633.....	6	00
12591	879	" " Dowel Pin.....	10	—
123E	901	" " Screw.....	06	—
11361	894	" Foot Bracket (left).....	10	—
11360	894	" " " (right).....	10	—
507E	898	" " " Bolt with 1515....	02	—
1515	890	" " " " Nut.....	01	—
670E	862	" Front Bearing Clamping Screw	06	—
19599	876	Buff Wheel Clamp Carrier with 19614	1	50
19600	878	" " " " Cap.....	50	—
12596	879	" " " " " Pin... ..	03	—
691	—	" " " " " Ser... ..	04	—
19601	876	" " " " Locking Rack with 19614.....	3	00
19602	876	Buff Wheel Clamp Carrier Locking Rack Hinge Bracket with two 453c	1	50
19603	878	Buff Wheel Clamp Carrier Locking Rack Hinge Bracket Hinge Pin... ..	25	—
2022	879	Buff Wheel Clamp Carrier Locking Rack Hinge Bracket Pin.....	01	—
453c	899	Buff Wheel Clamp Carrier Locking Rack Hinge Bracket Set Screw ...	02	—
381E	899	Buff Wheel Clamp Carrier Locking Rack Screw.....	06	—
19604	—	Buff Wheel Clamp Carrier Rack Latch, Nos. 19605 to 19608.....	1	35
19605	877	Buff Wheel Clamp Carrier Rack Latch Bracket with 453c.....	75	—
2022	879	Buff Wheel Clamp Carrier Rack Latch Bracket Pin.....	01	—

No	Plate	Name	Each	Old No.
453c	899	Buff Wheel Clamp Carrier Rack Latch Bracket Set Screw.....	02	—
19606	880	Buff Wheel Clamp Carrier Rack Latch Pin.....	30	—
19607	880	Buff Wheel Clamp Carrier Rack Latch Pin Head.....	25	—
19608	879	Buff Wheel Clamp Carrier Rack Latch Spring.....	05	—
19609	881	Buff Wheel Clamp Carrier Sliding Flange with 453c.....	75	—
2049	853	Buff Wheel Clamp Carrier Sliding Flange Pin.....	01	236
453c	899	Buff Wheel Clamp Carrier Sliding Flange Set Screw.....	02	—
19610	880	Buff Wheel Clamp Carrier Sliding Flange Shaft.....	15	—
19611	880	Buff Wheel Clamp Carrier Sliding Flange Gear with 462c.....	75	—
2049	853	Buff Wheel Clamp Carrier Sliding Flange Gear Pin.....	01	236
462c	—	Buff Wheel Clamp Carrier Sliding Flange Gear Set Screw.....	02	—
19612	876	Buff Wheel Clamp Carrier Sliding Rack with 19613.....	2 00	—
685D	—	Buff Wheel Clamp Carrier Sliding Rack Screw.....	15	—
8734	886	Buff Wheel Clamp Carrier Sliding Rack Spring.....	08	—
19613	—	Buff Wheel Clamp Carrier Sliding Rack Spring Hook for 19612....	05	—
19614	—	Buff Wheel Clamp Carrier Sliding Rack Spring Hook for 19601.....	05	—
792c	903	Buff Wheel Clamp Carrier Sliding Rack Stop Screw.....	03	—
19615	880	Buff Wheel Clamp Carrier Stop Dog 164E 899	30	—
		Screw.....	04	—
19616	878	Buff Wheel Clamp Carrier Stop Plate 691	25	—
		Screw.....	04	—
19617	878	Buff Wheel Clamp Carrier Weight (3 lbs.) with 19624 and 19625.....	30	—
19618	878	Buff Wheel Clamp Carrier Weight (4 lbs.) with 19624 and 19625.....	35	—
19619	—	Buff Wheel Clamp Carrier Weight Connection (belt) with 19621.....	10	—
19620	879	Buff Wheel Clamp Carrier Weight Connection Guide Pin for 19641...	03	—
19621	—	Buff Wheel Clamp Carrier Weight Connection Hook for 19619.....	02	—

No.	Plate	Name	Each	Old No.
19614	—	Buff Wheel Clamp Carrier Weight Connection Hook for 19599.....	05	—
19622	881	Buff Wheel Clamp Carrier Weight Connection Pulley.....	35	—
19623	880	Buff Wheel Clamp Carrier Weight Connection Pulley Bracket.....	30	—
164E	899	Buff Wheel Clamp Carrier Weight Connection Pulley Bracket Screw..	04	—
917D	900	Buff Wheel Clamp Carrier Weight Connection Pulley Screw.....	12	—
19624	881	Buff Wheel Clamp Carrier Weight Eyelet for 19617 and 19618.....	05	—
19625	881	Buff Wheel Clamp Carrier Weight Eyelet Hook.....	05	—
19626	880	Buff Wheel Clamp Spindle with three 19627.....	1 00	—
19611	880	Buff Wheel Clamp Spindle Gear with 462c.....	75	—
2049	853	Buff Wheel Clamp Spindle Gear Pin 462c	01	236
		“ “ “ “ “ Set Screw.....	02	—
19627	879	Buff Wheel Clamp Spindle Spur....	05	—
19628	880	“ “ “ “ Washer..	15	—
918D	900	“ “ “ “ “ Ser..	10	—
19620	—	Cloth Plate.....	2 00	—
899	901	“ “ Screw.....	04	—
11363	825	Crank Connecting Rod.....	1 25	206
* 11364	—	“ “ “ Cap.....	—	—
145E	899	“ “ “ “ “ Screw..	04	—
565c	898	“ “ “ “ Hinge Screw	15	—
1513	890	“ “ “ “ “ “	—	—
		Nut.....	05	—
11865	855	Face Plate.....	2 00	—
101D	901	“ “ Screw.....	04	—
11866	—	“ “ complete, No. 11865 with 190, 910c, 11867, 11868, 11871 to 11876, two each 164D and 8800....	5 75	—
19630	877	Feed Bar.....	4 00	—
307c	898	“ “ Screw Centre.....	06	—
1513	890	“ “ “ “ Nut.....	05	—
11367	830	“ “ Cam with two 445c.....	1 00	12
445c	900	“ “ Set Screw.....	03	—
11368	830	“ “ Connecting Link.....	35	16
565c	898	“ “ “ “ Hinge Screw..	15	—
1513	890	“ “ “ “ “ “	—	—
		Nut.....	05	—
19631	879	Feed Dog.....	1 00	—
19632	877	“ “ Carrier with 8077.....	2 00	—
568c	898	“ “ “ “ Hinge Screw.....	15	—
8734	886	“ “ “ “ Spring.....	08	—
8077	879	“ “ “ “ “ Hook for 19632.....	01	—

No.	Plate	Name	Each	Old No.
19633	879	Feed Dog Carrier Spring Hook for 19598.....	05	—
919o	900	Feed Dog Screw.....	06	—
11870	825	" Forked Connection.....	1 75	207
565o	898	" " " Hinge Scr.....	15	—
1513	890	" " " " " " Nut.....	05	—
11871	825	Feed Lifting Rock Shaft.....	1 40	31
11872	—	" " " " 11871 with 11874.....	2 35	29
11874	830	Feed Lifting Rock Shaft Crank with 453o and 1861.....	95	—
2117	890	Feed Lifting Rock Shaft Crank Pin.....	01	23
1861	862	" " " " Roller and Stud.....	35	—
453o	899	Feed Lifting Rock Shaft Crank Set Screw.....	02	—
564o	898	Feed Lifting Rock Shaft Scr. Centre.....	12	—
1508	890	" " " " " " Nut.....	06	—
11875	830	Feed Regulator.....	60	208
588E	898	" " Hinge Screw.....	15	—
254D	902	" " Thumb Screw.....	40	—
11876	825	" Rock Shaft.....	1 40	21A
11877	—	" " " 11876 with 11879.....	2 00	20
11879	898	" " " Crank with 453o.....	60	22
2117	890	" " " Pin.....	01	23
453o	899	" " " Set Screw.....	02	—
564o	898	" " " Screw Centre.....	12	—
1508	890	" " " " " Nut.....	06	—
19634	880	Guide Pin for circular stitching.....	35	—
19635	876	" Plate for circular stitching.....	1 25	—
691	—	" Screw.....	04	—
11522	855	Lifting Presser Bar.....	1 00	300
11523	856	" " Bell Crank.....	1 50	307
11524	856	" " " Adjusting Link.....	1 50	356
11525	—	Lifting Presser Bar Bell Crank Adjusting Link 11524 with 1518, 1828 and 2718.....	1 80	308
611D	—	Lifting Presser Bar Bell Crank Adjusting Link Adjusting Screw.....	12	—
8D	898	Lifting Presser Bar Bell Crank Adjusting Link Hinge Screw.....	20	—
1828	899	Lifting Presser Bar Bell Crank Adjusting Link Roller and Screw 372o.....	25	—
372o	898	Lifting Presser Bar Bell Crank Adjusting Link Roller Screw.....	12	—
1518	890	Lifting Presser Bar Bell Crank Adjusting Link Roller Screw Nut.....	04	—
2718	897	Lifting Presser Bar Bell Crank Adjusting Link Roller Screw Nut Washer.....	01	309

No.	Plate	Name	Each	Old No.
11526	889	Lifting Presser Bar Bell Crank Connection Stud.....	75	—
11527	—	Lifting Presser Bar Bell Crank Connection Stud 11526 with 164D, 11528 and two 858o.....	95	310
164D	899	Lifting Presser Bar Bell Crank Connection Stud Screw.....	04	—
11528	862	Lifting Presser Bar Bell Crank Connection Stud Screw Washer.....	15	311
858o	900	Lifting Presser Bar Bell Crank Connection Stud Set Screw.....	03	—
11867	857	Lifting Presser Bar Lifter.....	1 00	—
11531	881	" " " Bracket.....	1 25	305
2117	890	" " " Pin.....	01	23
11868	860	" " " Hinge Pin.....	10	—
910o	900	" " " " " Set Screw.....	03	—
11409	827	Lifting Presser Bar Spring.....	15	50
11869	860	" " Adjusting Block with 523o.....	1 00	—
523o	901	Lifting Presser Bar Spring Adjusting Block Set Screw.....	18	—
11880	828	Needle Bar.....	1 00	35
11881	830	" " Connecting Link.....	80	298
566o	898	" " " Hinge Screw.....	15	—
1513	890	Needle Bar Connecting Link Hinge Screw Nut.....	05	—
11883	887	Needle Bar Connecting Stud with two 445o.....	1 25	36
445o	900	Needle Bar Connecting Stud Set Scr.....	03	—
258D	899	" " Screw Bushing.....	20	—
11847	888	" Clamp with 245 and 11885.....	75	—
11885	890	" " Gib.....	15	40
245	899	" " Set Screw.....	03	—
11497	—	Oil Cup.....	80	—
11917	—	" " Cover.....	25	—
9084	889	" " Hinge Pin.....	02	—
2205	887	" " Latch Spring.....	04	296
207	901	" " " Screw.....	02	—
185D	899	" " Screw.....	05	—
11919	888	" " Thread Eyelet.....	05	—
8953	—	" or Wax Stripper (felt).....	03	297
5480	887	" " " Washer (steel) for 11497.....	01	—
11918	888	Oil or Wax Stripper Washer (steel) for 11917.....	03	—
207	901	Oil or Wax Stripper Washer Screw.....	02	—
11921	825	" Cup complete, Nos. 2205, 5480, 9084, 11497, 11917, 11918, 11919, two 8953 and three 207.....	1 25	—

No.	Plate	Name	Each	Old No.
11841	827	Oscillating Rock Shaft (steel).....	1 75	—
11898	827	“ “ “ Hinge Pin...	75	256
1508	890	“ “ “ “ “		
		Nut	06	—
622c	899	Oscillating Rock Shaft Hinge Pin Screw Bearing.....	15	—
1508	890	Oscillating Rock Shaft Hinge Pin Screw Bearing Nut.....	06	—
11165	897	Oscillating Rock Shaft Oil Pad.....	01	—
11842	—	“ “ “ 11841 with 622c, 11165, 11398 and two 1508...	2 75	—
11850	825	Oscillating Shaft.....	1 25	—
11893	887	“ “ Collar with two 453c	10	354
453c	899	“ “ “ Set Screw....	02	—
11848	—	“ “ Crank.....	30	—
11849	830	“ “ “ 11848 with 453c, 1513 and 1885.....	75	—
2117	890	Oscillating Shaft Crank Pin.....	01	23
1885	900	“ “ “ Roller and Screw Stud	40	—
1513	890	Oscillating Shaft Crank Roller and Screw Stud Nut.....	05	—
190	899	Oscillating Shaft Crank Roller Cap Scr.	03	—
5968	887	“ “ “ “ “ “		
		Washer.....	02	—
453c	899	Oscillating Shaft Crank Set Screw...	02	—
19636	—	Shuttle (cylinder), 3-in. diam., with 11910.....	6 00	—
11910	833	Shuttle Bobbin (solid and hardened).	25	—
11852	833	“ Cylinder.....	2 50	—
8961	890	“ “ Hinge Pin.....	02	63
11853	833	“ “ Latch.....	15	—
12002	833	“ “ “ Pin.....	01	—
11854	833	“ “ “ Spring.....	03	—
590x	901	“ “ “ “ Screw..	02	—
11856	830	“ Driver with 453c.....	1 75	—
2117	890	“ “ Pin.....	01	23
453c	899	“ “ Set Screw.....	02	—
19637	881	“ Frame.....	2 75	—
19638	877	“ Race Back.....	1 00	—
11833	889	“ “ Dowel Pin.....	01	—
11834	830	“ “ “ Spring.....	25	—
32d	901	“ “ “ “ Screw....	15	—
19639	877	“ “ Body.....	2 75	—
11837	825	“ Frame with 11833....	2 00	—
11838	889	“ “ “ Position Pin..	03	—
19640	—	“ “ complete, Nos. 32d, 11834, 19638, 19639 and two 11833.	4 00	—
135d	899	Shuttle Race Screw.....	05	—
773c	901	“ Tension Regulating Screw..	05	—
8964	833	“ “ Spring.....	40	360

No.	Plate	Name	Each	Old No.
11043	897	Tension Friction Washer (steel).....	03	—
8879	887	“ “ “ (felt). Old No. 171, No. 5 Machine.....	01	—
1560	890	Tension Regulating Thumb Nut....	04	—
8905	887	“ “ “ “ “		
		Washer.....	01	361
850d	902	Tension Screw Stud.....	25	—
8791	888	“ Spring.....	10	320
11044	897	“ Wheel.....	75	—
11871	—	“ (“) complete, Nos. 850d, 1560, 8791, 8905, 11043, 11044 and two 8879.....	1 25	—
11872	861	Thread Eyelet for 11866	05	—
11873	860	“ Guard “ “	03	—
11547	—	“ Retainer Bracket.....	30	328
158d	901	“ “ “ Screw.....	03	—
2102	888	“ “ Disc.....	05	84
1560	890	“ “ Regulating Thumb Nut.....	04	—
8905	887	Thread Retainer Regulating Thumb Nut Washer.....	01	361
633d	862	Thread Retainer Screw Stud.....	10	—
2103	888	“ “ Spring.....	03	85
2049	853	“ “ Thread Guide Pin.	01	236
11546	859	“ “ complete, Nos. 633d, 1560, 2049, 2103, 8905, 11547 and two 2102.....	60	327
11428	827	Thread Take-up Cam (steel) with 434c	5 00	80
8873	887	“ “ “ Pin.....	05	81
434c	890	“ “ “ Set Screw.....	04	—
11844	—	“ “ Lever.....	1 20	—
11845	856	“ “ “ 11844 with 1518 and 1845.....	1 50	321
567d	898	Thread Take-up Lever Hinge Screw.	15	—
1845	899	“ “ “ Roller and Screw Stud	30	—
1518	890	Thread Take-up Lever Roller and Screw Stud Nut.....	04	—
11874	857	Thread Take-up Spring.....	15	—
11875	857	“ “ “ Regulator... 164d 899	60	—
		“ “ “ “ “		
		Screw.....	04	—
8800	890	Thread Take-up Spring Regulator Screw Washer.....	06	90
164d	899	Thread Take-up Spring Scr.....	04	—
8800	890	“ “ “ “ Washer	06	90
11876	861	“ “ “ Thread Guard.....	10	—
190	899	Thread Take-up Spring Thread Guard Screw.....	03	—
19641	—	Throat Plate Body with 19620.....	1 00	—

BOBBIN WINDER (HAND) FOR MACHINE BED.

No.	Plate	Name	Each	Old No.
11755	—	Belt.....	05	—
11756	—	" 11755 with 25028. Old No. 104, No. 11 Machine.....	05	—
25028	889	Belt Hook.....	01	371
135D	899	Bobbin Winder Screw.....	05	—
11758	858	Frame. Old No. 101, No. 11 Mach..	50	—
11759	858	Pulley. " " 103, " " " "	25	—
11760	892	" Driving Wheel.....	50	366
8380	893	" " " Handle.....	03	—
11762	893	" " " Stud..	10	—
8382	887	" " " " " "	01	—
		Washer.....	01	—
11761	859	Pulley Driving Wheel Handle complete, Nos. 8380, 8382 and 11762...	10	369
11763	887	Pulley Driving Wheel Stud.....	10	367
2269	889	" " " " Pin.....	01	153
11764	888	" " " " Washer.	01	368
11765	858	Spindle. Old No. 102, No. 11 Mach.	40	—
11754	855	Bobbin Winder complete, Nos. 2269, 11756, 11758, 11759, 11760, 11761, 11763, 11764 and 11765. Old No. 100, No. 11 Machine.....	2 00	—

Numerical List of Parts.

No.	Plate.	Name.	Each.	Old No.
8D	898	Lifting Presser Bar Bell Crank Adjusting Link Hinge Screw.	20	—
32D	901	Shuttle Race Back Spring Screw.....	15	—
65D	899	Arm Side Cover Screw.....	15	—
123E	901	Shuttle Race Screw for 7-22 Machine.	06	—
123E	901	Bed Extension Screw " 7-24 " "	06	—
128E	901	Vibrating Presser Bar Cap Bracket Screw (inside).....	04	—
129D	901	Needle Bar Connecting Stud Clamping Screw for 7-22 Machine.....	04	—
135D	899	Feed Lifting Rock Shaft Crank Clamping Screw for 7-22 Machine.....	05	—
135D	899	Oil Cup Screw.....	05	—
135D	899	Shuttle Race Screw for 7-24 Machine.	05	—
135D	899	Bobbin Winder Screw for 11754.....	05	—
145E	899	Crank Connecting Rod Cap Screw...	04	—
158D	901	Thread Retainer Bracket Screw for 7-24 Machine.....	03	—
161D	901	Face Plate Screw.....	04	—
164E	899	Buff Wheel Clamp Carrier Stop Dog Screw for 7-24 Machine.....	04	—
164E	899	Buff Wheel Clamp Carrier Weight Connection Pulley Bracket Screw for 7-24 Machine.....	04	—
164D	899	Lifting Presser Bar Bell Crank Connection Stud Screw.....	04	—
164D	899	Thread Take-up Spring Regulator Scr.	04	—
164D	899	" " " " Screw.....	04	—
164D	899	Vibrating Presser Foot Screw for 7-22 Machine.....	04	—
166D	899	Thread Eyelet Screw for 7-22 Mach..	07	—
180D	901	" Retainer Bracket Screw for 7-22 Machine.....	03	—
190	899	Oscillating Shaft Crank Roller Cap Screw.....	03	—
190	899	Thread Take-up Spring Thread Guard Screw.....	03	—
190	899	Vibrating Presser Bar Spring Stud Scr.	03	—
207	901	Needle Set Screw for 7-22 Machine ..	02	—
207	901	Oil Cup Cover Latch Spring Screw ..	02	—
207	901	Oil or Wax Stripper Washer Screw..	02	—
212D	903	Vibrating Presser and Stretching Foot Stop Screw for 7-24 Machine.....	04	—
245	899	Needle Clamp Set Screw for 7-24 Mach.	03	—
254D	902	Feed Regulator Thumb Screw.....	40	—
254D	902	Guide Thumb Screw for 7-22 Mach..	40	—
257D	902	Needle Bar Screw Bushing for 7-22 Machine.....	20	—

No. Plate	Name	Each	Old No.
258D 899	Needle Bar Screw Bushing for 7-24 Machine.....	20	—
307C 898	Feed Bar Screw Centre.....	06	—
354C 899	Balance Wheel Set Screw.....	06	—
354C 899	Belt Shifter Pulley (fast) Set Screw for 11943.....	06	—
372C 898	Lifting Presser Bar Bell Crank Adjusting Link Roller Screw.....	12	—
381E 899	Buff Wheel Clamp Carrier Locking Rack Screw for 7-24 Machine.....	06	—
381D 899	Feed Dog Screw for 7-22 Machine...	06	—
381D 899	Throat Plate Screw.....	06	—
389 901	Cloth Plate Screw.....	04	—
401D 899	Throat Plate Needle Hole Strip Scr..	02	—
434C 899	Belt Shifter Fork Set Screw for 11941	04	—
434C 899	Thread Take-up Cam Set Screw.....	04	—
437C 899	Arm Shaft Bushing Set Screw.....	04	—
445C 900	Feed Cam Set Screw.....	03	—
445C 900	Needle Bar Connecting Stud Set Scr..	03	—
448C 900	Belt Shifter Pulley (loose) Collar Set Screw for 11459.....	03	—
448C 900	Belt Shifter Slide Rod Collar Set Screw for 11453.....	03	—
448C 900	Belt Shifter Slide Rod Spring Collar Set Screw for 11453.....	03	—
448C 900	Shuttle Driver Set Screw for 7-22 Machine.....	03	—
453C 899	Buff Wheel Clamp Carrier Locking Rack Hinge Bracket Set Screw for 7-24 Machine.....	02	—
453C 899	Buff Wheel Clamp Carrier Rack Latch Bracket Set Screw for 7-24 Machine	02	—
453C 899	Buff Wheel Clamp Carrier Sliding Flange Set Screw for 7-24 Machine.	02	—
453C 899	Feed Lifting Rock Shaft Crank Set Screw for 7-24 Machine.....	02	—
453C 899	Feed Rock Shaft Crank Set Screw....	02	—
453C 899	Oscillating Shaft Collar Set Screw for 7-24 Machine.....	02	—
453C 899	Oscillating Shaft Crank Set Screw....	02	—
453C 899	Shuttle Driver Set Screw for 7-24 Mach	02	—
462C —	Buff Wheel Clamp Carrier Sliding Flange Gear Set Screw for 7-24 Machine.....	02	—
462C —	Buff Wheel Clamp Spindle Gear Set Screw for 7-24 Machine.....	02	—
507E 898	Bed Foot Bracket Bolt with 1515....	02	—
523C 901	Lifting Presser Bar Spring Adjusting Block Set Screw.....	18	—
564C 898	Feed Lifting Rock Shaft Screw Centre	12	—
564C 898	" Rock Shaft Screw Centre.....	12	—

No. Plate	Name	Each	Old No.
565C 898	Crank Connecting Rod Hinge Screw..	15	—
565C 898	Feed " Link Hinge Screw..	15	—
565C 898	" Forked Connection Hinge Screw..	15	—
566C 898	Needle Bar Connecting Link Hinge Screw.....	15	—
567D 898	Thread Take-up Lever Hinge Screw..	15	—
567D 898	Belt Shifter Cord Pulley Screw for 11945.....	15	—
568C 898	Feed Dog Carrier Hinge Screw for 7-24 Machine.....	15	—
568E 898	Feed Regulator Hinge Screw.....	15	—
590E 901	Shuttle Cylinder Latch Spring Screw	02	—
611D —	Lifting Presser Bar Bell Crank Adjusting Link Adjusting Screw.....	12	—
612E —	Vibrating Presser Bar Cap Bracket Screw (outside).....	06	—
622C 899	Oscillating Rock Shaft Hinge Pin Screw Bearing.....	15	—
633D 898	Thread Retainer Screw Stud 7-24 Machine.....	10	—
657C 903	Vibrating Presser and Stretching Foot Hinge Screw for 7-24 Machine.....	10	—
670E 898	Bed Front Bearing Clamping Screw for 7-24 Machine.....	06	—
681D 898	Vibrating Presser Bar Hinge Screw..	08	—
682D 898	" " " Stop Thumb Screw.....	10	—
685D —	Buff Wheel Clamp Carrier Sliding Rack Screw for 7-24 Machine.....	15	—
691 —	Buff Wheel Clamp Carrier Cap Screw for 7-24 Machine.....	04	—
691 —	Buff Wheel Clamp Carrier Stop Plate Screw for 7-24 Machine.....	04	—
691 —	Guide Plate Screw for 7-24 Machine.	04	—
773C 901	Shuttle Tension Regulating Screw....	05	—
792C 903	Buff Wheel Clamp Carrier Sliding Rack Stop Screw for 7-24 Machine.	03	—
850D 902	Tension Screw Stud.....	25	—
858C 900	Lifting Presser Bar Bell Crank Connection Stud Set Screw.....	03	—
872E 900	Arm Screw.....	10	—
910C 900	Lifting Presser Bar Lifter Hinge Pin Set Screw.....	03	—
915D 903	Thread Retainer Screw Stud for 7-22 Machine.....	15	—
917D 900	Buff Wheel Clamp Carrier Weight Connection Pulley Screw for 7-24 Machine.....	12	—
918D 900	Buff Wheel Clamp Spindle Washer Screw for 7-24 Machine.....	10	—

No.	Plate	Name	Each	Old No.
919c	900	Feed Dog Screw for 7-24 Machine....	06	—
1508	890	" Lifting Rock Shaft Screw Centre Nut	06	—
1508	890	Feed Rock Shaft Screw Centre Nut ..	06	—
1508	890	Oscillating Rock Shaft Hinge Pin Nut	06	—
1508	890	" " " " " Scr.	06	—
		Bearing Nut.....	06	—
1513	890	Crank Connecting Rod Hinge Screw Nut.....	05	—
1513	890	Feed Bar Screw Centre Nut.....	05	—
1513	890	" Connecting Link Hinge Screw Nut.....	05	—
1513	890	Feed Forked Connection Hinge Screw Nut.....	05	—
1513	890	Needle Bar Connecting Link Hinge Screw Nut.....	05	—
1513	890	Oscillating Shaft Crank Roller and Screw Stud Nut.....	05	—
1515	890	Bed Foot Bracket Bolt Nut.....	01	—
1518	890	Lifting Presser Bar Bell Crank Adjusting Link Roller Screw Nut.....	04	—
1518	890	Thread Take-up Lever Roller and Screw Stud Nut.....	04	—
1560	890	Tension Regulating Thumb Nut.....	04	—
1560	890	Thread Retainer Regulating Thumb Nut.....	04	—
1620	903	Vibrating Presser and Stretching Foot Hinge Screw Nut for 7-24 Machine	03	—
1828	899	Lifting Presser Bar Bell Crank Adjusting Link Roller and Scr. 3720..	25	—
1845	899	Thread Take-up Lever Roller and Scr. Stud.....	30	—
1861	862	Feed Lifting Rock Shaft Crank Roller and Stud.....	35	—
1885	900	Oscillating Shaft Crank Roller and Screw Stud.....	40	—
2022	879	Buff Wheel Clamp Carrier Locking Rack Hinge Bracket Pin for 7-24 Machine.....	01	—
2022	879	Buff Wheel Clamp Carrier Rack Latch Bracket Pin for 7-24 Mach..	01	—
2049	853	Buff Wheel Clamp Carrier Sliding Flange Pin for 7-24 Machine.....	01	236
2049	853	Buff Wheel Clamp Carrier Sliding Flange Gear Pin for 7-24 Machine.	01	236
2049	853	Buff Wheel Clamp Spindle Gear Pin for 7-24 Machine.....	01	236
2049	853	Thread Retainer Thread Guide Pin for 7-24 Machine.....	01	236
2049	853	Vibrating Presser Bar Guide Bracket Pin.....	01	236

No.	Plate	Name	Each	Old No.
2103	883	Thread Retainer Disc.....	05	84
2103	888	" " Spring.....	03	85
2117	890	Belt Shifter Guide Rod Pin for 11945	01	23
2117	890	" " Slide " " " "	01	23
2117	890	Feed Lifting Rock Shaft Crank Pin for 7-24 Machine.....	01	23
2117	890	Feed Rock Shaft Crank Pin.....	01	23
2117	890	Lifting Presser Bar Lifter Bracket Pin.....	01	23
2117	890	Oscillating Shaft Crank Pin.....	01	23
2117	890	Shuttle Driver Pin for 7-24 Machine..	01	23
2205	887	Oil Cup Cover Latch Spring.....	04	296
2269	889	Needle Clamp Pin for 7-23 Machine..	01	—
2269	889	Bobbin Winder Pulley Driving Wheel Stud Pin for 11754.....	01	153
2718	897	Lifting Presser Bar Bell Crank Adjusting Link Roller Screw Nut Washer.....	01	309
3146	889	Vibrating Presser Bar Stop Block Washer (front).....	01	343
5480	887	Oil or Wax Stripper Washer (sterl) for 11497.....	01	—
5667	—	Belt Shifter Foot Lever for 5668....	15	—
5668	895	" " " " 5667 with 5669 and 5671 for 11945.....	40	—
5669	—	Belt Shifter Foot Lever Bracket for 5668.....	10	—
5671	897	Belt Shifter Foot Lever Hinge Pin for 5668.....	01	—
5672	895	Belt Shifter Foot Lever Lifting Spring for 11945.....	03	—
5968	887	Oscillating Shaft Crank Roller Cap Screw Washer.....	02	—
6439	—	Belt Shifter Foot Lever Chain (length 36 to 45 inches) for 11945.....	20	—
8077	879	Feed Dog Carrier Spring Hook for 19632, for 7-24 Machine.....	01	—
8380	893	Bobbin Winder Pulley Driving Wheel Handle for 11761.....	03	—
8382	887	Bobbin Winder Pulley Driving Wheel Handle Stud Washer for 11761.....	01	—
8702	887	Arm Dowel Pin.....	15	3
8708	827	" Spool Pin for 7-24 Machine....	05	172
8734	886	Buff Wheel Clamp Carrier Sliding Rack Spring for 7-24 Machine.....	08	—
8734	886	Feed Dog Carrier Spring for 7-24 Machine.....	08	—
8791	888	Tension Spring.....	10	320
8800	890	Thread Take-up Spring Regulator Scr. Washer.....	06	90

No.	Plate	Name	Each	Old No.
8800	890	Thread Take-up Spring Scr. Washer.	06	90
8804	892	Belt Shifter Frame Handle for 11941.	30	101
8873	887	Thread Take-up Cam Pin	05	81
8879	887	Tension Friction Washer (felt). Old No. 171, No. 5 Machine	01	—
8905	887	Tension Regulating Thumb Nut Washer	01	861
8905	887	Thread Retainer Regulating Thumb Nut Washer	01	861
8908	894	Wrench for 354c	10	351
8909	894	" " 1513 and 1518	15	352
8910	894	" " 1508	25	—
8953	—	Oil or Wax Stripper (felt)	03	297
8961	890	Shuttle Cylinder Hinge Pin	02	63
8964	838	" Tension Spring for 7-24 Mach.	40	860
9084	889	Oil Cup Cover Hinge Pin	02	—
11043	897	Tension Friction Washer (steel)	03	—
11044	897	" Wheel	75	—
11165	897	Oscillating Rock Shaft Oil Pad	01	—
11854	830	Arm Shaft Bushing	75	5
11856	896	Balance Wheel with two 354c	1 75	6
11860	894	Bed Foot Bracket (right)	10	—
11861	894	" " " (left)	10	—
11863	825	Crank Connecting Rod	1 25	206
* 11864	—	" " " Cap	—	—
11867	830	Feed Cam with two 445c	1 00	12
11868	880	" Connecting Link	35	16
11870	825	" Forked Connection	1 75	207
11871	825	" Lifting Rock Shaft	1 40	31
11872	—	" " " " 11871 with 11874, for 7-24 Machine	2 35	29
11874	880	Feed Lifting Rock Shaft Crank with 453c and 1861, for 7-24 Machine	95	—
11875	880	Feed Regulator	60	208
11876	825	" Rock Shaft	1 40	21A
11877	—	" " " 11876 with 11879	2 00	20
11879	898	" " " Crank with 453c	60	22
11880	828	Needle Bar for 7-24 Machine	1 00	85
11881	830	" " Connecting Link for 7-24 Machine	80	288
11883	887	Needle Bar Connecting Stud with two 445c, for 7-24 Machine	1 25	86
11885	890	Needle Clamp Gib	15	40
11893	887	Oscillating Shaft Collar with two 453c, for 7-24 Machine	10	854
11898	827	Oscillating Rock Shaft Hinge Pin	75	256
11409	827	Lifting Presser Bar Spring	15	50
11428	827	Thread Take-up Cam (steel) with 434c	5 00	80
11446	890	Belt Shifter Cord Eyelet for 11945	04	106
11447	874	" " " Pulley " " "	35	107

No.	Plate	Name	Each	Old No.
11450	828	Belt Shifter Guide Rod for 11945	30	109
11451	828	" " Slide Rod " " "	75	102
11453	887	" " " Collar with two 448c, for 11945	25	103
11453	887	Belt Shifter Slide Rod Spring Collar with two 448c, for 11945	25	103
11459	897	Belt Shifter Pulley (loose) Collar with two 448c, for 11945	25	98
11497	—	Oil Cup	80	—
11523	855	Lifting Presser Bar	1 00	300
11523	856	" " " Bell Crank	1 50	807
11524	856	" " " " Adjusting Link	1 50	356
11525	—	Lifting Presser Bar Bell Crank Adjusting Link 11524 with 1518, 1828 and 2718	1 80	808
11526	889	Lifting Presser Bar Bell Crank Connection Stud	75	—
11527	—	Lifting Presser Bar Bell Crank Connection Stud 11526 with 164d, 11528 and two 858c	95	310
11528	862	Lifting Presser Bar Bell Crank Connection Stud Screw Washer	15	311
11531	881	Lifting Presser Bar Lifter Bracket	1 25	305
11546	859	Thread Retainer complete, Nos. 633d, 1560, 2049, 2103, 8905, 11547 and two 2102, for 7-24 Machine	60	327
11547	—	Thread Retainer Bracket for 7-24 Machine	30	328
11559	859	Vibrating Presser Bar Cap Bracket (upper)	50	335
11560	859	Vibrating Presser Bar Cap Bracket (lower)	50	336
11561	859	Vibrating Presser Bar Guide Bracket	2 00	339
11563	862	" " " Spring Stud	40	337
11564	862	" " " " " Spring	02	338
11565	859	Vibrating Presser Bar Stop complete, Nos. 633d, 3146, 11566 and 11567	40	341
11566	862	Vibrating Presser Bar Stop Block	25	342
11567	862	Washer (inside)	01	344
11754	855	Bobbin Winder (Hand, for Machine Bed) complete, Nos. 2269, 11756, 11758, 11759, 11760, 11761, 11763, 11764 and 11765. Old No. 100, No. 11 Machine	2 00	—
11755	—	Bobbin Winder Belt for 11756	05	—
11756	—	" " " 11755 with 25028, for 11754. Old No. 104, No. 11 Machine	05	—

No.	Plate	Name	Each	Old No.
11758	858	Bobbin Winder Frame for 11754. Old No. 101, No. 11 Machine.	50	—
11759	858	Bobbin Winder Pulley for 11754. Old No. 103, No. 11 Machine.	25	—
11760	892	Bobbin Winder Pulley Driving Wheel for 11754	50	366
11761	859	Bobbin Winder Pulley Driving Wheel Handle complete, Nos. 8380, 8382 and 11762	10	369
11762	893	Bobbin Winder Pulley Driving Wheel Handle Stud for 11761	10	—
11763	887	Bobbin Winder Pulley Driving Wheel Stud for 11754	10	367
11764	888	Bobbin Winder Pulley Driving Wheel Stud Washer for 11754	01	368
11765	853	Bobbin Winder Spindle for 11754. Old No 102, No 11 Machine.	40	—
11831	895	Screw Driver, 5-in. blade	20	—
11833	889	Shuttle Race Back Dowel Pin	01	—
11834	830	" " Spring for 7-24 Machine.	25	—
11837	825	Shuttle Race Frame with 11838, for 7-24 Machine.	2	00
11838	889	Shuttle Race Frame Position Pin for 7-24 Machine.	03	—
11841	827	Oscillating Rock Shaft (steel).	1	75
11842	—	" " " 11841 with 623c, 11165, 11398 and two 1508.	2	75
11844	—	Thread Take-up Lever for 7-24 Mach.	1	20
11845	856	" " " 11844 with 1518 and 1845, for 7-24 Machine.	1	50 321
11847	888	Needle Clamp with 245 and 11985 for 7-24 Machine.	75	—
11848	—	Oscillating Shaft Crank.	30	—
11849	830	" " " 11848 with 453c, 1513 and 1885	75	—
11850	825	Oscillating Shaft for 7-24 Machine.	1	25
11852	833	Shuttle Cylinder " " "	2	50
11853	833	" " " Latch for 19569 and 19636	15	—
11854	833	Shuttle Cylinder Latch Spring.	03	—
11856	830	" Driver with 453c for 7-24 Mach	1	75
11865	855	Face Plate for 7-24 Machine.	2	00
11866	—	" " complete, No. 11865 with 190, 910c, 11867, 11868, 11871 to 11876, two each 164d and 8800 for 7-24 Machine.	5	75
11867	857	Lifting Presser Bar Lifter.	1	00
11868	860	" " " " Hinge Pin.	10	—
11869	860	" " " " Spring Adjusting Block with 522c	1	00

No.	Plate	Name	Each	Old No.
11871	—	Tension (wheel) complete, Nos. 850d, 1560, 879L, 8905, 11043, 11044 and two 8879 for 7-24 Machine	1	25
11872	861	Thread Eyelet for 11866 for 7-24 Mach.	05	—
11873	860	" Guard for 11866 and 19596	03	—
11874	857	" Take-up Spring	15	—
11875	857	" " " Regulator	60	—
11876	861	" " " Thread Guard for 7-24 Machine	10	—
11878	838	Arm Shaft	7	00
11910	833	Shuttle Bobbin (solid and hardened).	25	—
11913	825	Arm Side Cover	25	—
11917	—	Oil Cup Cover	25	—
11918	888	" or Wax Stripper Washer (steel) for 11917	03	—
11919	888	Oil Cup Thread Eyelet	05	—
11921	825	" " complete, Nos. 2205, 5480, 9084, 11497, 11917, 11918, 11919, two 8953 and three 207	1	25
11940	896	Belt Shifter Fork for 11945	75	—
11941	896	" " Frame with 8804 and two 434c for 11945	1	75
11942	823	Belt Shifter Slide Rod Spring for 11945	15	—
11943	896	" " Pulley (fast) with two 354c for 11945	1	10
11944	896	Belt Shifter Pulley (loose) for 11945	1	00
11945	—	" " complete, Nos. 567d, 5668, 5072, 6439, 11446, 11447, 11450, 11451, 11459, 11940 to 11944, two each 2117 and 11453	7	50
12002	833	Shuttle Cylinder Latch Pin	01	—
12591	879	Bed Extension Dowel Pin for 7-24 Machine.	10	—
12591	879	Shuttle Driver Pin for 7-22 Machine.	10	—
12591	879	" Race Dowel Pin for 7-22 Mach.	10	—
12596	879	Buff Wheel Clamp Carrier Cap Pin for 7-24 Machine	03	—
14529	889	Shuttle Cylinder Latch for 19568 for 7-22 Machine.	15	—
* 19555	—	Arm.	18	50
		Nos. 19556 to 19596 for 7-22 Machine.		
* 19556	—	Bed	18	50
19557	863	Cloth Plate	1	25
19558	863	Face Plate	2	00
19559	873	Feed Bar	2	25
19560	868	" Dog	3	00
19561	—	" Lifting Rock Shaft 11871 with 19562	3	40
19562	865	Feed Lifting Rock Shaft Crank with 135d and 1861	2	00

No	Plate	Name	Each	Old No.
19563	848	Needle Bar	1 00	—
19564	869	" " Connecting Link	80	—
19565	869	" " " Stud with 129D and 4450	1 25	—
19566	865	Needle Clamp with two 207	2 50	—
19567	863	Oscillating Shaft	1 25	—
19568	866	Shuttle (cylinder), 3-in. diam. (inside), with 11910	6 00	—
19569	866	Shuttle (cylinder), 3-in. diam. (outside), with 11910	6 00	—
19570	867	Shuttle Cylinder for 19568	2 50	—
19571	867	" " " 19569	2 50	—
19572	864	" Driver with 4480	5 00	—
19573	867	" Frame for 19568	2 75	—
19574	867	" " " 19569	2 75	—
19575	864	" Race Back (inside)	1 00	—
19576	864	" " " (outside)	1 00	—
19577	864	" " " Spring	25	—
19578	864	" " Body	5 00	—
19579	—	" " complete, Nos. 19575, 19576, two each 32D, 19577 and four 11838	7 50	—
19580	866	Shuttle Tension Spring for 19568	40	—
19581	866	" " " " 19569	40	—
19582	885	Tension (wheel) complete, Nos. 850D, 1560, 8791, 8905, 11043, two 11044 and three 8879	2 00	—
19583	869	Thread Eyelet for 19596	05	—
19584	869	" " (double) for 19555	25	—
19585	869	" Retainer Bracket	1 50	—
19586	865	" " Thread Guide Pin	05	—
19587	—	" " complete, Nos. 19585, 19586, two each 1560, 2103, 8905 and four 2102	1 90	—
19588	—	Thread Take-up Lever	1 40	—
19589	864	" " " 19588 with 1518 and 1845	1 75	—
19590	865	Thread Take-up Spring Thread Guard	05	—
19591	—	Throat Plate Body	1 40	—
19592	868	" " Needle Hole Strip	60	—
19593	868	" " complete, Nos. 19591 with two 19592 and four 401D	2 50	—
19594	—	Vibrating Presser Bar	1 00	—
19595	884	" " Foot	2 50	—
19596	—	Face Plate complete, No. 18568 with 190, 910c, 11867, 11868, 11873, 11874, 11875, 19582, 19583, 19590 and two each 164D and 8800	6 25	—
		Nos. 19597 to 19647 for 7-24 Machine.		
* 19597	—	Bed	18 50	—
19598	—	" Extension with 19638	6 00	—

No.	Plate	Name	Each	Old No.
19599	876	Buff Wheel Clamp Carrier with 19614	1 50	—
19600	878	" " " " Cap	50	—
19601	876	" " " " Locking Rack with 19614	3 00	—
19602	876	Buff Wheel Clamp Carrier Locking Rack Hinge Bracket with two 4530	1 50	—
19603	878	Buff Wheel Clamp Carrier Locking Rack Hinge Bracket Hinge Pin	25	—
19604	—	Buff Wheel Clamp Carrier Rack Latch, Nos. 19605 to 19608	1 35	—
19605	877	Buff Wheel Clamp Carrier Rack Latch Bracket with 4530	75	—
19606	880	Buff Wheel Clamp Carrier Rack Latch Pin	30	—
19607	880	Buff Wheel Clamp Carrier Rack Latch Pin Head	25	—
19608	879	Buff Wheel Clamp Carrier Rack Latch Spring	05	—
19609	881	Buff Wheel Clamp Carrier Sliding Flange with 4530	75	—
19610	880	Buff Wheel Clamp Carrier Sliding Flange Shaft	15	—
19611	880	Buff Wheel Clamp Carrier Sliding Flange Gear with 4620	75	—
19611	880	Buff Wheel Clamp Spindle Gear with 4620	75	—
19612	876	Buff Wheel Clamp Carrier Sliding Rack with 19613	2 00	—
19613	—	Buff Wheel Clamp Carrier Sliding Rack Spring Hook for 19612	05	—
19614	—	Buff Wheel Clamp Carrier Sliding Rack Spring Hook for 19601	05	—
19614	—	Buff Wheel Clamp Carrier Weight Connection Hook for 19599	05	—
19615	880	Buff Wheel Clamp Carrier Stop Dog	30	—
19616	878	" " " " " Plate	25	—
19617	878	" " " " " Weight (3 lbs.) with 19624 and 19625	30	—
19618	878	Buff Wheel Clamp Carrier, Weight (4 lbs.) with 19624 and 19625	35	—
19619	—	Buff Wheel Clamp Carrier Weight Connection (belt) with 19621	10	—
19620	879	Buff Wheel Clamp Carrier Weight Connection Guide Pin for 19641	03	—
19621	—	Buff Wheel Clamp Carrier Weight Connection Hook for 19619	02	—
19622	881	Buff Wheel Clamp Carrier Weight Connection Pulley	35	—
19623	880	Buff Wheel Clamp Carrier Weight Connection Pulley Bracket	30	—

PLATE 827—ONE-HALF SIZE

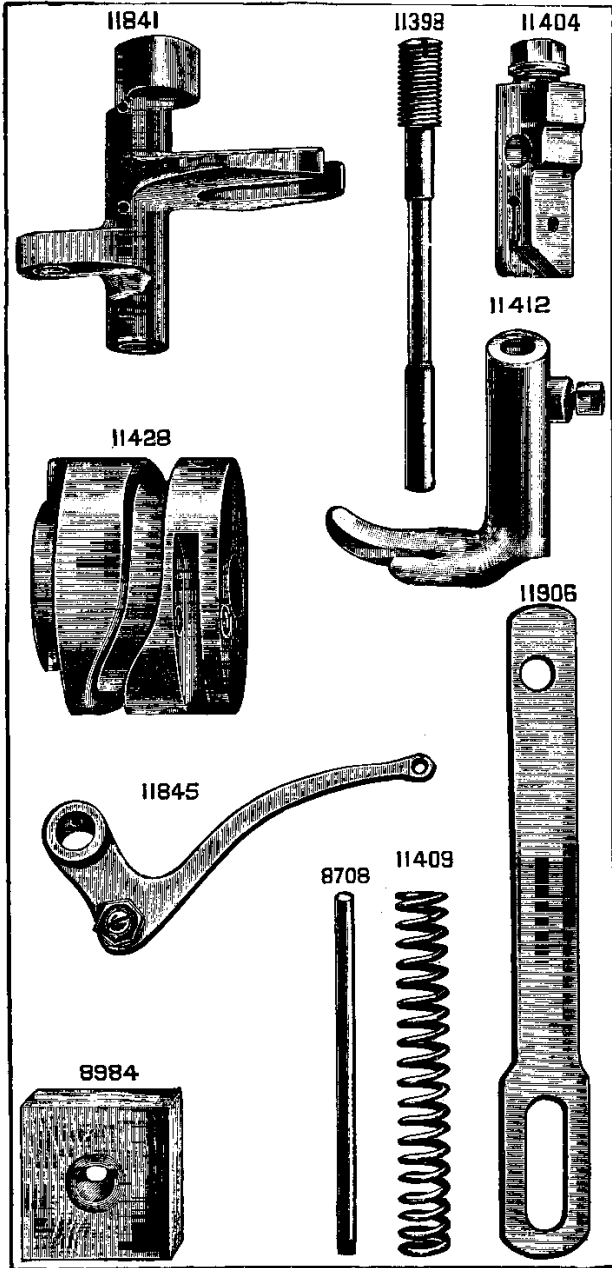

PLATE 828—ONE-HALF SIZE

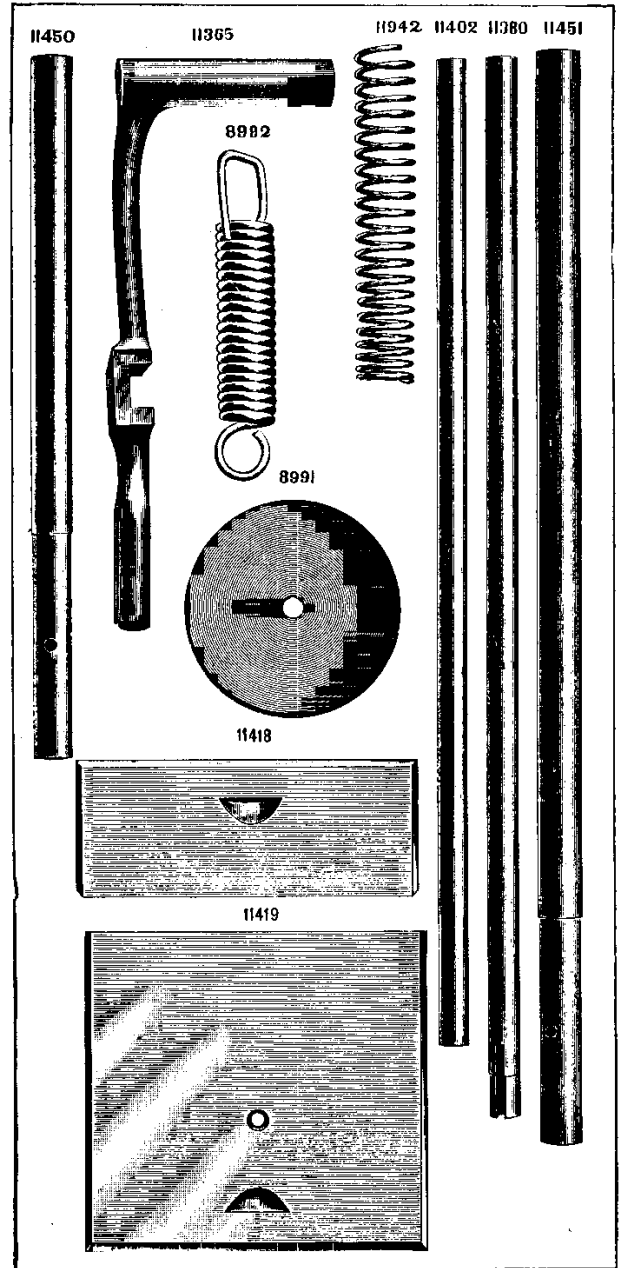

PLATE 830—ONE-HALF SIZE

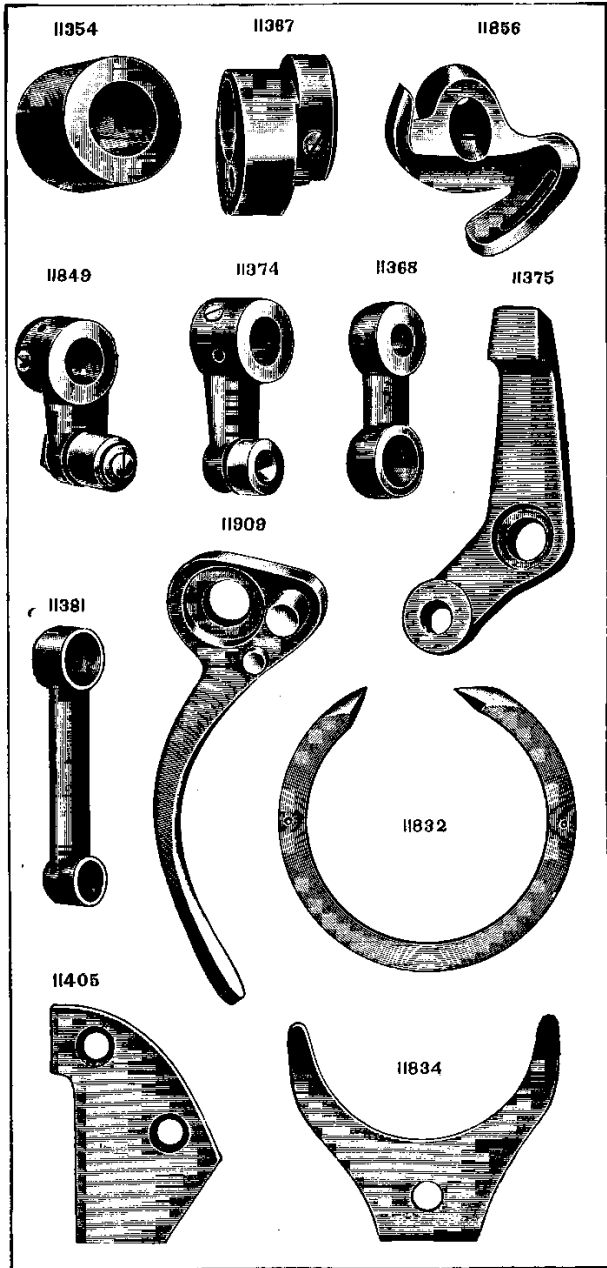

PLATE 833—FULL SIZE

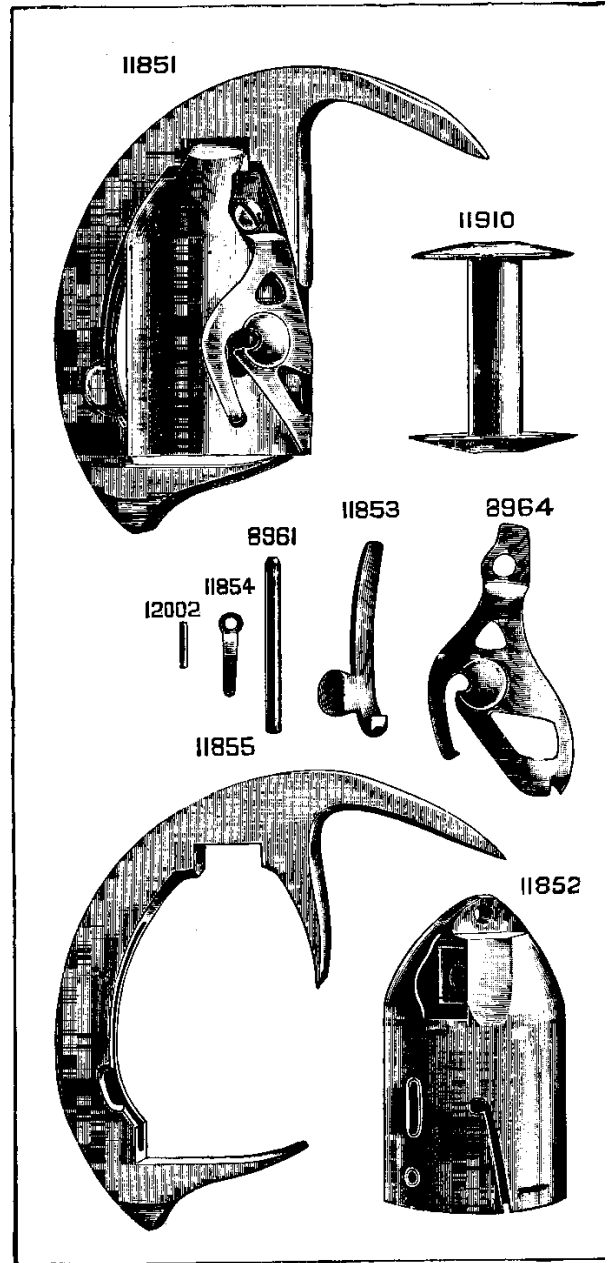

PLATE 838—ONE-FOURTH SIZE

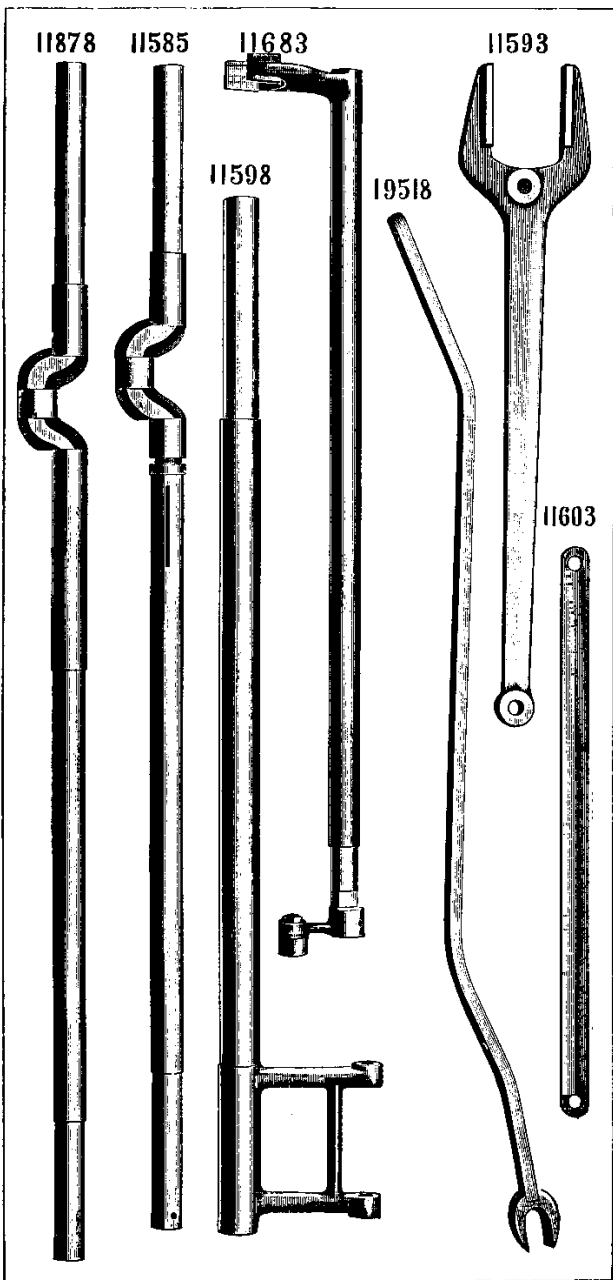

PLATE 848—ONE-HALF SIZE

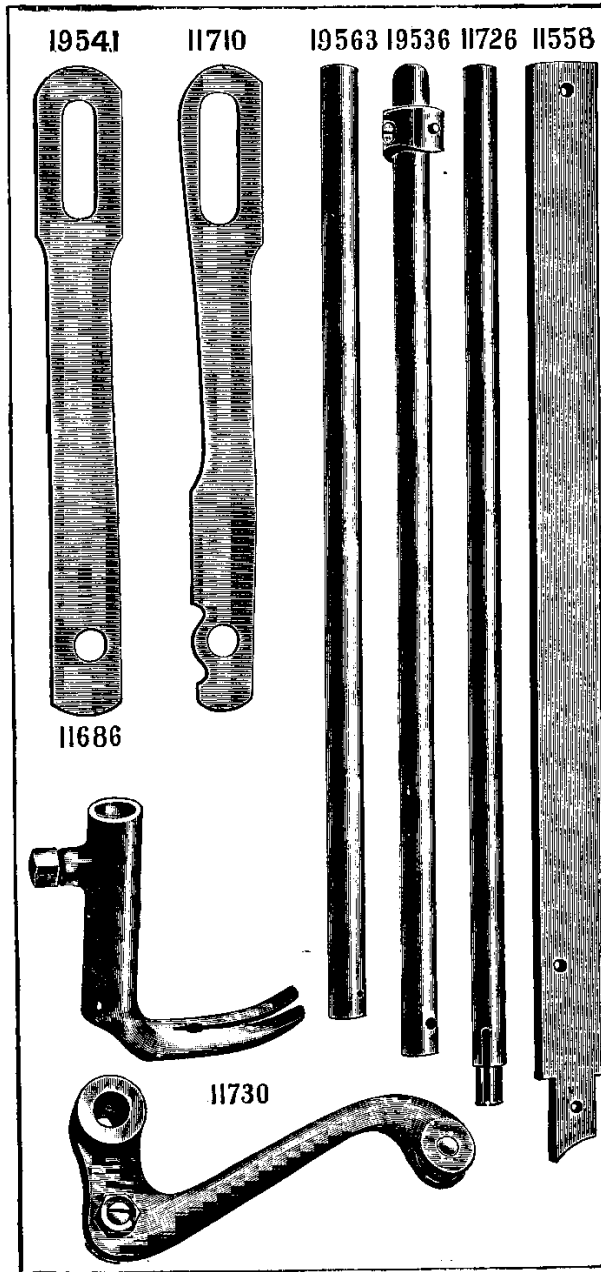

PLATE 853—FULL SIZE

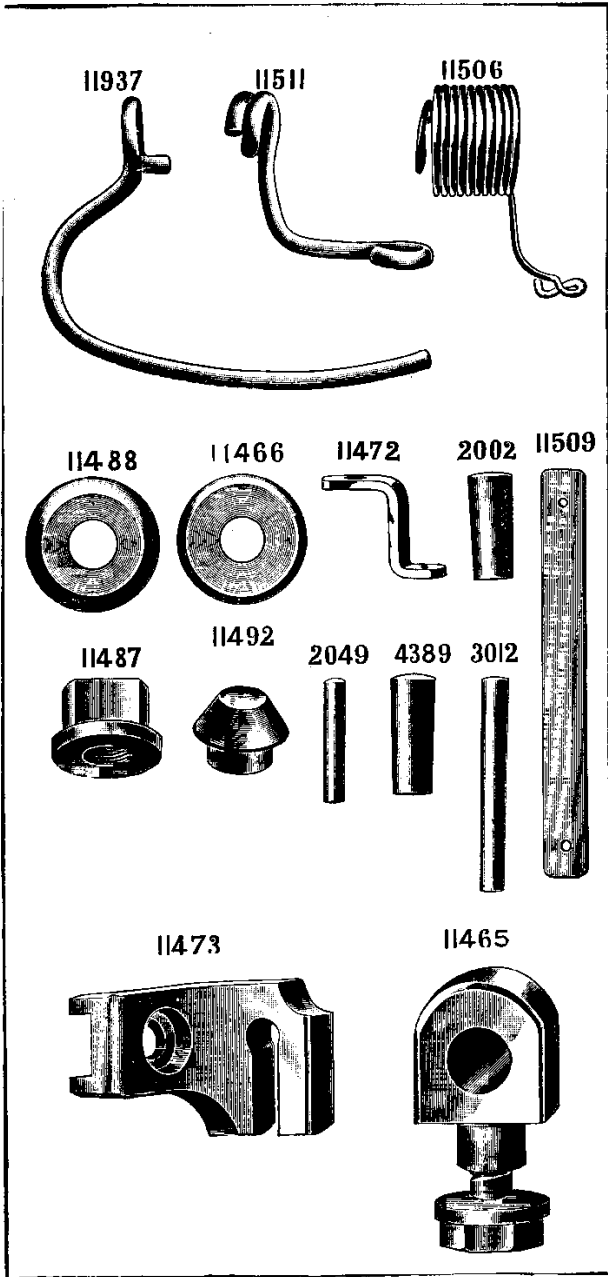

PLATE 855—ONE-FOURTH SIZE

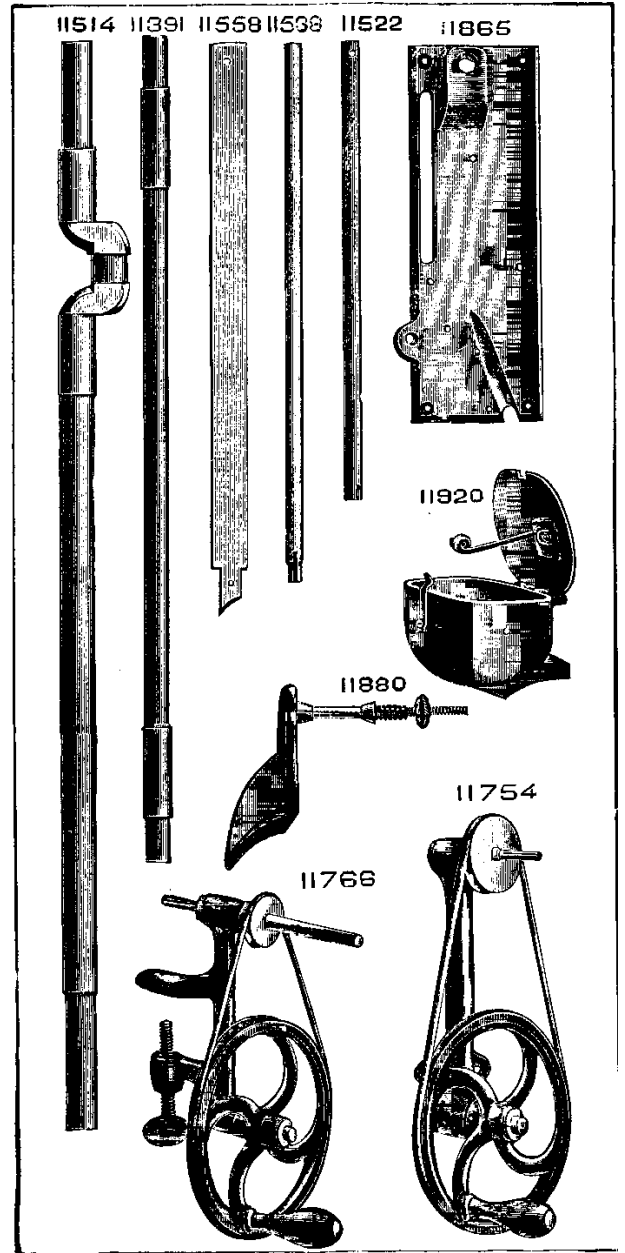

PLATE 856—ONE-HALF SIZE

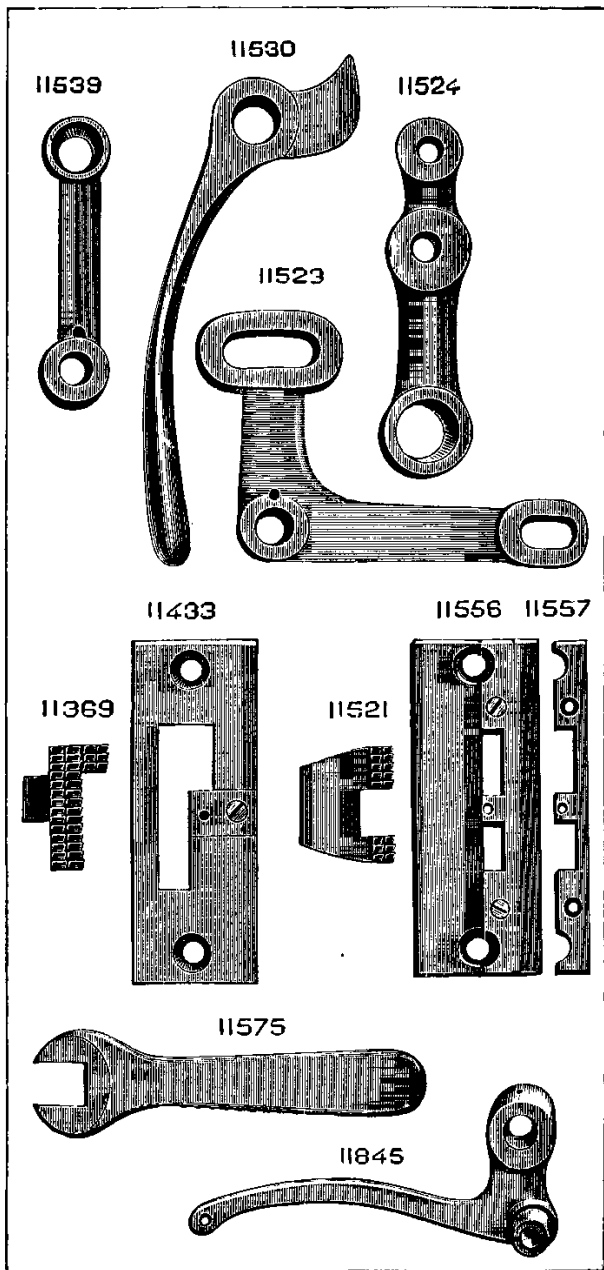

PLATE 857—ONE-HALF SIZE

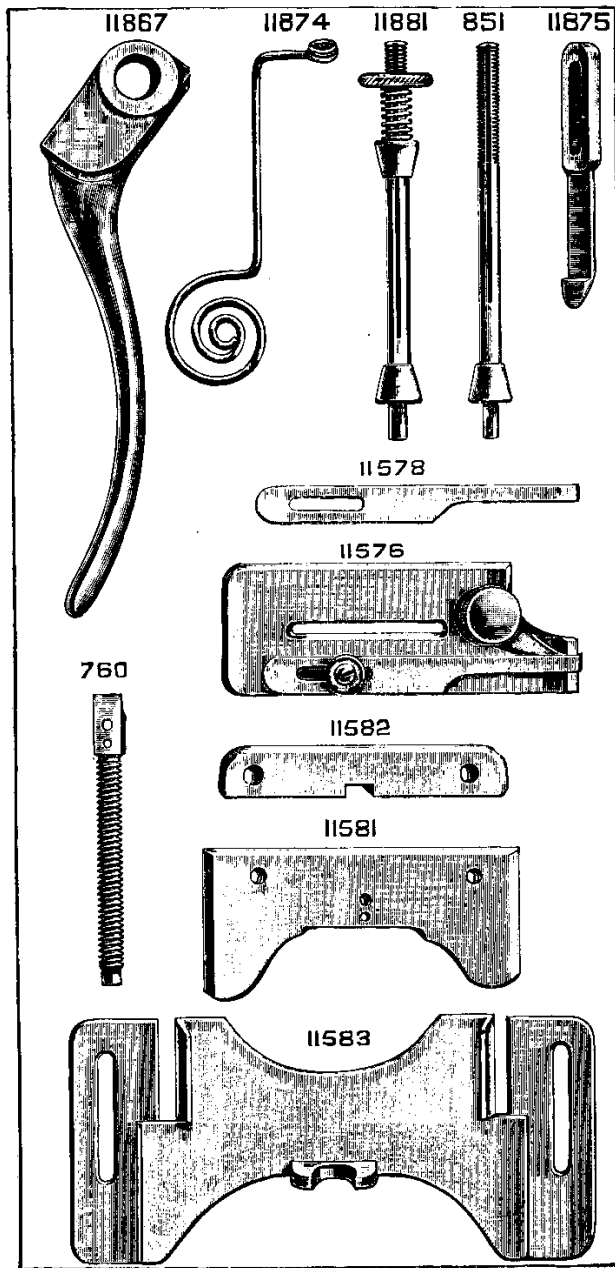

PLATE 858—ONE-HALF SIZE

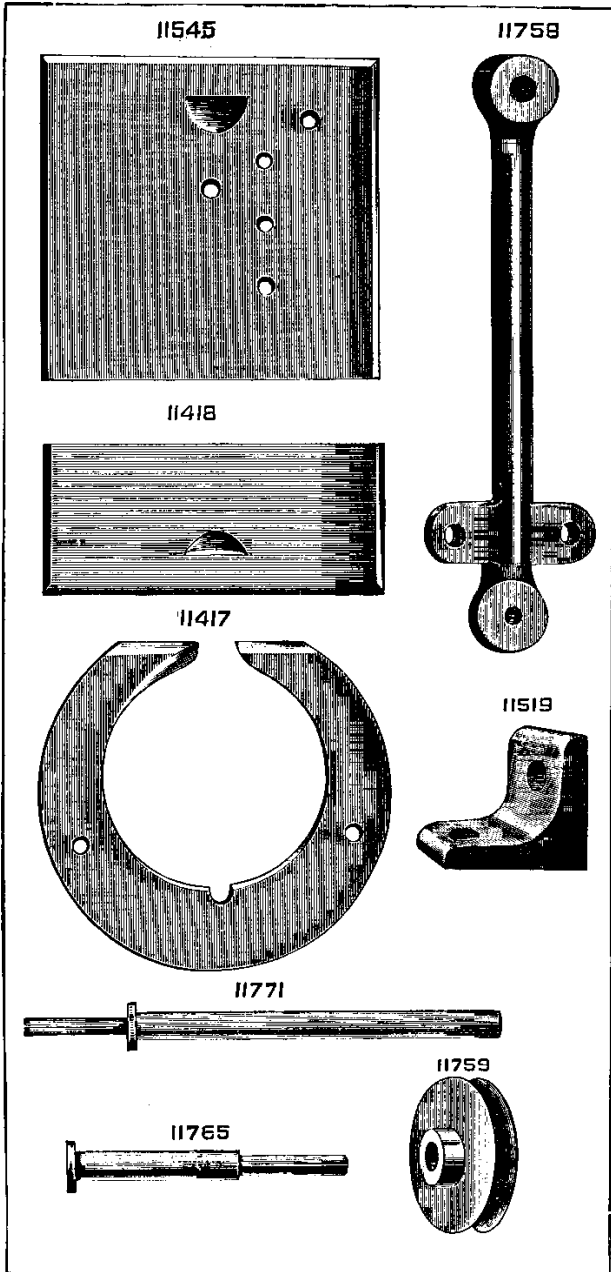

PLATE 859—ONE-HALF SIZE

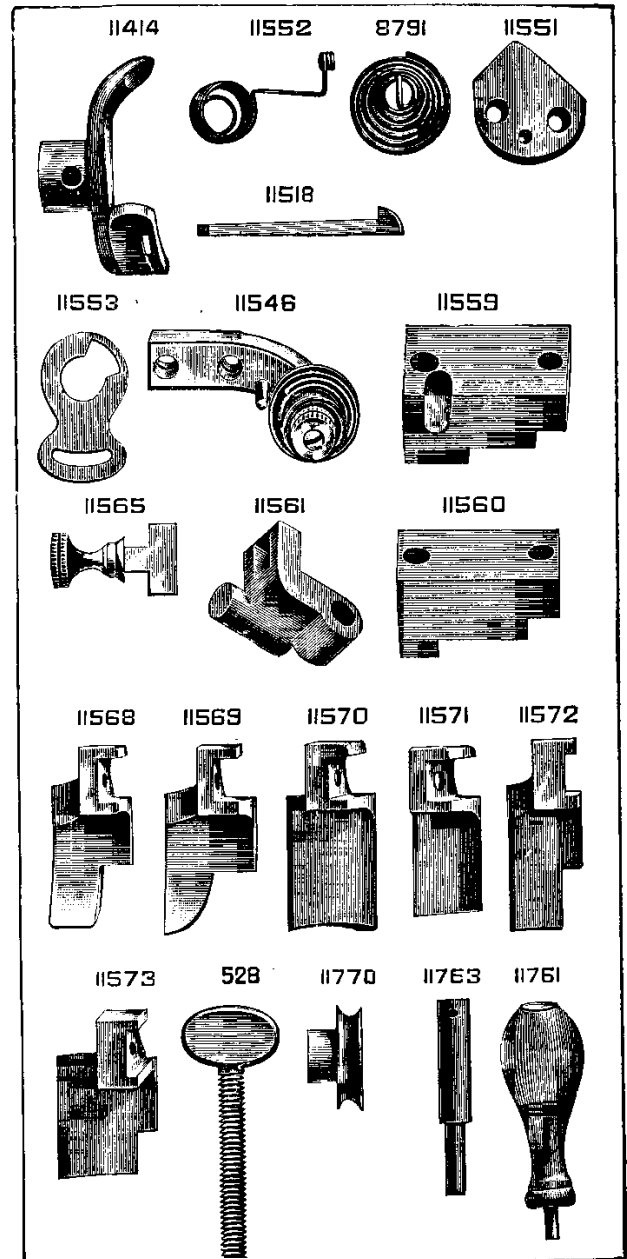

PLATE 860—FULL SIZE

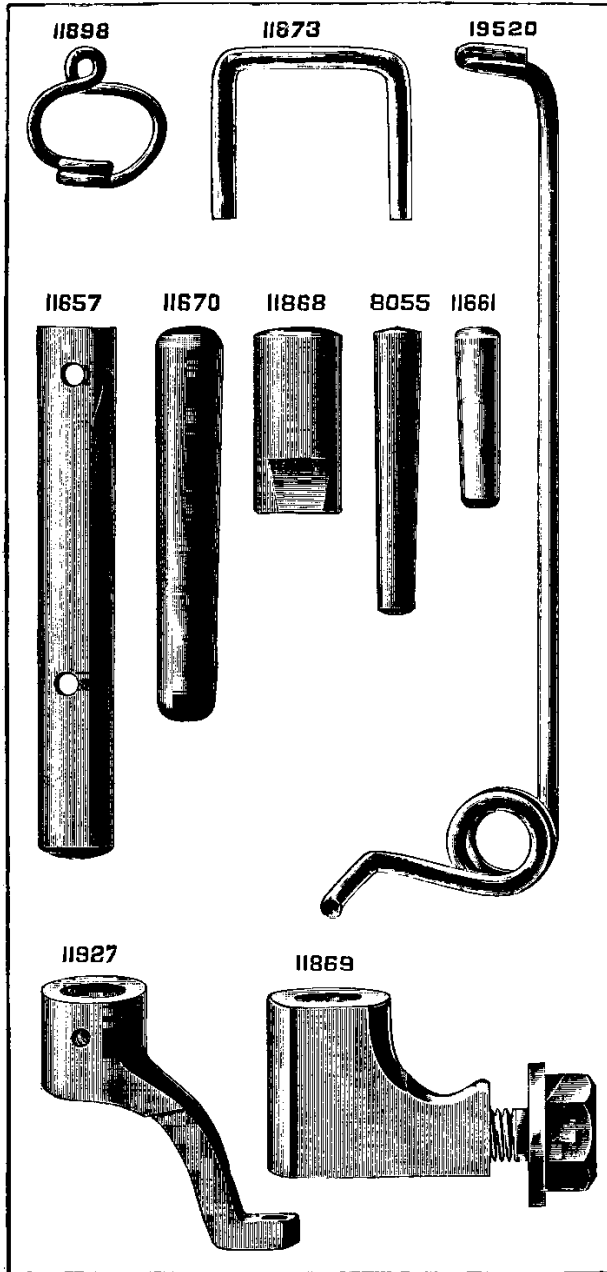

PLATE 861—FULL SIZE

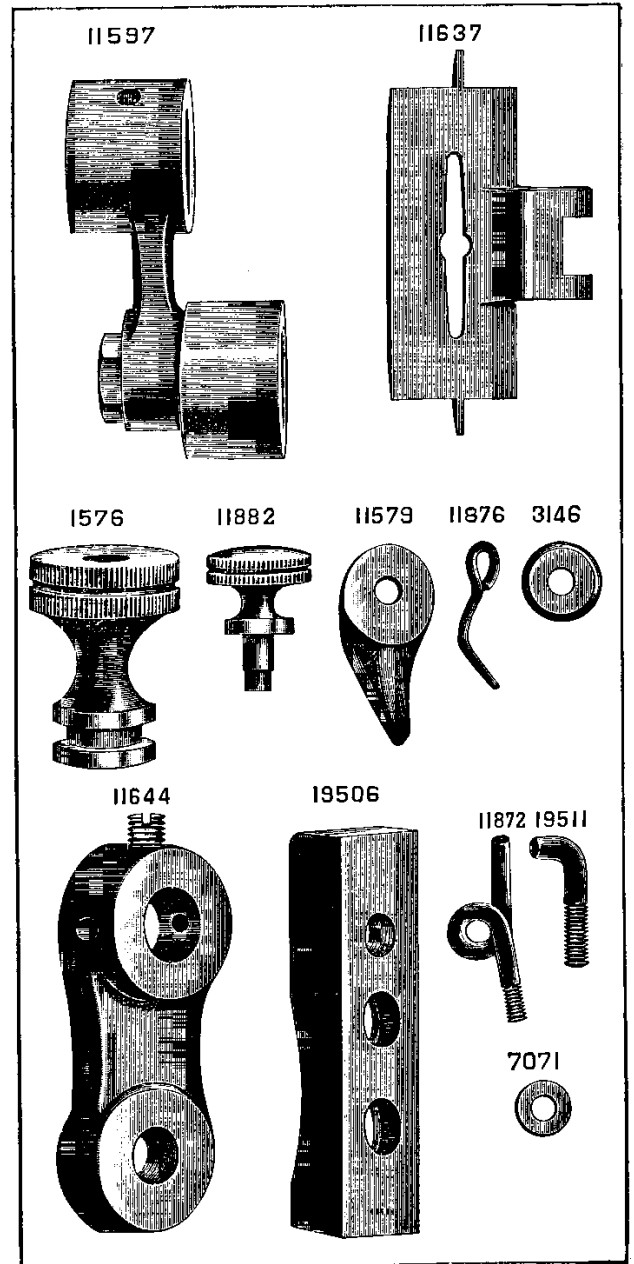

PLATE 862—FULL SIZE

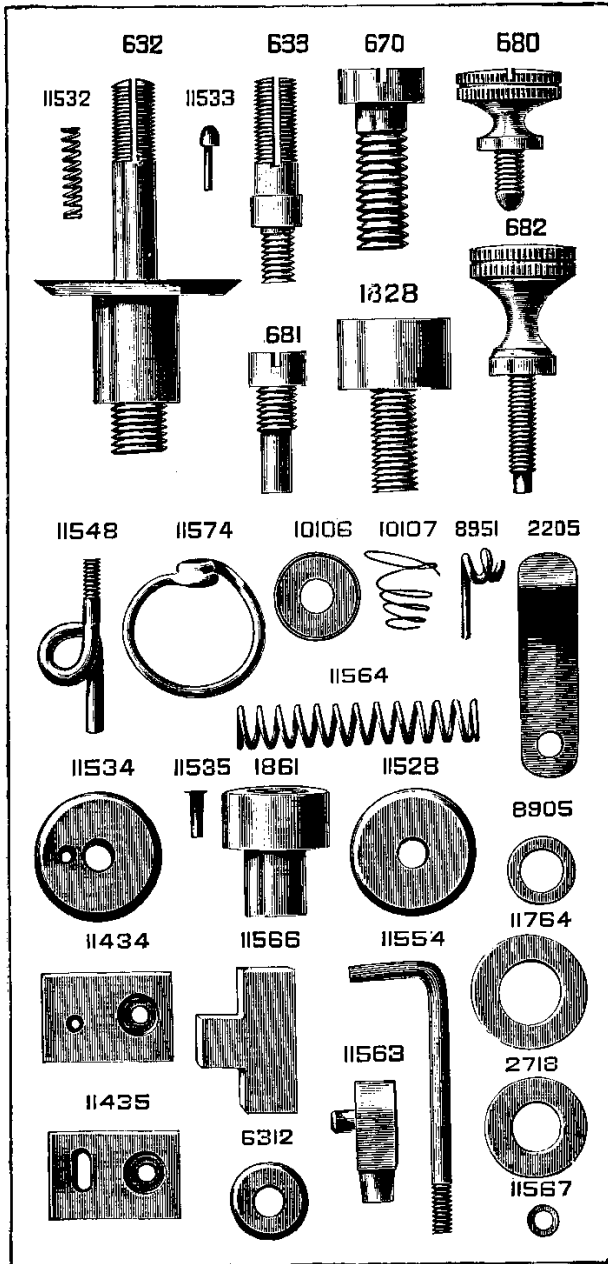

PLATE 863—ONE-FOURTH SIZE

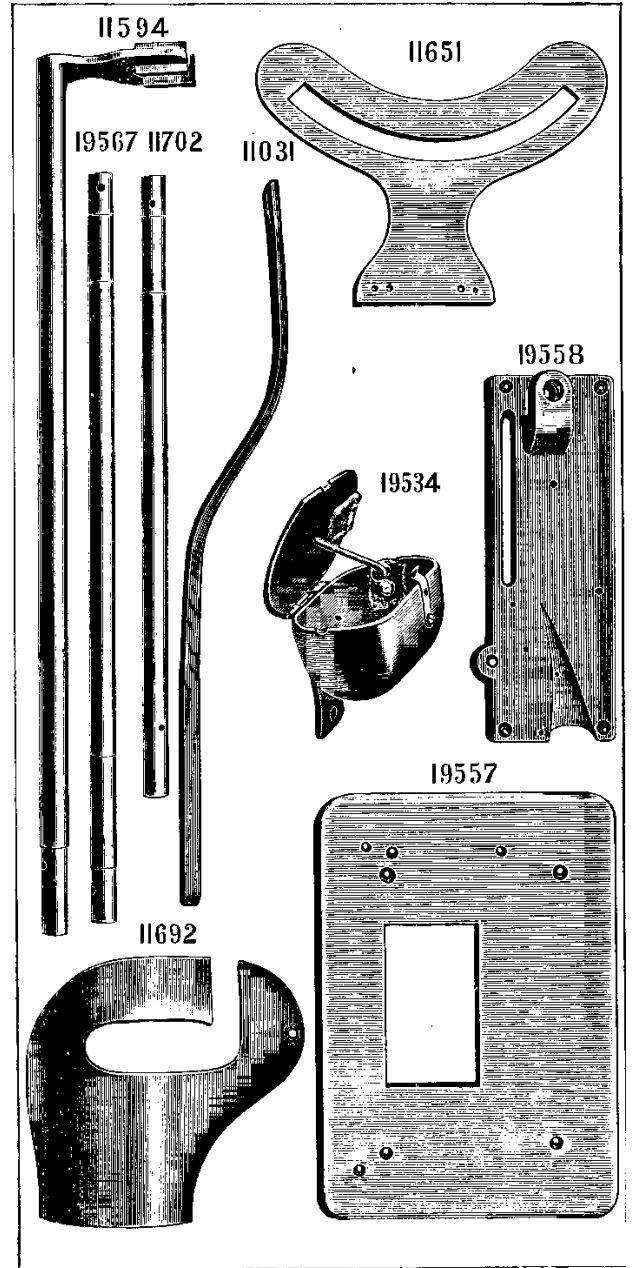

PLATE 864—ONE-HALF SIZE

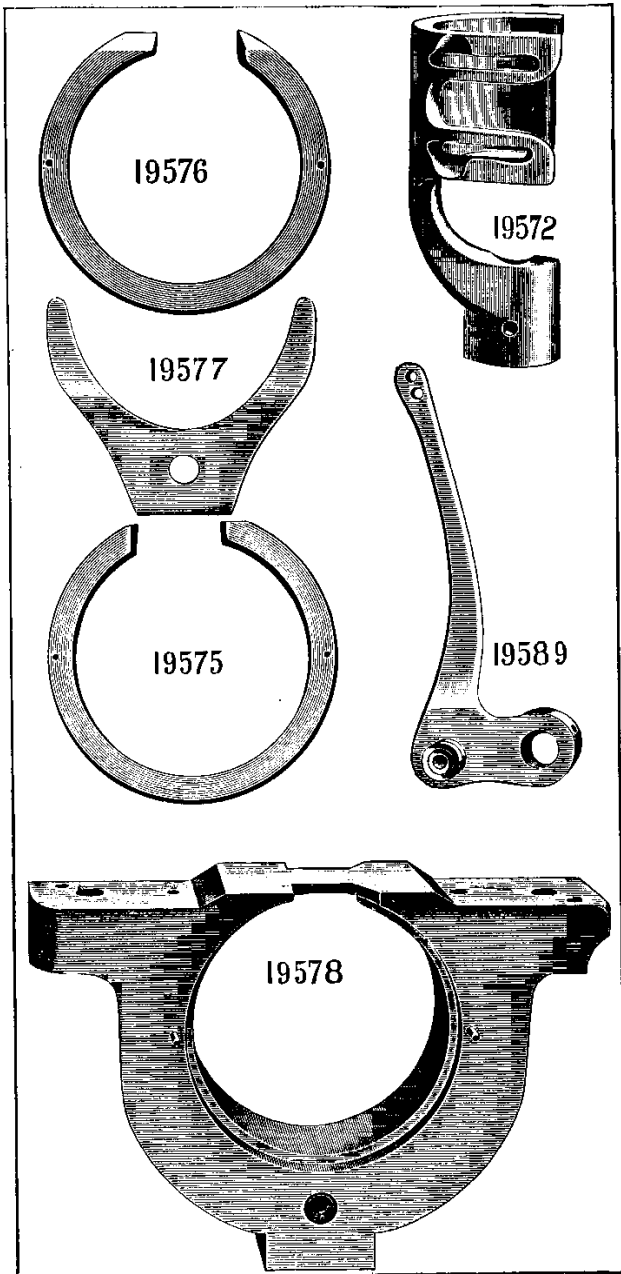

PLATE 865—FULL SIZE

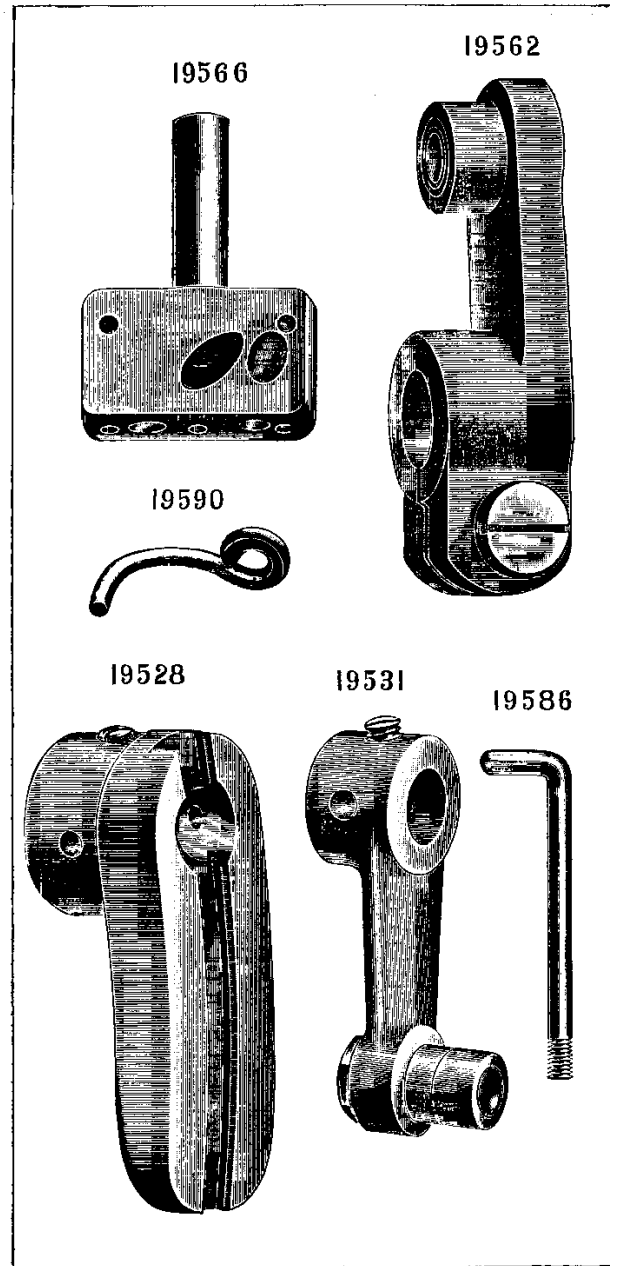

PLATE 866—FULL SIZE

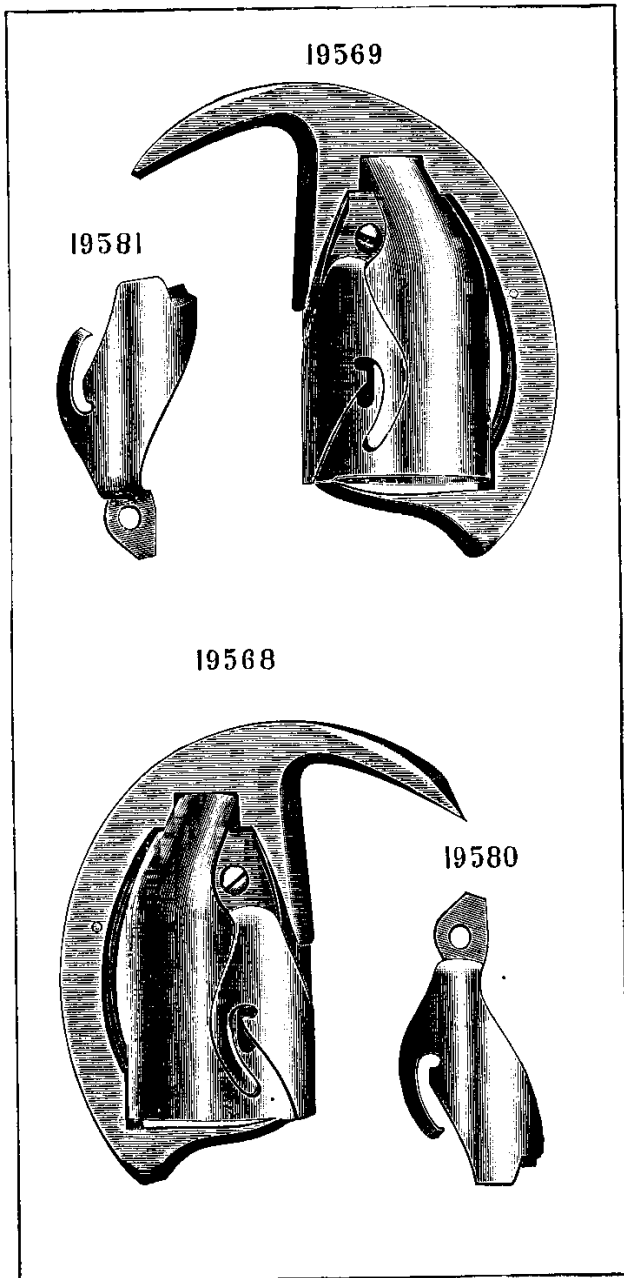

PLATE 867—FULL SIZE

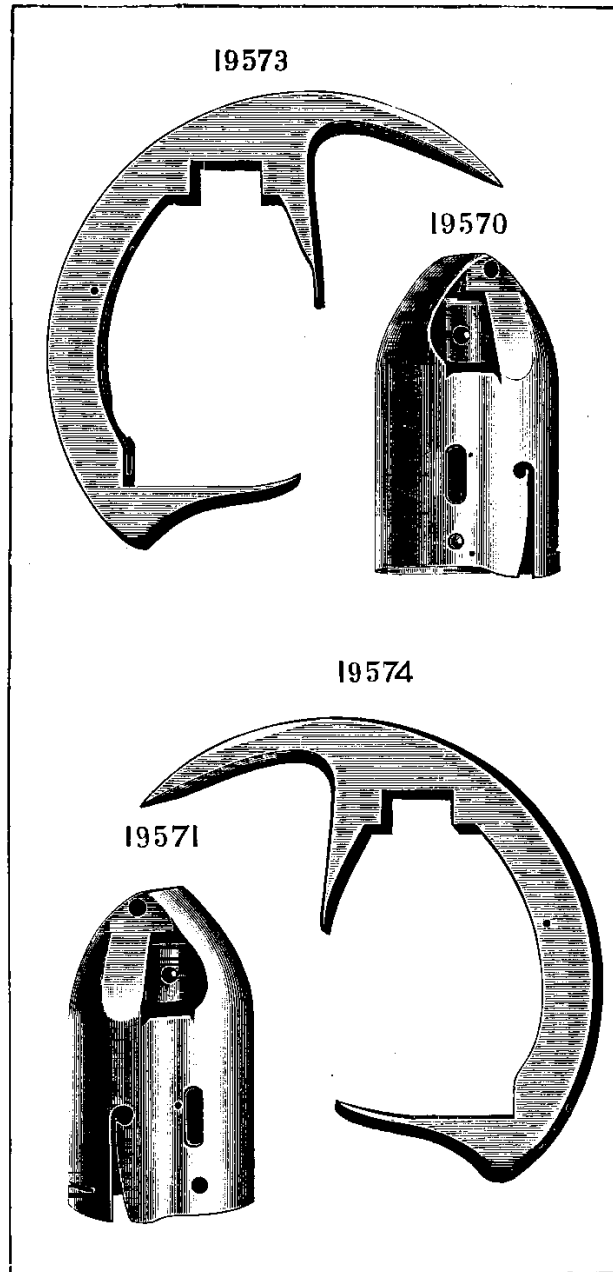

PLATE 874—FULL SIZE

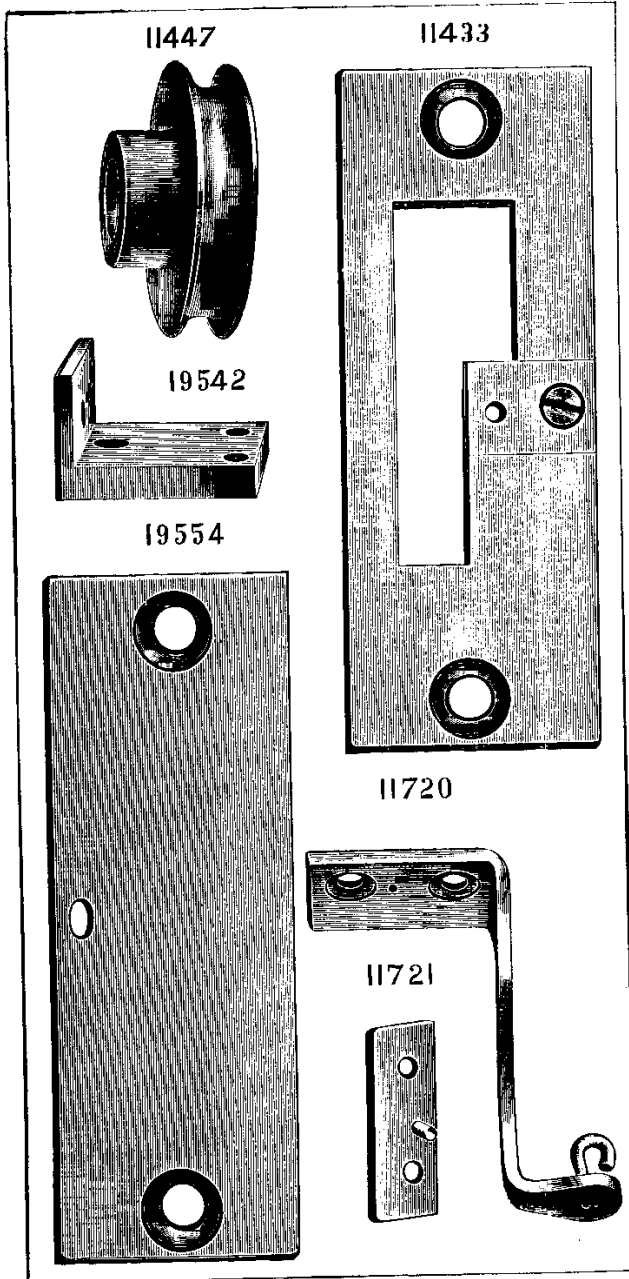

PLATE 876—ONE-HALF SIZE

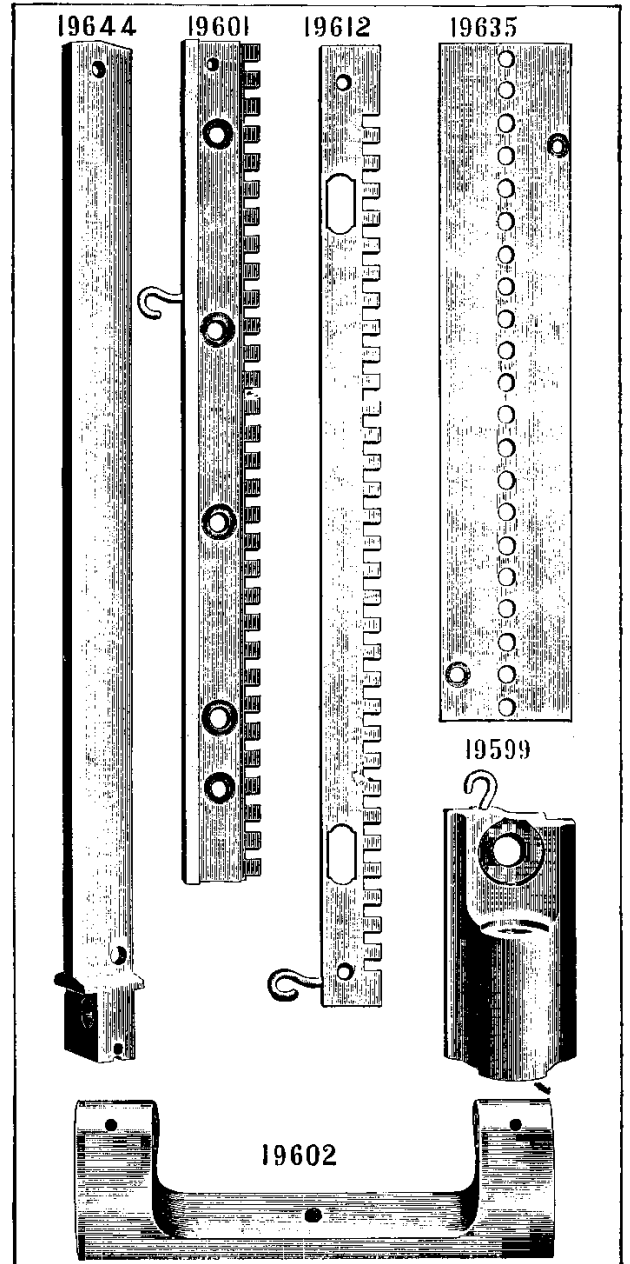

PLATE 877—ONE-HALF SIZE

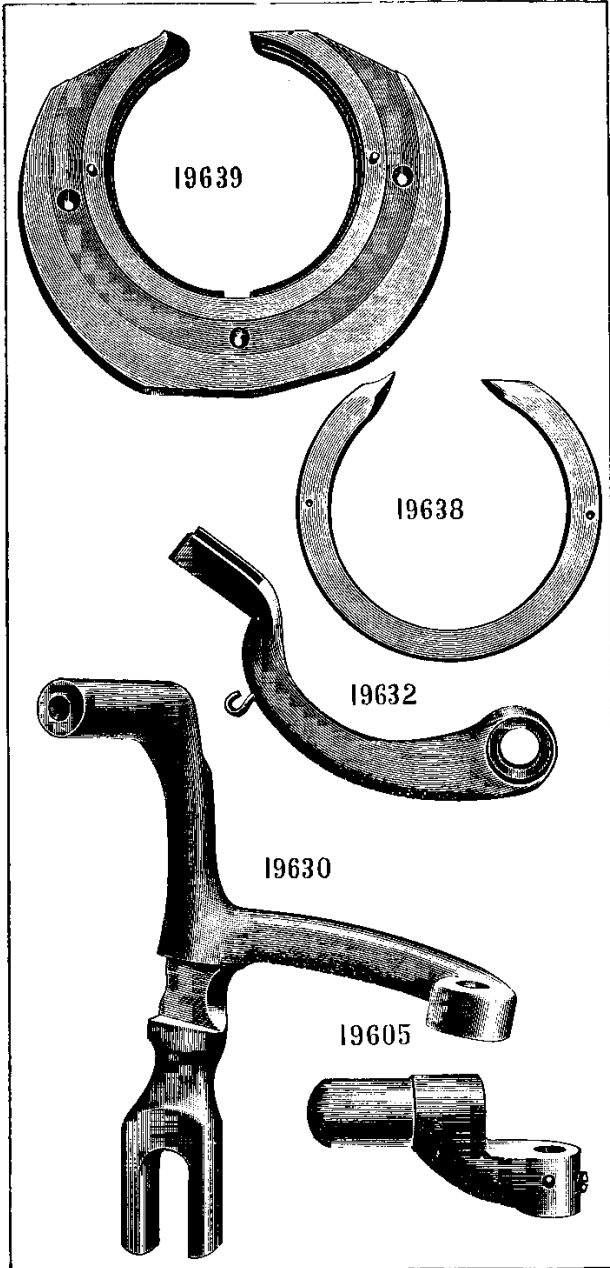

PLATE 879—FULL SIZE

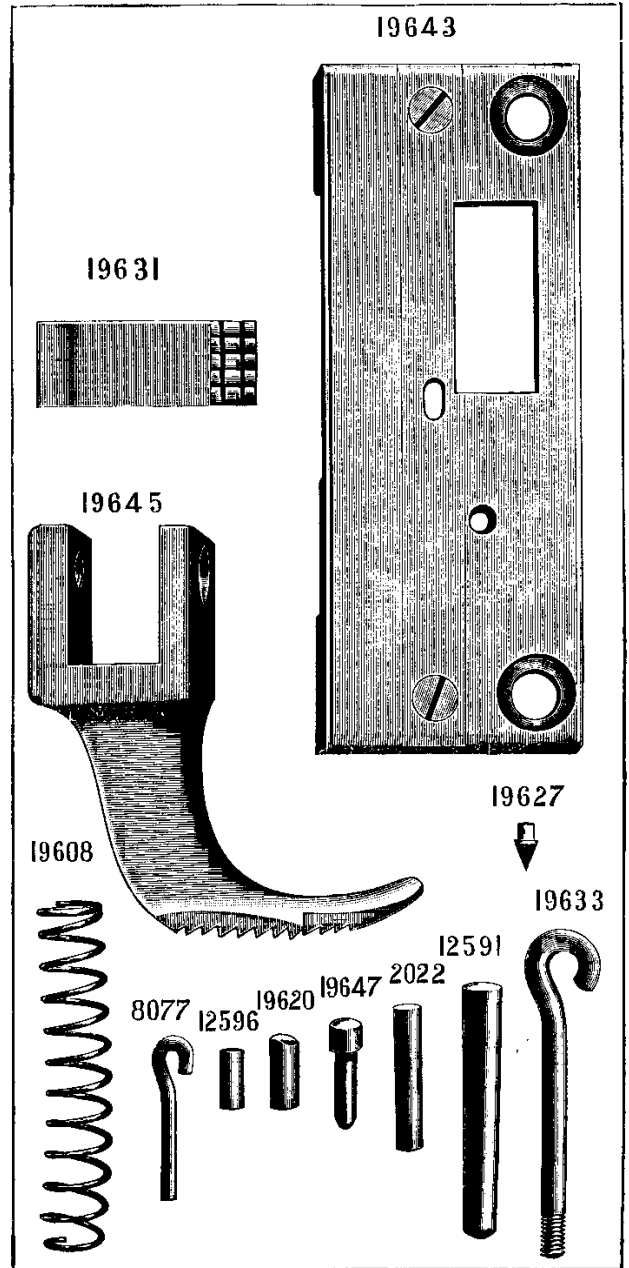

PLATE 880—FULL SIZE

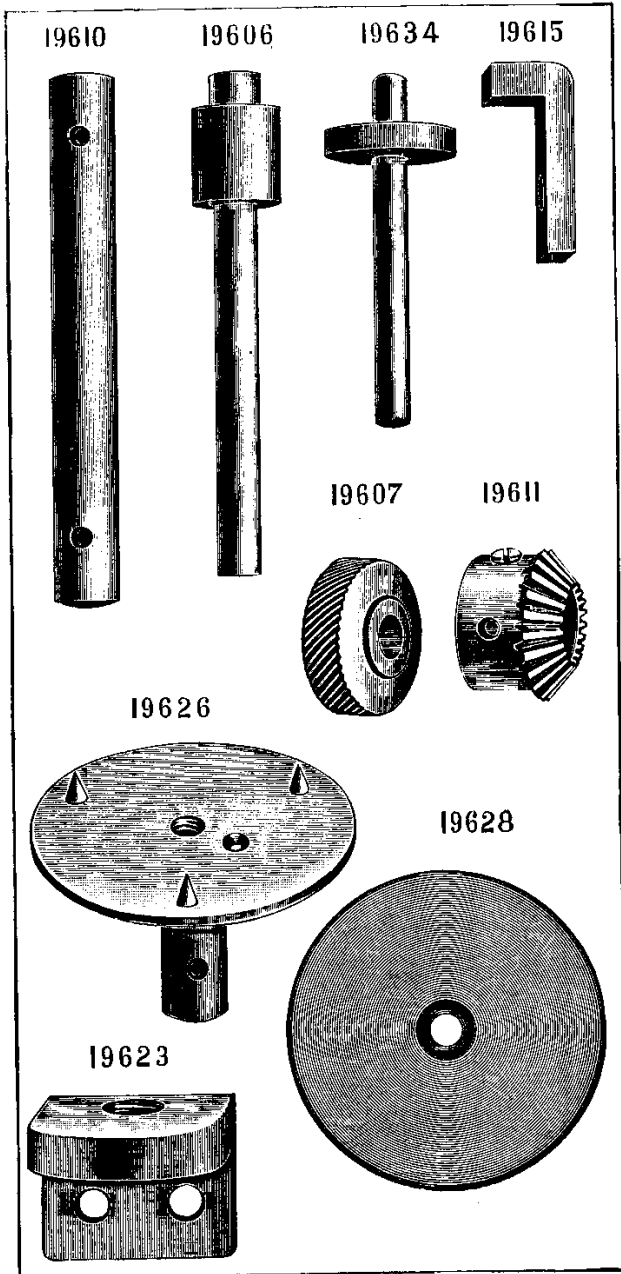

PLATE 881—FULL SIZE

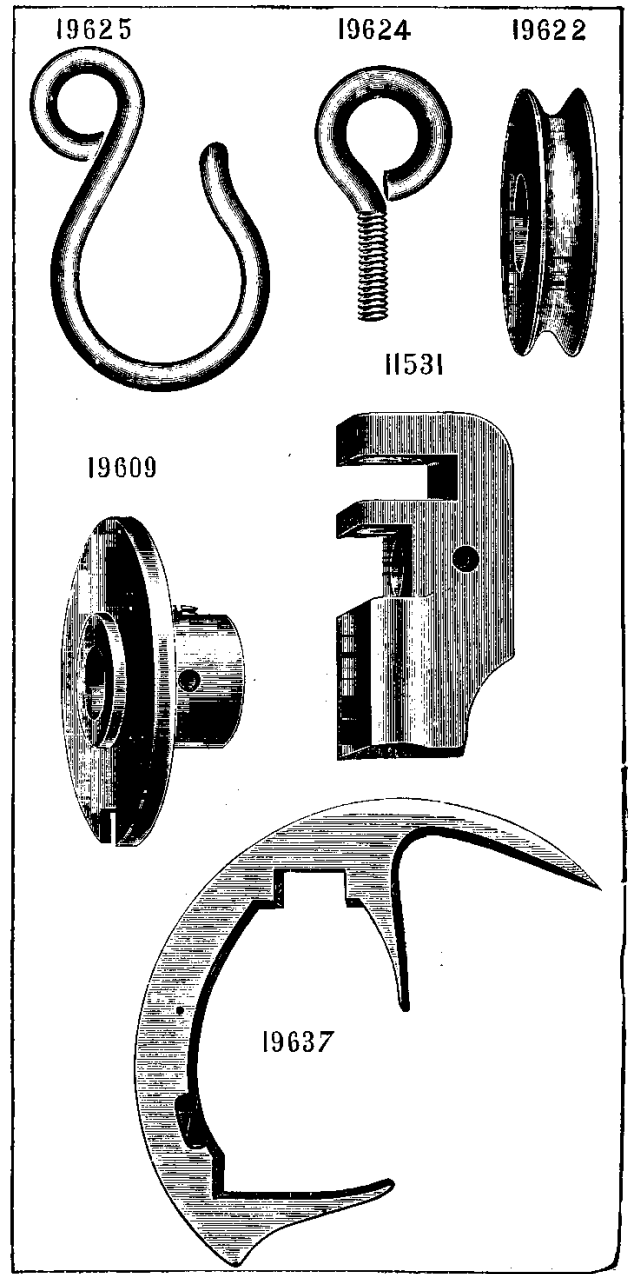

PLATE 885—FULL SIZE

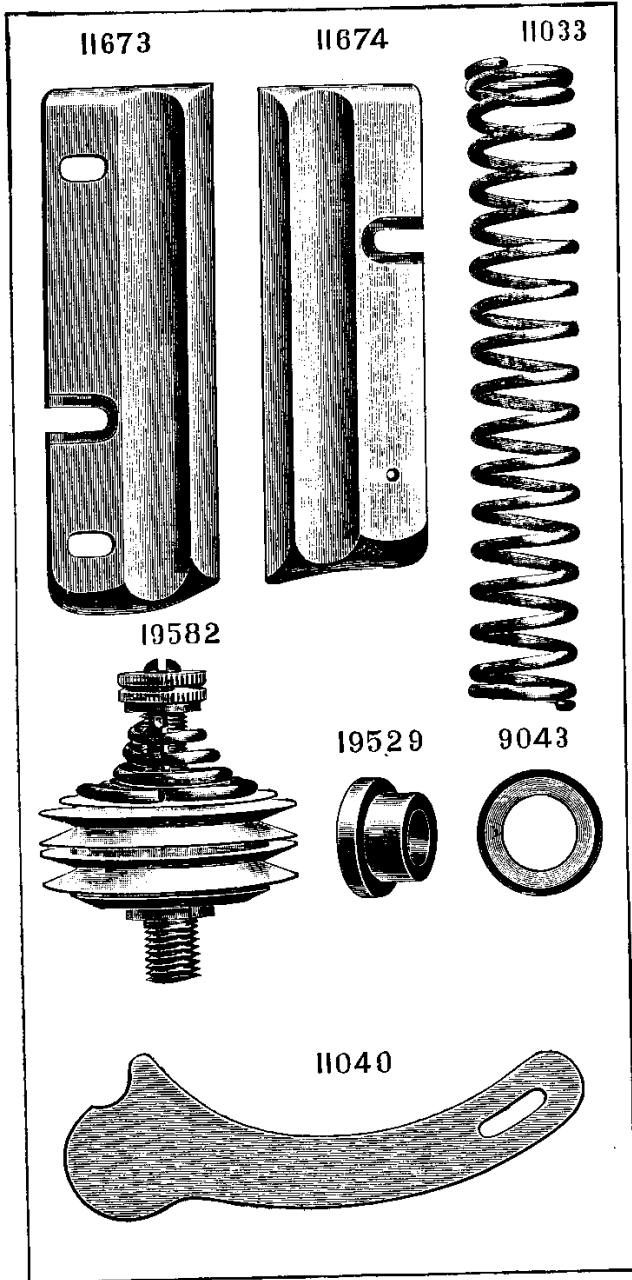

PLATE 886—FULL SIZE

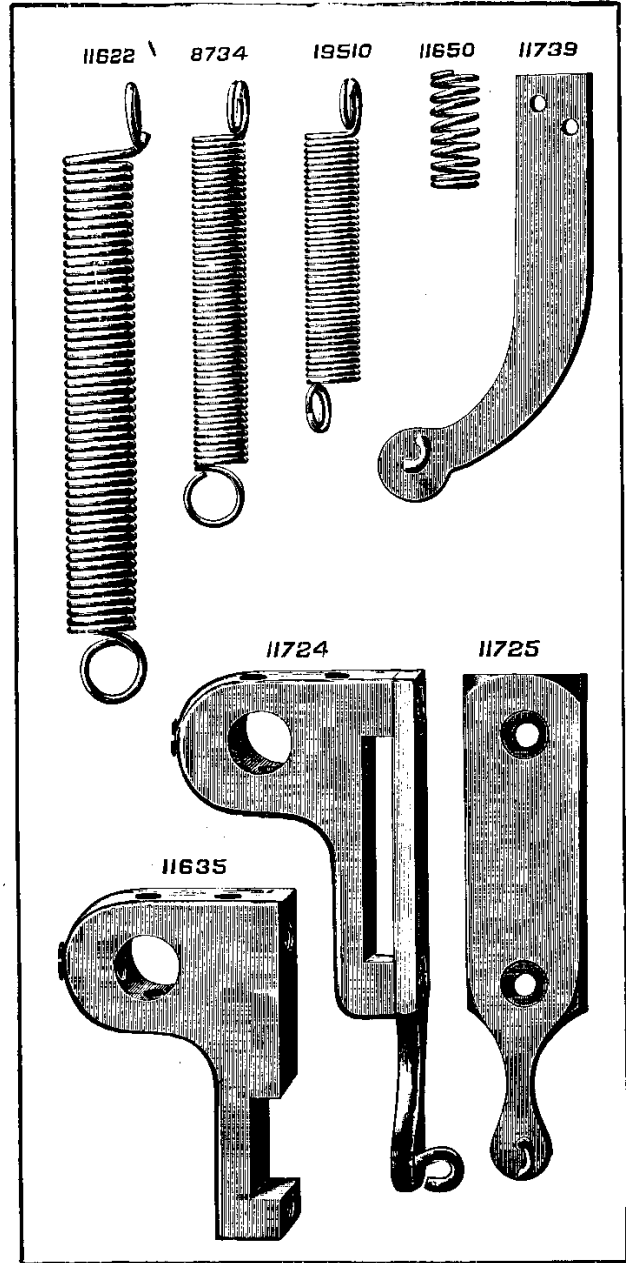

PLATE 889—FULL SIZE

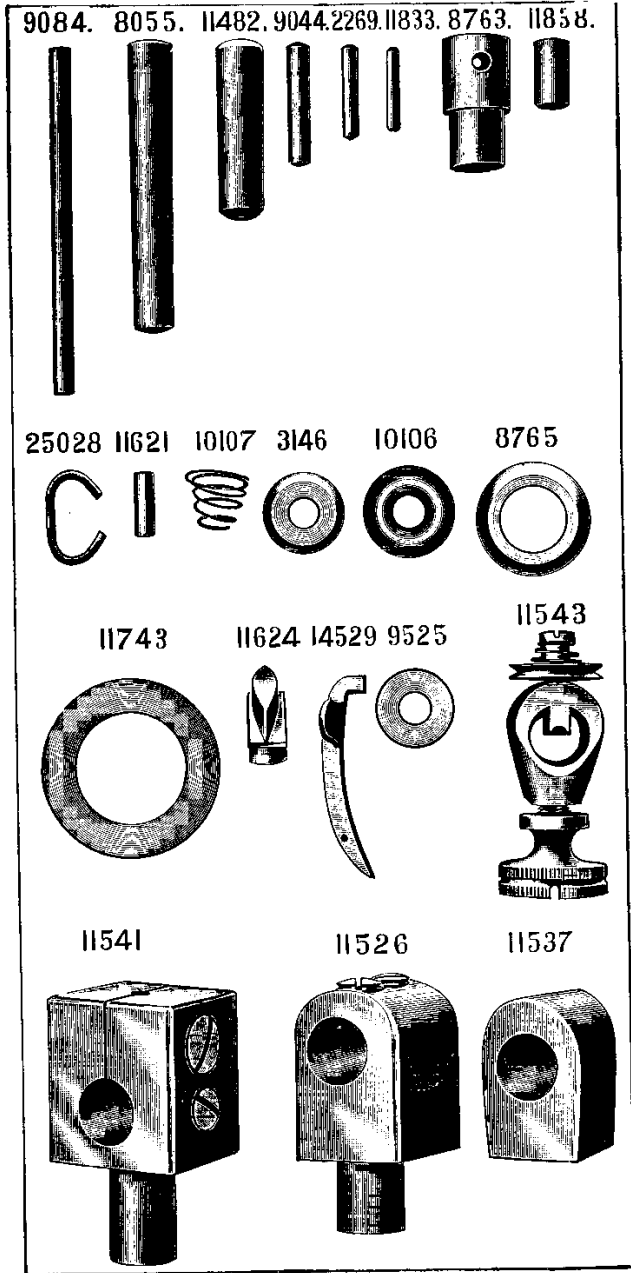

PLATE 890—FULL SIZE

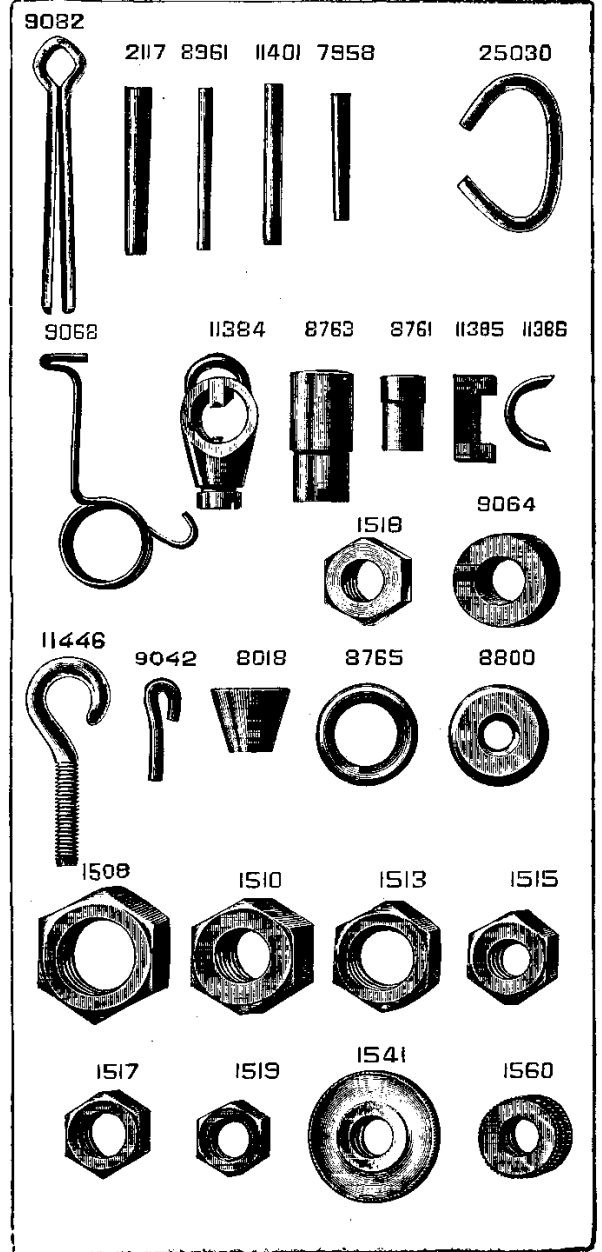

PLATE 892—ONE-HALF SIZE

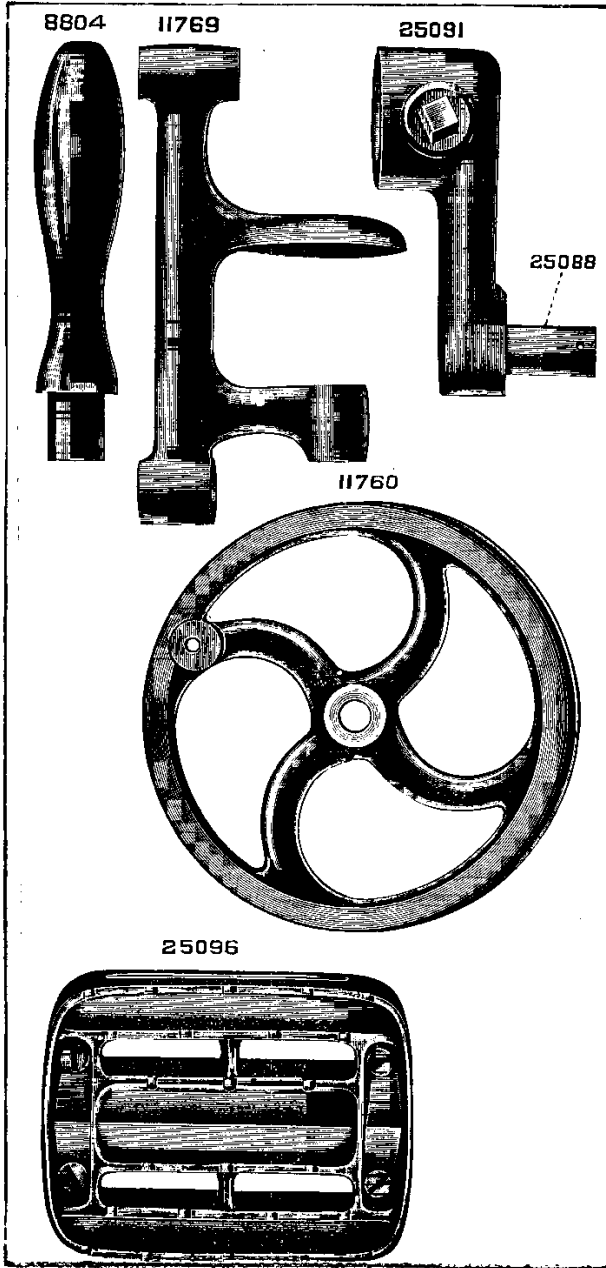

PLATE 893—FULL SIZE

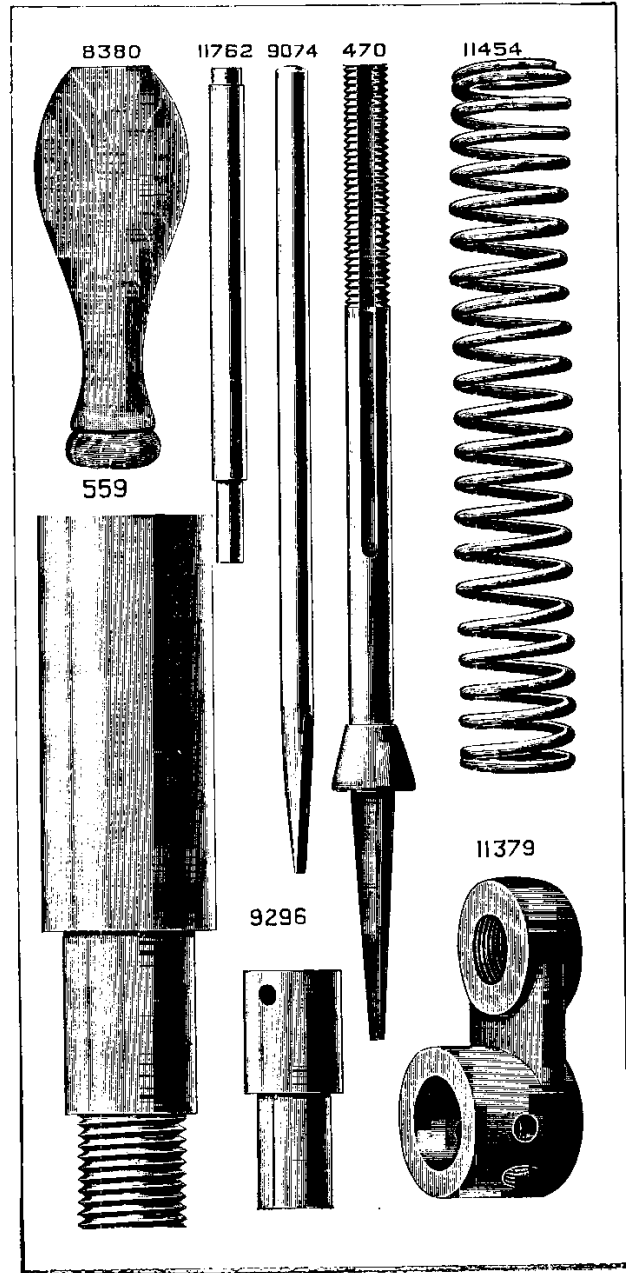

PLATE 894—ONE-HALF SIZE

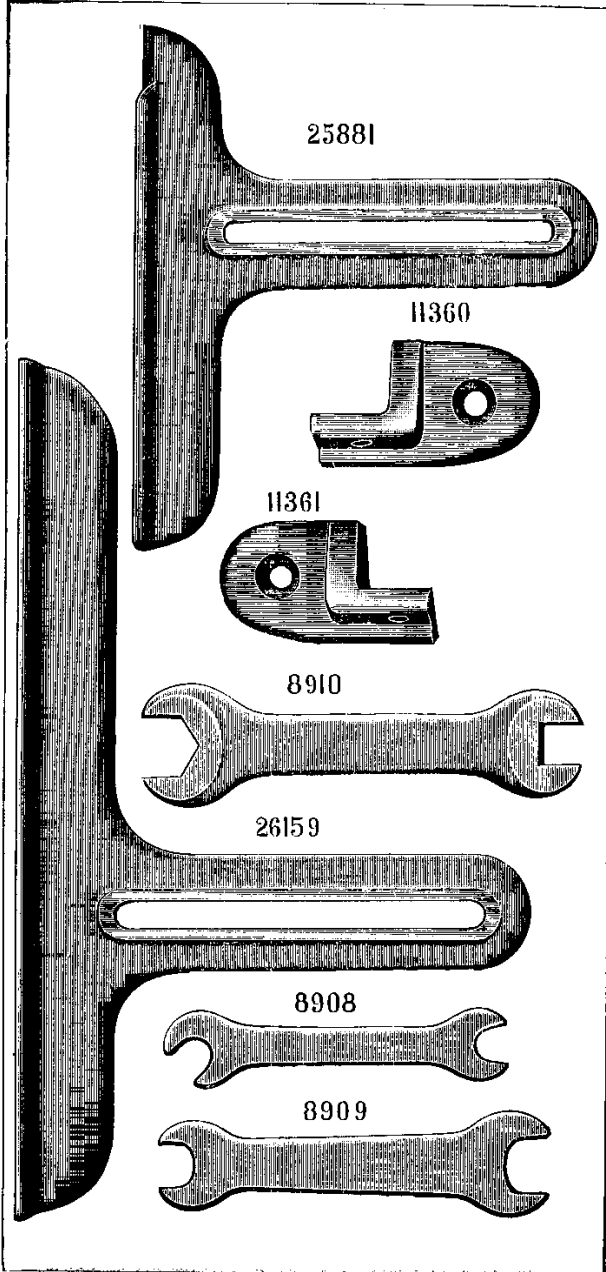

PLATE 895—ONE-HALF SIZE

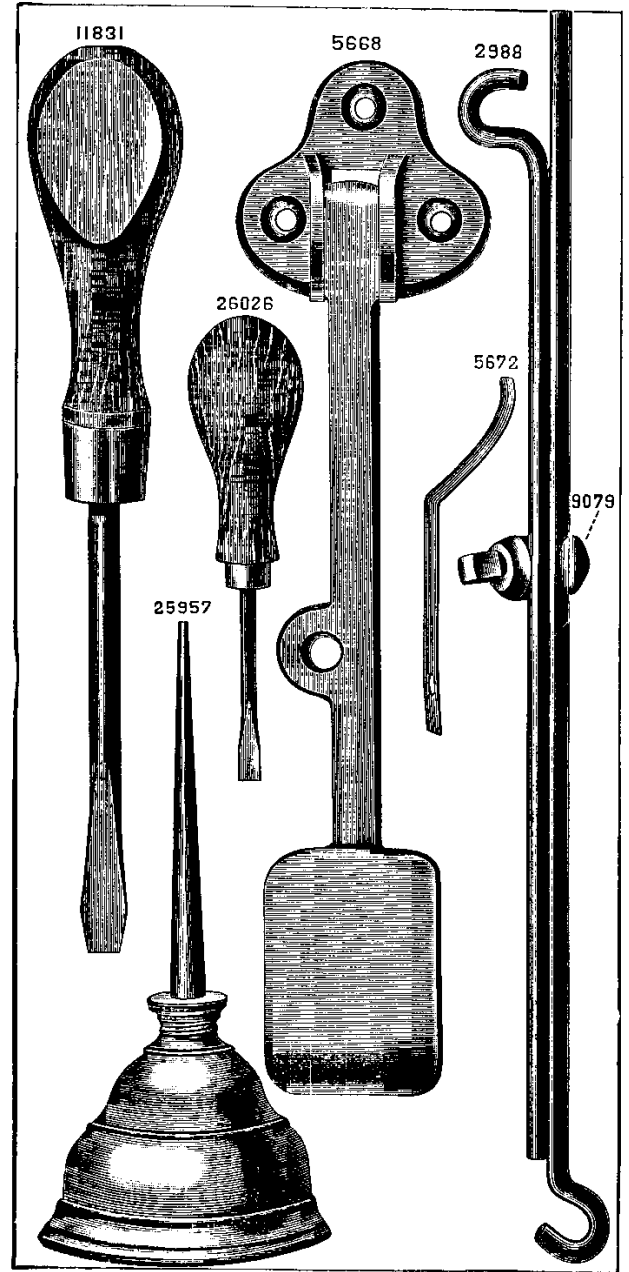

PLATE 896—ONE-EIGHTH SIZE

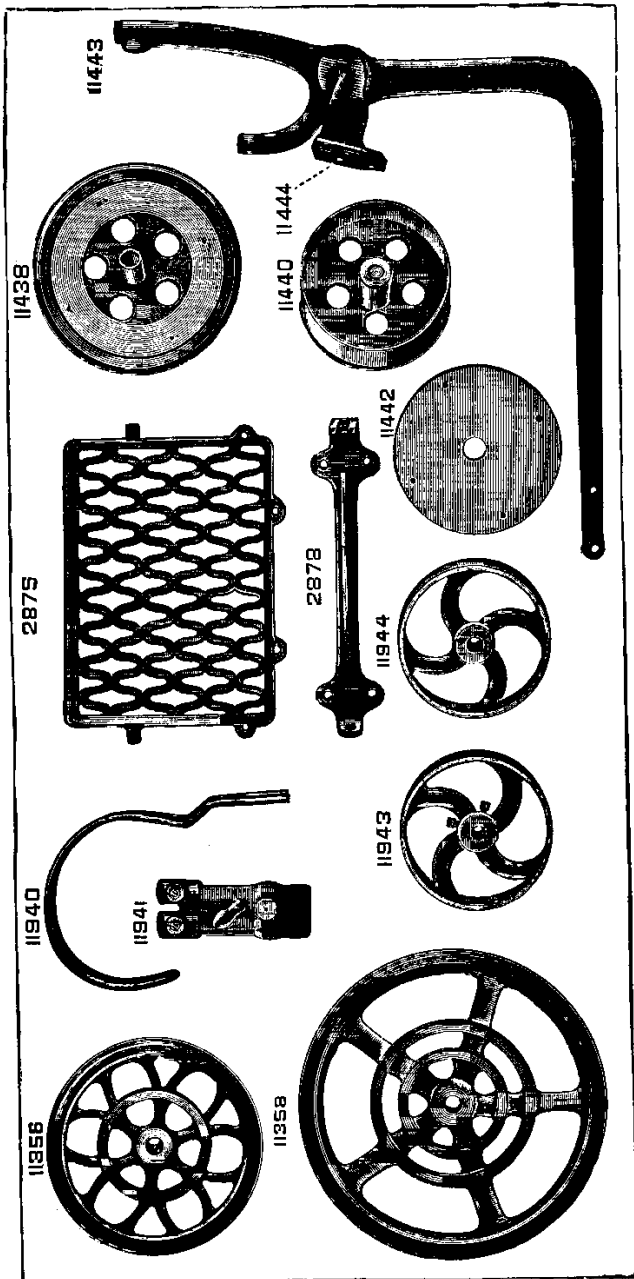

PLATE 897—FULL SIZE

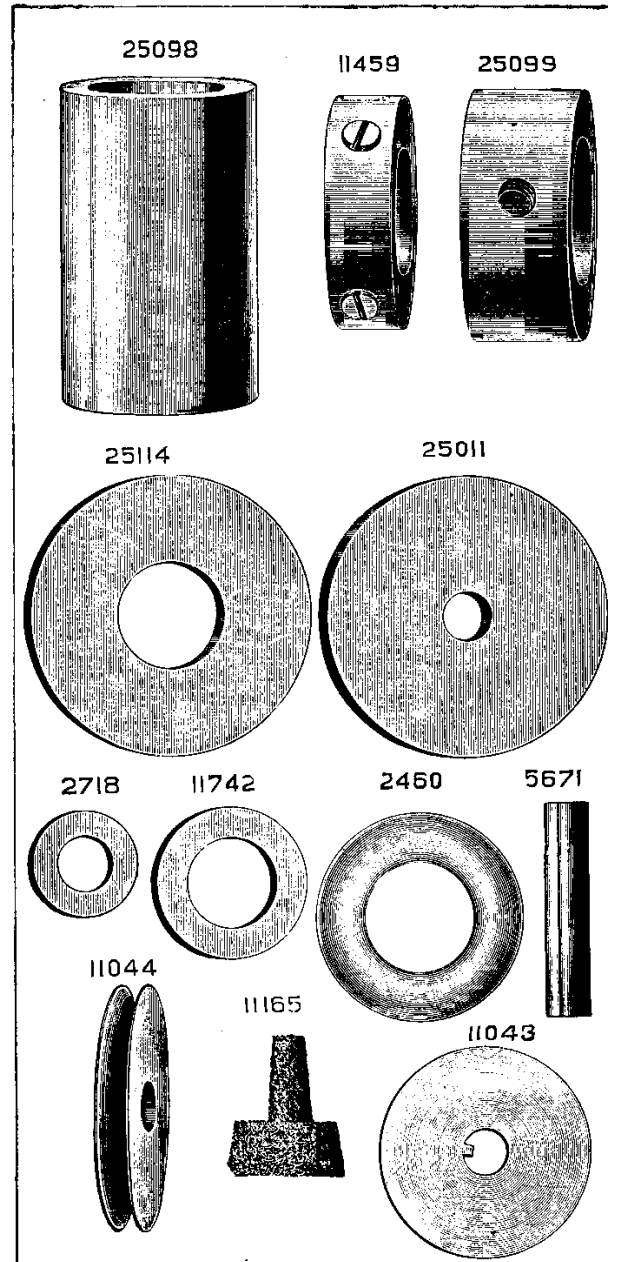

PLATE 898—FULL SIZE

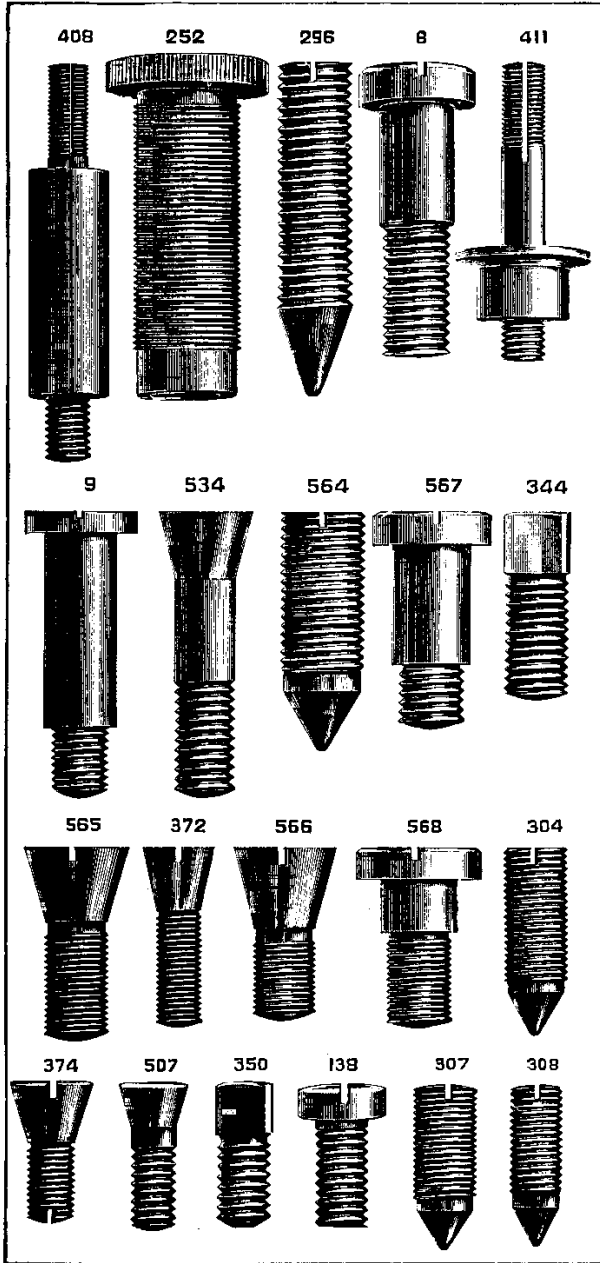

PLATE 899—FULL SIZE

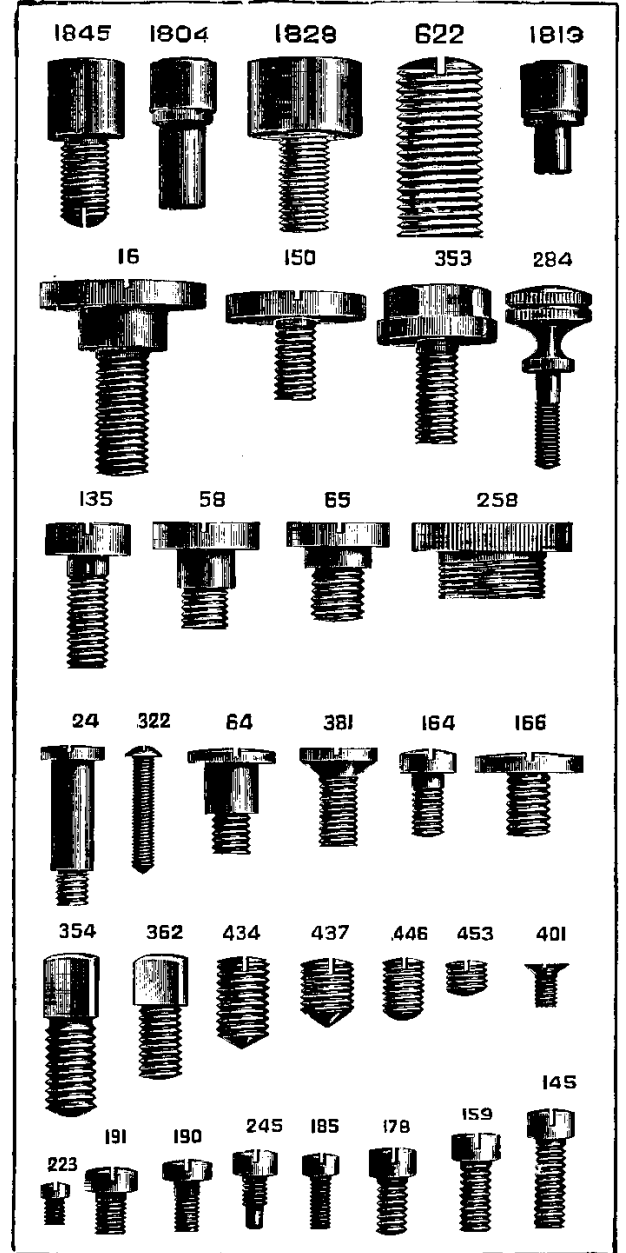

PLATE 900—FULL SIZE

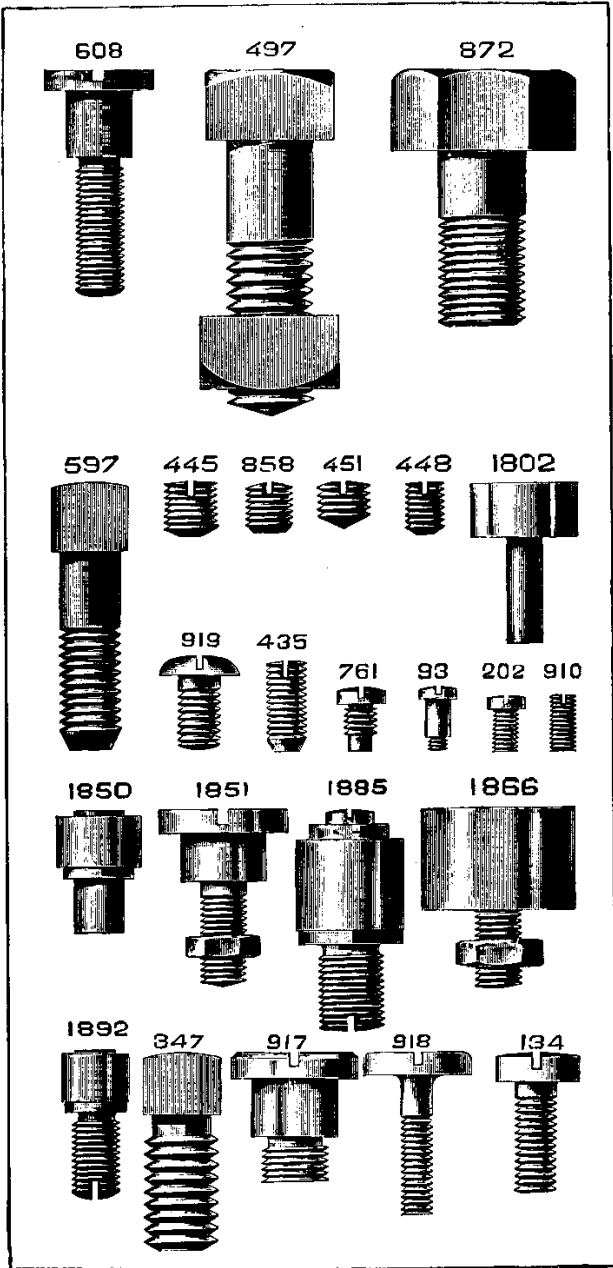

PLATE 901—FULL SIZE

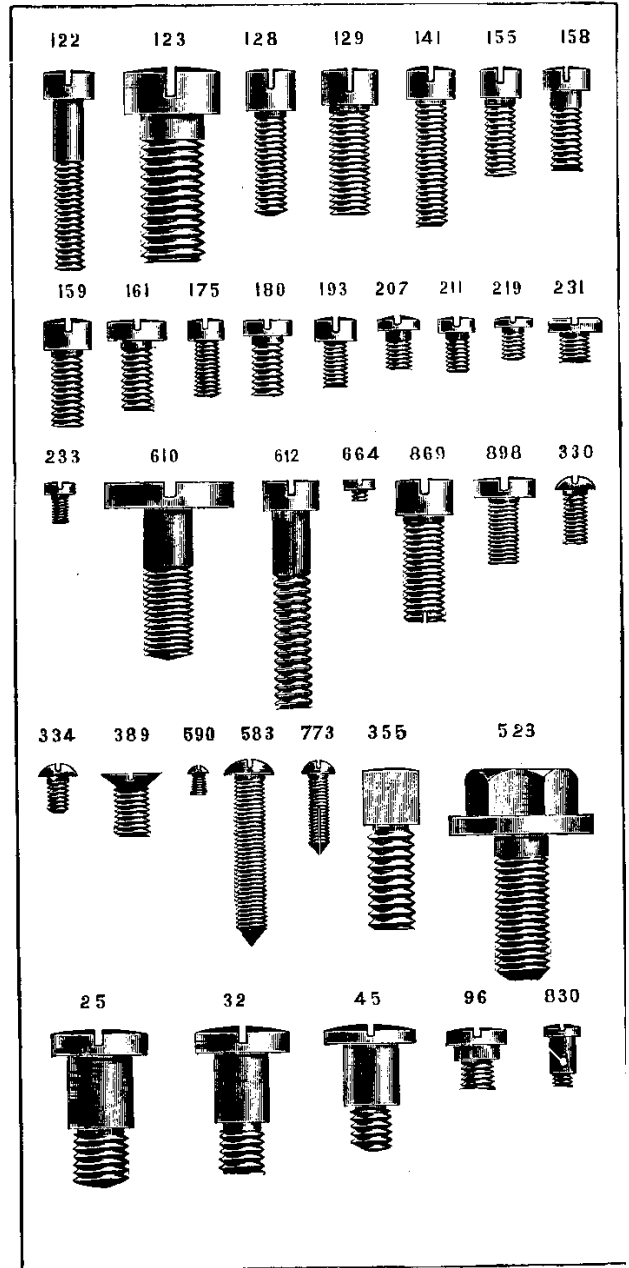

PLATE 902—FULL SIZE

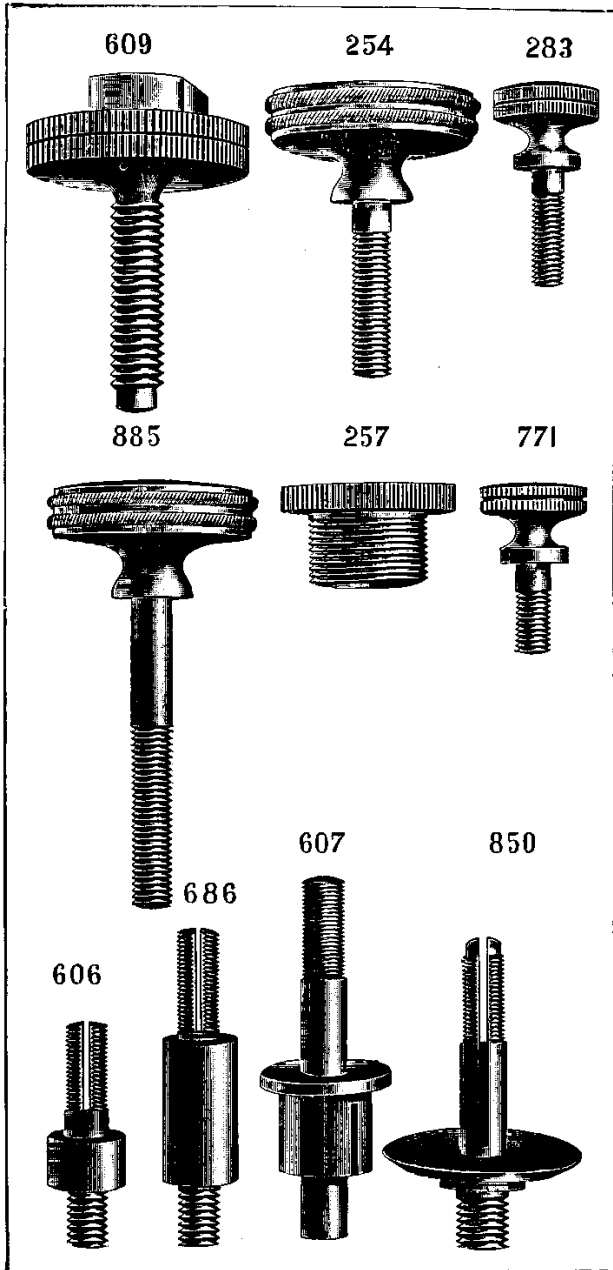

PLATE 903—FULL SIZE

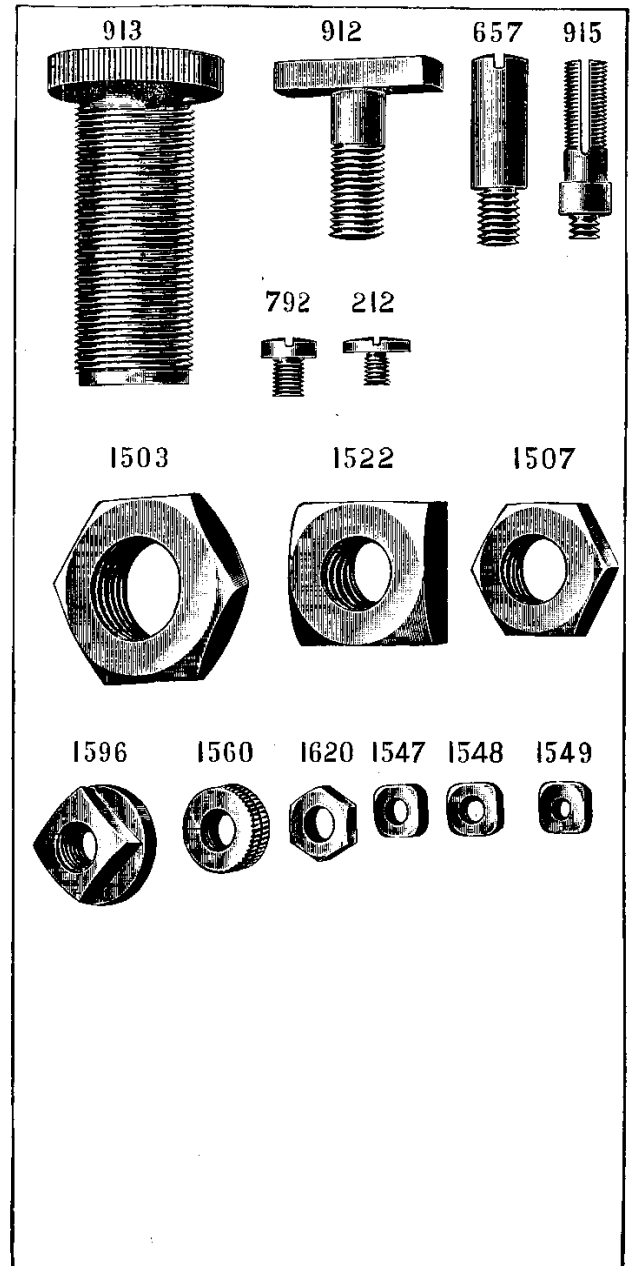

PLATE 904—FULL SIZE

