

# PFAFF

## 1244

**Unterklassen-Ausstattung**



Subclass parts

Composition des sous-classes

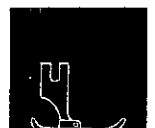
Composición de las subclases

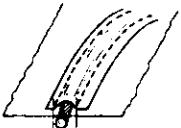

**Table des sous-classes**  
**Tabla de subclases** PFAFF 1244

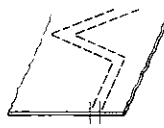
Unterklasse Subclass Sous-classe Subclase	-162/01	-720/02-944/01	-720/02-944/01-900/..	-720/02-944/01
Arbeitsgang Operation Opération Operación				
Ausführung Model Version Tipo de máquina	CN	BN	BN	B/CN
Nadelabstand in mm Needle gauge in mm Ecartement des aiguilles en mm Distancia entre agujas en mm	5,7; 7,2	2,0	2,0	2,4 - 7,2
Nadeistange <input type="checkbox"/> 10/2 Needle bar Barre à aiguille Barra de aguja		91-140 631-91	91-140 631-91	91-140 631-91 <input type="checkbox"/> = 2,4 - 2,8 mm 91-140 637-91 <input type="checkbox"/> = 3,2 - 7,2 mm
Nadelhalter <input type="checkbox"/> 10/2 Needle holder Pince-aiguille Portaagujas	91-710 004-93	91-019 916-13	91-019 916-13	91-019 916-13 <input type="checkbox"/> = 2,4 - 2,8 mm 91-019 930-13 <input type="checkbox"/> = 3,2 - 7,2 mm
Nähfuß <input type="checkbox"/> 4 <input type="checkbox"/> 10/2 Presser foot Pied presseur Pie prensatelas	91-057 135-03			
Rollfuß <input type="checkbox"/> 4 Roller presser Pied à roulette Pie rodante		91-051 138-93	91-051 138-93	91-051 138-93
Drückerfuß <input type="checkbox"/> 4 <input type="checkbox"/> 10/2 Presser foot Pied presseur Pie prensatelas		91-010 816-03	91-010 816-03	91-010 816-03
Stichplatte <input type="checkbox"/> 4 <input type="checkbox"/> 10/2 Needle plate Plaque à aiguille Placa de aguja	91-048 875-04	91-048 496-04	91-058 877-04	91-058 736-04
Stoffschieber <input type="checkbox"/> 4 <input type="checkbox"/> 10/2 Feed dog Griffe Transportador inferior	91-047 959-04	91-046 300-04	91-047 301-04	91-047 826-04
Bandführung Tape guide Guide-ruban Guiacintas	91-053 115-91			

Unterklasse Subclass Sous-classe Subclase	-720/02-944/01-900/..	-750/01-4/01	-750/01-4/01	-750/01-4/01-900/..
<p>Arbeitsgang Operation Opération Operación</p> 		<p>Für Stepparbeiten an Schuhschäften und sonstigen Lederwaren mittels angetriebenem Rollfuß. For stitching shoe uppers and other leather articles with driven roller presser. Travaux de piquage sur tiges ou autres articles en cuir, par pied à roulette entraînée. Para trabajos de pespunteado en cortes de calzado y en artículos de cuero mediante pie rodante accionado.</p>	<p>Für Stepparbeiten an Schuhschäften und sonstigen Lederwaren mittels angetriebenem Rollfuß. For stitching shoe uppers and other leather articles with driven roller presser. Travaux de piquage sur tiges ou autres articles en cuir, par pied à roulette entraînée. Para trabajos de pespunteado en cortes de calzado y en artículos de cuero mediante pie rodante accionado.</p>	<p>Für Stepparbeiten an Schuhschäften und sonstigen Lederwaren mittels angetriebenem Rollfuß. For stitching shoe uppers and other leather articles with driven roller presser. Travaux de piquage sur tiges ou autres articles en cuir, par pied à roulette entraînée. Para trabajos de pespunteado en cortes de calzado y en artículos de cuero mediante pie rodante accionado.</p>
Ausführung Model Version Tipo de máquina	B/CN	CN 8; DN 8	CN 8; DN 8	CN 8
Nadelabstand in mm Needle gauge in mm Ecartement des aiguilles en mm Distancia entre agujas en mm	2,4 - 7,2	1,6 - 3,2	3,6 - 7,2	1,6 - 7,2
Nadelstange <span style="border: 1px solid black; padding: 0 2px;">10/2</span> Needle bar Barre à aiguille Barra de aguja	91-140 631-91 <span style="border: 1px solid black; padding: 0 2px;">10</span> = 2,4 - 2,8 mm 91-140 637-91 <span style="border: 1px solid black; padding: 0 2px;">10</span> = 3,2 - 7,2 mm			
Nadelhalter <span style="border: 1px solid black; padding: 0 2px;">10/2</span> Needle holder Pince-aiguille Portaagujas	91-019 916-93 <span style="border: 1px solid black; padding: 0 2px;">10</span> = 2,4 - 2,8 mm 91-019 930-13 <span style="border: 1px solid black; padding: 0 2px;">10</span> = 3,2 - 7,2 mm	91-118 195-93 x 3,6 <span style="border: 1px solid black; padding: 0 2px;">41/2</span>	91-119 309-93	91-118 195-93 x 3,6 <span style="border: 1px solid black; padding: 0 2px;">41/2</span> <span style="border: 1px solid black; padding: 0 2px;">10</span> = 1,6 - 3,2 mm 91-119 309-93 <span style="border: 1px solid black; padding: 0 2px;">10</span> = 3,6 - 7,2 mm
Rollfuß <span style="border: 1px solid black; padding: 0 2px;">4</span> Roller presser Pied à roulette Pie rodante	91-051 138-93	91-141 232-13 x 0,8 <span style="border: 1px solid black; padding: 0 2px;">95/6</span>	91-141 232-13 x 0,8 <span style="border: 1px solid black; padding: 0 2px;">95/6</span>	91-141 232-13 x 0,8 <span style="border: 1px solid black; padding: 0 2px;">95/6</span>
Drückertuß <span style="border: 1px solid black; padding: 0 2px;">4</span> <span style="border: 1px solid black; padding: 0 2px;">10/2</span> Presser foot Pied presseur Pie prensatelas	91-010 816-03	91-015 558-04	91-010 882-04	91-015 558-04 <span style="border: 1px solid black; padding: 0 2px;">10</span> = 1,6 - 3,2 mm 91-010 882-04 <span style="border: 1px solid black; padding: 0 2px;">10</span> = 3,6 - 7,2 mm
Fingerschutz Finger guard Protège-doigts Salvadedos		91-012 658-91	91-012 658-91	91-012 658-91
Stichplatte <span style="border: 1px solid black; padding: 0 2px;">4</span> <span style="border: 1px solid black; padding: 0 2px;">10/2</span> Needle plate Plaque à aiguille Placa de aguja	91-058 845-04	91-058 441-04	91-058 736-04	91-058 835-04 <span style="border: 1px solid black; padding: 0 2px;">10</span> = 1,6 - 3,2 mm 91-058 845-04 <span style="border: 1px solid black; padding: 0 2px;">10</span> = 3,6 - 7,2 mm
Stoffschieber <span style="border: 1px solid black; padding: 0 2px;">4</span> <span style="border: 1px solid black; padding: 0 2px;">10/2</span> Feed dog Griffe Transportador inferior	91-047 949-04 <span style="border: 1px solid black; padding: 0 2px;">10</span> = 2,4 - 3,6 mm 91-059 005-04 <span style="border: 1px solid black; padding: 0 2px;">10</span> = 4,0 - 7,2 mm	91-047 826-04	91-047 826-04	91-059 067-04 <span style="border: 1px solid black; padding: 0 2px;">10</span> = 1,6 - 3,6 mm 91-059 005-04 <span style="border: 1px solid black; padding: 0 2px;">10</span> = 4,0 - 7,2 mm

**Table des sous-classes**  
**Tabla de subclases** PFAFF 1244

Unterklasse Subclass Sous-classe Subclase	-750/01-4/01-900/..	-944/01	-944/01	-944/01-900/..	-944/01-900/..
Arbeitsgang Operation Opération Operación	Für Stepparbeiten an Schuhschäften und sonstigen Lederwaren mittels angetriebenem Rollfuß. For stitching shoe uppers and other leather articles with driven roller presser. Travaux de piquage sur tiges ou autres articles en cuir, par pied à roulette entraînée. Para trabajos de pespunteado en cortes de calzado y en artículos de cuero mediante pie rodante accionado.	Für Stepparbeiten an Schuhschäften und sonstigen Lederwaren mittels angetriebenem Rollfuß. For stitching shoe uppers and other leather articles with driven roller presser. Travaux de piquage sur tiges ou autres articles en cuir, par pied à roulette entraînée. Para trabajos de pespunteado en cortes de calzado y en artículos de cuero mediante pie rodante accionado.	Für Stepparbeiten an Schuhschäften und sonstigen Lederwaren mittels angetriebenem Rollfuß. For stitching shoe uppers and other leather articles with driven roller presser. Travaux de piquage sur tiges ou autres articles en cuir, par pied à roulette entraînée. Para trabajos de pespunteado en cortes de calzado y en artículos de cuero mediante pie rodante accionado.	Für Stepparbeiten an Schuhschäften und sonstigen Lederwaren mittels angetriebenem Rollfuß. For stitching shoe uppers and other leather articles with driven roller presser. Travaux de piquage sur tiges ou autres articles en cuir, par pied à roulette entraînée. Para trabajos de pespunteado en cortes de calzado y en artículos de cuero mediante pie rodante accionado.	Für Stepparbeiten an Schuhschäften und sonstigen Lederwaren mittels angetriebenem Rollfuß. For stitching shoe uppers and other leather articles with driven roller presser. Travaux de piquage sur tiges ou autres articles en cuir, par pied à roulette entraînée. Para trabajos de pespunteado en cortes de calzado y en artículos de cuero mediante pie rodante accionado.
Ausführung Model Version Tipo de máquina	C/DN 8	CN 8; DN 8	CN 8; DN 8	CN 8	C/DN 8
Nadelabstand in mm Needle gauge in mm Ecartement des aiguilles en mm Distancia entre agujas en mm	2,0 - 7,2	1,6 - 3,2	3,6 - 7,2	1,6 - 7,2	2,0 - 7,2
Nadelhalter <sup>[10/2]</sup> Needle holder Pince-aiguille Portaagujas	91-118 195-93 x 3,6 <sup>[41/2]</sup> [10] = 2,0 - 3,2 mm 91-119 309-93 [10] = 3,6 - 7,2 mm	91-118 195-93 x 3,6 <sup>[41/2]</sup>	91-119 309-93	91-118 195-93 x 3,6 <sup>[41/2]</sup> [10] = 1,6 - 3,2 mm 91-119 309-93 [10] = 3,6 - 7,2 mm	91-118 195-93 x 3,6 <sup>[41/2]</sup> [10] = 2,0 - 3,2 mm 91-119 309-93 [10] = 3,6 - 7,2 mm
Rollfuß <sup>[4]</sup> Roller presser Pied à roulette Pie rodante	91-141 232-13 x 0,8 <sup>[95/6]</sup>	91-051 159-93	91-051 159-93	91-051 159-93	91-051 159-93
Drückertfuß <sup>[4]</sup> <sup>[10/2]</sup> Presser foot Pied presseur Pie prensateñas	91-115 558-04 [10] = 2,0 - 3,2 mm 91-010 882-04 [10] = 3,6 - 7,2 mm	91-015 558-04	91-010 882-04	91-015 558-04 [10] = 1,6 - 3,2 mm 91-010 882-04 [10] = 3,6 - 7,2 mm	91-015 558-04 [10] = 2,0 - 3,2 mm 91-010 882-04 [10] = 3,6 - 7,2 mm
Fingerschutz Finger guard Protège-doigts Salvadedos	91-012 658-91	91-157 813-91	91-157 813-91	91-157 813-91	91-157 813-91
Stichplatte <sup>[4]</sup> <sup>[10/2]</sup> Needle plate Plaque à aiguille Placa de aguja	91-058 835-04 [10] = 2,0 - 3,2 mm 91-058 845-04 [10] = 3,6 - 7,2 mm	91-058 441-04	91-058 736-04	91-058 835-04 [10] = 1,6 - 3,2 mm 91-058 845-04 [10] = 3,6 - 7,2 mm	91-058 835-04 [10] = 2,0 - 3,2 mm 91-058 845-04 [10] = 3,6 - 7,2 mm
Stoffschieber <sup>[4]</sup> <sup>[10/2]</sup> Feed dog Griffe Transportador inferior	91-059 067-04 [10] = 2,0 - 3,6 mm 91-059 005-04 [10] = 4,0 - 7,2 mm	91-047 826-04	91-047 826-04	91-059 067-04 [10] = 1,6 - 3,6 mm 91-059 005-04 [10] = 4,0 - 7,2 mm	91-059 067-04 [10] = 2,0 - 3,2 mm 91-059 005-04 [10] = 4,0 - 7,2 mm

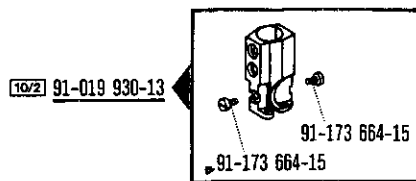
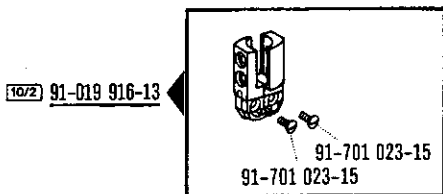
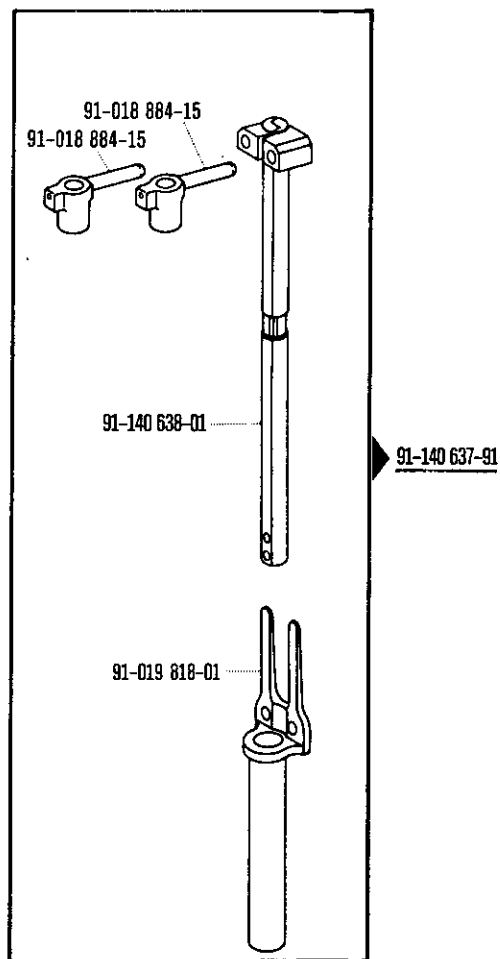
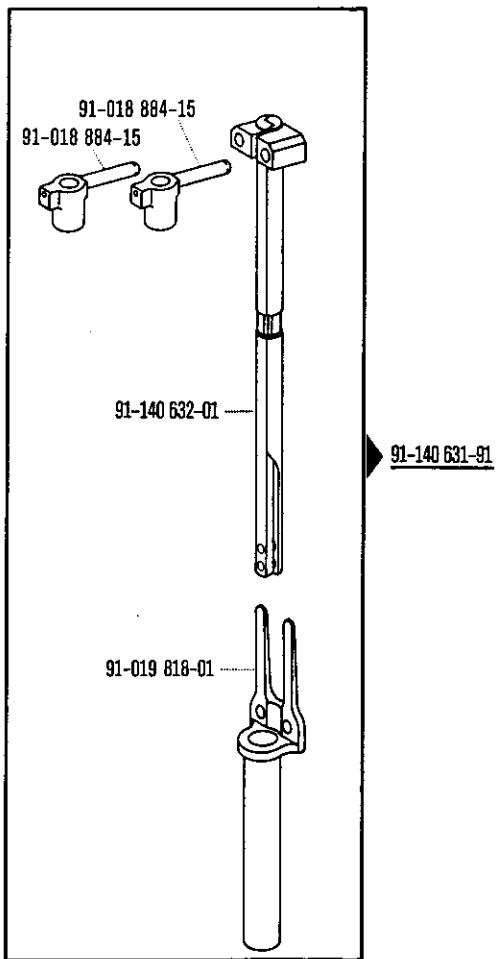

-720/02-944/01  
 -720/02-944/01-900/56

-720/02-944/01  
 -720/02-944/01-900/56

91-118 195-93 x 3,6 10/2 41/2

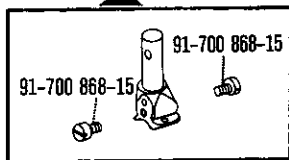

-750/01-4/01  
 -750/01-4/01-900/56  
 -944/01  
 -944/01-900/56

91-119 309-93 10/2

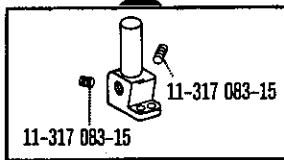

-750/01-4/01  
 -750/01-4/01-900/56  
 -944/01  
 -944/01-900/56

91-710 004-93 10/2

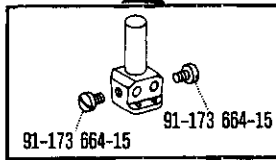





-162/01

91-051 138-93 4 10/2



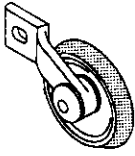
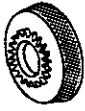
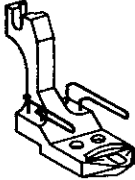
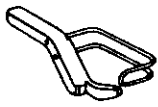
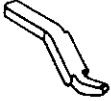

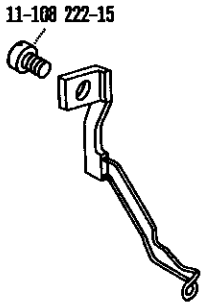
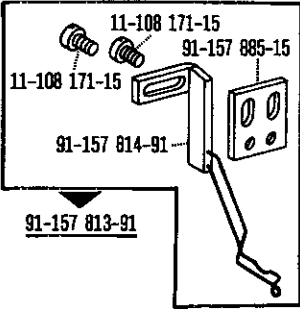
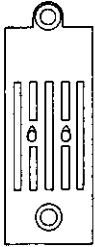
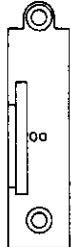
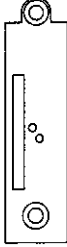
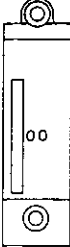

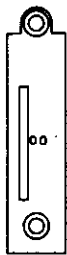
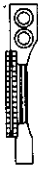
-720/02-944/01  
 -720/02-944/01-900/56

Organe de couture  
 Organo de costura PFAFF 1244

<p>91-051 159-93 <span style="border: 1px solid black; padding: 0 2px;">4</span> <span style="border: 1px solid black; padding: 0 2px;">10/2</span></p>  <p><b>-944/01</b> <b>-944/01-900/56</b></p>	<p>91-141 232-13 x 0,8 <span style="border: 1px solid black; padding: 0 2px;">95/6</span></p>  <p><b>-750/01-4/01</b> <b>-750/01-4/01-900/56</b></p>	<p>91-057 135-03 <span style="border: 1px solid black; padding: 0 2px;">4</span> <span style="border: 1px solid black; padding: 0 2px;">5</span> <span style="border: 1px solid black; padding: 0 2px;">10/2</span></p>  <p><b>-162/01</b></p>	<p>91-010 816-03 <span style="border: 1px solid black; padding: 0 2px;">4</span> <span style="border: 1px solid black; padding: 0 2px;">10/2</span></p>  <p><b>-720/02-944/01</b> <b>-720/02-944/01-900/56</b></p>
<p>91-010 882-04 <span style="border: 1px solid black; padding: 0 2px;">4</span> <span style="border: 1px solid black; padding: 0 2px;">10/2</span></p>  <p><b>-750/01-4/01</b> <b>-750/01-4/01-900/56</b> <b>-944/01</b> <b>-944/01-900/56</b></p>	<p>91-015 558-04 <span style="border: 1px solid black; padding: 0 2px;">4</span> <span style="border: 1px solid black; padding: 0 2px;">10/2</span></p>  <p><b>-750/01-4/01</b> <b>-750/01-4/01-900/56</b> <b>-944/01</b> <b>-944/01-900/56</b></p>	<p>91-012 658-91</p>  <p><b>-750/01-4/01</b> <b>-750/01-4/01-900/56</b></p>	<p>11-108 222-15</p>  <p><b>-944/01</b> <b>-944/01-900/56</b></p>
<p>91-048 875-04 <span style="border: 1px solid black; padding: 0 2px;">4</span> <span style="border: 1px solid black; padding: 0 2px;">10/2</span></p>  <p><b>-162/01</b></p>	<p>91-048 496-04 <span style="border: 1px solid black; padding: 0 2px;">4</span> <span style="border: 1px solid black; padding: 0 2px;">10/2</span></p>  <p><b>-720/02-944/01</b></p>	<p>91-058 441-04 <span style="border: 1px solid black; padding: 0 2px;">4</span> <span style="border: 1px solid black; padding: 0 2px;">10/2</span></p>  <p><b>-750/01-4/01</b> <b>-944/01</b></p>	<p>91-058 736-04 <span style="border: 1px solid black; padding: 0 2px;">4</span> <span style="border: 1px solid black; padding: 0 2px;">10/2</span></p>  <p><b>-720/02-944/01</b> <b>-750/01-4/01</b> <b>-944/01</b></p>
<p>91-058 835-04 <span style="border: 1px solid black; padding: 0 2px;">4</span> <span style="border: 1px solid black; padding: 0 2px;">10/2</span></p>  <p><b>-750/01-4/01-900/56</b> <b>-944/01-900/56</b></p>	<p>91-058 845-04 <span style="border: 1px solid black; padding: 0 2px;">4</span> <span style="border: 1px solid black; padding: 0 2px;">10/2</span></p>  <p><b>-720/02-944/01-900/56</b> <b>-750/01-4/01-900/56</b> <b>-944/01-900/56</b></p>	<p>91-058 877-04 <span style="border: 1px solid black; padding: 0 2px;">4</span> <span style="border: 1px solid black; padding: 0 2px;">10/2</span></p>  <p><b>-720/02-944/01-900/56</b></p>	<p>91-046 300-04 <span style="border: 1px solid black; padding: 0 2px;">4</span> <span style="border: 1px solid black; padding: 0 2px;">10/2</span></p>  <p><b>-720/02-944/01</b></p>

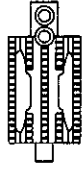
Gauge parts  
 Organes de couture  
 Organos de costura PFAFF 1244

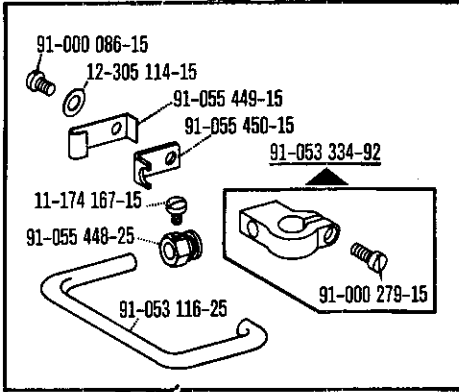
<p>91-047 301-04 <span style="border: 1px solid black; padding: 0 2px;">A</span> <span style="border: 1px solid black; padding: 0 2px;">10/2</span></p>  <p>-720/02-944/01-900/56</p>	<p>91-047 826-04 <span style="border: 1px solid black; padding: 0 2px;">A</span> <span style="border: 1px solid black; padding: 0 2px;">10/2</span></p>  <p>-720/02-944/01          -750/01-4/01          -944/01</p>	<p>91-047 949-04 <span style="border: 1px solid black; padding: 0 2px;">A</span> <span style="border: 1px solid black; padding: 0 2px;">10/2</span></p>  <p>-720/02-944/01-900/56</p>	<p>91-047 959-04 <span style="border: 1px solid black; padding: 0 2px;">A</span> <span style="border: 1px solid black; padding: 0 2px;">10/2</span></p>  <p>-162/01</p>
<p>91-059 005-04 <span style="border: 1px solid black; padding: 0 2px;">A</span> <span style="border: 1px solid black; padding: 0 2px;">10/2</span></p>  <p>-720/02-944/01-900/56          -750/01-4/01-900/56          -944/01-900/56</p>	<p>91-059 067-04 <span style="border: 1px solid black; padding: 0 2px;">A</span> <span style="border: 1px solid black; padding: 0 2px;">10/2</span></p>  <p>-750/01-4/01-900/56          -944/01-900/56</p>	<p>91-053 115-91</p>  <p>-162/01</p>	

☐ siehe Erläuterungen Register A 10/2  
 see explanations in section A 10/2  
 voir légende registre A 10/2

**PFAFF**