

SINGER
212U541A

ILLUSTRATED PARTSLIST FOR SINGER*

MACHINE 212U541A

This Insert Lists Only the Parts Used for the 212U541A Machine.

For 212U541A Machine;
Pages of this Insert

Pages of Parts List
for 212U141A

1	supersedes	1
2	supersedes	9
3	supersedes	10
4	supersedes	11

Note) 212U541A Uses Part No. N1955-01, Size 135X65, #21 Needle

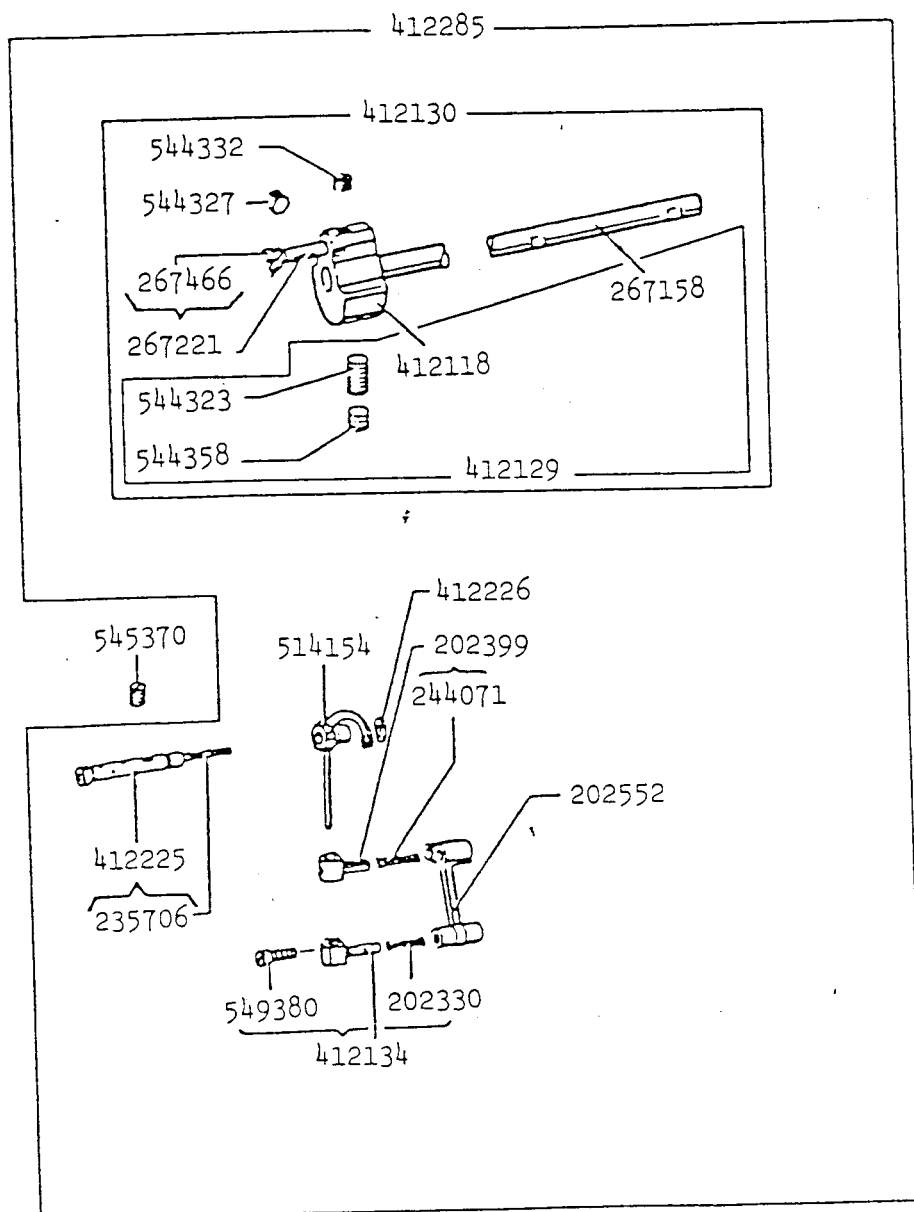
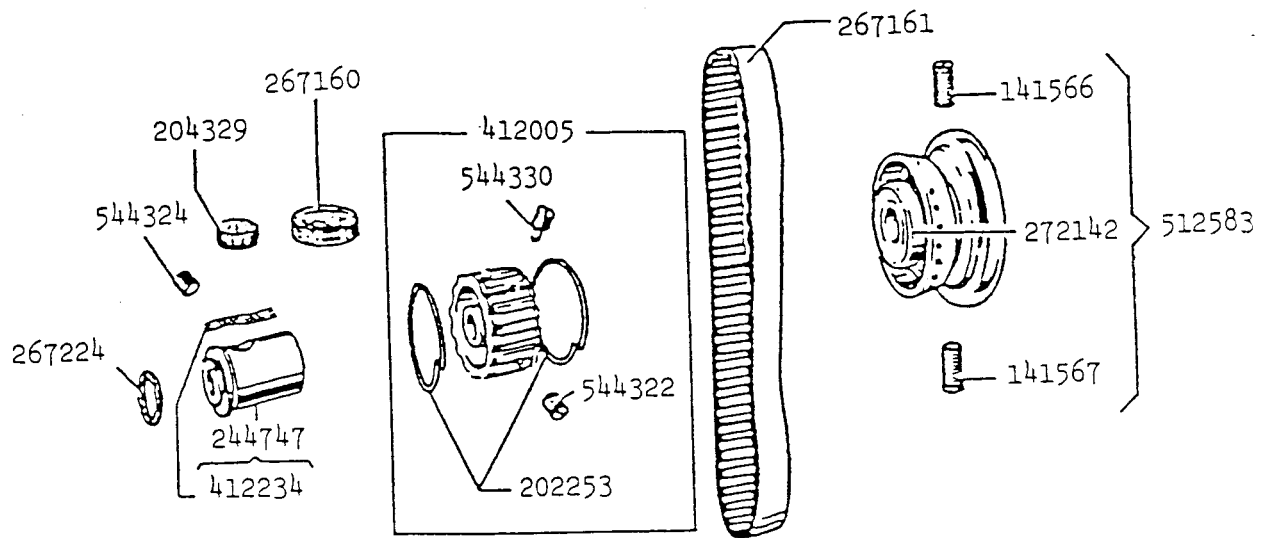

No.	212U141A 541A 211U157 165 166 566	Description
141566	* * * * *	Machine Pulley Position Screw
141567	* * * * *	Machine Pulley Set Screw
202253	* * * * *	Arm Shaft Connection Belt Pulley Spring Flange (2)
202330	* * * * *	Needle Bar Connection Stud Oil Packing (wick)
202399	* * * * *	Take-up Lever Driving Stud with 244071
202552	* * * * *	Needle Bar Connecting Link
204329	* * * * *	Arm Shaft Bushing Oil Pad (felt) (lower)
235706	* * * * *	Take-up Lever Hinge Stud Oil Packing (wick)
244071	* * * * *	Take-up Lever Driving Stud Oil Packing (wick)
244747	* * * * *	Arm Shaft Bushing (front) with 412234
267158	* * * * *	Arm Shaft
267160	* * * * *	Arm Shaft Bushing Oil Pad (felt) (upper)
267161	* * * * *	Arm Shaft Connecting Belt
267221	* * * * *	Needle Bar Connecting Link Stud with 267466
267224	* * * * *	Needle Bar Crank Friction Washer
267466	* * * * *	Needle Bar Connecting Link Stud Oil Packing (wick)
272142	* * * * *	Machine Pulley Ball Bearing (back)
412005	* * * * *	Arm Shaft Connection Belt Pulley with 202253 (2), 544322, 544330
412118	- * - - - *	Needle Bar Crank
412129	- * - - - *	Arm Shaft Complete 267158, 412118, 544323, 544358
412130	- * - - - *	Arm Shaft Complete 267221, 412129, 544327, 544332
412134	* * * - - -	Needle Bar Connecting Stud with 202330, 549380
412225	* * * * * *	Take-up Lever Hinge Stud with 235706
412226	* * * * * *	Take-up Lever Hinge Stud Wearing Washer
412234	* * * * * *	Arm Shaft Bushing (front) Oil Wick
412285	- * - - - -	Arm Shaft Complete 202399, 202552, 412130, 412134 412225, 412226, 514154
512583	* * * - - -	Machine Pulley with 141566, 141567, 272142
514154	- * - - - -	Take-up Lever
544322	* * * * * *	Arm Shaft Connection Belt Pulley Set Screw
544323	* * * * * *	Needle Bar Crank Position Screw
544324	* * * * * *	Arm Shaft Bushing (front) Set Screw
544327	* * * * * *	Needle Bar Connecting Link Stud Set Screw
544330	* * * * * *	Arm Shaft Connection Belt Pulley Position Screw
544332	* * * * * *	Needle Bar Connecting Link Stud Set Screw
544358	* * * * * *	Needle Bar Crank Position Screw Check Screw
545370	* * * * * *	Take-up Lever Hinge Stud Set Screw
549380	* * * * * *	Needle Bar Connecting Stud Pinch Screw

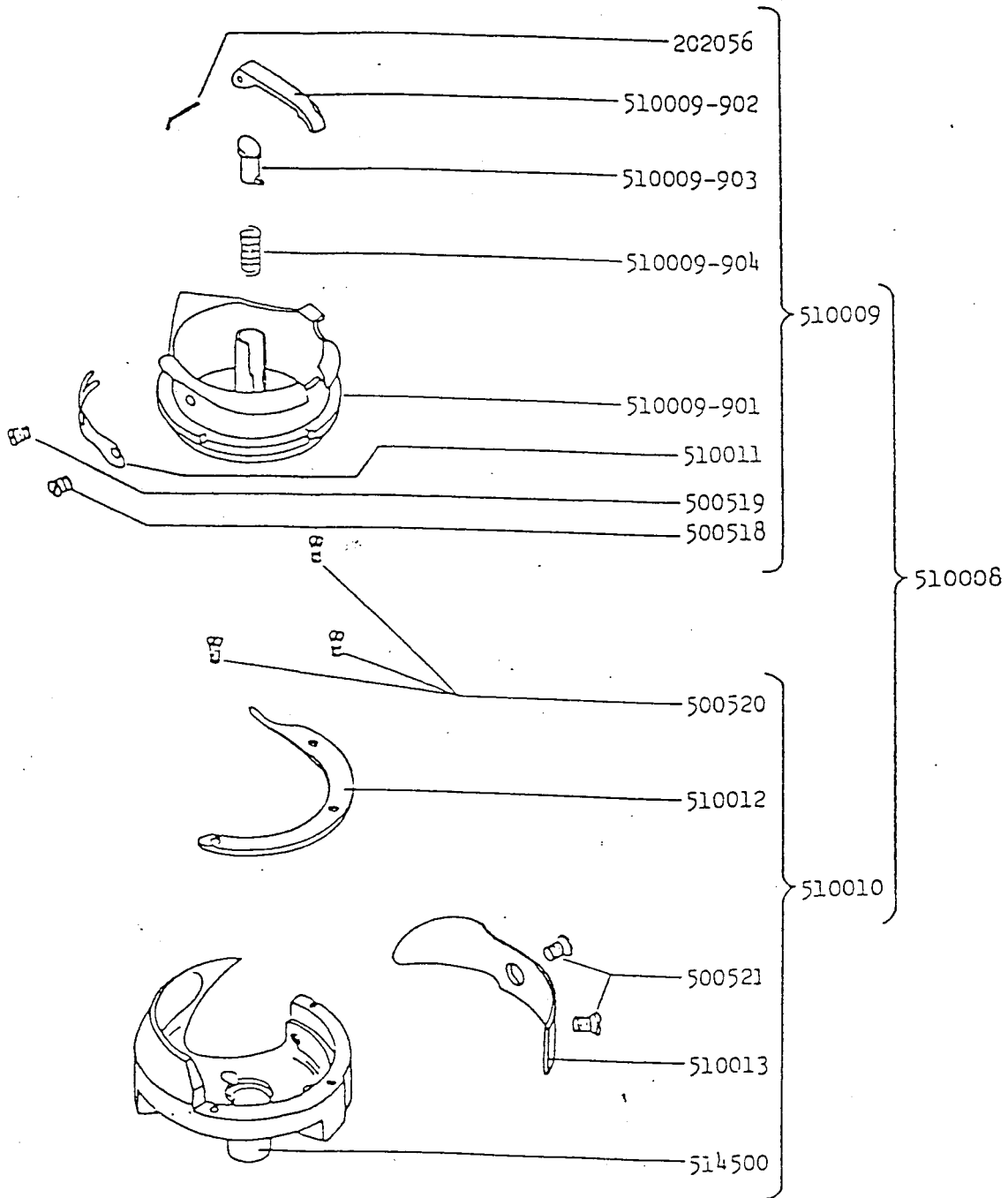

No.	212071A 511A 2110157 165 166 566	Description
202056	* * * * *	Bobbin Case Latch Pin
500518	- * - - - *	Bobbin Case Tension Spring Screw
500519	- * - - - *	Bobbin Case Tension Spring Regulating Screw
500520	- * - - - *	Hook Gib Screw (3)
500521	- * - - - *	Hook Needle Guard Screw (2)
510008	- * - - - *	Hook and Bobbin Case Complete 510009, 510010
510009	- * - - - *	Bobbin Case Complete 202056, 500518, 500519, 510009-901 510009-902, 510009-903, 510009-904, 510011
510009-901	- * - - - *	Bobbin Case Body
510009-902	- * - - - *	Bobbin Case Latch
510009-903	- * - - - *	Bobbin Case Latch Plunger
510009-904	- * - - - *	Bobbin Case Latch Spring
510010	- * - - - *	Hook Complete 500520 (3), 500521 (2), 510012, 510013, 514500
510011	- * - - - *	Bobbin Case Tension Spring
510012	- * - - - *	Hook Gib
510013	- * - - - *	Hook Needle Guard
514500	- * - - - *	Hook Body

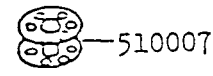
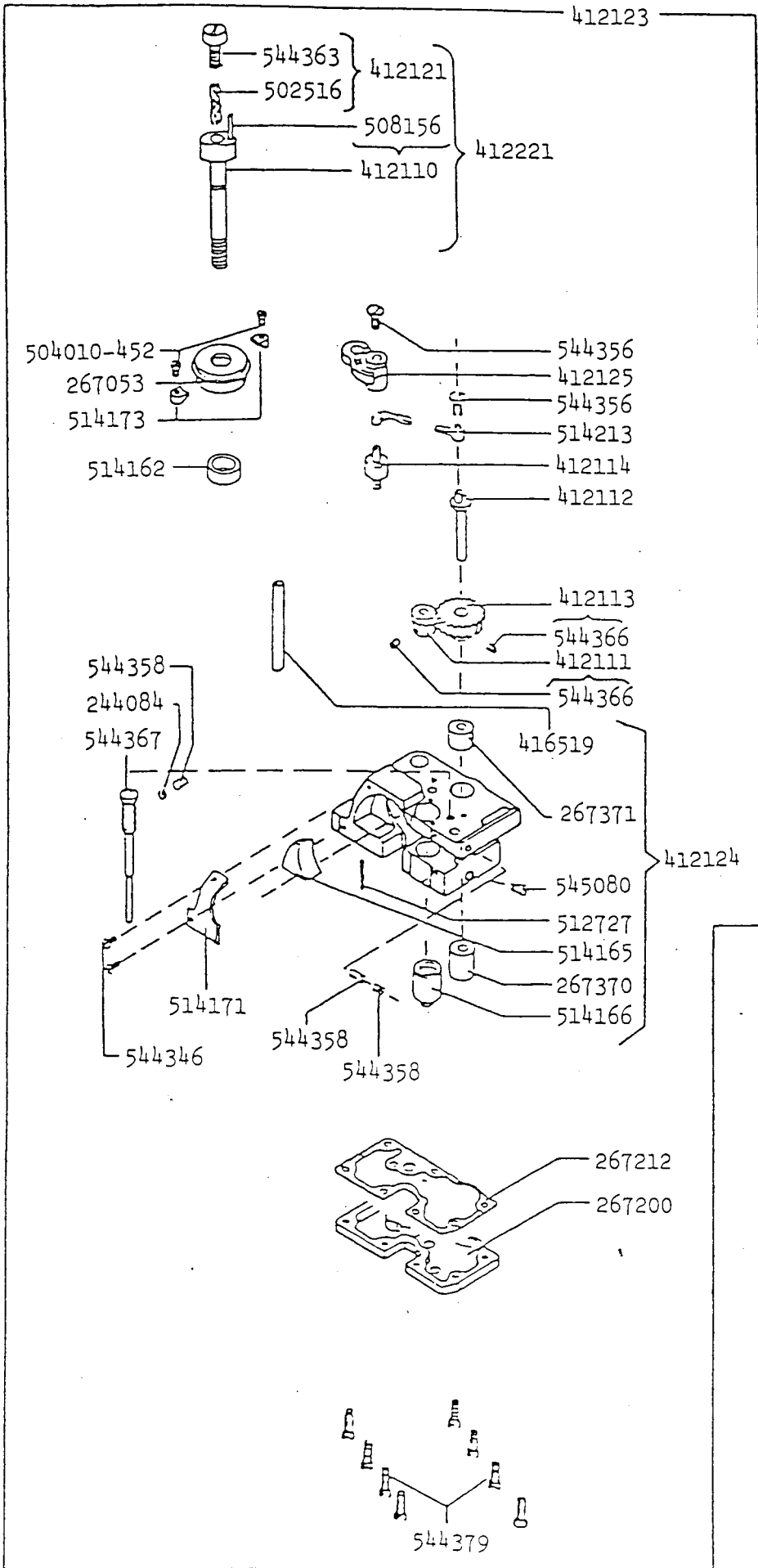

510007

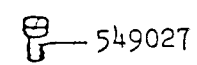

549027

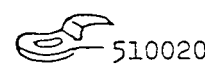

510020

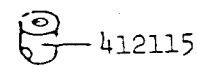

412115

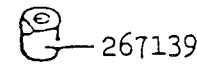

267139

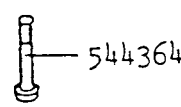

544364

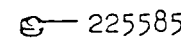

225585

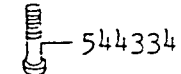

544334

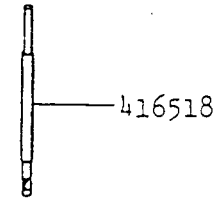

416518

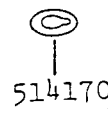

514170

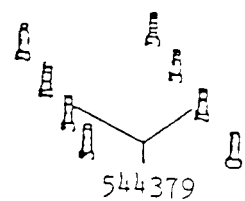

544379

No.	212U141A 541A 211U157 165 166 566	Description
225585	* * * * *	Hook Saddle Screw Washer
224084	* * * - - *	Hook Saddle Oil Regulating Screw Check Screw Packing
267053	* * * - - *	Hook Ball Bearing
267139	* * * - - *	Pinch Sleeve (lower)
267200	* * * - - *	Hook Saddle Oil Reservoir
267212	* * * - - *	Hook Saddle Oil Reservoir Gasket
267370	* * * - - *	Bobbin Case Opener Driving Cam Shaft Bushing (lower)
267371	* * * - - *	Bobbin Case Opener Driving Cam Shaft Bushing (upper)
412110	- * - - - *	Hook Shaft with 508156
412111	- * - - - *	Hook Driving Pinion (Spiral) with 544366 (2)
412112	* * * - - *	Bobbin Case Opener Cam Shaft
412113	* * * - - *	Bobbin Case Opener Driving Cam Shaft Gear (Spiral) with 544366 (2)
412114	- * - - - *	Bobbin Case Opener Crank Hinge Stud
412115	* * * - - *	Pinch Sleeve (upper)
412121	- * - - - *	Hook Shaft Oil Wick Holder Complete 502516, 544363
412123	- * - - - *	Hook Saddle (right) Complete 244084, 267053, 267200, 267212, 412111, 412112, 412113, 412114, 412124, 412125, 412221, 504010-452 (2), 514162, 514171, 514173 (2), 514213, 544346 (2), 544356 (2), 544358 (3), 544367, 544379 (8)
412124	* * * - - *	Hook Saddle (right) with 267370, 267371, 416519, 512727, 514165, 514166, 545080
412125	- * - - - *	Bobbin Case Opener Crank
412221	- * - - - *	Hook Shaft, Hook Shaft Oil Wick Holder Complete 412110, 412121
416518	* * * - - *	Hook Saddle Oil Gauge
416519	* * * - - -	Hook Saddle Oil Gauge Sleeve
502516	- * - - - *	Hook Shaft Oil Wick
504010-452	* * * - - *	Hook Ball Bearing Retainer Screw (2)
508156	- * - - - *	Hook Shaft Parallel Pin
510007	- * - - - *	Bobbin
510020	- * - - - *	Bobbin Case Opener
512727	* * * - - *	Hook Saddle Oil Wick
514162	- * - - - *	Spacer
514165	* * * - - *	Hook Saddle Foam Cushion
514166	* * * - - *	Hook Shaft Bushing
514170	- * - - - *	Hook Spacer (7)
514171	* * * - - *	Hook Saddle Cover Plate
514173	* * * - - *	Hook Ball Bearing Retainer (2)
514213	* * * - - *	Bobbin Case Opener Link
544334	* * * * * *	Hook Saddle Screw
544346	* * * - - *	Hook Saddle Cover Plate Screw (2)
544356	* * * - - *	Bobbin Case Opener Crank Cap Screw
544356	* * * - - *	Bobbin Case Opener Link Cap Screw
544358	* * * - - *	Hook Saddle Oil Regulating Screw Check Screw
544358	* * * - - *	Bobbin Case Opener Crank Hinge Stud Set Screw
544358	* * * - - *	Bobbin Case Opener Crank Hinge Stud Set Screw Check Screw
544363	- * - - - *	Hook Shaft Oil Wick Holder
544364	* * * - - *	Pinch Sleeve Screw
544366	* * * - - *	Bobbin Case Opener Driving Cam Shaft Gear (Spiral) Set Screw (2)
544366	* * * - - *	Hook Driving Pinion (Spiral) Set Screw (2)
544367	* * * - - *	Hook Saddle Oil Regulating Screw
544379	* * * - - *	Hook Saddle Oil Reservoir Screw (8)
545080	* * * - - *	Hook Saddle Oil Stop Screw
549027	* * * * * *	Bobbin Case Opener Screw