

**SINGER**  
15K88,K91

ILLUSTRATED  
LIST OF PARTS

FOR

Nos. 15K88 to 15K91  
MACHINES



\*\*A Trade Mark of THE SINGER MANUFACTURING CO.

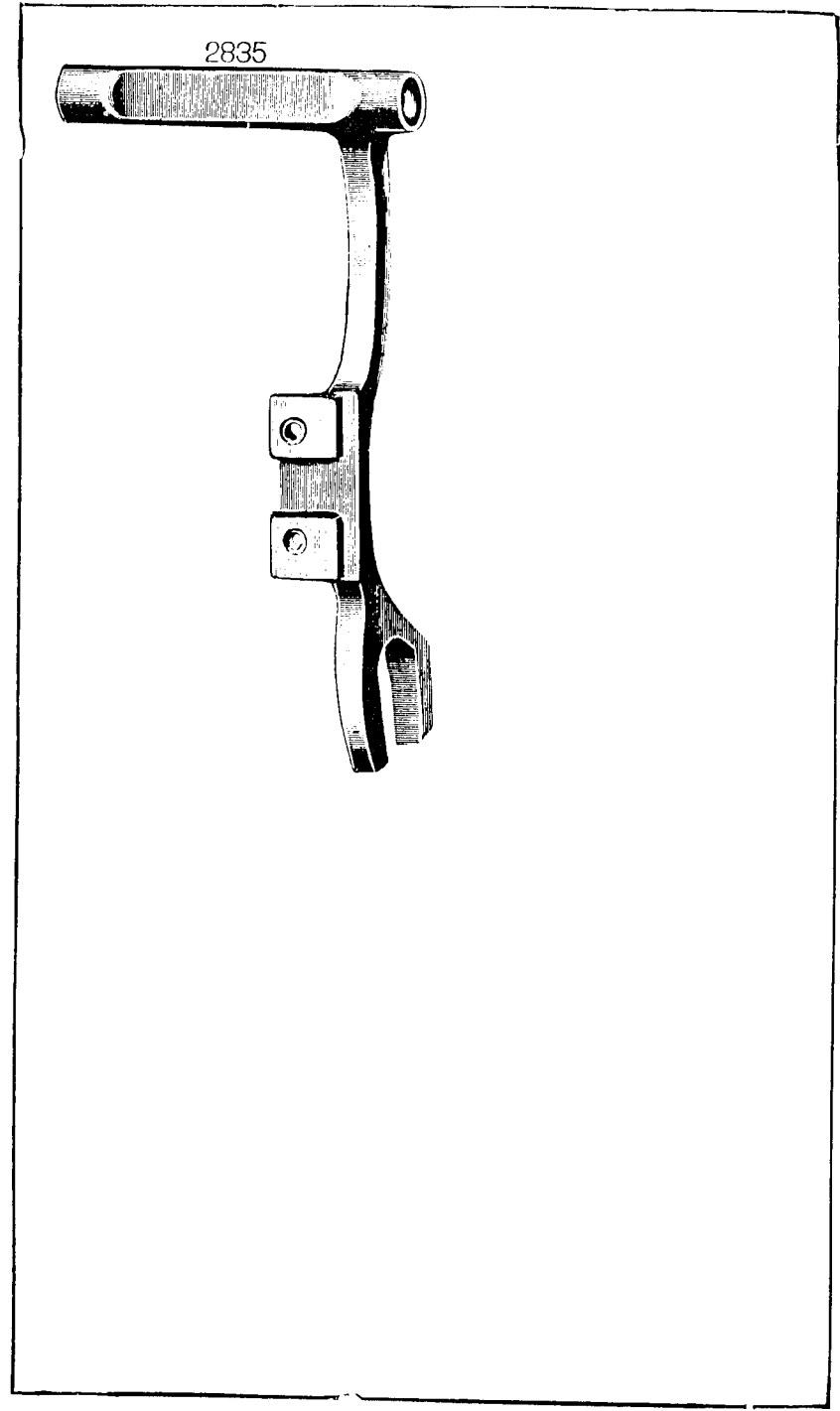

121170

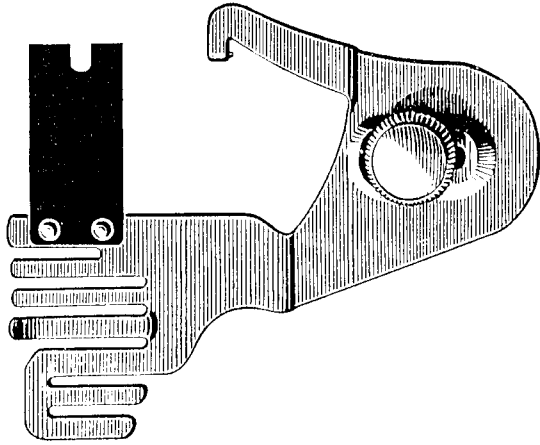

121547

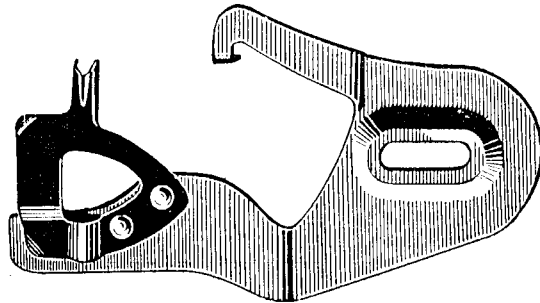

15282

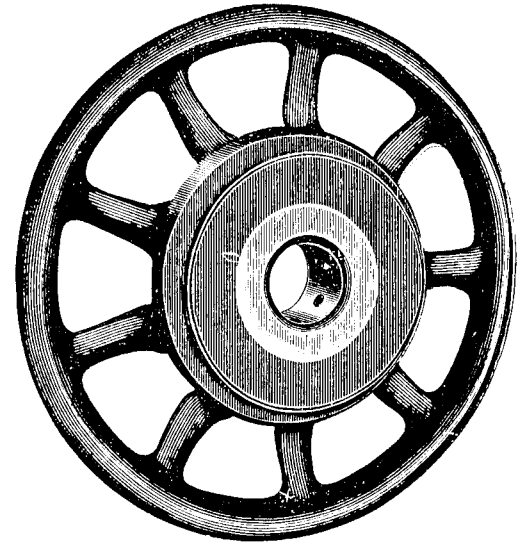

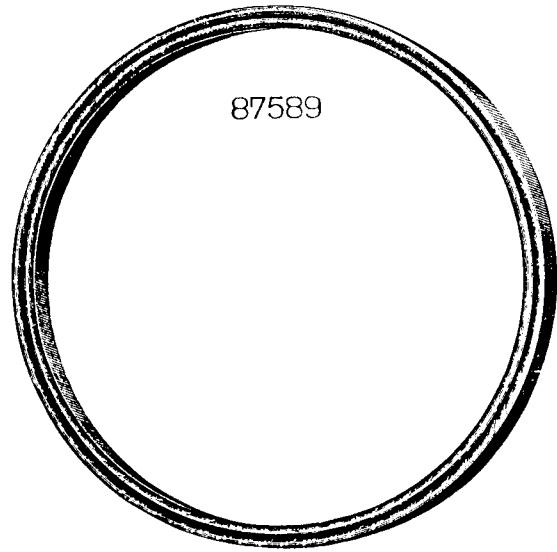

87589

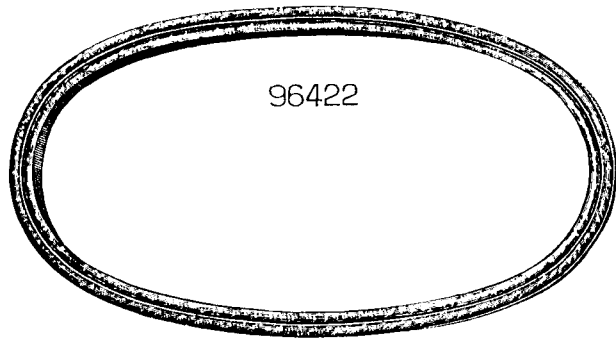

96422

32672

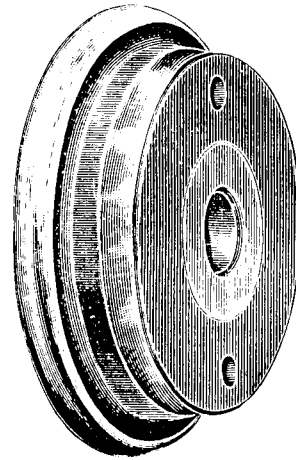

125319

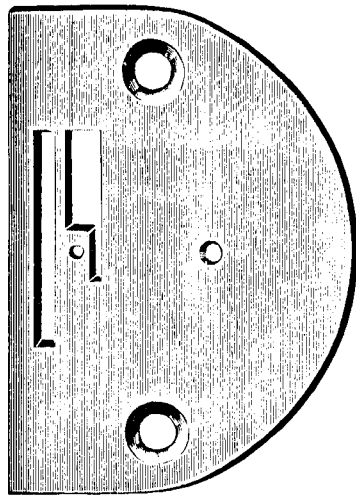

125261

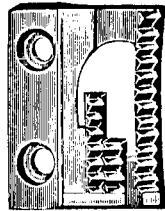

125285



120855



120914



125336

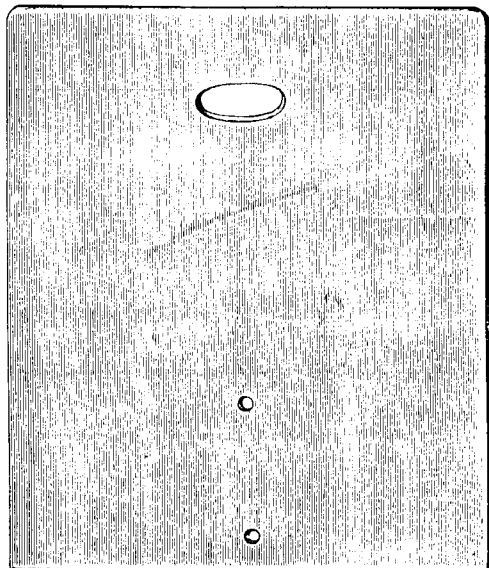

125337

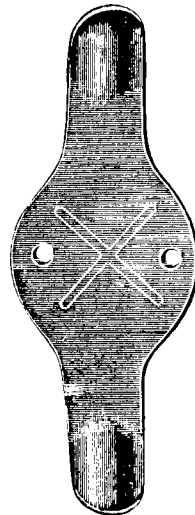

125253



125270



125021



125263



125262

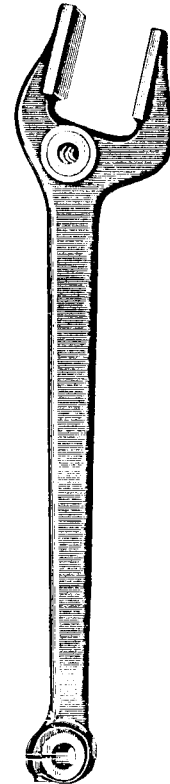

125280

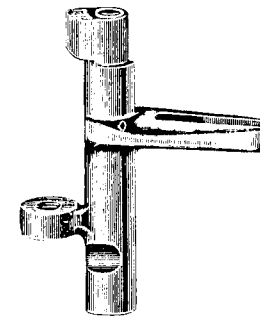

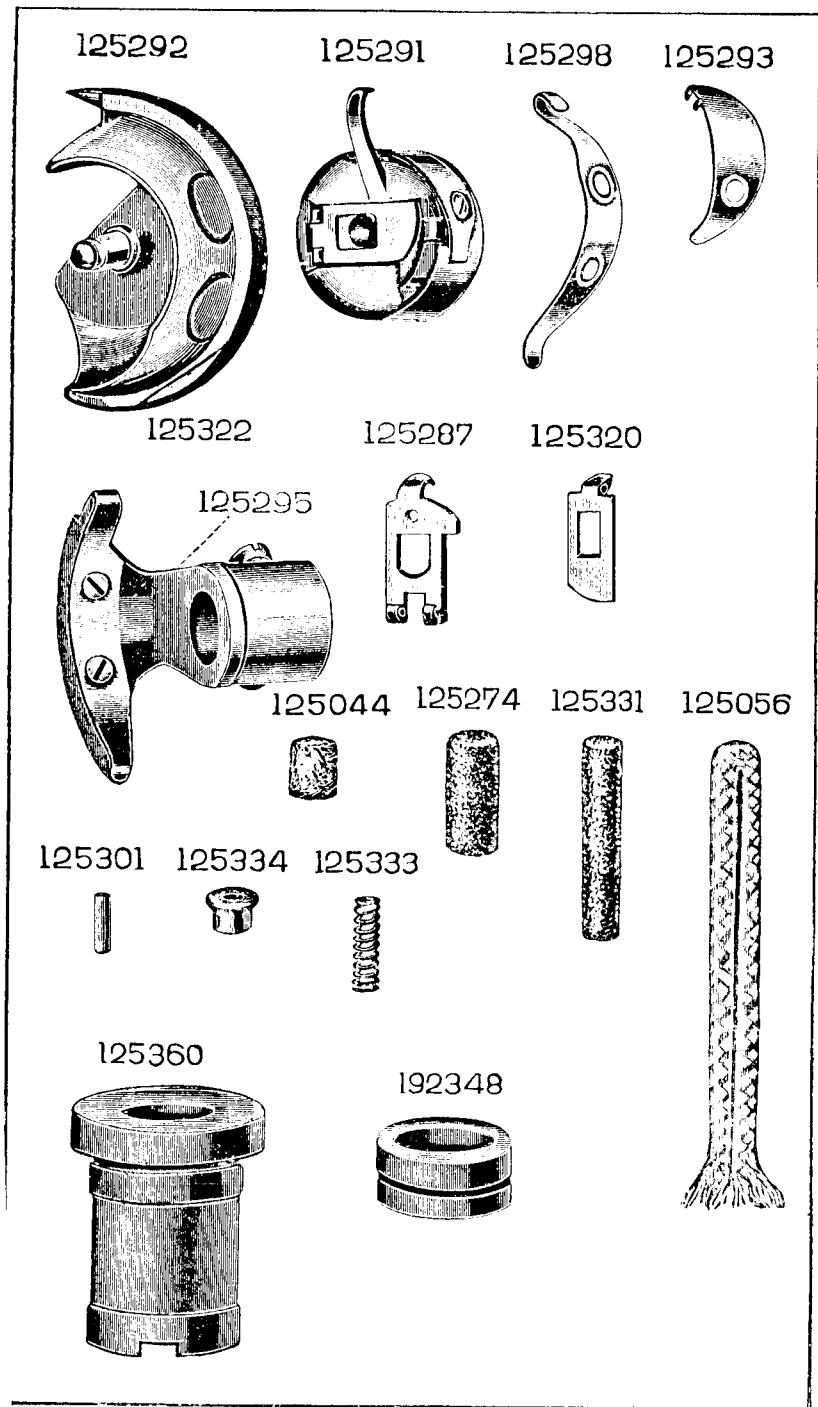
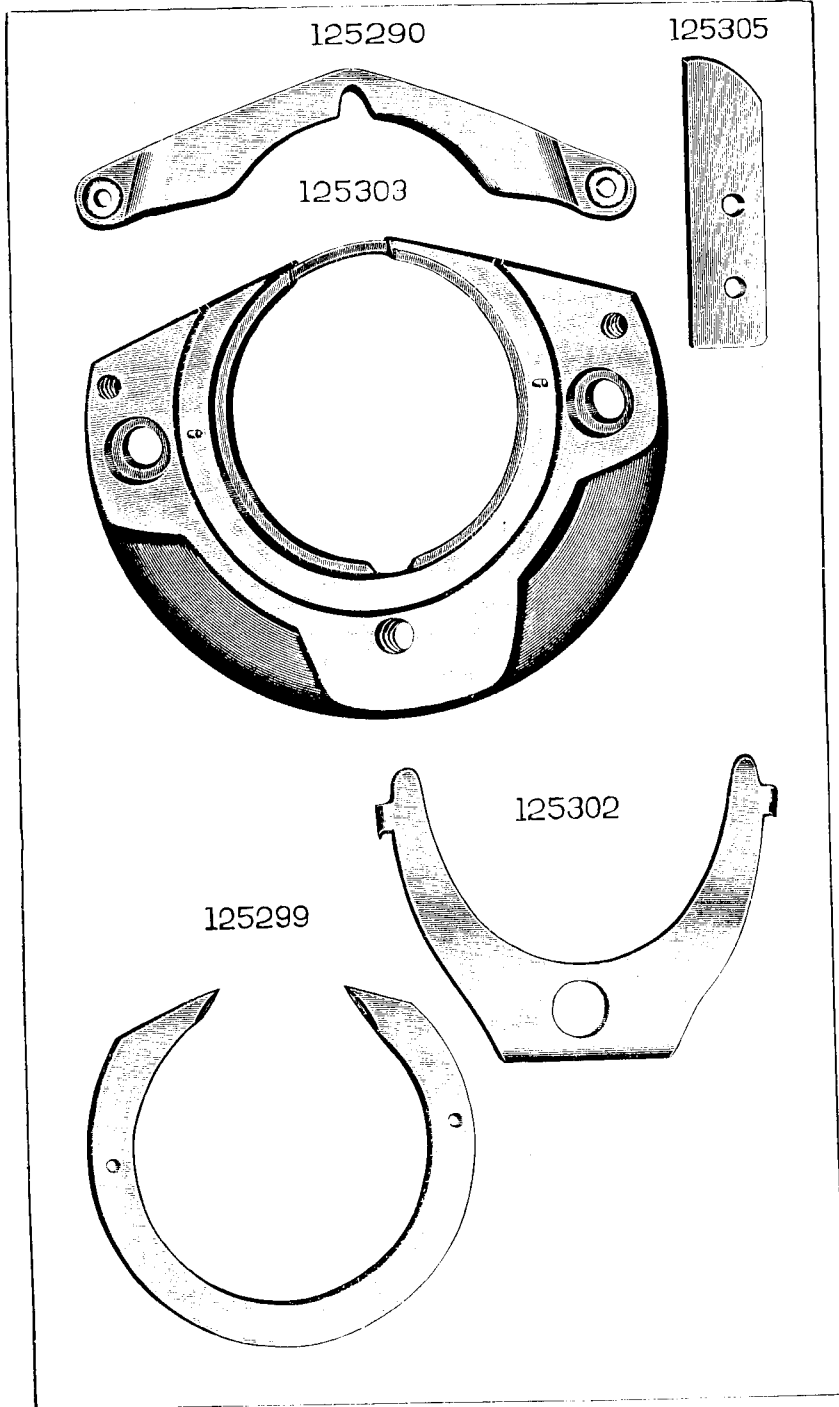

125308

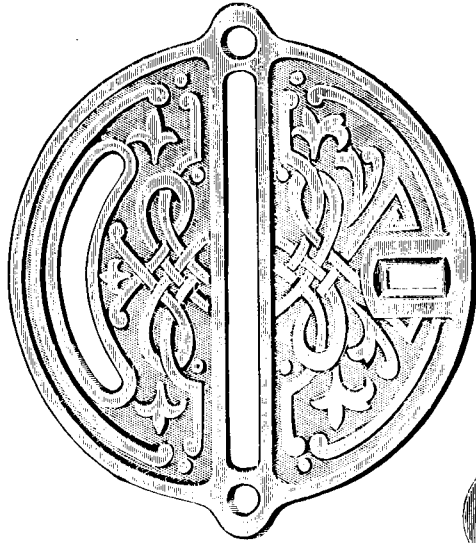

125369



125269



125361

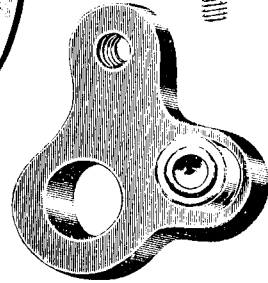

125307

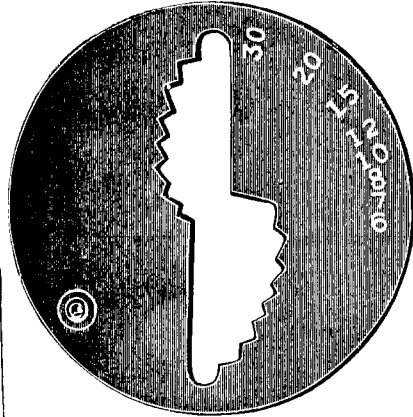

38391



125347

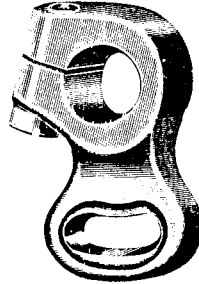

125349



125276



125283

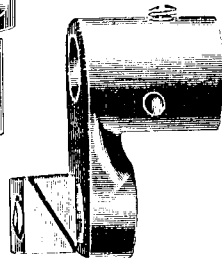

125268

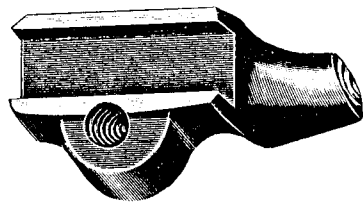

125377

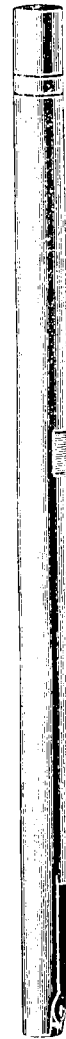

55621

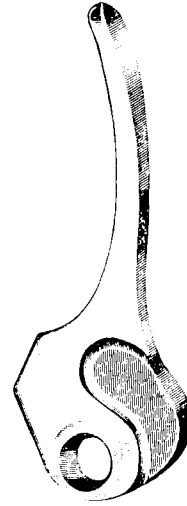

125272



125382

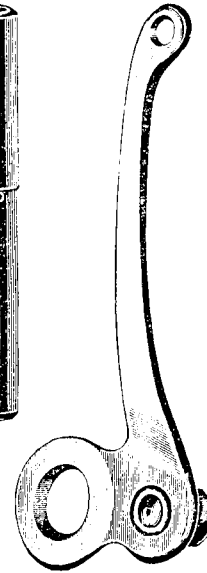

125317



125258

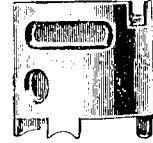

125316

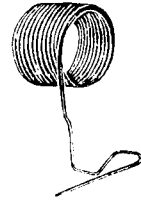

45285



125378



45321

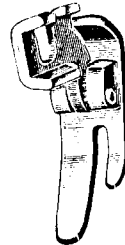

121441

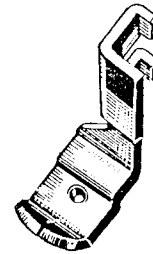



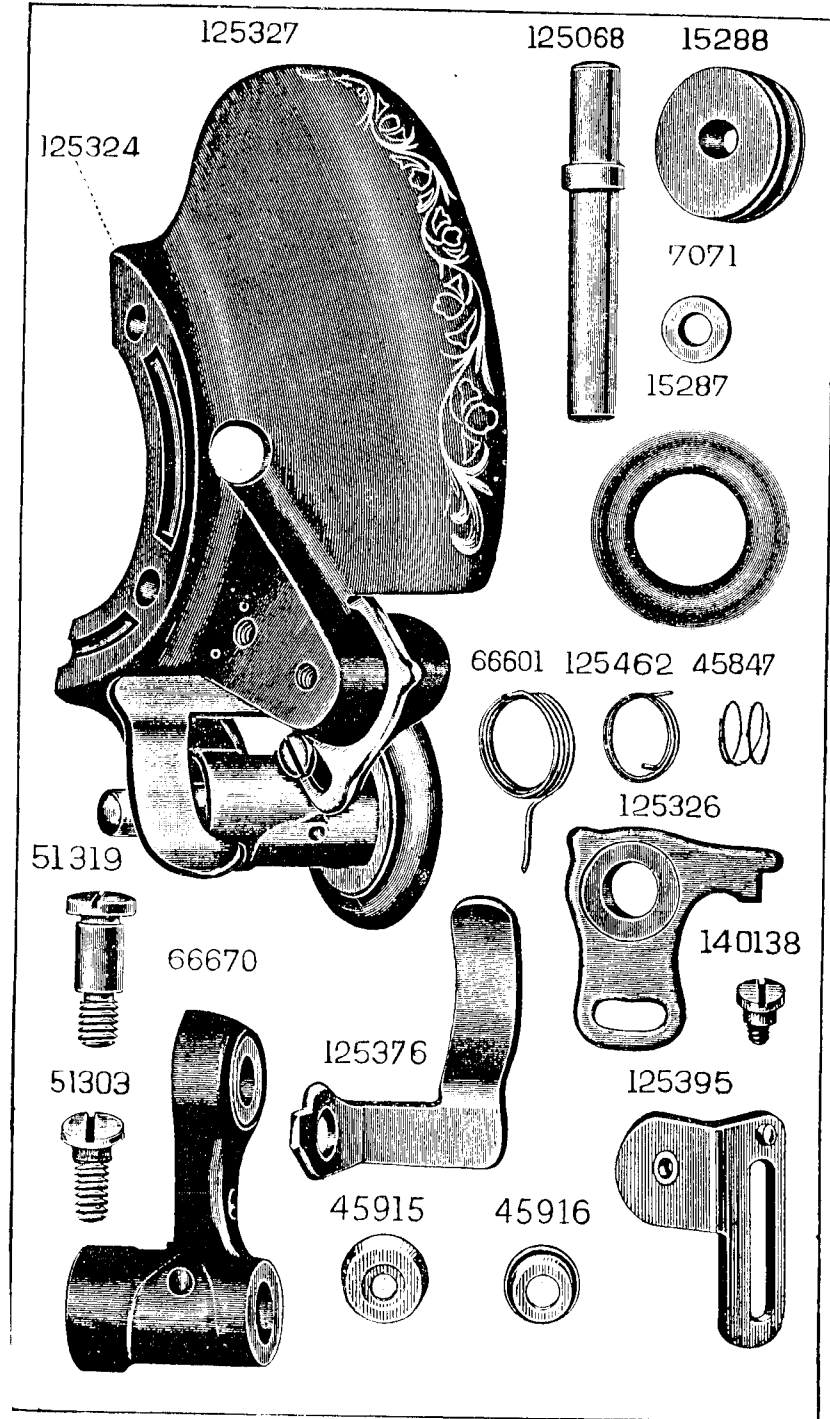
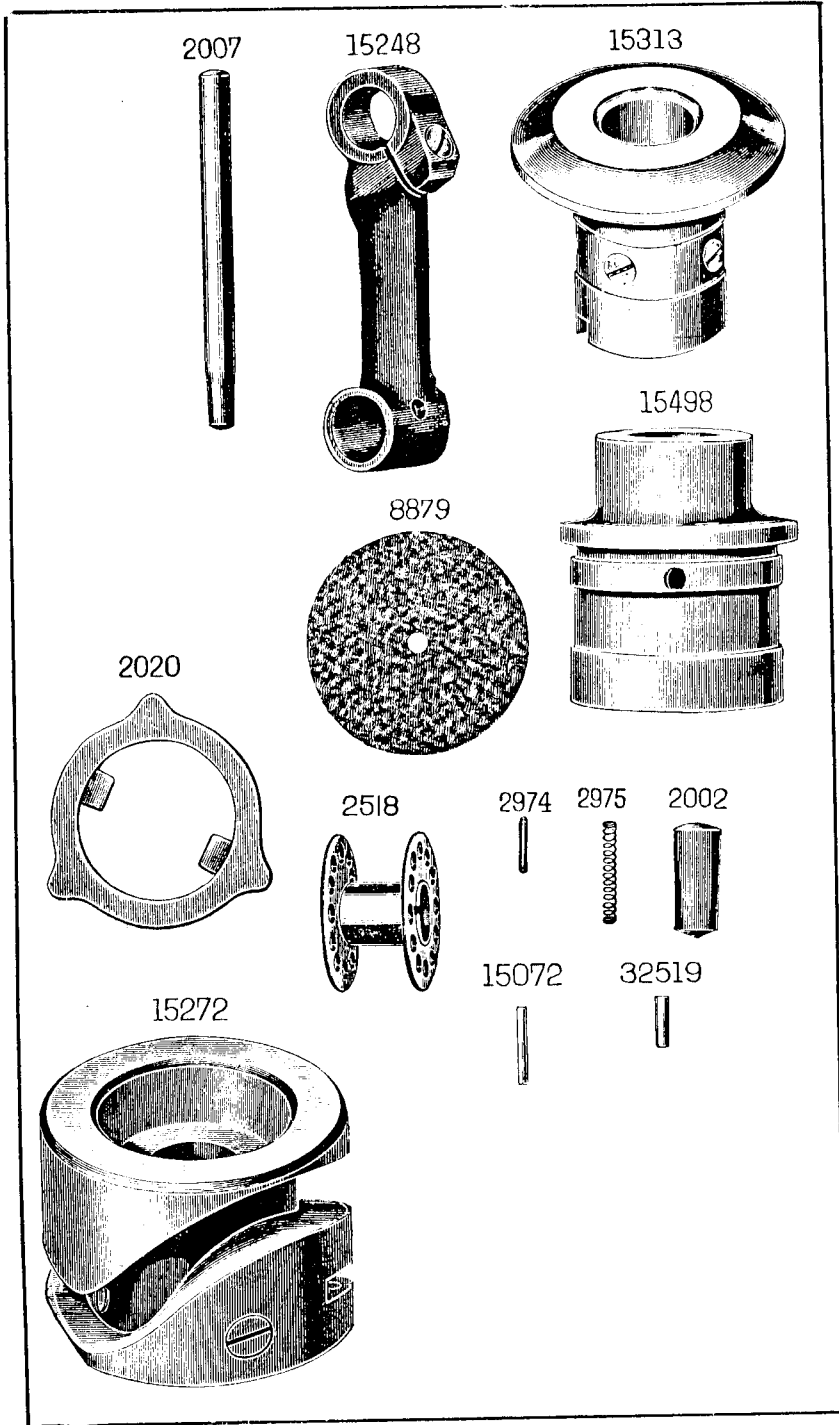

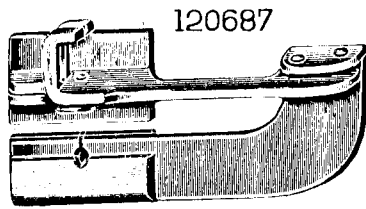

120687

85893



36583

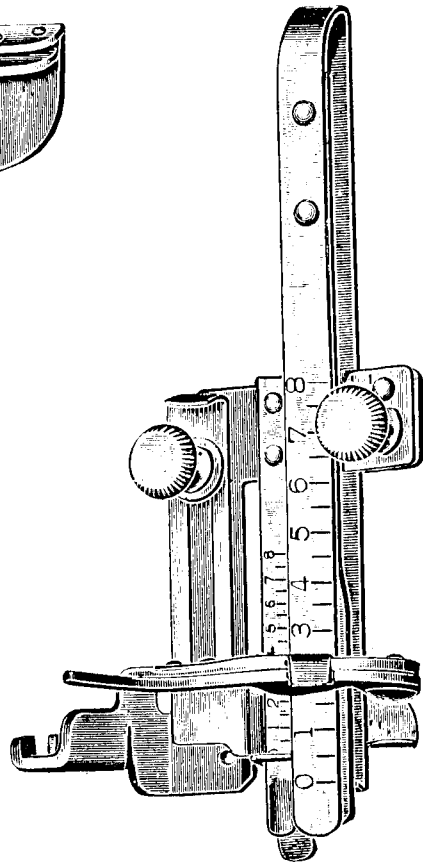

138



145



157



158



175



183



190



193



208



248

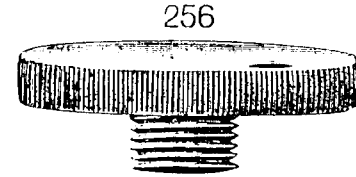

256



304



315



335



375



391



399



435



448



453



462

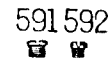

591 592



570



662



691



857



896



1085



1253



1285

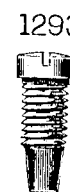

1293



SS528



50053



50292



50353



50527



51002



51224

714



1341



1498



51045



51229



51246



51252

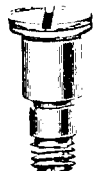

140545



51289



51261

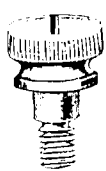

51282

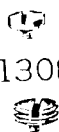

51308

1813



1513

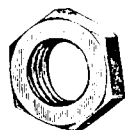

1518



1519



1822



1520



1735



45306

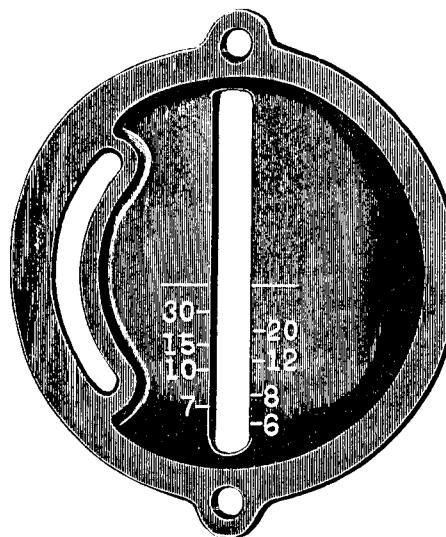

45305



51312



45310



1550



125387

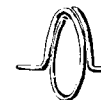

45308

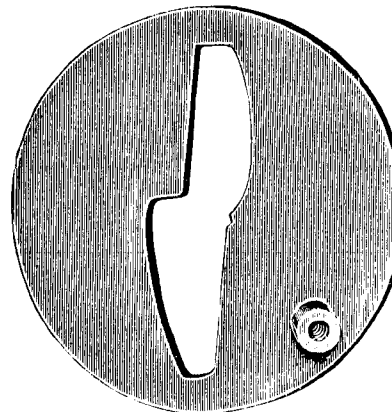

125388

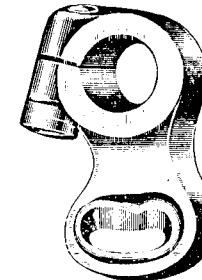

125386

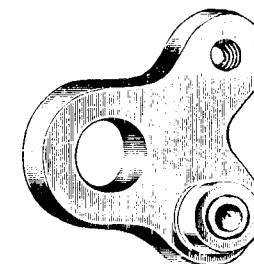

193586

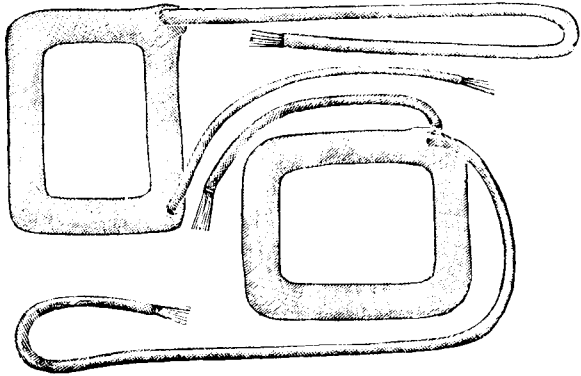

193561

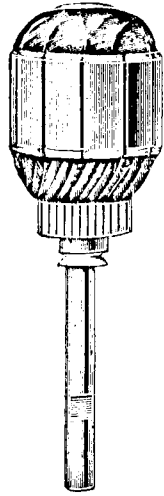

192542

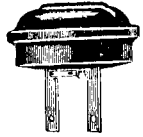

192541



192543



198052

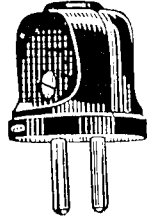

97382



97384

97383

51280

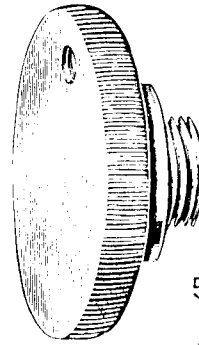

125359

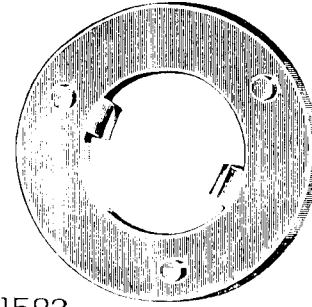

125365



194113

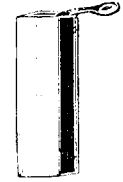

125385



51582



246



51093



51319



192793



192691



192692



701719



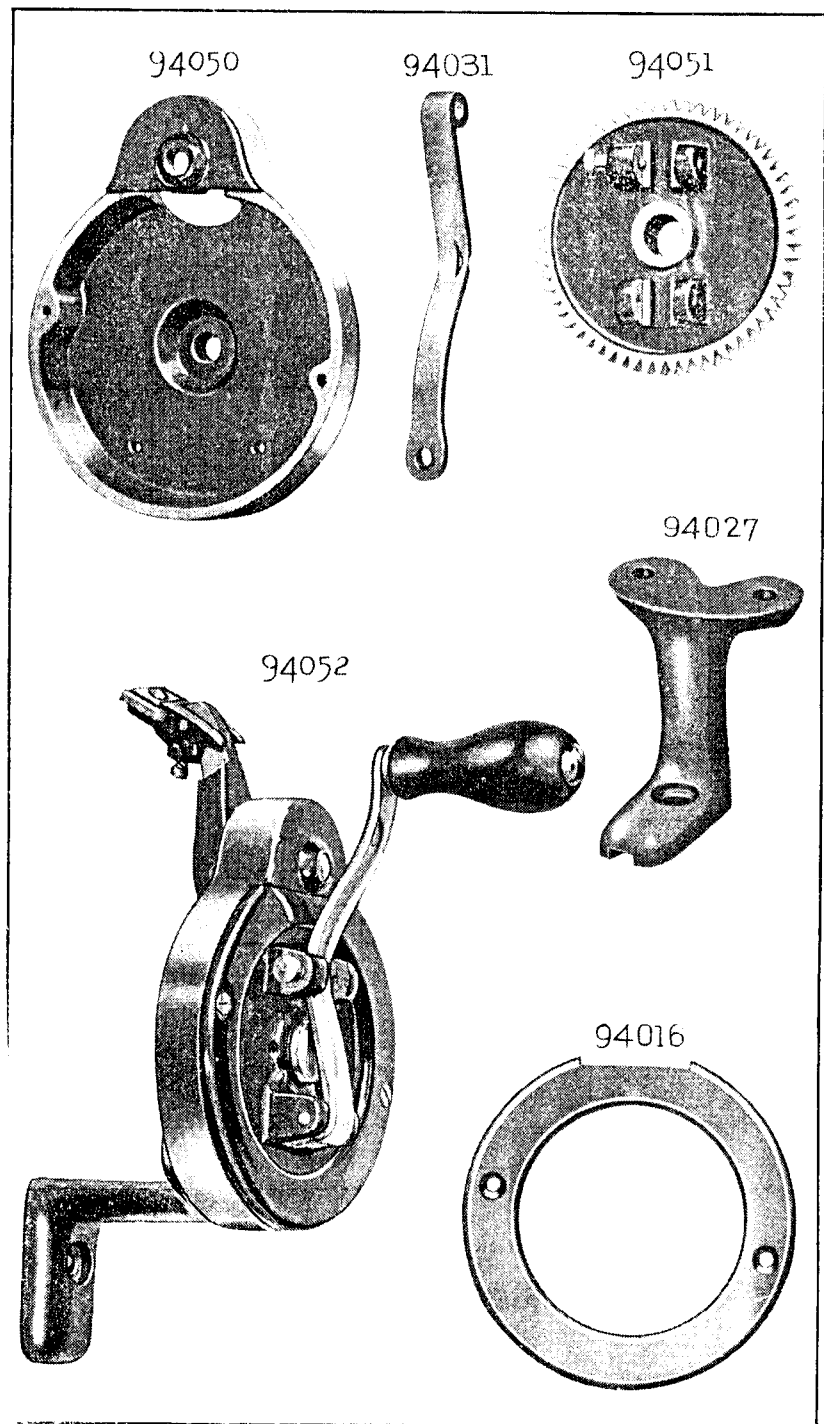
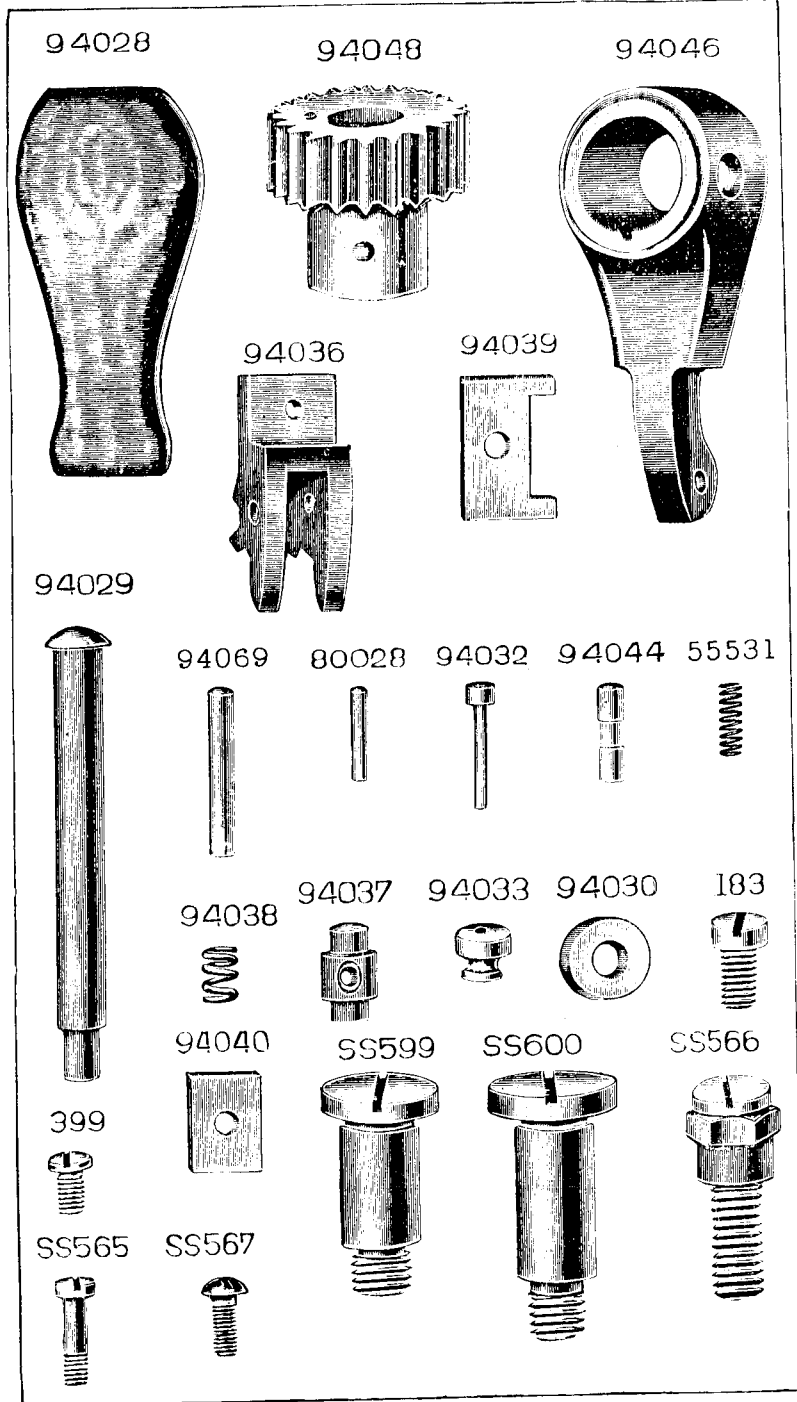

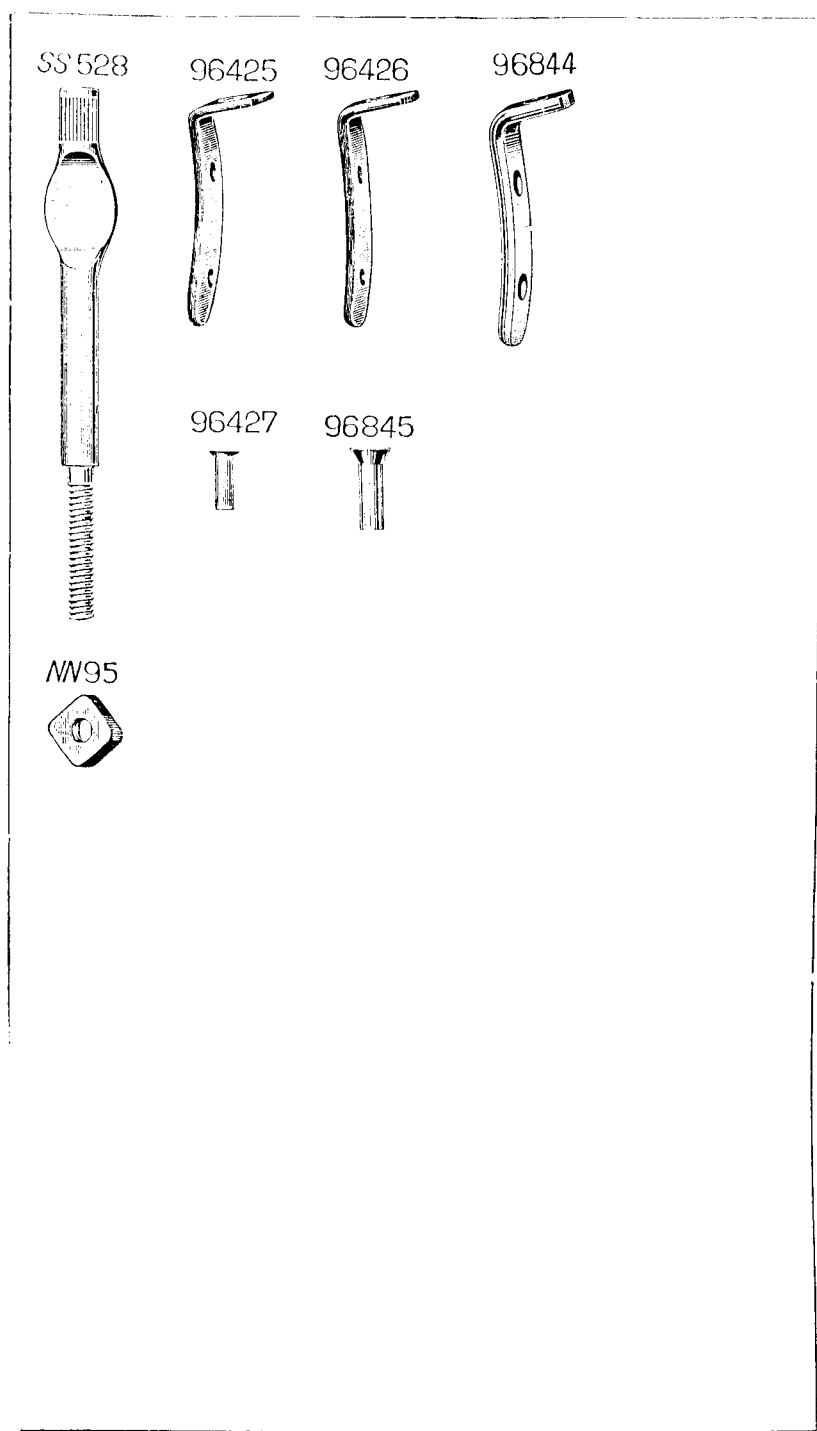
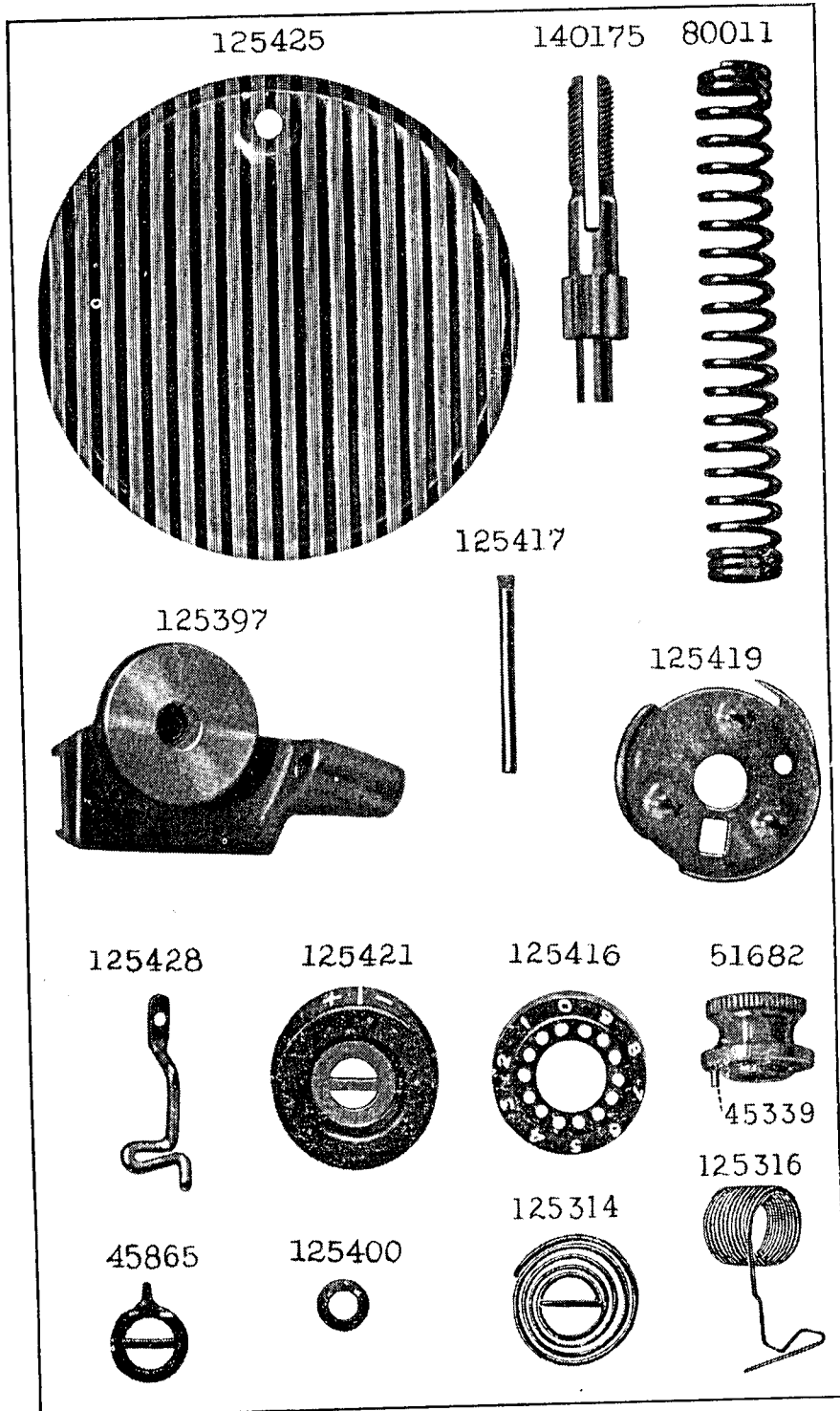

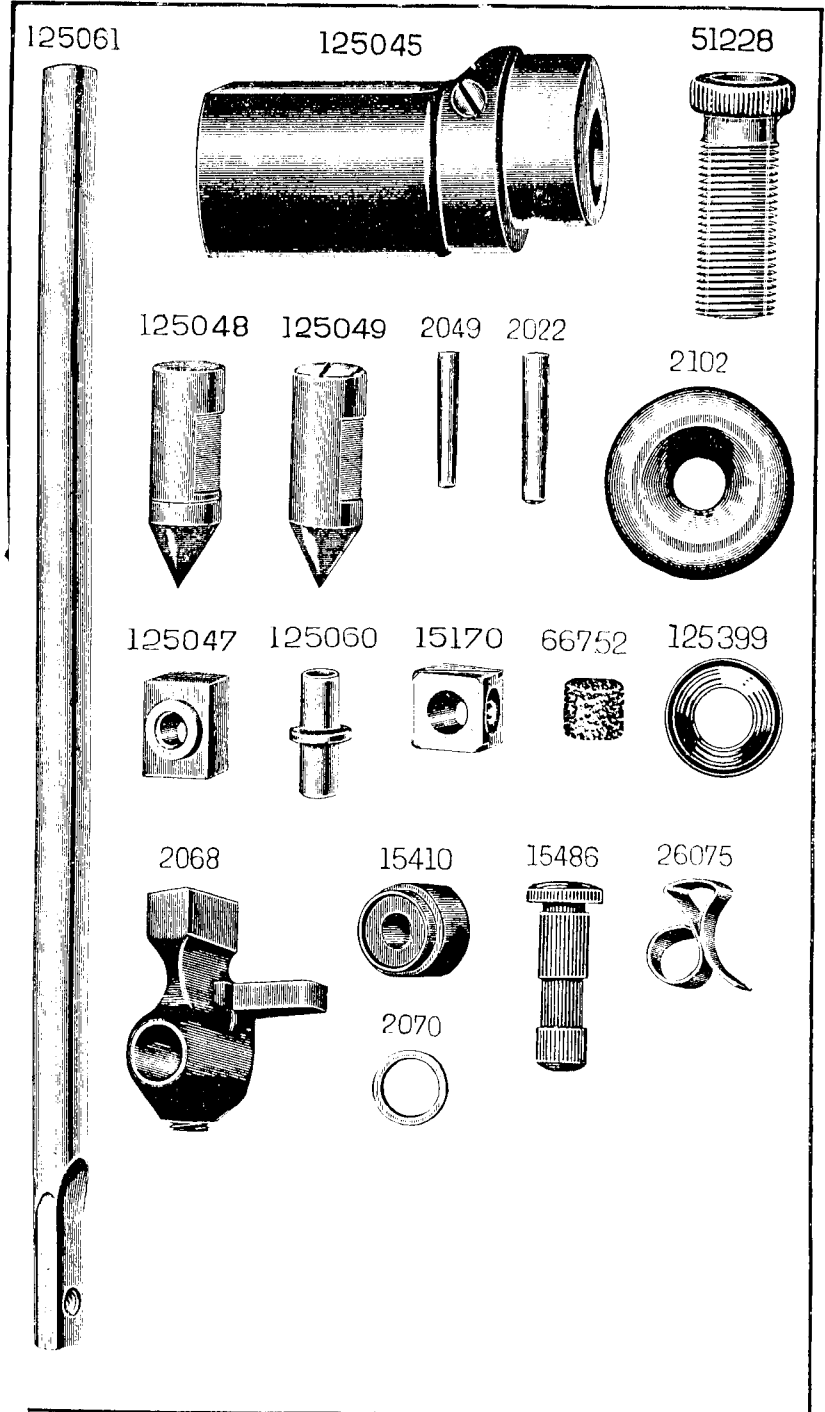
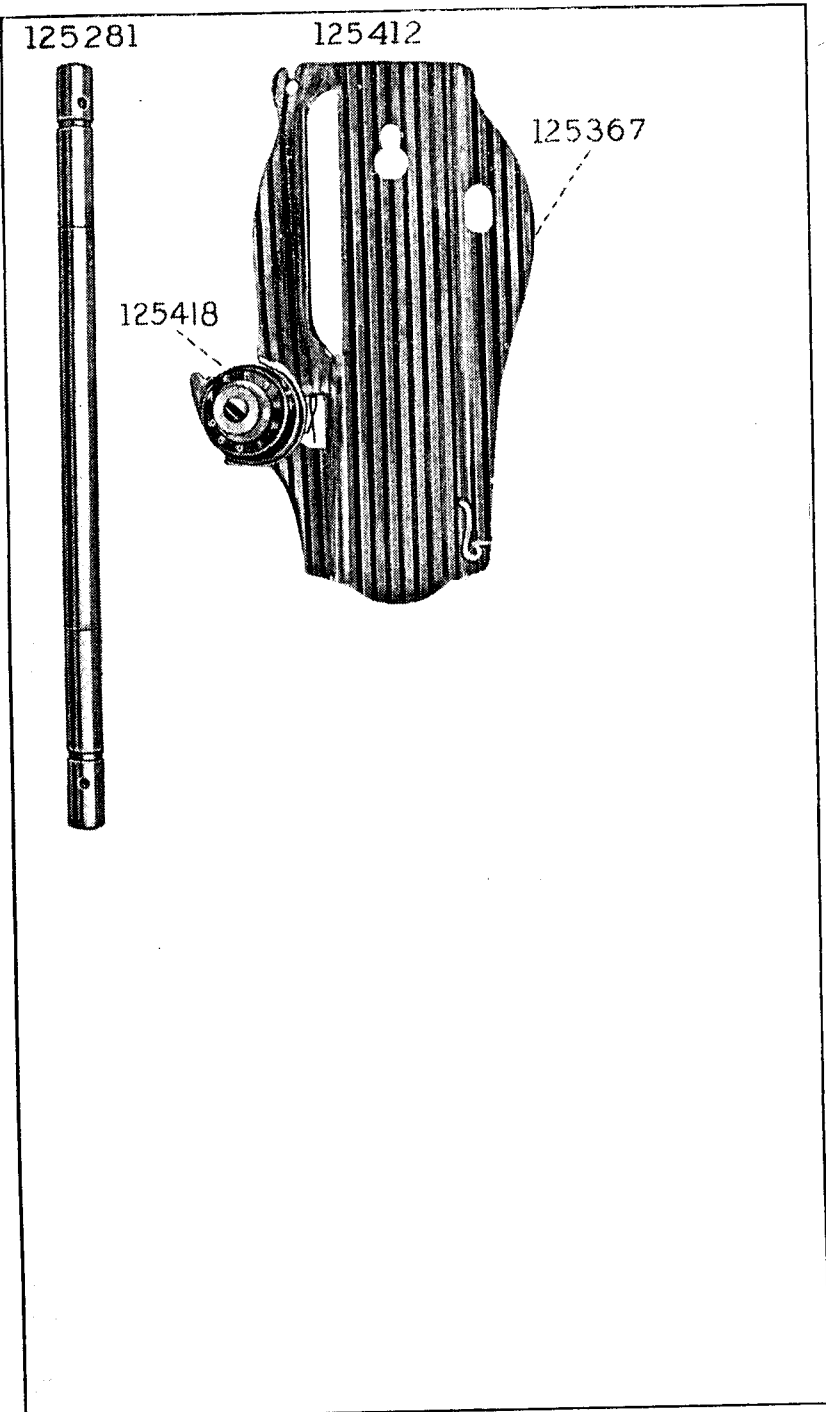

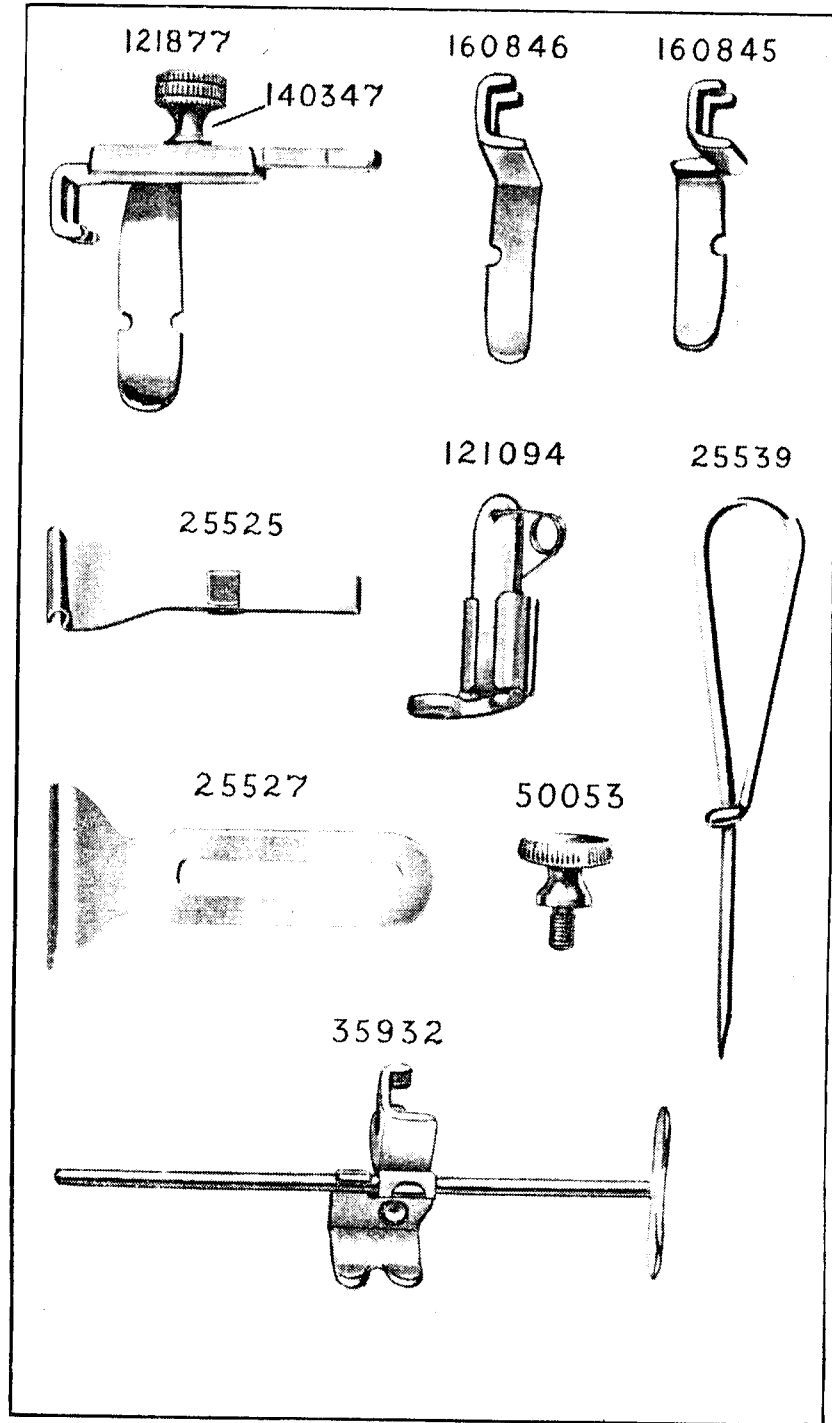
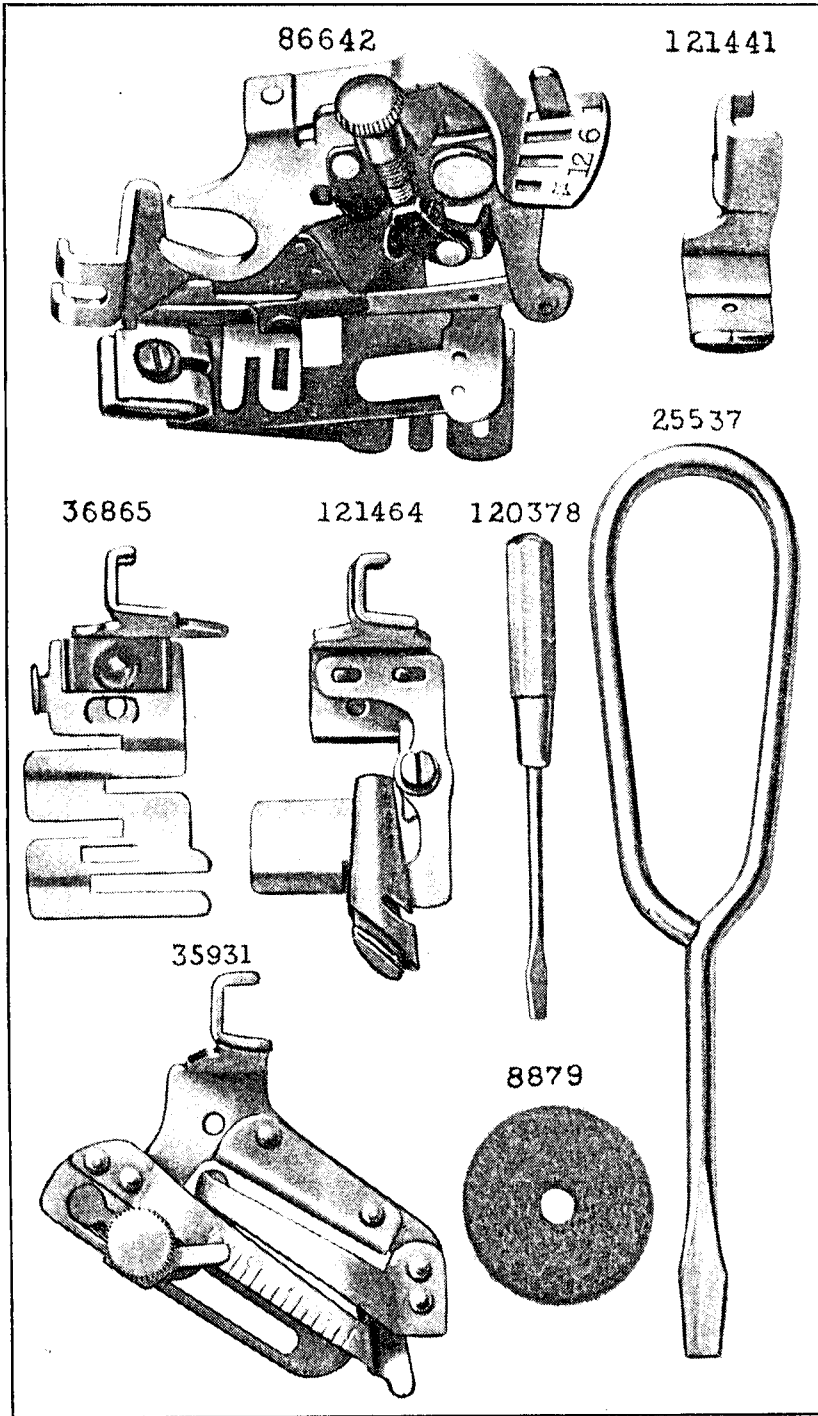
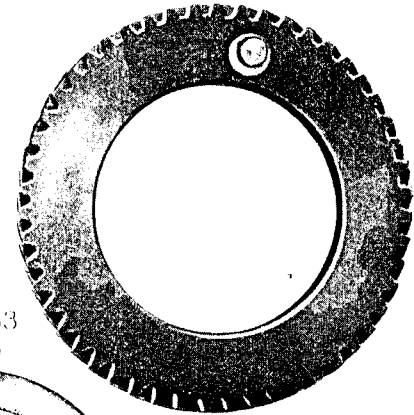

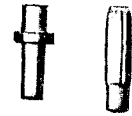

PLATE 4956 - FULL SIZE

125352



125356 125358



125353

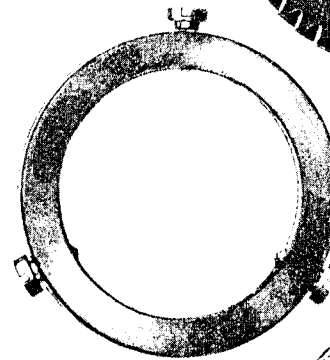

51281 125357



125354

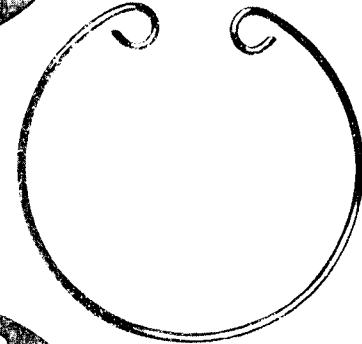

125355

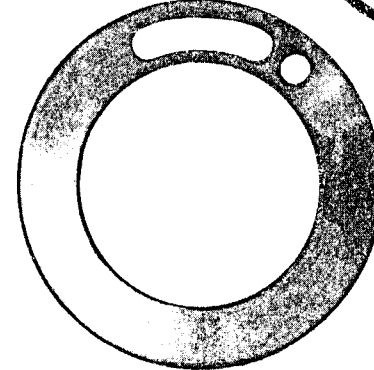

### PLATE 4959—FULL SIZE

193523



193529



193524



192457



192458



193640



193546



192459

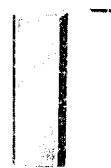

193542



727511



192790



193527



193526



51284



193543



51285



50617



51286



447



224



882



1768



192424

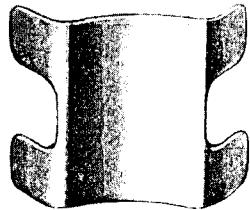

### PLATE 4960—ONE-HALF SIZE

193555

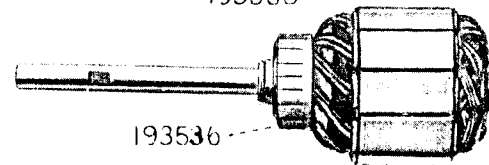

193536

193541

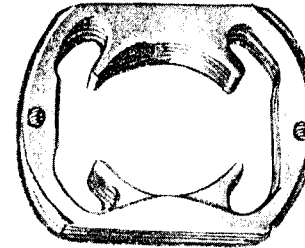

125350

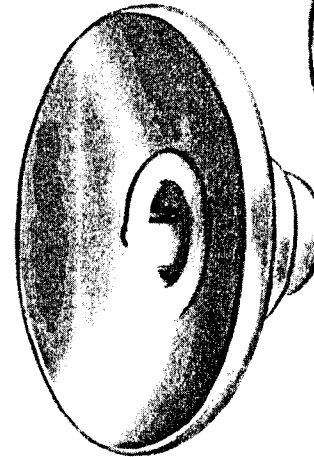

193544

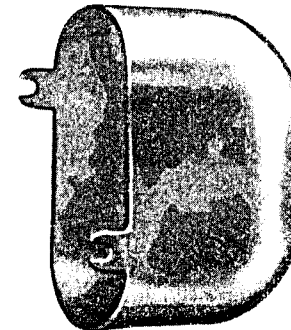

193545

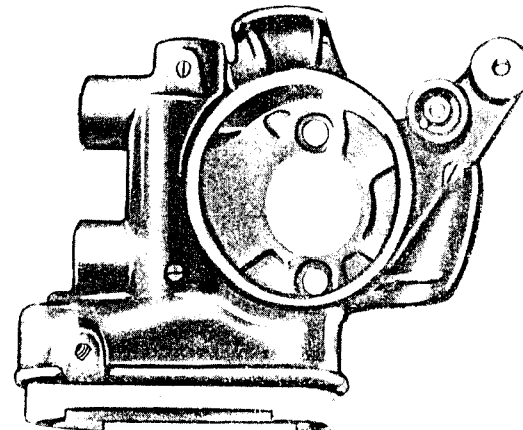
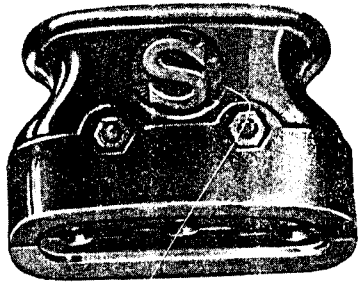
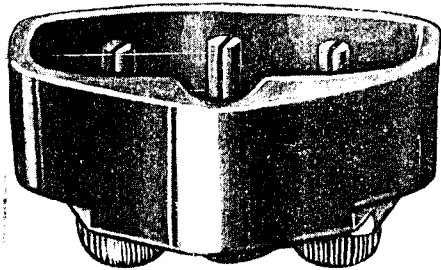

PLATE 4964—FULL SIZE

192989



192797



193629

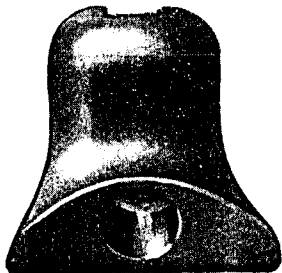

50657



51293



## CONTENTS

---

	Page
Parts complete for 15K88 to 15K90 Machines	47
Parts special to 15K91 Machine	53
Attachments	63
Bobbin Winder	61
Embroidery Hoops	65
Hand Attachment	66
Numerical List of Parts	75
Obsolete Parts	67

## LIST OF PARTS

FOR

# 15K88 to 15K91 Machines

# INSTRUCTIONS FOR ORDERING

In ordering from this List, the prefix and affix letters with the part number **MUST BE** quoted exactly as they are shown in the first column.

**A** number always indicates the same part in whatever List it may appear, or for whatever machine.

The affix letters (where shown) indicate the style of finish, as follows:—

- A. Hardened, Polished, Nickel Plated and Buffed.
- B. Polished, Nickel Plated and Buffed.
- C. Hardened only.
- D. Polished only.
- E. Soft, Not Polished.
- F. Hardened and Polished.
- G. Bright Rumbled and Nickel Plated.
- H. Blued.
- J. Nickel Plated only.
- K. Hardened and Nickel Plated.
- L. Brass Plated.
- M. Oxidized.
- R. Phosphate Coating Formed on Surface of Iron or Steel.
- S. Cadmium Plated.
- T. Copper Plated.
- U. Zinc Plated.
- V. Silver Plated.
- W. Polished and Nickel Plated.
- X. Black Oxide for Iron and Steel.
- Y. Black Nickel Plated only.
- Z. Chromium Plated.
- A.A. Buffed and Chromium Plated.
- A.B. Hardened, Polished, Buffed and Chromium Plated.
- A.E. Hardened, Bright Rumbled and Nickel Plated.
- A.F. Hardened, Bright Rumbled, Nickel Plated, Bright Rumbled and Chromium Plated.
- A.G. Alumilite (Plain).
- A.H. Alumilite (Dyed). Colour must be stated.
- A.J. Polished, Nickel Plated and Chromium Plated.
- A.K. Hardened, Polished, Nickel Plated and Chromium Plated.
- A.L. Heat Treated for Toughness.
- A.L.D. Heat Treated for Toughness and Polished.
- A.L.X. Heat Treated for Toughness and Black Oxide.
  - A.S. Black Moulded Phenolic.
  - A.T. Beige Moulded Phenolic.
  - A.U. Brown Moulded Phenolic.
- A.W. Hardened then Flame Coated with Tungsten Carbide.
- B.A. Chrome Nickel, Satin Finish.
- B.B. Hardened and Chrome Nickel, Satin Finish.
- C.R. Hardened and Phosphate Coating Formed on Surface of Steel.
- C.U. Hardened and Zinc Plated.
- F.J. Hardened, Polished and Nickel Plated.
- T.A. Hardened, Polished, Copper and Nickel Plated and Buffed.
- T.B. Copper and Nickel Plated and Polished.
- T.J. Copper and Nickel Plated only.
- T.K. Hardened, Copper and Nickel Plated.
- T.L. Copper and Brass Plated.
- T.M. Copper Plated and Oxidized.
- X.C. Hardened and Black Oxide for Iron and Steel.
- Z.A. Hardened, Polished, Nickel Plated, Buffed and Chromium Plated.
- Z.B. Polished, Nickel Plated, Buffed and Chromium Plated.
- Z.C. Hardened and Chromium Plated.
- Z.D. Polished and Chromium Plated.
- Z.G. Bright Rumbled, Nickel Plated, Bright Rumbled and Chromium Plated.
- Z.J. Nickel and Chromium Plated.
- Z.T. Copper and Chromium Plated.

*Parts marked with an asterisk (\*) are furnished only when the repairs are made at Factory.*

## PARTS COMPLETE

FOR

### Nos. 15K88 to 15K90 MACHINES

#### C.B. Shuttle, Reverse Feed, Balanced Machine, for Family Use.

No.	Plate						
		<b>Arm</b>	...	...	...	...	...
25251	--	"	125251, with 435c, 448c, 15186 and 15198	...	...	...	...
25252		"	Dowel Pin (2)	...	...	...	...
2002	1954	"	Oil Pad (felt), for oiling Arm Shaft Back Bearing	...	...	...	...
25331	1949	"	" " Spring	...	...	...	...
25333	1949	"	" " " Cap	...	...	...	...
25334	1949	"	" " " " Screw (3)	...	...	...	...
138e	1957	"	Shaft	...	...	...	...
15253	1947	"	" " 125253 with 15434, 15498 and 125045	...	...	...	...
5254		"	" " Bushing	...	...	...	...
5498	1954	"	" " " Set Screw	...	...	...	...
435c	1957	"	" " Side Cover	...	...	...	...
5425b	2391	"	" " " Thumb Screw	...	...	...	...
1224b	1957	"	" " " Spool Pin	...	...	...	...
2007	1954	"	" " " "	...	...	...	...
5255		<b>Bed</b>	...	...	...	...	...
256b	1957	<b>Clamp Stop Motion Clamp Screw</b>	...	...	...	...	...
248a	1957	"	" " " " Stop Screw	...	...	...	...
2020	1954	"	" " " " Washer	...	...	...	...
312		"	" " " Flanged Bushing	...	...	...	...
313	1954	"	" " " " 15312 with two 462al	...	...	...	...
022	2552	"	" " " " Pin	...	...	...	...
462al	1957	"	" " " " Set Screw	...	...	...	...
314		<b>Clamp Stop Motion, complete, Nos. 248a, 256b, 2020 and</b>	...	...	...	...	15313
021	1947	<b>Crank Connecting Rod with 125012, 125044 and two 896c</b>	...	...	...	...	...
012		"	" " " " Cap	...	...	...	...
896c	1957	"	" " " " Screw	...	...	...	...
375c	1957	"	" " " " Hinge Screw	...	...	...	...
518j	1958	"	" " " " " Nut	...	...	...	...
044	1949	"	" " " " Oil Pad (felt)	...	...	...	...
367	2551	<b>Face Plate</b>	...	...	...	...	...
84		"	" " 125367 with 15410, 125258 and 125369	...	...	...	...
68		"	" " 125384 with 857b, 50292b and 125317	...	...	...	...
58	1951	"	" " Tension Seat	...	...	...	...
28	2391	"	" " Thread Guard	...	...	...	...
69	1950	"	" " " " 125428 with 125373	...	...	...	...

No.	Plate			No.	Plate
125373	--	<b>Face Plate</b>	Thread Guard Rivet ...	125386	1960
125412	2551	" "	125368 with 125418 ...	125349	1950
190b	1957	" "	Screw ...	1813	1958
				125387	1960
2835	792	<b>Feed Bar</b>	... ..	51289j	1958
315c	1957	" "	Screw Centre (2) ...	15282	1152
1519j	1958	" "	" " Nut (2) ...	32672	1722
125045	2552	<b>Feed Cam and Counterbalance</b>	with 1285c ...	51045c	1958
1285c	1957	" "	" " Position Screw ...	25377	1951
125261	1946	<b>Feed Dog, 12 teeth (14 teeth to the inch)</b>	... ..	25272	1951
208al	1957	" "	Screw (2) ...	25273	
				25274	1949
125262	1947	<b>Feed Forked Connection</b>	with 175j ...	1498c	1958
125340		" "	" " 125262 with 125335 ...	15248	1954
175j	1957	" "	" " Adjusting Screw ...	25275	
51252c	1958	" "	" " Hinge Screw (eccentric) ...	51002c	1957
1520j	1958	" "	" " " Nut ...	570c	1957
125047	2552	" "	" " Slide Block ...	1520j	1958
125335		" "	" " 125047 with 1085c ...	5276	1950
1085c	1957	" "	" " Screw Stud ...	1341c	1958
				5334	
125263	1947	<b>Feed Lifting Rock Shaft</b>	... ..	5285	1951
125388	1960	" "	" " Crank with 157j ...	5378	1951
157j	1957	" "	" " Clamping Screw ...	1308j	1958
125389		" "	" " complete, Nos. 51289j and 125386 to 125388 ...	0515c	1958
				9519	1954
125390		" "	" " complete, Nos. 125263, 125349 and 125389 ...	5280	1947
304c	1957	" "	" " Screw Centre (2) ...	5048	2552
125344		" "	" " 304c with 1513j (2) ...	1246c	1958
1513j	1958	" "	" " Nut (2) ...	5049	2552
				1246c	1958
125397	2391	<b>Feed Regulator</b>	... ..	3056	1949
125398		" "	125397 with 125381 ...	281	2551
50353c	1957	" "	" " Hinge Screw ...	363	
125399	2552	" "	" " Friction Washer ...	323	
				282	
45305	1960	<b>Feed Reversing Handle</b>	... ..	283	1950
125381		" "	" " 45305 with 1550j ...	284	
1550j	1960	" "	" " Lock Nut ...	049	2552
				462al	1957
125270	1947	<b>Feed Rock Shaft</b>	... ..	170	2552
304c	1957	" "	" " Screw Centre (2) ...	330	
125344		" "	" " 304c with 1513j (2) ...	060	2552
1513j	1958	" "	" " Nut (2) ...		

<b>Feed Throw-out Lever</b>	with 1813	...	...	...
"	"	"	Retaining Ring	...
"	"	"	Roller and Stud	...
"	"	"	Spring	...
"	"	"	Thumb Screw	...
<b>Hand Wheel, 2 1/4" pulley,</b>	for 15K88 and 15K89 Machines	...	...	...
"	"	3 1/4" pulley,	for 15K90 Machine	...
<b>Machine Hinge Connection Set Screw</b>	(2)	...	...	...
<b>Needle Bar</b>	with 92519	...	...	...
"	"	Bushing	...	...
"	"	"	125272 with 125274	...
"	"	"	Oil Pad (felt)	...
"	"	"	Set Screw	...
"	"	"	Connecting Link with 51002c	...
"	"	"	" 15248 with 125276	...
"	"	"	" Adjusting Screw	...
"	"	"	" Hinge Screw	...
"	"	"	" " " Nut	...
"	"	"	Stud with 1341c	...
"	"	"	Set Screw	...
<b>Needle Clamp</b>	with 140545c	...	...	...
"	"	45334 with 51308j	...	...
"	"	Gib and Thread Guard	...	...
"	"	Position Screw	...	...
"	"	Thumb Screw	...	...
"	"	Stop Pin	...	...
<b>Oscillating Rock Shaft</b>	with 125056	...	...	...
"	"	"	Centre (left)	...
"	"	"	" ( " ) Set Screw	...
"	"	"	" (right)	...
"	"	"	" ( " ) Set Screw	...
"	"	"	Oil Wick (braided cotton)	...
<b>Oscillating Shaft</b>	...	...	...	...
"	"	125281 with 2049 and 125295	...	...
"	"	125363 with 125283, 125298 and two 51229e	...	...
"	"	Crank	...	...
"	"	"	125282 with 462al and 125330	...
"	"	"	125282 with 125330 and two 462al	...
"	"	"	Pin	...
"	"	"	Set Screw	...
"	"	"	Slide Block	...
"	"	"	" " 15170 with 125060	...
"	"	"	Stud	...

No.	Plate						
125061	2552	<b>Presser Bar</b>	...	...	...	...	...
55621	1951	"	"	Lifter	...	...	...
15486	2552	"	"	"	Hinge Stud	...	...
448c	1957	"	"	"	"	Set Screw	...
80011	2391	"	"	"	Spring	...	...
2068	2552	"	"	"	Bracket with 453c	...	...
453c	1957	"	"	"	"	Set Screw	...
2070	2552	"	"	"	Washer	...	...
45329	-	<b>Presser Foot</b>	Hinge Pin	...	...	...	...
45319	-	"	"	Plate	...	...	...
*32774	-	"	"	Shank	...	...	...
45321	1951	<b>Presser Foot</b>	(hinged), complete, Nos. 32774, 45319 and 45329				
<i>NOTE.—No. 45321 is sent with machine unless otherwise specified on order.</i>							
125285	1946	<b>Presser Foot</b>	...	...	...	...	...
51224b	1957	"	"	Thumb Screw	...	...	...
*51228b	2552	<b>Pressure Regulating Thumb Screw</b>	...	...	...	...	...
66773	-	"	"	"	"	51228b with 66752	...
66752	2552	"	"	"	"	Plug (felt)	...
2518	1954	<b>Shuttle Bobbin</b>	...	...	...	...	...
125287	1949	"	"	"	Case Latch	...	...
125320	1949	"	"	"	"	Lever	...
2974	1954	"	"	"	"	Fulcrum Pin	...
2975	1954	"	"	"	"	Spring	...
592e	1957	"	"	"	"	Stop Screw	...
125288	-	"	"	"	"	Hinge, Nos. 2974, 125287 and 125320	...
125290	1948	"	"	"	"	Position Plate	...
391j	1957	"	"	"	"	"	...
125291	1949	"	"	"	"	with 591f, 592e, 2975, 125288 and 125293	...
125292	1949	"	"	"	"	Body	...
591f	1957	"	"	"	"	Tension Regulating Screw	...
125293	1949	"	"	"	"	Spring	...
125294	-	<b>Shuttle</b> , 1 $\frac{1}{8}$ " diam., complete, Nos. 2518, 125291 and 125292	...	...	...	...	...
*125295	1949	<b>Shuttle Driver</b>	...	...	...	...	...
125297	-	"	"	"	"	125295 with two 1253c	...
125322	1949	"	"	"	"	125297 with 125298 and two 51229e	...
125298	1949	"	"	"	"	Cushion Spring	...
51229e	1958	"	"	"	"	"	Screw
2049	2552	"	"	"	"	Pin	...
1253c	1957	"	"	"	"	Set Screw	...

No.	Plate						
125299	1948	<b>Shuttle Race Back</b>	.....	...	...	...	...
125301	1949	"	"	"	Position Pin	...	...
125302	1948	"	"	"	Spring	...	...
51261j	1958	"	"	"	"	Thumb Screw	...
125303	1948	"	"	"	Body	...	...
125304	-	"	"	"	"	125303 with 125305 and two 662j	...
125300	-	"	"	"	"	125304 with 125290, two each 391j and 125301	...
125305	1948	"	"	"	Cap	...	...
662j	1957	"	"	"	"	Screw	...
125306	-	<b>Shuttle Race</b> , complete, Nos. 51261j, 125299, 125300 and 125302	...	...	...	...	...
145j	1957	"	"	"	"	Screw (2)	...
125336	1946	<b>Shuttle Race Slide</b>	...	...	...	...	...
125337	1946	"	"	"	Spring	...	...
51282j	1958	"	"	"	"	Screw	...
125338	-	<b>Shuttle Race Slide</b> , complete, Nos. 125336, 125337 and two 51282j	...	...	...	...	...
45306	1960	<b>Stitch Indicator Plate</b>	...	...	...	...	...
335b	1957	"	"	"	"	Screw (2)	...
<del>45307</del>	-	<del>Regulating Plate</del>	...	...	...	...	...
45308	1960	"	"	"	"	<del>45307 with 45289</del>	...
45309	-	"	"	"	"	45308 with 45306, 45310, 51312b and 125400	...
51312b	1960	"	"	"	"	Thumb Screw	...
<del>45289</del>	-	<del>Bushing</del>	...	...	...	...	...
125400	2391	"	"	"	"	Friction Washer	...
45310	1960	"	"	"	"	Washer (fibre)	...
2102	2552	<b>Tension Disc</b>	...	...	...	...	...
125421	2391	"	"	"	"	Indicator	...
125416	2391	"	"	"	"	Flange	...
45865	2391	"	"	"	"	Stop Washer	...
51682b	2391	"	"	"	"	Regulating Thumb Nut with 45339	...
45339	2391	"	"	"	"	"	Engaging Pin
125417	2391	"	"	"	"	Releasing Pin	...
125314	2391	"	"	"	"	Spring	...
140175c	2391	"	"	"	"	Stud	...
125420	-	"	"	"	"	140175c with 51682b	...
15410	2552	"	"	"	"	Bushing	...
50292b	1957	"	"	"	"	Set Screw	...
25418	-	<b>Tension</b> , complete, Nos. 45865, 125314, 125316, 125416, 125417, 125419 to 125421 and two 2102	...	...	...	...	...
26075	2552	<b>Thread Cutter and Holder</b>	...	...	...	...	...

No.	Plate						
15272	1954	<b>Thread Take-up Cam</b>	with 1293al	...	...	...	...
*15434	---	"	"	"	15272 with 570c and 1520j	...	...
1293al	1957	"	"	"	Timing Screw	...	...
*125382	1951	<b>Thread Take-up Lever</b>	with 1822	...	...	...	...
125383	---	"	"	"	125382 with 50527c	...	...
50527c	1957	"	"	"	Hinge Screw	...	...
1822	1958	"	"	"	Roller and Stud	...	...
125316	2391	<b>Thread Take-up Spring</b>		...	...	...	...
125317	1951	"	"	"	Regulator	...	...
857b	1957	"	"	"	" Set Screw	...	...
125419	2391	"	"	"	Thread Guard	...	...
125319	1946	<b>Throat Plate</b>	for 125261	...	...	...	...
691a	1957	"	"	"	Screw (2)	...	...
125029	---	<b>Drip Pan</b>	(for Cover Set)	...	...	...	...

## PARTS SPECIAL

TO

### No. 15K91 MACHINE

(OBSOLETE)

**C.B. Shuttle ; Reverse Feed ; Balanced Machine ; Solid Hand Wheel ;  
P.G. Motor and SINGER Light ; for Family Use.**

This machine is the same as No. 15K88 with the following exceptions :

No.	Plate						
51280b	2091	<b>Clamp Stop Motion Clamp Screw</b>		...	...	...	...
246a	2091	"	"	"	"	Stop Screw	...
125359	2091	"	"	"	"	Washer	...
125360	1949	"	"	"	"	Flanged Bushing	...
*125371	---	"	"	"	"	"	125360 with 51280b
125372	---	"	"	"	"	"	125360 with two 462al
125350	4960	<b>Hand Wheel</b>	with 125358	...	...	...	...
125364	---	"	"	"	"	125350 with 125352 to 125355 and two 125385	...
125351	---	"	"	"	"	Gear (textolite)	...
125352	4956	"	"	"	"	125351 with 125356 and 125357	...
125353	4956	"	"	"	"	Collar with three 51281c	...
51281c	4956	"	"	"	"	Set Screw	...
125354	4956	"	"	"	"	Spring	...
125385	2091	"	"	"	"	Cushion Pin (eccentric)	...
125355	4956	"	"	"	"	Retaining Washer	...
125356	4956	"	"	"	"	Stud	...
125357	4956	"	"	"	"	" Washer	...
125358	4956	"	"	"	"	Spring Stud	...



## MOTOR PARTS

No.	Plate	
193555	4960	Armature, complete, for P.G.K. 3 Motor
193556	---	" " " P.G.K. 5 Motor
193557	---	" " " P.G.K. 6 Motor
193557	---	" " " P.G.K. 7 Motor
193558	---	" " " P.G.K. 8 Motor
193559	---	" " " P.G.K. 9 Motor
193560	---	" " " P.G.K. 10 Motor
193561	2090	" " " P.G.K. 11 Motor
193561	2090	" " " P.G.K. 12 Motor
193562	---	" " " P.G.K. 15 Motor
193563	---	" " " P.G.K. 87 Motor
193564	---	" " " P.G.K. 90 Motor
193560	---	" " " P.G.K. 92 Motor
*193540	---	Armature Core, complete
*193528	---	" Shaft
193523	4959	" " Bearing Sleeve (commutator end)
447c	4959	" " " " ( " " ) Set Screw
193524	4959	" " " " (front end)
50617b	4959	" " " " ( " " ) Cap Screw
447c	4959	" " " " ( " " ) Set Screw
193542	4959	" " Oil Sling
193529	4959	" " Pinion (spiral) with two 462al
462al	1957	" " " Set Screw
931275	---	" Wire Separator (linen)
194591	---	Brush (carbon) for 25 and 32 volts
192457	4959	" ( " ) " 50 to 145 volts (2)
193799	---	" ( " ) " 150 to 250 volts (2)
193543	4959	" Cap (2)
192458	4959	" Spring (2)
194113	2091	" Tube (2)
193546	4959	" " Insulating Bushing (2)
882e	4959	" " " " Set Screw
193536	4960	Commutator, complete
193566	---	Field Coil (left) for 193565
193567	---	" " (right) for 193565
193565	---	Field Coil, complete, Nos. 193566 and 193567, for P.G.K. 3 Motor
193569	---	Field Coil (left) for 193568
193570	---	" " (right) for 193568
193568	---	Field Coil, complete, Nos. 193569 and 193570, for P.G.K. 5 Motor
193572	---	Field Coil (left) for 193571
193573	---	" " (right) for 193571
193571	---	Field Coil, complete, Nos. 193572 and 193573, for P.G.K. 6 Motor
193575	---	Field Coil (left) for 193574
193576	---	" " (right) for 193574
193574	---	Field Coil, complete, Nos. 193575 and 193576 for P.G.K. 7 Motor

## MOTOR PARTS

No.	Plate	
193578	---	Field Coil (left) for 193577
193579	---	" " (right) for 193577
193577	---	Field Coil, complete, Nos. 193578 and 193579 for P.G.K. 8 Motor
193581	---	Field Coil (left) for 193580
193582	---	" " (right) for 193580
193580	---	Field Coil, complete, Nos. 193581 and 193582 for P.G.K. 9 Motor
193584	---	Field Coil (left) for 193583
193585	---	" " (right) for 193583
193583	---	Field Coil, complete, Nos. 193584 and 193585 for P.G.K. 10 and P.G.K. 11 Motors
193587	---	Field Coil (left) for 193586
193588	---	" " (right) for 193586
193586	2090	Field Coil, complete, Nos. 193587 and 193588 for P.G.K. 12 Motor
193590	---	Field Coil (left) for 193589
193591	---	" " (right) for 193589
193589	---	Field Coil, complete, Nos. 193590 and 193591 for P.G.K. 15 Motor
193593	---	Field Coil (left) for 193592
193594	---	" " (right) for 193592
193592	---	Field Coil, complete, Nos. 193593 and 193594 for P.G.K. 87 Motor
193596	---	Field Coil (left) for 193595
193597	---	" " (right) for 193595
193595	---	Field Coil, complete, Nos. 193596 and 193597 for P.G.K. 90 Motor
193599	---	Field Coil (left) for 193598
193600	---	" " (right) for 193598
193598	---	Field Coil, complete, Nos. 193599 and 193600 for P.G.K. 92 Motor
727511	4959	Field Coil Lead Bushing (rubber)
195834	---	" " " Terminal Clip (2)
192424	4959	Field Coil Retainer (2)
193541	4960	" Core, complete
51286r	4959	" " Screw (2)
193526	4959	Grease Wick
193525	---	" " 193526 with 193527 (2)
193527	4959	" " Spring
51284r	4959	" " " Cap Screw (2)
193640	4959	" " " Retainer (2)
*192852	---	Lead Cord
192851	---	Lead Cord, complete, from lamp socket to three-pin terminal, for Knee and Treadle Control, Nos. 192790, 192852, 192989 and Plug

## MOTOR PARTS

No.	Plate		No.	Plate	
*192820	---	Lead Cord, 8ft. long, for 192875	198052	2090	Two-Pin Plug
192874	---	" " 3 ft. 10 ins. long, for 192875	198108	" "	(Norwegian)
192875	---	Lead Cord, complete, from lamp socket to three-pin terminal and controller, for Foot Controller, Nos. 192348, 192820, 192874, 192989, Plug and two 195834	198138	" "	(Danish)
192348	1949	Lead Bushing	198367	" "	(Swiss)
195834	---	Lead Terminal Clip	97382	2090	Bayonet Plug, complete, Nos. 97383 and 97384
193544	4960	Motor Cover	97383	2090	" " Body for 97382
224b	4959	" " Screw (2)	97384	2090	" " Cover for 97382
193522	---	" Frame	192540	---	Screw Plug, complete, Nos. 192541 and 192542
193545	4960	" " 193522 with 193523, 193524, two each 447c and 882c	192541	2090	" " Base for 192540
*193644	---	Motor Frame 193545 with 190b, 51303b, 51319b, 125326, 125365, 125366, 125376 and 125462	192542	2090	" " Cap with 192543 for 192540
51285e	4959	Motor Frame Screw (2)	192543	2090	" " Flash Disc (fibre) for 192542
899418	---	Name Plate for P.G.K. 7 Motor			
899419	---	" " " all P.G.K. Motors except P.G.K. 7			
192790	4959	Three-Pin Terminal Adaptor Bushing			
*192643	---	" " (female half) Housing (upper)			
*192644	---	" " ( " " ) " (lower)			
51093r	2091	" " ( " " ) " Screw			
1768r	4959	" " ( " " ) " " Nut			
192692	2091	" " ( " " ) Insert Clamp			
192691	2091	" " ( " " ) " Sleeve			
192989	4964	Three-Pin Terminal (female half), complete, Nos. 192643, 192644, two each 1768r, 51093r, three each 192691 and 192692			
*192642	---	Three-Pin Terminal Body (male half)			
*193700	---	" " " ( " " ) 192642 with three 192793			
192793	2091	" " " (male half) Post			
51582	2091	" " " ( " " ) " Thumb Nut			
701719	2091	" " " ( " " ) " Washer			
192797	4964	Three-Pin Terminal Body (male half), complete, Nos. 193700, three each 51582 and 701719			
193629	4964	Three-Pin Terminal Body (male half) Bracket			
51293e	4964	" " " ( " " ) " Screw			
50657r	4964	" " " ( " " ) Screw			
190439	---	Tube, filled with Singer Lubricant, for Electric Motors			
190613	---	" 190439 with 190612			
190612	---	" Carton (paper)			

## PLUGS

No.	Plate		No.	Plate	
198052	2090	Two-Pin Plug			
198108	" "	(Norwegian)			
198138	" "	(Danish)			
198367	" "	(Swiss)			
97382	2090	Bayonet Plug, complete, Nos. 97383 and 97384			
97383	2090	" " Body for 97382			
97384	2090	" " Cover for 97382			
192540	---	Screw Plug, complete, Nos. 192541 and 192542			
192541	2090	" " Base for 192540			
192542	2090	" " Cap with 192543 for 192540			
192543	2090	" " Flash Disc (fibre) for 192542			

**SINGER LIGHT**

(for details see Form K5550, List of Parts for B.R.K. Motors)

No.	Plate
193294	SINGER Light (moulded, less lamp), complete, Nos. 691j, 97359, 191785, 193248, 193289, 193400, 193421, 193431, 193437, 701842 and two 191786
194120	SINGER Light Lamp

*NOTE.—When ordering lamps for SINGER Lights, it is necessary to state the exact voltage required.*

Example :— 194120, 240 volts

**Bobbin Winder**

for Hand Wheel No. 15282 or No. 32672

No.	Plate
15072	1954 <b>Bobbin Position Pin</b>
†125324	1955 <b>Bracket</b> (belt cover)
158e	1957 " Screw (2)
66670	1955 <b>Frame</b>
125366	" 66670 with 15288 and 125068
51319b	1955 " Hinge Screw
66601	1955 " Spring
15287	1955 <b>Friction Ring</b> (rubber)
15288	1955 <b>Pulley</b>
125068	1955 <b>Spindle</b> with 15072
2007	1954 <b>Spool Pin</b>
125376	1955 <b>Stop Latch</b>
51303b	1955 " " Hinge Screw
125462	1955 " " Spring
125395	1955 <b>Tension Bracket</b>
125396	" " complete, Nos. 45847, 45915, 45916, 125395 and 140138b
193b	1957 " " Screw
7071	1955 " " Washer
45915	1955 " Disc
45916	1955 " " Screw Washer
45847	1955 " " Spring
140138b	1955 " " Screw
125326	1955 <b>Tripping Arm</b>
190b	1957 " " Screw
†125327	1955 <b>Bobbin Winder</b> (automatic), complete, Nos. 190b, 15287, 51303b, 51319b, 66601, 125324, 125326, 125366, 125376 and 125462

† In ordering it is necessary to state Class of Machine.

## Bobbin Winder Parts

for No. 15K91 Machine  
(OBSOLETE)

No.	Plate							
15072	1954	<b>Bobbin Position Pin</b>	...	...	...	...	...	...
66670	1955	<b>Frame</b>	...	...	...	...	...	...
125366	---	"	66670 with 15288 and 125068	...	...	...	...	...
51319b	1955	"	Hinge Screw	...	...	...	...	...
125365	2091	"	Spring	...	...	...	...	...
15287	1955	<b>Friction Ring</b>	(rubber)	...	...	...	...	...
15288	1955	<b>Pulley</b>	...	...	...	...	...	...
125068	1955	<b>Spindle with 15072</b>	...	...	...	...	...	...
2007	1954	<b>Spool Pin</b>	...	...	...	...	...	...
125376	1955	<b>Stop Latch</b>	...	...	...	...	...	...
51303b	1955	"	" Hinge Screw	...	...	...	...	...
125462	1955	"	" Spring	...	...	...	...	...
125395	1955	<b>Tension Bracket</b>	...	...	...	...	...	...
125396	---	"	" complete, Nos. 45847, 45915, 45916, 125395 and 140138b	...	...	...	...	...
193b	1957	"	" Screw	...	...	...	...	...
7071	1955	"	" " Washer	...	...	...	...	...
45915	1955	"	Disc	...	...	...	...	...
45916	1955	"	" Screw Washer	...	...	...	...	...
45847	1955	"	" Spring	...	...	...	...	...
140138b	1955	"	Screw	...	...	...	...	...
125326	1955	<b>Tripping Arm</b>	...	...	...	...	...	...
190b	1957	"	" Screw	...	...	...	...	...

## Attachments

Attachment Set  
Supplied with Machine

No.	Plate							
121464	2574	Binder	...	...	...	...	...	...
36865	2574	Edge Stitcher	...	...	...	...	...	...
121441	2574	Gathering Foot (double toe)	...	...	...	...	...	...
35931	2574	Hemmer (adjustable)	...	...	...	...	...	...
15 x 1	---	Needles (6)	...	...	...	...	...	...
86642	2574	Ruffler	...	...	...	...	...	...
25537	2574	Screw Driver (machine)	...	...	...	...	...	...
120378	2574	"	" (bobbin case)	...	...	...	...	...
8879	2574	Spool Pin Washer (cloth)	...	...	...	...	...	...
160810	---	Set of Attachments, complete, Nos. 25537, 35931, 36865, 86642, 120378, 121441, 121464, two 8879 and six needles	...	...	...	...	...	...
160811	---	Set of Attachments (less needles), complete, Nos. 25537, 35931, 36865, 86642, 120378, 121441, 121464 and two 8879	...	...	...	...	...	...
120855	1946	Hemmer (foot) $\frac{5}{64}$ " hem	...	...	...	...	...	...
2518	1954	Shuttle Bobbin (4)	...	...	...	...	...	...
120861	---	Tin of Oil (3 oz.)	...	...	...	...	...	...

The following Attachments may be purchased at an additional charge:

25525	2719	Bias Gauge	...	...	...	...	...	...
25527b	2719	Cloth Guide	...	...	...	...	...	...
50053b	2719	" " and Underbraider Thumb Screw	...	...	...	...	...	...
120914	1946	Feller (foot)	...	...	...	...	...	...
120687	---	Imitation Hemstitching Attachment with Yielding Presser Plate	...	...	...	...	...	...
35932	2719	Quilter	...	...	...	...	...	...
121170	909	Ruffler Shirring Plate	...	...	...	...	...	...
25539	2719	Stiletto	...	...	...	...	...	...
36583	1956	Tucker	...	...	...	...	...	...
121547	909	Underbraider	...	...	...	...	...	...

## Art Work and Darning

No.	Plate				
85893	1956	Embroidery Foot (for art work)	...	...	...
121094	2719	Darning Foot (spring)	...	...	...

## Cording Feet

For Stitching on Edge and Inserting Cord

No.	Plate				
160845	2719	Presser Foot (left toe)	...	...	...
160846	2719	" " (right toe)	...	...	...

## Imitation Hemstitching Attachment

No.	Plate				
120687	1956	with Yielding Presser Plate	...	...	...

## Presser Feet

No.	Plate				
121875	—	Presser Foot, for 121877	<i>obsolete</i>	...	...
140347w	—	" " Adjusting Thumb Screw, for 121877	<i>obsolete</i>	...	...
121876	—	" " Body, for 121877	<i>obsolete</i>	...	...
121877	2719	Presser Foot (adjustable for sewing on the right or left side of the needle), complete, Nos. 121875, 121876 and 140347w, for Cording and Slide Fastener Work	<i>obsolete, use 161127</i>	...	...
121441	2574	Presser Foot (double toe) for gathering	...	...	...

## Presser Foot

(for Cording and Slide Fastener Work)

No.	Plate				
140728	—	Presser Foot Adjusting Thumb Screw	...	...	...
161122	—	" " " " " Spring	...	...	...
161123	—	" " Hinge Pin	...	...	...
161124	—	" " Plate	...	...	...
161125	—	" " Shank (adjustable)	...	...	...
161126	—	" " (stationary)	...	...	...
161127	—	Presser Foot (hinged, adjustable) for sewing on the right or left side of the needle, complete, Nos. 140728 and 161122 to 161126	...	...	...

96417	—	Round, 5 $\frac{3}{8}$ " diam. $\times$ 7 $\frac{m}{m}$ high, complete,	Nos. 101348 and 101349
96418	2193	" 7" " $\times$ 7 $\frac{m}{m}$ " " "	Nos. 101350 and 101351
96419	—	" 8" " $\times$ 7 $\frac{m}{m}$ " " "	Nos. 101352 and 101353
96420	—	" 10" " $\times$ 7 $\frac{m}{m}$ " " "	Nos. 101354 and 101355
96421	—	" 12" " $\times$ 7 $\frac{m}{m}$ " " "	Nos. 101356 and 101357
96423	—	Oval, 9" $\times$ 4 $\frac{1}{2}$ " $\times$ 7 $\frac{m}{m}$ high, complete,	Nos. 101360 and 101361
96424	—	" 12" $\times$ 5 $\frac{1}{2}$ " $\times$ 7 $\frac{m}{m}$ " " "	Nos. 101362 and 101363

## Embroidery Hoops (Plain)

(BIRCH)

No.	Plate				
87586	—	Round, 5 $\frac{3}{8}$ " diam. $\times$ 7 $\frac{m}{m}$ high	101336 & 101337	...	...
96416	—	" 7" " $\times$ 7 $\frac{m}{m}$ " " "	101346 & 101347	...	...
87589	1221	" 8" " $\times$ 7 $\frac{m}{m}$ " " "	101338 & 101339	...	...
87593	—	" 10" " $\times$ 7 $\frac{m}{m}$ " " "	101340 & 101341	...	...
87595	—	" 12" " $\times$ 7 $\frac{m}{m}$ " " "	101342 & 101343	...	...
96422	1221	Oval, 9" $\times$ 4 $\frac{1}{2}$ " $\times$ 7 $\frac{m}{m}$ high	101358 & 101359	...	...
87597	—	" 12" $\times$ 5 $\frac{1}{2}$ " $\times$ 7 $\frac{m}{m}$ " " "	101344 & 101345	...	...

## Embroidery Hoops (with Clamp)

(BIRCH)

No.	Plate				
96417	—	Round, 5 $\frac{3}{8}$ " diam. $\times$ 7 $\frac{m}{m}$ high, with SS528j, NN95j, two	96425 and four 96427		
96418	—	" 7" " $\times$ 7 $\frac{m}{m}$ " " " SS528j, NN95j, two	96426 and four 96427		
96419	—	" 8" " $\times$ 7 $\frac{m}{m}$ " " " SS528j, NN95j, two	96426 and four 96427		
96420	—	" 10" " $\times$ 7 $\frac{m}{m}$ " " " SS528j, NN95j, two	96426 and four 96427		
96421	—	" 12" " $\times$ 7 $\frac{m}{m}$ " " " SS528j, NN95j, two	96844 and four 96845		
96423	—	Oval, 9" $\times$ 4 $\frac{1}{2}$ " $\times$ 7 $\frac{m}{m}$ high, with SS528j, NN95j,	96425, 96426 and four 96427		
96424	—	" 12" $\times$ 5 $\frac{1}{2}$ " $\times$ 7 $\frac{m}{m}$ " " " SS528j, NN95j,	96425, 96426 and four 96427		
96425	2399	Clamping Bracket for	<del>96417, 96423 and 96424</del> 101349, 101361 & 101363		
96426	2399	" " " "	<del>96418 to 96420, 96423 and 96424</del> 101351, 101353		
96844	2399	" " " "	<del>96421</del> 101357, 101355, 101361, 101363		
96427	2399	" " Rivet for	<del>96417 to 96420, 96423 and 96424</del> 101349		
96845	2399	" " " "	<del>96421</del> 101357, 101351, 101353, 101355		
SS528j	2399	" " Screw	...		
NN95j	2399	" " Nut	...		

101336	---	"	"	(outer) for 87586	...	...	...
101337	---	"	"	(inner) for 87589	...	...	...
101338	---	"	"	(outer) for 87589	...	...	...
101339	---	"	"	(inner) for 87593	...	...	...
101340	---	"	"	(outer) for 87593	...	...	...
101341	---	"	"	(inner) for 87595	...	...	...
101342	---	"	"	(outer) for 87595	...	...	...
101343	---	"	"	(inner) for 87597	...	...	...
101344	---	"	"	(outer) for 87597	...	...	...
101345	---	"	"	(inner) for 96416	...	...	...
101346	---	"	"	(outer) for 96416	...	...	...
101347	---	"	"	(inner) for 96422	...	...	...
101358	---	"	"	(outer) for 96422	...	...	...
101359	---	"	"	(outer) for 96422	...	...	...
-----							
101348	---	Embroidery Hoop	(inner) for 96417	...	...	...	...
101349	---	"	(outer) with SS528j, NN95j, two 96425 and four 96427, for 96417	...	...	...	...
101350	---	"	(inner) for 96418	...	...	...	...
101351	---	"	(outer) with SS528j, NN95j, two 96426 and four 96427, for 96418	...	...	...	...
101352	---	"	(inner) for 96419	...	...	...	...
101353	---	"	(outer) with SS528j, NN95j, two 96426 and four 96427, for 96419	...	...	...	...
101354	---	"	(inner) for 96420	...	...	...	...
101355	---	"	(outer) with SS528j, NN95j, two 96426 and four 96427, for 96420	...	...	...	...
101356	---	"	(inner) for 96421	...	...	...	...
101357	---	"	(outer) with SS528j, NN95j, two 96844 and four 96845, for 96421	...	...	...	...
101360	---	"	(inner) for 96423	...	...	...	...
101361	---	"	(outer) with SS528j, NN95j, 96425, 96426 and four 96427, for 96423	...	...	...	...
101362	---	"	(inner) for 96424	...	...	...	...
101363	---	"	(outer) with SS528j, NN 95j, 96425, 96426 and four 96427, for 96424	...	...	...	...

## Embroidery Hoop (with Spring)

(BIRCH)

No.	Plate	
101364	---	Hoop (inner) for 101246
101365	---	" (outer) with Spring, for 101246
101246	---	" (round) 10" diam. x $\frac{7}{16}$ " high, complete, Nos. 101364 and 101365

## Hand Attachment

No.	Plate		No.	Plate
94050	2284	<b>Body</b> ... ..	25361	1950
94027	2284	" Bracket ... ..	25347	1950
183e	2114	" " Screw ... ..	25362	---
94028	2114	<b>Crank Handle</b> (wood) ... ..		
94029b	2114	" " Spindle ... ..	25267	---
94030b	2114	" " " Flange (loose) ... ..		
94069	2114	" Hinge Pin ... ..		
94031a	2284	" Lever ... ..	25268	1950
94032	2114	" " Lock Pin ... ..	25341	---
94033b	2114	" " " " Head ... ..		
55531	2114	" " " " Spring ... ..		
94034b	---	<b>Crank</b> , complete, Nos. 94028, 94029b, 94030b and 94031a ... ..	5269	1950
94046	2114	<b>Driver</b> ... ..	5345	---
94070	---	" 94046 with 80028 and 94048 ... ..	1735j	1958
94036	2114	" Finger ... ..		
94039	2114	" " Driving Pad (raw-hide) ... ..	5374	---
94040	2114	" " " " Plate ... ..	5307	1950
SS567e	2114	" " " " and Plate Binding Screw ... ..	5379	---
94041	---	" " 94036 with SS567e, 94039 and 94040 ... ..	5308	1950
94044	2114	" " Hinge Pin ... ..	335b	1957
94037	2114	" " Latch ... ..	714b	1958
SS565e	2114	" " " Screw Stud ... ..	5309	---
94038	2114	" " " Spring ... ..	8391	1950
94051b	2284	<b>Gear</b> with 55531, 94032 and 94033b ... ..		
94016	2284	" Cover ... ..		
399a	2114	" " Screw ... ..		
SS599f	2114	" Screw Stud ... ..		
94048	2114	<b>Pinion</b> ... ..		
80028	2114	" Dowel Pin ... ..		
SS600f	2114	" Screw Stud (eccentric) ... ..		
94052b	2284	<b>Hand Attachment</b> , complete, Nos. SS565e, SS566c, SS599f, SS600f, 94016, 94027, 94034b, 94037, 94038, 94041, 94044, 94050, 94051b, 94069, 94070, two each 183e and 399a ... ..		
SS566c	2114	<b>Hand Attachment Screw</b> ... ..		

## Obsolete Parts

No.	Plate		No.	Plate
		<b>Feed Bar Throw-out Lever</b> with 1813 ... ..		
		<b>Feed Lifting Rock Shaft Crank</b> with 157j ... ..		
		<b>Feed Lifting Rock Shaft Crank</b> , complete, Nos. 51289j, 125347 and 125361 ... ..		
		<b>Feed Lifting Rock Shaft</b> , complete, Nos. 125263, 125349 and 125362 ... ..		
		<b>Feed Regulator</b> ... ..		
		" " 125268 with 125345 ... ..		
		<b>Feed Reversing Lever</b> ... ..		
		" " " 125269 with 1735j ... ..		
		" " " Lock Nut ... ..		
		<b>Stitch Indicator Plate</b> ... ..		
		" " " 125374 with 125309 ... ..		
		" " " 125307 with 714b, 38391 and 125308 ... ..		
		" " " Cover ... ..		
		" " " Screw (2) ... ..		
		" Regulating Thumb Screw ... ..		
		" " " " Bushing ... ..		
		" " " " Washer ... ..		

# Numerical List of Parts

No.	Plate	
NN95j	2399	Embroidery Hoop Clamping Bracket Screw Nut for <del>96417 to 96421, 96423 and 96424</del> 101353, 101355,
138e	1957	Arm Screw ... .. 101357, 101361, 101363.
145j	1957	Shuttle Race Screw ... ..
157j	1957	Feed Lifting Rock Shaft Crank Clamping Screw for 125347 and 125388 ... ..
158e	1957	Bobbin Winder Bracket Screw ... ..
175j	1957	Feed Forked Connection Adjusting Screw for 125262 ... ..
183e	2114	Hand Attachment Body Bracket Screw for 94052b ... ..
190b	1957	Bobbin Winder Tripping Arm Screw for 125327 and 193644 ... ..
190b	1957	Face Plate Screw ... ..
193b	1957	Bobbin Winder Tension Bracket Screw ... ..
208al	1957	Feed Dog Screw ... ..
224b	4959	Motor Cover Screw for 15K91 Machine ... ..
246a	2091	Clamp Stop Motion Clamp Stop Screw for 15K91 Machine ... ..
248a	1957	Clamp Stop Motion Clamp Stop Screw for 15314 ... ..
256b	1957	Clamp Stop Motion Clamp Screw for 15314
304c	1957	Feed Lifting Rock Shaft Screw Centre for 125344 ... ..
304c	1957	Feed Rock Shaft Screw Centre for 125344 ... ..
315c	1957	Feed Bar Screw Centre ... ..
335b	1957	Stitch Indicator Plate Cover Screw (Obsolete)
335b	1957	Stitch Indicator Plate Screw ... ..
375c	1957	Crank Connecting Rod Hinge Screw ... ..
391j	1957	Shuttle Bobbin Case Position Plate Screw for 125300 ... ..
399a	2114	Hand Attachment Gear Cover Screw for 94052b ... ..
435c	1957	Arm Shaft Bushing Set Screw for 125252 ... ..
447c	4959	Armature Shaft Bearing Sleeve (commutator end) Set Screw for 193545 ... ..
447c	4959	Armature Shaft Bearing Sleeve (front end) Set Screw for 193545 ... ..
448c	1957	Presser Bar Lifter Hinge Stud Set Screw for 125252 ... ..
453c	1957	Presser Bar Spring Bracket Set Screw for 2068 ... ..
462al	1957	Armature Shaft Pinion Set Screw for 193529
462al	1957	Clamp Stop Motion Flanged Bushing Set Screw for 15313 and 125372 ... ..



No.	Plate	
462al	1957	Oscillating Shaft Crank Set Screw for 125283 and 125284 ... ..
SS528j	2399	Embroidery Hoop Clamping Bracket Screw for <del>96417 to 96421, 96423 and 96424</del> 10134410
SS565e	2114	Hand Attachment Driver Finger Latch Screw Stud for 94052b ... .. 101353, 101357, 1013
SS566c	2114	Hand Attachment Screw for 94052b
SS567e	2114	Hand Attachment Driver Finger Driving Pad and Plate Binding Screw for 94041 ...
570c	1957	Needle Bar Connecting Link Hinge Screw for 15434 ... ..
591f	1957	Shuttle Tension Regulating Screw for 125291
592e	1957	Shuttle Bobbin Case Latch Stop Screw for 125291 ... ..
SS599f	2114	Hand Attachment Gear Screw Stud for 94052b
SS600f	2114	Hand Attachment Pinion Screw Stud (eccentric) for 94052b ... ..
662j	1957	Shuttle Race Cap Screw for 125304 ...
691a	1957	Throat Plate Screw ... ..
714b	1958	Stitch Regulating Thumb Screw for 125379 (Obsolete)
857b	1957	Thread Take-up Spring Regulator Set Screw for 125368 ... ..
882e	4959	Brush Tube Insulating Bushing Set Screw for 193545 ... ..
896e	1957	Crank Connecting Rod Cap Screw for 125021
1085e	1957	Feed Forked Connection Slide Block Screw Stud for 125335 ... ..
1253c	1957	Shuttle Driver Set Screw for 125297 ...
1285c	1957	Feed Cam and Counterbalance Position Screw for 125045 ... ..
1293al	1957	Thread Take-up Cam Timing Screw for 15272
1341c	1958	Needle Bar Connecting Stud Set Screw for 125276 ... ..
1498c	1958	Needle Bar Bushing Set Screw ... ..
1513j	1958	Feed Lifting Rock Shaft Screw Centre Nut for 125344 ... ..
1513j	1958	Feed Rock Shaft Screw Centre Nut for 125344
1518j	1958	Crank Connecting Rod Hinge Screw Nut ...
1519j	1958	Feed Bar Screw Centre Nut ... ..
1520j	1958	Feed Forked Connection Hinge Screw Nut
1520j	1958	Needle Bar Connecting Link Hinge Screw Nut for 15434 ... ..
1550j	1960	Feed Reversing Handle Lock Nut for 125381
1735j	1958	Feed Reversing Lever Lock Nut for 125345 (Obsolete)

No.	Plate	
1768r	4959	Three-Pin Terminal (female half) Housing Screw Nut for 192989 ... ..
1813	1958	Feed Throw-out Lever Roller and Stud for 125361 and 125386 ... ..
1822	1958	Thread Take-up Lever Roller and Stud for 125382 ... ..
2002	1954	Arm Dowel Pin ... ..
2007	1954	Arm Spool Pin ... ..
2007	1954	Bobbin Winder Spool Pin ... ..
2020	1954	Clamp Stop Motion Clamp Washer for 15314
2022	2552	Clamp Stop Motion Flanged Bushing Pin ...
2049	2552	Oscillating Shaft Crank Pin for 125363 ...
2049	2552	Shuttle Driver Pin ... ..
2068	2552	Presser Bar Spring Bracket with 453c ...
2070	2552	Presser Bar Spring Washer ... ..
2102	2552	Tension Disc for 125418 ... ..
2518	1954	Shuttle Bobbin for 125294 ... ..
2835	792	Feed Bar ... ..
2974	1954	Shuttle Bobbin Case Latch Lever Fulcrum Pin for 125288 ... ..
2975	1954	Shuttle Bobbin Case Latch Spring for 125291
7071	1955	Bobbin Winder Tension Bracket Screw Washer ... ..
8879	2574	Spool Pin Washer (cloth) for 160810 and 160811 ... ..
15072	1954	Bobbin Winder Bobbin Position Pin for 125068 ... ..
*15170	2552	Oscillating Shaft Crank Slide Block for 125330 ... ..
*15248	1954	Needle Bar Connecting Link with 51002e, for 125275 ... ..
15272	1954	Thread Take-up Cam with 1293al, for 15434
15282	1152	Hand Wheel, 2 1/4" pulley, for 15K88 and 15K89 Machines ... ..
15287	1955	Bobbin Winder Friction Ring (rubber) for 125327 and 15K91 Machine ... ..
15288	1955	Bobbin Winder Pulley for 125366 ... ..
*15312	---	Clamp Stop Motion Flanged Bushing for 15313 ... ..
15313	1954	Clamp Stop Motion Flanged Bushing 15312 with two 462al, for 15314 ... ..
15314	---	Clamp Stop Motion, complete, Nos. 248a, 256b, 2020 and 15313, for 15K88 to 15K90 Machines ... ..
15410	2552	Tension Stud Bushing for 125384 ... ..
*15434	---	Thread Take-up Cam 15272, with 570c and 1520j, for 125254 ... ..

No.	Plate	
15486	2552	Presser Bar Lifter Hinge Stud for 125252 ...
15498	1954	Arm Shaft Bushing for 125252 and 125254
25525	2719	Bias Gauge ... ..
25527b	2719	Cloth Guide ... ..
25537	2574	Screw Driver (machine) for 160810 and 160811 ... .. (Accessories)
25539	2719	Stiletto ... ..
26075	2552	Thread Cutter and Holder ... ..
<del>32519</del>	<del>1954</del>	<del>Needle Stop Pin for 125377</del> ... ..
32672	1722	Hand Wheel, 3 1/4" Pulley, for 15K90 Machine
*32774	-	Presser Foot Shank for 45321 ... ..
35931	2574	Hemmer (adjustable) for 160810 and 160811
35932	2719	Quilter ... ..
36583	1956	Tucker ... ..
36865	2574	Edge Stitcher for 160810 and 160811 ... ..
38391	1950	Stitch Regulating Thumb Screw Washer for 125379 ... .. (Obsolete)
45285	1951	Needle Clamp 45334 with 51308j ... ..
<del>45290</del>	-	<del>Stitch Regulating Thumb Screw Bushing for 45308</del> ... ..
45305	1960	Feed Reversing Handle for 125381 ... ..
45306	1960	Stitch Indicator Plate for 45309 ... ..
<del>45307</del>	-	<del>Stitch Regulating Plate for 45308</del> ... ..
45308	1960	Stitch Regulating Plate 45307 with 45289 for 45309 ... ..
45309	-	Stitch Regulating Plate 45308 with 45306, 45310, 51312b and 125400 ... ..
45310	1960	Stitch Regulating Thumb Screw Washer (fibre) for 45309 ... ..
45319	-	Presser Foot Plate for 45321 ... ..
45321	1951	Presser Foot (hinged), complete, Nos. 32774, 45319, and 45329 ... ..
45329	-	Presser Foot Hinge Pin for 45321 ... ..
45334	-	Needle Clamp with 140545c for 45285 ... ..
45339	2391	Tension Regulating Thumb Nut Engaging Pin for 51682 ... ..
45847	1955	Bobbin Winder Tension Disc Spring for 125396 ... ..
45865	2391	Tension Indicator Flange Stop Washer for 125418 ... ..
45915	1955	Bobbin Winder Tension Disc for 125396 ... ..
45916	1955	Bobbin Winder Tension Disc Screw Washer for 125396 ... ..
50053b	2719	Cloth Guide and Under Braider Thumb Screw ... ..
50292b	1957	Tension Stud Set Screw for 125368 ... ..
50353e	1957	Feed Regulator Hinge Screw ... ..

No.	Plate	
50527c	1957	Thread Take-up Lever Hinge Screw for 125383 ... ..
50617b	4959	Armature Shaft Bearing Sleeve (front end) Cap Screw for 15K91 Machine ... ..
50657r	4964	Three-Pin Terminal Body (male half) Screw for 15K91 Machine ... ..
51002c	1957	Needle Bar Connecting Link Adjusting Screw for 15248 ... ..
51045c	1958	Machine Hinge Connection Set Screw ... ..
51093r	2091	Three-Pin Terminal (female half) Housing Screw for 192989 ... ..
51224b	1957	Arm Side Cover Thumb Screw ... ..
51224b	1957	Presser Foot Thumb Screw ... ..
*51228b	2552	Pressure Regulating Thumb Screw for 66773
51229c	1958	Shuttle Driver Cushion Spring Screw for 125322 and 125323 ... ..
51246c	1958	Oscillating Rock Shaft Centre (left) Set Screw ... ..
51246c	1958	Oscillating Rock Shaft Centre (right) Set Screw ... ..
51252c	1958	Feed Forked Connection Hinge Screw (eccentric) ... ..
51261j	1958	Shuttle Race Back Spring Thumb Screw for 125306 ... ..
51280b	2091	Clamp Stop Motion Clamp Screw for 125371
51281c	4956	Hand Wheel Gear Collar Set Screw for 125353 ... ..
51282j	1958	Shuttle Race Slide Spring Screw for 125338
51284r	4959	Grease Wick Spring Cap Screw for 15K91 Machine ... ..
51285e	4959	Motor Frame Screw for 15K91 Machine ... ..
51286r	4959	Field Core Screw for 15K91 Machine ... ..
51289j	1958	Feed Throw-out Lever Thumb Screw for 125362 and 125389 ... ..
51293e	4964	Three-Pin Terminal Body (male half) Bracket Screw for 15K91 Machine ... ..
51303b	1955	Bobbin Winder Stop Latch Hinge Screw for 125327 and 193644 ... ..
51308j	1958	Needle Clamp Position Screw for 45285 ... ..
51312b	1960	Stitch Regulating Thumb Screw for 45309
51319b	2091	Bobbin Winder Frame Hinge Screw for 125327 and 193644 ... ..
51582b	2091	Three-Pin Terminal Body (male half) Post Thumb Nut for 192797 ... ..
51682b	2391	Tension Regulating Thumb Nut with 45339 for 125420 ... ..

No.	Plate	
55531	2114	Hand Attachment Crank Lever Lock Pin Spring for 94051b ... ..
55621	1951	Presser Bar Lifter ... ..
66601	1955	Bobbin Winder Frame Spring for 125327 ...
66670	1955	Bobbin Winder Frame for 125366 ...
66752	2552	Pressure Regulating Thumb Screw Plug (felt) for 66773 ... ..
66773	---	Pressure Regulating Thumb Screw 51228b with 66752 ... ..

No.	Plate	
80011	2391	Presser Bar Spring ... ..
80028	2114	Hand Attachment Pinion Dowel Pin for 94070 ... ..
85893	1956	Embroidery Foot (for art work) ... ..
86642	2574	Ruffler for 160810 and 160811 ... ..
87586	---	Embroidery Hoop (round, birch) 5 $\frac{3}{8}$ " diam. $\times 7\frac{m}{m}$ high <i>10/336 &amp; 10/337</i> ...
87589	1221	Embroidery Hoop (round, birch) 8" diam. $\times 7\frac{m}{m}$ high <i>10/338 &amp; 10/339</i> ...
87593	---	Embroidery Hoop (round, birch) 10" diam. $\times \frac{7}{16}$ " high <i>10/340 &amp; 10/341</i> ...
87595	---	Embroidery Hoop (round, birch) 12" diam. $\times \frac{1}{2}$ " high <i>10/342 &amp; 10/343</i> ...
87597	---	Embroidery Hoop (oval, birch) 12" $\times$ 5 $\frac{1}{2}$ " $\times$ 7 $\frac{m}{m}$ high <i>10/344 &amp; 10/345</i> ...

No.	Plate	
94016	2284	Hand Attachment Gear Cover for 94052b ...
94027	2284	Hand Attachment Body Bracket for 94052b
94028	2114	Hand Attachment Crank Handle (wood) for 94034b ... ..
94029b	2114	Hand Attachment Crank Handle Spindle for 94034b ... ..
94030b	2114	Hand Attachment Crank Handle Spindle Flange (loose) for 94034b ... ..
94031a	2284	Hand Attachment Crank Lever for 94034b ...
94032	2114	Hand Attachment Crank Lever Lock Pin for 94051b ... ..
94033b	2114	Hand Attachment Crank Lever Lock Pin Head for 94051b ... ..
94034b		Hand Attachment Crank, complete, Nos. 94028, 94029b, 94030b and 94031a, for 94052b ... ..
94036	2114	Hand Attachment Driver Finger for 94041
94037	2114	Hand Attachment Driver Finger Latch for 94052b ... ..
94038	2114	Hand Attachment Driver Finger Latch Spring for 94052b ... ..
94039	2114	Hand Attachment Driver Finger Driving Pad (raw-hide) for 94041 ... ..
94040	2114	Hand Attachment Driver Finger Driving Pad Plate for 94041 ... ..
94041		Hand Attachment Driver Finger 94036, with SS567c, 94039 and 94040, for 94052b ...
94044	2114	Hand Attachment Driver Finger Hinge Pin for 94052b ... ..
94046	2114	Hand Attachment Driver for 94070 ... ..
94048	2114	Hand Attachment Pinion for 94070 ... ..
94050	2284	Hand Attachment Body for 94052b ... ..
94051b	2284	Hand Attachment Gear with 55531, 94032 and 94033b, for 94052b ... ..
94052b	2284	Hand Attachment, complete Nos. SS565e, SS566c, SS599f, SS600f, 94016, 94027, 94034b, 94037, 94038, 94041, 94044, 94050, 94051b, 94069, 94070, two each 183c and 399a ... ..
94069	2114	Hand Attachment Crank Hinge Pin for 94052b ... ..
94070		Hand Attachment Driver 94046 with 80028 and 94048, for 94052b ... ..

No.	Plate	
96416		Embroidery Hoop (round, birch) 7" diam. × 7 <sup>m</sup> / <sub>m</sub> high 101346 & 101347 ...
96417		Embroidery Hoop (round, birch) 5 <sup>3</sup> / <sub>8</sub> " diam. × 7 <sup>m</sup> / <sub>m</sub> high, with SS528j, NN95j, two 96425 and four 96427 ... ..
96418		Embroidery Hoop (round, birch) 7" diam. × 7 <sup>m</sup> / <sub>m</sub> high, with SS528j, NN95j, two 96426 and four 96427 ... ..
96419		Embroidery Hoop (round, birch) 8" diam. × 7 <sup>m</sup> / <sub>m</sub> high, with SS528j, NN95j, two 96426 and four 96427 ... ..
96420		Embroidery Hoop (round, birch) 10" diam. × 7 <sup>m</sup> / <sub>m</sub> high, with SS528j, NN95j, two 96426 and four 96427 ... ..
96421		Embroidery Hoop (round, birch) 12" diam. × 7 <sup>m</sup> / <sub>m</sub> high, with SS528j, NN95j, two 96844 and four 96845 ... ..
96422	1221	Embroidery Hoop (oval, birch) 9" × 4 <sup>1</sup> / <sub>2</sub> " × 7 <sup>m</sup> / <sub>m</sub> high 101358 & 101359 ... ..
96423		Embroidery Hoop (oval, birch) 9" × 4 <sup>1</sup> / <sub>2</sub> " × 7 <sup>m</sup> / <sub>m</sub> high, with SS528j, NN95j, 96425, 96426 and four 96427 ... ..
96424		Embroidery Hoop (oval, birch) 12" × 5 <sup>1</sup> / <sub>2</sub> " × 7 <sup>m</sup> / <sub>m</sub> high, with SS528j, NN95j, 96425, 96426 and four 96427 ... ..
96425	2399	Embroidery Hoop Clamping Bracket for 101349, 101361, 101362 & 101363 ... ..
96426	2399	Embroidery Hoop Clamping Bracket for 101351, 101353, 101355, 101361, 101362 & 101363 ... ..
96427	2399	Embroidery Hoop Clamping Bracket Rivet for 96417 to 96420, 96423 and 96424 101349, 101351, 101353, 101355 ... ..
96844	2399	Embroidery Hoop Clamping Bracket for 101353, 101355, 101361 & 101362 ... ..
96845	2399	Embroidery Hoop Clamping Bracket Rivet for 96421 101357 ... ..
97382	2090	Bayonet Plug, complete, Nos. 97383 and 97384, for 15K91 Machine ... ..
97383	2090	Bayonet Plug Body for 97382 ... ..
97384	2090	Bayonet Plug Cover for 97382 ... ..
96417		Embroidery Hoop (round, birch) 5 <sup>3</sup> / <sub>8</sub> " diam. × 7 <sup>m</sup> / <sub>m</sub> high, complete, Nos. 101348 and 101349 ... ..
96418	2193	Embroidery Hoop (round, birch) 7" diam. × 7 <sup>m</sup> / <sub>m</sub> high, complete, Nos. 101350 and 101351 ... ..
96419		Embroidery Hoop (round, birch) 8" diam. × 7 <sup>m</sup> / <sub>m</sub> high, complete, Nos. 101352 and 101353 ... ..
96420		Embroidery Hoop (round, birch) 10" diam. × 7 <sup>m</sup> / <sub>m</sub> high, complete, Nos. 101354 and 101355 ... ..
96421		Embroidery Hoop (round, birch) 12" diam. × 7 <sup>m</sup> / <sub>m</sub> high, complete, Nos. 101356 and 101357
96423		Embroidery Hoop (oval, birch) 9" × 4 <sup>1</sup> / <sub>2</sub> " × 7 <sup>m</sup> / <sub>m</sub> high, complete, Nos. 101360 and 101361
96424		Embroidery Hoop (oval, birch) 12" × 5 <sup>1</sup> / <sub>2</sub> " × 7 <sup>m</sup> / <sub>m</sub> high, complete, Nos. 101362 and 101363 ... ..

101362	—	Embroidery Hoop (inner) for 96424	...
101363	—	Embroidery Hoop (outer) with SS528j, NN95j, 96425, 96426 and four 96427, for 96424	...
101364	—	Embroidery Hoop (inner) for 101246	...
101365	—	Embroidery Hoop (outer) with Spring, for 101246	...
140728	—	Presser Foot Adjusting Thumb Screw for 161127	...
101122	—	Presser Foot Adjusting Thumb Screw Spring for 161127	...
161123	—	Presser Foot Hinge Pin for 161127	...
161124	—	Presser Foot Plate for 161127	...
161125	—	Presser Foot Shank (adjustable) for 161127	...
161126	—	Presser Foot Shank (stationary) for 161127	...
161127	—	Presser Foot (hinged, adjustable) for sewing on the right or left side of the needle, complete, Nos. 140728 and 161122 to 161126	...
101246	—	Embroidery Hoop (round, birch) 10" diam. x $\frac{1}{8}$ " high, complete, Nos. 101364 and 101365	...
101336	—	Embroidery Hoop (inner) for 87586	...
101337	—	Embroidery Hoop (outer) for 87586	...
101338	—	Embroidery Hoop (inner) for 87589	...
101339	—	Embroidery Hoop (outer) for 87589	...
101340	—	Embroidery Hoop (inner) for 87593	...
101341	—	Embroidery Hoop (outer) for 87593	...
101342	—	Embroidery Hoop (inner) for 87595	...
101343	—	Embroidery Hoop (outer) for 87595	...
101344	—	Embroidery Hoop (inner) for 87597	...
101345	—	Embroidery Hoop (outer) for 87597	...
101346	—	Embroidery Hoop (inner) for 96416	...
101347	—	Embroidery Hoop (outer) for 96416	...
101348	—	Embroidery Hoop (inner) for 96417	...
101349	—	Embroidery Hoop (outer) with SS528j, NN95j, two 96425 and four 96427, for 96417	...
101350	—	Embroidery Hoop (inner) for 96418	...
101351	—	Embroidery Hoop (outer) with SS528j, NN95j, two 96426 and four 96427, for 96418	...
101352	—	Embroidery Hoop (inner) for 96419	...
101353	—	Embroidery Hoop (outer) with SS528j, NN95j, two 96426 and four 96427, for 96419	...
101354	—	Embroidery Hoop (inner) for 96420	...
101355	—	Embroidery Hoop (outer) with SS528j, NN95j, two 96426 and four 96427, for 96420	...
101356	—	Embroidery Hoop (inner) for 96421	...
101357	—	Embroidery Hoop (outer) with SS528j, NN95j, two 96844 and four 96845, for 96421	...
101358	—	Embroidery Hoop (inner) for 96422	...
101359	—	Embroidery Hoop (outer) for 96422	...
101360	—	Embroidery Hoop (inner) for 96423	...

No.	Plate	
120378	2574	Screw Driver (bobbin case) for 160810 and 160811
120687	1956	Imitation Hemstitching Attachment with yielding presser plate
120855	1946	Hemmer (foot), $\frac{5}{8}$ " hem...
120861		Tin of Oil (3 oz.)
120914	1946	Feller (foot)
121094	2719	Darning Foot (spring)
121170	909	Ruffler Shirring Plate
121441	2574	Gathering Foot (double toe) for 160810 and 160811
121441	2574	Presser Foot (double toe) for gathering
121461	2574	Binder for 160810 and 160811
121547	909	Under Braider
121875		Presser Foot for 121877 <i>obsolete</i>
121876		Presser Foot Body for 121877 <i>obsolete</i>
121877	2719	Presser Foot (adjustable for sewing on the right or left side of the needle), complete, Nos. 121875, 121876 and 140347w, for Cording and Slide Fastener Work <i>obsolete use 161127</i>
*125012		Crank Connecting Rod Cap for 125021
125021	1947	Crank Connecting Rod with 125012, 125044 and two 896e
125029		Drip Pan (for Cover Set)
125044	1949	Crank Connecting Rod Oil Pad (felt) for 125021
125045	2552	Feed Cam and Counterbalance with 1285c, for 125251
125047	2552	Feed Forked Connection Slide Block for 125335
125048	2552	Oscillating Rock Shaft Centre (left)
125049	2552	Oscillating Rock Shaft Centre (right)
125056	1949	Oscillating Rock Shaft Oil Wick (braided cotton) for 125280
*125060	2552	Oscillating Shaft Crank Slide Block Stud for 125330
125061	2552	Presser Bar
125068	1955	Bobbin Winder Spindle with 15072, for 125366
*125251		Arm for 125252
125252		Arm 125251 with 435e, 448c, 15486 and 15498
125253	1947	Arm Shaft for 125254
*125254		Arm Shaft 125253 with 15434, 15498 and 125045
*125255		Bed
125258	1951	Face Plate Tension Seat for 125384
125261	1946	Feed Dog, 12 teeth (14 teeth to the inch)

No.	Plate	
125262	1947	Feed Forked Connection with 175j, for 125340
125263	1947	Feed Lifting Rock Shaft for 125267 and 125390 ... ..
125267	--	Feed Lifting Rock Shaft, complete, Nos. 125263, 125349 and 125362 (Obsolete)
125268	1950	Feed Regulator for 125341 (Obsolete)
125269	1950	Feed Reversing Lever for 125345 (Obsolete)
125270	1947	Feed Rock Shaft ... ..
*125272	1951	Needle Bar Bushing for 125273 ... ..
125273	—	Needle Bar Bushing 125272 with 125274 ... ..
125274	1949	Needle Bar Bushing Oil Pad (felt) for 125273
125275	—	Needle Bar Connecting Link 15248 with 125276 ... ..
125276	1950	Needle Bar Connecting Stud with 1341c, for 125275 ... ..
125280	1947	Oscillating Rock Shaft with 125056 ... ..
125281	2551	Oscillating Shaft for 125363 ... ..
*125282	—	Oscillating Shaft Crank for 125283 and 125284
*125283	1950	Oscillating Shaft Crank 125282, with 462al and 125330 for 125323 ... ..
125284	—	Oscillating Shaft Crank 125282 with 125330 and two 462al ... ..
125285	1946	Presser Foot ... ..
125287	1949	Shuttle Bobbin Case Latch for 125288 ... ..
125288	—	Shuttle Bobbin Case Hinge, Nos. 2974, 125287 and 125320 for 125291 ... ..
125290	1948	Shuttle Bobbin Case Position Plate for 125300 ... ..
125291	1949	Shuttle Bobbin Case with 591f, 592c, 2975, 125288 and 125293, for 125294 ... ..
125292	1949	Shuttle Body for 125294 ... ..
125293	1949	Shuttle Tension Spring for 125291 ... ..
125294	—	Shuttle, 1 $\frac{1}{8}$ " diam., complete, Nos. 2518, 125291 and 125292 ... ..
*125295	1949	Shuttle Driver for 125297 and 125363 ... ..
125297	—	Shuttle Driver 125295, with two 1253c, for 125322 ... ..
125298	1949	Shuttle Driver Cushion Spring for 125322 and 125323 ... ..
125299	1948	Shuttle Race Back for 125306 ... ..
125300	—	Shuttle Race Body 125304, with 125290, two each 391j and 125301, for 125306 ... ..
125301	1949	Shuttle Race Back Position Pin for 125300
125302	1948	Shuttle Race Back Spring for 125306 ... ..
125303	1948	Shuttle Race Body for 125304 ... ..
125304	—	Shuttle Race Body 125303 with 125305 and two 662j, for 125300 ... ..

No.	Plate	
125305	1948	Shuttle Race Cap for 125304 ... ..
125306	—	Shuttle Race, complete, Nos. 51261j, 125299, 125300 and 125302 ... ..
125307	1950	Stitch Indicator Plate 125374, with 125309, for 125379 ... .. (Obsolete)
125308	1950	Stitch Indicator Plate Cover for 125379 (Obsolete)
*125309	—	Stitch Regulating Thumb Screw Bushing for 125307 ... .. (Obsolete)
125311	2391	Tension Spring for 125418 ... ..
125316	2391	Thread Take-up Spring for 125418 ... ..
125317	1951	Thread Take-up Spring Regulator for 125368
125319	1946	Throat Plate for 125261 ... ..
125320	1949	Shuttle Bobbin Case Latch Lever for 125288
125322	1949	Shuttle Driver 125297 with 125298 and two 51229e ... ..
125323	—	Oscillating Shaft 125363 with 125283, 125298 and two 51229e ... ..
†125324	1955	Bobbin Winder Bracket (belt cover) for 125327 ... ..
125326	1955	Bobbin Winder Tripping Arm for 125327 and 193614 ... ..
†125327	1955	Bobbin Winder (automatic), complete, Nos. 190b, 15287, 51303b, 51319b, 66601, 125324, 125326, 125366, 125376 and 125462 for Hand Wheel No. 15282 or No. 32672 ... ..
125330	—	Oscillating Shaft Crank Slide Block 15170, with 125060, for 125283 and 125284 ... ..
125331	1949	Arm Oil Pad (felt) for oiling Arm Shaft Back Bearing ... ..
125333	1949	Arm Oil Pad Spring ... ..
125334	1949	Arm Oil Pad Spring Cap ... ..
125335	—	Feed Forked Connection Slide Block 125047 with 1085e, for 125340 ... ..
125336	1946	Shuttle Race Slide for 125338 ... ..
125337	1946	Shuttle Race Slide Spring for 125338 ... ..
125338	—	Shuttle Race Slide, complete, Nos. 125336, 125337 and two 51282j ... ..
† In ordering it is necessary to state Class of Machine.		
125340	—	Feed Forked Connection 125262 with 125335
125341	—	Feed Regulator 125268 with 125345 (Obsolete)
125344	—	Feed Lifting Rock Shaft Screw Centre 304c with 1513j ... ..
125344	—	Feed Rock Shaft Screw Centre 304c with 1513j ... ..

No.	Plate	
125345	--	Feed Reversing Lever 125269, with 1735j, for 125341 ... .. (Obsolete)
125347	1950	Feed Lifting Rock Shaft Crank with 157j, for 125362 ... .. (Obsolete)
125349	1950	Feed Throw-out Lever Retaining Ring for 125267 and 125390 ... ..
125350	4960	Hand Wheel with 125358, for 125364 ... ..
125351	---	Hand Wheel Gear (textolite) for 125352 ... ..
125352	4956	Hand Wheel Gear 125351, with 125356 and 125357, for 125364 ... ..
125353	4956	Hand Wheel Gear Collar with three 51281c, for 125364 ... ..
125354	4956	Hand Wheel Gear Spring for 125364 ... ..
125355	4956	Hand Wheel Gear Spring Retaining Washer for 125364 ... ..
125356	4956	Hand Wheel Gear Spring Stud for 125352 ... ..
125357	4956	Hand Wheel Gear Spring Stud Washer for 125352 ... ..
125358	4956	Hand Wheel Spring Stud for 125350 ... ..
125359	2091	Clamp Stop Motion Clamp Washer for 15K91 Machine ... ..
125360	1949	Clamp Stop Motion Flanged Bushing for 125371 and 125372 ... ..
125361	1950	Feed Bar Throw-out Lever with 1813, for 125362 ... .. (Obsolete)
125362	---	Feed Lifting Rock Shaft Crank, complete, Nos. 51289j, 125347 and 125361, for 125267 ... .. (Obsolete)
125363	---	Oscillating Shaft 125281 with 2049 and 125295 for 125323 ... ..
125364	---	Hand Wheel 125350 with 125352 to 125355 and two 125385 for 15K91 Machine ... ..
125365	2091	Bobbin Winder Frame Spring for 193644 ... ..
125366	---	Bobbin Winder Frame 66670, with 15288 and 125068 for 125327 and 193644 ... ..
*125367	2551	Face Plate for 125384 ... ..
125368	---	Face Plate 125381, with 857b, 50292b and 125317, for 125412 ... ..
125369	1950	Face Plate Thread Guard 125428 with 125373, for 125384 ... ..
*125371	---	Clamp Stop Motion Flanged Bushing 125360 with 51280b, for 15K91 Machine ... ..
125372	---	Clamp Stop Motion Flanged Bushing 125360 with two 462a1, for 15K91 Machine ... ..
125373	---	Face Plate Thread Guard Rivet for 125369 ... ..
125374	---	Stitch Indicator Plate for 125307 (Obsolete) ... ..

No.	Plate	
125376	1955	Bobbin Winder Stop Latch for 125327 and 193644 ... ..
125377	1951	Needle Bar with <del>32510</del> ... ..
125378	1951	Needle Clamp Gib and Thread Guard ... ..
125379	---	Stitch Indicator Plate 125307 with 714b, 38391 and 125308 ... .. (Obsolete)
125381	---	Feed Reversing Handle 45305 with 1550j, for 125398 ... ..
*125382	1951	Thread Take-up Lever with 1822, for 125383 ... ..
125383	---	Thread Take-up Lever 125382 with 50527c ... ..
125384	---	Face Plate 125367, with 15410, 125258 and 125369, for 125368 ... ..
125385	2091	Hand Wheel Gear Spring Cushion Pin (eccentric) for 125364 ... ..
125386	1960	Feed Throw-out Lever with 1813, for 125389 ... ..
125387	1960	Feed Throw-out Lever Spring for 125389 ... ..
125388	1960	Feed Lifting Rock Shaft Crank with 157j, for 125389 ... ..
125389	---	Feed Lifting Rock Shaft Crank, complete, Nos. 51289j and 125386 to 125388, for 125390 ... ..
125390	---	Feed Lifting Rock Shaft, complete, Nos. 125263, 125349 and 125389 ... ..
125395	1955	Bobbin Winder Tension Bracket for 125396 ... ..
125396	---	Bobbin Winder Tension Bracket, complete, Nos. 45847, 45915, 45916, 125395 and 140138b ... ..
125397	2391	Feed Regulator for 125398 ... ..
125398	---	Feed Regulator 125397 with 125381 ... ..
125399	2552	Feed Regulator Hinge Screw Friction Washer ... ..
125400	2391	Stitch Regulating Thumb Screw Friction Washer for 45309 ... ..
125412	2551	Face Plate 125368 with 125418 ... ..
125416	2391	Tension Indicator Flange for 125418 ... ..
125417	2391	Tension Releasing Pin for 125418 ... ..
125418	---	Tension, complete, Nos. 45865, 125314, 125316, 125416, 125417, 125419 to 125421 and two 2102 for 125412 ... ..
125419	2391	Thread Take-up Spring Thread Guard for 125418 ... ..
125420	---	Tension Stud 140175e with 51682b for 125418 ... ..
125421	2391	Tension Indicator for 125418 ... ..
125425b	2391	Arm Side Cover ... ..
125428	2391	Face Plate Thread Guard for 125369 ... ..

No.	Plate	
125462	1955	Bobbin Winder Stop Latch Spring for 125327 and 193644 ... ..

No.	Plate	
140138b	1955	Bobbin Winder Tension Screw for 125396 ...
140175c	2391	Tension Stud for 125420 ...
140347w	2719	Presser Foot Adjusting Thumb Screw for 121877 <i>absolute</i> ...
140545c	1958	Needle Clamp Thumb Screw for 45334 ...
160810	---	Set of Attachments, complete, Nos. 25537, 35931, 36865, 86642, 120378, 121441, 121464, two 8879 and six needles ...
160811	---	Set of Attachments (less needles), complete, Nos. 25537, 35931, 36865, 86642, 120378, 121441, 121464 and two 8879 ...
160845	2719	Cording Foot (left toe) for Stitching on Edge, Inserting Cord and Slide Fastener Work
160846	2719	Cording Foot (right toe) for Stitching on Edge, Inserting Cord and Slide Fastener Work ... ..



No.	Plate	
190439	—	Tube, filled with Singer Lubricant, for Electric Motors, for 190613 ... ..
190612	—	Tube Carton (paper) for 190613 ... ..
190613	—	Tube 190439 with 190612, for 15K91 Machine
192348	1949	Lead Bushing for 192875 ... ..
192424	4959	Field Coil Retainer for 15K91 Machine ...
192457	4959	Brush (carbon) for 50 to 145 volts, for 15K91 Machine ... ..
192458	4959	Brush Spring for 15K91 Machine ... ..
192540	—	Screw Plug, complete, Nos. 192541 and 192542, for 15K91 Machine ... ..
192541	2090	Screw Plug Base for 192540 ... ..
192542	2090	Screw Plug with 192543, for 192540 ... ..
192543	2090	Screw Plug Flash Disc (fibre) for 192542 ...
*192642	—	Three-Pin Terminal Body (male half) for 193700 ... ..
*192643	—	Three-Pin Terminal (female half) Housing (upper) for 192989 ... ..
*192644	—	Three-Pin Terminal (female half) Housing (lower) for 192989 ... ..
192691	2091	Three-Pin Terminal (female half) Insert Sleeve for 192989 ... ..
192692	2091	Three-Pin Terminal (female half) Insert Clamp for 192989 ... ..
192790	4959	Three-Pin Terminal Adaptor Bushing for 192851 ... ..
192793	2091	Three-Pin Terminal Body (male half) Post for 193700 ... ..
192797	4964	Three-Pin Terminal Body (male half), complete, Nos. 193700, three each 51582 and 701719, for 15K91 Machine ... ..
*192820	—	Lead Cord, 8 ft. long, for 192875 ... ..
192851	—	Lead Cord, complete, from lamp socket to three-pin terminal, for Knee and Treadle Control, Nos. 192790, 192852, 192989 and Plug for 15K91 Machine ... ..
*192852	—	Lead Cord for 192851 ... ..
192874	—	Lead Cord, 3 ft. 10 ins. long, for 192875 ...
192875	—	Lead Cord, complete, from lamp socket to three-pin terminal and controller, for Foot Controller, Nos. 192348, 192820, 192874, 192989, Plug and two 195834, for 15K91 Machine ... ..

No.	Plate	
192989	4964	Three-Pin Terminal (female half), complete, Nos. 192643, 192644, two each 1768r, 51093r, three each 192691 and 192692, for 192851 and 192875 ... ..
193294	—	SINGER Light (moulded, less lamp), complete, Nos. 691j, 97359, 191785, 193248, 193289, 193400, 193421, 193431, 193437, 701842, and two 191786 ... ..
193522	—	Motor Frame for 193545 ... ..
193523	4959	Armature Shaft Bearing Sleeve (commutator end) for 193545 ... ..
193524	4959	Armature Shaft Bearing Sleeve (front end) for 193545 ... ..
193525	—	Grease Wick 193526 with 193527, for 15K91 Machine ... ..
193526	4959	Grease Wick for 193525 ... ..
193527	4959	Grease Wick Spring for 193525 ... ..
*193528	—	Armature Shaft for 15K91 Machine ... ..
193529	4959	Armature Shaft Pinion (spiral) with two 462al, for 15K91 Machine ... ..
193536	4960	Commutator, complete, for 15K91 Machine
*193540	—	Armature Core, complete, for 15K91 Machine
193541	4960	Field Core, complete, for 15K91 Machine ...
193542	4959	Armature Shaft Oil Sling for 15K91 Machine
193543	4959	Brush Cap for 15K91 Machine ... ..
193544	4960	Motor Cover for 15K91 Machine ... ..
193545	4960	Motor Frame 193522 with 193523, 193524, two each 447c and 882e, for 193644 ... ..
193546	4959	Brush Tube Insulating Bushing for 15K91 Machine ... ..
193555	4960	Armature, complete, for P.G.K. 3 Motor for 15K91 Machine ... ..
193556	—	Armature, complete, for P.G.K. 5 Motor for 15K91 Machine ... ..
193557	—	Armature, complete, for P.G.K. 6 and P.G.K. 7 Motors for 15K91 Machine ... ..
193558	—	Armature, complete, for P.G.K. 8 Motor for 15K91 Machine ... ..
193559	—	Armature, complete, for P.G.K. 9 Motor for 15K91 Machine ... ..
193560	—	Armature, complete, for P.G.K. 10 and P.G.K. 92 Motors for 15K91 Machine ...
193561	2090	Armature, complete, for P.G.K. 11 and P.G.K. 12 Motors for 15K91 Machine ... ..
193562	—	Armature, complete, for P.G.K. 15 Motor for 15K91 Machine ... ..

No.	Plate	
193563	—	Armature, complete, for P.G.K. 87 Motor for 15K91 Machine ... ..
193564	—	Armature, complete, for P.G.K. 90 Motor for 15K91 Machine ... ..
193565	—	Field Coil, complete, Nos. 193566 and 193567, for P.G.K. 3 Motor for 15K91 Machine ...
193566	—	Field Coil (left) for 193565 ... ..
193567	—	Field Coil (right) for 193565 ... ..
193568	—	Field Coil, complete, Nos. 193569 and 193570, for P.G.K. 5 Motor for 15K91 Machine ...
193569	—	Field Coil (left) for 193568 ... ..
193570	—	Field Coil (right) for 193568 ... ..
193571	—	Field Coil, complete, Nos. 193572 and 193573, for P.G.K. 6 Motor for 15K91 Machine ...
193572	—	Field Coil (left) for 193571 ... ..
193573	—	Field Coil (right) for 193571 ... ..
193574	—	Field Coil, complete, Nos. 193575 and 193576, for P.G.K. 7 Motor for 15K91 Machine ...
193575	—	Field Coil (left) for 193574 ... ..
193576	—	Field Coil (right) for 193574 ... ..
193577	—	Field Coil, complete, Nos. 193578 and 193579, for P.G.K. 8 Motor for 15K91 Machine ...
193578	—	Field Coil (left) for 193577 ... ..
193579	—	Field Coil (right) for 193577 ... ..
193580	—	Field Coil, complete, Nos. 193581 and 193582, for P.G.K. 9 Motor for 15K91 Machine ...
193581	—	Field Coil (left) for 193580 ... ..
193582	—	Field Coil (right) for 193580 ... ..
193583	—	Field Coil, complete, Nos. 193584 and 193585, for P.G.K. 10 and P.G.K. 11 Motors for 15K91 Machine ... ..
193584	—	Field Coil (left) for 193583 ... ..
193585	—	Field Coil (right) for 193583 ... ..
193586	2090	Field Coil, complete, Nos. 193587 and 193588, for P.G.K. 12 Motor for 15K91 Machine
193587	—	Field Coil (left) for 193586 ... ..
193588	—	Field Coil (right) for 193586 ... ..
193589	—	Field Coil, complete, Nos. 193590 and 193591, for P.G.K. 15 Motor for 15K91 Machine
193590	—	Field Coil (left) for 193589 ... ..
193591	—	Field Coil (right) for 193589 ... ..
193592	—	Field Coil, complete, Nos. 193593 and 193594, for P.G.K. 87 Motor for 15K91 Machine
193593	—	Field Coil (left) for 193592 ... ..
193594	—	Field Coil (right) for 193592 ... ..
193595	—	Field Coil, complete, Nos. 193596 and 193597, for P.G.K. 90 Motor for 15K91 Machine

No.	Plate	
193596	—	Field Coil (left) for 193595 ... ..
193597	—	Field Coil (right) for 193595 ... ..
193598	—	Field Coil, complete, Nos. 193599 and 193600, for P.G.K. 92 Motor for 15K91 Machine
193599	—	Field Coil (left) for 193598 ... ..
193600	—	Field Coil (right) for 193598 ... ..
193629	4964	Three-Pin Terminal Body (male half) Bracket for 15K91 Machine ... ..
193640	4959	Grease Wick Spring Retainer for 15K91 Machine ... ..
*193644	—	Motor Frame 193545, with 190b, 51303b, 51319b, 125326, 125365, 125366, 125376 and 125462 for 15K91 Machine ...
*193700	—	Three-Pin Terminal Body (male half) 192642 with three 192793, for 192797 ...
193799	—	Brush (carbon) for 150 to 250 volts for 15K91 Machine ... ..
194113	2091	Brush Tube for 15K91 Machine ... ..
194120	—	SINGER Light Lamp ... ..
<i>NOTE.—When ordering 194120 state voltage required.</i>		
194591	—	Brush (carbon) for 25 and 32 volts for 15K91 Machine ... ..
195834	—	Field Coil Lead Terminal Clip for 15K91 Machine ... ..
195834	—	Lead Terminal Clip for 192875 ... ..

NUMERICAL LIST OF PARTS

105

No.	Plate	
198052	2090	Two-Pin Plug for 15K91 Machine ...
198108	---	Two-Pin Plug (Norwegian) for 15K91 Machine
198138	---	Two-Pin Plug (Danish) for 15K91 Machine
198367	---	Two-Pin Plug (Swiss) for 15K91 Machine ...

108

NUMERICAL LIST OF PARTS

No.	Plate	
701719	2091	Three-Pin Terminal Body (male half) Post Washer for 192797 ... ..
727511	1959	Field Coil Lead Bushing (rubber) for 15K91 Machine ... ..
899418	---	Name Plate for P.G.K. 7 Motor ... ..
899419	---	Name Plate for all P.G.K. Motors except P.G.K. 7 ... ..
931275	---	Armature Wire Separator (linen) for 15K91 Machine ... ..