

PFAFF

345

Unterklassen-Ausstattung

Subclass parts

Composition des sous-classes

Composición de las subclases

Erläuterungen
Explanations

Légende
Explicaciones

Die Liste enthält nur Nähwerkzeuge sowie unterklassenabhängige Teile. Beim Umbau in eine andere Unterklasse bzw. Ausführung können auch noch Maschinenteile erforderlich sein. Geben Sie also bei Bestellungen die genaue Bezeichnung der vorhandenen bzw. der gewünschten Ausführung an.

The list contains only gauge parts and subclass-dependent parts. For a conversion into another subclass or version machine parts may be required as well. Please state the exact classification of the existing or required version on your order.

La liste comprend uniquement des organes de couture et des pièces dépendant des sous-classes. En cas de transformation en une autre sous-classe ou une autre version, il se peut que d'autres pièces de machine soient nécessaires. C'est pourquoi nous vous prions d'indiquer, à la commande, la désignation exacte de la version existante ou souhaitée.

La lista contiene solamente órganos de costura y piezas dependientes de la subclase. En el caso de transformación en otra subclase o en otro tipo, es posible que sean necesarias piezas de la máquina. Al hacer los pedidos, indíquese la denominación exacta del tipo existente o del deseado.

4 Ausführungstyp bei Bestellung angeben.
Model to be stated on order.
Préciser le modèle à la commande.
Indíquese el tipo en los pedidos.

5 Nähmuster bzw. Material einsenden.
Submit sewing sample or material.
Joindre échantillons de couture ou matières.
Enviense muestras de costura.

38/11 Ohne Zahnung
Without teeth
Sans denture
S'in dentado

Unterklassen-Übersicht
Table of subclasses

Table des sous-classes
Tabla de subclasses

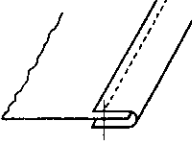
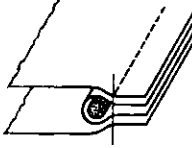
Unterklasse Subclass Sous-classe Subclase	-H3-6/01	-H3-17/01	-H3-40/01
Arbeitsgang Operation Opération Operación	Für allgemeine Näharbeiten. Standardform des Teilesatzes. For ordinary sewing operations. Standard parts set. Travaux d'utilité courante Jeu de pièces standard. Para trabajos de costura en general. Juego de piezas estándar.		
Ausführung Model Version Tipo de máquina	CN	CN	CN
Nadelstange Needle bar Barre à aiguille Barra de aguja	91-710 650-92	91-710 650-92	91-710 650-92
Stoffschieber ^[4] Feed dog Griffe Transportador inferior	91-044 080-04	91-045 539-04 ^[38/11]	91-044 080-04
Stichplatte ^[4] Needle plate Plaque à aiguille Placa de aguja	91-044 262-04	91-040 701-04	91-044 262-04
Stoffrückenfuß ^[4] Presser foot Pied presseur Pie prensatelas	91-040 475-04 x 8,0	91-040 432-04 x 8,0	91-044 102-04 x 8,0 ^[5]
Stoffschiebefuß ^[4] Vibrating presser Pied entraîneur Transportador superior	91-049 269-93 x 5,0	91-042 819-93 x 5,0 ^[38/11]	91-044 101-93 x 5,0 ^[5] ^[38/11]
Fingerschutz Finger guard Garde-doigts Salvatedos	91-057 721-91	91-057 721-91	91-057 721-91
Apparat ^[5] Attachment Appareil Aparato		91-040 533-23	91-044 032-23
Träger Bracket Support Soporte		91-045 543-90	91-042 940-90
Schieber Slide Glissière Corredera	91-014 212-24 x 0,8	91-014 212-24 x 0,8	91-014 212-24 x 0,8
Schieberleiste Slide runner Support de glissière Guía de la corredera	91-015 041-25	91-015 041-25	91-015 041-25
Bandteller Tape disc Plateau dérouleur Disco portacintas		91-043 943-70/995	

Unterklassen-Übersicht
Table of subclasses

Table des sous-classes
Tabla de subclasses

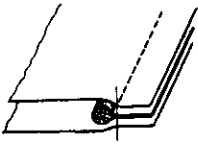
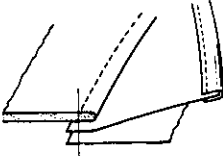
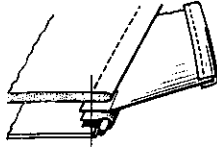
Unterklasse Subclass Sous-classe Subclase	-H3-40/05	-H3-145/01	-H3-159/02
Arbeitsgang Operation Opération Operación			
Ausführung Model Version Tipo de máquina	CN	CN	CN
Nadelstange Needle bar Barre à aiguille Barra de aguja	91-710 650-92	91-710 650-92	91-710 650-92
Stoffschieber ^[4] Feed dog Griffe Transportador inferior	91-044 080-04	91-045 759-04 ^[38/11]	91-047 069-04
Stichplatte ^[4] Needle plate Plaque à aiguille Placa de aguja	91-044 262-04	91-058 516-04	91-048 165-04
Stoffdrückerfuß ^[4] Presser foot Pied presseur Pie prensatelas	91-044 102-04 x 8,0 ^[5]	91-045 764-05 x 8,0	91-040 475-04 x 8,0 91-049 523-05 ^[38/11]
Stoffschiebefuß ^[4] Vibrating presser Pied entraîneur Transportador superior	91-044 101-93 x 5,0 ^[5] ^[38/11]	91-045 763-93 x 5,0 ^[38/11]	91-049 269-93 x 5,0 91-049 030-93 x 5,0 ^[38/11]
Fingerschutz Finger guard Garde-doigts Salvadedos	91-057 721-91	91-057 721-91	91-057 721-91
Apparat ^[5] Attachment Appareil Aparato	91-460 475-23	91-056 181-93	91-494 665-91
Träger Bracket Support Soporte	91-042 940-90		91-042 940-90
Schieber Slide Glissière Corredera	91-014 212-24 x 0,8	91-014 212-24 x 0,8	91-014 212-24 x 0,8
Schieberleiste Slide runner Support de glissière Guía de la corredera	91-015 041-25	91-014 677-35	91-041 677-35

Nähwerkzeuge
Gauge parts

Organes de couture
Organos de costura

91-710 650-92

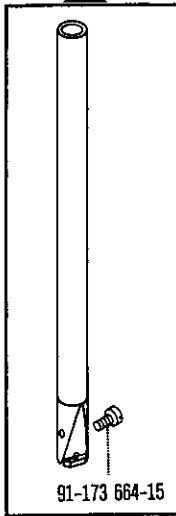

91-173 664-15

-H3-6/01
-H3-17/01
-H3-40/01
-H3-40/05
-H3-145/01
-H3-159/02

91-044 080-04 [4]



-H3-6/01
-H3-40/01
-H3-40/05

91-045 539-04 [4] [38/11]

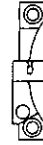

-H3-17/01

91-045 759-04 [4] [38/11]



-H3-145/01

91-047 069-04 [4]

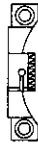

-H3-159/01

91-040 701-04 [4]

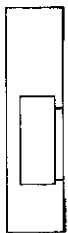

-H3-17/01

91-044 262-04 [4]

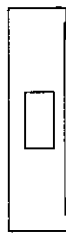

-H3-6/01
-H3-40/01
-H3-40/05

91-048 165-04 [4]

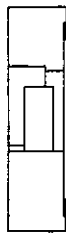

-H3-159/02

91-058 516-04 [4]



-H3-145/01

91-040 432-04 x 8,0 [4]



-H3-17/01

91-040 475-04 x 8,0 [4]



-H3-6/01
-H3-159/02

91-044 102-04 x 8,0 [4] [5]



-H3-40/01
-H3-40/05

91-045 764-04 x 8,0 [4]

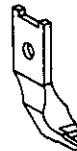

-H3-145/01

91-049 523-05 [38/11]

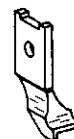

-H3-159/02

Nähwerkzeuge
Gauge parts

Organes de couture
Organos de costura

91-042 819-93 x 5,0 [4]
38/11

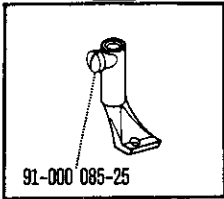

91-000 085-25

-H3-17/01

91-044 101-93 x 5,0 [4] [5]
38/11

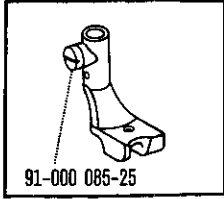

91-000 085-25

-H3-40/01
-H3-40/05

91-045 763-93 x 5,0 [4]
38/11

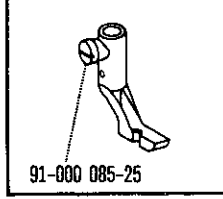

91-000 085-25

-H3-145/01

91-049 030-93 x 5,0 [4]
38/11

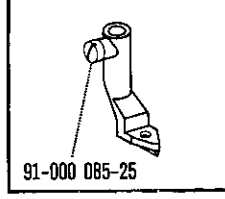

91-000 085-25

-H3-159/02

91-049 269-93 x 5,0 [4]



91-000 085-25

-H3-6/01
-H3-159/02

11-108 222-15 (2 x)

12-305 144-15 (2 x)

91-057 721-91

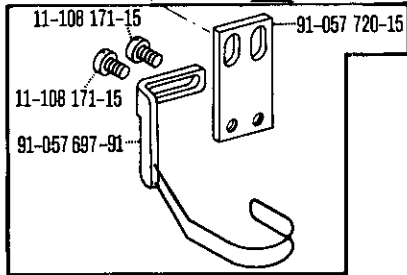

11-108 171-15

91-057 720-15

11-108 171-15

91-057 697-91

-H3-6/01
-H3-17/01
-H3-40/01
-H3-40/05
-H3-145/01
-H3-159/02

91-040 533-23 [5]

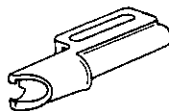

-H3-17/01

91-044 032-23 [5]

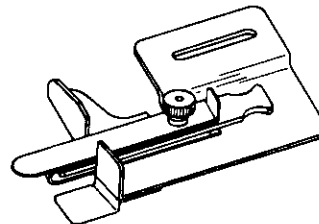

-H3-40/01

91-056 181-93 [5]

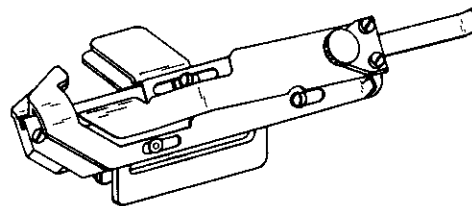

-H3-145/01

91-460 475-23 [5]

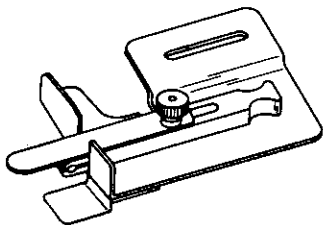

-H3-40/05

91-494 665-91 [5]

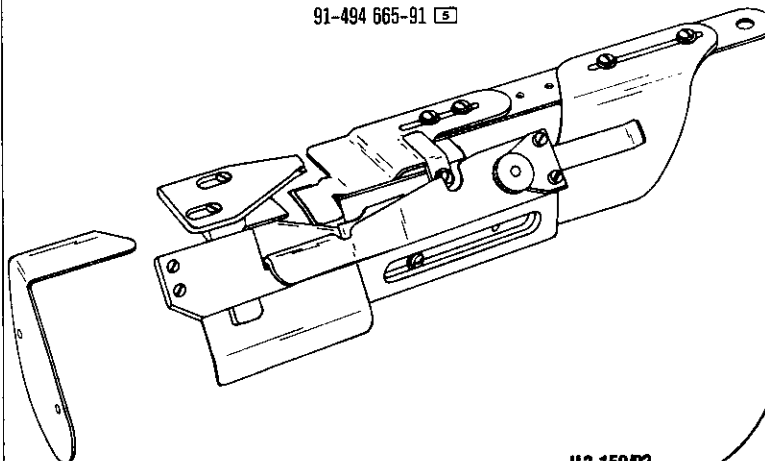

-H3-159/02

Nähwerkzeuge
Gauge parts

Organes de couture
Organos de costura

91-042 940-90

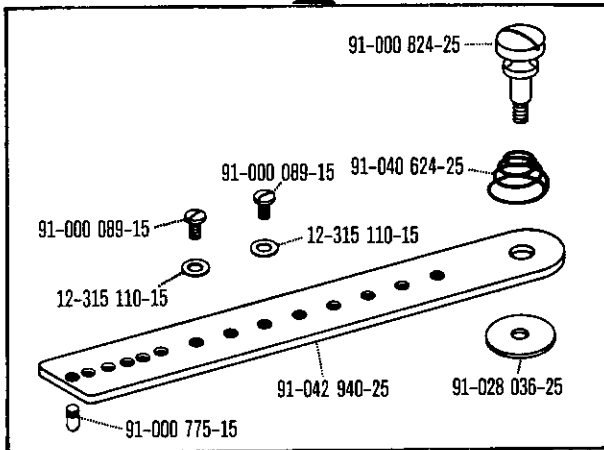

-H3-40/01
-H3-40/05
-H3-159/02

91-043 943-70/995

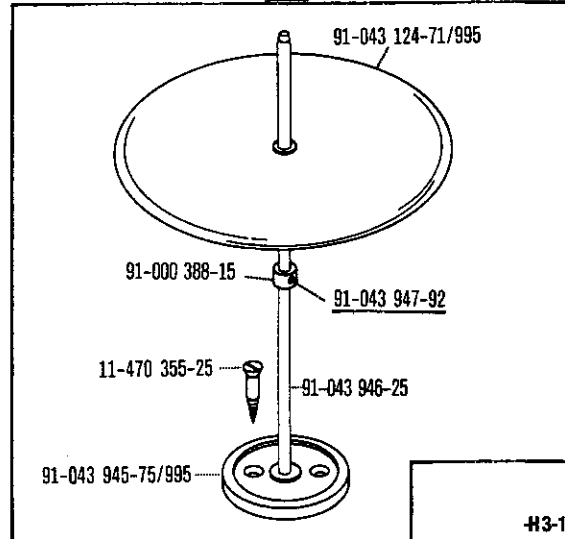

-H3-17/01

91-045 543-90

91-045 543-91

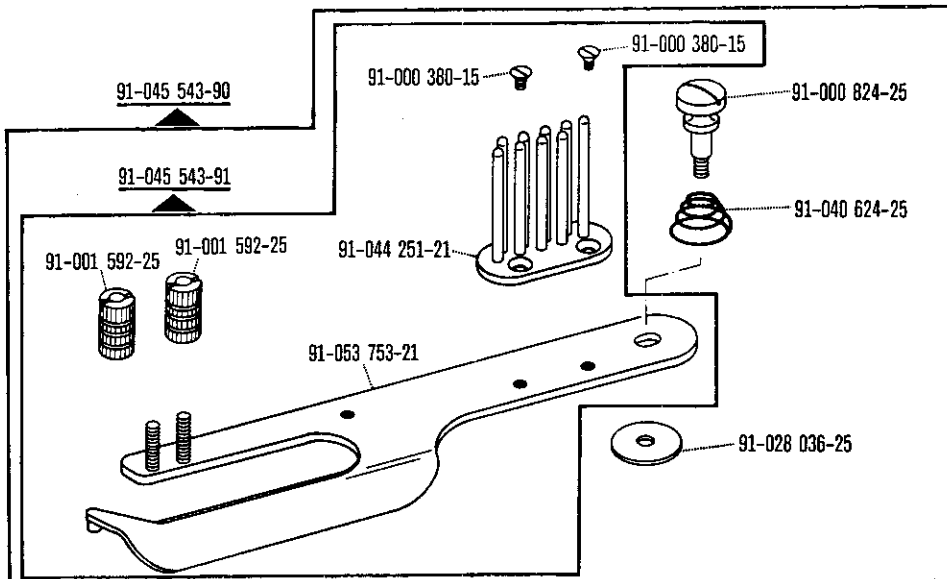

-H3-17/01

91-014 212-24 x 0,8

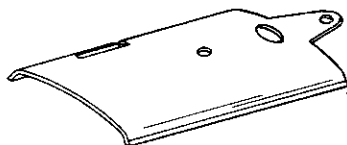

-H3-6/01
-H3-17/01
-H3-40/01
-H3-40/05
-H3-145/01
-H3-159/02

91-014 677-35

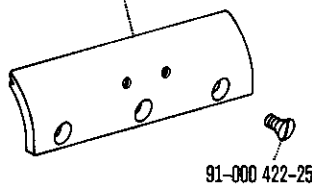

91-000 422-25
-H3-145/01
-H3-159/02

91-015 041-25

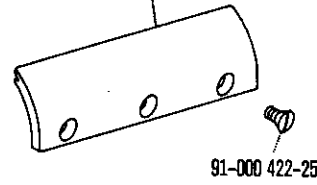

91-000 422-25
-H3-6/01
-H3-17/01
-H3-40/01
-H3-40/05

PFAFF

G.M. PFAFF
Aktiengesellschaft

Postfach 3020
D-67653 Kaiserslautern

Königstr. 154
D-67655 Kaiserslautern

Telefon: (0631) 200-0
Telefax: (0631) 172 02
Telex: 45753 PFAFF D

Gedruckt in der BRD
Printed in Germany
Imprimé en R.F.A.
Impreso en la R.F.A.