

SINGER
112W116

INSTRUCTIONS FOR ORDERING

In ordering from this list, use ONLY the PART number in the FIRST column.

The number stamped on a Sewing Machine Part is the number of the Single Part only, except when the part includes Set Screws, Clamping Screws, Studs and Rollers Spun on, Small Wires riveted, or Parts soldered together, etc., which it is necessary to furnish in combination.

Every combination of parts sent out has its specific number which, although not stamped on Parts (except in above case), must be used when ordering the combination.

Each number always indicates the SAME PART in whatever list it appears, or for whatever Machine.

The letters after some of the numbers indicate the style of finish only, as follows:

- A. Hardened, Polished, Nickel Plated and Buffed.
- B. Polished, Nickel Plated and Buffed.
- C. Hardened only.
- D. Polished only.
- E. Soft, not polished.
- F. Hardened and Polished.
- H. Blued.
- J. Nickel Plated only.
- R. Merlized.
- X. Black Oxide.
- XC. Hardened and Black Oxide.
- Y. Black Nickel only.

These letters MUST BE USED when they appear in the list and AFTER the number, as in the list.

In this series:

- 200001 to 201500 and 350001 to 351500 are Screw Numbers.
- 201501 to 201800 and 351501 to 351800 are Nut Numbers.
- 201801 to 202000 and 351801 to 352000 are Roller Numbers.
- 202001 to 350000 are Numbers of Machine Parts.

The figures in the second column refer only to the plate in which the illustration of the part is shown and are NOT TO BE USED in ordering.

Two or more numbers over a cut indicate that the difference between such parts is not visible in an illustration.

Parts marked with an asterisk (*) are furnished when repairs are made at the factory.

LIST OF PARTS COMPLETE FOR

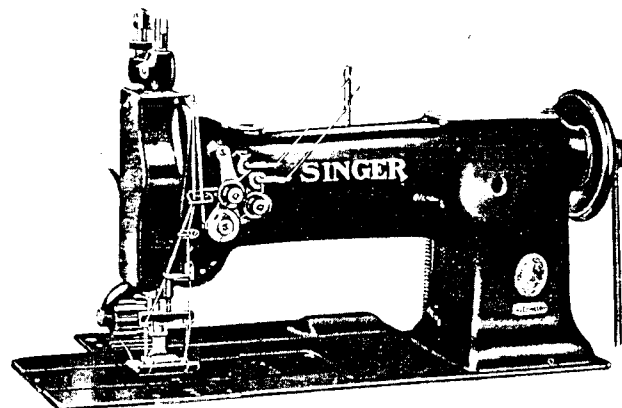

MACHINE No. 112w116

TWO NEEDLE HIGH SPEED
COMPOUND AND PULLER FEEDS

For Tents, Awnings, Overalls, Flag Work, Balloons, etc.

Made in gauges from 3/32 to 2 inches.

No.	Plate	Name
*237175	-----	Arm with 202135
224002	16283	" Cap
200278H	16283	" " Screw
202248	16283	" " " Washer
204235	17788	" Position Pin (2)
200004E	17788	" Screw (3)
202005	17788	" " Washer (3)
224102	16283	" Shaft with 200357E and 224392
240802	16283	" " Bushing (back) with 202244
202244	16283	" " " " Oil Packing (wick)
200338C	16283	Arm Shaft Bushing (back) Set Screw
207080	16283	" " " (front) with 202244
202244	16283	" " " " Oil Packing (wick)
200502H	16283	Arm Shaft Bushing (front) Oil Packing Thumb Screw
200341C	16283	Arm Shaft Bushing (front) Set Screw
224103	17788	" " Connection Belt
224104	17788	" " " " Pulley with 200327C, 200602C and two 202253
200602C	17788	Arm Shaft Connection Belt Pulley Position Screw

PARTS FOR MACHINE NO. 112w116

No.	Plate	Name
200327C	1778B	Arm Shaft Connection Belt Pulley Set Screw
202253	1778B	Arm Shaft Connection Belt Pulley Spring Flange
224113	16287	Arm Shaft Connection Belt Timing Collar with 200113F
200113F	16287	Arm Shaft Connection Belt Timing Collar Set Screw
224139	16287	Arm Shaft Connection Belt Timing Plate
200164B	16287	Arm Shaft Connection Belt Timing Plate Screw (2)
224392	16283	Arm Shaft Oil Packing (wick)
200357E	16283	" " " " Stop Screw
224144	17791	Attachment Slide Plate with 213479 and 236061
236061	17791	Attachment Slide Plate Friction Slide
213479	17791	" " " " " "
		Spring
235132	16283	Balance Wheel (disc) "V" belt groove (outside diam. of belt groove 3.016) with 201346C and 350107C
235096	16283	Balance Wheel (disc) (belt groove 2-1/2 in.diam.) with 200328C and 200335C
		Note: Balance Wheel No.235096 is furnished with this machine unless otherwise specified on order
200328C	16283	Balance Wheel Position Screw
350107C	16283	" " " " " "
200335C	16283	" " Set Screw
201346C	16283	" " " " " "
*237030	-----	Bed with 203376
54897	16287	" Oil Cup
247504	17791	" Slide (back),for use with Throat Plates in gauges from 3/32 to 3/8 inch
223852	17791	Bed Slide (back),for use with Throat Plates in gauges from 13/32 to 2 inch
223811	17791	Bed Slide (back) Stop
223812	17791	" " " " Spring
223853	17791	" " (front),for use with Throat Plates in gauges from 3/32 to 1/2 inch
224043	17791	Bed Slide (front),for use with Throat Plates in gauges from 17/32 to 1 inch
224044	17791	Bed Slide (front),for use with Throat Plates in gauges from 1-1/32 to 1-23/32 inch
237056	17791	Bed Slide (front),for use with Throat Plates in gauges from 1-3/4 to 2 inch

PARTS FOR MACHINE NO. 112w116

No.	Plate	Name
203208	16284	Bobbin (2)
224197	16284	" Case Base with 202056,203211 to 203213 and 203216
203211	16284	Bobbin Case Base Latch
*202056	-----	" " " " Pin
203212	16284	" " " " Plunger
203213	16284	" " " " Spring
237168	16284	" " Cap with 200594C,200984C, 203214,241674,241675 and two 350405C
241674	16284	Bobbin Case Oiling Felt
241675	16284	" " " " Retainer
350405C	16284	" " " " " Screw
224004	16285	" " Opener
224005	16285	" " " Lever with 201349C, 201542C and 203101
201349C	16285	Bobbin Case Opener Lever Driving Screw Stud
201542C	16285	Bobbin Case Opener Lever Driving Screw Stud Nut
203101	16285	Bobbin Case Opener Lever Driving Screw Stud Oil Packing (wick)
265088	16285	Bobbin Case Opener Lever Hinge Stud with 202277
202277	16285	Bobbin Case Opener Lever Hinge Stud Oil Packing (wick)
200364C	16285	Bobbin Case Opener Lever Hinge Stud Set Screw
223623	16285	Bobbin Case Opener Lever Link
200118D	16285	" " " Screw
203214	16284	" " Tension Spring
200984C	16284	" " " " Regulating Screw
200594C	16284	Bobbin Case Tension Spring Screw
205216	16284	" " Washer (cloth)
237169	16284	Bobbin Case complete,Nos.224197 and 237168
210911	17791	Face Plate
202135	17791	" " Position Pin
200473B	17791	" " Thumb Screw
224050	16245	Feed Bar with 200336E and 201535E
224051	16245	" " 224050 with 200040C,224052 and 225837
350393C	16245	Feed Bar Hinge Screw (driving)
201518E	16245	" " " " Nut
223637	16254	Feed Dog,50 needle hole,for needle sizes 14 and 15,in 3/32 in.gauge, for 224030
223629	16254	Feed Dog,46 needle hole,for needle sizes 16 and 18,in gauges 1/8, 5/32,3/16 and 7/32 in.,for 224030
223628	16254	Feed Dog,46 needle hole,for needle sizes 16 and 18,in gauges from 1/4 to 13/32 in.,in steps of 1/32 in., for 223884

PARTS FOR MACHINE NO. 112w116

No.	Plate	Name
223632	16254	Feed Dog, 46 needle hole, for needle sizes 16 and 18, in gauges from 7/16 to 31/32 in., in steps of 1/32 in., for 224033
223635	16255	Feed Dog, 46 needle hole, for needle sizes 16 and 18, in gauges from 1 to 1-1/2 in., in steps of 1/32 in., for 224035
237064	17798	Feed Dog, 46 needle hole, for needle sizes 16 and 18, in gauges from 1-17/32 to 2 in., in steps of 1/32 in., for 237070
200106E	16254	Feed Dog Screw (2)
200336E	16245	" " Support Screw
201535E	16245	" " " " Nut
237565	17788	Feed Driving Connection with 200049D and 202330
201171C	17788	Feed Driving Connection Hinge Screw
201517E	17788	" " " " " " Nut
202277	17788	" " " " " " Oil
		Packing (wick)
202330	17788	Feed Driving Connection Oil Packing (wick)
200049D	17788	Feed Driving Connection Pinch Screw
237521	17788	" " Eccentric Regulating Bracket
237043	17788	Feed Driving Eccentric Regulating Bracket 237521 with 224108, two each 200256C and 201525E
224108	17788	Feed Driving Eccentric Regulating Bracket Flange with 200383C and 200437C
200437C	17788	Feed Driving Eccentric Regulating Bracket Flange Position Screw
200383C	17788	Feed Driving Eccentric Regulating Bracket Flange Set Screw
200256C	17788	Feed Driving Eccentric Regulating Bracket Hinge Screw
201525E	17788	Feed Driving Eccentric Regulating Bracket Hinge Screw Nut
202301	17788	Feed Driving Eccentric Regulating Bracket Plunger
237523	17788	Feed Driving Eccentric Regulating Bracket Plunger Spring
200607C	17788	Feed Driving Eccentric Regulating Bracket Plunger Spring Stop Screw
200256C	17788	Feed Driving Eccentric Regulating Bracket Stop Screw
201525E	17788	Feed Driving Eccentric Regulating Bracket Stop Screw Nut
200429C	17788	Feed Driving Eccentric Regulating Screw
200383C	17788	Feed Driving Eccentric Regulating Screw Check Screw

PARTS FOR MACHINE NO. 112w116

No.	Plate	Name
223650	16245	Feed Driving Rock Shaft
223651	16245	" " " " 223650 with 201518E, 224051 and 350393C
223652	16245	Feed Driving Rock Shaft Crank with 200019E
200019E	16245	Feed Driving Rock Shaft Crank Pinch Screw
202625	16245	Feed Driving Rock Shaft Stop Collar with two 200383C (2)
200383C	16245	Feed Driving Rock Shaft Stop Collar Set Screw
224154	16287	Feed Lifting Cam with 201220C
224052	16245	" " " " Fork with 200173D and 223655
200040C	16245	Feed Lifting Cam Fork Screw
225837	16245	" " " " " " Washer
223655	16245	" " " " Oiling Felt
200173D	16245	" " " " " " Screw
201220C	16287	" " " " Set Screw
224122	16283	" " " " Regulating Spindle with 202311, 202443 and 202619
*202311	-----	Feed Regulating Spindle Head
202443	16283	" " " " " " Pin
202619	16283	" " " " " " Position Pin
224016	16284	Hook (sewing)
224115	16284	" 224016 with 224025, 224100, two each 200590H and 201253F
237171	16284	Hook and Bobbin Case complete, Nos. 224115 and 237169
224019	16285	Hook Bushing (lower) (bronze)
200364C	16285	" " " " Set Screw
224020	16285	" " (upper) (bronze)
200446C	16285	" " " " Position Screw
223867	16287	" " " " Driving Gear (spiral) with 200362C and 201222C (2)
201222C	16287	Hook Driving Gear Position Screw
200362C	16287	" " " " Set Screw
224021	16285	" " " " Pinion (spiral) with two 200382C
200382C	16285	Hook Driving Pinion Set Screw
224022	16285	" " " " Thrust Washer
224110	16287	" " " " Shaft
224111	16287	" " " " Bushing with 202244
202244	16287	" " " " " " Oil Packing (wick)
200327C	16287	Hook Driving Shaft Bushing Set Screw
224112	16287	" " " " " " Connection Belt Pulley with 202253 and two 201254C
201254C	16287	Hook Driving Shaft Connection Belt Pulley Set Screw
202253	16287	Hook Driving Shaft Connection Belt Pulley Spring Flange
224100	16284	Hook Gib
201253F	16284	" " " " Screw
223849	16285	Hook Saddle (left) with 200009E

PARTS FOR MACHINE NO. 112w116

No.	Plate	Name
223850	16286	Hook Saddle (right) with 200009E
224023	16285	" " 223849 with 200364C, 200446C 224019 and 224020
224024	16286	Hook Saddle 223850 with 200364C 200446C, 224019 and 224020
223680	16287	Hook Saddle Bearing (left)
200327C	16287	" " " " Set Screw
223681	16287	" " " (right)
200335C	16287	" " " " Set Screw
200009E	16285	" " Pinch Screw
200006E	16285	" " Screw (2)
225585	16285	" " Washer (2)
224117	16285	Hook Saddle (left) complete, Nos. 200118D, 200364C, 223623, 224004, 224005, 224021 to 224023, 237171 and 265088
224118	16286	Hook Saddle (right) complete, Nos. 200118D, 200364C, 223623, 224004, 224005, 224021, 224022, 224024, 237171 and 265088
224025	16284	Hook Washer
200590H	16284	" " Screw
240067	17791	Knee Lifter Connection Lever
200262H	17791	" " " " Hinge Screw
223684	17791	Knee Lifter Connection Lever Lifting Rod with 202302
202302	17791	Knee Lifter Connection Lever Lifting Rod Cotter Pin
206628	17791	Knee Lifter Connection Lever Lifting Rod Spring
227227	17791	Knee Lifter Connection Lever Lifting Rod Spring Collar with 200113F
200113F	17791	Knee Lifter Connection Lever Lifting Rod Spring Collar Set Screw
240068	17791	Knee Lifter Lifting Lever
200262H	17791	" " " " Hinge Screw
237034	17789	Needle Bar
238251	17789	" " Connecting Link
264718	17789	" " " " Oil Guard
201183D	17789	" " " " " "
		Screw
202333	17789	Needle Bar Connecting Link Stud with 202254
202254	17789	Needle Bar Connecting Link Stud Oil Packing (wick)
200374C	17789	Needle Bar Connecting Link Stud Set Screw
200383C	17789	Needle Bar Connecting Link Stud Set Screw
264714	17789	Needle Bar Connecting Stud with 200072C and 202277
202277	17789	Needle Bar Connecting Stud Oil Packing (wick)
200072C	17789	Needle Bar Connecting Stud Pinch Screw

PARTS FOR MACHINE NO. 112w116

No.	Plate	Name
202692	17789	Needle Bar Crank with 200335C, 200374C, 200383C, 200428C and 202333
223677	17789	Needle Bar Crank 202692 with 202399, 202400, 223881, 238251 and 264714
203172	17789	Needle Bar Crank Friction Washer
200428C	17789	" " " Position Screw
200335C	17789	" " " Set Screw
237339	17789	" " " Rock Frame
210910	17789	" " " " Hinge Stud with 202277
202277	17789	Needle Bar Rock Frame Hinge Stud Oil Packing (wick)
200347C	17789	Needle Bar Rock Frame Hinge Stud Set Screw
202666	17789	Needle Bar Rock Frame Position Bracket
200098F	17789	" " " " " "
		Screw
223690	16609	Needle Bar Rock Frame Rock Shaft
223691	16609	" " " " " "
		223690 with 200387C and 210920
223692	16609	Needle Bar Rock Frame Rock Shaft Crank with 200029E
223693	17788	Needle Bar Rock Frame Rock Shaft Crank Connection with 202277
200833C	17788	Needle Bar Rock Frame Rock Shaft Crank Connection Hinge Screw
201522E	17788	Needle Bar Rock Frame Rock Shaft Crank Connection Hinge Screw Nut
202277	17788	Needle Bar Rock Frame Rock Shaft Crank Connection Oil Packing (wick)
200029E	16609	Needle Bar Rock Frame Rock Shaft Crank Pinch Screw
202668	16609	Needle Bar Rock Frame Slide Block
210920	16609	" " " " " " 202668 with 201141C
201141C	16609	Needle Bar Rock Frame Slide Block Stud
200387C	16609	" " " " " "
		Set Screw
231383	17798	Needle Holder, in gauges from 3/32 to 15/32 in., in steps of 1/32 in., with 201030F and two 200141F
231402	17798	Needle Holder, in gauges from 1/2 to 3/4 in., in steps of 1/32 in., with 201030F and two 200141F
231403	17798	Needle Holder, in gauges from 25/32 to 1-1/2 in., in steps of 1/32 in., with 201030F and two 200141F
231404	17798	Needle Holder, in gauges from 1-17/32 to 2 in., in steps of 1/32 in., with 201030F and two 200141F
201030F	17798	Needle Holder Screw
200141F	17798	" Set Screw
208566	17789	Presser Bar with 200074F
207072	17789	" " Bushing (lower)
237003	17792	" " " (upper)
200352C	17789	" " " Set Screw (2)

No.	Plate	Name
237004	17789	Presser Bar Lifter
200653C	17789	" " " Hinge Screw
207963	17789	" " " Lifting Releasing Lever Bracket
200975F	17789	Presser Bar Lifting Releasing Lever Bracket Guide Screw
206608	17789	Presser Bar Lifting Releasing Lever Bracket Spring
202337	17789	Presser Bar Position Guide
202338	17789	" " " " Lever with 200086F
200086F	17789	Presser Bar Position Guide Lever Pinch Screw
200352C	17789	Presser Bar Position Guide Set Screw
207965	17791	" " " Spring (flat)
210949	17789	" " " Bracket with 200086C
200086C	17789	" " " " Pinch Screw
200538C	17791	" " " Regulating Screw
200948F	17791	" " " Support Screw
230795	16294	" Foot Hinge Pin
223799	16296	" " " Plate for 223799
224061	16296	" " " " 224062
224079	16296	" " " " 224080
224081	16296	" " " " 224082
224083	16296	" " " " 224084
223770	16296	" " " " 223771
224067	16297	" " " " 224068
224085	16297	" " " " 224086
224087	16297	" " " " 224088
224157	17796	" " " " 224158
224077	16297	" " " " 224078
237059	17799	" " " " 237060
200074F	17789	" " " Screw
223309	16294	" " " Shank
224158	17796	Presser Foot (hinged) complete,50 needle hole,in gauges 3/32 to 3/16 in.,in steps of 1/32 in.,Nos.223309 224157 and 230795
223799	16296	Presser Foot (hinged) complete,50 needle hole,in gauges 5/32 and 3/16 in.,Nos.223309,223798 and 230795
224062	16296	Presser Foot (hinged) complete,50 needle hole,in gauges 7/32 to 5/16 in.,in steps of 1/32 in.,Nos.223309 224061 and 230795
224080	16296	Presser Foot (hinged) complete,50 needle hole,in gauges 11/32 to 7/16 in.,in steps of 1/32 in.,Nos.223309 224079 and 230795
224082	16296	Presser Foot (hinged) complete,50 needle hole,in gauges 15/32 to 9/16 in.,in steps of 1/32 in.,Nos.223309 224081 and 230795
224084	16296	Presser Foot (hinged) complete,50 needle hole,in gauges 19/32 and 5/8 in.,Nos.223309,224083 and 230795

No.	Plate	Name
223771	16296	Presser Foot (hinged) complete,50 needle hole,in gauges 21/32 to 3/4 in.,in steps of 1/32 in.,Nos.223309 223770 and 230795
224133	16296	Presser Foot (hinged) complete,50 needle hole,in gauges from 25/32 to 15/16 in.,in steps of 1/32 in., Nos.223309,224132 and 230795
224068	16297	Presser Foot (hinged) complete,50 needle hole,in gauges 31/32 to 1-1/16 in.,in steps of 1/32 in., Nos.223309,224067 and 230795
224086	16297	Presser Foot (hinged) complete,50 needle hole,in gauges 1-3/32 to 1-3/16 in.,in steps of 1/32 in., 223309,224085 and 230795
224088	16297	Presser Foot (hinged) complete,50 needle hole,in gauges from 1-7/32 to 1-7/16 in.,in steps of 1/32 in., Nos.223309,224087 and 230795
224078	16297	Presser Foot (hinged) complete,50 needle hole,in gauges 1-15/32 and 1-1/2 in.,Nos.223309,224077 and 230795
237060	17799	Presser Foot (hinged) complete,50 needle hole,in gauges from 1-17/32 to 2 in.,in steps of 1/32 in.,Nos. 223309,230795 and 237059
237005	17793	Puller Feed Clutch Case with 200341C and 200347C
200341C	17793	Puller Feed Clutch Case Position Screw
200347C	17793	" " " " Set Screw
237036	17794	" " " " Driving Connection
200919C	17794	" " " " " "
		Hinge Screw
201522E	17794	Puller Feed Clutch Driving Connection Hinge Screw Nut
237007	17794	Puller Feed Clutch Driving Crank with 200035E
201201F	17794	Puller Feed Clutch Driving Crank Hinge Screw
1518E	17794	Puller Feed Clutch Driving Crank Hinge Screw Nut
225585	17794	Puller Feed Clutch Driving Crank Hinge Screw Washer
200035E	17794	Puller Feed Clutch Driving Crank Pinch Screw
237008	17793	Puller Feed Clutch Driving Flange with two 237015
237015	17793	Puller Feed Clutch Driving Flange Pin
237009	17793	" " " " Friction Spring
201456C	17793	" " " " " " Ad-justing Screw
201525E	17793	Puller Feed Clutch Friction Spring Ad-justing Screw Nut
203349	17793	Puller Feed Clutch Friction Spring Ad-justing Screw Washer

No.	Plate	Name
237010	17793	Puller Feed Clutch Retaining Flange with 201457C and two 237015
237015	17793	Puller Feed Clutch Retaining Flange Pin
201457C	17793	Puller Feed Clutch Retaining Flange Screw Stud
200337C	17794	Puller Feed Clutch Retaining Flange Screw Stud Set Screw
201531E	17794	Puller Feed Clutch Retaining Flange Screw Stud Set Screw Nut
237011	17793	Puller Feed Clutch Roller (10)
237012	17793	" " " " Cam (2)
237015	17793	" " " " " Position Pin
200106E	17793	Puller Feed Clutch Roller Cam Screw
237013	17793	" " " " Carrier with 237015
237074	17793	Puller Feed Clutch Roller Carrier Spring
237015	17793	Puller Feed Clutch Roller Carrier Spring Pin
237046	17793	Puller Feed Clutch complete, Nos. 237005, 237008, 237010, two each 237012, 237013, 237074, six 200106E and ten 230711
237016	17794	Puller Feed Cover Plate
200570E	17794	" " " " Screw (2)
237017	17794	" " Roll (lower) (coarse) with 200374C and 200396C
200396C	17794	Puller Feed Roll (lower) Position Screw
200374C	17794	Puller Feed Roll (lower) Set Screw
237018	17794	" " " " Shaft
237019	17794	" " " " " Bracket (2)
200029C	17794	Puller Feed Roll (lower) Shaft Bracket Screw (4)
205797	17794	Puller Feed Roll (lower) Shaft Collar with 200386C
200386C	17794	Puller Feed Roll (lower) Shaft Collar Set Screw
237045	17792	Puller Feed Roll (upper) (coarse)
237021	17792	" " " " Bar
237022	17792	" " " " " Bracket with 200396C and 237015
200256D	17792	Puller Feed Roll (upper) Bar Bracket Screw
200396C	17792	Puller Feed Roll (upper) Bar Bracket Set Screw
237023	17792	Puller Feed Roll (upper) Bar Bracket Support with 200054E
200054E	17792	Puller Feed Roll (upper) Bar Bracket Support Pinch Screw
237037	17792	Puller Feed Roll (upper) Bar Lifter
200550C	17792	" " " " " Hinge Screw

No.	Plate	Name
237015	17792	Puller Feed Roll (upper) Bar Lifter Stop Pin
237024	17792	Puller Feed Roll (upper) Bar Lifting Bracket with 200958C
200958C	17792	Puller Feed Roll (upper) Bar Lifting Bracket Set Screw
237025	17992	Puller Feed Roll (upper) Bar Position Lever with 200054E
200054E	17992	Puller Feed Roll (upper) Bar Position Lever Pinch Screw
237026	17792	Puller Feed Roll (upper) Bar Spring
237027	17792	" " " " " Washer
201458D	17792	Puller Feed Roll (upper) Bar Thumb Screw
237028	17792	Puller Feed Roll (upper) Bracket with 200374C, 200378C and 200396C
200396C	17792	Puller Feed Roll (upper) Bracket Position Screw
200374C	17792	Puller Feed Roll (upper) Bracket Set Screw
237029	17792	Puller Feed Roll (upper) Hinge Stud
200378C	17792	" " " " " Set Screw
223881	17789	Take-up Lever
202399	17789	" " " " Driving Stud with 202277
202277	17789	" " " " " Oil Packing (wick)
202400	17789	Take-up Lever Hinge Stud with 202423
202423	17789	" " " " " Oil Packing (wick)
200363C	17789	Take-up Lever Hinge Stud Set Screw
202401	17789	" " " " Oiling Felt
200132E	17789	" " " " " Screw
223702	17730	<u>Tension Bracket with two each 201224B and 236060</u>
200159F	17790	Tension Bracket Screw
248217	17790	Tension Bracket complete, Nos. 200978H, 201199F, 223702, 223703, 223706, 237174 two each 200309E, 204271, 223438, 223704, three 201572H and four 244049
244048	17790	Tension Disc
236060	17790	" " " " Position Pin
223703	17790	" " " " Release Lever
235072	17789	" " " " Rod
200309E	17790	" " " " Screw
223704	17790	" " " " Plunger
204271	17790	" " " " Washer
223438	17790	" " " " Spring
201224B	17790	" " " " Stud
201572H	17790	" " " " Thumb Nut
223706	17790	Thread Controller Disc
200978H	17790	" " " " " Screw
237174	17790	" " " " Spring
241360	17790	" " " " Stop

No.	Plate	Name
200132E	17790	Thread Controller Spring Stop Screw
201199F	17790	" " Stud with 204925
200061C	17790	" " " Set Screw
201572H	17790	" " " Thumb Nut
204925	17790	" " " Washer
224028	16283	" Guide
224040	17790	" "
210954	17790	" " (lower)
210955	17790	" " (upper)
200582H	17790	" " Screw (4)
240034	17790	" Retainer (2)
200366H	17790	" " Set Screw
224030	16254	Throat Plate, for 223637, in gauges from 3/32 to 7/32 in., in steps of 1/32 inch
223884	16254	Throat Plate, for 223628, in gauges from 1/4 to 13/32 in., in steps of 1/32 inch
224033	16254	Throat Plate, for 223632, in gauges from 7/16 to 31/32 in., in steps of 1/32 inch
224035	16255	Throat Plate, for 223635, in gauges from 1 to 1-1/2 in., in steps of 1/32 inch
237070	17798	Throat Plate, for 237064, in gauges from 1-17/32 to 2 in., in steps of 1/32 inch
200161D	16254	Throat Plate Clamp Screw
203376	16254	" " Position Pin
691F	16254	" " Screw

ACCESSORIES

No.	Plate	Name
200157B	17791	Attachment Screw
203208	16284	Bobbin (10)
225497	17795	" Case Screw Driver
126 x 9	-----	Needle, twelve, size 18
237044	17139	Drip Pan, 20 in. long, with four 3/4 in. wire nails
41564	17795	Machine Rest Pin (wood), 4 in. long
120342	17795	Oiler (copper plated) with 120343
120343	17795	" Spout (3-1/2 in. long)
225498	17795	Screw Driver (7-1/4 in. long)
10875	17795	Wrench

BOBBIN WINDER

259428	16615	Brake (leather)
259429	16615	" Clamp
200113F	16615	" " Screw
225453	16615	Frame with 202277 and 259660
225454	16615	" Hinge Pin
202277	16615	" Oil Packing (wick)
259660	16615	" " Well Washer
225455	16615	" Spring
225456	16615	" " Plunger
225368	16615	Pulley with 200380C
200380C	16615	" Set Screw
225361	16615	Spindle
225444	16615	Stop Latch
200056E	16615	" " Screw
225458	16615	" " Thumb Lever
225459	16615	" " " " Hinge Stud
225459	16615	" " " " Joint Stud
202478	16615	" " Trip Lever
200299H	16615	" " " " Hinge Screw
225461	16615	Tension Bracket with 201499H
200082D	16615	" " Screw
228026	16615	" " " Washer
2102	16615	" Disc
13710	16615	" Spring
201499H	16615	" Stud
201572H	16615	" " Thumb Nut
225462	16615	Bobbin Winder Tension Bracket complete Nos. 13710, 2Q1572H, 225461 and two 2102
259430	16615	Bobbin Winder and Tension Bracket Base

ACCESSORIES

No.	Plate	Name
259431	16615	Universal Bobbin Winder complete, Nos. 200056E, 200082D, 200113F, 200299H 202478, 225368, 225381, 225444, 225453 to 225456, 225458, 225462, 228026, 259428 to 259430, two each 225459 and wood screws 3/4 in., No. 12, R.H.B.

KNEE LIFTER

228359	16643	Rock Lever with two 350231C
228360	16643	" " Bracket with 200347C and three wood screws 7/8 in., No. 12
228361	16643	Rock Lever Bracket 228360 with 228359, 228363, 228367 and 228386
228362	16643	Rock Lever Extension with 200529C
350231C	16643	" " " Set Screw
228363	16643	" " Hinge Pin
228364	16643	" " Knee Plate with 350231C
228388	16643	" " " " " Arm
350231C	16643	" " " " " Set Screw
350231C	16643	" " " " " Set Screw
228365	16643	" " Rod
200529C	16643	" " " Set Screw
228386	16643	" " Spring
228367	16643	" " Stop Stud
200347C	16643	" " " " " Set Screw
228368	16643	Knee Lifter complete, Nos. 228361, 228362 228364, 228365 and 228388

(Other Knee Lifter Parts are listed with
parts of machine head.)

THREAD UNWINDER

FOR THREE SPOOLS

225259	16257	Spool Rest (for one spool) (flat) with 201018C
225257	16257	Spool Rest (for two spools) (flat) with 201018C
150203	16257	Spool Rest Cushion (felt)
225388	16257	" " " Rod
200383C	16257	" " " " " Set Screw

ACCESSORIES

No.	Plate	Name
201018C	16257	Spool Rest Set Screw
259658	16257	" " Stand with 200383C
225391	16257	Thread Guide
201696H	16257	" " Lock Nut
225326	16257	" " Position Cap
225324	16257	" " Rod with 208AL and 225322
208AL	16257	" " " Screw
225322	16257	" " " Washer
259143	16257	Thread Unwinder (for three spools) complete, Nos. 201696H, 225257, 225259, 225324, 225326, 225388, 259658, three each 150203, 225391 and wood screws 7/8 in. Nos. 12

ATTACHMENT SLIDE PLATES

224144	17791	Attachment Slide Plate with 213479 and 236061
224146	17791	Attachment Slide Plate with 213479 and 236061, for use with depressed Throat Plates

FEED DOGS

223629	16254	Feed Dog, 46 needle hole, for needle sizes 16 and 18, in gauges 1/8 to 7/32 in., in steps of 1/32 in., for 224030
223630	16254	Feed Dog, 40 needle hole, for needle sizes 20 and 22, in gauges 1/8 to 7/32 in., in steps of 1/32 in., for 224030
223637	16254	Feed Dog, 50 needle hole, for needle sizes 14 and 15, in gauges 3/32 to 7/32 in., in steps of 1/32 in., for 224030
223889	16254	Feed Dog, 53 needle hole, for needle sizes 12 and 13, in gauges 3/32 to 7/32 in., in steps of 1/32 in., for 224030

FEED DOGS

No.	Plate	Name
223639	16254	Feed Dog,50 needle hole,for needle sizes 14 and 15,in gauges 3/16 and 7/32 in.,for 224031
224007	16254	Feed Dog,53 needle hole,for needle sizes 12 and 13,in gauges 3/16 and 7/32 in.,for 224031
223890	16254	Feed Dog,53 needle hole,for needle sizes 12 and 13,in gauges from 1/4 to 13/32 in.,in steps of 1/32 in.,for 223884
223628	16254	Feed Dog,46 needle hole,for needle sizes 16 and 18,in gauges from 1/4 to 13/32 in.,in steps of 1/32 in.,for 223884
223631	16254	Feed Dog,40 needle hole,for needle sizes 20 and 22,in gauges 1/4 to 13/32 in.,in steps of 1/32 in.,for 223884
224009	16254	Feed Dog,46 needle hole,for needle sizes 16 and 18,in gauges from 1/4 to 13/32 in.,in steps of 1/32 in.,for 224036
224010	16254	Feed Dog,50 needle hole,for needle sizes 14 and 15,in gauges from 7/16 to 27/32 in.,in steps of 1/32 in.,for 224037
224011	16254	Feed Dog,46 needle hole,for needle sizes 16 and 18,in gauges from 7/16 to 27/32 in.,in steps of 1/32 in.,for 224037
223638	16254	Feed Dog,50 needle hole,for needle sizes 14 and 15,in gauges from 1/4 to 13/32 in.,in steps of 1/32 in.,for 223684
224057	16254	Feed Dog,50 needle hole,for needle sizes 14 and 15,in gauges from 1/4 to 13/32 in.,in steps of 1/32 in.,for 224036
223632	16254	Feed Dog,46 needle hole,for needle sizes 16 and 18,in gauges from 7/16 to 31/32 in.,in steps of 1/32 in.,for 224033
223633	16254	Feed Dog,40 needle hole,for needle sizes 20 and 22,in gauges from 7/16 to 31/32 in.,in steps of 1/32 in.,for 224033
223634	16254	Feed Dog,50 needle hole,for needle sizes 14 and 15,in gauges from 7/16 to 31/32 in.,in steps of 1/32 in.,for 224033
223891	16254	Feed Dog,53 needle hole,for needle sizes 12 and 13,in gauges from 7/16 to 31/32 in.,in steps of 1/32 in.,for 224033

FEED DOGS

No.	Plate	Name
223635	16255	Feed Dog,46 needle hole,for needle sizes 16 and 18,in gauges from 1-1/2 in.,in steps of 1/32 in for 224035
223636	16255	Feed Dog,40 needle hole,for needle sizes 20 and 22,in gauges from 1-1/2 in.,in steps of 1/32 in for 224035
223641	16255	Feed Dog,50 needle hole,for needle sizes 14 and 15,in gauges from 1-1/2 in.,in steps of 1/32 in for 224035
224012	16255	Feed Dog,50 needle hole,for needle sizes 14 and 15,in gauges from 1-1/2 in.,in steps of 1/32 in for 224029
224013	16255	Feed Dog,46 needle hole,for needle sizes 16 and 18,in gauges from 1-1/2 in.,in steps of 1/32 in for 224029
224006	16255	Feed Dog,40 needle hole,for needle sizes 20 and 22,in gauges from 1-1/2 in.,in steps of 1/32 in for 224029
223640	16255	Feed Dog,46 needle hole,for needle sizes 16 and 18,in gauges from 7/8 to 1-1/2 in.,in steps of 1/32 in.,for 224032
224008	16255	Feed Dog,40 needle hole,for needle sizes 20 and 22,in gauges from 1-1/2 in.,in steps of 1/32 in.,for 224034
237064	17798	Feed Dog,46 needle hole,for needle sizes 16 and 18,in gauges from 1-17/32 to 2 in.,in steps of 1/32 in.,for 237070
237065	17798	Feed Dog,40 needle hole,for needle sizes 20 and 22,in gauges from 1-17/32 to 2 in.,in steps of 1/32 in.,for 237070
237066	17798	Feed Dog,50 needle hole,for needle sizes 14 and 15,in gauges from 1-17/32 to 2 in.,in steps of 1/32 in.,for 237070
237067	17798	Feed Dog,40 needle hole,for needle sizes 20 and 22,in gauges from 1-17/32 to 2 in.,in steps of 1/32 in.,for 237071
237068	17798	Feed Dog,50 needle hole,for needle sizes 14 and 15,in gauges from 1-17/32 to 2 in.,in steps of 1/32 in.,for 237071
237069	17798	Feed Dog,46 needle hole,for needle sizes 16 and 18,in gauges from 1-17/32 to 2 in.,in steps of 1/32 in.,for 237071

PRESSER FEET

No.	Plate	Name
226887	17799	Presser Foot Bracket
226888	17799	" " Connection Lever
350068D	17799	" " " " Hinge
225586	17799	Screw
206335	17799	Presser Foot Connection Lever Pin
230795	16294	" " Hinge Pin
224186	17796	" " " "
224157	17796	" " Plate for 224187
224188	17796	" " " " 224158
224173	17797	" " " " 224189
224168	17797	" " " " 224174
224065	17796	" " " " 224169
224190	17796	" " " " 224066
224171	17796	" " " " 224191
224183	17796	" " " " 224172
224071	17796	" " " " 224184
224073	17796	" " " " 224072
224075	17796	" " " " 224074
224181	17796	" " " " 224076
223694	16294	" " " " 224182
224155	16294	" " " " 223695
223754	16294	" " " " 224156
223756	16294	" " " " 223755
224063	16294	" " " " 223757
224069	16294	" " " " 224064
223696	17797	" " " " 224070
224128	17797	" " " " 223697
224130	17797	" " " " 224129
223772	17797	" " " " 224131
223798	16296	" " " " 223773
224061	16296	" " " " 223799
223746	16296	" " " " 224062
224079	16296	" " " " 223747
223698	16296	" " " " 224080
224081	16296	" " " " 223699
223748	16296	" " " " 224082
224083	16296	" " " " 223749
223744	16296	" " " " 224084
223770	16296	" " " " 223745
223750	16296	" " " " 223771
224132	16296	" " " " 223751
223785	16296	" " " " 224133
224067	16297	" " " " 223786
224085	16297	" " " " 224068
224087	16297	" " " " 224086
224077	16297	" " " " 224088
		" " " " 224078

PRESSER FEET

No.	Plate	Name
224124	16297	Presser Foot Plate for 224125
224179	16297	" " " " 224180
224177	16297	" " " " 224178
237059	17799	" " " " 237060
237072	17799	" " " " 237073
226889	17799	" " " " (left) for 226893
226890	17799	" " " " (right) for 226893
226080	17799	" " " " Spring
226891	17799	" " " " Shank with 225586
226892	17799	" " " " Guide Plate
200581H	17799	" " " " " " Screw
350145D	17799	" " " " " " " "
224187	17796	Presser Foot (hinged) complete, 53 needle hole, in gauges 3/32 to 3/16 in., in steps of 1/32 in., Nos. 223309, 224186 and 230795
224158	17796	Presser Foot (hinged) complete, 50 needle hole, in gauges 3/32 to 3/16 in., in steps of 1/32 in., Nos. 223309, 224157 and 230795
224189	17796	Presser Foot (hinged) complete, 40 needle hole, in gauges 1/8 to 3/16 in., in steps of 1/32 in., Nos. 223309, 224188 and 230795
224174	17797	Presser Foot (hinged) complete, 50 needle hole, in gauges from 3/16 to 5/16 in., in steps of 1/32 in., Nos. 223309, 224173 and 230795
224169	17797	Presser Foot (hinged) complete, 50 needle hole, in gauges from 11/32 to 5/8 in., in steps of 1/32 in., Nos. 223309, 224168 and 230795
224066	17796	Presser Foot (hinged) complete, 53 needle hole, in gauges 3/32 to 3/16 in., in steps of 1/32 in., Nos. 223309, 224065 and 230795, for lap seam felling
224191	17796	Presser Foot (hinged) complete, 50 needle hole, in gauges 1/8 to 3/16 in., in steps of 1/32 in., Nos. 223309, 224190 and 230795
224172	17796	Presser Foot (hinged) complete, 53 needle hole, in gauges 1/8 to 3/16 in., in steps of 1/32 in., Nos. 223309, 224171 and 230795
224184	17796	Presser Foot (hinged) complete, 53 needle hole, in gauges 1/8 to 3/16 in., in steps of 1/32 in., Nos. 223309, 224183 and 230795, for felling
224072	17796	Presser Foot (hinged) complete, 50 needle hole, in gauges 7/32 to 5/16 in., in steps of 1/32 in., Nos. 223309, 224071 and 230795

PRESSER FEET

No.	Plate	Name
224074	17796	Presser Foot (hinged) complete, 50 needle hole, in gauges 11/32 to 7/16 in., in steps of 1/32 in., Nos. 223309, 224073 and 230795
224076	17796	Presser Foot (hinged) complete, 50 needle hole, in gauges 21/32 to 3/4 in., in steps of 1/32 in., Nos. 223309, 224075 and 230795
224182	17796	Presser Foot (hinged) complete, 53 needle hole, in gauges 21/32 to 3/4 in., in steps of 1/32 in., Nos. 223309, 224181 and 230795
223695	16294	Presser Foot (hinged) complete, 50 needle hole, in gauges from 1/8 to 5/16 in., in steps of 1/32 in., Nos. 223309, 223694 and 230795, for lap seam felling
224156	16294	Presser Foot (hinged) complete, 53 needle hole, in gauges from 1/8 to 5/16 in., in steps of 1/32 in., Nos. 223309, 224155 and 230795, for lap seam felling
223755	16294	Presser Foot (hinged) complete, 50 needle hole, in gauges 11/32 to 7/16 in., in steps of 1/32 in., Nos. 223309, 223754 and 230795, for lap seam felling
223757	16294	Presser Foot (hinged) complete, 50 needle hole in gauges from 1/2 to 9/16 in., in steps of 1/32 in., Nos. 223309, 223756 and 230795, for lap seam felling
224064	16294	Presser Foot (hinged) complete, 50 needle hole, in gauges from 15/32 to 5/8 in., in steps of 1/32 in., Nos. 223309, 224063 and 230795, for lap seam felling
224070	16294	Presser Foot (hinged) complete, 50 needle hole, in gauges 21/32 to 3/4 in., in steps of 1/32 in., Nos. 223309, 224069 and 230795, for lap seam selling
223697	17797	Presser Foot (hinged) complete, 40 needle hole, in gauges from 1/4 to 7/16 in., in steps of 1/32 in., Nos. 223309, 223696 and 230795, for over- all felling
224129	17797	Presser Foot (hinged) complete, 40 needle hole, in gauges from 1/4 to 7/16 in., in steps of 1/32 in., Nos. 223309, 224128 and 230795
224131	17797	Presser Foot (hinged) complete, 40 needle hole, in gauges from 15/32 to 5/8 in., in steps of 1/32 in., Nos. 223309, 224130 and 230795

PRESSER FEET

No.	Plate	Name
223773	17797	Presser Foot (hinged) complete, 50 needle hole, in gauges from 1/8 to 5/16 in., in steps of 1/32 in., Nos. 223309, 223772 and 230795, for lap seam felling
223799	16296	Presser Foot (hinged) complete, 50 needle hole, in gauges 5/32 and 3/16 in., Nos. 223309, 223798 and 230795
224062	16296	Presser Foot (hinged) complete, 50 needle hole, in gauges 7/32 to 5/16 in., in steps of 1/32 in., Nos. 223309, 224061 and 230795
223747	16296	Presser Foot (hinged) complete, 46 needle hole, in gauges 7/32 to 5/16 in., in steps of 1/32 in., Nos. 223309, 223746 and 230795
224080	16296	Presser Foot (hinged) complete, 50 needle hole, in gauges 11/32 to 7/16 in., in steps of 1/32 in., Nos. 223309, 224079 and 230795
223699	16296	Presser Foot (hinged) complete, 46 needle hole, in gauges 11/32 to 7/16 in., in steps of 1/32 in., Nos. 223309, 223698 and 230795
224082	16296	Presser Foot (hinged) complete, 50 needle hole, in gauges 15/32 to 9/16 in., in steps of 1/32 in., Nos. 223309, 224081 and 230795
223749	16296	Presser Foot (hinged) complete, 46 needle hole, in gauges 15/32 to 9/16 in., in steps of 1/32 in., Nos. 223309, 223748 and 230795
224084	16296	Presser Foot (hinged) complete, 50 needle hole, in gauges 19/32 and 5/8 in., Nos. 223309, 224083 and 230795
223745	16296	Presser Foot (hinged) complete, 46 needle hole, in gauges 19/32 and 5/8 in., Nos. 223309, 223744 and 230795
223771	16296	Presser Foot (hinged) complete, 50 needle hole, in gauges 21/32 to 3/4 in., in steps of 1/32 in., Nos. 223309, 223770 and 230795
223751	16296	Presser Foot (hinged) complete, 46 needle hole, in gauges 21/32 to 3/4 in., in steps of 1/32 in., Nos. 223309, 223750 and 230795
224133	16296	Presser Foot (hinged) complete, 50 needle hole, in gauges from 25/32 to 15/16 in., in steps of 1/32 in., Nos. 223309, 224132 and 230795
223786	16296	Presser Foot (hinged) complete, 46 needle hole, in gauges from 25/32 to 15/16 in., in steps of 1/32 in., Nos. 223309, 223785 and 230795

PRESSER FEET

No.	Plate	Name
224066	16297	Presser Foot (hinged) complete, 50 needle hole, in gauges 31/32 to 1-1/16 in., in steps of 1/32 in., Nos. 223309, 224067 and 230795
224086	16297	Presser Foot (hinged) complete, 50 needle hole, in gauges 1-3/32 to 1-3/16 in., in steps of 1/32 in., Nos. 223309, 224085 and 230795
224088	16297	Presser Foot (hinged) complete, 50 needle hole, in gauges from 1-7/32 to 1-7/16 in., in steps of 1/32 in., Nos. 223309, 224087 and 230795
224078	16297	Presser Foot (hinged) complete, 50 needle hole, in gauges 1-15/32 and 1-1/2 in., Nos. 223309, 224077 and 230795
224125	16297	Presser Foot (hinged) complete, 46 needle hole, in gauges 1-15/32 and 1-1/2 in., Nos. 223309, 224124 and 230795
224180	16297	Presser Foot (hinged) complete, 46 needle hole, in gauges 1-3/32 to 1-3/16 in., in steps of 1/32 in., Nos. 223309, 224179 and 230795
224178	16297	Presser Foot (hinged) complete, 40 needle hole, in gauges from 1-7/32 to 1-7/16 in., in steps of 1/32 in., Nos. 223309, 224177 and 230795
237060	17799	Presser Foot (hinged) complete, 50 needle hole, in gauges from 1-17/32 to 2 in., in steps of 1/32 in., Nos. 223309, 230795 and 237059
237073	17799	Presser Foot (hinged) complete, 40 needle hole, in gauges from 1-17/32 to 2 in., in steps of 1/32 in., Nos. 223309, 230795 and 237072
226893	17799	Presser Foot (hinged) (compensating) complete, in gauges from 1 to 2 in., in steps of 1/32 in., Nos. 226887 to 226890, 226892, 350068D, 350145D, two each 200581H, 206335, 226080 and 226891

THROAT PLATES

No.	Plate	Name
224030	16254	Throat Plate, for 223629, 223630, 223637, and 223889, in gauges from 3/32 to 7/32 in., in steps of 1/32 inch
224031	16254	Throat Plate, for 223639 and 224007 in gauges 3/16 and 7/32 inch
223884	16254	Throat Plate, for 223628, 223631, 223638 and 223890, in gauges from 1/4 to 13/32 in., in steps of 1/32 inch.
224036	16254	Throat Plate, for 224009 and 224057, in gauges from 1/4 to 13/32 in., in steps of 1/32 inch
224033	16254	Throat Plate, for 223632 to 223634 and 223891, in gauges from 7/16 to 31/32 in., in steps of 1/32 inch
224037	16254	Throat Plate, for 224010 and 224011, in gauges from 7/16 to 27/32 in., in steps of 1/32 inch
224035	16255	Throat Plate, for 223635, 223636 and 223641, in gauges from 1 to 1-1/2 in., in steps of 1/32 inch
224029	16255	Throat Plate, for 224006, 224012 and 224013, in gauges from 1 to 1-1/2 in., in steps of 1/32 inch
224032	16255	Throat Plate, for 223640, in gauges from 7/8 to 1-1/2 in., in steps of 1/32 inch
224034	16255	Throat Plate, for 224008 in gauges from 1 to 1-1/2 in., in steps of 1/32 inch
237070	17798	Throat Plate, for 237064 to 237066 in gauges from 1-17/32 to 2 in., in steps of 1/32 inch
237071	17798	Throat Plate, for 237067 to 237069, in gauges from 1-17/32 to 2 in., in steps of 1/32 inch

ARM CAP AND THREAD GUIDE

No.	Plate	Name
224045	16200	Arm Cap
223604	16300	" " Thread Guide
223605	16300	" " " " 223604 with 210991 and two 200179H
210991	16300	Arm Cap Thread Guide Latch Spring
200179H	16300	" " " " " " Screw
200172H	16300	" " " " " Screw
224046	16300	Arm Cap and Thread Guide complete, Nos. 223605, 224045 and two 200172H

FOOT LIFTER

PARTS REQUIRED FOR CHANGING FROM
KNEE LIFTER TO FOOT LIFTER

223733	17791	Foot Lifter Lifting Lever Extension
200082D	17791	" " " " " "
		Screw (2)
227561	17791	Foot Lifter Lifting Lever Spring
200835D	17791	" " " " " " Stop Screw

FOOT LIFTER

FOOT LIFTER

No.	Plate	Name
227952	16862	Lever with 227954
227678	16862	" Chain, 48 in. long with 202784
227954	16862	" " Hook (lower)
202784	16862	" " " (upper)
225016	16862	" Hinge Pin
227953	16862	" Stand with two wood screws 1 in. No. 12
227955	16862	Foot Lifter Lever complete, Nos. 225016, 227678, 227952 and 227953

PULLER FEED ROLLS

237017	17794	Puller Feed Roll (lower) (coarse) with 200374C and 200396C
237035	17138	Puller Feed Roll (lower) (fine) with 200374C and 200396C
237038	17138	Puller Feed Roll (lower) (rubber faced) with 200374C and 200396C
237048	17138	Puller Feed Roll (lower) (cork faced) with 200374C and 200396C
237045	17792	Puller Feed Roll (upper) (coarse)
237036	17138	" " " " (fine)
237039	17138	" " " " (rubber faced)
237049	17138	" " " " (cork faced)

STRIP REELS

ATTACHED TO THE TOP OF THE ARM

226199	17800	Strip Reel Disc (6 in. diam.) with 225980
226198	17800	Strip Reel Disc (9 in. diam.) with 225980
225980	17800	Strip Reel Disc Base
227113	17800	" " " Rod (lower) with Strip Guide
227115	17800	Strip Reel Disc Rod (upper) with Strip Guide
227116	17800	Strip Reel Disc Rod Collar

STRIP REELS

No.	Plate	Name
227210	17800	Strip Reel Disc Rod Collar 227116 with 200731E and 227327
200731E	17800	Strip Reel Disc Rod Collar Wing Screw
201484C	17800	" " " " Set Screw
227327	17800	" " " " Tension Spring (spiral)
227108	17800	Strip Reel Support with two 201484C
200017C	17800	" " " Screw
227127	-----	Single Strip Reel complete, Nos. 200017C, 227108, 227115, 227210 and two 226199
227560	-----	Single Strip Reel complete, Nos. 200017C, 227108, 227113, 227210 and two 226198
227212	17800	Double Strip Reel complete, Nos. 200017C 227108, 227113, 227115, two each 226198, 226199 and 227210

STRIP REELS

ATTACHED TO THE UNDER SIDE OF BENCH

226199	17800	Strip Reel Disc (6 in. diam.) with 225890
225980	17800	Strip Reel Disc Base
227148	17800	" " " Rod
227116	17800	" " " Collar
227210	17800	" " " " " 227116 with 200731C and 227327
200731E	17800	Strip Reel Disc Rod Collar Wing Screw
201484C	17800	" " " " Set Screw
227327	17800	" " " " Tension Spring (spiral)
227138	17800	Strip Reel Support with 201484C
227139	17800	Strip Reel complete, Nos. 227138, 227148, 227210, two each 226199 and wood screws 1 in., No. 10

STRIP TENSION DEVICE

231363	17801	Strip Tension Base
231364	17801	" " Plate with 200457D, 201599H and two 200383C
200457D	17801	Strip Tension Plate Adjusting Thumb Screw
201599H	17801	Strip Tension Plate Adjusting Thumb Screw Nut
200383C	17801	Strip Tension Plate Set Screw
231365	17801	" " " Shaft
231366	17801	" " " Spring

STRIP TENSION DEVICE

No.	Plate	Name
231367	17801	Strip Tension Plate Spring Adjusting Collar with 200380C
200380C	17801	Strip Tension Plate Spring Adjusting Collar Set Screw
231368	17801	Strip Tension Strip Guide
200162D	17801	" " " " Screw
231369	17801	Strip Tension Device complete (adjust- able for strips up to 3 in., in width) Nos. 231363 to 231367, two each 200162D, 231368 and wood screws 1 in., No. 12H

MISCELLANEOUS PARTS

USED IN CONJUNCTION WITH THREAD UNWINDER

60913	16257	Spool Weight with 60914
60914	16257	" " Center Pin
225377	16257	" Wire (for small spools)
27739	16257	Thread Cone (wood)
225390	16257	" " Holder





OBSOLETE PARTS



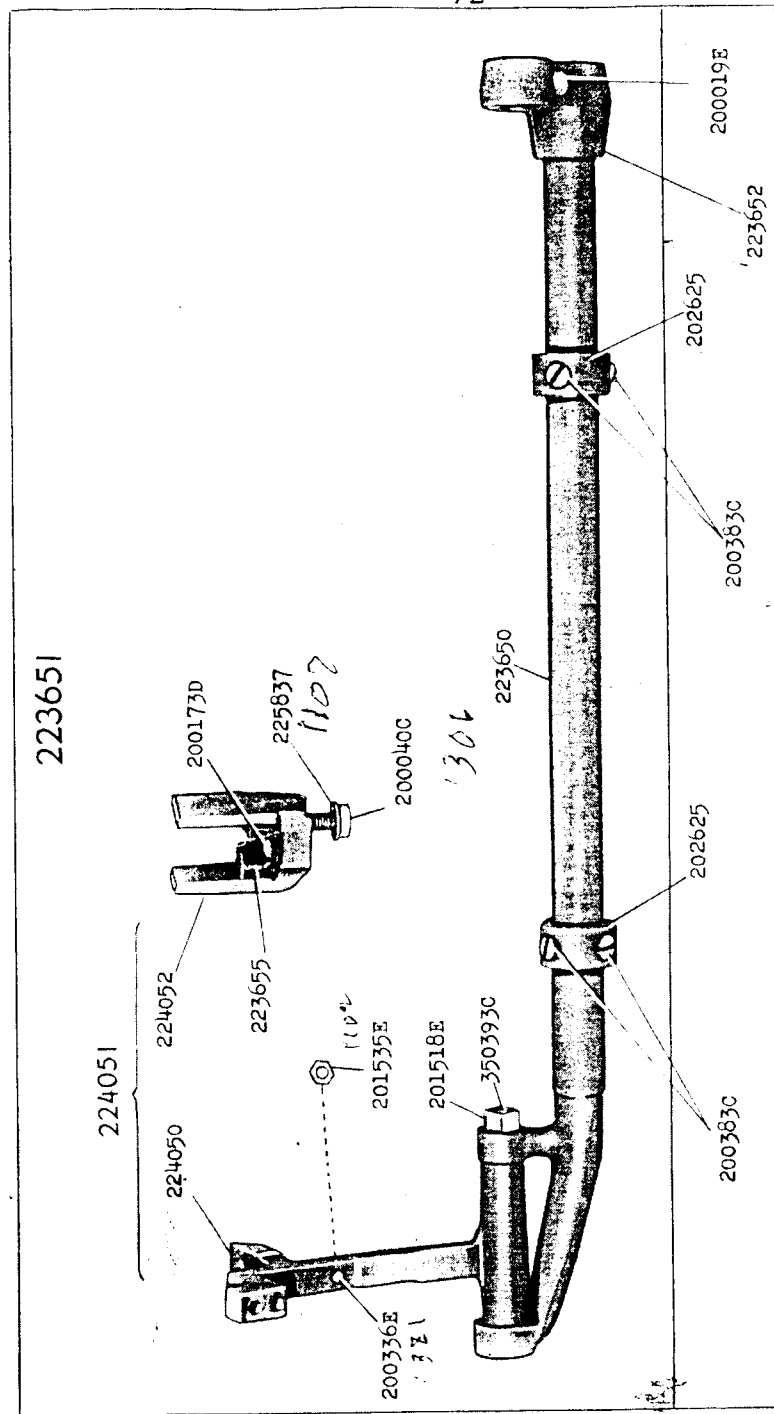

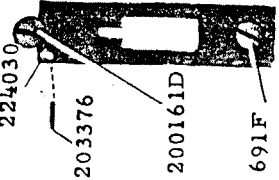
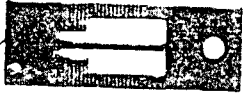
223626	-----	Feed Bar with 200336C and 201535E
223654	-----	" Lifting Cam Fork with 200173D and 223655

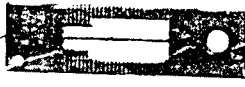
SINGER Needles should be used
 in SINGER Machines.
 These Needles and their Containers
 are marked with the
 Company's Trade Mark "SIMANCO. **" 1

Needles in Containers marked
 "FOR SINGER MACHINES"
 are NOT **SINGER** made needles. 2

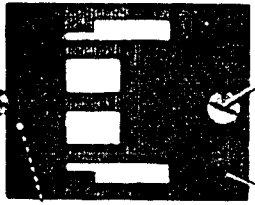

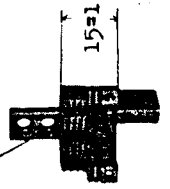
<p>224030 203376 200161D 691F</p>  <p>223630-40 223629-46 223637-50 223889-53</p> <p>200106E</p> <p>15=1</p>	<p>223884</p>  <p>1/4 to 13/32 In steps of 1/32 inch</p> <p>223631-40 223628-46 223638-50 223890-53</p> <p>15=1</p>	<p>224033</p>  <p>7/16 to 31/32 In steps of 1/32 inch</p> <p>223633-40 223632-46 223634-50 223891-53</p> <p>15=1</p>
<p>224037</p>  <p>224011-46 224010-50</p> <p>15=1</p> <p>7/16 to 27/32 In steps of 1/32 inch</p>	<p>224031</p>  <p>3/16-7/32</p> <p>223642-46 223639-50 224007-53</p> <p>15=1</p>	<p>224036</p>  <p>1/4 to 13/32 In steps of 1/32 inch</p> <p>224009-46 224057-50</p> <p>15=1</p>

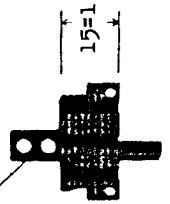
<p>203376 200161D 691F</p>  <p>223635-46 223641-50 1 to 1-1/2</p> <p>227636-40 1-1-1/4-1-1/2 200106E</p> <p>15=1</p> <p>In steps of 1/32 inch</p>	<p>224029</p>  <p>224006-40 224012-50 224013-46</p> <p>15=1</p> <p>1 to 1-1/2 in steps of 1/32 inch</p>	<p>224032</p>  <p>7/8 to 1-1/2 in steps of 1/32 inch</p>
<p>227640-46</p>  <p>15=1</p>	<p>224034</p>  <p>1 to 1-1/2 in steps of 1/32 inch</p>	<p>224008-40</p>  <p>15=1</p>

16257 - 1/6

259143

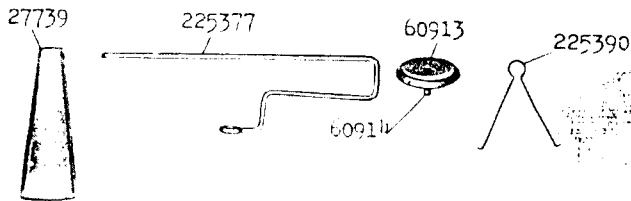
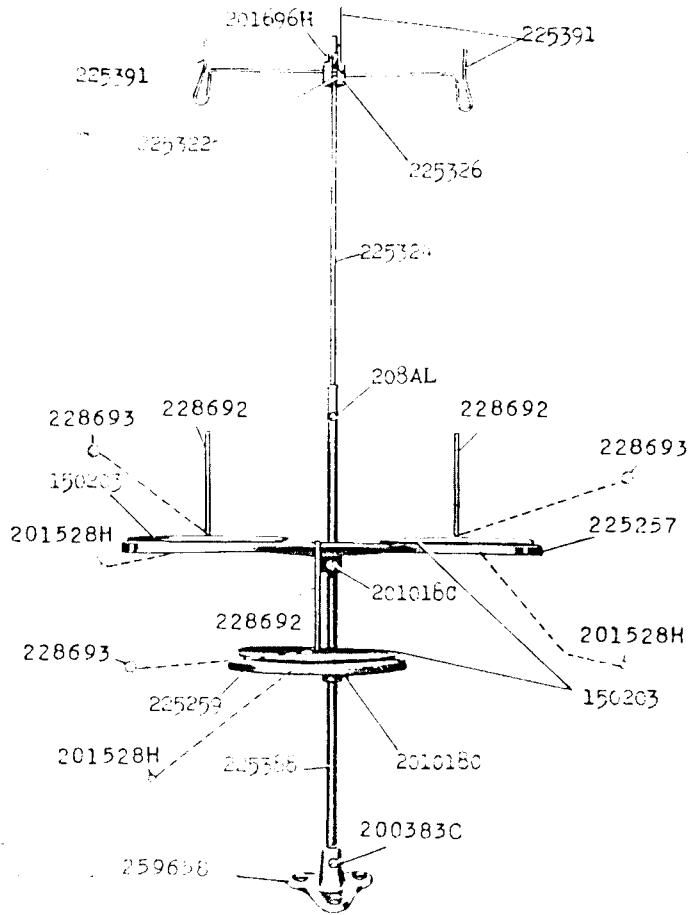

16283 - 3/8

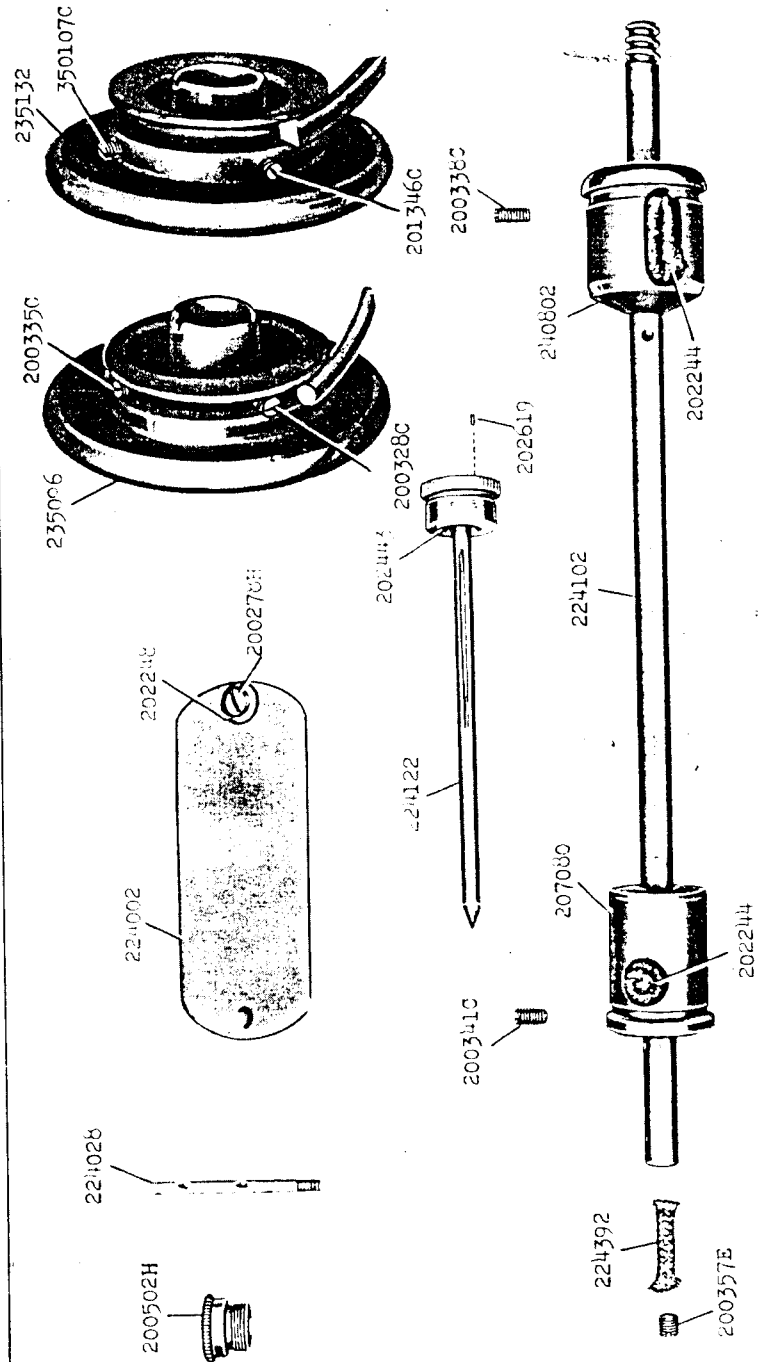

16284

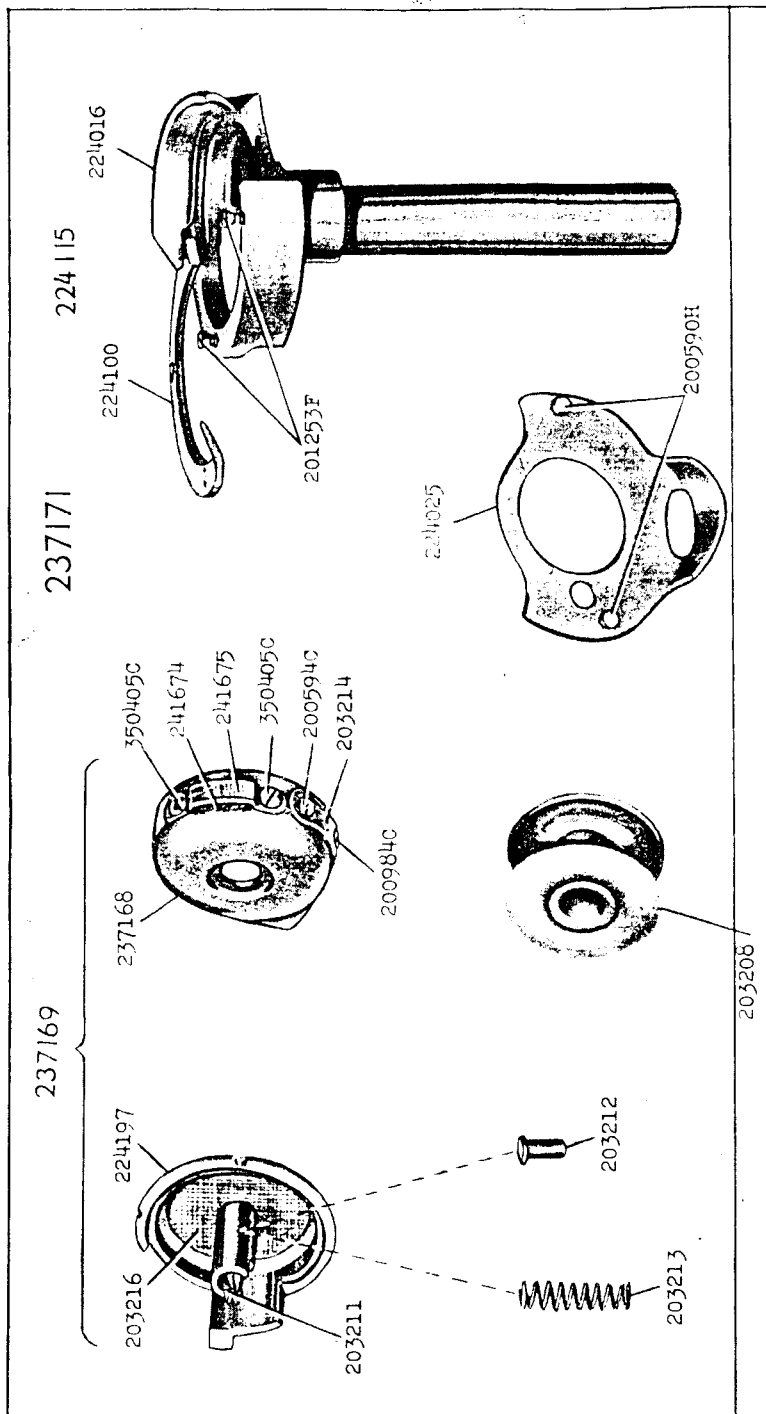

16285 - 2/3

224117

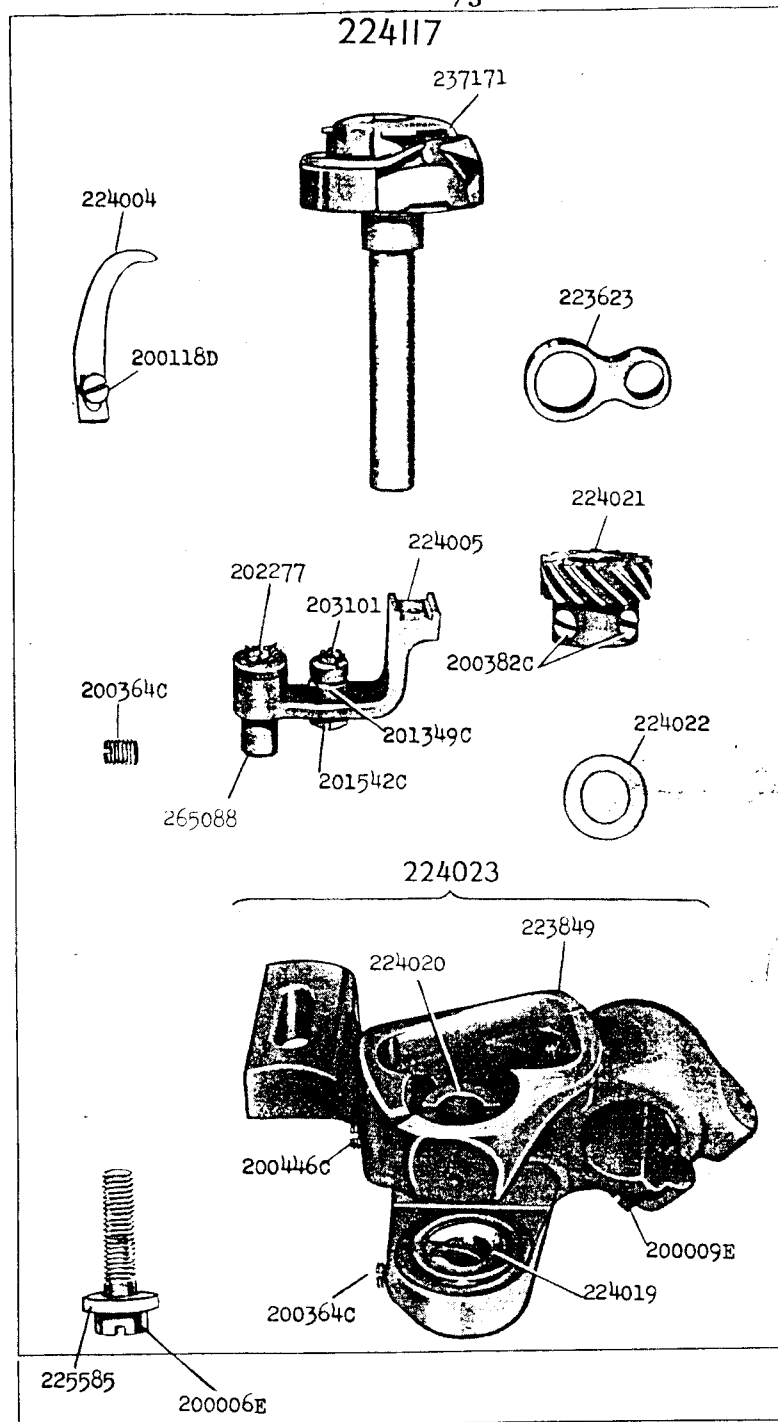

16286 - 2/3

224118

237171

224004

200118D

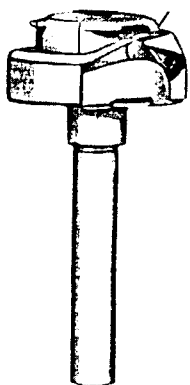

223623



224021



224005

202277

203101

224022

200382C

200364C

215055

201542C

201349C

224024

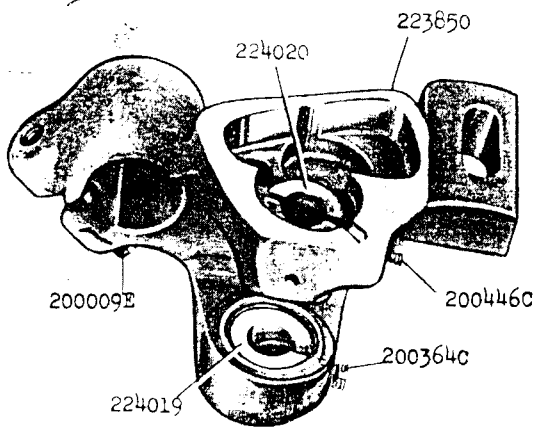

223850

224020

200009E

200446C

224019

200364C



225585

200006E

16287 - 3/8

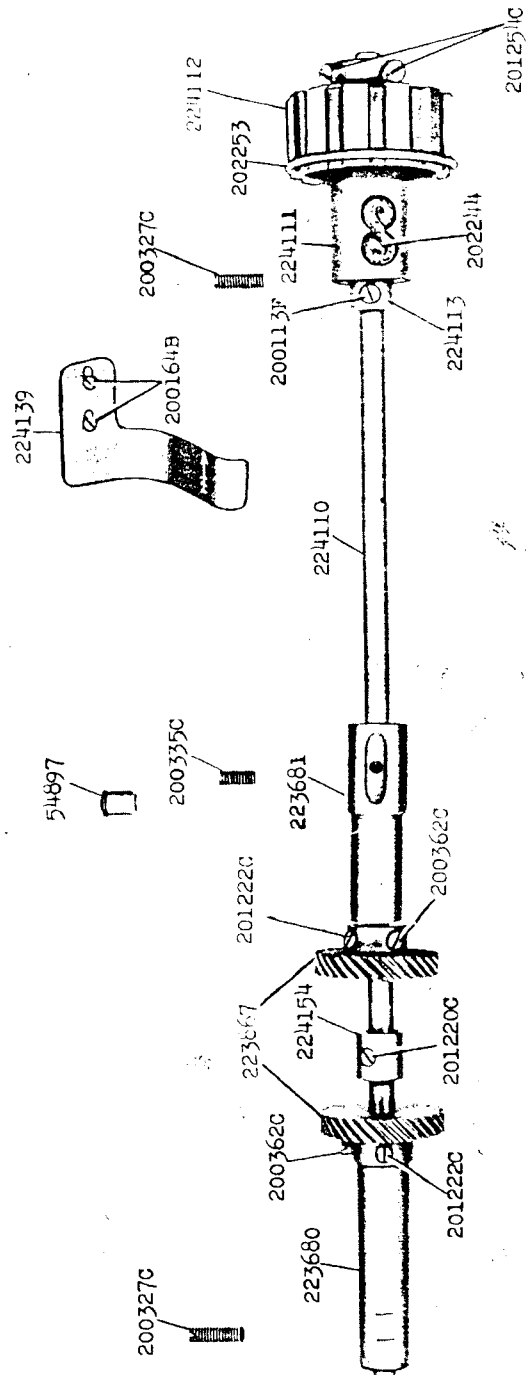

224112

202253

201251C

200327C

224111

202214

224139

200164B

200113F

224113

224110

54897

200335C

223681

200362C

201222C

223687

200362C

201222C

200327C

223680

201222C

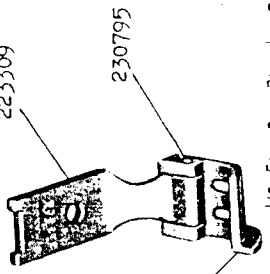
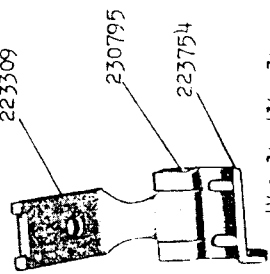
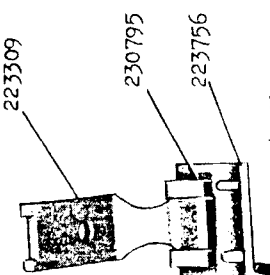
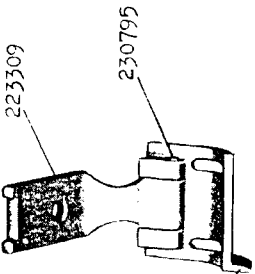
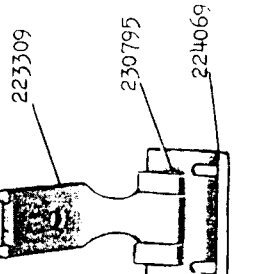
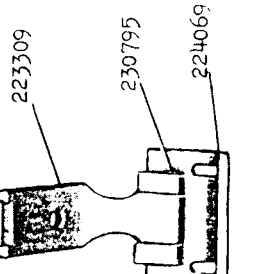
<p>223695-50 224156-53</p>  <p>223309 230795 223694 224155</p> <p>1/8 - 5/32 - 3/16 - 7/32 - 1/4 - 9/32 - 5/16</p>	<p>223755-50</p>  <p>223309 230795 223754</p> <p>1/32 - 3/8 - 1/3 - 3/2 - 7/16</p>	<p>223757-50</p>  <p>223309 230795 223756</p> <p>1/2 - 17/32 - 9/16</p>
<p>224064-50</p>  <p>223309 230795 224063</p> <p>15/32 - 1/2 - 7/32 - 9/16 - 19/32 - 5/8</p>	<p>224070-50</p>  <p>223309 230795 224069</p> <p>2 1/32 - 1 1/16 - 2 3/32 - 3/4</p>	<p>224070-50</p>  <p>223309 230795 224069</p>

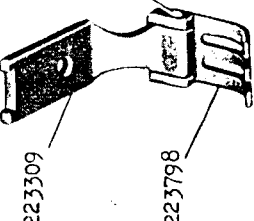
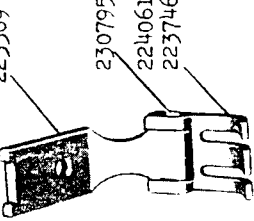
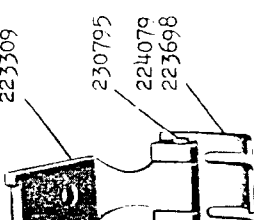
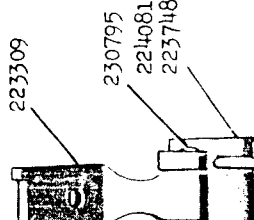
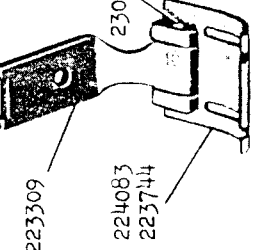
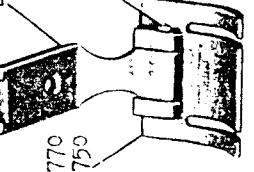
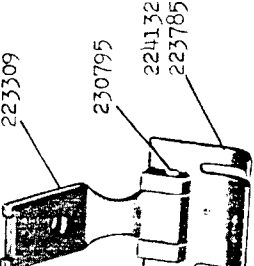
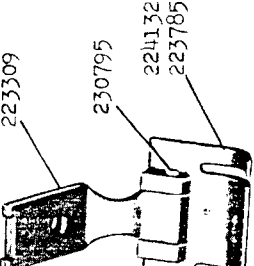
<p>223799-50</p>  <p>223309 230795 223798</p> <p>5/32 - 3/16</p>	<p>224062-50 223747-46</p>  <p>223309 230795 224061 223746</p> <p>7/32 - 1/2 - 9/32 - 5/16</p>	<p>224080-50 223699-46</p>  <p>223309 230795 224079 223698</p> <p>1 1/32 - 3/8 - 13/32 - 7/16</p>	<p>224082-50 223749-46</p>  <p>223309 230795 224081 223748</p> <p>15/32 - 1/2 - 17/32 - 9/16</p>
<p>224084-50 223745-46</p>  <p>223309 230795 224083 223744</p> <p>19/32 - 5/8</p>	<p>223771-50 223751-46</p>  <p>223309 230795 223770 223750</p> <p>2 1/32 - 1 1/16 - 2 3/32 - 3/4</p>	<p>224133-50 223786-46</p>  <p>223309 230795 224132 223785</p> <p>2 5/32 - 3/16 - 27/32 - 7/8 - 2 9/32 - 5/16</p>	<p>224133-50 223786-46</p>  <p>223309 230795 224132 223785</p>

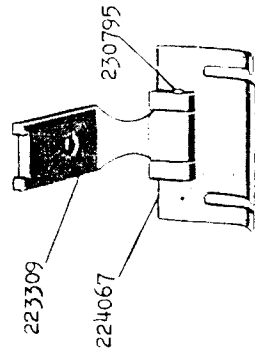
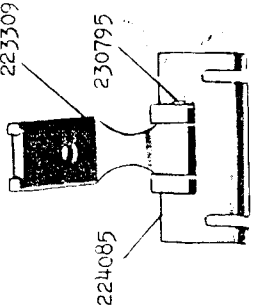
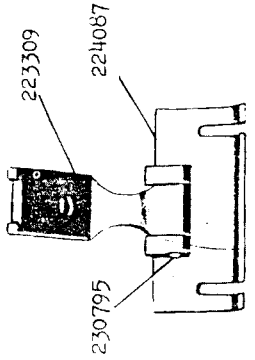
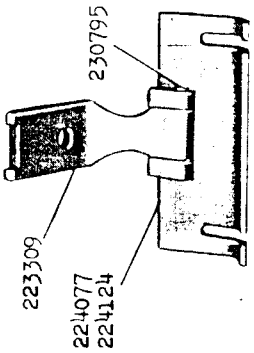
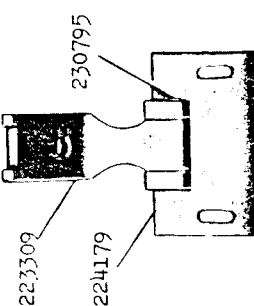
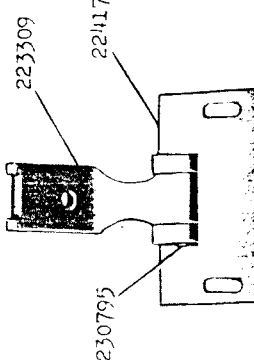
<p>224068-50</p>  <p>223309 224067 230795</p> <p>3/32-1-1/32-1-1/16</p>	<p>224086-50</p>  <p>223309 230795 224085</p> <p>13/32-1-1/8-15/32-1-3/16</p>	<p>224088-50</p>  <p>223309 230795 224087</p> <p>17/32-1-1/4-1-9/32-1-5/16-1-11/32-1-3/8-1-13/32-1-7/16</p>
<p>224078-50 224125-46</p>  <p>223309 224077 224124 230795</p> <p>1-5/32-1-1/2</p>	<p>224180-46</p>  <p>223309 224179 230795</p> <p>13/32-1-1/8-15/32-1-3/16</p>	<p>224178-40</p>  <p>223309 230795 224177</p> <p>17/32-1-1/4-1-9/32-1-5/16-1-11/32-1-3/8-1-13/32-1-7/16</p>

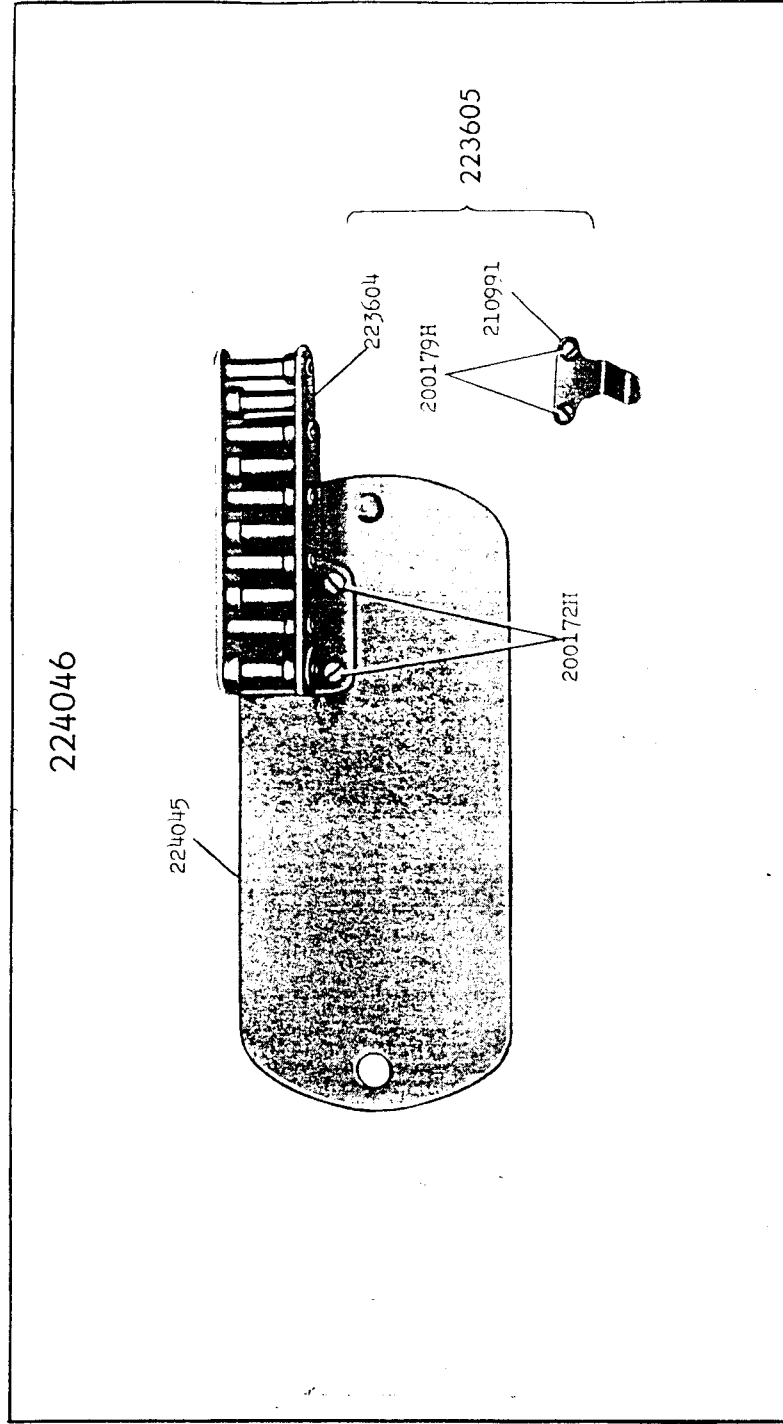

16609 - 1/2

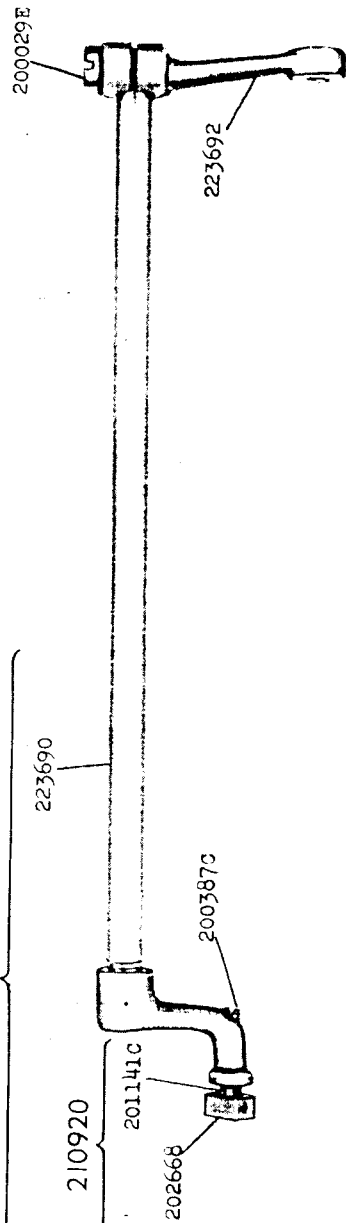

16615 - 1/2

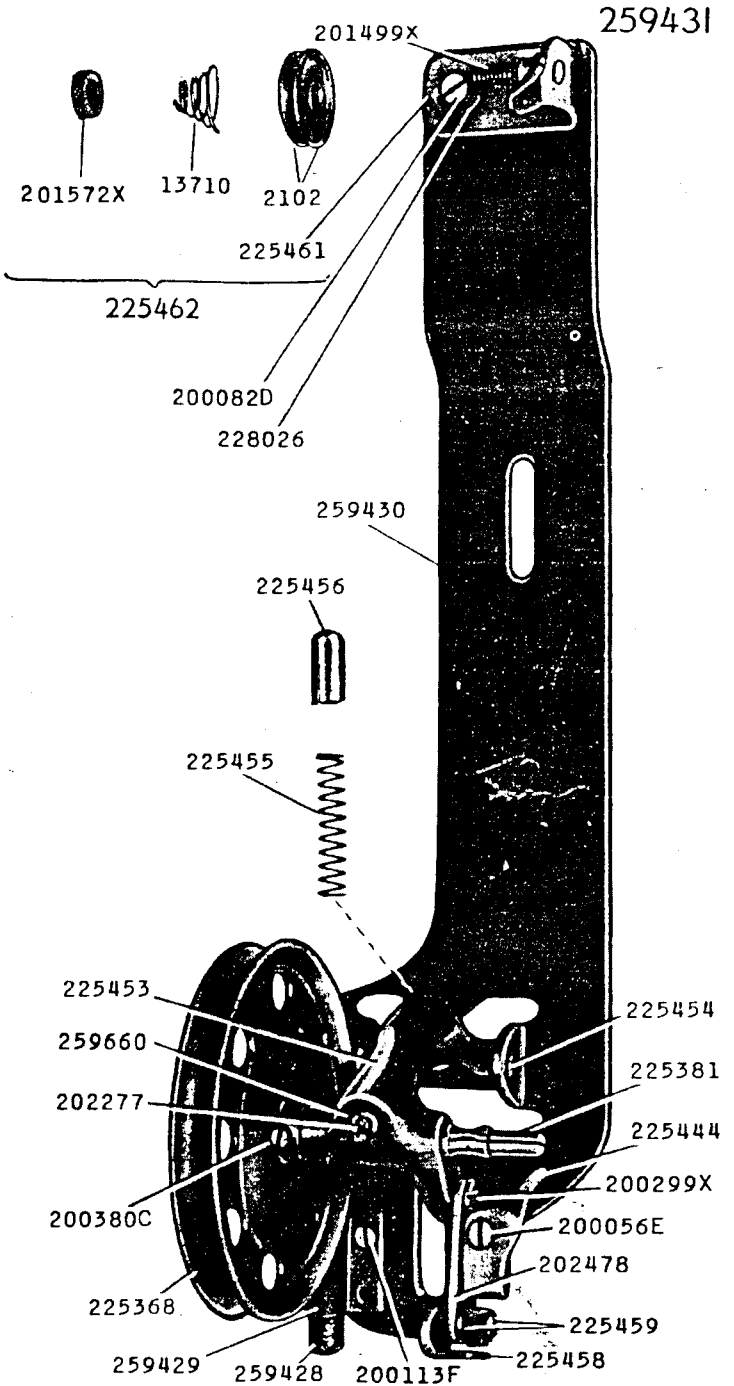

16643 - 3/8

228368

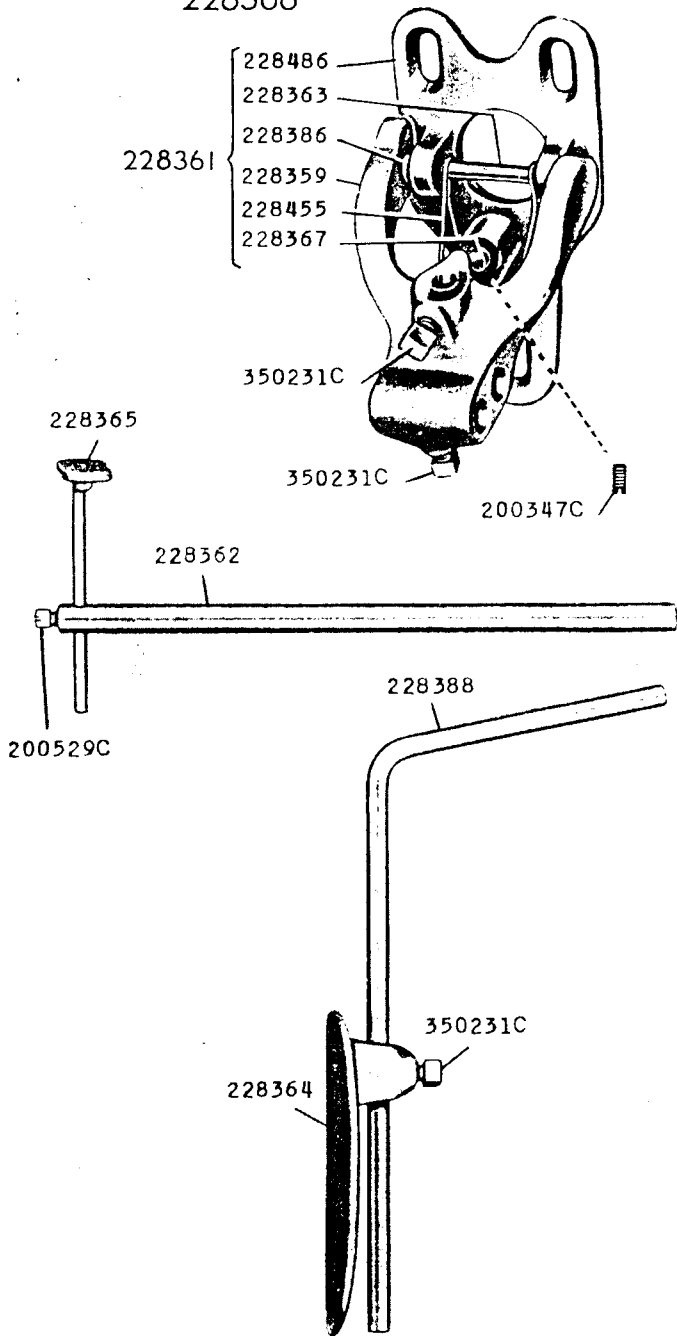

16862 - 1/3

227955

202784

227678-48"

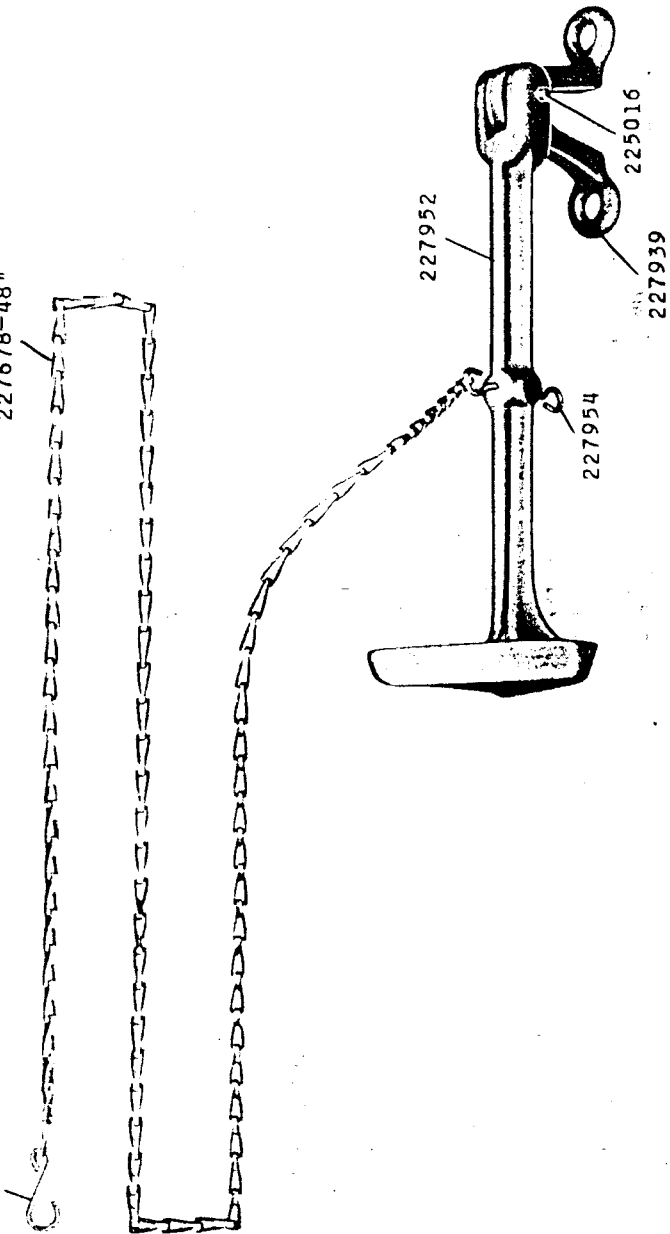

17138 - 5/8

237049

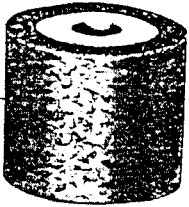

237048

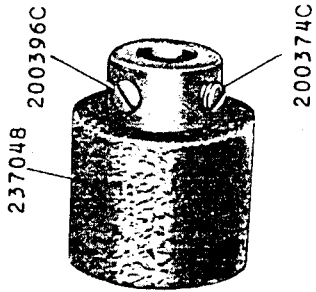

237035

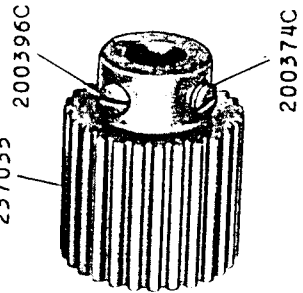

237039

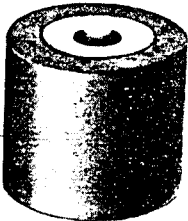

237038

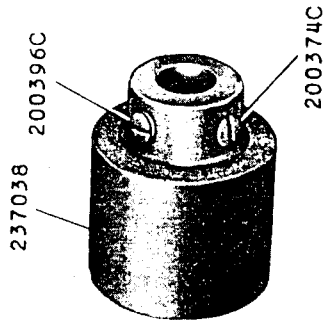

17139 - 1/3

237044



17788 3/8

7043

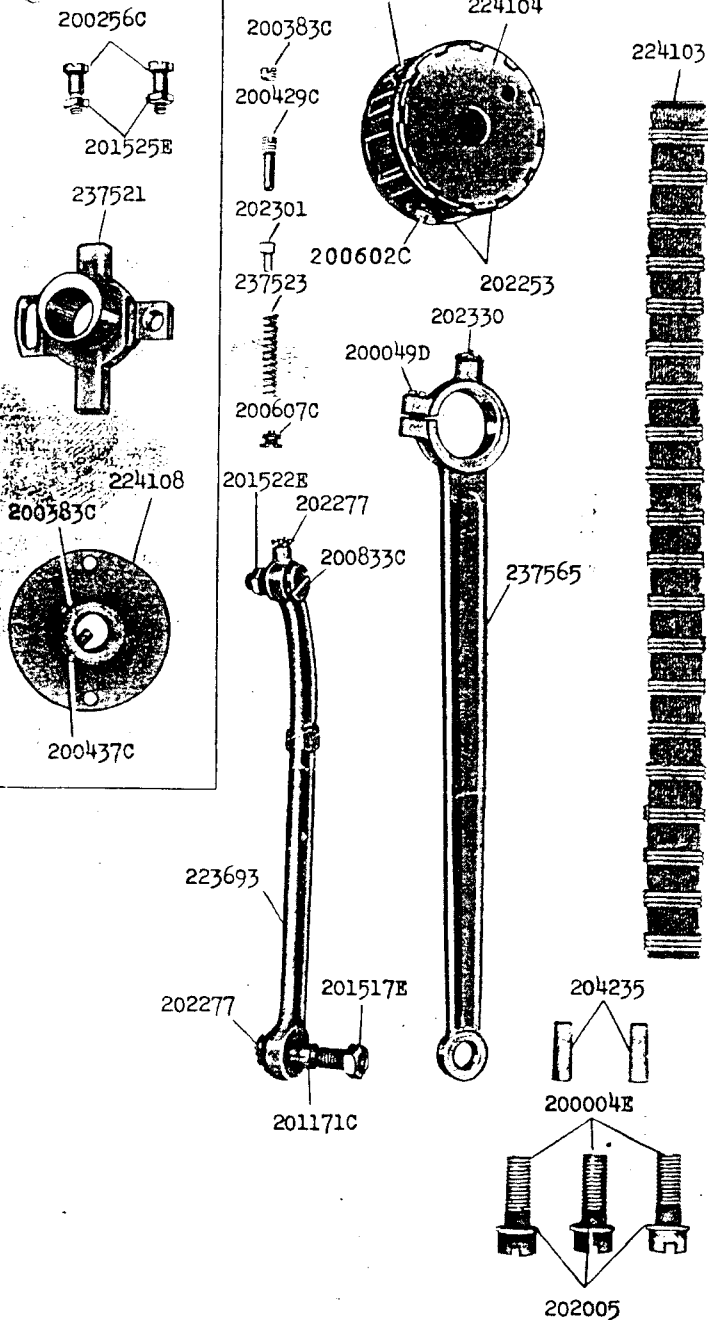

17789 3/8

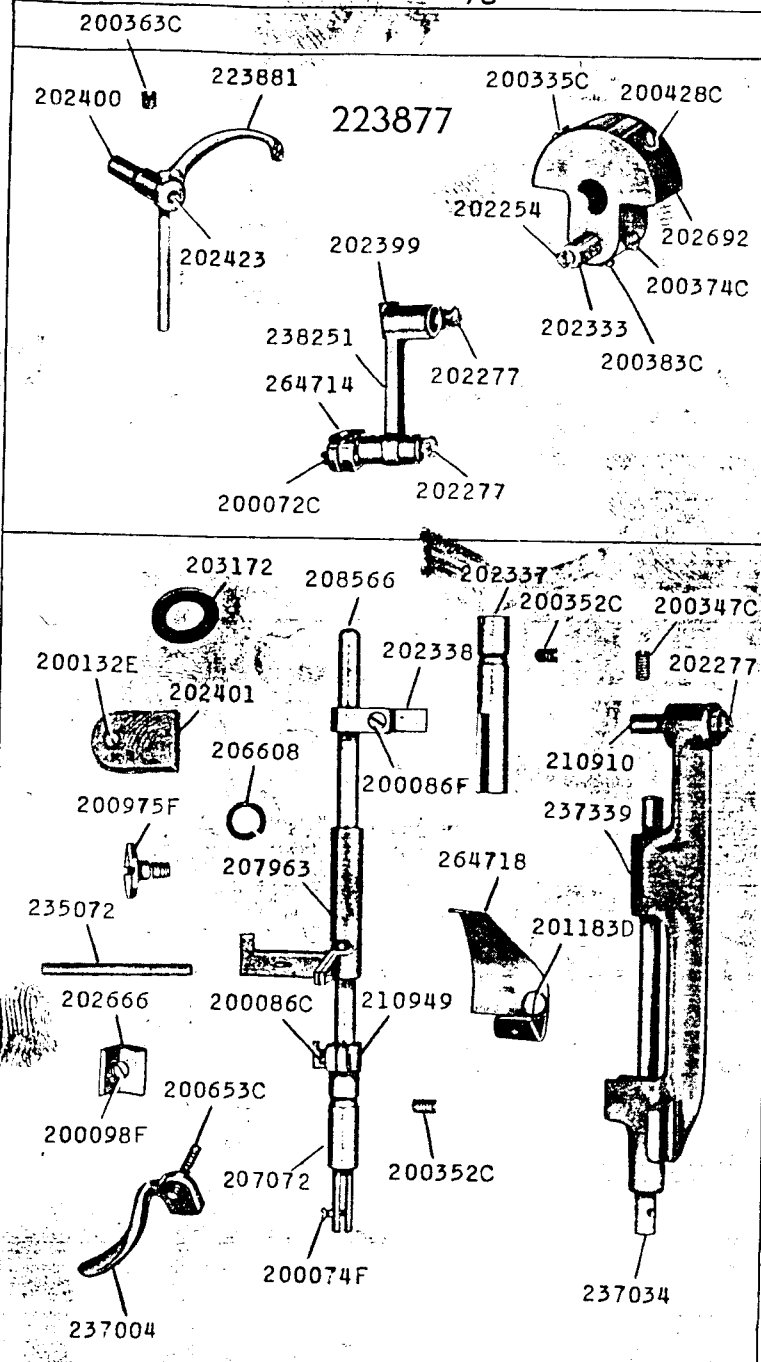

17790-1/2

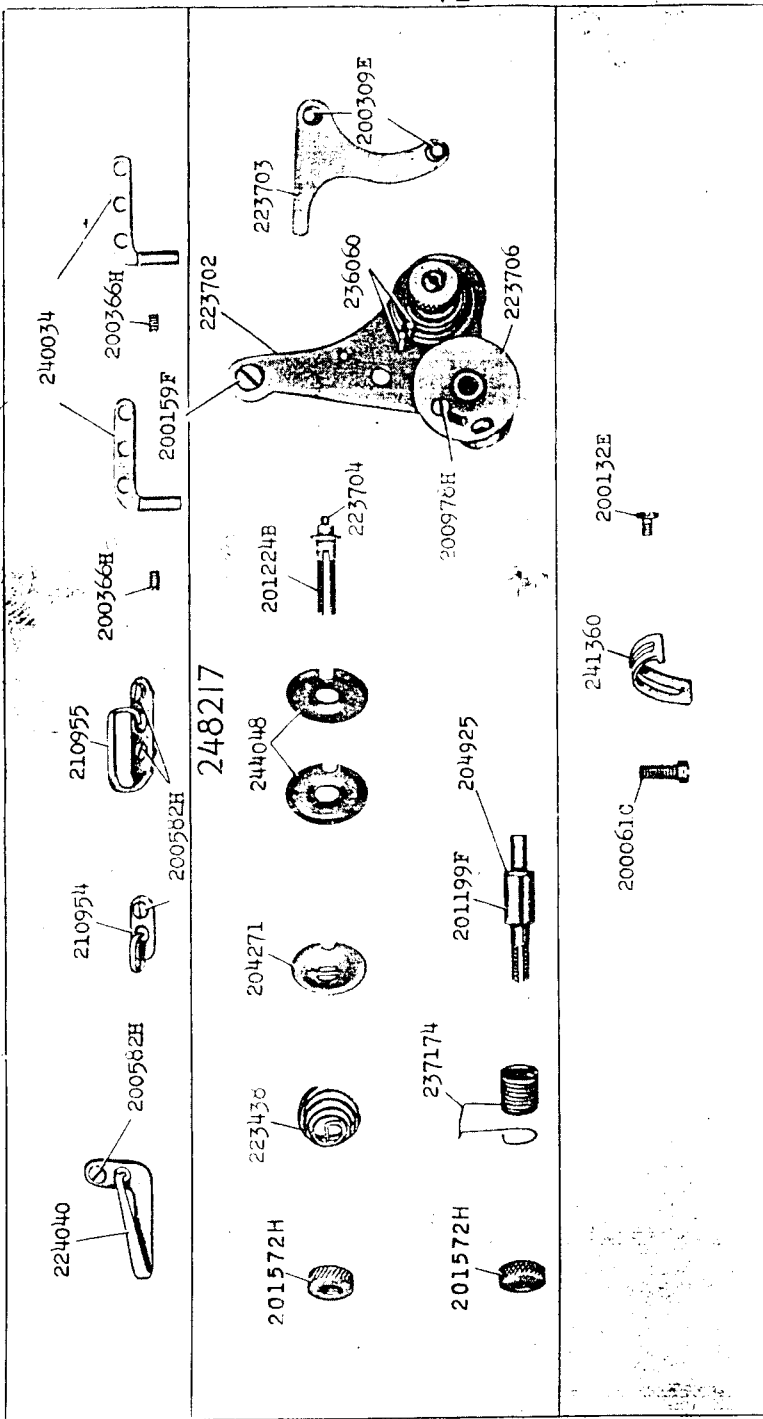

17791 1/3

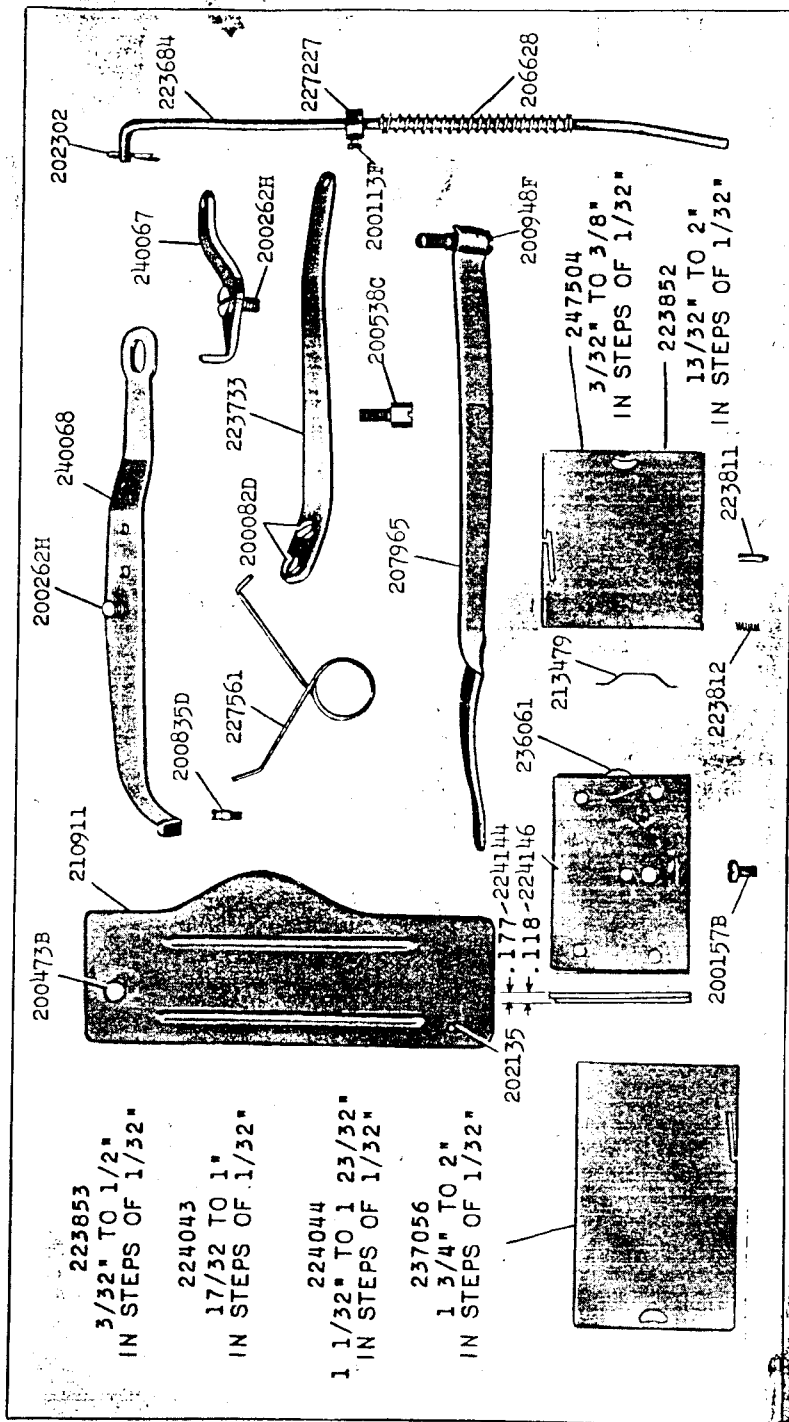

17792 1/2

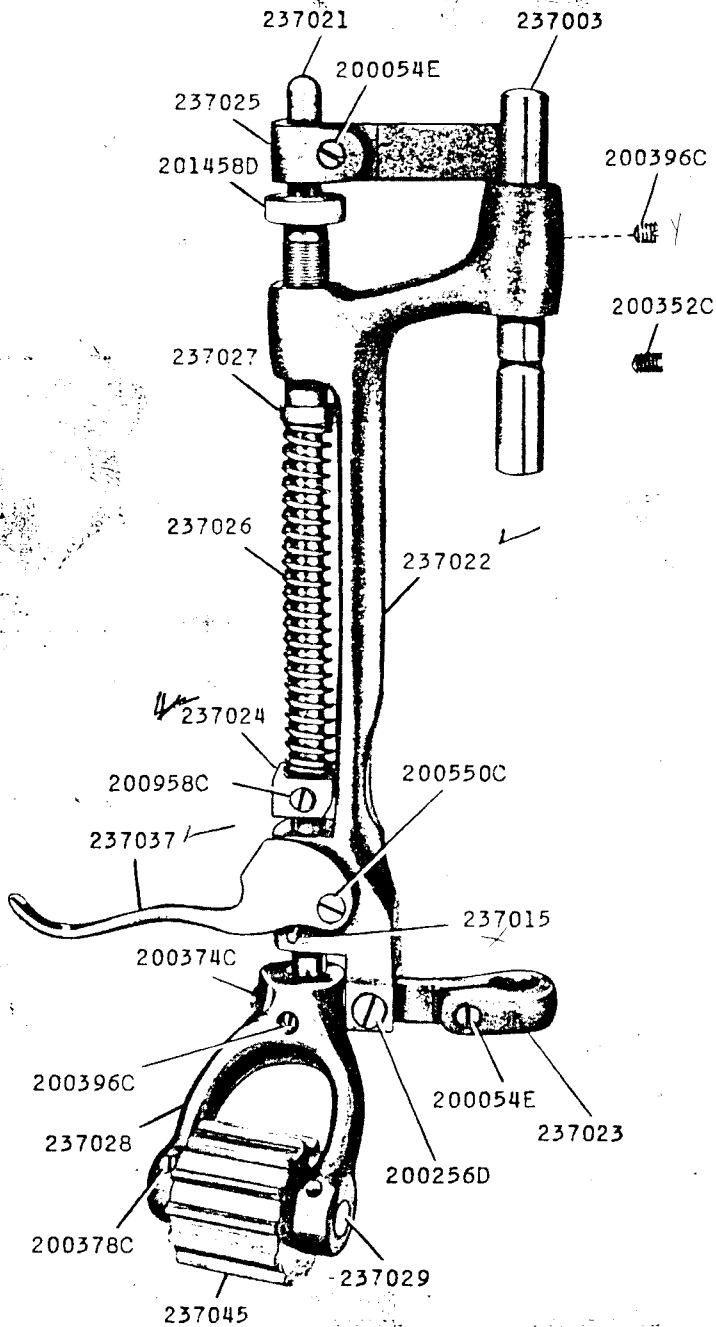

17793 1/2

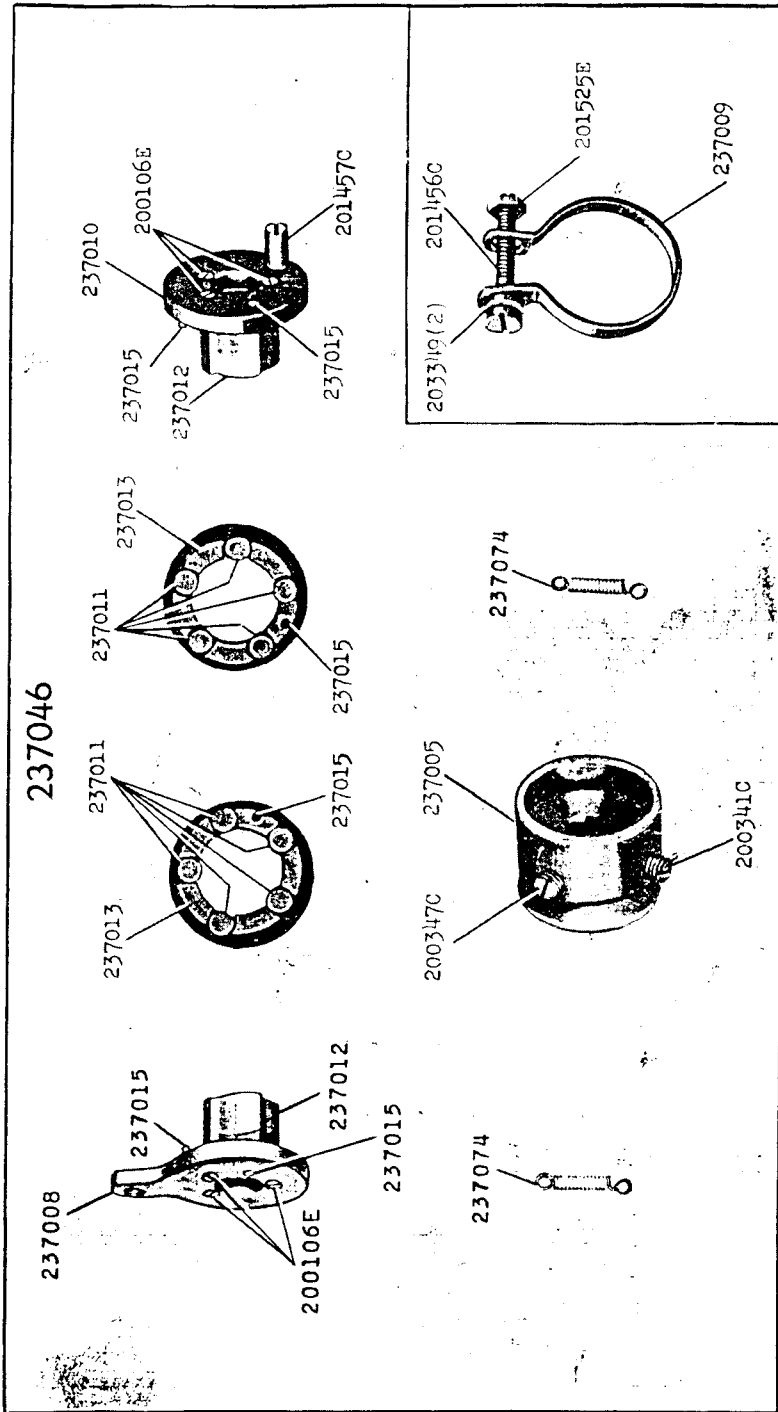

17794 3/8

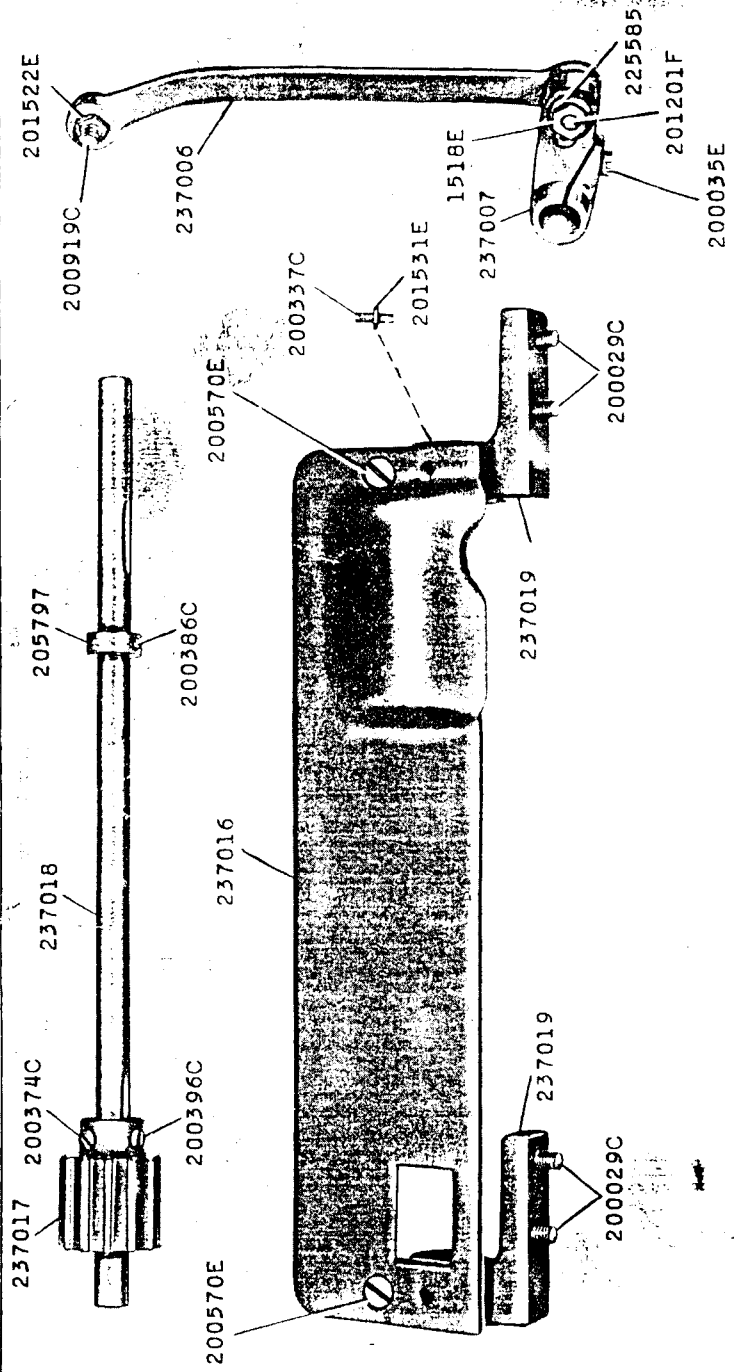

17795 1/2

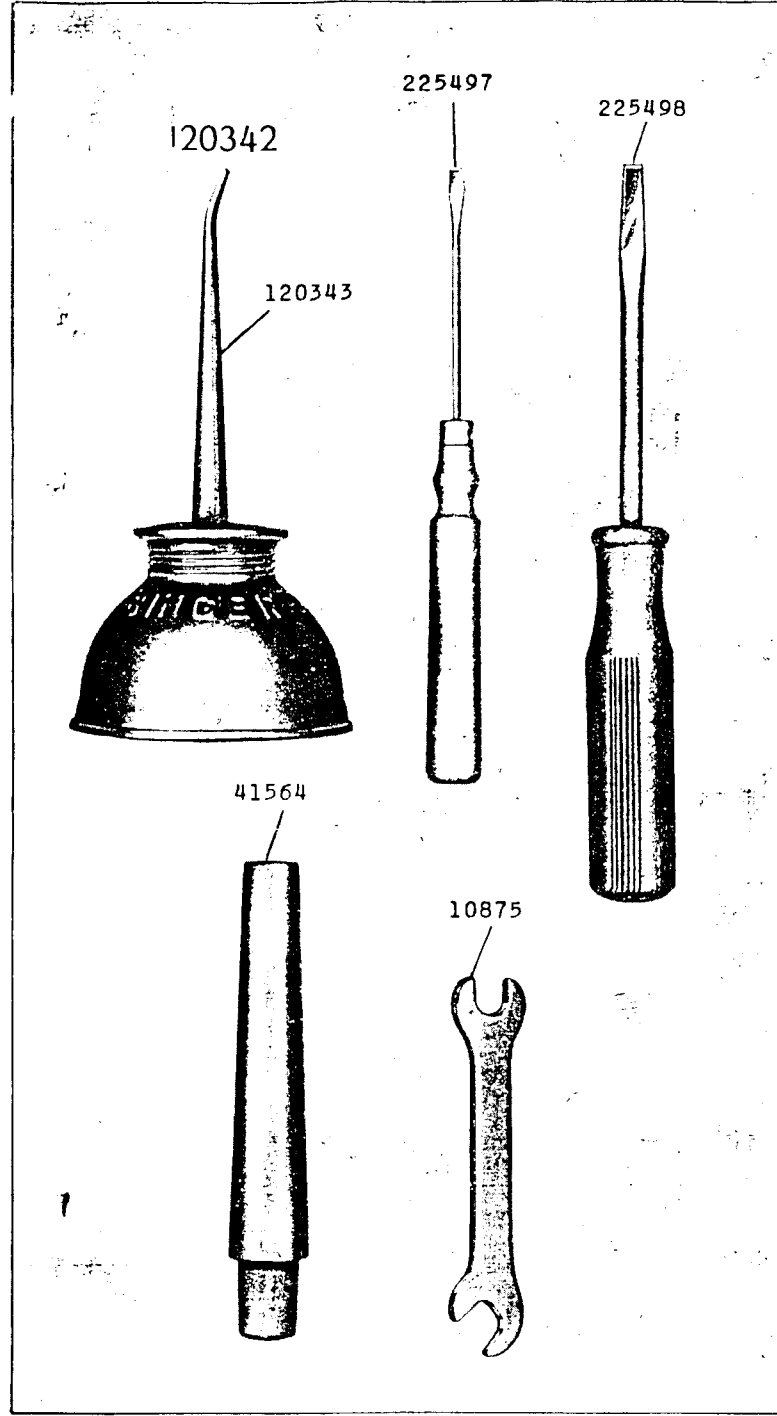

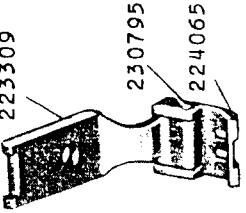
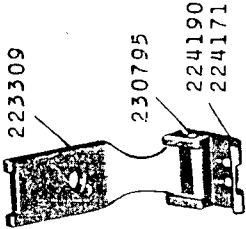
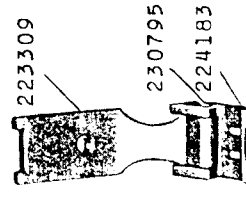
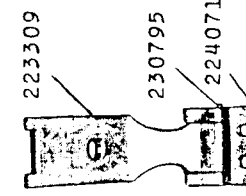
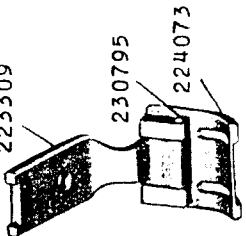
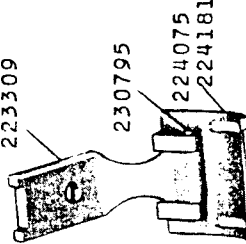
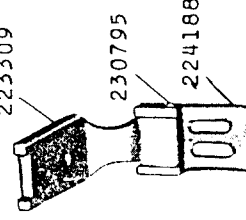
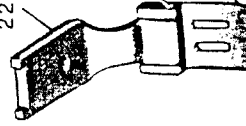

17796 2/3

<p>224066-53 223309 230795 224065 3/32-1/8-5/32-3/16</p> 	<p>224191-50 224172-53 223309 230795 224190 224171 1/8-5/32-3/16</p> 	<p>224184-53 223309 230795 224183 1/8-5/32-3/16</p> 	<p>224072-50 223309 230795 224071 7/32-1/4-9/32-5/16</p> 
<p>224074-50 223309 230795 224073 11/32-3/8-13/32-7/16</p> 	<p>224076-50 224182-53 223309 230795 224075 224181 21/32-11/16-23/32-3/4</p> 	<p>224189-40 223309 230795 224188 1/8-5/32-3/16</p> 	<p>224187-53 224158-50 223309 230795 224186 224157 3/32-1/8-5/32-3/16</p> 

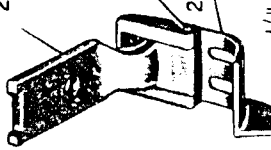
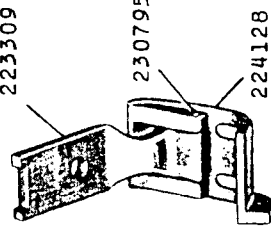
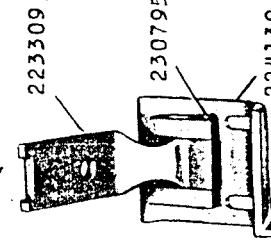
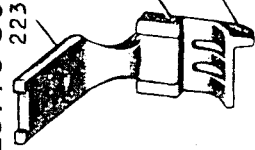
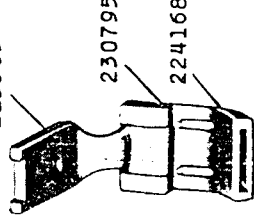
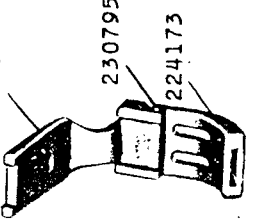
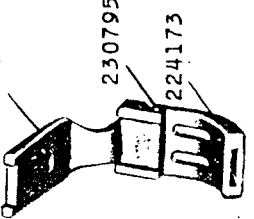
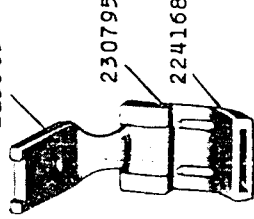
17797 2/3

<p>223697-40 223309 230795 223696 1/4-9/32-5/16</p> 	<p>224129-40 223309 230795 224128 1/4-9/32-5/16-11/32-3/8-13/32-7/16</p> 	<p>224131-40 223309 230795 224130 15/32-1/2-17/32-9/16-19/32-5/8</p> 	<p>223773-50 223309 230795 223772 1/8-5/32-3/16-7/32-1/4-9/32-5/16</p> 
<p>224169-50 223309 230795 224168 11/32-3/8-13/32-7/16-15/32-1/2 17/32-9/16-19/32-5/8</p> 	<p>224174-50 223309 230795 224173 3/16-7/32-1/4-9/32-5/16</p> 	<p>224175-50 223309 230795 224175 3/16-7/32-1/4-9/32-5/16</p> 	<p>224169-50 223309 230795 224168 11/32-3/8-13/32-7/16-15/32-1/2 17/32-9/16-19/32-5/8</p> 

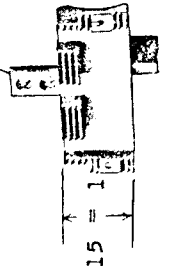
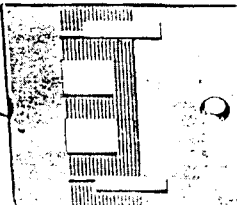
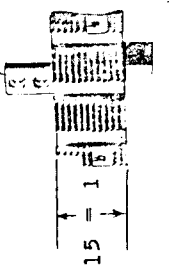
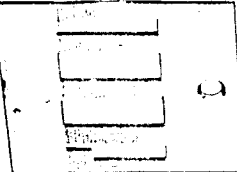
17798 1/2

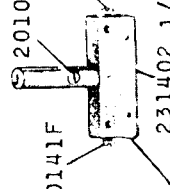
<p>237064-46 237065-40 237066-50</p>  <p>237070</p> 	<p>237067-40 237068-50 237069-46</p>  <p>237071</p> 
<p>1 17/32" TO 2" IN STEPS OF 1/32"</p>  <p>200141F 201030F 231383 3/32" TO 15/32" IN STEPS OF 1/32"</p>	<p>1 17/32" TO 2" IN STEPS OF 1/32"</p>  <p>200141F 201030F 231402 1/2" TO 3/4" IN STEPS OF 1/32" 231403 25/32" TO 1 1/2" IN STEPS OF 1/32"</p>

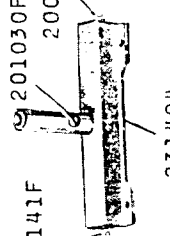
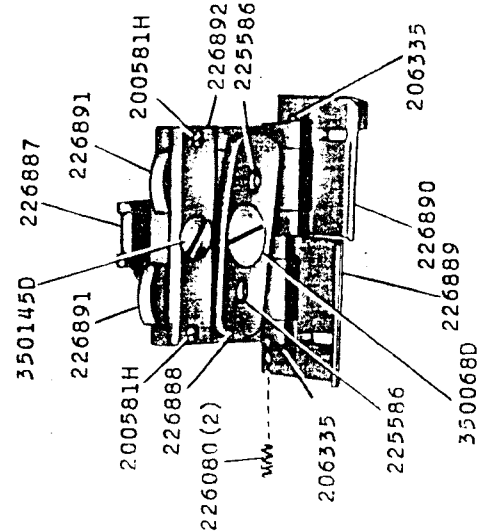
<p>200141F 201030F 231404 1 17/32" TO 2" IN STEPS OF 1/32"</p> 	<p>226893</p> 
--	---

17799 5/8

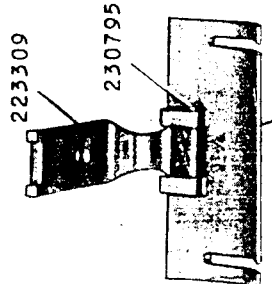
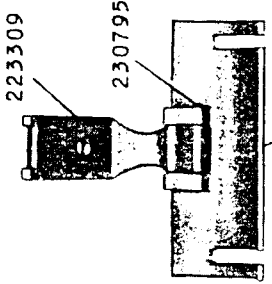
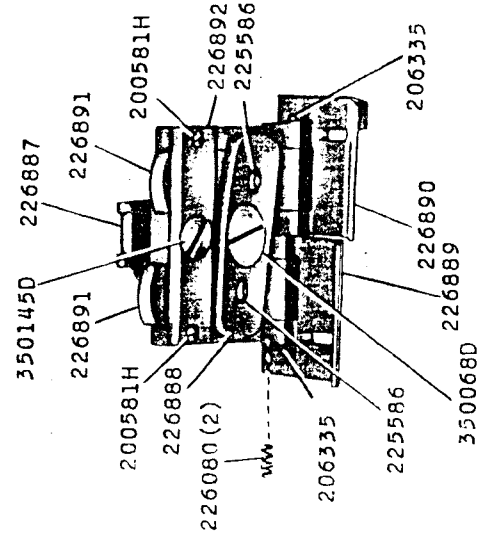
<p>237060-50</p>  <p>237059</p> <p>1 17/32" TO 2" IN STEPS OF 1/32"</p>	<p>237073-40</p>  <p>237072</p> <p>1 17/32" TO 2" IN STEPS OF 1/32"</p>	<p>226893</p> 
--	---	---

17800 1/6

227212

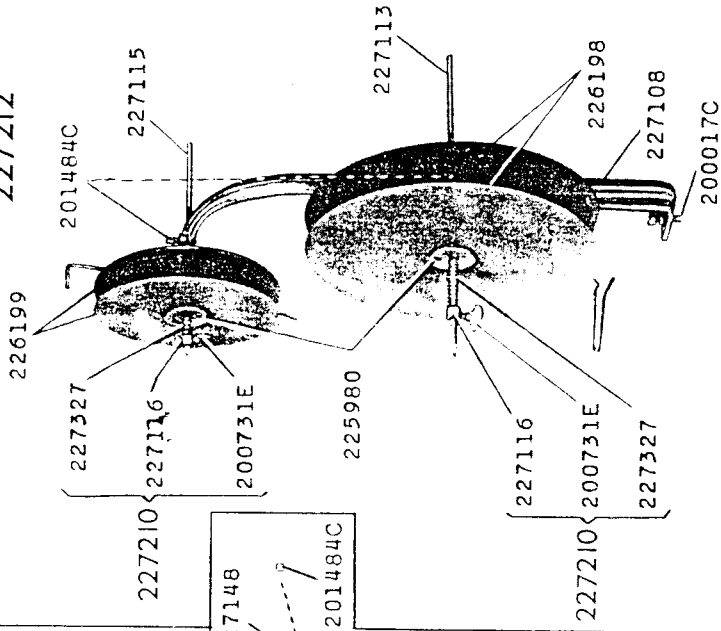

227139

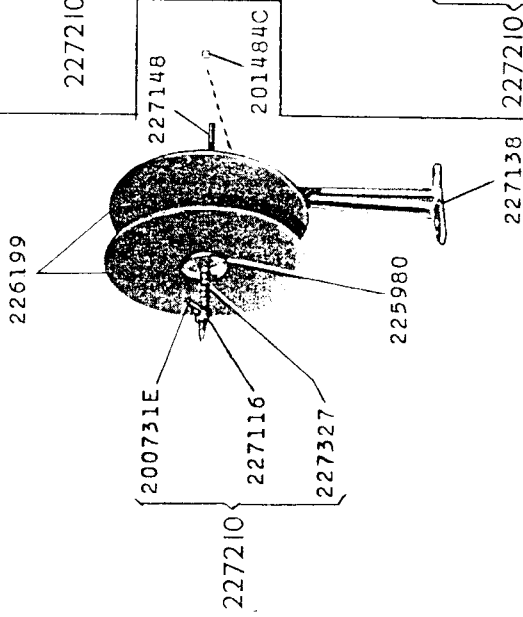

17801 1/2

231369

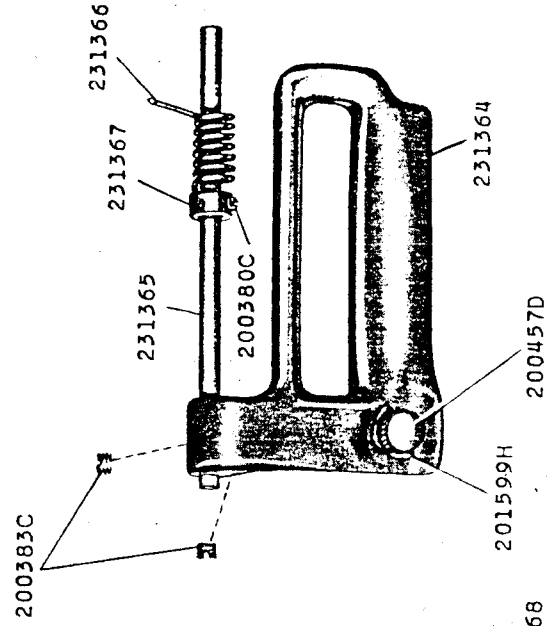

231363

