

18945  
5)  
PRINTED IN U. S. A.

HISTORICAL COPY  
DO NOT REMOVE

# LIST OF PARTS



## MACHINES

Nos. 44-4, 44-7 and 44-25

---

THE SINGER MANUFACTURING COMPANY

# INSTRUCTIONS FOR OILING

To ensure easy running and prevent unnecessary wear of the parts which are in movable contact, the machine requires oiling and when in continuous use, "TYPE B" or "TYPE D" OIL, sold only by Singer Sewing Machine Company, should be applied at least twice each day to all oil holes marked "OIL", as instructed in Form 8088.

"TYPE D" OIL is stainless.

## INDEX

	Page
Attachments and Accessories.....	31
Belt Guard.....	31
Ball Bearing Roller Pressers.....	38
Ball Bearing Roller Pressers with Ratchet Brake.....	39
Bobbin Winders.....	32
Finger Guard.....	34
Fittings For Making Bag Handles (for 44-4 Machine).....	13
Foot Lifter.....	34
Guide (for 44-4 and 44-25 Machines).....	32
Knife Grinder.....	35
Knee Lifter Parts.....	36
Machine Base.....	31
Machine No. 44-4.....	5
Machine No. 44-7.....	14
Machine No. 44-25.....	23
Numerical List of Parts.....	45
Obsolete Parts.....	40
Plain Roller Pressers.....	38
Thread Unwinder.....	40

# INSTRUCTIONS FOR ORDERING

In ordering from this list, use ONLY the part NUMBER in the FIRST column.

The number stamped on a Sewing Machine Part is in every case the number of the single part only.

Every combination of parts sent out as such has its specific number, which, although not stamped on the parts, must be used when ordering the combination.

Each number always indicates the SAME PART in whatever list it appears, or for whatever machine.

The letters after some of the numbers indicate the style of finish only, as follows:

- A-Hardened, Polished, Nickel Plated and Buffed
- A.A-Buffed and Chromium Plated
- A.B-Hardened, Polished, Buffed and Chromium Plated
- A.C-Brown Baking Enamel Finish
- A.D-Gray Baking Enamel Finish
- A.E-Hardened, Bright Rumbled and Nickel Plated
- A.F-Hardened, Bright Rumbled, Nickel Plated, Bright Rumbled and Chromium Plated
- B-Polished, Nickel Plated and Buffed
- C-Hardened Only
- C.R-Hardened and Merlized
- D-Polished Only
- E-Soft, Not Polished
- F-Hardened and Polished
- F.J-Hardened, Polished and Nickel Plated
- G-Bright Rumbled and Nickel Plated
- H-Blued
- J-Nickel Plated Only
- K-Hardened and Nickel Plated
- L-Brass Plated
- M-Oxidized
- N-Japaned, Dull
- P-Japaned, Bright
- P.P-Wrinkle Finish
- R-Merlized
- S-Cadmium Plated
- T-Copper Plated
- T.A-Hardened, Polished, Copper and Nickel Plated and Buffed
- T.B-Copper and Nickel Plated and Polished
- T.J-Copper and Nickel Plated Only
- T.K-Hardened, Copper and Nickel Plated
- T.L-Copper and Brass Plated
- T.M-Copper Plated and Oxidized
- U-Zinc Plated
- V-Silver Plated
- W-Polished and Nickel Plated
- X-Black Oxide, for Iron and Steel
- X.C-Hardened and Black Oxide, for Iron or Steel
- Y-Black Nickel Plated Only
- Z-Chromium Plated
- Z.A-Hardened, Polished, Nickel Plated, Buffed and Chromium Plated
- Z.B-Polished, Nickel Plated, Buffed and Chromium Plated
- Z.C-Hardened and Chromium Plated
- Z.D-Polished and Chromium Plated
- Z.G-Bright Rumbled, Nickel Plated, Bright Rumbled and Chromium Plated
- Z.J-Nickel and Chromium Plated
- Z.T-Copper and Chromium Plated

These letters MUST BE USED when they appear in the list; and AFTER the number as in the list.

In this series:

- 1 to 1500, 50001 to 51500 and 140001 to 142000 are Screw Numbers
- 1501 to 1800 and 51501 to 51800 are Nut Numbers
- 1801 to 2000 and 51801 to 52000 are Roller Numbers
- 2001 to 30000 and 52001 to 140000 and 141001 to 190000 are Sewing Machine Parts, 130001 and upward are numbers of Electrical Parts.

The figures in the second column refer only to the plates, illustrating the parts, and are NOT TO BE USED in ordering.

Parts marked with an asterisk (\*) are furnished only when repairs are made at factory.

## LIST OF PARTS COMPLETE

FOR

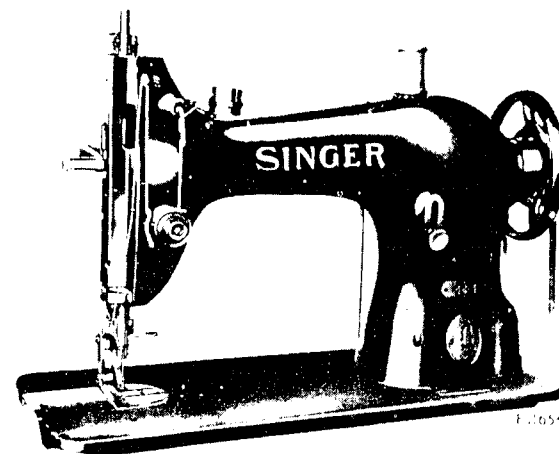

## MACHINE No. 44-4

FOR LEATHER. HAS VERTICAL TRIMMER. DROP FEED.

SPEED 1800 R. P. M.

No.	Plate	Name
*16557	---	Arm with 11104, 15404 and two 15405.....
8582	8409	" Dowel Pin.....
12453	8409	" Oil Tube for intermediate bearing....
12454	8409	" " " with 132590, for oiling 12409.....
24131	8409	Arm Oil Tube with 52045, for oiling 12197
11119	8409	" " " 52045, for oiling 12408 and 16569.....
52045	8409	Arm Oil Tube Packing (wick).....
132590	8409	" " " " (wick).....
748E	8409	" Screw (back).....
868E	8409	" " (front).....
16511	8388	" Shaft.....
62541	---	" " 16511 with 12197 and 16569.....
*6563E	---	" " 62541 with 20197.....
*11104	---	" " Bushing (front).....
12357	8388	" " Flanged Bushing (back).....
448C	8409	" " " " " Set Screw
144D	8409	" " Screw.....

No.	Plate	Name
12193	8388	Arm Side Cover.....
51224D	8409	" " " Thumb Screw.....
12403	8388	" Spool Pin and Thread Eyelet.....
8879	8420	" " " Washer (cloth).....
24296	8388	Balance Wheel (power) light rim, 2 3/16 inch pulley, with two 448C.....
24297	8388	Balance Wheel Oil Cover.....
210D	8409	" " " " Screw.....
448C	8409	" " " Set Screw.....
*16596	----	Bed.....
20197	8388	Crank Connecting Rod with two 896C.....
896C	8409	" " " Cap Screw.....
908C	8409	" " " Hinge Screw.....
1619J	8409	" " " " " Nut.....
16558	----	Face Plate.....
16559	8410	Face Plate complete, Nos. 2827, 12150 and 16558.....
203J	8409	Face Plate Screw.....
62682	8409	" " " Thread Eyelet.....
*44181	----	" " " Guard (lower).....
12150	8409	" " " " " 44181 with 12152.....
12152	8409	Face Plate Thread Guard (lower) Rivet....
2827	8409	" " " " (upper) with 8505
8505	8409	" " " " Rivet....
12368	8410	Feed Bar.....
313C	8409	" " " Screw Center.....
56813	----	" " " " 313C with 1519J....
1519J	8409	" " " " Nut.....
12197	8421	" Cam and Feed Lifting Eccentric with 446C.....
446C	8409	Feed Cam and Feed Lifting Eccentric Set Screw.....
3033	770	Feed Connecting Link.....
375C	8409	" " " Hinge Screw.....
1518E	8412	" " " " " Nut.....
16560	1338	" Dog, 10 teeth (16 teeth to the inch)
Note: No. 16560 is sent with this machine unless otherwise specified on order.		
24392	1338	Feed Dog, 8 teeth (12 teeth to the inch)
24951	8412	" " 15 teeth (24 teeth to the inch)
208E	8412	" " " Screw.....
12123	8410	" Forked Connection.....
375C	8409	" " " Hinge Screw.....
1518E	8412	" " " " " Nut...
16504	8410	" Lifting Rock Shaft.....
16588	----	Feed Lifting Rock Shaft complete, Nos. 3093, 12376, 16504 and 16558.....

No.	Plate	Name
16550	8412	Feed Lifting Rock Shaft Crank (back) with 462C.....
3093	8412	Feed Lifting Rock Shaft Crank (back) Pin.
462C	8412	" " " " " Set Screw.....
12376	770	Feed Lifting Rock Shaft Crank (front) with 157J and 1813.....
157J	8412	Feed Lifting Rock Shaft Crank (front) Clamping Screw.....
1513	8412	Feed Lifting Rock Shaft Crank (front) Roller and Stud.....
43976	8411	Feed Lifting Rock Shaft Crank Connecting Rod with 43977 and two 966E.....
*43977	----	Feed Lifting Rock Shaft Crank Connecting Rod Cap.....
966E	8412	Feed Lifting Rock Shaft Crank Connecting Rod Cap Screw.....
375C	8409	Feed Lifting Rock Shaft Crank Connecting Rod Hinge Screw.....
1518E	8412	Feed Lifting Rock Shaft Crank Connecting Rod Hinge Screw Nut.....
307C	8412	Feed Lifting Rock Shaft Screw Center....
56814	----	" " " " " 307C with 1513J.....
1513J	8412	Feed Lifting Rock Shaft Screw Center Nut.
3033	8410	" Regulator.....
1126K	8412	" " Hinge Screw.....
818D	8412	" " Thumb Screw.....
16506	8411	" Rock Shaft.....
24376	----	Feed Rock Shaft complete, Nos. 16506 and 29633.....
29633	8412	Feed Rock Shaft Crank with 157J.....
157J	8412	" " " " Clamping Screw....
307C	8412	" " " " Screw Center.....
56814	----	" " " " " 307C with 1513J.....
1513J	8412	Feed Rock Shaft Screw Center Nut.....
16598	1338	Knife, narrow, end and side cut.....
Note: Five No. 16598 are sent with this machine unless other Knives are specified on or- der.		
19173	1338	Knife, broad, diagonal cut.....
19174	1338	" " " end and side cut.....
19175	1338	" " " medium, end and side cut.....
19176	1338	" " " " " cut only.....
19177	1338	" " " " " (shearing).....
19178	1338	" " " " " and side cut (concave)
19179	1338	" " " " " " (thin gauge).....

No.	Plate	Name
19297	8413	Knife Bar with 2301.....
24431	8413	" " Crank with 191C.....
1162C	8414	" " " Coupling Pin.....
1564D	1338	" " " " " Head.....
2297	1338	" " " " " Spring.....
2022	8414	" " " Pin.....
191C	8414	" " " Set Screw.....
24432	----	Knife Bar Crank complete, Nos. 1162C, 1564D, 2297 and 24431.....
16563	8413	Knife Bar Driving Crank (forked).....
16564	8413	" " " Bracket.....
24433	----	Knife Bar Driving Crank Bracket complete, Nos. 2022, 16563, 16564 and 24432.....
647C	8414	Knife Bar Driving Crank Bracket Screw....
24122	8414	" " Lifting Spring.....
24123	8414	" " " " " Case.....
24124	8414	" " " " " Guide.....
24906	----	" " " " " 24124 with 2523 and 24125.....
*24125	8414	Knife Bar Lifting Spring Guide Bracket...
621J	8414	" " " " " " Screw
2523	8396	" " " " " " Pin.....
2301	8414	" " " Stop Pin.....
24127	----	Knife Bar complete, Nos. 621J, 16567, 19297 24126, 24906 and two 335H.....
16567	8414	Knife Holder with two 206D.....
24128	8414	" " Handle.....
335H	8414	" " Screw.....
206D	8412	" Screw for 16567.....
16568	8413	Needle Bar with 620F, 904E and 24391.....
19265	8413	" " " 904E, for 19173.....
12382	770	" " Connecting Link with 794E.....
43997	----	" " " " 12382 with 12384.....
794E	8414	Needle Bar Connecting Link Adjusting Screw.....
*12383	----	Needle Bar Connecting Stud.....
1904	770	" " " " Roller (roller only).....
453C	8412	Needle Bar Connecting Stud Set Screw....
12384	770	Needle Bar Connecting Stud complete, Nos. 453C, 1904 and 12383.....
16569	8413	Needle Bar Crank (eccentric) with 448C and 743C.....
743C	8414	Needle Bar Crank Position Screw.....
448C	8409	" " " Set Screw.....
24391	8414	" " Thread Guard.....
620F	8414	" " " Set Screw.....
904E	8414	" Set Screw for 16568 and 19265.....

No.	Plate	Name
44222	8413	Oil Cup.....
44223	----	" " 44222 with 44005.....
44214	----	" " Extension.....
44005	8413	" " " 44214 with 24075.....
24075	8413	" " " Post.....
44006	8413	" " Packing (felt).....
44224	8413	" " Thread Retainer.....
44225	8413	Oil Cup complete, Nos. 44006, 44223 and 44224.....
*24104	8413	Oscillating Rock Shaft.....
24105	----	Oscillating Rock Shaft complete, Nos. 4784 12388 and 24104.....
12388	8410	Oscillating Rock Shaft Hinge Pin.....
448C	8409	" " " " " Set Screw
4784	8414	" " " " Oil Pad.....
16509	8417	" Shaft.....
19496	----	" " Crank for 19447.....
44134	----	" " " 44135.....
19447	8394	Oscillating Shaft Crank complete, Nos. 457C, 1518E, 19449 and 19496.....
44135	8394	Oscillating Shaft Crank complete, Nos. 1518E, 19449, 44134 and two 453C.....
2049	8396	Oscillating Shaft Crank Pin.....
457C	8394	" " " Set Screw for 19447.....
453C	8412	Oscillating Shaft Crank Set Screw for 44135.....
19448	8394	Oscillating Shaft Crank Slide Block.....
226J	8394	" " " " " Cap Screw.....
12424	8394	Oscillating Shaft Crank Slide Block Cap Screw Washer.....
988C	8394	Oscillating Shaft Crank Slide Block Screw Stud.....
1518E	8412	Oscillating Shaft Crank Slide Block Screw Stud Nut.....
19449	8394	Oscillating Shaft Crank Slide Block com- plete, Nos. 226J, 988C, 12424 and 19448
19441	8417	Presser Bar (hollow).....
19464	----	Presser Bar complete, Nos. 190J, 19441 to 19443 and 24445.....
12326	770	Presser Bar Guide Bracket with 453C.....
453C	8412	" " " " Set Screw.....
2062	8413	" " Lifter.....
636C	8413	" " " Screw.....
1520E	8394	" " " Nut.....
12327	8394	" Lifting and Releasing Lever Bracket.....

No.	Plate	Name
11167	8417	Presser Bar Spring (light) .051 wire....
Note: No. 11167 is sent with this machine unless another Spring is specified on order.		
12139	8417	Presser Bar Spring (medium) .055 wire....
20023	8417	" " " (heavy) .063 wire....
11170	8418	" " " Washer.....
688J	8396	Pressure Regulating Thumb Screw.....
1841	----	Roller, 7/8 in. diam., 9/64 in. face, fine with 652D and 1528J.....
62677	8418	Roller Arm.....
18442	8418	" " Bracket.....
19443	8418	" " " Position Collar with 456C.....
456C	8418	Roller Arm Bracket Position Collar Set Screw.....
987E	8418	Roller Arm Bracket Screw Stud.....
19444	8418	" " " Spring.....
19445	8418	" " " Pin.....
19446	8418	" " " Stud.....
24445	----	Roller Arm Bracket Spring Stud complete, Nos. 987E and 19444 to 19446.....
62722	8402	Roller Presser complete, 7/8 in. diam., 9/64 in. face, fine roller, Nos. 1841 and 62677.....
Note: No. 62722 is sent with this machine unless another Roller Presser is specified on order.		
190J	8418	Roller Presser Screw.....
652D	8403	" Screw for 1841.....
1528J	8396	" Nut for 1841.....
2996	8396	Shuttle Bobbin.....
62739	----	" " Case.....
15140	8396	" " Latch.....
2973	8396	" " " Lever.....
2974	8396	" " " Fulcrum Pin.....
2975	8396	Shuttle Bobbin Case Latch Spring.....
592E	8396	" " " Stop Screw.....
15141	8396	" " " Hinge, Nos. 2973, 2974 and 15140.....
*7553	8396	Shuttle Bobbin Case Position Finger.....
2523	8396	" " " Rivet.....
24412	8396	" " " Plate.....
391J	8402	" " " Screw.....
62740	8396	Shuttle Bobbin Case complete, Nos. 591F, 592E, 2523, 2975, 7553, 15141, 15278 and 62739.....
12393	8396	Shuttle Bcdy.....
591F	8403	" Tension Regulating Screw.....

No.	Plate	Name
15278	8396	Shuttle Tension Spring.....
1929C	8418	" 1 11/16 in. diam., Nos. 2996, 13363 and 62740.....
*13394	----	Shuttle Driver.....
12444	8418	" " 13394 with two 1266C.....
2049	8396	" " Pin.....
1860C	8403	" " Set Screw.....
2531	8396	" Race Back.....
2532	8396	" " " Position Pin.....
2533	8396	" " " Spring.....
24413	8418	" " " Screw.....
24413	----	" " Body.....
*62501	----	" " 24413 with 4418 and two 1053E.....
*62501	----	Shuttle Race Body 24413 with 24420 and two 1053E.....
62517	----	Shuttle Race Body 62502 with two 2532....
62516	----	" " " 62501 with two 2532....
24412	8396	" " Cap for 62502.....
24420	8417	" " " 62501.....
1053E	8418	" " " Screw.....
24419	8417	Shuttle Race complete, Nos. 907D, 2531, 2533, 24412, 62517 and two 391J.....
24421	8417	Shuttle Race complete for 19174, Nos. 907D 2531, 2533, 24412, 62516 and two 391J....
143D	8418	Shuttle Race Screw.....
12431	----	" Slide.....
12432	8402	Shuttle Race Slide complete, Nos. 4307, 12431 and two 735E.....
4307	8402	Shuttle Race Slide Spring.....
725E	8396	" " " Screw.....
2102	8396	Tension Disc.....
1560C	8396	" Regulating Thumb Nut.....
32072	8396	" Releasing Disc.....
43944	8396	" " Lever.....
12396	8396	" " " Hinge Pin.....
12395	8396	" " " Spring.....
32574	8396	" " " Pin.....
50327C	8398	" Screw Stud.....
*44141	----	" " " 50327C with 1560C.....
43945	8396	" Spring.....
12149	8396	Thread Guard.....
*44118	----	Tension complete, Nos. 7336, 32572, 32574, 43945, 43946, 44141 and two 2102.....
52454	8398	Thread Retainer.....
624C	8396	" Set Screw.....
12404	8396	" Take-up Crank.....
3094	8396	" " " Wedge.....
735E	8396	" " " Screw.....

No.	Plate	Name
12408	770	Thread Take-up Lever.....
775E	8398	" " " Cap Screw.....
12166	8398	" " " Hinge Pin.....
12409	770	" " " Link.....
11204	770	" " " Hinge Pin.....
435C	8398	" " " " " Set Screw.....
12410	----	Thread Take-up Lever complete, Nos. 12166 12408 and 12409.....
43946	8398	Thread Take-up Spring.....
733E	8418	" " " Regulator.....
448C	5409	" " " " " Set Screw
62626	----	Throat Plate Body.....
16599	1338	" " Cutting Bar, 5/128 inch to 3/32 inch gauge.....
Note: When ordering No. 16599, state required distance of trimmed edge from seam.		
Note: No. 16599, 3/64 inch gauge is sent with this machine unless another gauge is specified on order.		
238D	8415	Throat Plate Cutting Bar Screw.....
2328	1338	" " Spring Slide for 16597.....
2329	1338	" " " " " 19180.....
2330	1338	" " " " Spring.....
56895	1338	" " " " " Stop (oval).....
725D	8398	Throat Plate Spring Slide Spring Stop Screw.....
16597	1338	Throat Plate complete, for 16560, 24392 and 24951, Nos. 725D, 2328, 2330, 16599, 56895, 62626 and two 238D.....
19180	1269	Throat Plate complete for 16560, 24392 and 24951, for 19174, Nos. 725D, 2329, 2330 16599, 56895, 62626 and two 238D.....
Note: When ordering Nos. 16597 or 19180, state required distance of trimmed edge from seam.		
Note: No. 16597, 5/128 inch gauge, is sent with this machine, unless otherwise specified on order.		
691F	8415	Throat Plate Screw.....
15404	----	Trade Mark.....
15405	8398	" " Rivet.....
24079	8407	Drip Pan.....

## FOR MAKING BAG HANDLES

No.	Plate	Name
24388	8415	Feed Dog (grooved).....
26836	8415	Guide.....
284J	8415	" Thumb Screw.....
24439	8415	Presser Foot (grooved).....
4947	8415	Throat Plate Cutting Bar, 5/128 inch to 3/32 inch gauge.....
Note: When ordering No. 4947, state required distance of trimmed edge from seam.		
238D	8415	Throat Plate Cutting Bar Screw.....
2328	1338	" " Spring Slide.....
2330	1338	" " " " Spring.....
56895	1338	" " " " " Stop (oval).....
725D	8398	Throat Plate Spring Slide Spring Stop Screw.....
24390	8415	Throat Plate complete, for 24388, Nos. 725D, 2328, 2330, 4947, 56895 and two 238D.....

SINGER Needles should be used  
in SINGER Machines.  
These Needles and their Containers  
are marked with the  
Company's Trade Mark "SIMANCO. #1" 1

Needles in Containers marked  
"FOR SINGER MACHINES"  
are NOT **SINGER** made needles. 2

LIST OF PARTS COMPLETE  
FOR

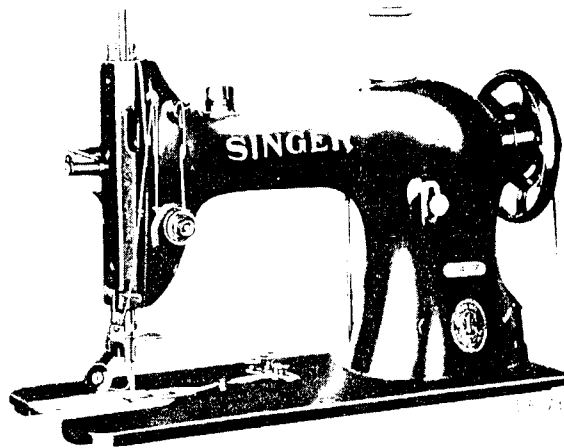

MACHINE No. 44-7

FOR SHOES. HAS VERTICAL TRIMMER THAT CAN BE INSTANTLY ADJUSTED FOR THE SCALLOPS AND TOPS OF SHOES. DROP FEED. SPEED 1800 R. P. M.

No.	Plate	Name
*16587	----	Arm with 11104, 15404 and two 15405.....
3583	8409	" Dowel Pin.....
12453	8409	" Oil Tube for intermediate bearing....
12454	8409	" " " with 132590, for oiling 12409
24131	8409	" " " " 52045, for oiling 12197
11119	8409	" " " " 52045, for oiling 12408 and 16589.....
52045	8409	Arm Oil Tube Packing (wick).....
132590	8409	" " " " (wick).....
748E	8409	" Screw (back).....
868E	8409	" " (front).....
16511	8388	" Shaft.....
*11104	----	" Bushing (front).....
12357	8388	" Flanged Bushing (back).....
448C	8409	" " " " Set Screw
144D	8409	" " Screw.....
12196	8409	" Side Cover.....
51324E	8410	" " Thumb Screw.....

No.	Plate	Name
12403	8388	Arm Spool Pin and Thread Eyelet.....
8879	8420	" " " Washer (cloth).....
24296	8388	Balance Wheel (power) light rim, 2 3/16 inch pulley, with two 448C.....
24297	9388	Balance Wheel Oil Cover.....
210D	8409	" " " " Screw.....
448C	8409	" " " " Set Screw.....
*16596	----	Bed.....
20197	8388	Crank Connecting Rod with two 896C.....
896C	8409	" " " " Cap Screw.....
908C	8409	" " " " Hinge Screw.....
1619J	8409	" " " " " Nut.....
16558	----	Face Plate.....
16559	8410	Face Plate complete, Nos. 2827, 12150 and 16558.....
203J	8409	Face Plate Screw.....
62682	8409	" " " Thread Eyelet.....
*44181	----	" " " " Guard (lower).....
12150	8409	" " " " " " 44181 with 12152.....
12152	8409	Face Plate Thread Guard (lower) Rivet....
2827	8409	" " " " (upper) with 8505
8505	8409	" " " " " Rivet....
12368	8410	Feed Bar.....
313C	8409	" " " Screw Center.....
56813	----	" " " " 313C with 1519J....
1519J	8409	" " " " " Nut.....
12197	8421	" Cam and Feed Lifting Eccentric with 446C.....
446C	8409	Feed Cam and Feed Lifting Eccentric Set Screw.....
3033	770	Feed Connecting Link.....
375C	8409	" " " " Hinge Screw.....
1518E	8412	" " " " " Nut.....
16560	1338	" Dog, 10 teeth (16 teeth to the inch)
Note: No. 16560 is sent with this machine unless otherwise specified on order.		
24392	1338	Feed Dog, 8 teeth (12 teeth to the inch)
24951	8412	" " 15 teeth (24 teeth to the inch)
208E	8412	" " Screw.....
12123	8410	" Forked Connection.....
375C	8409	" " " " Hinge Screw.....
1518E	8412	" " " " " Nut...
16504	8410	" Lifting Rock Shaft.....
16588	----	Feed Lifting Rock Shaft complete, Nos. 3093, 12376, 16504 and 16558.....
16556	8412	Feed Lifting Rock Shaft Crank (back) with 462C.....
3093	8412	Feed Lifting Rock Shaft Crank (back) Pin.



No.	Plate	Name
462C	8412	Feed Lifting Rock Shaft Crank (back) Set Screw.....
12376	770	Feed Lifting Rock Shaft Crank (front) with 157J and 1813.....
157J	8412	Feed Lifting Rock Shaft Crank (front) Clamping Screw.....
1813	8412	Feed Lifting Rock Shaft Crank (front) Roller and Stud.....
43976	8411	Feed Lifting Rock Shaft Crank Connecting Rod with 43977 and two 966E.....
*43977	----	Feed Lifting Rock Shaft Crank Connecting Rod Cap.....
966C	8412	Feed Lifting Rock Shaft Crank Connecting Rod Cap Screw.....
375C	8409	Feed Lifting Rock Shaft Crank Connecting Rod Hinge Screw.....
1518E	8412	Feed Lifting Rock Shaft Crank Connecting Rod Hinge Screw Nut.....
307C	8412	Feed Lifting Rock Shaft Screw Center.....
56814	----	" " " " " " 307C with 1513J.....
1513J	8412	Feed Lifting Rock Shaft Screw Center Nut.....
3039	8410	" Regulator.....
1128E	8412	" " Hinge Screw.....
818D	8412	" " Thumb Screw.....
16506	8411	" Rock Shaft.....
24376	----	Feed Rock Shaft complete, Nos. 16506 and 29633.....
29633	8412	Feed Rock Shaft Crank with 157J.....
157J	8412	" " " " " Clamping Screw.....
307C	8412	" " " " " Screw Center.....
56814	----	" " " " " " 307C with 1513J.....
1513J	8412	Feed Rock Shaft Screw Center Nut.....
16598	1338	Knife (narrow) end and side cut.....
<b>Note: Five No. 16598 are sent with this machine unless other Knives are specified on order.</b>		
19173	1338	Knife, broad, diagonal cut.....
19174	1338	" " end and side cut.....
19175	1338	" medium, end and side cut.....
19176	1338	" " " cut only.....
19177	1338	" " " " (shearing).....
19178	1338	" " " and side cut (concave).....
19179	1338	" " " " " " (thin gauge).....
19297	8413	Knife Bar with 2301.....
24431	8413	" " Crank with 191C.....
1162C	8414	" " " Coupling Pin.....

No.	Plate	Name
1564D	1338	Knife Bar Crank Coupling Pin Head.....
2297	1338	" " " " " Spring.....
2022	8414	" " " " Pin.....
191C	8414	" " " " Set Screw.....
24432	----	Knife Bar Crank complete, Nos. 1162C, 1564D, 2297 and 24431.....
16563	8413	Knife Bar Driving Crank (forked).....
16564	8413	" " " " Bracket.....
24433	----	Knife Bar Driving Crank Bracket complete, Nos. 2022, 16563, 16564 and 24432.....
647C	8414	Knife Bar Driving Crank Bracket Screw.....
24123	8414	" " " " Lifting Spring.....
24123	8414	" " " " Case.....
24124	8414	" " " " " Guide.....
24906	----	" " " " " " 24124 with 2523 and 24125.....
*24125	8414	Knife Bar Lifting Spring Guide Bracket... Screw
621J	8414	" " " " " " " Screw
2523J	8396	" " " " " " " Pin.....
2301	8414	" " Stop Pin.....
24127	----	Knife Bar complete, Nos. 621J, 16567, 19297 24126, 24906 and two 335H.....
<b>Note: No. 24127 is sent with this machine unless otherwise ordered.</b>		
16567	8414	Knife Holder with two 208D.....
24126	8414	" " Handle.....
335H	8414	" " Screw.....
24374	----	Knife Bar complete, Nos. 621J, 19297, 24373 24906 and two 335H.....
24371	8414	Knife Holder.....
24372	8414	" " Body with 442C.....
24142	8414	" " Handle.....
14026	8414	" " " Rivet.....
14026	8414	" " " Hinge Pin.....
24143	8414	" " Spring.....
442C	8414	" " Stop Screw.....
24373	----	Knife Holder (hinged) complete, Nos. 2291 24142, 24143, 24371, 24372 and two each 223F and 14026.....
208D	8412	Knife Screw for 16567.....
223F	8414	" " " 24373.....
2291	1338	" " Washer.....
16568	8413	Needle Bar with 620F, 904E and 24391.....
19265	8413	" " " 904E, for 19173.....
12382	770	" " Connecting Link with 794E.....
43997	----	" " " " " 12382 with 12384.....
794E	8414	Needle Bar Connecting Link Adjusting Screw.....

No.	Plate	Name
*12383	----	Needle Bar Connecting Stud.....
1904	770	" " " " Roller (roller only).....
453C	8412	Needle Bar Connecting Stud Set Screw....
12384	770	Needle Bar Connecting Stud complete, Nos. 453C, 1904 and 12383.....
16569	8413	Needle Bar Crank (eccentric) with 448C and 743C.....
743C	8414	Needle Bar Crank Position Screw.....
448C	8409	" " " " Set Screw.....
24391	8414	" " " " Thread Guard.....
620F	8414	" " " " Set Screw.....
904E	8414	" " " " Set Screw for 16568 and 19265.....
44222	8413	Oil Cup.....
44223	----	" " 44222 with 44005.....
44214	----	" " Extension.....
44005	8413	" " " " 44214 with 24075.....
24075	8413	" " " " Post.....
44006	8413	" " " " Packing (felt).....
44224	8413	" " " " Thread Retainer.....
44225	8413	Oil Cup complete, Nos. 44006, 44223 and 44224.....
*24104	8413	Oscillating Rock Shaft.....
24105	----	Oscillating Rock Shaft complete, Nos. 4784, 12388 and 24104.....
12388	8410	Oscillating Rock Shaft Hinge Pin.....
448C	8409	" " " " " " Set Screw
4784	8414	" " " " " " Oil Pad.....
16509	8417	" " " " " " Shaft.....
19496	----	" " " " " " Crank for 19447.....
44134	----	" " " " " " 44135.....
19447	8394	Oscillating Shaft Crank complete, Nos. 457C, 1518E, 19449 and 19496.....
44135	8394	Oscillating Shaft Crank complete, Nos. 1518E, 19449, 44134 and two 453C.....
2049	8396	Oscillating Shaft Crank Pin.....
457C	8394	" " " " " " Set Screw for 19447.....
453C	8412	Oscillating Shaft Crank Set Screw for 44135.....
19448	8394	Oscillating Shaft Crank Slide Block.....
226J	8394	" " " " " " Cap Screw.....
12424	8394	Oscillating Shaft Crank Slide Block Cap Screw Washer.....
988C	8394	Oscillating Shaft Crank Slide Block Screw Stud.....
1518E	8412	Oscillating Shaft Crank Slide Block Screw Stud Nut.....

No.	Plate	Name
19449	8394	Oscillating Shaft Crank Slide Block complete, Nos. 226J, 988C, 12424 and 19448
19441	8417	Presser Bar (hollow).....
19464	----	Presser Bar complete, Nos. 190J, 19441 to 19443 and 24445.....
12388	770	Presser Bar Guide Bracket with 453C.....
453C	8412	" " " " " " Set Screw.....
2062	8418	" " " " " " Lifter.....
689C	8418	" " " " " " Screw.....
1528J	8394	" " " " " " Nut.....
12387	8394	" " " " " " Lifting and Releasing Lever Bracket.....
11167	8417	Presser Bar Spring (light) .051 wire....
Note: No. 11167 is sent with this machine unless another Spring is specified on order.		
12139	8417	Presser Bar Spring (medium) .055 wire....
20023	8417	" " " " (heavy) .063 wire....
11170	8418	" " " " " " Washer.....
688J	8396	Pressure Regulating Thumb Screw.....
1841	----	Roller, 7/8 in. diam., 9/64 in. face, fine, with 652D and 1528J.....
82677	8418	Roller Arm.....
19442	8418	" " " " " " Bracket.....
19443	8418	" " " " " " Position Collar with 456C.....
456C	8418	Roller Arm Bracket Position Collar Set Screw.....
987E	8418	Roller Arm Bracket Screw Stud.....
19444	8418	" " " " " " Spring.....
19445	8418	" " " " " " Pin.....
19446	8418	" " " " " " Stud.....
24445	----	Roller Arm Bracket Spring Stud complete, Nos. 987E and 19444 to 19446.....
62722	8402	Roller Presser complete, 7/8 in. diam., 9/64 in. face, fine roller, Nos. 1841 and 62677.....
Note: No. 62722 is sent with this machine unless another Roller Presser is specified on order.		
190J	8418	Roller Presser Screw.....
652D	8403	" " " " " " Screw for 1841.....
1528J	8396	" " " " " " Nut for 1841.....
2996	8396	Shuttle Bobbin.....
62739	----	" " " " " " Case.....
15140	8396	" " " " " " Latch.....
2973	8396	" " " " " " Lever.....
2974	8396	" " " " " " " " Fulcrum Pin.....
2975	8396	Shuttle Bobbin Case Latch Spring.....

No.	Plate	Name
592E	8396	Shuttle Bobbin Case Latch Stop Screw.....
15141	8396	" " " Hinge Nos. 2973,2974 and 15140.....
*7553	8396	Shuttle Bobbin Case Position Finger.....
2523	8396	" " " " " Rivet.
24412	8396	" " " " " Plate.....
391J	8402	" " " " " Screw.
62740	8396	Shuttle Bobbin Case complete, Nos. 591F, 592E,2523,2973,7553,15141,15273 and 62739.....
12393	8396	Shuttle Body.....
591F	8403	" Tension Regulating Screw.....
15278	8396	" " Spring.....
19292	8418	" " 1 11/16 in. diam.,Nos. 2996,12393 and 62740.....
*12394	----	Shuttle Driver.....
12444	8418	" " 12394 with two 1266C.....
2049	8396	" " Pin.....
1266C	8403	" " Set Screw.....
2531	8398	" Race Back.....
2532	8396	" " Position Pin.....
2533	8396	" " Spring.....
907D	8418	" " " " Screw.....
24413	----	" " Body.....
*62502	----	" " 24413 with 24418 and two 1053E.....
*62501	----	Shuttle Race Body 24413 with 24420 and two 1053E.....
62517	----	Shuttle Race Body 62502 with two 2532, for 24419.....
62516	----	Shuttle Race Body 62501 with two 2532, for 24421.....
24418	8396	Shuttle Race Cap for 62502.....
24420	8417	" " " " 62501.....
1053E	8418	" " " Screw.....
24419	8417	Shuttle Race complete, Nos. 907D,2531, 2533,24412,62517 and two 391J.....
24421	8417	Shuttle Race complete for 19174, Nos.907D 2531,2533,24412,62516 and two 391J...
145D	8418	Shuttle Race Screw.....
12431	----	" " Slide.....
12432	8422	Shuttle Race Slide complete, Nos. 4307, 12431 and two 725E.....
4307	8422	Shuttle Race Slide Spring.....
725E	8398	" " " " Screw.....
2102	8398	Tension Disc.....
1560C	8398	" Regulating Thumb Nut.....
32572	8398	" Releasing Disc.....
43944	8398	" " Lever.....

No.	Plate	Name
12398	8398	Tension Releasing Lever Hinge Pin.....
12329	8398	" " " Spring.....
32574	8398	" " " Pin.....
50327C	8398	" Screw Stud.....
*44141	----	" " " 50327C with 1560C.....
43945	8398	" Spring.....
12149	8398	" Thread Guard.....
*44118	----	Tension complete, Nos. 7336,32572,32574, 43945,43946,44141 and two 2102.....
52454	8398	Thread Retainer.....
624C	8398	" " Set Screw.....
12404	8398	" Take-up Crank.....
3094	8398	" " " Wedge.....
690E	8398	" " " " Screw.....
12408	770	" " Lever.....
775E	8398	" " " Cap Screw.....
12166	8398	" " " Hinge Pin.....
12409	770	" " " Link.....
11204	770	" " " " Hinge Pin.....
435C	8398	" " " " " " " Set Screw.....
12410	----	Thread Take-up Lever complete, Nos. 12166 12408 and 12409.....
43946	8398	Thread Take-up Spring.....
7336	8418	" " " Regulator.....
448C	8409	" " " " Set Screw.
19164	1270	Throat Plate Cutting Bar for 5/128 inch to 1/16 inch gauge for 19101.....
		Note: When ordering Nos. 18599,19164 or 62618 state required distance of trimmed edge from seam.
		Note: No. 19164, 1/16 inch gauge, is sent with this machine, unless otherwise specified on order.
62618	8415	Throat Plate Cutting Bar 5/64 inch to 1/4 inch gauge, for 62619.....
16599	1338	Throat Plate Cutting Bar 5/128 inch to 3/32 inch gauge, for 16597.....
238D	8415	Throat Plate Cutting Bar Screw.....
5478	1270	" " Extension.....
5479	1270	" " " Adjusting Link....
81D	1270	" " " " " Hinge Screw.....
5480	1270	Throat Plate Extension Adjusting Link Hinge Screw Washer.....
723D	1270	Throat Plate Extension Adjusting Link Thumb Screw.....
3146	1270	Throat Plate Extension Adjusting Link Thumb Screw Washer.....

No.	Plate	Name
289D	1270	Throat Plate Extension Adjusting Thumb Screw.....
1560E	1270	Throat Plate Extension Adjusting Thumb Screw Nut.....
240D	8412	Throat Plate Extension Screw.....
2328	1338	" " Spring Slide.....
2330	1338	" " " " Spring.....
56895	1338	" " " " " Stop (oval).....
725D	9398	Throat Plate Spring Slide Spring Stop Screw.....
62619	----	Throat Plate complete for 16680, 24392, 62620, Nos. 725D, 2328, 2330, 56895, 62618, 62675 and two 238D.....
62626	----	Throat Plate Body.....
16597	1338	Throat Plate complete for 16580, 24392, and 24951, Nos. 725D, 2328, 2330, 16595, 56895, 62626 and two 238D.....
62675	----	Throat Plate Body.....
19101	1270	Throat Plate complete, for 16580, 24392, 62675, Nos. 725D, 2328, 2330, 19104, 56895, 62675 and two 238D.....
*62575	8416	Throat Plate with Extension complete, Nos. 723D, 3148, 5478, 5479, 19101 and two each 240D, 289D and 1560E.....
19102	1270	Throat Plate with Extension 62575 with 81D and 8400.....
Note: No. 19102, 1/16 inch gauge, is sent with this machine unless otherwise specified on order.		
62620	----	Throat Plate with Extension complete for 62621, Nos. 723D, 3148, 5478, 5479, 62619 and two each 240D, 289D and 1560E.....
62621	----	Throat Plate with Extension 62620 with 81D and 8400.....
957F	1270	Throat Plate Screw.....
*15404	----	Trade Mark.....
15405	8398	" " Rivet.....
24079	8407	Drip Pan.....

LIST OF PARTS COMPLETE  
FOR

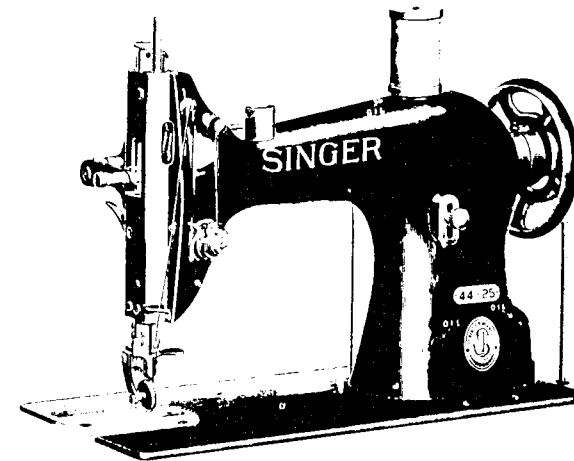

MACHINE No. 44-25

FOR LEATHER. HAS VERTICAL TRIMMER. WHEEL FEED.

SPEED 1800 R. P. M.

No.	Plate	Name
*16557	----	Arm with 11104, 15404 and two 15405.....
8582	8409	" Dowel Pin.....
12453	8409	" Oil Tube for intermediate bearing.....
12454	8409	" " " with 132590, for oiling 12409
24131	8409	" " " " 52045, for oiling 5570..
11113	8409	" " " " 52045, for oiling 12408 and 16569.....
52045	8409	Arm Oil Tube Packing (wick).....
132590	8409	" " " " (wick).....
748E	8409	" Screw (back).....
868E	8409	" " (front).....
16511	8388	" Shaft.....
*11104	----	" Bushing (front).....
12357	8388	" Flanged Bushing (back).....
448C	8409	" " " " Set Screw
144D	8409	" Screw.....
12193	8388	" Side Cover.....
51224D	8409	" " Thumb Screw.....
12403	8388	" Spool Pin and Thread Eyelet.....

No.	Plate	Name
8879	8420	Arm Spool Pin Washer (cloth).....
24296	8388	Balance Wheel (power) light rim, 2 3/16 inch pulley, with two 448C.....
24297	8388	Balance Wheel Oil Cover.....
210D	8409	" " " " Screw.....
448C	8409	" " " " Set Screw.....
*16596	----	Bed.....
20197	8388	Crank Connecting Rod with two 896C.....
896C	8409	" " " " Cap Screw.....
908C	8409	" " " " Hinge Screw.....
1619J	8409	" " " " " " Nut.....
16558	----	Face Plate.....
16559	8410	Face Plate complete, Nos. 2827, 12150 and 16558.....
203J	8409	Face Plate Screw.....
62682	8409	" " " " Thread Eyelet.....
*44181	----	" " " " " " Guard (lower).....
12150	8409	" " " " " " 44181 with 12152.....
12152	8409	Face Plate Thread Guard (lower) Rivet....
2827	8409	" " " " " " (upper) with 8505
8505	8409	" " " " " " Rivet....
3033	770	Feed Connecting Link.....
375C	8409	" " " " " " Hinge Screw.....
1518E	8412	" " " " " " Nut.....
5570	8410	" " Eccentric with 446C.....
446C	8409	" " " " " " Set Screw.....
12429	8410	" " Forked Connection.....
375C	8409	" " " " " " Hinge Screw.....
1518E	8412	" " " " " " Nut....
3039	8410	" " Regulator.....
1128E	8412	" " " " " " Hinge Screw.....
818D	8412	" " " " " " Thumb Screw.....
16506	8411	" " Rock Shaft.....
24378	----	Feed Rock Shaft complete, Nos. 16506 and 29633.....
29633	8412	Feed Rock Shaft Crank with 157J.....
157J	8412	" " " " " " Clamping Screw....
307C	8412	" " " " " " Screw Center.....
56814	----	" " " " " " " " 307C with 1513J.....
1513J	8412	Feed Rock Shaft Screw Center Nut.....
2258	8411	Feed Wheel.....
Note: No. 2258 is sent with this machine unless otherwise specified on order.		
15022	8411	Feed Wheel 2258, coarse teeth.....
2263	8417	" " " " " " Driver with 2266.....
19266	8411	" " " " " " Link.....
324D	8412	" " " " " " Screw.....

No.	Plate	Name
313C	8409	Feed Wheel Driver Link Screw Center.....
56813	----	" " " " " " " " 313C. with 1519J.....
1519J	8409	Feed Wheel Driver Link Screw Center Nut..
2265	8412	" " " " " " Spring.....
2266	8412	" " " " " " Hook.....
19267	8411	" " " " " " Frame with 453C.....
19302	----	Feed Wheel Frame complete, Nos. 151C, 183C 163F, 240D, 2252, 2254 to 2256, 2258, 3114 19267 and two each 119C and 1528J....
119C	8412	Feed Wheel Frame Adjusting Screw.....
1528J	8396	" " " " " " " " Nut.....
453C	8412	" " " " " " Set Screw.....
19268	8413	" " " " " " Shaft.....
307C	8412	" " " " " " Screw Center.....
56814	----	" " " " " " " " 307C with 1513J.....
1513J	8412	Feed Wheel Frame Shaft Screw Center Nut..
3114	8412	" " " " " " Friction Plate (back).....
151C	8412	" " " " " " " " Screw...
2252	8412	" " " " " " " " (front).....
183C	8412	" " " " " " " " Screw...
2254	8412	" " " " " " Retaining Clutch.....
2255	8412	" " " " " " " " Cap.....
183F	8412	" " " " " " " " Screw....
2256	8412	" " " " " " " " Spring.....
240D	8412	" " " " " " " " Screw.
16598	1338	Knife, narrow, end and side cut.....
Note: Five No. 16598 are sent with this machine un- less other Knives are specified on order.		
19173	1338	Knife, broad, diagonal cut.....
19174	1338	" " " " " " end and side cut.....
19175	1338	" " " " " " medium, end and side cut.....
19176	1338	" " " " " " cut only.....
19177	1338	" " " " " " (shearing).....
19178	1338	" " " " " " and side cut (concave)
19179	1338	" " " " " " " " " " (thin gauge).....
19297	8413	Knife Bar with 2301.....
24431	8413	" " " " " " Crank with 191C.....
1162C	8414	" " " " " " Coupling Pin.....
1564D	1338	" " " " " " " " Head.....
2297	1338	" " " " " " " " Spring.....
2022	8414	" " " " " " Pin.....
191C	8414	" " " " " " Set Screw.....
24432	----	Knife Bar Crank complete, Nos. 1162C, 1564D, 2297 and 24431.....
16563	8413	Knife Bar Driving Crank (forked).....
16564	8413	" " " " " " Bracket.....

No.	Plate	Name
24433	----	Knife Bar Driving Crank Bracket complete, Nos. 2022, 16563, 16564 and 24432.....
647C	8414	Knife Bar Driving Crank Bracket Screw....
24122	8414	" " Lifting Spring.....
24123	8414	" " " " Case.....
24124	8414	" " " " Guide.....
24906	----	" " " " " 24124 with 2523 and 24125.....
*24125	8414	Knife Bar Lifting Spring Guide Bracket...
621J	8414	" " " " " " Screw
2523	8396	" " " " " " Pin.....
2301	8414	" " Stop Pin.....
24127	----	Knife Bar complete, Nos. 621J, 16567, 19297, 24126, 24906 and two 335H.....
16567	8414	Knife Holder with two 208D.....
24126	8414	" " Handle.....
335H	8414	" " Screw.....
208D	8412	" " Screw.....
16568	8413	Needle Bar with 620F, 904E and 24391.....
19265	8413	" " " 904E, for 19173.....
12382	770	" " Connecting Link with 794E.....
43997	----	" " " " 12382 with 12384.....
794E	8414	Needle Bar Connecting Link Adjusting Screw.....
*12383	----	Needle Bar Connecting Stud.....
1904	770	" " " " Roller (roller only).....
453C	8412	Needle Bar Connecting Stud Set Screw....
12384	770	Needle Bar Connecting Stud complete, Nos. 453C, 1904 and 12383.....
16569	8413	Needle Bar Crank (eccentric) with 448C and 743C.....
743C	8414	Needle Bar Crank Position Screw.....
448C	8409	" " " Set Screw.....
24391	8414	" " Thread Guard.....
620F	8414	" " " " Set Screw.....
904E	8414	" " Set Screw for 16568 and 19265.....
44222	8413	Oil Cup.....
44223	----	" " 44222 with 44005.....
44214	----	" " Extension.....
44005	8413	" " " 44214 with 24075.....
24075	8413	" " " Post.....
44006	8413	" " Packing (felt).....
44224	8413	" " Thread Retainer.....
44225	8413	Oil Cup complete, Nos. 44006, 44223 and 44224.....
*24104	8413	Oscillating Rock Shaft.....

No.	Plate	Name
24105	----	Oscillating Rock Shaft complete, Nos. 4784, 12388 and 24104.....
12388	8410	Oscillating Rock Shaft Hinge Pin.....
878J	8414	" " " " " Oil Hole Stop Screw.....
12459	8414	Oscillating Rock Shaft Hinge Pin Oil Hole Stop Screw Washer (leather).....
448C	8409	Oscillating Rock Shaft Hinge Pin Set Screw.....
4784	8414	Oscillating Rock Shaft Oil Pad.....
16509	8417	" " Shaft.....
19496	----	" " Crank for 19447.....
44134	----	" " " 44135.....
19447	8394	Oscillating Shaft Crank complete, Nos. 457C, 1518E, 19449 and 19496.....
44135	8394	Oscillating Shaft Crank complete, Nos. 1518E, 19449, 44134 and two 453C.....
2049	8396	Oscillating Shaft Crank Pin.....
457C	8394	" " " Set Screw for 19447.....
453C	8412	Oscillating Shaft Crank Set Screw for 44135.....
19448	8394	Oscillating Shaft Crank Slide Block.....
226J	8394	" " " " " Cap Screw.....
12424	8394	Oscillating Shaft Crank Slide Block Cap Screw Washer.....
988C	8394	Oscillating Shaft Crank Slide Block Screw Stud.....
1518E	8412	Oscillating Shaft Crank Slide Block Screw Stud Nut.....
19449	8394	Oscillating Shaft Crank Slide Block complete, Nos. 226J, 988C, 12424 and 19443
19441	8417	Presser Bar (hollow).....
19464	----	Presser Bar complete, Nos. 190J, 19441 to 19443 and 24445.....
12326	770	Presser Bar Guide Bracket with 453C.....
453C	8412	" " " " Set Screw.....
2062	8418	" " Lifter.....
689C	8418	" " " Screw.....
1520E	8394	" " " Nut.....
12327	8394	" " Lifting and Releasing Lever Bracket.....
11167	8417	Presser Bar Spring (light) .051 wire....
Note: No. 11167 is sent with this machine unless another Spring is specified on order.		
12139	8417	Presser Bar Spring (medium) .055 wire....
20023	8417	" " " (heavy) .063 wire....
11170	8418	" " " Washer.....

No.	Plate	Name
688J	8396	Pressure Regulating Thumb Screw.....
1841	----	Roller, 7/8 in. diam., 9/64 in. face, fine with 652D and 1528J.....
62677	8418	Roller Arm.....
19442	8418	" " Bracket.....
19443	8418	" " " Position Collar with 456C.....
456C	8418	Roller Arm Bracket Position Collar Set Screw.....
987E	8418	Roller Arm Bracket Screw Stud.....
19444	8418	" " " Spring.....
19445	8418	" " " Pin.....
19446	8418	" " " Stud.....
24445	----	Roller Arm Bracket Spring Stud complete, Nos. 987E and 19444 to 19446.....
62722	8402	Roller Presser complete, 7/8 in. diam., 9/64 in. face, fine roller, Nos. 1841 and 62677.....
Note: No. 62722 is sent with this machine unless another Roller Presser is specified on order.		
190J	8413	Roller Presser Screw.....
652D	8403	" Screw for 1841.....
1528J	8396	" Nut for 1841.....
2996	8396	Shuttle Bobbin.....
62739	----	" " Case.....
15140	8396	" " " Latch.....
2973	8396	" " " Lever.....
2974	8396	" " " Fulcrum Pin.....
2975	8396	Shuttle Bobbin Case Latch Spring.....
592E	8396	" " " Stop Screw....
15141	8396	" " " Hinge, Nos. 2973, 2974 and 15140.....
*7553	8396	Shuttle Bobbin Case Position Finger.....
2523	8396	" " " Rivet
24412	8396	" " " Plate.....
391J	8402	" " " Screw.
62740	8396	Shuttle Bobbin Case complete, Nos. 591F, 592E, 2523, 2975, 7553, 15141, 15278 and 62739.....
12393	8396	Shuttle Body.....
591F	8403	" Tension Regulating Screw.....
15278	8396	" Spring.....
19292	8418	" 1 11/16 in. diam., Nos. 2996, 12393 and 62740.....
*12394	----	Shuttle Driver.....
12444	8418	" " 12394 with two 1266C.....
2049	8396	" " Pin.....

No.	Plate	Name
1266C	8403	Shuttle Driver Set Screw.....
2531	8398	" Race Back.....
2532	8396	" " " Position Pin.....
2533	8396	" " " Spring.....
907D	8418	" " " Screw.....
62749	----	" " Body.....
62754	----	" " " 62749 with 16584 and two 662D.....
62755	----	Shuttle Race Body 62754 with two 2532....
62756	----	" " " 62754 with 24412 and two 391J.....
16584	1355	Shuttle Race Cap for 62757.....
19182	1355	" " " 62761.....
662D	8418	" " " Screw.....
62757	8417	Shuttle Race complete, Nos. 907D, 2531J, 2533, 62756 and two 2532.....
24412	8396	Shuttle Bobbin Case Position Plate.....
391J	8402	" " " Screw.
62758	----	" Race Body 62749 with 19182 and two 662D.....
62759	----	Shuttle Race Body 62758 with two 2532....
62760	----	" " " 62758 with 24412 and two 391J.....
62761	8417	Shuttle Race complete for 19174, Nos. 907D, 2531, 2533, 62760 and two 2532.....
145D	8418	Shuttle Race Screw.....
12431	----	" " Slide.....
24810	----	Shuttle Race Slide complete, Nos. 4307, 12431 and two 1208J.....
4307	8422	Shuttle Race Slide Spring.....
1208J	8418	" " " Screw.....
2102	8398	Tension Disc.....
1560C	8398	" Regulating Thumb Nut.....
32572	8398	" Releasing Disc.....
43944	8398	" " Lever.....
12398	8398	" " " Hinge Pin.....
12329	8398	" " " Spring.....
32574	8398	" " Pin.....
50327C	8398	" Screw Stud.....
*44141	----	" " " 50327C with 1560C....
43945	8398	" Spring.....
12149	8398	" Thread Guard.....
*44118	----	Tension complete, Nos. 7336, 32572, 32574, 43945, 43946, 44141 and two 2102.....
52454	8398	Thread Retainer.....
624C	8398	" " Set Screw.....
12404	8398	" Take-up Crank.....
3094	8398	" " " Wedge.....
690E	8398	" " " " Screw.....

No.	Plate	Name
12408	770	Thread Take-up Lever.....
775E	8398	" " " Cap Screw.....
12166	8398	" " " Hinge Pin.....
12409	770	" " " Link.....
11204	770	" " " " Hinge Pin.....
435C	8398	" " " " " " Set Screw.....
12410	----	Thread Take-up Lever complete, Nos. 12166 12408 and 12409.....
43946	8398	Thread Take-up Spring.....
7336	8418	" " " Regulator.....
448C	8409	" " " " " " Set Screw
62672	----	Throat Plate Body for 24339 and 24369....
16599	1338	" " " Cutting Bar, 5/128 inch to 3/32 inch gauge.....
Note: When ordering No. 16599, state required dis- tance of trimmed edge from seam.		
Note: No. 16599, 3/64 inch gauge, is sent with this machine unless another gauge is specified on order.		
238D	8415	Throat Plate Cutting Bar Screw.....
2328	1338	" " " Spring Slide for 24339.....
2329	1338	" " " " " " 24369.....
2330	1338	" " " " " " Spring.....
56895	1338	" " " " " " Stop (oval).....
725D	8398	Throat Plate Spring Slide Spring Stop Screw.....
24339	1269	Throat Plate complete for 2258 and 15022, Nos. 725D, 2328, 2330, 16599, 56895, 62672 and two 238D.....
Note: No. 24339, 5/128 inch gauge, is sent with this machine unless otherwise specified on order.		
24369	1269	Throat Plate complete for 2258 and 15022, for 19174, Nos. 725D, 2329, 2330, 16599, 56895, 62672 and two 238D.....
Note: When ordering Nos. 24339 or 24369, state re- quired distance of trimmed edge from seam		
691F	8415	Throat Plate Screw.....
24370	----	Wheel Feed complete, Nos. 324D, 2263, 2265, 5570, 19266, 19268, 19302, 24339 or 24369 and 24810.....
Note: When ordering No. 24370, state required dis- tance of trimmed edge from seam.		
*15404	----	Trade Mark.....
15405	8398	" " Rivet.....
24080	8426	Drip Pan with four 1 in. wire nails, for Wheel Feed Machine.....

## ATTACHMENTS AND ACCESSORIES

No.	Plate	Name
51075E	8399	Machine Hinge Bolt with 51581E.....
51581E	8394	" " " Nut.....
6055	8399	" " " Washer.....
12361	8399	" " Connection.....
44139	8399	" " Plate.....
44140	----	Machine Hinge complete, Nos. 12361, 44139 and wood screw 1 1/4 in. No. 14.....
44180	----	Machine Hinge complete, Nos. 6055, 12361, 44139 and 51075E.....
12405	8399	Machine Rest (felt).....
41400	8400	" " Pin (wood) 3 1/8 in. long...
120342	8400	Oiler (copper plated) with 120343.....
120343	8400	" Spout, 3 1/2 in. long.....
26026	8400	Screw Driver (machine).....
26485	8400	" " (shuttle tension).....
35018	8400	Tape Delivery Blade.....
8909	8400	Wrench for 1513, 1518 and 51581.....
4822	8400	" " 1521 and 1528.....
8908	8400	" " 1519, 1520 and 1620.....
19221	8400	" " 1516 and 1619.....

## MACHINE BASE

No.	Plate	Name
24106	8399	Bed Frame Cushion (felt).....
158E	8399	" " " Screw.....
24107	8399	" " Hinge Connection.....
9261	8399	" " " Pin.....
970D	8399	" " Thumb Screw.....
24108	8408	" " with 970D, two each 9261, 24107, four each 158E, 24106 and six wood screws 1 1/4 in. No. 12.....
24908	8407	Drip Pan with two wood screws 1/2 in. No. 5 R.H.B.....

## BELT GUARD

No.	Plate	Name
41929	8408	Belt Guard.....
8418	8399	" " Button.....
8419	8399	" " " Washer (leather).....



No.	Plate	Name
8420	----	Belt Guard Button 8418 with 8419 and wood screw 1 1/4 in. No. 9 R.H.B.....
41930	8399	Belt Guard Hinge.....
41931	----	Belt Guard complete, Nos. 8420,41929, two 41930 and four wood screws 3/4 in.No. 9.....

## GUIDE

FOR 44-4 AND 44-25 MACHINES

No.	Plate	Name
25875	8410	Guide.....
284J	8415	" Thumb Screw.....

## BOBBIN WINDERS

### BOBBIN WINDER

SWINGING AUTOMATIC. RIGHT HAND

FOR 2996

FOR POWER TABLE

No.	Plate	Name
225433	8406	Bobbin Winder and Tension Bracket Base...
225453	8422	Frame with 202277 and 225438.....
225454	8420	" Hinge Pin.....
202277	----	" Oil Packing (wick).....
225438	8403	" " Well Cap.....
225455	8403	" Spring.....
225456	8420	" " Plunger.....
202473	8406	Pulley with 200380C.....
200380C	8403	" Set Screw.....
225381	8420	Spindle.....
225444	8420	Stop Latch.....
200056E	8403	" " Screw.....
225458	8420	" " Thumb Lever.....
225459	8403	" " " Hinge Stud.....
202478	8420	" " Trip Lever.....
200299H	8403	" " " Hinge Screw.....
225461	8420	Tension Bracket with 201499B.....
200082D	8403	" " Screw.....
228026	----	" " Washer.....
2102	8398	" Disc.....

No.	Plate	Name
202407	8403	Tension Spring.....
201499B	8420	" Stud.....
201572B	8403	" " Thumb Nut.....
225462	----	Tension Bracket complete, Nos. 201572B, 202407,225461 and two 2102.....
225382	8406	Bobbin Winder (swinging automatic, right hand) complete, Nos. 200056E,200082D, 200299H,202473,202478,225381,225433, 225444,225453 to 225456,225458,225462 228026, two each 225459 and wood screws 3/4 in. No. 12 R.H.B.....

## BOBBIN WINDER

SWINGING AUTOMATIC. RIGHT HAND

FOR 2996

FOR POWER TABLE

No.	Plate	Name
27552	8422	Base.....
15072	8415	Bobbin Position Pin.....
27302	6152	Frame.....
50356D	8415	" Hinge Screw.....
1620J	8415	" " " Nut.....
27303	8418	" Spring.....
27553	8422	Pulley.....
*27849	6152	Spindle.....
27538	6152	" 27849 with 15072,27850 and 41828.
*27850	8415	" Collar.....
41828	8425	" " Pin.....
27306	6152	Spool Pin.....
27307	6152	" Stand.....
27308	6152	Spool Stand complete, Nos. 418E,1562J, 2106,10141,11241,27306,27307 and two each 2455 and wood screws 1 in. No.10
11241	8388	Spool Washer (cloth).....
27312	6152	Stop Latch.....
35D	8415	" " Hinge Screw.....
2455	8420	Tension Disc.....
1562J	8420	" Regulating Thumb Nut.....
418E	8420	" Screw Stud.....
10141	8420	" Spring.....
2106	8420	" Thread Guide.....
27650	----	Bobbin Winder, Nos. 35D,1620J,27302,27303 27312,27538,27552,27553,50356D and two wood screws 1 in. No. 7.....
27554	----	Bobbin Winder (swinging automatic, right hand) complete, Nos. 27308 and 27650.

## BOBBIN WINDER

SWINGING AUTOMATIC. RIGHT HAND

FOR 2996

FOR STAND

This Bobbin Winder is the same as No. 27554 with the following exceptions:

No.	Plate	Name
27540	6152	Base, in place of 27552.....
27541	6152	Pulley, in place of 27553.....
27647	8422	Bobbin Winder, Nos. 35D,1620J,27302,27303 27312,27538,27540,27541,50356D and two wood screws 1 in. No. 7, in place of 27650.....
27544	----	Bobbin Winder (swinging automatic, right hand) complete, Nos. 27308 and 27647.

## FINGER GUARD

No.	Plate	Name
36818	8419	Finger Guard.....
36819	8419	" " Friction Washer.....
50316J	8419	" " Hinge Screw.....
36820	8419	" " Holder with 196J.....
196J	8394	" " Clamping Screw.....
36821	8419	Finger Guard complete, Nos. 36818 to 36820 and 50316J.....
120496	8419	Finger Guard.....
120497	8419	" " Holder with 50302J.....
50302J	8419	" " Set Screw.....
236J	8419	" " Screw.....
120498	8419	Finger Guard complete, Nos. 236J,120496 and 120497.....

## FOOT LIFTER

No.	Plate	Name
5596	6152	Bell Crank.....
56848	----	" " 5596 with 5599 and 5601.....
5599	6152	" " Bracket.....
178E	8403	" " Screw.....
5601	8419	" " Hinge Pin.....
5735	6152	" " Spring.....
5598	6152	Bell Crank complete, Nos. 5735 and 56848.
5670	----	Chain, length 26 in. to 35 in. with 56864 and 56865.....

Note: When ordering No. 5670, state length required

No.	Plate	Name
4879	8419	Chain Connecting Link.....
56864	8419	" Hook (large).....
56865	8419	" " (small).....
16585	8421	Lifting Lever with 448C, for 24426.....
12415	8421	" " Connecting Rod.....
12416	8419	" " " " Joint.....
76D	8403	" " " " " Hinge Screw.....
1521E	8403	Lifting Lever Connecting Rod Lock Nut....
802D	8419	" " Hinge Screw.....
12241	8424	" " Link for 24426.....
766D	8403	" " Hinge Screw.....
16586	8424	" " Pin for 24426.....
448C	8409	" " Set Screw.....
2763	8406	Rock Shaft.....
12242	8421	" " Hanger with two wood screws 1 in. No.10.....
6337	8406	Rock Shaft Lifting Bracket with two 356C.
12243	8406	" " " " Hook.....
7125	8406	" " " " Hook.....
356C	8403	" " " " Set Screw
356C	8403	" " " " Set Screw.....
2770	8406	" " Stop Dog with 356C.....
356C	8403	" " " " Set Screw.....
4880	8406	Rock Shaft complete, Nos. 2763,2770,7125, 12243 and two each 6337 and 12242....
4881	8406	Treadle.....
4882	6152	" Shaft.....
4883	6152	" Spring.....
4884	8406	" Stand.....
4885	8406	Treadle complete, Nos. 4879,4881 to 4884 and two wood screws 1 in. No. 16.....
24426	----	Foot Lifter complete, Nos. 76D,766D,802D, 1521E,4880,4885,5598,5670,12241,12415 12416,16585 16586 and two 178E.....

## KNIFE GRINDER

FOR 16598 AND 19173 TO 19179

No.	Plate	Name
27565	1104	Emery Wheel, 2 in. diam.....
1508J	1105	" " Clamping Nut.....
27822	1105	" " " " Washer.....
27567	1105	" " Shaft.....
60934	----	" " 27567 with 1508J,27565 27569 and 27822.....

## KNIFE GRINDER

No.	Plate	Name
27568	1105	Emery Wheel Shaft Oil Hole Cover (rubber)
27569	1105	" " " Pulley.....
310F	1105	" " " Screw Center.....
1516D	1105	" " " " " Nut.....
27564	1104	Frame with 27574.....
899J	1105	Knife Clamping Screw.....
27657	----	" Holder Body for 27658.....
27679	----	" " " " 27681.....
27658	1105	Knife Holder complete, Nos. 899J,27657 and 27660.....
27681	8423	Knife Holder complete, Nos. 899J,11833, 27660 and 27679.....
126392	8423	Knife Holder.....
126393	8423	Knife Holder complete for 16598 and 19173 to 19179, for 27661, Nos. 227J,899J, 11833,27660,126392 and 126394.....
27323	1105	Knife Holder Guide Bar.....
27572	1104	" " " " Bracket with 27574
310F	1105	" " " " " Screw Center.....
1516J	1105	Knife Holder Guide Bar Bracket Screw Center Nut.....
27573	1105	Knife Holder Guide Bar Bracket Spring....
27574	1105	" " " " " " Hook
27659	1105	" " Stop Collar with 237K.....
237K	1105	" " " " Set Screw.....
27660	8419	" Position Pin for 27658.....
27660	8419	" " " (lower) for 27681 and 126393.....
11833	8419	Knife Position Pin (upper) for 27681 and 126393.....
261J	1105	Knife Regulating Thumb Screw.....
126394	8420	" Stop.....
227J	8420	" " Screw.....
*60583	----	Knife Grinder, Nos. 261J,27323,27564, 27572,27573,27659,60934, two 27568 and four each 310F and 1516J.....
27661	----	Knife Grinder complete, Nos. 27662,60583, either 27658,27681 or 126393 and three wood screws 1 in. No. 10.....
27662	1104	Wrench for 1508 and 1516.....

## KNEE LIFTER PARTS

No.	Plate	Name
5596	6152	Bell Crank.....
56848	----	" " 5596 with 5599 and 5601.....

## KNEE LIFTER PARTS

No.	Plate	Name
5599	6152	Bell Crank Bracket.....
178E	8403	" " " Screw.....
5601	8419	" " Hinge Pin.....
5735	6152	" " Spring.....
5598	6152	Bell Crank complete, Nos. 5735 and 56848.
16585	8421	Lifting Lever with 448C, for 16587.....
12415	8421	" " Connecting Rod.....
12416	8419	" " " " " Joint.....
76D	8403	" " " " " Hinge Screw.....
1521E	8403	Lifting Lever Connecting Rod Lock Nut....
802D	8419	" " Hinge Screw.....
12241	8424	" " Link for 16587.....
766D	8403	" " " Hinge Screw.....
16586	8424	" " Pin for 16587.....
448C	8409	" " Set Screw.....
2759	8423	" Rod with 2761.....
2761	8420	" " Cap (washer).....
2762	8420	" " Collar with 362C.....
362C	8403	" " " Set Screw.....
2760	----	" 2759 with 2762.....
2763	8406	Rock Shaft.....
12242	8421	" " Hanger with two wood screws 1 in. No. 10.....
2765	8406	Rock Shaft Knee Arm for 2768.....
2766	8406	" " " " Hub with 356C.....
356C	8403	" " " " Set Screw.....
2768	----	" " " " 2765 with 2766 and 2767.....
2767	8406	Rock Shaft Knee Plate with 356C.....
356C	8403	" " " " Set Screw.....
6337	8406	" " Lifting Bracket with two 356C.
2778	8406	" " " " Hook.....
356C	8403	" " " " Set Screw
356C	8403	" " " " Set Screw.....
2770	8406	" " Stop Dog with 356C.....
356C	8403	" " " " Set Screw.....
2777	8406	" " 2763 with 2768,2770,2778,6337 and two 12242, for 16587.....
16587	----	Knee Lifter complete (power table) Nos. 76D,766D,902D,1521E,2777,5598,12241, 12415,12416,16585,16586 and two 178E.

## PLAIN ROLLER PRESSERS

Diameter of Roller	9/16"	7/8"	1 1/4"	1 1/4"	1 1/4"
Face of Roller	3/32"	9/64"	3/16"	9/64"	9/64"
Knurl of Roller	coarse	fine	coarse	coarse	coarse
Roller	51801	51802	1868	1895	1911
Roller Arm	24903	24903	62877	62877	16573
Roller Screw	388D	388D	652D	652D	386D
Roller Screw Nut	1550H	1550H	1528J	1528J	1528J
Roller Presser complete	24904	24905	62721	62680	16581

## BALL BEARING ROLLER PRESSERS

Diameter of Roller	7/8"	1 1/4"
Face of Roller	9/64"	7/32"
Knurl of Roller	coarse	coarse
Roller complete	51902	51863
Roller Arm	62857	62747
Roller Ball	208417	16232
Roller Ball Retaining Nut	201699	1766C
Roller Screw	350104C	50553C
Roller Nut	1528J	1528J
Roller Presser complete	62868	62748

## BALL BEARING ROLLER PRESSERS WITH RATCHET BRAKE

Diameter of Roller	7/8"	7/8"	7/8"	7/8"	7/8"	1 1/4"	1 1/4"
Face of Roller	9/64"	3/32"	1/3"	1/3"	1/8"	7/32"	1/8"
Knurl of Roller	coarse	fine	coarse	coarse	fine	coarse	coarse
Roller complete	51890	51912	51909	51907	51882	51894	51892
Roller Arm	62840	62840	62840	62840	62840	44274	62843
Roller Ball	208417	208417	208417	208417	208417	16232	16232
Roller Ball Retaining Nut	201699C	201699C	201699C	201699C	201699C	1766C	1766C
Roller Ratchet Spring Stop	62850	6295C	62850	62850	62850	62853	62853
Roller Ratchet Spring Stop Bracket	62851	62851	62877	62851	62851	62851	62851
Roller Ratchet Spring Stop Bracket complete	62852	62852	62878	62852	62852	62854	62854
Roller Ratchet Spring Stop Bracket Screw	230F	230F	230F	230F	230F	230F	230F
Roller Ratchet Spring Stop Screw	665J	665J	665J	665J	665J	665J	665J
Roller Screw	350104C	350104C	350104C	350104C	350104C	50553C	50553C
Roller Screw Nut	1528J	1528J	1528J	1528J	1528J	1528J	1528J
Roller Presser complete	44276	6288C	62891	62871	62842	44279	62849

## THREAD UNWINDER

No.	Plate	Name
225259	8405	Spool Rest with 201013C.....
150203	8405	" " Cushion (felt).....
225388	8405	" " Rod.....
200383C	8403	" " " Set Screw.....
201013C	8403	" " " Set Screw.....
202490	8405	" Stand with 200383C.....
225391	8405	Thread Guide.....
201696J	8403	" " Lock Nut.....
225326	8420	" " Position Cup.....
225324	8405	" " Rod with 208E and 225322....
208E	8412	" " " Screw.....
225322	8403	" " " Washer.....
225260	8405	Thread Unwinder complete, Nos. 150203, 201696J, 202490, 225259, 225324, 225326, 225388, 225391 and three wood screws 7/8 in. No. 12.....
27739	8405	Thread Cone (wood) for large cones.....
225390	8405	" " Holder for inverted cones....

Note: Nos. 27739 and 225390 are used with but not included in 225260.

## OBSOLETE PARTS

No.	Plate	Name
16532	8424	Arm Dowel Pin.....
19219	8424	Bed Frame Cushion (leather) for 19218 and 19399.....
12405	8399	Bed Frame Cushion (felt) for 16554.....
180C	8424	" " " Screw for 16554.....
19220	8424	" " " Spring for 19218 and 19399.....
19226	8424	Bed Frame Hinge Connection for 19228 and 19398.....
19227	----	Bed Frame Hinge Connection Cap for 19228, use 19397.....
19397	8424	Bed Frame Hinge Connection Cap for 19398.
211E	8424	" " " " " Screw.....
19228	----	Bed Frame Hinge Connection complete, Nos. 211E, 19226 and 19227, use 19398.....
19398	----	Bed Frame Hinge Connection complete, for 19399, Nos. 211E, 19226 and 19397.....
16555	8424	Bed Frame Hinge Plate for 16554, 19218 and 19399.....
14010	8424	Bed Frame Hinge Plate Rivet.....

No.	Plate	Name
16554	----	Bed Frame with two 16555, four each 190C and 12405 and six wood screws 1 1/4 in. No. 10, use 24108.....
19218	----	Bed Frame with two 16555, four each 19219 19220 and six each 14010 and wood screws 1 1/4 in. No. 10 and eight 158C, use 24108.....
19399	8426	Bed Frame complete, Nos. 970D, two each 16555, 19398, four each 19219, 19220, six each 14010, wood screws 1 1/4 in. No. 10 and eight 158C, use 24108.....
5602	8424	Bell Crank Spring for 5598.....
12365	8421	Crank Connecting Rod with 14013 and two 896C.....
12496	8421	Crank Connecting Rod with 14013 and two 896E, use 20197.....
*14013	----	Crank Connecting Rod Cap for 12365 and... 12496.....
375C	8409	Crank Connecting Rod Hinge Screw.....
1518E	8412	" " " " " Nut for 375C.....
12428	8421	Feed and Feed Lifting Eccentric with 446C
446C	8409	" " " " " Set Screw for 12428.....
16507	----	Feed Rock Shaft complete, Nos. 3043 and 16506, use 24376.....
3043	770	Feed Rock Shaft Crank with 462C, for 16507.....
462C	8412	Feed Rock Shaft Crank Set Screw for 3043.
1075E	8424	Guide Finger Holder Carrier Regulating Screw Stud.....
463C	8424	Guide Finger Holder Stop Screw.....
16561	8423	Knife Bar with 2301, for 16590.....
16562	8423	" " Crank with 191C, for 16589.....
897C	1338	" " " Coupling Pin for 16589...
16589	----	Knife Bar Crank complete for 24110, Nos. 897C, 1564D, 2297 and 16562, use 24432.
24110	----	Knife Bar Driving Crank Bracket complete, Nos. 2022, 16563, 16564 and 16589, use 24433.....
16565	----	Knife Bar Handle for 16590 and 19301....
16566	----	" " Lifting Spring for 44-4 Machine
19299	8424	" " " " Hook for 19301..
2266	8412	" " " " " " 16590..
16590	----	Knife Bar complete, for 44-4 Machine, Nos. 621J, 2266, 16561, 16565, 16567 and two 335H, use 19301.....
19301	----	Knife Bar complete, for 44-4 and 44-7 Ma- chines, Nos. 621D, 16565, 16567, 19297, 19299 and two 335H.....

No.	Plate	Name
463C	8424	Knife Holder Stop Screw for 24371.....
20368	770	Needle Bar Connecting Stud complete, Nos. 453C, 12383 and 20367, use 12384.....
20367	770	Needle Bar Connecting Stud Slide Block for 20368.....
696E	8424	Needle Bar Plug Screw.....
12495	8424	" " " Rivet.....
19487	----	Oil Cup with 12486, for 44-4 Machine, use 24024.....
*24020	8423	Oil Cup for 24024.....
24023	8423	" " Extension with 24075, for 24024..
12486	----	" " Packing (felt) for 24024.....
24024	8423	Oil Cup complete, for 44-4, 44-7 and 44-25 Machines, Nos. 12486, 24020 and 24023, use 44225.....
12386	8423	Oscillating Rock Shaft for 12387.....
12387	----	Oscillating Rock Shaft complete, Nos. 4784 12386 and 12388.....
12497	----	Oscillating Rock Shaft for 908C and 1902, for 12498, use 24104.....
12498	----	Oscillating Rock Shaft complete, Nos. 4784 12388 and 12497, use 24105.....
12443	8424	Oscillating Rock Shaft Oil Pad for 16508.
16508	8425	" " " " Holder with 12443.....
238D	8415	Oscillating Rock Shaft Oil Pad Holder Screw.....
12390	8425	Oscillating Shaft Crank complete, Nos. 457C, 1518E, 1902 and 19496.....
1902	8425	Oscillating Shaft Crank Roller and Screw Stud.....
1518E	8412	Oscillating Shaft Crank Roller and Screw Stud Nut.....
16570	8423	Presser Bar (hollow) for 44-4 and 44-7 Machines.....
1907	8425	Roller, 9/16 in., diam., 3/32 in. face, fine, with 388D and 1550J, for 16577.
1908	----	Roller, 9/16 in. diam., 3/32 in. face, coarse, with 388D and 1550J, for 16578.....
16571	8425	Roller Arm for 16577 and 16578.....
16574	8425	" " Bracket for 16570.....
16575	8425	" " " Position Collar with 456C, for 16570.....
16576	8425	Roller Arm Bracket Spring for 16574.....
16577	----	Roller Presser complete, 9/16 in. coarse roller, for 44-4, 44-7 and 44-25 Machines, Nos. 1907 and 16571, use 24904.....

No.	Plate	Name
16578	----	Roller Presser complete, 9/16 in. fine roller, for 44-4, 44-7 and 44-25 Machines, Nos. 1908 and 16571, use 24905
15003	8425	Shuttle Bobbin Case Hinge Nos. 2972 to 2974.....
2972	8425	Shuttle Bobbin Case Latch for 15003.....
12417	----	Shuttle Bobbin Case complete for 12392, Nos. 591F, 592E, 2523, 2526, 2975, 7553 and 15003, use 19293.....
19293	8425	Shuttle Bobbin Case complete for 19292, Nos. 591F, 592E, 2523, 2975, 7553, 15003 and 15098, use 62740.....
24074	8425	Shuttle Bobbin Case complete for 19292, Nos. 591F, 592E, 2523, 2975, 7553, 15098 and 15146, obsolete, use 62740.....
12392	----	Shuttle, 1 11/16 in. diam., Nos. 2996, 12393 and 12417, use 19292.....
648D	8418	Shuttle Race Back Spring Screw.....
5708	----	" " Body for 16583 and 19181....
16583	1355	Shuttle Race complete, for 44-4 and 44-7 Machines, Nos. 648D, 2531, 2533, 5708, 16584 and two each 662D and 2532, use 24419.....
19181	1355	Shuttle Race complete for 19174, for 44-4 and 44-7 Machines, Nos. 648D, 2531, 2533, 5708, 19182 and two each 662D and 2532, use 24421.....
647C	8414	Shuttle Race Screw, use 145D.....
240D	8412	" " Slide Spring Screw for 12432
2526	8425	" Tension Spring for 12417, use 15098
15098	8425	" " Spring.....
20081	8424	Tension Screw Stud Bushing.....
448C	8409	" " " " Set Screw....
20062	8424	" " " Flange.....
20063	8424	" " " Collar.....
12400	8425	Thread Retainer Sleeve.....
12401	8425	" " Spring.....
12402	8425	" " Stud.....
460C	8425	" " " Set Screw.....
12399	----	Thread Retainer complete, for 44-4, 44-7 and 44-25 Machines, Nos. 12400 to 12402, use 52379.....
210993	8425	Thread Retaining Sleeve.....
52398	8425	" " Spring.....
52378	8424	" " Stud.....
210958	8425	" " " Collar.....
52379	----	Thread Retainer complete, Nos. 52378, 52398, 210958 and 210993.....
430C	8425	Thread Take-up Lever Link Hinge Pin Set Screw.....

## NUMERICAL LIST OF PARTS

No.	Plate	Name
35D	8415	Bobbin Winder Stop Latch Hinge Screw for 27647 and 27650.....
76D	8403	Lifting Lever Connecting Rod Joint Hinge Screw for 16587 and 24426.....
81D	1270	Throat Plate Extension Adjusting Link Hinge Screw for 19102 and 62621.....
119C	8412	Feed Wheel Frame Adjusting Screw for 19302.....
144D	8409	Arm Shaft Screw.....
145D	8418	Shuttle Race Screw.....
151C	8412	Feed Wheel Friction Plate (back) Screw for 19302.....
157J	8412	Feed Lifting Rock Shaft Crank (front) Clamping Screw for 12376.....
157J	8412	Feed Rock Shaft Crank Clamping Screw for 29633.....
158E	8399	Bed Frame Cushion Screw for 19218, 19399 and 24108.....
178E	8403	Bell Crank Bracket Screw for 16587 and 24426.....
180C	8424	Bed Frame Cushion Screw for 16554, obsolete
183C	8412	Feed Wheel Friction Plate (front) Screw for 19302.....
183F	8412	Feed Wheel Retaining Clutch Cap Screw for 19302.....
190J	8418	Roller Presser Screw for 19464.....
191C	8414	Knife Bar Crank Set Screw for 16562 and 24431.....
196J	8394	Finger Guard Holder Clamping Screw for 36820.....
203J	8409	Face Plate Screw.....
208E	8412	Feed Dog Screw.....
208D	8412	Knife Screw for 16567.....
208E	8412	Thread Unwinder Thread Guide Rod Screw for 225324.....
210D	8409	Balance Wheel Oil Cover Screw.....
211E	8424	Bed Frame Hinge Connection Cap Screw, obsolete, for 19228 and 19398.....
223F	8414	Knife Screw for 24373.....
226J	8394	Oscillating Shaft Crank Slide Block Cap Screw for 19449.....
227J	8420	Knife Grinder Knife Stop Screw for 126393.
230F	8402	Roller Ratchet Spring Stop Bracket Screw for 44276, 44279, 62842, 62849, 62871, 62880 and 62891.....
235J	8419	Finger Guard Screw for 120498.....

SINGER Needles should be used  
in SINGER Machines.  
These Needles and their Containers  
are marked with the  
Company's Trade Mark "SIMANCO."<sup>1</sup> 1

Needles in Containers marked  
"FOR SINGER MACHINES"  
are NOT **SINGER** made needles. 2

## NUMERICAL

### LIST

### OF PARTS



No.	Plate	Name
237K	1105	Knife Grinder Knife Holder Stop Collar Set Screw for 27659.....
238D	8415	Oscillating Rock Shaft Oil Pad Holder Screw, obsolete.....
238D	8415	Throat Plate Cutting Bar Screw for 16597, 19101, 19180, 24339, 24369, 24390 and 62619.....
240D	8412	Feed Wheel Retaining Clutch Spring Screw for 19302.....
240D	8412	Shuttle Race Slide Spring Screw for 12432, obsolete.....
240D	8412	Throat Plate Extension Screw for 62575 and 62620.....
261J	1105	Knife Grinder Knife Regulating Thumb Screw for 60583.....
284J	8415	Guide Thumb Screw for 25875 and 26836.....
289D	1270	Throat Plate Extension Adjusting Thumb Screw for 62575 and 62620.....
307C	8412	Feed Lifting Rock Shaft Screw Center for 56814.....
307C	8412	Feed Rock Shaft Screw Center for 56814....
307C	8412	" Wheel Frame Shaft Screw Center for 56814.....
310F	1105	Knife Grinder Emery Wheel Shaft Screw Center for 60583.....
310F	1105	Knife Grinder Knife Holder Guide Bar Bracket Screw Center.....
313C	8409	Feed Bar Screw Center for 56813.....
313C	8409	" Wheel Driver Link Screw Center for 56813.....
324D	8412	Feed Wheel Driver Link Screw for 24370....
335H	8414	Knife Holder Screw for 16590, 19301, 24127 and 24374.....
356C	8403	Rock Shaft Knee Arm Hub Set Screw for 2766
356C	8403	" " " Plate Set Screw for 2767..
356C	8403	" " Lifting Bracket Hook Set Screw for 6337.....
356C	8403	Rock Shaft Lifting Bracket Set Screw for 6337.....
356C	8403	Rock Shaft Stop Dog Set Screw for 2770....
362C	8403	Lifting Rod Collar Set Screw for 2762.....
375C	8409	Crank Connecting Rod Hinge Screw, obsolete
375C	8409	Feed Connecting Link Hinge Screw.....
375C	8409	" Forked Connection Hinge Screw.....
375C	8409	" Lifting Rock Shaft Crank Connecting Rod Hinge Screw.....
386D	8403	Roller Screw for 1897, 1911 and 1912.....
388D	8403	" " " 1907, 1908, 51801 and 51802

No.	Plate	Name
391J	8402	Shuttle Bobbin Case Position Plate Screw for 24419, 24421, 62756 and 62760.....
418E	8420	Bobbin Winder Tension Screw Stud for 27308
430C	8425	Thread Take-up Lever Link Hinge Pin Set Screw, obsolete.....
435C	8398	Thread Take-up Lever Link Hinge Pin Set Screw.....
442C	8414	Knife Holder Stop Screw for 24372.....
446C	8409	Feed and Feed Lifting Eccentric Set Screw for 12428.....
446C	8409	Feed Cam and Feed Lifting Eccentric Set Screw for 12197.....
446C	8409	Feed Eccentric Set Screw for 5570.....
448C	8409	Arm Shaft Flanged Bushing (back) Set Screw
448C	8409	Balance Wheel Set Screw for 24296.....
448C	8409	Needle Bar Crank Set Screw for 16569.....
448C	8409	Lifting Lever Pin Set Screw for 16585.....
448C	8409	Oscillating Rock Shaft Hinge Pin Set Screw
448C	8409	Tension Screw Stud Bushing Set Screw, obsolete.....
448C	8409	Thread Take-up Spring Regulator Set Screw.
453C	8412	Feed Wheel Frame Set Screw for 19267.....
453C	8412	Needle Bar Connecting Stud Set Screw for 12384 and 20368.....
453C	8412	Oscillating Shaft Crank Set Screw for 44135.....
453C	8412	Presser Bar Guide Bracket Set Screw for 12326.....
456C	8418	Roller Arm Bracket Position Collar Set Screw for 16575 and 19443.....
457C	8394	Oscillating Shaft Crank Set Screw for 12390 and 19447.....
460C	8425	Thread Retainer Stud Set Screw, obsolete..
462C	8412	Feed Lifting Rock Shaft Crank (back) Set Screw for 16556.....
462C	8412	Feed Rock Shaft Crank Set Screw for 3043, obsolete.....
463C	8424	Guide Finger Holder Stop Screw, obsolete..
463C	8424	Knife Holder Stop Screw for 24371, obsolete
591F	8403	Shuttle Tension Regulating Screw for 12417 19293, 24074 and 62740.....
592E	8396	Shuttle Bobbin Case Latch Stop Screw for 12417, 19293, 24074 and 62740.....
620F	8414	Needle Bar Thread Guard Set Screw for 16568.....
621J	8414	Knife Bar Lifting Spring Guide Bracket Screw for 16590, 19301, 24127 and 24374.
624C	8398	Thread Retainer Set Screw.....
647C	8414	Knife Bar Driving Crank Bracket Screw....

No.	Plate	Name
647C	8414	Shuttle Race Screw, obsolete, use 145D....
648D	8418	" " Back Spring Screw for 16583 and 19181, obsolete.....
652D	8403	Roller Screw for 1841,1868 and 1895.....
662D	8418	Shuttle Race Cap Screw for 16583,19181, 62754 and 62758.....
665J	8401	Roller Ratchet Spring Stop Screw for 62852 62854 and 62878.....
688J	8396	Pressure Regulating Thumb Screw.....
689C	8418	Presser Bar Lifter Screw.....
690E	8398	Thread Take-up Crank Wedge Screw.....
691F	8415	Throat Plate Screw.....
696E	8424	Needle Bar Plug Screw, obsolete.....
723D	1270	Throat Plate Extension Adjusting Link Thumb Screw for 62575 and 62620.....
725E	8398	Shuttle Race Slide Spring Screw for 12432.
725D	8398	Throat Plate Spring Slide Spring Stop Screw for 16597,19101,19180,24339, 24369,24390 and 62619.....
743C	8414	Needle Bar Crank Position Screw for 16569.
748E	8409	Arm Screw (back).....
766D	8403	Lifting Lever Link Hinge Screw for 16587 and 24426.....
775E	8398	Thread Take-up Lever Cap Screw.....
794E	8414	Needle Bar Connecting Link Adjusting Screw for 12382.....
802D	8419	Lifting Lever Hinge Screw for 16587 and 24426.....
818D	8412	Feed Regulator Thumb Screw.....
868E	8409	Arm Screw (front).....
878J	8414	Oscillating Rock Shaft Hinge Pin Oil Hole Stop Screw.....
896C	8409	Crank Connecting Rod Cap Screw for 12365, 12496 and 20197.....
897C	1338	Knife Bar Crank Coupling Pin for 16589, obsolete.....
899J	1105	Knife Grinder Knife Clamping Screw for 27658,27681 and 126393.....
904E	8414	Needle Set Screw for 16568 and 19265.....
907D	8418	Shuttle Race Back Spring Screw for 24419, 24421,62757 and 62761.....
908C	8409	Crank Connecting Rod Hinge Screw.....
957F	1270	Throat Plate Screw.....
986E	8412	Feed Lifting Rock Shaft Crank Connecting Rod Cap Screw for 43976.....
970D	8399	Bed Frame Thumb Screw for 19399 and 24108.
987E	8418	Roller Arm Bracket Screw Stud for 24445...
988C	8394	Oscillating Shaft Crank Slide Block Screw Stud for 19449.....

No.	Plate	Name
1053E	8418	Shuttle Race Cap Screw for 62501 and 62502
1075E	8424	Guide Finger Holder Carrier Regulating Screw Stud, obsolete.....
1128E	8412	Feed Regulator Hinge Screw.....
1162C	8414	Knife Bar Crank Coupling Pin for 24432....
1208J	8418	Shuttle Race Slide Spring Screw for 24810.
1266C	8403	" Driver Set Screw for 12444.....
1508J	1105	Knife Grinder Emery Wheel Clamping Nut for 60934.....
1513J	8412	Feed Lifting Rock Shaft Screw Center Nut for 56814.....
1513J	8412	Feed Rock Shaft Screw Center Nut for 56814
1513J	8412	" Wheel Frame Shaft Screw Center Nut for 56814.....
1516D	1105	Knife Grinder Emery Wheel Shaft Screw Cen- ter Nut.....
1516J	1105	Knife Grinder Knife Holder Guide Bar Bracket Screw Center Nut for 60583....
1518E	8412	Crank Connecting Rod Hinge Screw Nut for 375C, obsolete.....
1518E	8412	Feed Connecting Link Hinge Screw Nut.....
1518E	8412	" Forked Connection Hinge Screw Nut....
1518E	8412	" Lifting Rock Shaft Crank Connecting Rod Hinge Screw Nut.....
1518E	8412	Oscillating Shaft Crank Roller and Screw Stud Nut, for 12390, obsolete.....
1518E	8412	Oscillating Shaft Crank Slide Block Screw Stud Nut for 19447 and 44135.....
1519J	8409	Feed Bar Screw Center Nut for 56813.....
1519J	8409	" Wheel Driver Link Screw Center Nut for 56813.....
1520E	8394	Presser Bar Lifter Screw Nut.....
1521E	8403	Lifting Lever Connecting Rod Lock Nut for 16587 and 24426.....
1528J	8396	Feed Wheel Frame Adjusting Screw Nut for 19302.....
1528J	8396	Roller Screw Nut for 1841,1868,1895,1897, 1911,1912,51863,51882,51890,51892, 51894,51902,51907,51909 and 51912.....
1550J	8403	Roller Screw Nut for 1907,1908,51801 and 51802.....
1560C	8398	Tension Regulating Thumb Nut for 44141....
1562J	8420	Bobbin Winder Tension Regulating Thumb Nut for 27308.....
1564D	1338	Knife Bar Crank Coupling Pin Head for 16589 and 24432.....
1580E	1270	Throat Plate Extension Adjusting Thumb Screw Nut for 62575 and 62620.....
1619J	8409	Crank Connecting Rod Hinge Screw Nut.....

## NUMERICAL LIST OF PARTS

No.	Plate	Name
1620J	8415	Bobbin Winder Frame Hinge Screw Nut for 27647 and 27650.....
1766C	8402	Roller Ball Retaining Nut for 51863, 51892 and 51894.....
1813	8412	Feed Lifting Rock Shaft Crank (front) Roller and Stud for 12376.....
1841	----	Roller, 7/8 in. diam., 9/64 in. face, fine with 652D and 1528J, for 62722.....
1868	8401	Roller, 7/8 in. diam., 9/64 in. face, coarse with 652D and 1528J, for 62721.....
1895	8401	Roller, 7/8 in. diam., 3/16 in. face, coarse, with 652D and 1528J, for 62680.....
1897	8401	Roller, 1 1/4 in. diam., 3/16 in. face, coarse, with 386D and 1528J, for 62627.....
1902	8425	Oscillating Shaft Crank Roller and Screw Stud for 12390, obsolete.....
1904	770	Needle Bar Connecting Stud Roller (roller only) for 12364.....
1907	8425	Roller, 9/16 in. diam., 3/32 in. face, fine with 388D and 1550J, for 16577, obsolete.....
1908	----	Roller, 9/16 in. diam., 3/32 in. face, coarse, with 388D and 1550J, for 16579, obsolete.....
1911	8401	Roller, 1 1/4 in. diam., 9/64 in. face, coarse, with 386D and 1528J, for 16581.....
1912	----	Roller, 1 1/4 in. diam., 9/64 in. face, fine, with 386D and 1528J, for 16582.....
2022	8414	Knife Bar Crank Pin for 24110 and 24433.....
2049	8396	Oscillating Shaft Crank Pin.....
2049	8396	Shuttle Driver Pin.....
2062	8418	Presser Bar Lifter.....
2102	8398	Bobbin Winder Tension Disc for 225462.....
2102	8398	Tension Disc for 44118.....
2106	8420	Bobbin Winder Tension Thread Guide for 27308.....
2252	8412	Feed Wheel Friction Plate (front) for 19302.....
2254	8412	Feed Wheel Retaining Clutch for 19302.....
2255	8412	" " " " Cap for 19302.....
2256	8412	" " " " Spring for 19302.....
2258	8411	Feed Wheel for 15022, 19302, 24339 and 24369.....
2263	8417	" " Driver with 2266, for 24370.....
2265	8412	" " " Spring for 24370.....
2266	8412	" " " Hook for 2263.....
2266	8412	Knife Bar Lifting Spring Hook for 16590, obsolete.....
2291	1338	Knife Screw Washer for 24373.....

## NUMERICAL LIST OF PARTS

No.	Plate	Name
2297	1338	Knife Bar Crank Coupling Pin Spring for 16589 and 24432.....
2301	8414	Knife Bar Stop Pin for 16561 and 19297.....
2328	1338	Throat Plate Spring Slide for 16597, 19101, 24339, 24390, 62619.....
2329	1338	Throat Plate Spring Slide for 19130 and 24369.....
2330	1338	Throat Plate Spring Slide Spring for 16597 19101, 19130, 24339, 24369, 24390 and 62619.....
2455	8420	Bobbin Winder Tension Disc for 27308.....
2523	8396	Knife Bar Lifting Spring Guide Pin for 24906.....
2523	8396	Shuttle Bobbin Case Position Finger Rivet for 12417, 19293, 24074 and 62740.....
2526	8425	Shuttle Tension Spring for 12417, obsolete use 15098.....
2531	8398	Shuttle Race Back for 16583, 19181, 24419, 24421, 62757 and 62761.....
2532	8396	Shuttle Race Back Position Pin for 16583, 19181, 62516, 62517, 62518, 62755, 62757, 62759 and 62761.....
2533	8396	Shuttle Race Back Spring for 16583, 19181, 24419, 24421, 62757 and 62761.....
2759	8423	Lifting Rod with 2761, for 2760.....
2760	----	" " 2759 with 2762.....
2761	8420	" " Cap (washer) for 2759.....
2762	8420	" " Collar with 362C, for 2760.....
2763	8406	Rock Shaft for 2777 and 4880.....
2765	8406	" " Knee Arm for 2768.....
2766	8406	" " " Hub with 356C, for 2768.....
2767	9406	Rock Shaft Knee Plate with 356C, for 2768.....
2768	----	" " " Arm 2765 with 2766 and 2767, for 2777.....
2770	8406	Rock Shaft Stop Dog with 356C, for 2777 and 4880.....
2777	9406	Rock Shaft 2763 with 2769, 2770, 2778, 6337 and two 12242, for 16587.....
2779	8406	Rock Shaft Lifting Bracket Hook for 2777..
2827	8409	Face Plate Thread Guard (upper) with 8505, for 16559.....
2972	8425	Shuttle Bobbin Case Latch for 15003, obsolete.....
2973	8396	Shuttle Bobbin Case Latch Lever for 15003 and 15141.....
2974	8396	Shuttle Bobbin Case Latch Lever Fulcrum Pin for 15003 and 15141.....

No.	Plate	Name
12243	8406	Rock Shaft Lifting Bracket Hook for 4880..
12326	770	Presser Bar Guide Bracket with 453C.....
12327	8394	" " Lifting and Releasing Lever Bracket.....
12329	8398	Tension Releasing Lever Spring.....
12357	8388	Arm Shaft Flanged Bushing (back).....
12361	8399	Machine Hinge Connection for 44140 and 44180 (Attachments and Accessories)...
12365	8421	Crank Connecting Rod with 14013 and two 896C, obsolete.....
12368	8410	Feed Bar.....
12376	770	" Lifting Rock Shaft Crank (front) with 157J and 1813, for 16588.....
12382	770	Needle Bar Connecting Link with 794E, for 43997.....
12383	----	Needle Bar Connecting Stud for 12384 and 20368.....
12384	770	Needle Bar Connecting Stud complete, Nos. 453C, 1904 and 12383, for 43997.....
12386	8423	Oscillating Rock Shaft for 12387, obsolete
12387	----	Oscillating Rock Shaft complete 4784, 12386 and 12388, obsolete.....
12388	8410	Oscillating Rock Shaft Hinge Pin for 12387 12498 and 24105.....
12390	8425	Oscillating Shaft Crank complete, Nos. 457C 1518E, 1902 and 19496, obsolete.....
12392	----	Shuttle, 1 11/16 in. diam., Nos. 2996, 12393 and 12417, obsolete, use 19292..
12393	8396	Shuttle Body for 12392 and 19292.....
12394	----	" Driver for 12444.....
12398	8398	Tension Releasing Lever Hinge Pin.....
12399	----	Thread Retainer complete, for 44-4, 44-7 and 44-25 Machines, Nos. 12400 to 12402, obsolete, use 52379.....
12400	8425	Thread Retainer Sleeve for 12399, obsolete
12401	8425	" " Spring for 12399, obsolete
12402	8425	" " Stud, for 12399, obsolete.
12403	8388	Arm Spool Pin and Thread Eyelet.....
12404	8398	Thread Take-up Crank.....
12405	8399	Machine Rest (felt) Attachments and Accessories.....
12405	8399	Bed Frame Cushion (felt) for 16554, obsolete.....
12408	770	Thread Take-up Lever for 12410.....
12409	770	" " Link for 12410.....
12410	----	Thread Take-up Lever complete, Nos. 12166, 12403 and 12409.....
12415	8421	Lifting Lever Connecting Rod for 16587 and 24426.....

No.	Plate	Name
12416	8419	Lifting Lever Connecting Rod Joint for 16587 and 24426.....
12417	----	Shuttle Bobbin Case complete for 12392, Nos. 591F, 592E, 2523, 2526, 2975, 7553 and 15003, obsolete, use 19293.....
12424	8394	Oscillating Shaft Crank Slide Block Cap Screw Washer for 19449.....
12428	8421	Feed and Feed Lifting Eccentric with 446C, obsolete.....
12429	8410	Feed Forked Connection.....
12431	----	Shuttle Race Slide for 12432 and 24810....
12432	8422	Shuttle Race Slide complete, Nos. 4307, 12431 and two 725E.....
12443	8424	Oscillating Rock Shaft Oil Pad for 16508, obsolete.....
12444	8418	Shuttle Driver 12394 with two 1266C.....
12453	8409	Arm Oil Tube for intermediate bearing....
12454	8409	" " " with 132590, for oiling 12409
12459	8414	Oscillating Rock Shaft Hinge Pin Oil Hole Stop Screw Washer (leather).....
12486	----	Oil Cup Packing (felt) for 19487 and 24024 obsolete.....
12495	8424	Needle Bar Plug Screw Rivet obsolete.....
12496	8421	Crank Connecting Rod with 14013 and two 896C, obsolete, use 20197.....
12497	----	Oscillating Rock Shaft 908C and 1902, for 12498, obsolete, use 24104.....
12498	----	Oscillating Rock Shaft complete, Nos. 4784 12388 and 12497, obsolete, 24105.....
14010	8424	Bed Frame Hinge Plate Rivet for 19218 and 19399, obsolete.....
14013	----	Crank Connecting Rod Cap for 12385 and 12496, obsolete.....
14026	8414	Knife Holder Handle Rivet.....
14026	8414	" " " Hinge Pin for 24373...
15003	8425	Shuttle Bobbin Case Hinge, Nos. 2972 to 2974, for 12417 and 19293, obsolete...
15022	8411	Feed Wheel 2258, coarse teeth for 24339 and 24369.....
15072	8415	Bobbin Winder Bobbin Position Pin for 27538.....
15098	8425	Shuttle Tension Spring for 19293 and 24074 obsolete.....
15140	8396	Shuttle Bobbin Case Latch for 15141.....
15141	8396	" " " Hinge Nos. 2973, 2974 and 15140, for 24074 and 62740.....
15278	8396	Shuttle Tension Spring for 62740.....
15404	----	Trade Mark for 16557.....
15405	8398	" " Rivet for 16557.....

No.	Plate	Name
16232	8403	Roller Ball for 51863,51892 and 51894.....
16504	8410	Feed Lifting Rock Shaft for 16588.....
16506	8411	" Rock Shaft for 16507 and 24376.....
16507	----	Feed Rock Shaft complete, Nos. 3043 and 16506, obsolete, use 24376.....
16508	8425	Oscillating Rock Shaft Oil Pad Holder with 12443, obsolete.....
16509	8417	Oscillating Shaft.....
16511	8388	Arm Shaft for 62541.....
16532	8424	" Dowel Pin,obsolete.....
16554	----	Bed Frame with two 16555, four each 180C, and 12405 and six wood screws 1 1/4 in. No. 10, obsolete, use 24108.....
16555	8424	Bed Frame Hinge Plate for 16554, 19218 and 19399, obsolete.....
16556	8412	Feed Lifting Rock Shaft Crank (back) with 462C, for 16588.....
*16557	----	Arm with 11104,15404 and two 15405.....
16558	----	Face Plate for 16559.....
16559	8410	Face Plate complete, Nos. 2827,12150 and 16558.....
16560	1338	Feed Dog, 10 teeth (16 teeth to the inch) for 16597,19101,19180 and 62619.....
16561	8423	Knife Bar with 2301, for 16590, obsolete..
16562	8423	" " Crank with 191C, for 16589, obsolete.....
16563	8413	Knife Bar Driving Crank (forked) for 24110 and 24433.....
16564	8413	Knife Bar Driving Crank Bracket for 24110 and 24433.....
16565	----	Knife Bar Handle for 16590 and 19301, obsolete.....
16566	----	Knife Bar Lifting Spring for 44-4 Machine, obsolete.....
16567	8414	Knife Holder with two 208D, for 16590, 19301 and 24127.....
16568	8413	Needle Bar with 620F,904E and 24391.....
16569	8413	" " Crank (eccentric) with 448C and 743C, for 62541.....
16570	8423	Presser Bar (hollow) for 44-4 and 44-7 Machine, obsolete.....
16571	8425	Roller Arm for 16577 and 16578, obsolete..
16573	8402	" " " 16581 and 16582.....
16574	8425	" " Bracket for 16570, obsolete....
16575	8425	" " " Position Collar with 456C, for 16570, obsolete.....
16576	8425	Roller Arm Bracket Spring for 16574, obsolete.....

No.	Plate	Name
16577	----	Roller Presser complete, 9/16 in., coarse roller, for 44-4,44-7 and 44-25 Machines, Nos. 1907 and 16571, obsolete, use 24904.....
16578	----	Roller Presser complete, 9/16 in., fine roller, for 44-4,44-7 and 44-25 Machines, Nos. 1908 and 16571, obsolete, use 24905.....
16581	----	Roller Presser complete, 1 1/4 in. diam., 9/64 in. face, coarse roller, Nos.1911 and 16573.....
16582	----	Roller Presser complete, 1 1/4 in. diam., 9/64 in. face, fine roller, Nos. 1912 and 16573.....
16583	1355	Shuttle Race complete, for 44-4 and 44-7 Machines, Nos. 648D,2531,2533,5708, 16584 and two each 662D and 2532, obsolete, use 24419.....
16594	1355	Shuttle Race Cap for 16583 and 62754.....
16585	8421	Lifting Lever with 448C, for 16587 and 24426.....
16586	8424	Lifting Lever Pin for 16587 and 24426.....
16587	----	Knee Lifter complete (power table) Nos. 76D,766D,802D,1521E,2777,5598,12241, 12415,12416,16585,16586 and two 178E..
16588	----	Feed Lifting Rock Shaft complete, Nos.3093 12376,16504 and 16556.....
16589	----	Knife Bar Crank complete for 24110, Nos. 897C,1564D,2297 and 16562, obsolete, use 24432.....
16590	----	Knife Bar complete, for 44-4 Machine, Nos. 621D,2266,16561,16565,16567 and two 335H, obsolete, use 19301.....
*16596	----	Bed.....
16597	1338	Throat Plate complete for 16560,24392 and 24951, Nos. 725D,2328,2330,16599,56895 62626 and two 238D.....
16598	1338	Knife (narrow) end and side cut.....
16599	1338	Throat Plate Cutting Bar 5/128 in. to 3/32 in., gauge, for 16597,19180,24339 and 24369.....
19101	1270	Throat Plate complete for 16560,24392, 62575, Nos. 725D,2328,2330,19164,56895 62875 and two 238D, for 62575.....
19102	1270	Throat Plate with Extension 62575 with 81D and 5480.....
19164	1270	Throat Plate Cutting Bar for 5/128 in. to 1/16 in. gauge, for 19101.....
19173	1338	Knife, broad, diagonal cut.....

## NUMERICAL LIST OF PARTS

No.	Plate	Name
19174	1338	Knife, broad, end and side cut.....
19175	1338	" medium, end and side cut.....
19176	1338	" " " cut only.....
19177	1338	" " " " (shearing).....
19178	1338	" " " and side cut (concave).
19179	1338	" " " " " " (thin gauge).....
19180	1269	Throat Plate complete for 16560,24392 and 24951, for 19174, Nos. 725D,2329,2330, 16599,56895,62626 and two 238D.....
19181	1355	Shuttle Race complete for 19174, for 44-4 and 44-7 Machines, Nos. 648D,2531,2533 5708,19182 and two each 662D and 2532, obsolete, use 24421.....
19182	1355	Shuttle Race Cap for 19181,62758 and 62761
19218	----	Bed Frame with two 16555, four each 19219, 19220 and six each 14010 and wood screws 1 1/4 in. No. 10 and eight 158C obsolete, use 24108.....
19219	8424	Bed Frame Cushion (leather) for 19218 and 19399, obsolete.....
19220	8424	Bed Frame Cushion Spring for 19218 and 19399, obsolete.....
19221	8400	Wrench for 1516 and 1619 (Attachments and Accessories).....
19226	8424	Bed Frame Hinge Connection for 19228 and 19398, obsolete.....
19227	----	Bed Frame Hinge Connection Cap for 19228, obsolete, use 19397.....
19228	----	Bed Frame Hinge Connection complete, Nos. 211E,19226 and 19227, obsolete, use 19398.....
19265	8413	Needle Bar with 904E, for 19173.....
19266	8411	Feed Wheel Driver Link for 24370.....
19267	8411	" " Frame with 453C, for 19302.....
19268	8413	" " Shaft for 24370.....
19292	8418	Shuttle, 1 11/16 in. diam., Nos. 2996, 12393 and 62740.....
19293	8425	Shuttle Bobbin Case complete for 19292, Nos. 591F,592E,2523,2975,7553,15003 and 15098,obsolete, use 24074.....
19297	8413	Knife Bar with 2301, for 19301,24127 and 24374.....
19299	8424	Knife Bar Lifting Spring Hook for 19301, obsolete.....
19301	----	Knife Bar complete, for 44-4 and 44-7 Machines, Nos. 621D,16565,16567,19297, 19299 and two 335H, obsolete.....

## NUMERICAL LIST OF PARTS

No.	Plate	Name
19302	----	Feed Wheel Frame complete, Nos. 151C,183C, 183F,240D,2252,2254 to 2256,2258,3114, 19267 and two each 119C and 1528J, for 24370.....
19397	8424	Bed Frame Hinge Connection: Cap for 19398, obsolete.....
19398	----	Bed Frame Hinge Connection complete, for 19399, Nos. 211E,19226 and 19397, obsolete.....
19399	8426	Bed Frame complete, Nos. 970D, two each 16555,19398, four each 19219,19220,six each 14010, wood screws 1 1/4 in. No. 10 and eight 158C, obsolete, use 24108
19441	8417	Presser Bar (hollow) for 19464.....
19442	8418	Roller Arm Bracket for 19464.....
19443	8418	" " " Position Collar with 456C, for 19464.....
19444	8418	Roller Arm Bracket Spring for 24445.....
19445	8418	" " " " Pin for 24445..
19446	8418	" " " " Stud for 24445..
19447	8394	Oscillating Shaft Crank complete, Nos.457C 1518E,19449 and 19496.....
19448	8394	Oscillating Shaft Crank Slide Block for 19449.....
19449	8394	Oscillating Shaft Crank Slide Block complete, Nos. 226J,988C,12424 and 19448, for 19447 and 44135.....
19464	----	Presser Bar complete, Nos. 190J,19441 to 19443 and 24445.....
19487	----	Oil Cup with 12486, for 44-4 Machine, obsolete, use 24024.....
19496	----	Oscillating Shaft Crank for 12390 and 19447.....
20023	8417	Presser Bar Spring (heavy) .063 wire.....
20061	8424	Tension Screw Stud Bushing,obsolete.....
20062	8424	" " " Flange,obsolete.....
20063	8424	" " " Collar, obsolete
20197	8388	Crank Connecting Rod with two 896C, for 62635.....
20367	770	Needle Bar Connecting Stud Slide Block for 20368, obsolete.....
20368	770	Needle Bar Connecting Stud complete, Nos. 453C,12383 and 20367, obsolete, use 12384.....
*24020	8423	Oil Cup for 24024, obsolete.....
24023	8423	" " Extension with 24075, for 24024, obsolete.....

No.	Plate	Name
24024	8423	Oil Cup complete, for 44-4, 44-7 and 44-25 Machines, Nos. 12486, 24020 and 24023, obsolete, use 44225.....
24074	8425	Shuttle Bobbin Case complete for 19292, Nos. 591F, 592E, 2523, 2975, 7553, 15098 and 15141, obsolete, use 62740.....
24075	8413	Oil Cup Extension Post for 24023 and 44005
24079	8407	Drip Pan.....
24080	8426	Drip Pan with four 1 in. wire nails, for Wheel Feed Machine.....
24104	8413	Oscillating Rock Shaft for 24105.....
24105	----	Oscillating Rock Shaft complete, Nos. 4784 12388 and 24104.....
24106	8399	Bed Frame Cushion (felt) for 24108.....
24107	8399	" " Hinge Connection for 24108.....
24108	8408	" " with 970D, two each 9261, 24107, four each 158E, 24106 and six wood screws 1 1/4 in. No. 12.....
24110	----	Knife Bar Driving Crank Bracket complete, Nos. 2022, 16563, 16564 and 16589, obsolete, use 24433.....
24122	8414	Knife Bar Lifting Spring.....
24123	8414	" " " " Case.....
24124	8414	" " " " Guide for 24906..
24125	8414	" " " " Bracket for 24906.....
24126	8414	Knife Holder Handle for 24127.....
24127	----	Knife Bar complete, Nos. 621J, 16567, 19297, 24126, 24906 and two 335H.....
24131	8409	Arm Oil Tube with 52045, for oiling 5570 and 12197.....
24142	8414	Knife Holder Handle for 24373.....
24143	8414	" " Spring for 24373.....
24296	8388	Balance Wheel (power) light rim, 2 3/16 in. pulley, with two 448C.....
24297	8388	Balance Wheel Oil Cover.....
24339	1269	Throat Plate complete, for 2258 and 15022, Nos. 725D, 2328, 2330, 16599, 56895, 62672 and two 238D, for 24370.....
24369	1269	Throat Plate complete, for 2258 and 15022, for 19174, Nos. 725D, 2329, 2330, 16599, 56895, 62672 and two 238D, for 24370...
24370	----	Wheel Feed complete, Nos. 324C, 2263, 2265, 5570, 19266, 19268, 19302, 24339 or 24369 and 24810.....
24371	8414	Knife Holder for 24373.....
24372	8414	" " Body with 442C, for 24373....

No.	Plate	Name
24373	----	Knife Holder (hinged) complete, Nos. 2291, 24142, 24143, 24371, 24372 and two each 223F and 14026, for 24374.....
24374	----	Knife Bar complete, Nos. 621J, 19297, 24373, 24906 and two 335H.....
24376	----	Feed Rock Shaft complete, Nos. 16506 and 29633.....
24388	8415	Feed Dog (grooved) for 24390.....
24390	8415	Throat Plate complete for 24388, Nos. 725D 2328, 2330, 4947, 56895 and two 238D.....
24391	8414	Needle Bar Thread Guard for 16568.....
24392	1338	Feed Dog, 8 teeth (12 teeth to the inch) for 16597, 19101, 19180 and 62619.....
24412	8396	Shuttle Bobbin Case Position Plate for 24419, 24421, 62756 and 62760.....
24413	----	Shuttle Race Body for 62501 and 62502....
24418	8396	" " Cap for 62502.....
24419	8417	Shuttle Race complete, Nos. 907D, 2531, 2533 24412, 62517 and two 391J.....
24420	8417	Shuttle Race Cap for 62501.....
24421	8417	Shuttle Race complete, for 19174, Nos. 907D 2531, 2533, 24412, 62516 and two 391J....
24426	----	Foot Lifter complete, Nos. 76D, 766D, 802D, 1521E, 4880, 4885, 5598, 5670, 12241, 12415, 12416, 16585, 16586 and two 178E.....
24431	8413	Knife Bar Crank with 191C, for 24432.....
24432	----	Knife Bar Crank complete, Nos. 1162C, 1564D 2297 and 24431, for 24433.....
24433	----	Knife Bar Driving Crank Bracket complete, Nos. 2022, 16563, 16564 and 24432.....
24439	8415	Presser Foot (grooved).....
24445	----	Roller Arm Bracket Spring Stud complete, Nos. 987E and 19444 to 19446, for 19464.....
24810	----	Shuttle Race Slide complete, Nos. 4307, 12431 and two 1208J, for 24370.....
24903	8402	Roller Arm for 24904 and 24905.....
24904	----	Roller Presser complete, 9/16 in. diam., 3/32 in. face, coarse roller, Nos. 24903 and 51801.....
24905	----	Roller Presser complete, 9/16 in. diam., 3/32 in. face, fine roller, Nos. 24903 and 51802.....
24906	----	Knife Bar Lifting Spring Guide 24124 with 2523 and 24125, for 24127 and 24374...
24908	8407	Drip Pan with two wood screws 1/2 in. No.5 R.H.B.....
24951	8412	Feed Dog, 15 teeth (24 teeth to the inch) for 16597 and 19180.....

No.	Plate	Name
24990	8402	Roller Arm for 62627.....
25875	8410	Guide for 44-4 and 44-25 Machines.....
26028	8400	Screw Driver (machine) Attachments and Accessories.....
26485	8400	Screw Driver (shuttle tension) Attachments and Accessories.....
26836	8415	Guide for 44-4 Machine.....
27302	6152	Bobbin Winder Frame for 27647 and 27650...
27303	8418	" " " Spring for 27647 and 27650.....
27306	6152	Bobbin Winder Spool Pin for 27308.....
27307	6152	" " Stand for 27308.....
27308	6152	Bobbin Winder Spool Stand complete, Nos. 418E, 1562J, 2106, 10141, 11241, 27306, 27307 and two each 2455 and wood screws 1 in. No. 10, for 27544 and 27554.....
27312	6152	Bobbin Winder Stop Latch for 27647 and 27650.....
27323	1105	Knife Grinder Knife Holder Guide Bar for 60583.....
27538	6152	Bobbin Winder Spindle 27849 with 15072, 27850 and 41828, for 27647 and 27650..
27540	6152	Bobbin Winder Base for 27647.....
27541	6152	" " Pulley for 27647.....
27544	----	Bobbin Winder (swinging automatic, right hand) complete, Nos. 27308 and 27647..
27552	8422	Bobbin Winder Base for 27650.....
27553	8422	" " Pulley for 27650.....
27554	----	Bobbin Winder (swinging automatic, right hand) complete, Nos. 27308 and 27650..
27564	1104	Knife Grinder Frame with 27574, for 60583.
27565	1104	" " Emery Wheel, 2 in. diam., for 60934.....
27567	1105	Knife Grinder Emery Wheel Shaft for 60934.
27568	1105	" " " " " 011 Hole Cover (rubber) for 60583.....
27569	1105	Knife Grinder Emery Wheel Shaft Pulley for 60934.....
27572	1104	Knife Grinder Knife Holder Guide Bar Bracket with 27574, for 60583.....
27573	1105	Knife Grinder Knife Holder Guide Bar Bracket Spring for 60583.....
27574	1105	Knife Grinder Knife Holder Guide Bar Bracket Spring Hook for 27564 and 27572.....
27647	8422	Bobbin Winder for 27544, Nos. 35D, 1620J, 27302, 27303, 27312, 27538, 27540, 27541, 50356D and two wood screws 1 in. No. 7

No.	Plate	Name
27650	----	Bobbin Winder for 27554, Nos. 35D, 1620J, 27302, 27303, 27312, 27538, 27552, 27553, 50356D and two wood screws 1 in. No. 7
27657	----	Knife Grinder Knife Holder Body for 27658
27658	1105	Knife Grinder Knife Holder complete, Nos. 899J, 27657 and 27660, for 27661.....
27659	1105	Knife Grinder Knife Holder Stop Collar with 237K, for 60583.....
27660	8419	Knife Grinder Knife Position Pin for 27658.....
27660	8419	Knife Grinder Knife Position Pin (lower) for 27681 and 126393.....
27661	----	Knife Grinder complete, Nos. 27662, 60583 either 27658, 27681 or 126393 and three wood screws 1 in. No. 10.....
27662	1104	Knife Grinder Wrench for 1508, 1516 and 27661.....
27679	----	Knife Grinder Knife Holder Body for 27681
27681	8423	Knife Grinder Knife Holder complete, Nos. 899J, 11833, 27660 and 27679, for 27661
27739	8405	Thread Unwinder Thread Cone (wood) for large cones.....
27822	1105	Knife Grinder Emery Wheel Clamping Nut Washer for 60934.....
*27849	6152	Bobbin Winder Spindle for 27538.....
*27850	8415	" " " Collar for 27539...
29633	8412	Feed Rock Shaft Crank with 157J, for 24376
32572	8398	Tension Releasing Disc for 44118.....
32574	8398	" " Pin for 44118.....
35018	8400	Tape Delivery Blade (Attachments and Accessories).....
36818	8419	Finger Guard for 36821.....
36819	8419	" " Friction Washer for 36821...
36820	8419	" " Holder with 196J, for 36821.
36821	8419	Finger Guard complete, Nos. 36818 to 36820 and 50316J.....
41400	8400	Machine Rest Pin (wood) 3 1/8 in. long (Attachments and Accessories).....
41828	8425	Bobbin Winder Spindle Collar Pin for 27538.....
41929	8408	Belt Guard for 41931.....
41930	8399	" " Hinge for 41931.....
41931	----	Belt Guard complete, Nos. 8420, 41929, two 41930 and four wood screws 3/4 in. No. 9.....
43944	8398	Tension Releasing Lever.....
43945	8398	" Spring for 44118.....
43946	8398	Thread Take-up Spring for 44118.....



No.	Plate	Name
43976	8411	Feed Lifting Rock Shaft Crank Connecting Rod with 43977 and two 966E.....
*43977	----	Feed Lifting Rock Shaft Crank Connecting Rod Cap for 43976.....
43997	----	Needle Bar Connecting Link 12382 with 12384.....
44005	8413	Oil Cup Extension 44214 with 24075, for 44223.....
44006	8413	Oil Cup Packing (felt) for 44225.....
*44118	----	Tension complete, Nos. 7336, 32572, 32574, 43945, 43946, 44141 and two 2102.....
44134	----	Oscillating Shaft Crank for 44135.....
44135	8394	Oscillating Shaft Crank complete, Nos. 1518E, 19449, 44134 and two 453C.....
44139	8399	Machine Hinge Plate for 44140 and 44180 (Attachments and Accessories).....
44140	----	Machine Hinge complete, Nos. 12361, 44139 and wood screw 1 1/4 in. No. 14 (Attachments and Accessories).....
*44141	----	Tension Screw Stud 50327C with 1560C, for 44118.....
44180	----	Machine Hinge complete, Nos. 6055, 12361, 44139 and 51075E (Attachments and Accessories).....
*44181	----	Face Plate Thread Guard (lower) for 12150
44214	----	Oil Cup Extension for 44005.....
44222	8413	" " for 44223.....
44223	----	" " 44222 with 44005, for 44225.....
44224	8413	" " Thread Retainer for 44225.....
44225	8413	Oil Cup complete, Nos. 44006, 44223 and 44224.....
44274	8402	Roller Arm for 44279.....
44276	----	Roller Presser (ball bearing) complete, 7/8 in. diam., 9/64 in., face, coarse roller, Nos. 230F, 51890, 62840 and 62852.....
44279	8394	Roller Presser (ball bearing) complete, 1 1/4 in. diam., 7/32 in., face, coarse roller, Nos. 230F, 44274, 51894 and 62854.....
50302J	8419	Finger Guard Holder Set Screw for 120497.
50316J	8419	" " Hinge Screw for 36821.....
50327C	8398	Tension Screw Stud for 44141.....
50356D	8415	Bobbin Winder Frame Hinge Screw for 27647 and 27650.....
50553C	8401	Roller Screw for 51863, 51892 and 51894...
51075E	8399	Machine Hinge Bolt with 51581E, for 44180 (Attachments and Accessories).....
51224D	8409	Arm Side Cover Thumb Screw.....

No.	Plate	Name
51581E	8394	Machine Hinge Bolt Nut for 51075E (Attachments and Accessories).....
51801	8401	Roller, 9/16 in. diam., 3/32 in. face, coarse, with 388D and 1550H, for 24904
51802	----	Roller, 9/16 in. diam., 3/32 in. face, fine with 388D and 1550H, for 24905.....
51863	8401	Roller, 1 1/4 in. diam., 7/32 in. face, coarse (ball bearing) complete for 62748, Nos. 1528J, 1766C, 50553C and twenty-four 16232.....
51882	8401	Roller, 7/8 in. diam., 9/64 in. face, fine (ball bearing) complete for 62842, Nos. 1528J, 201699C, 350104C and twenty-eight 206417.....
51890	----	Roller, 7/8 in. diam., 9/64 in. face, coarse (ball bearing) complete for 44276, Nos. 1528J, 201699C, 350104C and twenty-eight 206417.....
51892	8401	Roller, 1 1/4 in. diam., 1/8 in. face, coarse (ball bearing) complete for 62849, Nos. 1528J, 1766C, 50553C and twenty-four 16232.....
51894	----	Roller, 1 1/4 in. diam., 7/32 in. face, coarse (ball bearing) complete for 44279, Nos. 1528J, 1766C, 50553C and twenty-four 16232.....
51902	8401	Roller, 7/8 in. diam., 9/64 in. face, coarse (ball bearing) complete for 62868, Nos. 1528J, 201699C, 350104C and twenty-eight 206417.....
51907	8401	Roller, 7/8 in. diam., 1/8 in. face, fine (ball bearing) complete for 62871, Nos. 1528J, 201699C, 350104C and twenty-eight 206417.....
51909	8401	Roller, 7/8 in. diam., 1/8 in. face, coarse (ball bearing) complete for 62891, Nos. 1528J, 201699C, 350104C and twenty-eight 206417.....
51912	8401	Roller, 7/8 in. diam., 3/32 in. face, fine (ball bearing) complete for 62880, Nos. 1528J, 201699C, 350104C and twenty-eight 206417.....
52045	8409	Arm Oil Tube Packing (wick) for 11119 and 24131.....
52378	8424	Thread Retaining Stud for 52379, obsolete.
52379	----	Thread Retainer complete, Nos. 52378, 52398 210958 and 210993, obsolete.....
52398	8425	Thread Retaining Spring for 52379, obsolete
52454	8398	" Retainer.....

No.	Plate	Name
56813	----	Feed Bar Screw Center 313C with 1519J.....
56813	----	" Wheel Driver Link Screw Center 313C with 1519J.....
56814	----	Feed Lifting Rock Shaft Screw Center 307C with 1513J.....
56814	----	Feed Rock Shaft Screw Center 307C with 1513J.....
56814	----	Feed Wheel Frame Shaft Screw Center 307C with 1513J.....
56848	----	Bell Crank 5596, with 5599 and 5601, for 5598.....
56864	8419	Chain Hook (large) for 5670.....
56865	8419	" " (small) for 5670.....
56895	1338	Throat Plate Spring Slide Spring Stop (oval) for 16597,19101,19180,24339, 24369,24390 and 62619.....
*60583	----	Knife Grinder Nos. 261J,27323,27564,27572, 27573,27659,60934, two 27568 and four each 310F and 1516J, for 27661.....
60934	----	Knife Grinder Emery Wheel Shaft 27567 with 1508J,27565,27569 and 27822, for 60583
*62501	----	Shuttle Race Body 24413 with 24420 and two 1053E, for 62516.....
*62502	----	Shuttle Race Body 24413 with 24418 and two 1053E, for 62517.....
62516	----	Shuttle Race Body 62501 with two 2532, for 24421.....
62517	----	Shuttle Race Body 62502 with two 2532, for 24419.....
62518	----	Shuttle Race Body 62509 with two 2532, ob- solete.....
62541	----	Arm Shaft 16511 with 12197 and 16569, for 62635.....
*62575	8416	Throat Plate with Extension complete, Nos. 723D,3146,5478,5479,19101 and two each 240D,289D and 1580E, for 19102.....
62618	8415	Throat Plate Cutting Bar 5/64 in. to 1/4 in. gauge for 62619.....
62619	----	Throat Plate complete for 16560,24392, 62620, Nos. 725D,2328,2330,56895,62618 62675 and two 238D.....
62620	----	Throat Plate with Extension complete for 62621, Nos. 723D,3146,5478,5479,62619 and two each 240D,289D and 1580E.....
62621	----	Throat Plate with Extension 62620 with 81D and 5480.....
62626	----	Throat Plate Body for 16597 and 19180.....

No.	Plate	Name
62627	----	Roller Presser complete, 1 1/4 in. diam., 3/16 in. face, coarse roller, Nos.1897 and 24990.....
*62635	----	Arm Shaft 62541 with 20197.....
62672	----	Throat Plate Body for 24339 and 24369.. .
62675	----	" " " " 19101 and 62619.....
62677	8418	Roller Arm for 62680 and 62721.....
62680	8402	Roller Presser complete, 7/8 in. diam., 3/16 in. face, with roller set 1/8 in. beyond center of needle, Nos. 1895 and 62677.....
62682	8409	Face Plate Thread Eyelet.....
62721	8402	Roller Presser complete, 7/8 in. diam., 9/64 in. face, coarse roller, Nos.1868 and 62677.....
62722	8402	Roller Presser complete, 7/8 in. diam., 9/64 in. face, fine roller, Nos. 1841 and 62677.....
*62739	----	Shuttle Bobbin Case for 62740.....
62740	8396	Shuttle Bobbin Case complete, Nos. 591F, 592E,2523,2975,7553,15141,15278 and 62739, for 19292.....
62747	8402	Roller Arm for 62748.....
62748	8394	Roller Presser (ball bearing)complete, 1 1/4 in. diam., 7/32 in. face, coarse roller, Nos. 51863 and 62747.....
62749	----	Shuttle Race Body for 62754 and 62758.....
62754	----	" " " 62749 with 16584 and two 662D, for 62755 and 62756.....
62755	----	Shuttle Race Body 62754 with two 2532.....
62756	----	" " " 62754 with 24412 and two 391J, for 62757.....
62757	8417	Shuttle Race complete, Nos. 907D,2531,2533 62756 and two 2532.....
62758	----	Shuttle Race Body 62749 with 19182 and two 662D, for 62759 and 62760.....
62759	----	Shuttle Race Body 62758 with two 2532.....
62760	----	" " " 62758 with 24412 and two 391J, for 62761.....
62761	8417	Shuttle Race complete, for 19174, Nos.907D 2531,2533,62760 and two 2532.....
62840	8402	Roller Arm for 44276,62842,62871,62880 and 62891.....
62842	----	Roller Presser (ball bearing) complete, 7/8 in. diam., 9/64 in. face, fine roller, Nos. 230F,51882,62840 and 62852.....
62843	8402	Roller Arm for 62849.....

No.	Plate	Name
62849	8394	Roller Presser (ball bearing) complete, 1 1/4 in. diam., 1/8 in. face, coarse roller, Nos. 230F, 51892, 62843 and 62854.....
62850	8401	Roller Ratchet Spring Stop for 62852 and 62878.....
62851	8402	Roller Ratchet Spring Stop Bracket for 62852 and 62854.....
62852	----	Roller Ratchet Spring Stop Bracket 62851 with 665J and 62850, for 44276, 62842, 62871 and 62880.....
62853	8401	Roller Ratchet Spring Stop for 62854.....
62854	----	Roller Ratchet Spring Stop Bracket 62851 with 665J and 62853, for 44279 and 62849.....
62857	8402	Roller Arm for 62888.....
62868	8402	Roller Presser (ball bearing) complete, 7/8 in. diam., 9/64 in. face, coarse roller, Nos. 51902 and 62857.....
62871	----	Roller Presser (ball bearing) complete, 7/8 in. diam., 1/8 in. face, fine roller, Nos. 230F, 51907, 62840 and 62852.....
62877	8402	Roller Ratchet Spring Stop Bracket for 62878.....
62878	----	Roller Ratchet Spring Stop Bracket 62877 with 665J and 62850, for 62891.....
62880	----	Roller Presser (ball bearing) complete, 7/8 in. diam., 3/32 in. face, fine roller, Nos. 230F, 51912, 62840 and 62852.....
62891	----	Roller Presser (ball bearing) complete, 7/8 in. diam., 1/8 in. face, coarse roller, Nos. 230F, 51909, 62840 and 62878.....
120342	8400	Oiler (copper plated) with 120343 (Attachments and Accessories).....
120343	8400	Oiler Spout, 3 1/2 in. long for 120342 (Attachments and Accessories).....
120496	8419	Finger Guard for 120498.....
120497	8419	" " Holder with 50302J, for 120498.....
120498	8419	Finger Guard complete, Nos. 236J, 120496 and 120497.....
126392	8423	Knife Grinder Knife Holder for 126393....
126393	8423	Knife Grinder Knife Holder complete, for 16598 and 19173 to 19179, for 27661, Nos. 227D, 899J, 11833, 27660, 126392 and 126394.....

No.	Plate	Name
126394	8420	Knife Grinder Knife Stop for 126393.....
132590	8409	Arm Oil Tube Packing (wick) for 12454....
150203	8405	Thread Unwinder Spool Rest Cushion (felt) for 225260.....
200056E	8403	Bobbin Winder Stop Latch Screw for 225382
200082D	8403	" " Tension Bracket Screw for 225382.....
200299H	8403	Bobbin Winder Stop Latch Trip Lever Hinge Screw for 225382.....
200380C	8403	Bobbin Winder Pulley Set Screw for 202473
200383C	8403	Thread Unwinder Spool Rest Rod Set Screw for 202490.....
201018C	8403	Thread Unwinder Spool Rest Set Screw for 225259.....
201499B	8420	Bobbin Winder Tension Stud for 225461....
201572B	8403	" " " " Thumb Nut for 225462.....
201696J	8403	Thread Unwinder Thread Guide Lock Nut for 225260.....
201699C	8402	Roller Ball Retaining Nut for 51882, 51890, 51902, 51907, 51909 and 51912.....
202277	----	Bobbin Winder Frame Oil Packing (wick) for 225453.....
202407	8403	Bobbin Winder Tension Spring for 225462..
202473	8406	" " Pulley with 200380C, for 225382.....
202478	8420	Bobbin Winder Stop Latch Trip Lever for 225382.....
202490	8405	Thread Unwinder Spool Stand with 200383C, for 225260.....
206417	8403	Roller Ball for 51882, 51890, 51902, 51907, 51909 and 51912.....
210958	8425	Thread Retaining Stud Collar for 52379...
210993	8425	" " Sleeve for 52379.....
225259	8405	" Unwinder Spool Rest with 201018C, for 225260.....
225260	8405	Thread Unwinder complete, Nos. 150203, 201696J, 202490, 225259, 225324, 225326, 225388, 225391 and three wood screws 7/8 in. No. 12.....
225322	8403	Thread Unwinder Thread Guide Rod Washer for 225324.....
225324	8405	Thread Unwinder Thread Guide Rod with 208E and 225322, for 225260.....
225326	8420	Thread Unwinder Thread Guide Position Cup for 225260.....
225381	8420	Bobbin Winder Spindle for 225382.....

## NUMERICAL LIST OF PARTS

No.	Plate	Name
225382	8406	Bobbin Winder (swinging automatic, right hand) complete, Nos. 200056E, 200082D, 200299H, 202473, 202478, 225381, 225433, 225444, 225453 to 225456, 225458, 225462, 228026, two each 225459 and wood screws 3/4 in. No. 12 R.H.B.....
225388	8405	Thread Unwinder Spool Rest Rod for 225260.
225390	8405	" " Thread Cone Holder for inverted cones.....
225391	8405	Thread Unwinder Thread Guide for 225260...
225433	8406	Bobbin Winder and Tension Bracket Base for 225382.....
225438	8403	Bobbin Winder Frame Oil Well Cap for 225453.....
225444	8420	Bobbin Winder Stop Latch for 225382.....
225453	8422	" " Frame with 202277 and 225438 for 225382.....
225454	8420	Bobbin Winder Frame Hinge Pin for 225382..
225455	8403	" " Spring for 225382.....
225456	8420	" " Plunger for 225382.....
225458	8420	Bobbin Winder Stop Latch Thumb Lever for 225382.....
225459	8403	Bobbin Winder Stop Latch Thumb Lever Hinge Stud for 225382.....
225461	8420	Bobbin Winder Tension Bracket with 201499B for 225462.....
225462	----	Bobbin Winder Tension Bracket complete, Nos. 201572B, 202407, 225461 and two 2102, for 225382.....
228026	----	Bobbin Winder Tension Bracket Screw Washer for 225382.....
350104C	8401	Roller Screw for 51882, 51890, 51902, 51907, 51909 and 51912.....

SINGER Needles should be used  
in SINGER Machines.  
These Needles and their Containers  
are marked with the  
Company's Trade Mark "SIMANCO." 1

Needles in Containers marked  
"FOR SINGER MACHINES"  
are NOT **SINGER** made needles. 2

## ILLUSTRATIONS OF PARTS

PLATE 770—FULL SIZE

12404

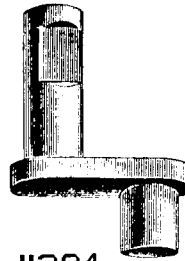

12384

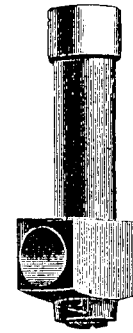

1904



12408

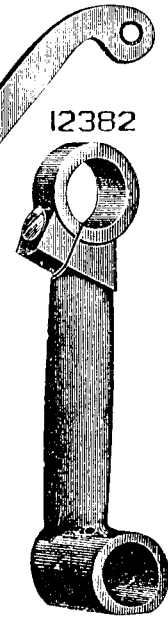

12382

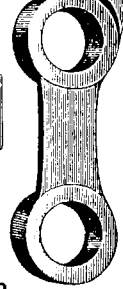

11204



12409

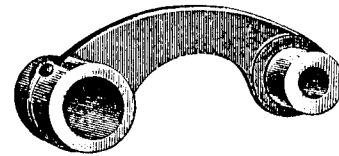

12376

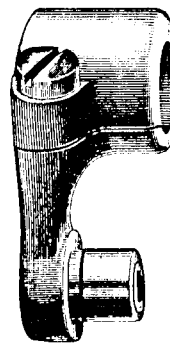

3043

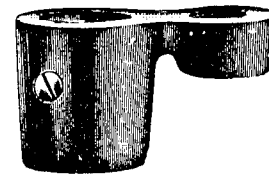

12326

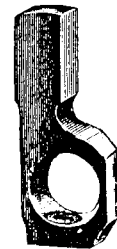

12327

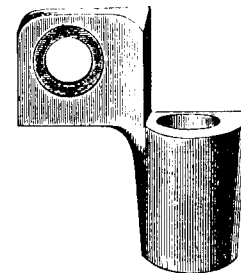

20367

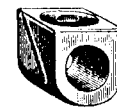

3033



20368

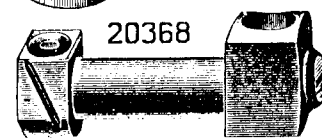

PLATE 1104—ONE-HALF SIZE

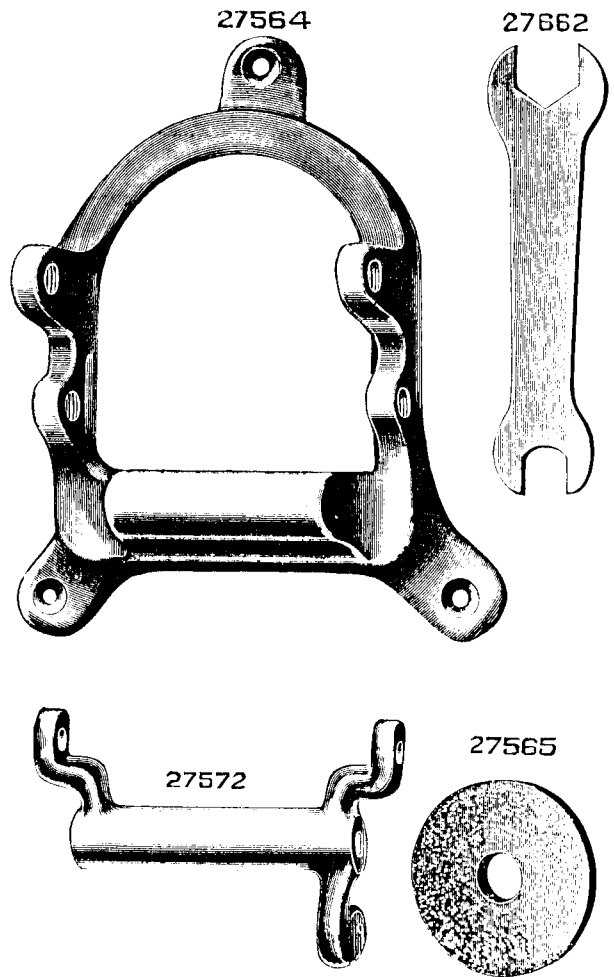

PLATE 1105—FULL SIZE

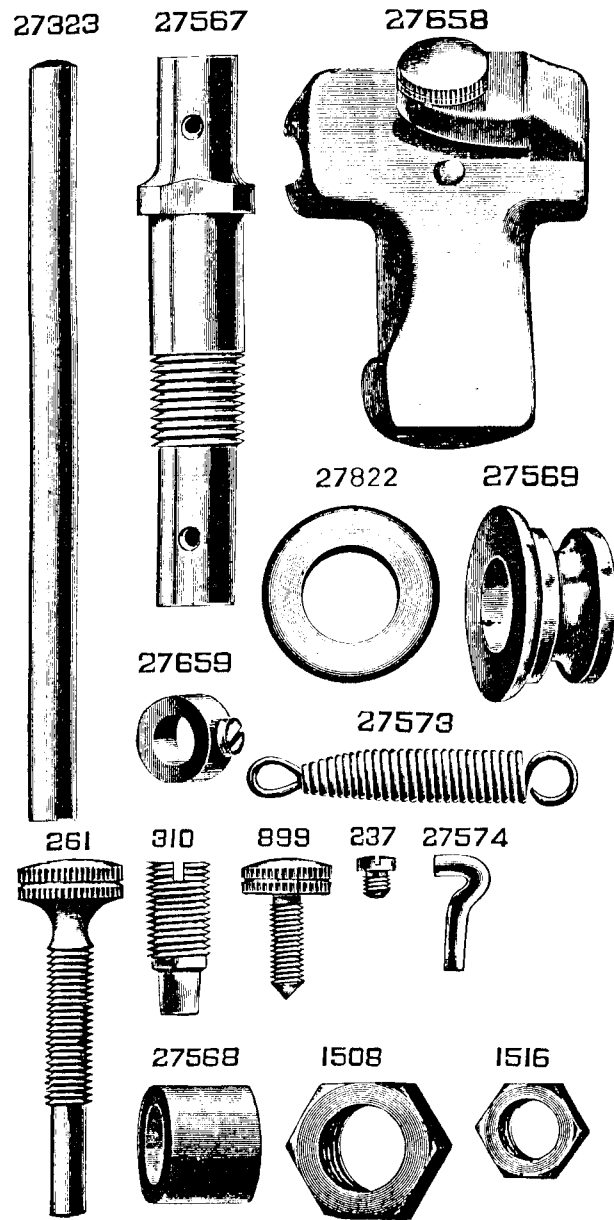

PLATE 1269—FULL SIZE

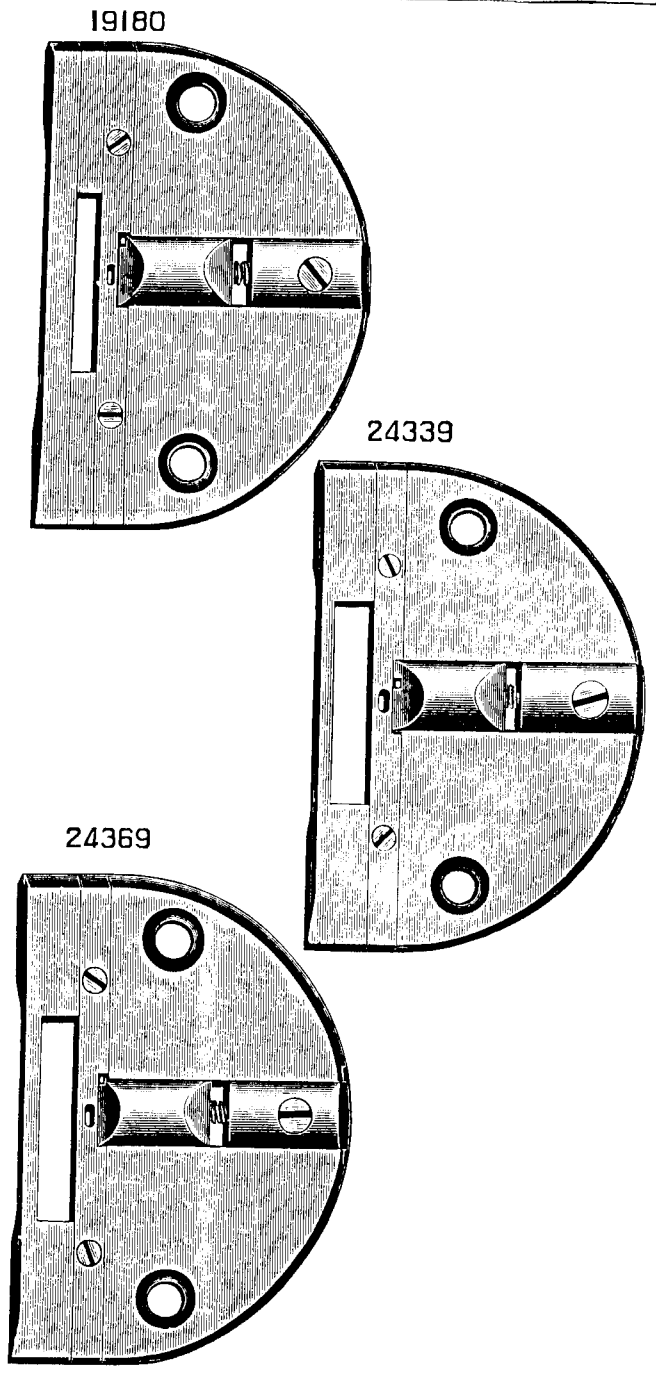

PLATE 1270—FULL SIZE

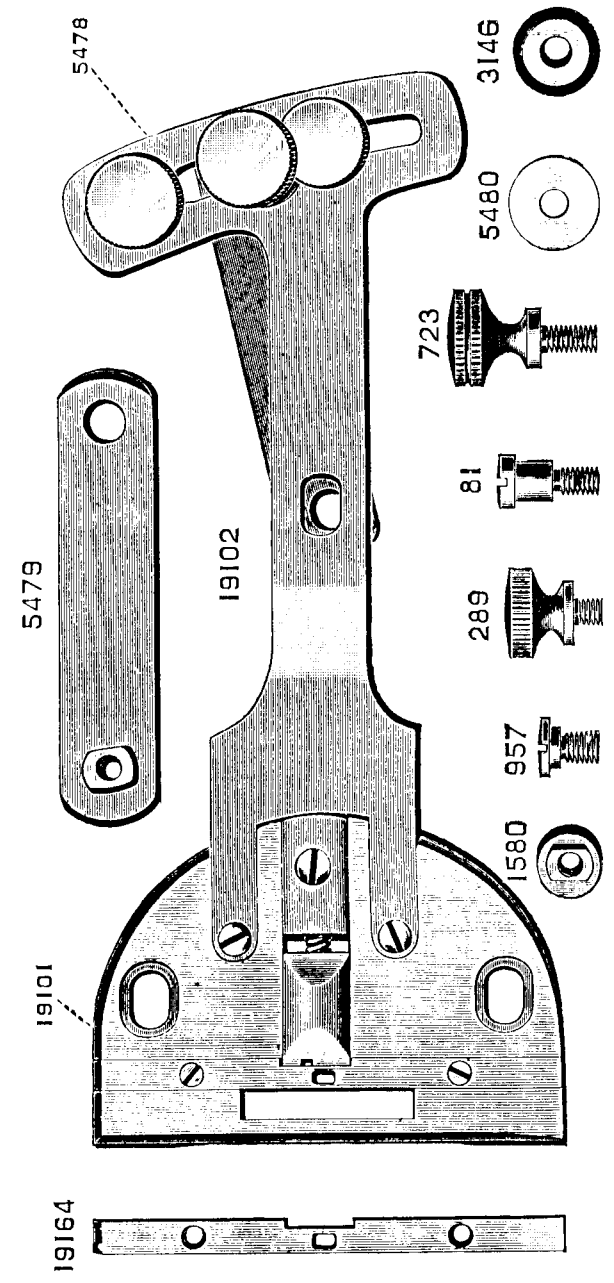

PLATE 1888—FULL SIZE

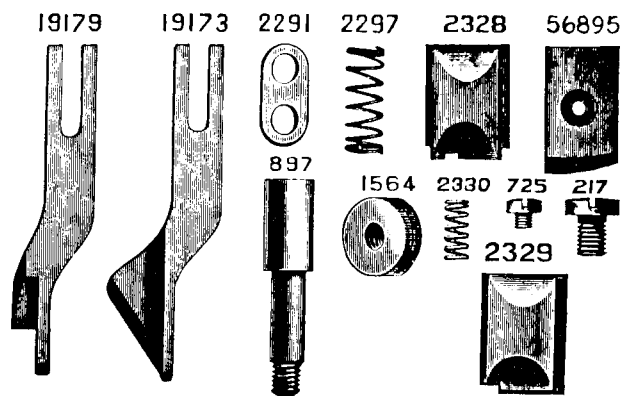
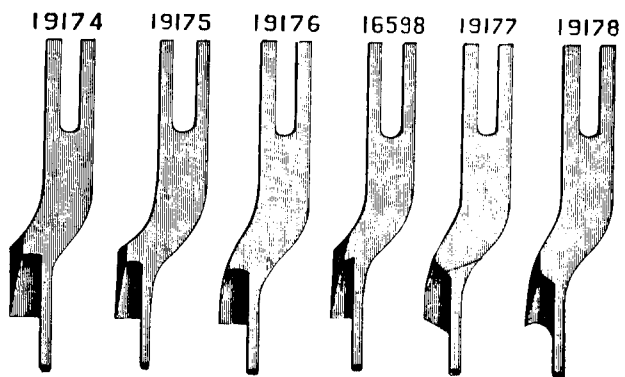
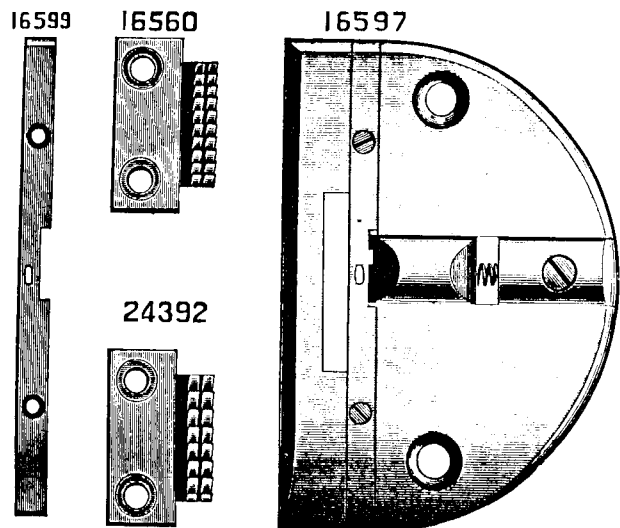

PLATE 1355 - FULL SIZE

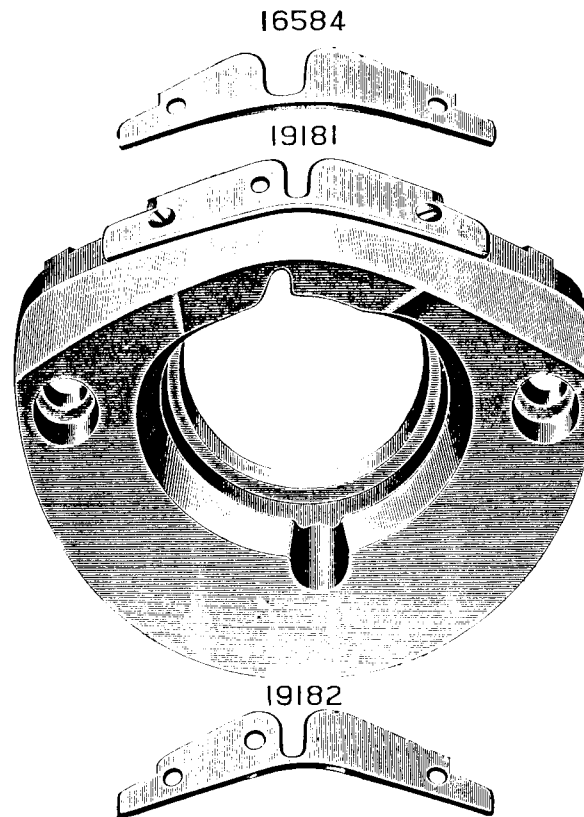
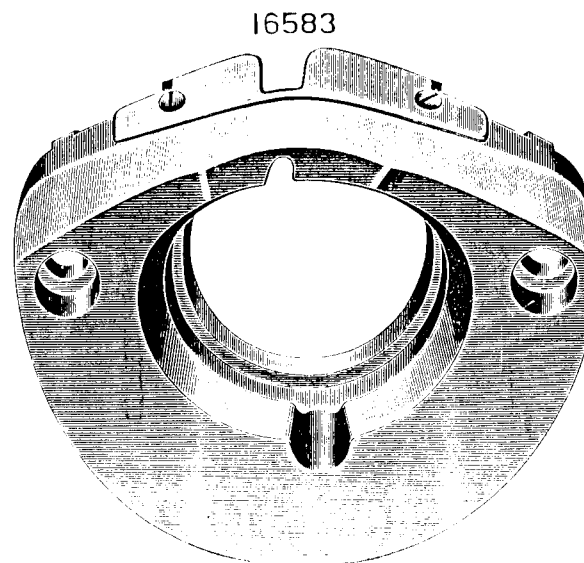
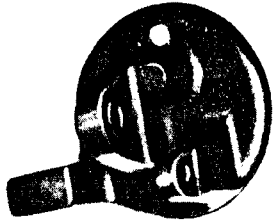



PLATE 6152-ONE-HALF SIZE

27540



27312



27302

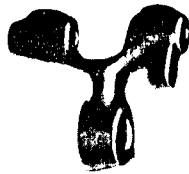

27541

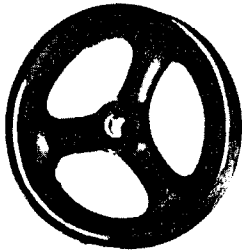

27307



27308

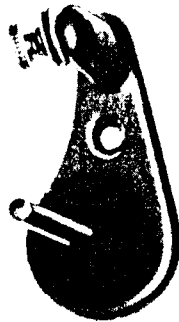

4883

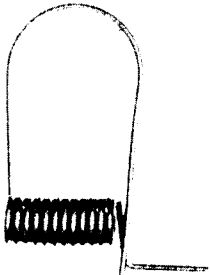

27306



27849

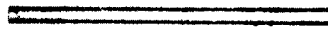

27538



4882

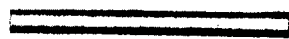

5596



5599



5735



5598

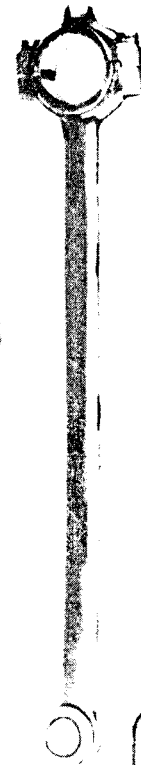

PLATE 8388-ONE-HALF SIZE

16311



2497



12193

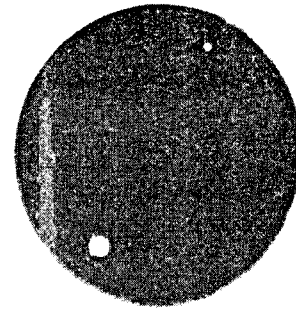

12357



1403

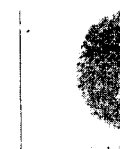

11241

12480

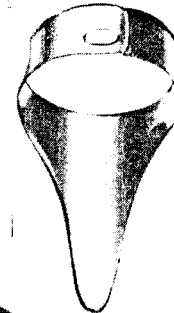

24296

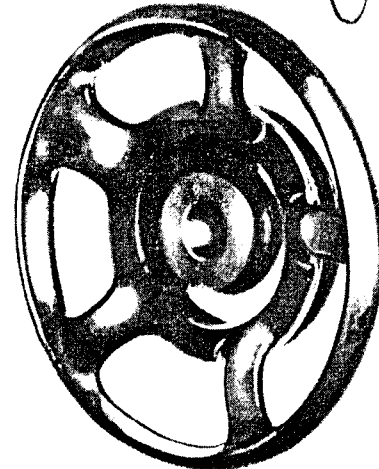

PLATE 8394—FULL SIZE

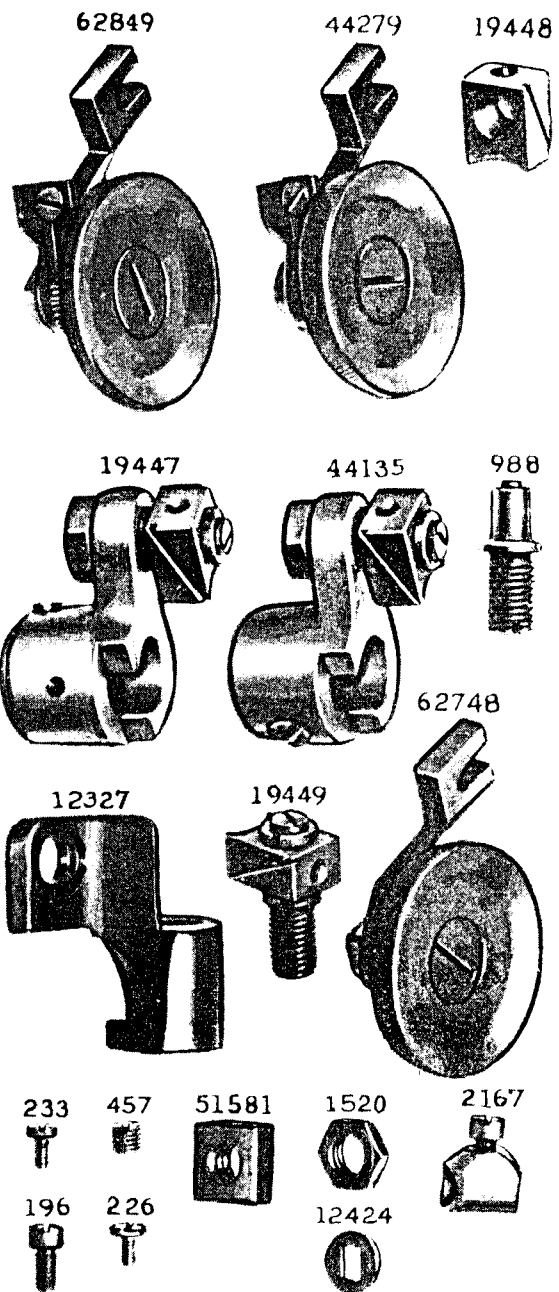

PLATE 8396—FULL SIZE

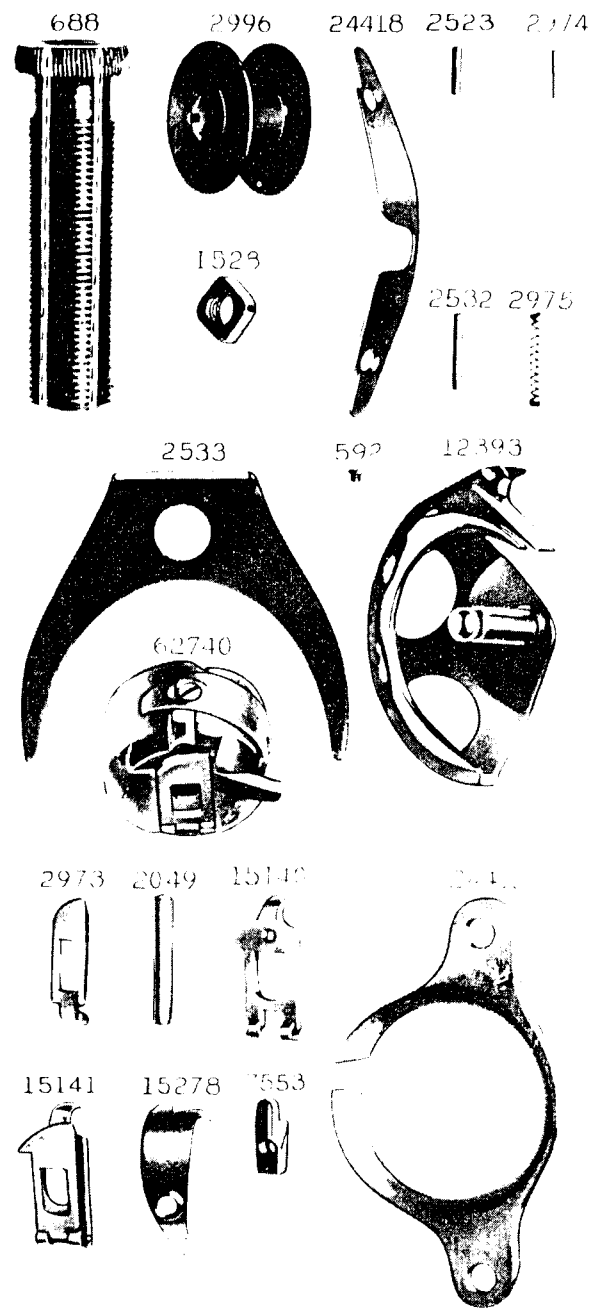

PLATE 8398—FULL SIZE

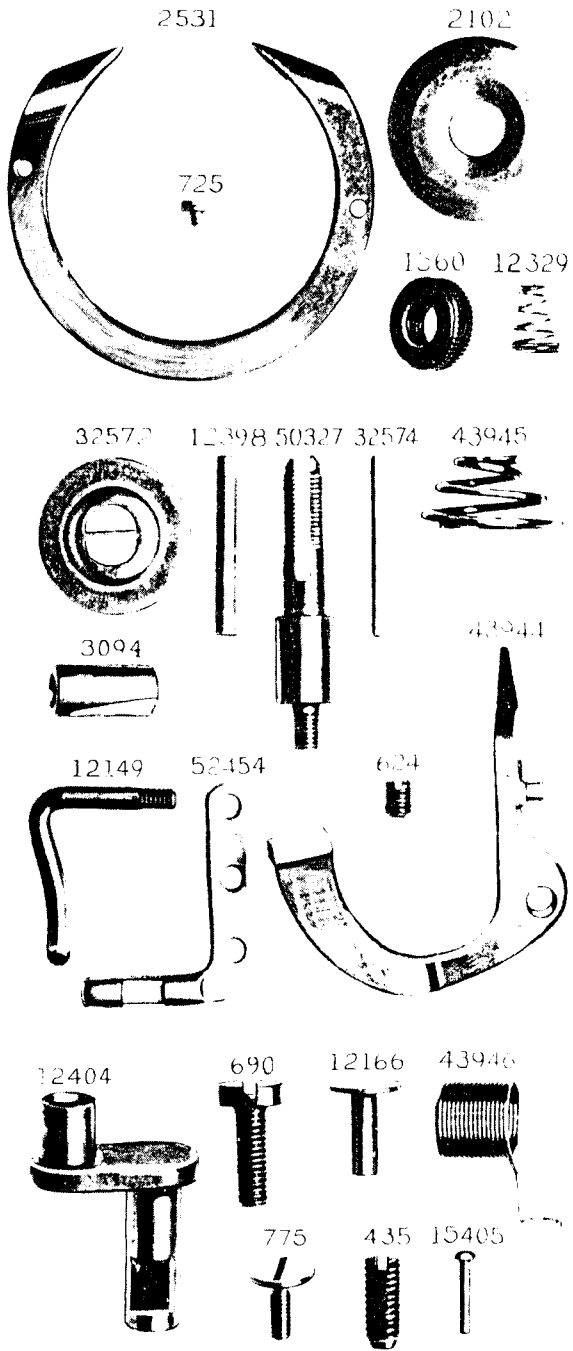

PLATE 8399—FULL SIZE

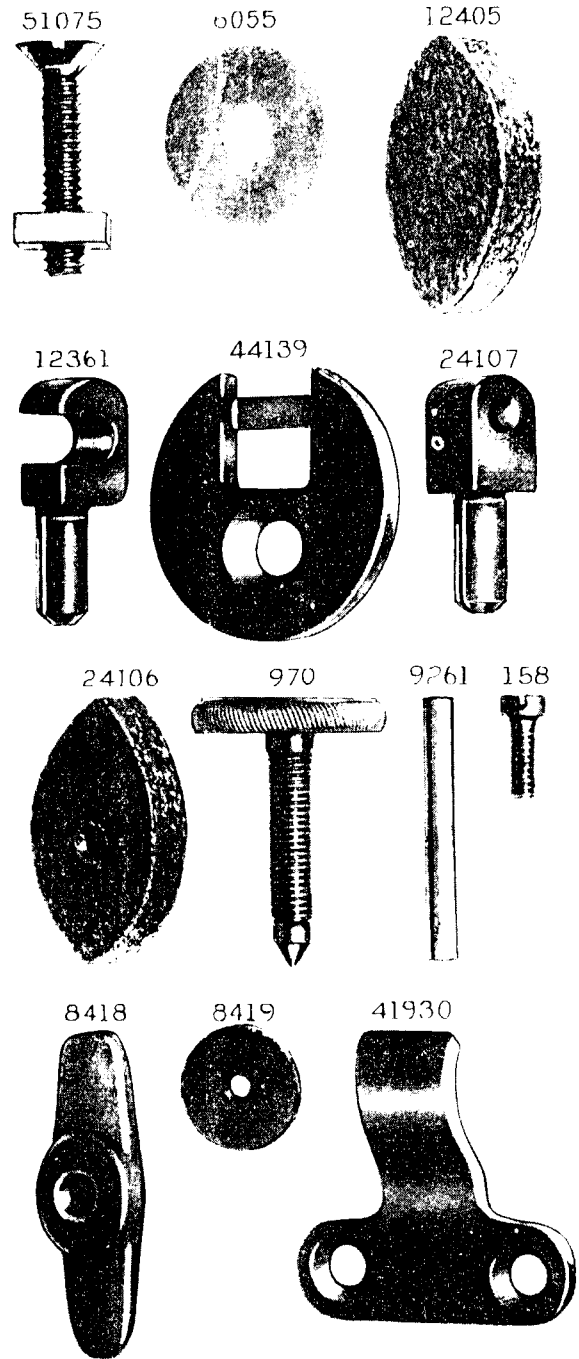

PLATE 8400—ONE-HALF SIZE

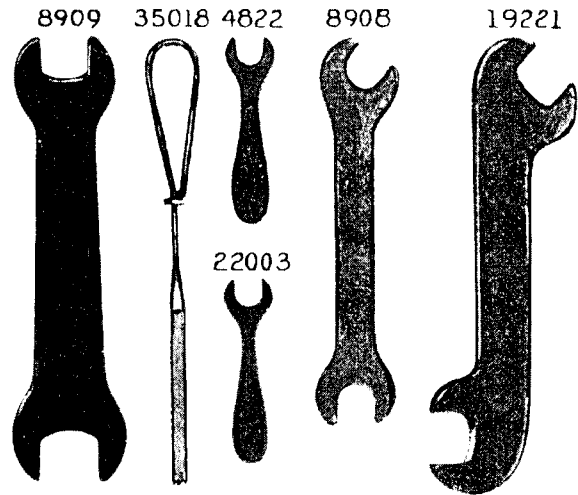
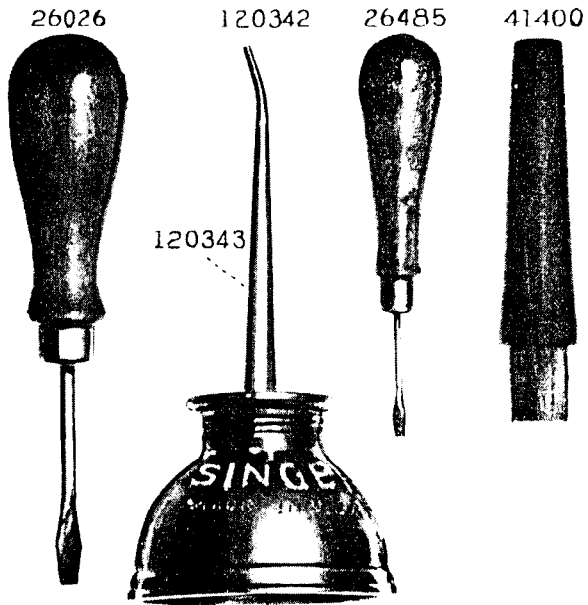

PLATE 8401—FULL SIZE

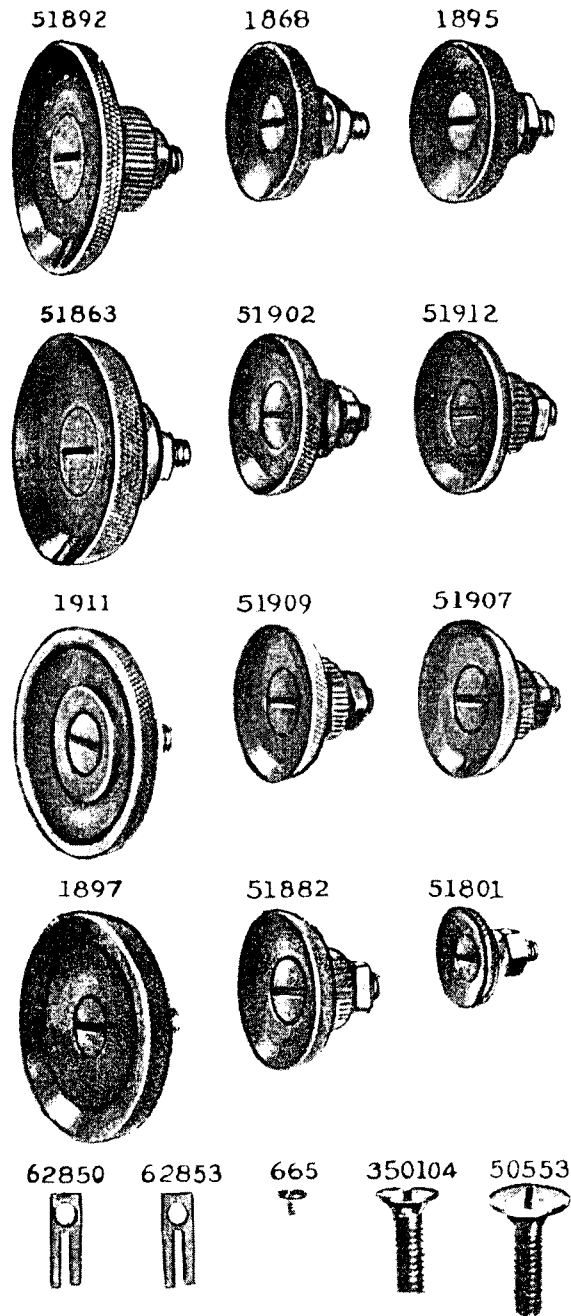

PLATE 8402—FULL SIZE

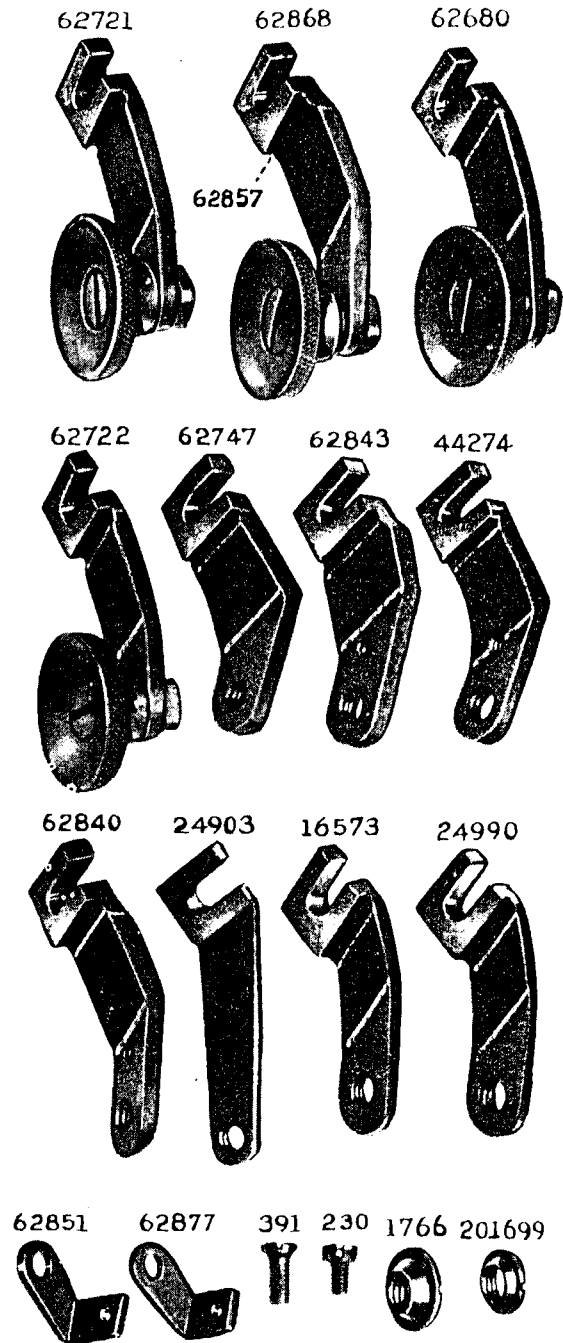

PLATE 8403—FULL SIZE

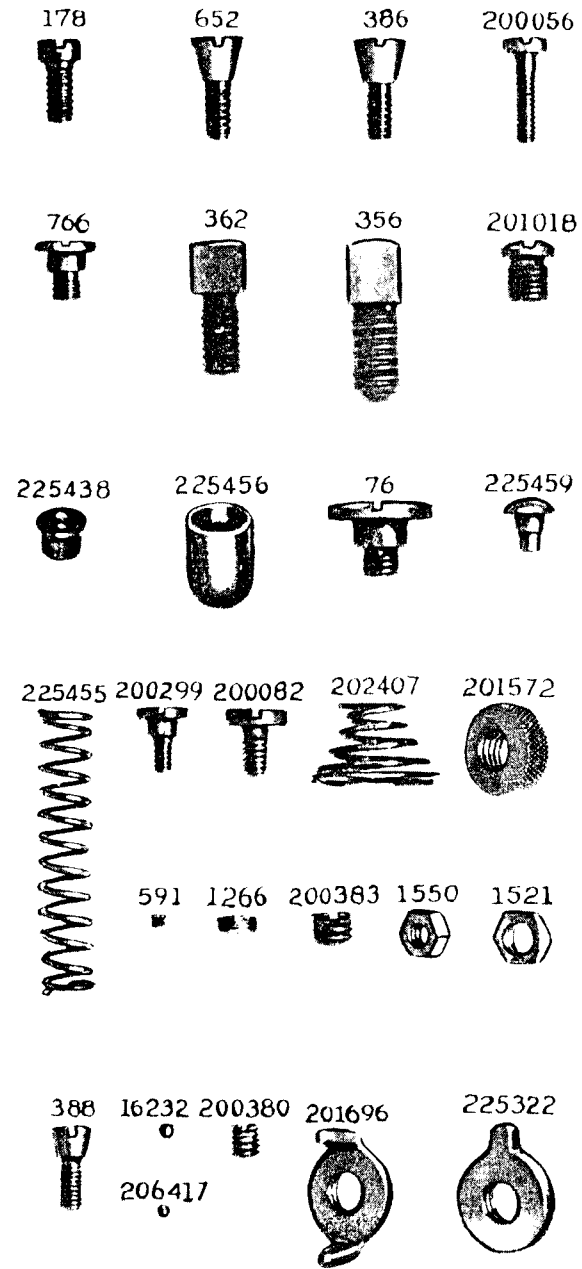

PLATE 8405 ONE-FOURTH SIZE

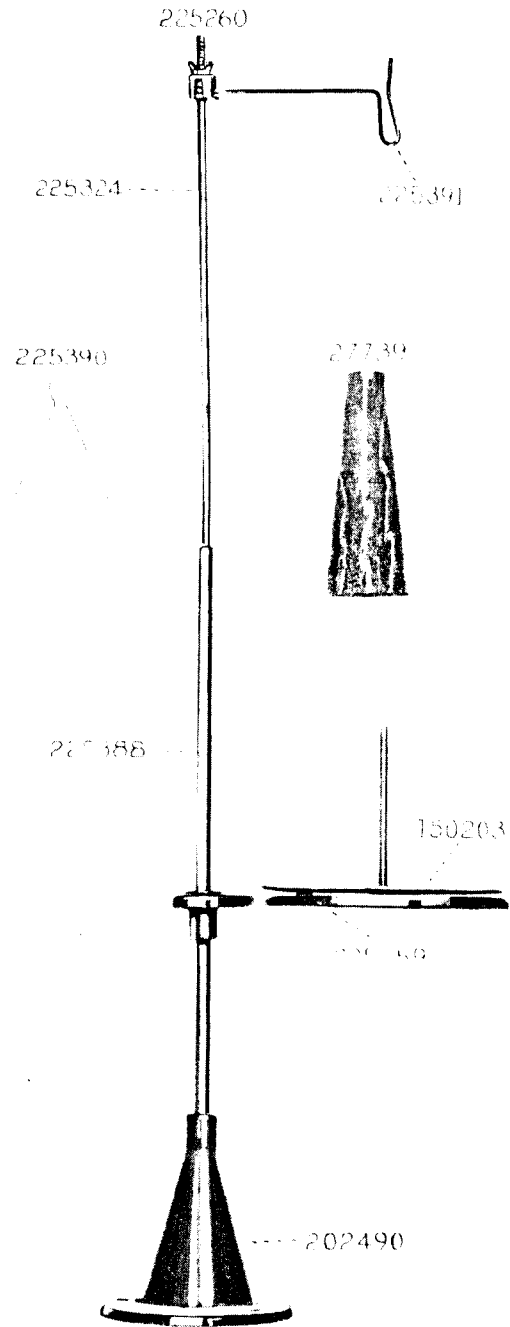

PLATE 8406 ONE-FOURTH SIZE

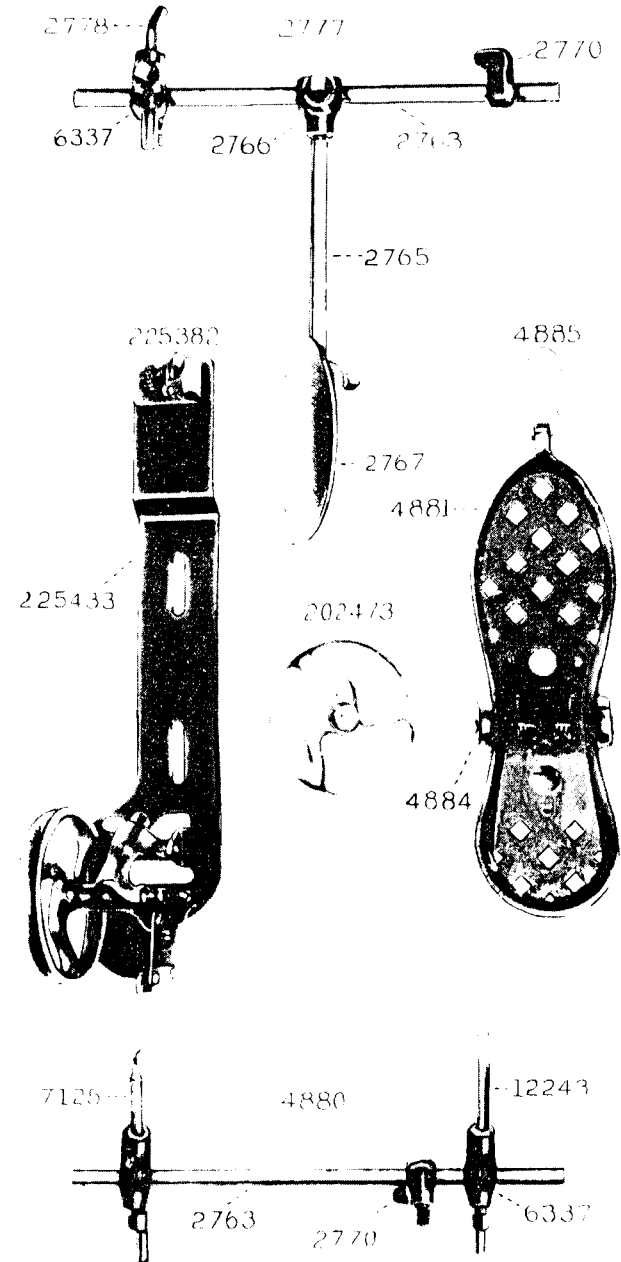
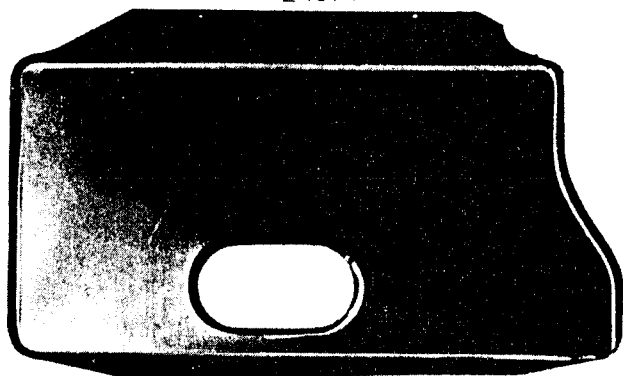

PLATE 8407—ONE-FOURTH SIZE

24079



24908

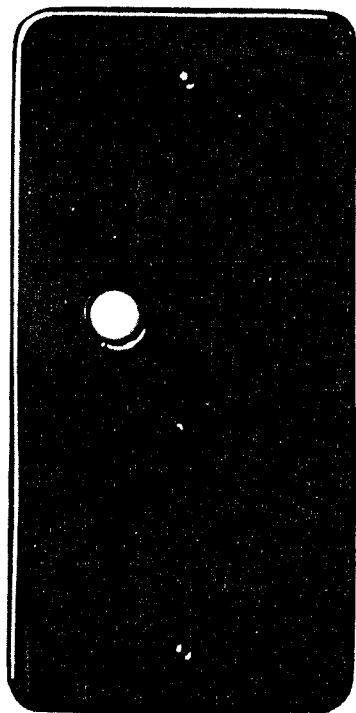
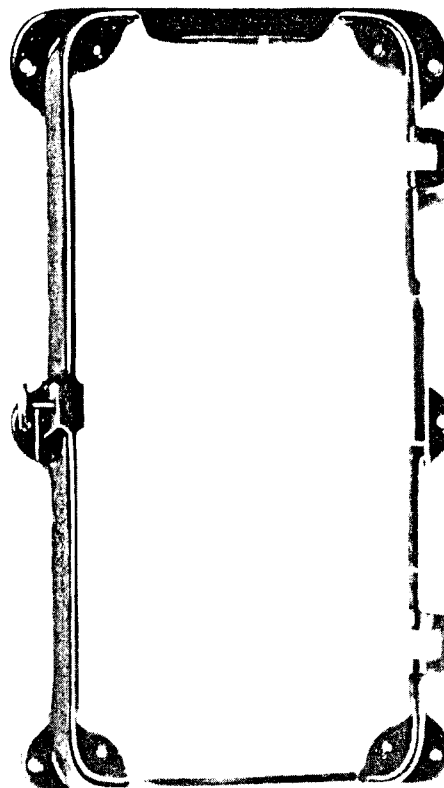

PLATE 8408—ONE-FOURTH SIZE

24108



41929

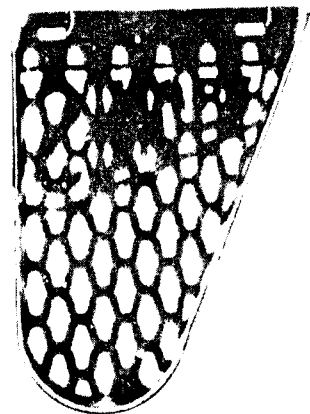

PLATE 8409-FULL SIZE

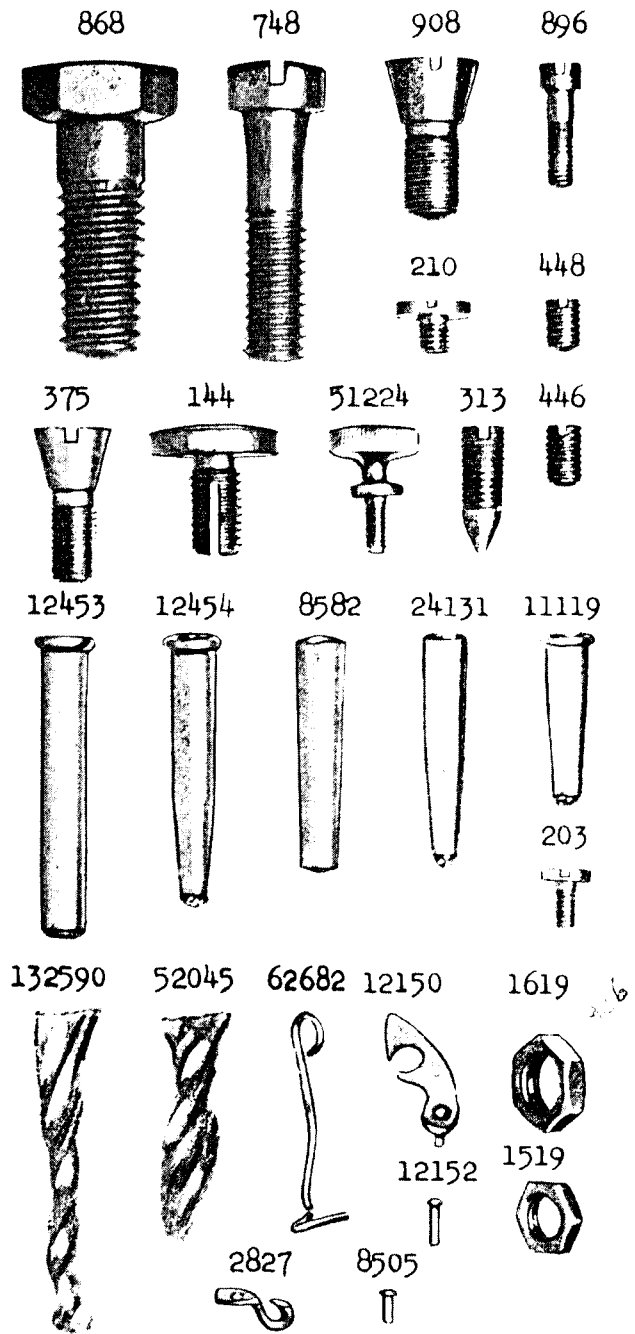

PLATE 8410-ONE-HALF SIZE

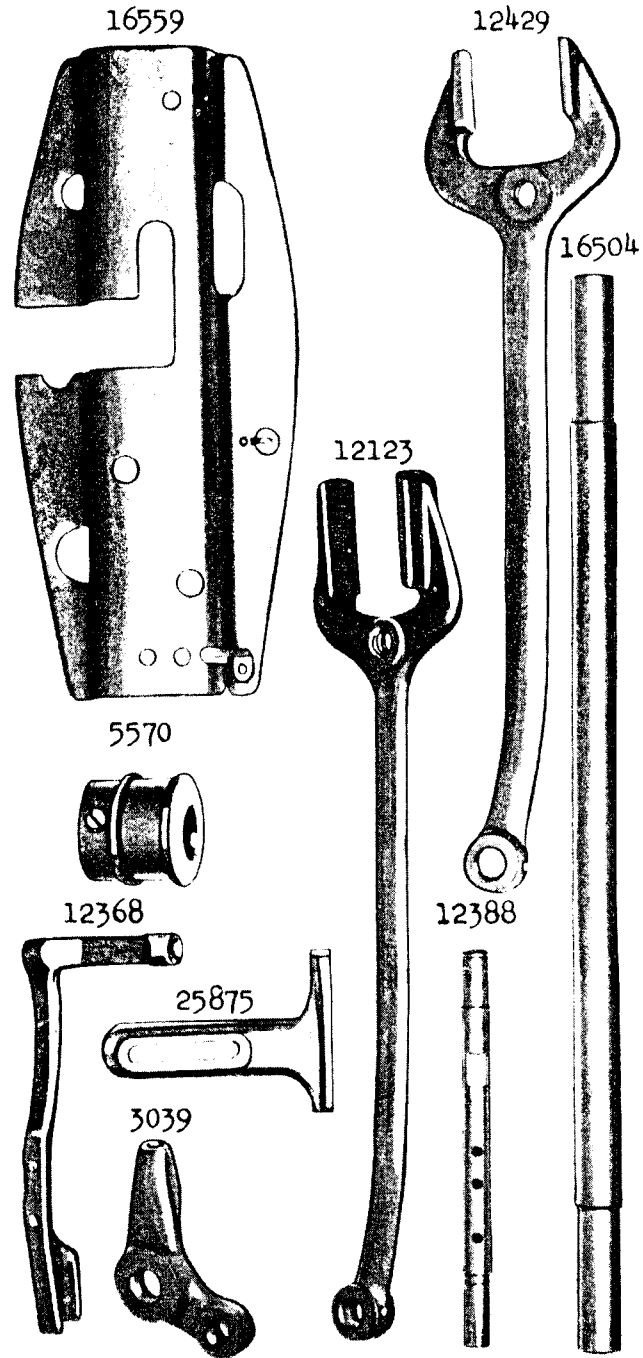
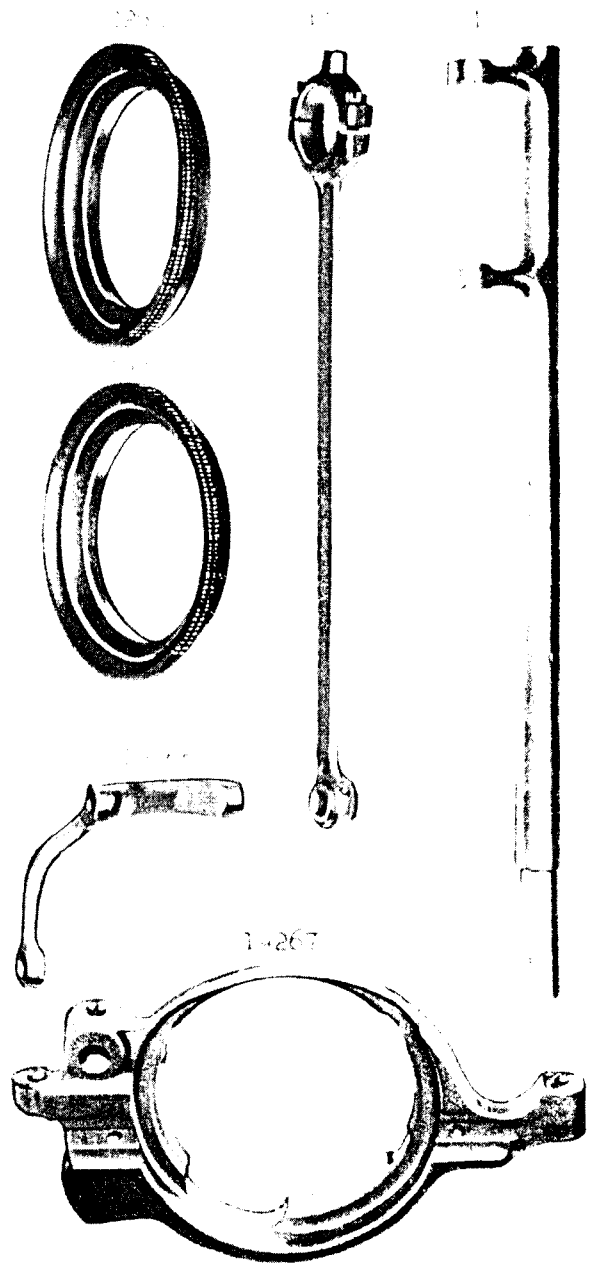

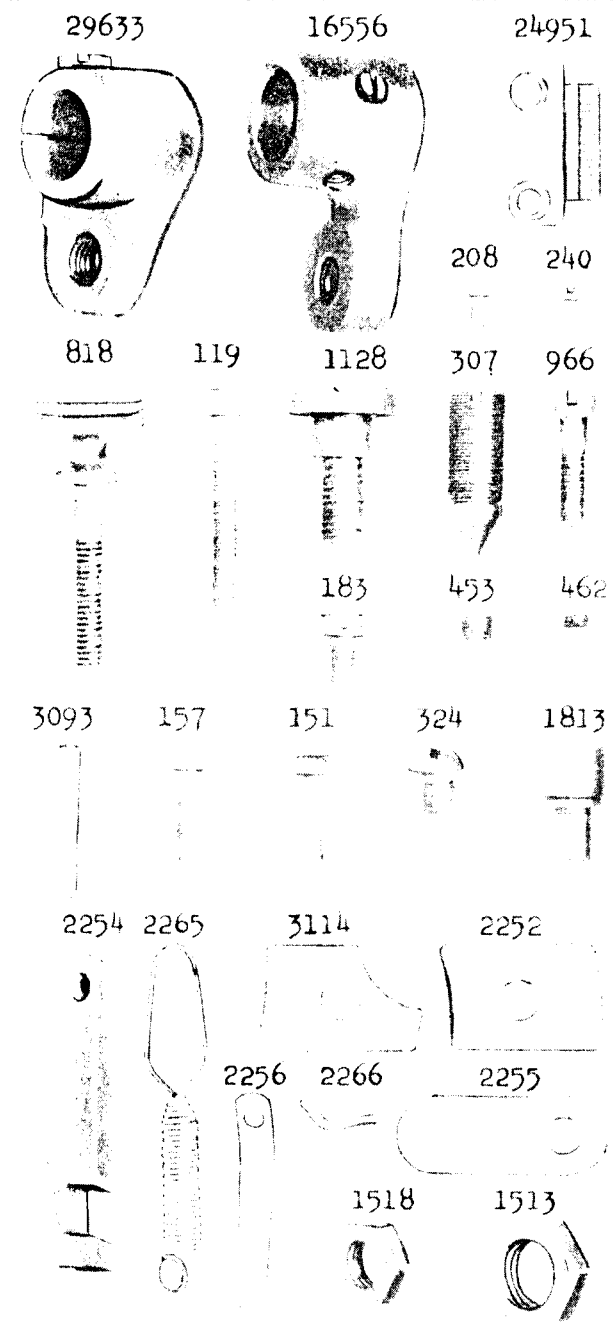

PLATE 8411-ONE-HALF SIZE



1-267

PLATE 8412-FULL SIZE



29633

16556

24951

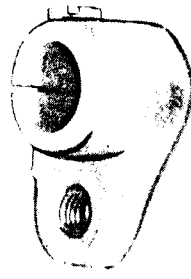

818

119

1128

208

240

307

966

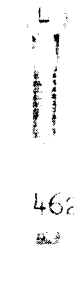
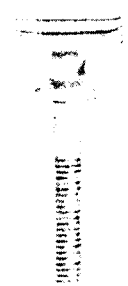

183

453

462

3093

157

151

324

1813

2254

2265

3114

2252

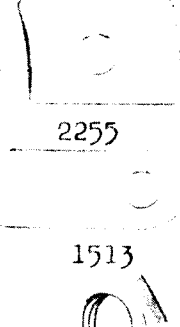
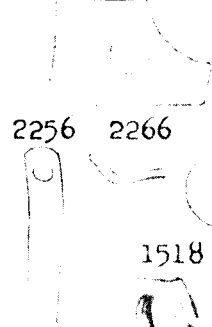
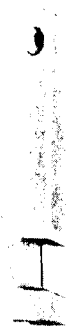

2256

2266

2255

1518

1513



PLATE 8413-ONE-HALF SIZE

19268 19297 24431

16563

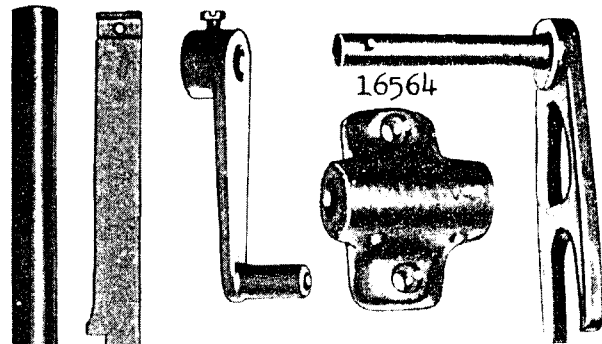

16568 19265 16569

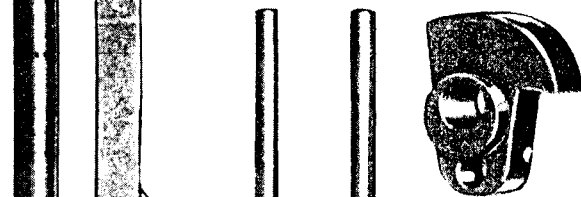

44225

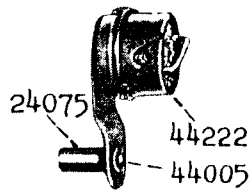

24104

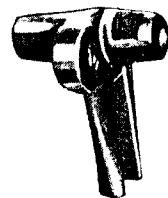

44006



44224



PLATE 8414-FULL SIZE

24122 24123 1162 24124 2022

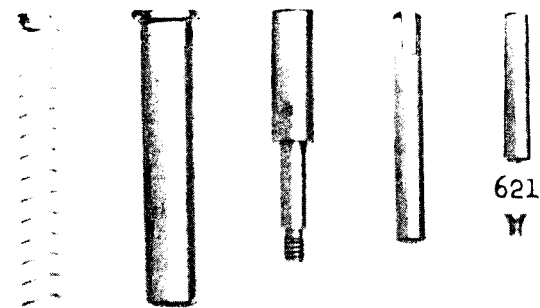

442 191 223 335



743 647 794 14026 2301 24143



24372

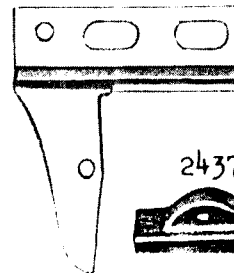

16567

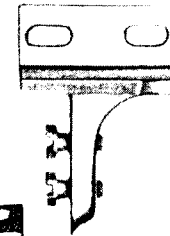

24142



24371



24125 24391

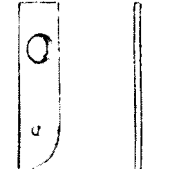

4784



878



12459



620



904



PLATE 8415-FULL SIZE

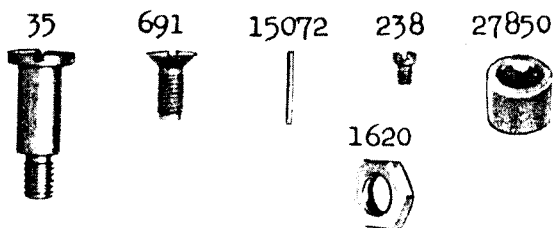
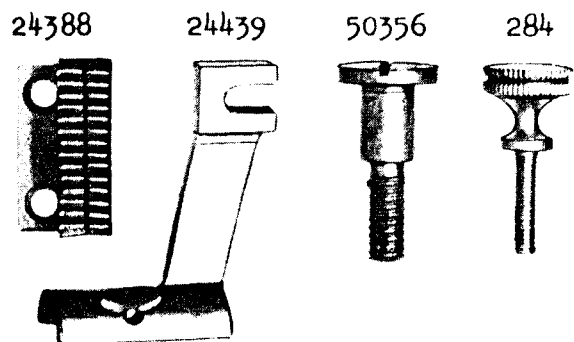
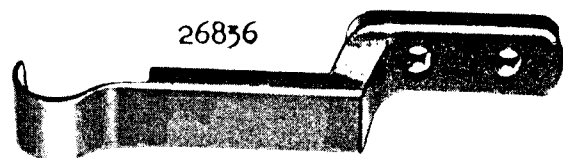
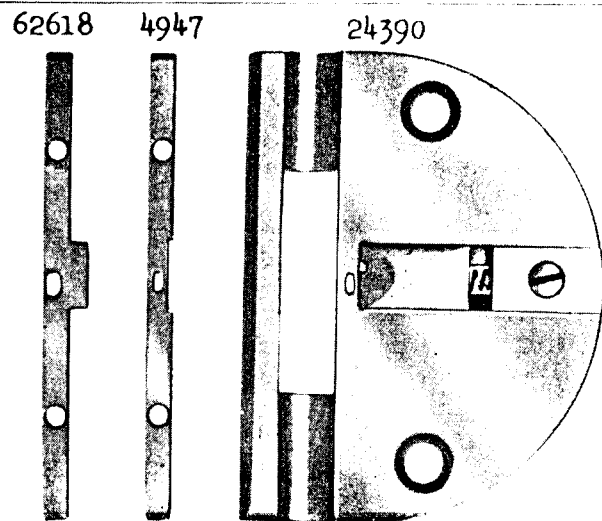

PLATE 8416-FULL SIZE

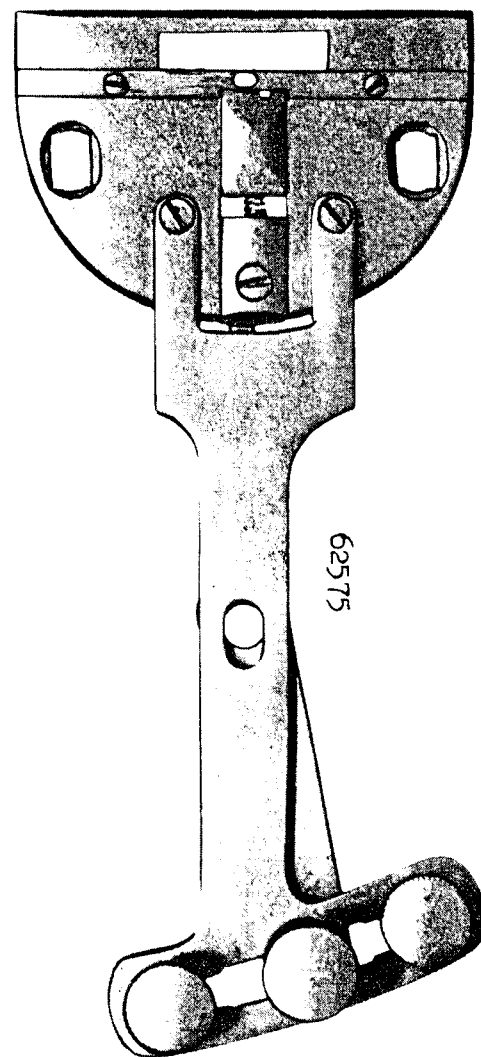

PLATE 8417-ONE-HALF SIZE

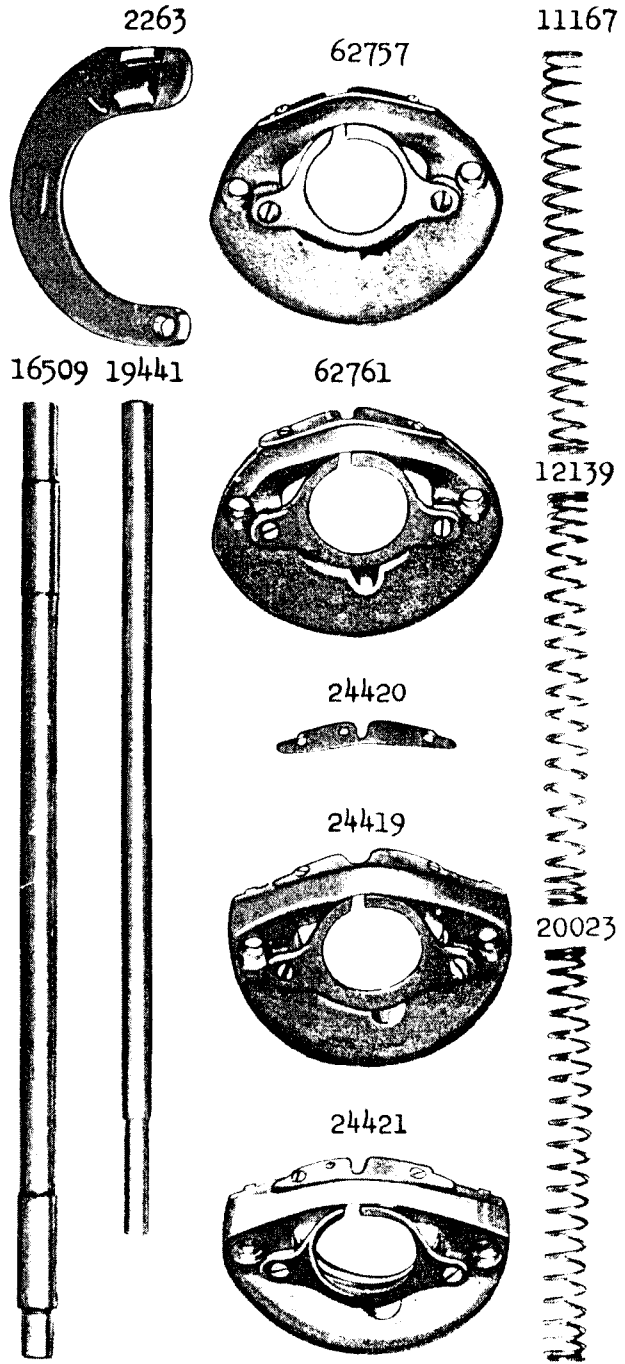

PLATE 8418-FULL SIZE

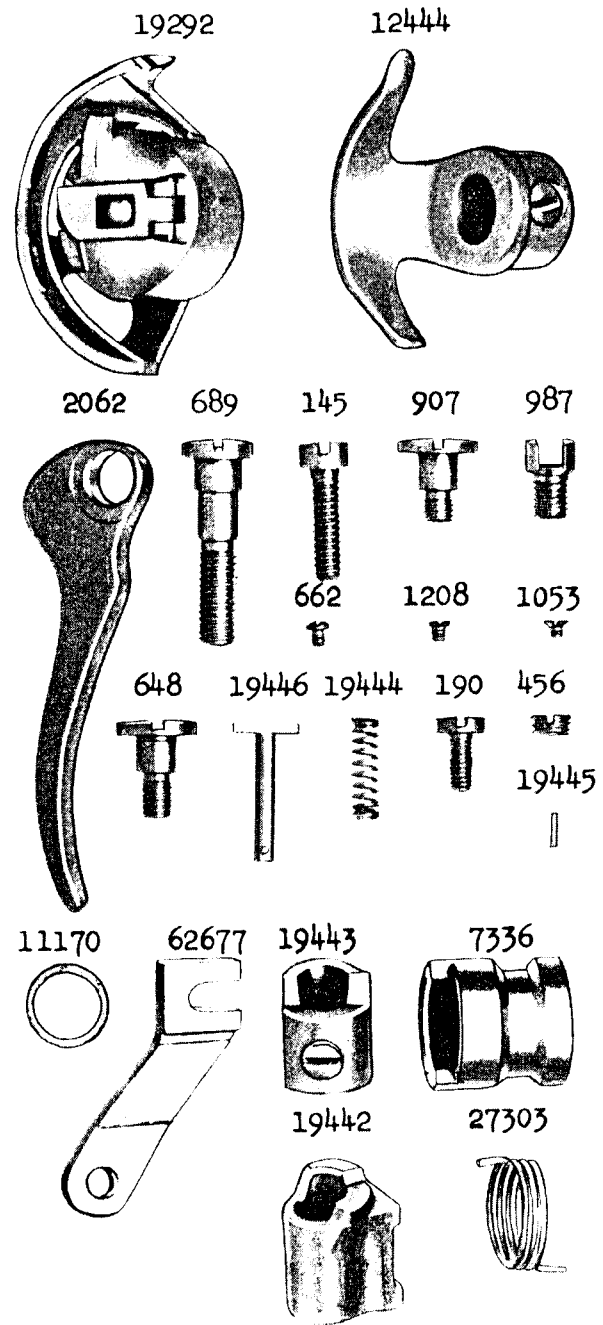

PLATE 8419-FULL SIZE

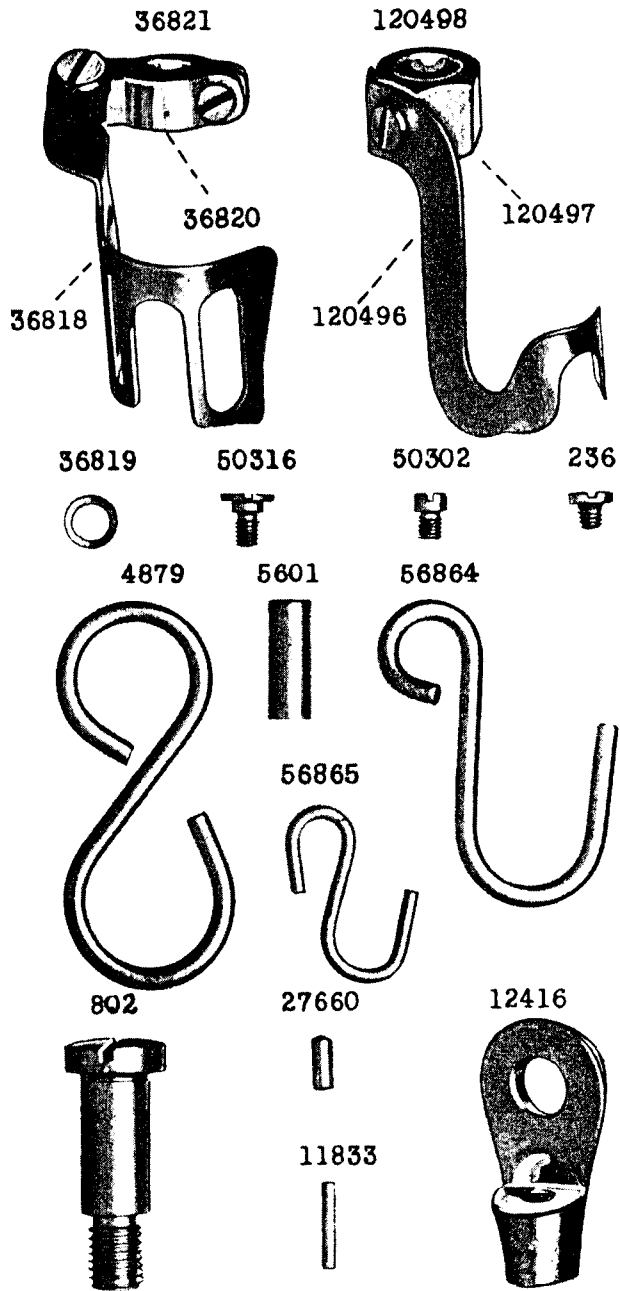

PLATE 8420-FULL SIZE

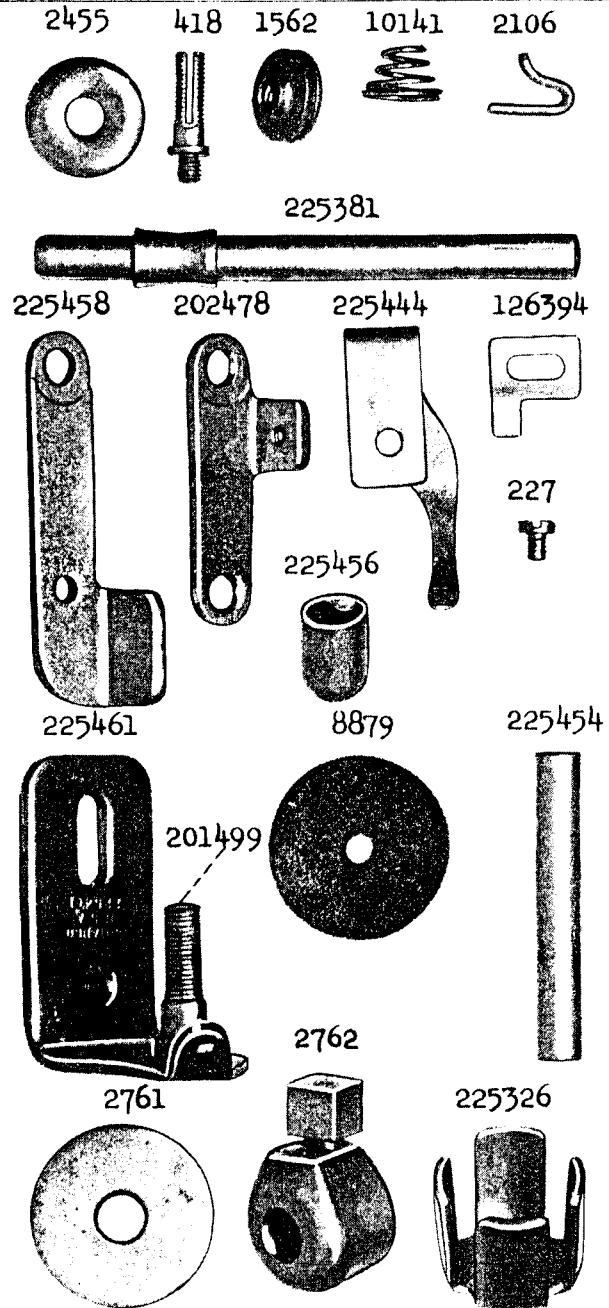

PLATE 8421-ONE-HALF SIZE

16585



12415



12365



12496

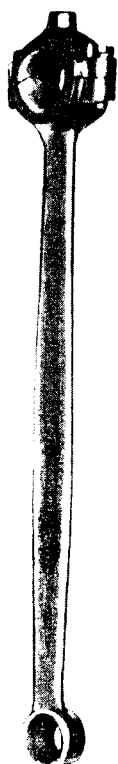

12242

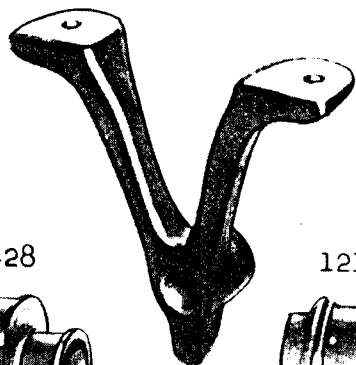

12428

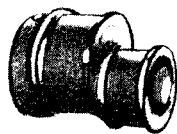

12197

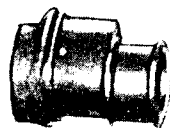
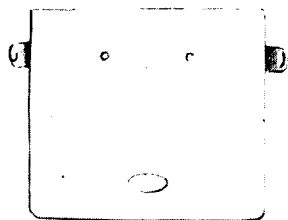
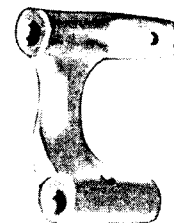

PLATE 8422-ONE-HALF SIZE

12432



225453



4307



27552

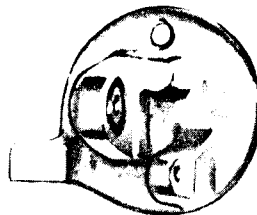

27553

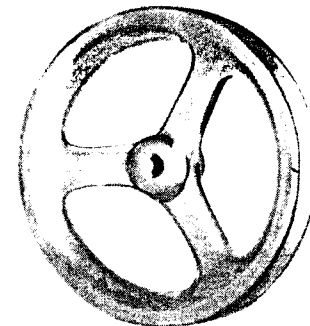

27647

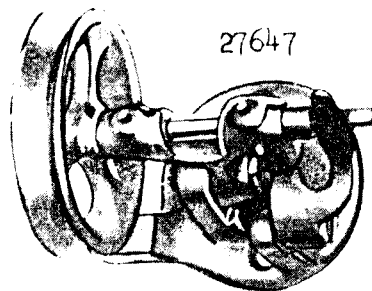
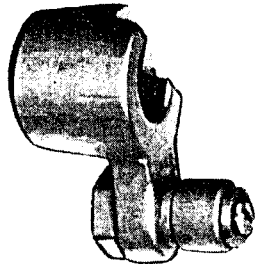

PLATE 8425-FULL SIZE

12390



1902



16508

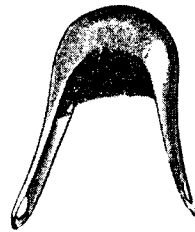

16571

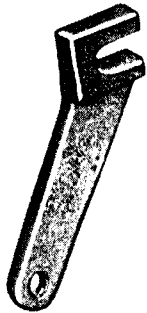

16574

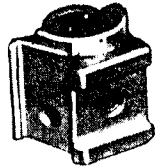

16575



16576



1907



460



19293

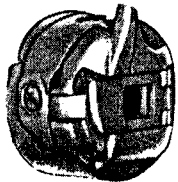

24074

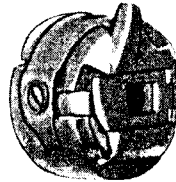

12402



430



2972



15003



52378



2526



15098



210958



210993



12401



12400



52398



PLATE 8426-ONE-QUARTER SIZE

19300

