

FINEST QUALITY

Union Special[®]

LEWIS • COLUMBIA

**INDUSTRIAL
SEWING
MACHINES**

**STYLE
39500 MA**

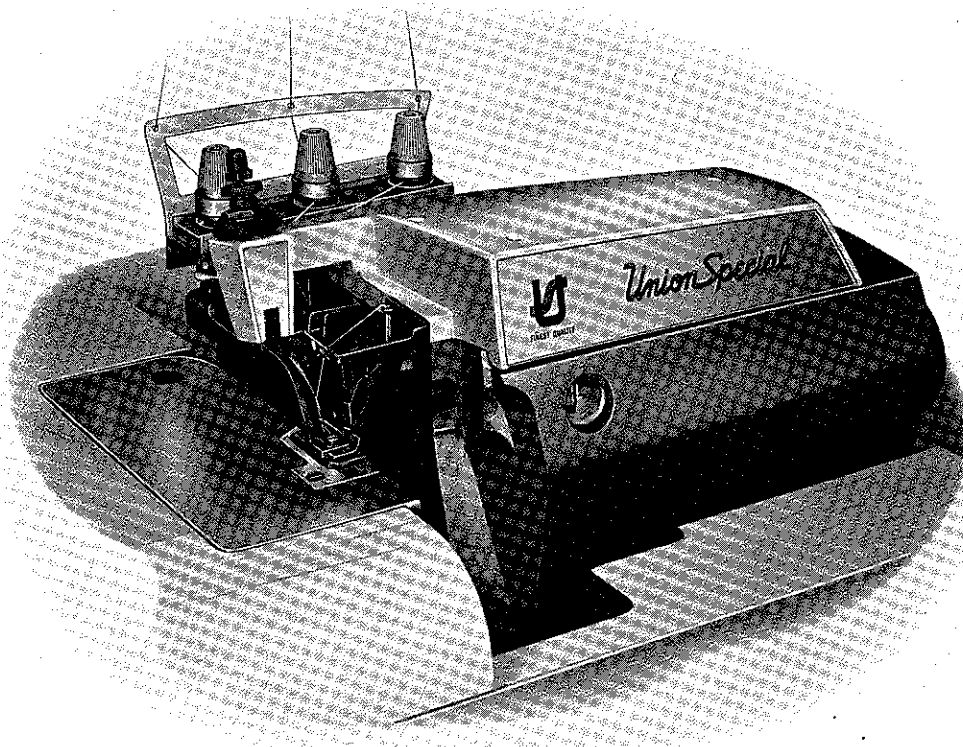

CLASS 39500

**CATALOG
No.
103 MA**

**HI-STYLED HIGH SPEED
SINGLE NEEDLE DIFFERENTIAL FEED
TOE CLOSING MACHINES**

Union Special **MACHINE COMPANY**

CHICAGO

Catalog No. 103 MA
(Supplement to Catalog No. 103 FA)

INSTRUCTIONS
FOR
ADJUSTING AND OPERATING
LIST OF PARTS

CLASS 39500

Style
39500 MA

First Edition

Copyright 1969
By
Union Special Machine Co.
Rights Reserved in All Countries

Union Special
MACHINE COMPANY
INDUSTRIAL SEWING MACHINES
CHICAGO

Printed in U. S. A.

April, 1969

IDENTIFICATION OF MACHINE

Each Union Special machine is identified by a Style number on a name plate on the machine. Style numbers are classified as standard and special. Standard Style numbers have one or more letters suffixed, but never contain the letter "Z". Example: "Style 39500 MA". Special Style numbers contain the letter "Z". When only minor changes are made in a standard machine, a "Z" is suffixed to the standard Style number. Example: "Style 39500 MAZ".

Styles of machines similar in construction are grouped under a Class number, which differs from the Style number in that it contains no letters. Example: "Class 39500".

APPLICATION OF CATALOG

This catalog is a supplement to Catalog No. 103 FA and should be used in conjunction therewith. Only those parts which are used on Style 39500 MA, and not on Style 39500 GS are illustrated and listed at the back of the book.

This catalog applies specifically to the standard Style of machine as listed herein. It can also be applied with discretion to some Special Styles of machines in Class 39500. References to directions, such as right and left, front and back, etc., are taken from the operator's position while seated at the machine. Operating direction of handwheel is away from operator.

STYLES OF MACHINES

Hi-Styled High Speed, Single Curved Blade Needle, Two Looper, Three Thread, Overseaming machine. Differential Feed, Trimming Mechanism with spring pressed Lower Knife, Automatic Lubricating System.

39500 MA Light duty machine, for toe closing on women's seamless hosiery. Seam specification 505-EFe-1 inverted. Standard seam width 1/16 to 3/32 inch depending on material. Stitch range 15-100 per inch. Cam adjusted main and differential feeds. Maximum recommended speed 7000 R. P. M.

OILING

CAUTION! Oil was drained from machine when shipped, so reservoir must be filled before beginning to operate. Oil capacity of Class 39500 is six ounces. A straight mineral oil of a Saybolt viscosity of 200 to 250 seconds at 100° Fahrenheit should be used.

Machine is filled with oil at spring cap in top cover. Oil level is checked at sight gauge on front of machine. Red bulb on oil level indicator should show between gauge lines when machine is stationary.

Machine is automatically lubricated. No oiling is necessary, other than keeping main reservoir filled. Check oil daily before the morning start; add oil as required.

The oil drain plug screw is located at back of machine near bottom edge of base. It is a magnetic screw designed to accumulate possible foreign materials which may have entered the crank case. It should be removed and cleaned periodically.

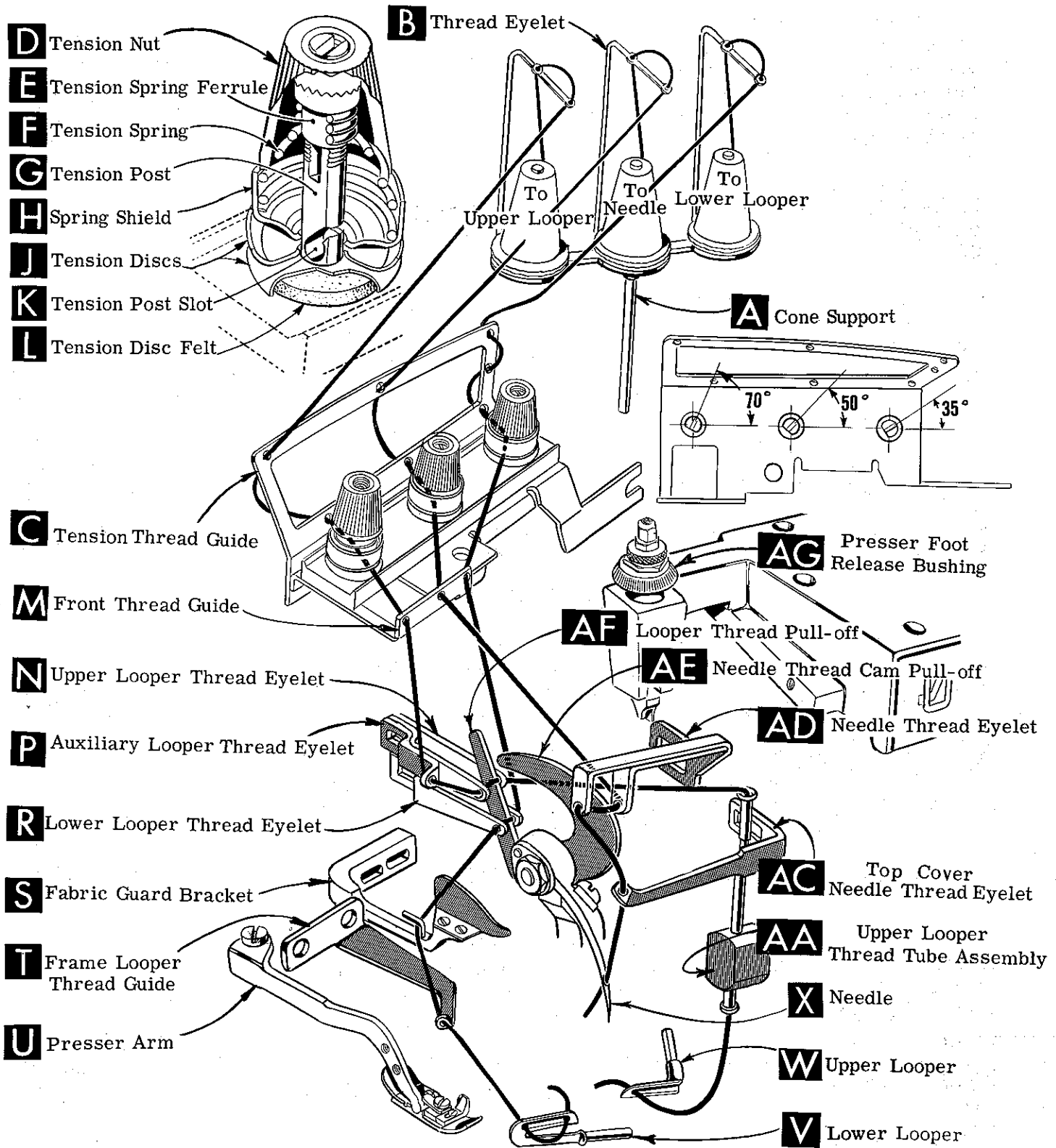

Fig. 1

NEEDLES

Each Union Special needle has both a type number and a size number. The type number denotes the kind of shank, point, length, groove, finish and other details. The size number, stamped on the needle shank, denotes largest diameter of blade, measured in thousandths of an inch midway between shank and eye. Collectively, type number and size number represent the complete symbol which is given on the label of all needles packaged and sold by Union Special.

This machine uses a curved blade needle. Standard needle for Style 39500 MA is Type 154 GAS. It is standard length, single grooved, struck groove, spotted and chromium plated, available in sizes 022, 025, 027, 029, 032, 036, 040, 044, 049 and 054.

To have needle orders promptly and accurately filled, an empty package, a sample needle, or type and size number should be forwarded. Use description on label. A complete order would read: "1000 Needles Type 154 GAS, Size 027".

Selection of proper needle size is determined by the size of thread used. Thread should pass freely through needle eye in order to produce a good stitch formation.

Success in the operation of Union Special machines can be secured only by use of needles packaged under our brand name *Union Special* which is backed by a reputation for producing highest quality needles in materials and workmanship for more than three-quarters of a century.

CHANGING NEEDLES

Release pressure on presser foot by turning presser foot release bushing (AG, Fig. 1) and swing presser arm (U) out of position. Turn handwheel in operating direction until needle is at its lowest point of travel. Using hexagonal socket wrench No. 21388 AU, furnished with machine, loosen needle clamp nut about 1/4 turn. Again turn handwheel until needle is at high position and withdraw needle.

To replace needle, leave needle holder at high position and, with the flat to the left, insert needle in holder until it rests against stop pin. Keeping needle in this position, turn handwheel until holder is again at its low point of travel, then tighten nut. Return presser arm (U) to position and re-lock presser foot release bushing (AG).

THREAD STAND

After thread comes from cones on cone support (A, Fig. 1) it is brought up through the back hole of thread eyelet (B), then down through the front hole of thread eyelet. Next it is threaded through the upper hole of tension thread guide (C) from front to back and then through the lower hole from back to front.

NOTE: The lower looper thread is threaded through the tension thread guide (C), first through the upper hole from back to front, second through the middle hole from front to back, and third through the lower hole back to front.

All threads then continue between the tension discs (J), through tension post slot (K) in tension post (G) and on through front thread guide (M).

THREADING

Only parts involved in threading are shown in threading diagram (Fig. 1). Parts are placed in their relative positions for clarity.

It will simplify threading Style 39500 MA to follow recommended sequence of threading lower looper first, upper looper second, and needle third.

Before beginning to thread, swing cloth plate open, turn handwheel in operating direction until needle (X) is at high position. Release pressure on presser foot by turning presser foot release bushing (AG), and swing presser arm (U) out of position.

Be sure the threads, as they come from the tension thread guide (C) are between tension discs (J) and in tension post slot (K) in tension post (G). The tension posts should be positioned so the tension post slot will be at the approximate angle for the different threads as indicated in Fig. 1.

TO THREAD LOWER LOOPER

Thread lower looper thread through right eyelet of front thread guide (M). Then double end of thread and lead it through both eyes of lower looper thread eyelet (R, Fig. 1) from right to left. Note: thread must pass in front of looper thread pull-off (AF). Lead thread behind fabric guard (S) and through eyelet hole of frame looper thread guide (T). Turn handwheel in operating direction until heel of lower looper (V) is all the way to the left; then thread through both eyes from left to right. Left eye of lower looper can be threaded easily if tweezers are in left hand.

TO THREAD UPPER LOOPER

Thread upper looper thread through left eyelet of front thread guide (M, Fig. 1). Turn handwheel until point of upper looper (W) is all the way left. Lead thread through auxiliary looper thread eyelet (P) from back to front, then through both eyes of upper looper thread eyelet (N) from left to right. NOTE: Thread must pass in front of looper thread pull-off (AF). After pulling up upper looper thread tube assembly (AA), lead the thread under neck of top cover casting and down through thread tube assembly (AA). Pull thread out bottom of tube, push tube down, and then insert thread through upper looper eye from front to back.

CAUTION! Be sure upper looper thread is under the needle thread when passing from tube assembly to upper looper eye.

TO THREAD THE NEEDLE

Thread needle thread through middle eyelet of front thread guide (M). Then turn handwheel in operating direction until needle (X, Fig. 1) is at its highest position. Insert needle thread from right to left, through both eyes of needle thread eyelet (AD), under neck of top cover casting; then down through hole in top cover needle thread eyelet (AC). Thread needle from front.

THREAD TENSION

The amount of tension on needle and looper threads is regulated by the tension nuts (D, Fig. 1). Tension on threads should be only enough to secure proper stitch formation.

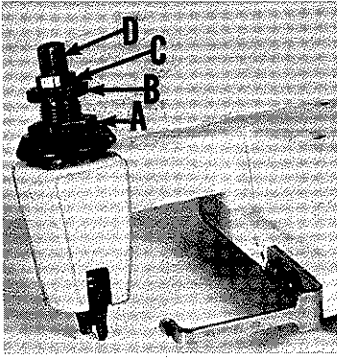

Fig. 2

PRESSER FOOT PRESSURE

Sufficient presser foot pressure to feed work uniformly should be maintained. Should it be necessary to increase or decrease amount of pressure on presser foot, loosen lock nut (A, Fig. 2) and turn adjusting screw (B). Adjusting screw has a right hand thread so tightening increases pressure, loosening decreases pressure. When pressure adjusting screw (B) has been properly set, tighten lock nut (A). With presser foot resting on throat plate, position

locking nut (C) so that its under surface is approximately 1/32 inch to 1/16 inch from the top surface of adjusting screw (B). Set cap (D) against locking nut (C).

FEED ECCENTRICS

Feed eccentrics used in Style 39500 MA machines have been selected to produce approximately 30 stitches per inch. It will be noted that the part number of main feed eccentric is No. 39540 B-30 and that of differential feed eccentric is also No. 39540 B-30. Minor numbers of the part symbol indicate approximately the number of stitches obtainable when using that eccentric. Unless otherwise specified, machine will be shipped with above combination of eccentrics.

Generally speaking, differential (right hand) feed eccentric determines number of stitches produced; main (left hand) feed eccentric is selected in relation to degree and direction of stretch of material being sewn, or type of operation.

Following stitch number feed eccentrics are available under No. 39540 B-4, -5, -6, -7, -8, -9, -10, -11, -12, -13, -14, -15, -16, -18, -20, -22, -24, -26, -28, -30, -32, -34, -36, -40, -50, -60, -70, -100. Only two eccentrics are supplied with each machine. Additional eccentrics may be ordered separately. To order an eccentric, use No. 39540 B with a minor number suffixed to indicate number of stitches desired. Example: "39540 B-30".

ASSEMBLING AND ADJUSTING SEWING PARTS

Before assembling and adjusting sewing parts, remove cloth plate, fabric guard, chip guard, upper knife assembly, lower knife holder assembly, then follow this suggested sequence:

SETTING THE NEEDLE

With throat plate assembled in position, needle should center in the front end of needle slot. When needle is at high position, needle point should be set 1/2 inch above throat plate (A, Fig. 3). To align needle or set the height above the throat plate, move needle driving arm (B, Fig. 3) by loosening clamp screw (C). After needle has been properly set tighten clamp screw (C) and remove throat plate.

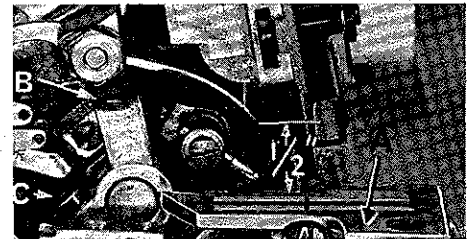

Fig. 3

SETTING THE NEEDLE (Continued)

If needle thread cam pull-off (A, Fig. 4) overlaps looper thread pull-off (B), separate by moving looper thread pull-off back. When re-tightening looper pull-off screw, be sure to take up end play in needle driving arm.

At this point, insert lower looper (A, Fig. 5) into bar (B). With lower looper at left end of its stroke, set looper point $\frac{1}{8}$ inch from center of needle (Fig. 5), using looper gauge No. 21225- $\frac{1}{8}$. Do not have lower looper deflecting needle. Tighten nut (C).

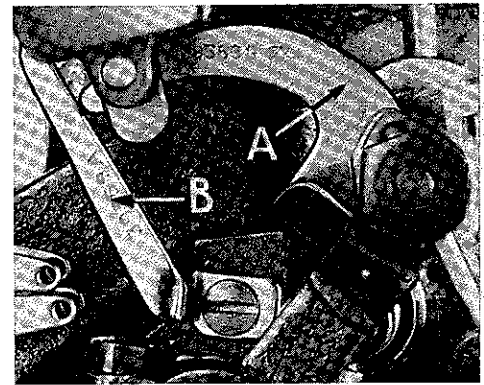

Fig. 4

Now assemble differential (front) feed dog.

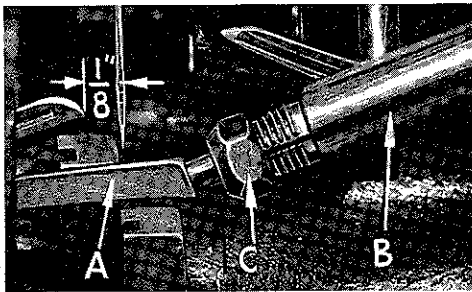

Fig. 5

SETTING THE REAR NEEDLE GUARD

Set rear needle guard (A, Fig. 6) as high as possible, without interfering with either lower looper or movement of lower knife holder, but still in position to deflect needle forward .002-.004 inch. Screw (B) is used to set rear needle guard. Make sure there is no interference between rear needle guard and lower looper.

SETTING THE LOWER LOOPER

Now finish lower looper adjustment. As lower looper moves to the right, its point should be set into the needle scarf (A, Fig. 7) until the needle springs forward from rear guard surface another .002-.004 inch.

SETTING THE FRONT NEEDLE GUARD

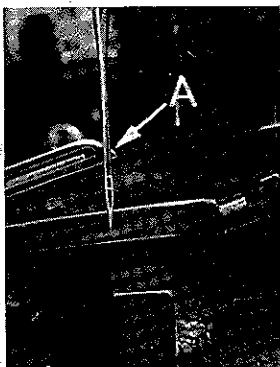

Fig. 7

Assemble front needle guard (C, Fig. 6). When lower looper is springing needle off rear needle guard, set front needle guard as close as possible to needle without touching. Screw (D) is used to adjust and set front needle guard. After this setting make sure there is no interference between needle guards and differential feed dog.

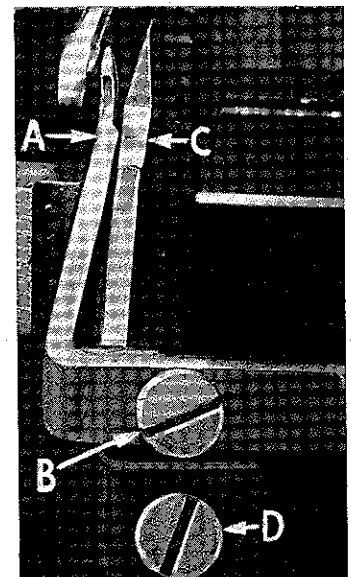

Fig. 6

SETTING THE UPPER LOOPER

Insert upper looper (A, Fig. 8) in its holder. Screw (B, Fig. 8) holds upper looper in its holder, and permits it to be pushed in or out or turned around its shank. Insert upper looper holder into upper looper shaft, if it is not already in place. Screw (C, Fig. 8) on clamp holds the upper looper holder in the shaft. Locate upper looper in its holder so that the shank extends $1/32$ to $1/16$ inch beyond holder (Fig. 8).

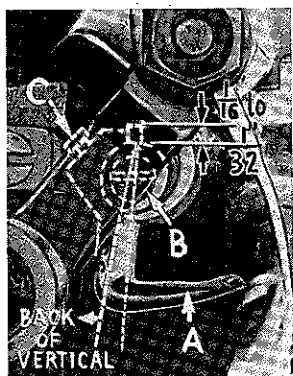

Fig. 8

When the upper looper is at the right end of its stroke, upper looper holder should be set to position upper looper shank back of vertical (Fig. 8).

Be sure, there is a clearance between heel of looper and casting. By adjusting looper holder in or out of upper looper shaft and by turning the looper around its shank, set upper looper point to cross lower looper to the left of the lower looper eye with 0.002 to 0.004 clearance (Fig. 9).

As the upper looper moves toward the top of its stroke, the heel of the upper looper should pass behind the lower looper head with $1/64$ to $1/32$ inch clearance.

Next, turn handwheel until looper is at the left end of its travel; check dimensions of upper looper point with respect to needle and throat plate (Fig. 10). If resetting is necessary, do it by moving the upper looper holder (A, Fig. 10).

For example, dimension $31/64$ inch is increased by turning upper looper holder counterclockwise looking from left end of machine; dimension $5/32$ inch is increased by pulling upper looper holder left, out of upper looper shaft. After these changes are made, it may be necessary to turn upper looper around its shank slightly to maintain the condition shown in Fig. 9.



Fig. 9

When the correct setting is obtained, it can be checked quickly as follows: As upper looper is moving to the right, when upper looper eye centers on the needle, bottom of the needle eye should be about level with top surface of upper looper (Fig. 11).

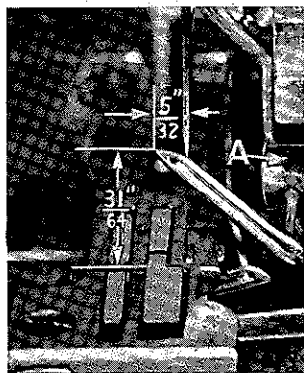

Fig. 10

Check setting to avoid interference between upper looper and needle on needle downstroke. If needle rubs the back of upper looper, pull looper out of its holder slightly and rotate looper a short distance counterclockwise, looking from left end of machine. Reset to maintain dimensions of Figs. 9, 10, 11.

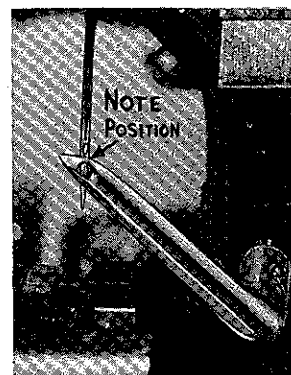

Fig. 11

SETTING THE FEED DOGS

Now assemble main (back) feed dog.

Set the feed dogs (A, B, Fig. 12) so the top surfaces of feed dogs all lay in the same plane. This can be checked by sighting across teeth with a straight edge. Now assemble throat plate. Feed dogs should now be leveled with throat plate surface by rotating feed tilting adjusting pin (D). This pin raises or lowers the back end of both feed bars at the same time.

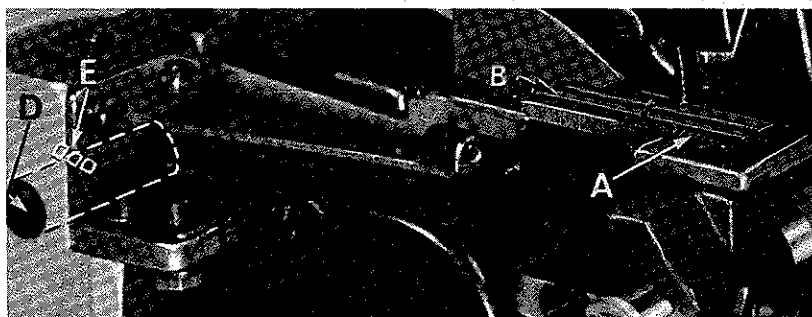

Fig. 12

The feed dogs should be set level at the time the top surfaces first appear above the throat plate. Screw (E) locks feed tilting adjusting pin in place. Now set the main and differential feed dogs so that the top surface of feed dog will rise about $3/64$ inch above throat plate.

SETTING THE LOWER KNIFE

Replace lower knife holder assembly. Lower knife (A, Fig. 13) should be set with cutting edge flush with throat plate surface. Adjustments are made with hexagonal head screw which holds lower knife. Lower knife is spring pressed against upper knife, so no lateral adjustment is necessary when width of trim is changed.

Lower knife may be secured in any position by tightening screw (B) and locking nut (C) against support bracket. Because screw (B) also serves as latch pin for the cloth plate latch spring, it should always be locked with nut (C) even when screw is not tightened against lower knife holder.

SETTING THE UPPER KNIFE

Replace upper knife assembly. Clamp upper knife (D, Fig. 13) in position, setting nut (E) to hold clamp (F) in its most clockwise position against upper knife. At bottom of its stroke, front cutting edge of upper knife should extend not less than $1/64$ inch below cutting edge of lower knife. The chain guard (D) should be set down against the upper knife and slightly back from the cutting edge.

After upper knife has been set for proper width of trim, screw (H) should be tightened to lock upper knife holding block (J) in place. This will simplify resetting when upper knife is replaced.

SETTING THE STITCH LENGTH

Length of stitch is determined by the combination of feed eccentrics used. Outer (left) eccentric (A, Fig. 14)

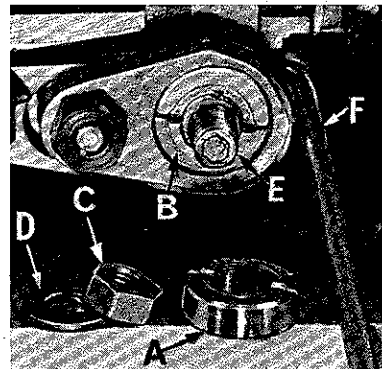

Fig. 14

SETTING THE STITCH LENGTH (Continued)

actuates main (rear) feed dog; while the inner (right) eccentric (B) actuates the differential (front) feed dog.

In assembling feed eccentrics, be sure hubs are facing each other. Be careful not to damage shaft or key. Tighten nut (C) securely.

To change feed eccentrics, remove nut (C) and washer (D) from end of shaft (E). Turn handwheel in operating direction until key slot in eccentric is toward the front. Using hooked eccentric extractor (F), supplied with machine, reach behind eccentrics as shown and withdraw

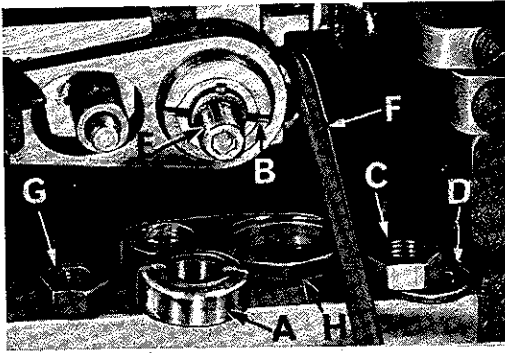

Fig. 15

eccentrics. It may be necessary to move handwheel back and forth slightly during extraction.

If eccentrics are unusually tight fitting, in addition to removing nut (C) and washer (D, Fig. 15) from shaft (E), it may be helpful to remove nut (D) and feed driving connection (H). Then continue as originally suggested.

SETTING THE PRESSER FOOT

Assemble the presser foot to presser arm. With needle in high position, swing presser arm into sewing position and set the presser foot to align needle holes (front and back) and flat on throat plate. The front edge of needle hole in presser foot must be aligned with front edge of needle hole in throat plate. It is also important that the bottom of the presser foot be flat on the throat plate. If necessary, presser foot can be realigned with throat plate slots by shifting the foot lifter lever shaft (H, Fig. 16). To move the shaft, loosen collar screws (B, Fig. 16) and clamp screw (G) and then shift the foot lifter lever shaft to the left or right as required. Retighten collar screws and clamp screw.

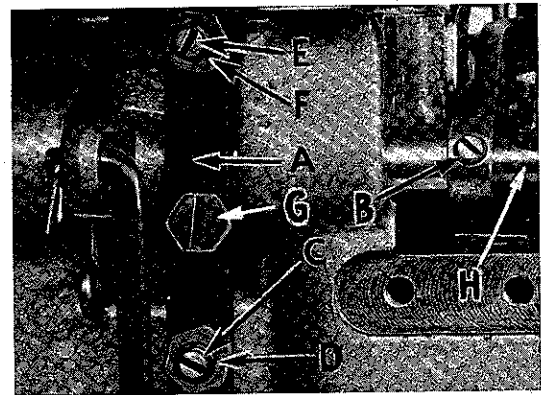

Fig. 16

The foot lifter lever arm (A, Fig. 16) and the collar (B) secure the shaft. Be sure the presser arm does not bind and rise when presser foot release bushing is unlocked.

Adjust lifter lever stop screw (C) so that presser foot can be raised no higher than upper looper will permit: then lock with nut (D). There should be from 1/16 to 1/8 inch free motion of foot lifter lever before the presser foot begins to rise. This adjustment should be made with screw (E) and locked with nut (F). Re-assemble the chip guard, fabric guard and cloth plate. To assemble chip guard, turn handwheel until upper knife assembly reaches its highest position.

STARTING TO OPERATE

Be sure machine is threaded according to threading diagram (Fig. 1).

With thread tensions light, set upper and lower looper thread eyelets (N and R) about horizontal and in the middle of their front to back locations.

STARTING TO OPERATE (Continued)

Operate machine slowly, without presser foot in place, to make sure that chain forms and moves off the tongue freely.

Swing presser foot into position, insert materials, and sew slowly.

NEEDLE THREAD CONTROL

While sewing on material, check needle thread control as follows: About 60% of needle thread required for the stitch should be drawn on needle downstroke.

To increase thread drawn on downstroke, position needle thread eyelet (AD, Fig. 1) farther to the rear. With needle at the bottom of its stroke, position needle thread eyelet (AD), so that needle thread cam-off (AE) just contacts the needle thread.

LOWER LOOPER THREAD CONTROL

Set lower looper thread eyelet (R, Fig. 1) about horizontal and all the way forward in its slot.

Frame looper thread guide (T) should be set with its eyelet approximately 1/8 inch to the right of lower looper heel eyelet, when lower looper is at the left end of its stroke.

UPPER LOOPER THREAD CONTROL

With material under presser foot, set upper looper thread eyelet (N, Fig. 1) to rest on top of lower looper thread eyelet, (R) and back far enough so upper looper thread is a little slack when upper looper reaches the left end of its stroke.

POSITIONING THE SQUARE EDGE

Position of lower looper thread at the edge is located by balancing needle and upper looper thread tensions.

To reduce amount of lower looper thread in the stitch, or close the edge more, increase lower looper thread tension.

TERMS

Prices are net cash and subject to change without notice. All shipments are forwarded f. o. b. shipping point. Parcel Post shipments are insured unless otherwise directed. A charge is made to cover postage and insurance.

The parts illustrated above and described below represent the parts that are used on Style 39500 MA, but are not used on Style 39500 GS.

Those parts shown in phantom views and bearing no reference numbers are common to Styles 39500 GS and MA.

Use Catalog No. 103 FA (Style 39500 GS) for all parts not illustrated or described in this catalog.

<u>Ref. No.</u>	<u>Part No.</u>	<u>Description</u>	<u>Amt. Req.</u>
1	39592 AE-8	Looper Thread Tension Spring-----	2
	39592 AE-4	Needle Thread Tension Spring-----	1
2	39524 AV	Throat Plate, marked "BZ"-----	1
3	39526 AB	Differential Feed Dog, vulcanized rubber feed surface-----	1
4	39505 AB	Main Feed Dog, marked "AG", vulcanized rubber feed surface-----	1
5	39540 B-30	Main Feed Drive Eccentric-----	1
6	39540 B-30	Differential Feed Drive Eccentric-----	1

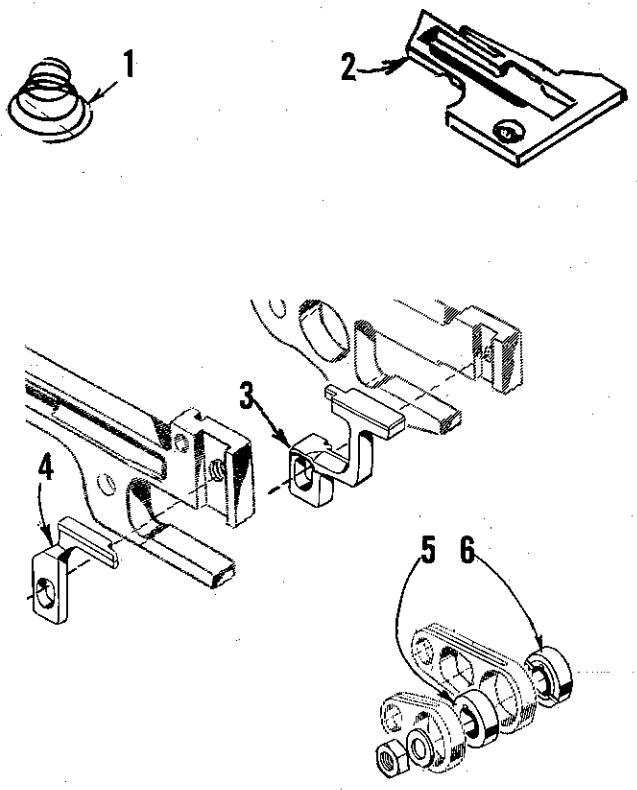



FINEST QUALITY

Union Special®

LEWIS and COLUMBIA

INDUSTRIAL SEWING MACHINES



SALES OFFICES AND REPRESENTATIVES

†Handle Union Special and Columbia only.

‡Handle Lewis and Columbia only.

All others handle Union Special, Lewis and Columbia with certain exceptions.

UNITED STATES

ALABAMA 35206, BIRMINGHAM, 732-84th Street, South, Lloyd D. Baldwin, Tel. 833-9904.

ALABAMA 36107, MONTGOMERY, 3223 Willow Lane Dr., (Zip Code 36110), Tommy Hendrix, Tel. 272-6667.

ARKANSAS 72203, LITTLE ROCK, P.O. Box 1783, James T. Taylor, Tel. (501) 376-3121.

*CALIFORNIA 90021, LOS ANGELES, 1100 E. Pico Blvd., Paul M. Mason, Mgr., Tel. Madison 5-5828.

CALIFORNIA 94110, SAN FRANCISCO, 3420-25th Street Robert J. Vail, Tel. 415/826-5969.

‡CALIFORNIA 94103, SAN FRANCISCO, Apparel City Sewing Machine Co., 1155 Mission St., Tel. MArket 1-6660.

COLORADO 80002, ARVADA, Casey's Sewing Machine Service, 5719 Reed St., Tel. 424-6630.

CONNECTICUT 06811, DANBURY, 22 Barnum Road, Robert W. Gaines, Tel. 746-3652.

FLORIDA 33127, MIAMI, 2525 N.W. 2nd Ave., Trimco Sewing Equipment, Inc., Tel. 633-1138.

FLORIDA 33566, PLANT CITY, 506 N. Gordon St. James C. Morgan, Tel. 752-1829.

*GEORGIA 30324, ATLANTA, 2120 Plasters Bridge Road, N.E., Merritt M. Ambrose, Mgr., Tel. 875-9237.

GEORGIA 30529, COMMERCE, Lakeview Drive, J. Tom Hanley, Tel. 335-4061.

GEORGIA 30030, DECATUR, 1713 Coventry Road, Joe V. Parker, Tel. 377-5559.

GEORGIA 31021, DUBLIN, 1615 Knox St., John W. Jones, Tel. 272-4663.

GEORGIA 30501, GAINESVILLE, RFD #1, John Bradberry, Tel. Cumming, Ga. 887-4732.

GEORGIA 30680, WINDER, 508 Fifth Ave., B. D. Smith, Tel. 867-3208.

*ILLINOIS 60610, CHICAGO, 400 N. Franklin St., Fred L. Koehler, Mgr., Tel. 644-6920.

KANSAS 66208, KANSAS CITY (PRAIRIE VILLAGE) 7351 Rosewood, Cleo C. Smith, Tel. HE 2-1705.

KENTUCKY 40207, LOUISVILLE, P.O. Box 7261, Raymond E. Hinton, Tel. 587-0042.

LOUISIANA 70458, NEW ORLEANS (SLIDELL) 275 Palm Springs Drive, Duane Bunger, Tel. 504/643-2484.

MARYLAND 21215, BALTIMORE, P.O. Box 2505, Ralph B. Foster, Tel. 727-8499.

‡MARYLAND 21204, BALTIMORE, J. Dashew, Inc., 417 W. Baltimore St., Tel. LExington 9-1838.

*MASSACHUSETTS 02111, BOSTON, 179 Lincoln St., William E. Palm, Mgr., Tel. Liberty 2-0147.

MASSACHUSETTS 02021, CANTON, York St., RFD, Roy T. Pedersen, Tel. 828-1412.

MASSACHUSETTS 02767, TAUNTON, P.O. Box #2 Raynham, Walter P. Godek, Tel. VanDyke 2-6149.

MICHIGAN 48223, DETROIT, 14561 Auburn, John Joyce, Tel. 313-584-4210.

MINNESOTA 55426, MINNEAPOLIS, 2800 Texas Ave., St. Louis Park, Minn., Leonard W. Koehler, Tel. 644-6236.

MISSISSIPPI 39209, JACKSON, 327 Eastview St., Jamie A. Boyette, Tel. Fleetwood 5-1976, Larry Lancaster, P.O. Box 1427 (Tupelo) 38801, Tel. 601/842-7650.

‡MISSOURI 64105, KANSAS CITY, Textile Machinery Co., 915 Broadway, Tel. Victor 2-9558.

MISSOURI 63114, ST LOUIS, 9022 Pallardy Lane, Carl E. McLaughlin, Tel. Chestnut 1-2368, 8725 Warner (Zip Code 63117), also Jerry Hicks.

‡NEW HAMPSHIRE 03060, NASHUA, P.O. Box 257, Herman E. Haberman Jr., Tel. Tuxedo 2-9698.

‡NEW JERSEY 07032, NORTH ARLINGTON, 32M Garden Terrace, Joseph Logiisci, Tel. 991-8211.

‡NEW JERSEY 07010, RUTHERFORD, 246 Sylvan St., Richard W. Whitson, Tel. Geneva 8-2178.

NEW JERSEY 08091, WEST BERLIN, P.O. Box 26, Frank A. Neff, Tel. 767-4350.

NEW YORK 02110, LATHAM, 57 Sylvan Ave., Clarence A. Wheeler, Tel. 518-785-6371.

NEW YORK 14502, MACEDON, 3 Jupiter Way, James Halbohm, Tel. 986-4693.

*NEW YORK 10001, NEW YORK, 370 7th Ave., (Penn Terminal Bldg.), Clarence L. Rosenquist, Mgr., Tel. Chickering 4-8800.

‡NEW YORK 14609, ROCHESTER, A. J. Adams Co., 1051 Culver Rd., Tel. BUTler 8-7250.

NEW YORK 11553, UNIONDALE, 873 Henry St., Anthony Candell, Tel. Ivanhoe 3-7477.

NORTH CAROLINA 27403, GREENSBORO, P.O. Box 226, William D. Harrod, Tel. 299-9367, 4216 Pennydale Dr., (Zip Code 27407), also Harold E. Miller, Tel. 292-0734.

OHIO 44109, CLEVELAND, 4914 Pearl Road, Cut & Sew Equipment Co., Tel. 661-5901.

OHIO 43216, COLUMBUS, P.O. Box 874, Larry Kelsen, Tel. AXminister 1-1222.

OKLAHOMA 73119, OKLAHOMA CITY, 2226 Southwest 53rd St., G. B. Wiley, Tel. 685-2836.

OREGON 97220, PORTLAND, 1950 N.E. 118th Ave. Robert E. Ritt, Phone: 503/771-2159 (Portland) 206/624-8083 (Seattle).

PENNSYLVANIA 18105, ALLENTOWN, P.O. Box 542, Luther D. Cassell, Tel. 797-2111.

PENNSYLVANIA 18015, BETHLEHEM, 1212 Camec St., Ed Deegan, Tel. 868-8204.

PENNSYLVANIA 18003, BERWICK, 1013 E. 16th St., Donald McFadden, Tel. 752-2442.

PENNSYLVANIA 18411, CLARKS SUMMIT, 428 West Grove Ave., John J. Lafer, Tel. JUNiper 7-2820.

*PENNSYLVANIA 19124, PHILADELPHIA, 4234 Macalester Ave., Ben W. Merz, Mgr., Tel. Gladstone 5-9800.

‡PENNSYLVANIA 15670, NEW ALEXANDRIA, (Pittsburgh), R.D. No. 1, Box 26A, W. Dale Speer, Tel. (Pittsburgh) 563-3589, also R. N. Bates.

PENNSYLVANIA 17567, REAMSTOWN, P.O. Box 176, David M. Bender, Tel. 267-6109, also F. J. Bartosic.

PENNSYLVANIA 17404, YORK, P.O. Box 884, Harding T. Powell, 854-8040, also F. J. Bartosic.

SOUTH CAROLINA 29204, COLUMBIA, P.O. Box 4246, Virlyn R. Crisler, Tel. Sunset 7-0863, P.O. Box 4112, also J. W. Carter, Tel. 254-4255.

SOUTH CAROLINA 29607, GREENVILLE, 25 Sir Abbot St., Orville W. Gregory, Tel. Cedar 9-5539.

TENNESSEE 37421, CHATTANOOGA, 1711 Roy Jo Circle, John W. Carter 615-892-1489.

TENNESSEE 37919, KNOXVILLE, 3905 Greenleaf Ave., Horace E. Clinard, Tel. 588-1865.

TENNESSEE 38117, MEMPHIS, 4695 Dunn Rd., Richard J. Lindhorst, Tel. Mutual 5-6750.

TENNESSEE 37214, NASHVILLE, 2517 Woodberry Drive, Felix M. Blunkall, Tel. 615-254-7538.

*TEXAS 75247, DALLAS, 6718 Oakbrook Blvd., P.O. Box 47424, J. H. Muir Mgr., Tel. 214/637-5990.

TEXAS 79926, EL PASO, P.O. Box 9573, Edward E. Smith, Tel. 598-2928.

TEXAS 76106, FT. WORTH, 1201 Altamont Dr., Arnold Stierwalt, Tel. 626-3183.

TEXAS 78213, SAN ANTONIO, Jerry Gregory, P.O. Box 13126, Tel. DI 2-5924.

UTAH 84105, SALT LAKE CITY, 1215 E. 13th South St., Larry F. Rosvall, Tel. IN 7-6931.

VIRGINIA 24006, Roanoke, P.O. Box 1151, Tom Traylor, Tel. 703-342-3233, also P. C. Eble.

CANADA

UNION SPECIAL MACHINE Co. of Canada, Ltd.

BRITISH COLUMBIA, N. BURNABY 2, James Murray, 1522 Madison Ave., Tel. MU 3-3917.

MANITOBA, WINNIPEG 2, Frank Thierman, Rm. 201, Whitfo Bldg., 70 Arthur St., Tel. 204-943-4933.

*ONTARIO, TORONTO 2B, Peter Fowler, Mgr.-Rep., 355 King St. West, Tel. Empire 6-2939.

*QUEBEC, MONTREAL 11, John Caschetto, Mgr.-Rep., 9595 Charles de Latour St. Tel. 514/387-7191.

FINEST
QUALITY
WORK

HIGHEST
PRODUCTION
RATES

LOWEST
MAINTENANCE
COSTS

**Sales Agents For UNION SPECIAL Machines;
Also Agent for (L) LEWIS and (C) COLUMBIA where marked.**

AFRICA

(TEXTILE & BAG MAKING MACHINES) Berzack Bros., Ltd. REPUBLIC OF SOUTH AFRICA—JOHANNESBURG 135/7 Pritchard St. CAPE TOWN—78 Darling St. DURBAN—72 Commercial Road. PORT ELIZABETH—277 Main Street. RHODESIA, BULAWAYO—133 Fife St. SALISBURY—2 Barton House, Corner Stanley Ave. and Moffat St. (L) (BAG CLOSING MACHINES) South African Scale Co. Pty., Ltd. REPUBLIC OF SOUTH AFRICA—JOHANNESBURG—32 Von Brandis St. BLOMFONTEIN—53 Zastron St. CAPE TOWN—Wales and Bree Sts. DURBAN—22 Allwell St. EAST LONDON—33-35 North Street, LADYSMITH, Natal—355 Murchison. PORT ELIZABETH—Box 611. Also at PIETERMARITZBURG, PRETORIA, VERENING—288 Potgieter St. RHODESIA, BULAWAYO—2 Leander House, Rhodes Street. SALISBURY—95 Victoria Street, ZAMBIA—LUSAKA—W. & T. Avery (Zambia) Ltd., Corner Stanley Road & Cadrington Street. ALGERIA, ALGIERS—Etablissement Ail Amer, 62 Boulevard Mohamed V. (L & C) ETHIOPIA, ASMARA—S.A. Calderan Africa, Avenue P. Asthana Woosen (L & C) GHANA—ACCRA—Crown Industrial Enterprises Ltd., P.O. Box 3547 (L & C) IVORY COAST—ABIDJAN—Ets. Jean Abile-Gai, Box 1798. (L & C) KENYA, NAIROBI—Transcandia, Ltd., College House, Koinange St. (P.O. Box 5933) (L & C) (Also Uganda, Tanganyika and Zanzibar) MALAGASY REPUBLIC—TANANARIVE—Soc. Ind. Et Com. De L'Emyrne, Boite Postale 1078, 17 Rue Clemenceau (L & C) MAURITIUS, PORT LOUIS—(Bag Closing & Bag Making Machines) Hall, Geneve, Langlois, Ltd., 42 Sir William Newton St. MOROCCO, CASABLANCA—R. Geismann & Fils, Rue El Idrissi Es Sakali (L) NIGERIA, APAPA, LAGOS—Sunflag Knitting Mills (Nigeria) Ltd. 9 Warehouse Road. (L & C) SUDAN, KHARTOUM—Franco Pinto (Sudan) Ltd., P.O. Box 305. (L & C)

ASIA

CAMBODIA, PHNOM-PENH—Denis Freres, 219 P.B. Sisowath, P.O. Box 48. (C & L) HONG KONG—G. R. Coleman Co. (Hong Kong) Ltd., Rm. 309, Marina House, 15 Queen's Road, Central. INDIA, CALCUTTA—Patrol Sewing Machine (P.) Ltd. 9/1 Sovaram Bysack St. G.P.O. Post Box 24. (L & C) JAPAN, OSAKA—Kanda Sewing Machine, Ltd., Umegae-Cho Kita-ku. (L) Branch—TOKYO. 3-6 Ginza Chuo-Ku 163. Also at: Ashikaga, Fukui, Hokkaido, Nagoya, Niigata, and Okayama. LAOS, VIETNAM—Denis Freres, P.O. Box 133. (C & L) PAKISTAN, (WEST) KARACHI—2 (Textile Machines)—Universal Trading Corp., 29 Zeeat Mansion, McLeod Road. (EAST AND WEST) (Bag closing and bag making machines) Thomas C. Keay, Ltd., 15 Baltic Street, Dundee, Scotland. REPUBLIC OF CHINA, TAIWAN, TAIPEI—G. R. Coleman Co. (Taiwan) Ltd., 16 Nan Yang St. (L & C) SINGAPORE 3—G. R. Coleman (Singapore) Ltd., No. 1-M Yong Siak St. Also all of Malaysia. (L & C) THAILAND, BANGKOK—Yip In Tsai & Co., Ltd., P.O. Box 23. (L & C) VIETNAM, SAIGON—Thai-Binh-Duong Cong-TY, 147 Rue Trinh-Minh-The. (C & L)

AUSTRALIA

SOLE DISTRIBUTORS: Capron, Carter Pty., Ltd., 490 Kent Street, SYDNEY 2000. Branches at: BRISBANE—454 Brunswick St., Valley, N.I. MELBOURNE 3000—134 A Beckett St. AGENTS: SOUTH AUSTRALIA—ADELAIDE—William Charlick Ltd., London Road, Mile End. WESTERN AUSTRALIA PERTH—Thomson's Pty. Ltd., 789 Hay St. TASMANIA, LAUNCESTON—Sew Knit Pty. Ltd., 72-74 George St. (L & C)

EUROPE

AUSTRIA, VIENNA A-1061—Naeschuster Heinrich Schuster O.H.G., Mariahilferstr. 51, Postfach 77, (L) (C—except 100 NTN) BELGIUM, BRUSSELS—Union Special Machine Corporation of America, 90 Rue de la Caserne, Gustave Thierie, Mgr. (C) DENMARK, COPENHAGEN—Rothenborg Specialmaskiner for Sy-Industri A/S, Nikolaj Plads 23. Offices at AALBORG, HERNING, KOLDING, ODENSE, RISSKOV-AARHUS AND SILKEBORG. (L & C) FINLAND, HELSINKI-LAUTTASAARI—Suomen Kenolike O/Y, Vattunienkatu 13. Branches at TAMPERE-Pienteollisuus-talo, TURKU, Humalistonkatu 7-B. (L & C) FRANCE, PARIS—Cie. des Machines Union Special de France, 91 Ave. de la Republique—Thos. de Semlyen, Directeur, Branches at: (59) LILLE 5 Residence Citeaux, Parc Saint-Maur. LYON, VILLEURBANNE (RHONE) 58 rue Alexandre Bouthin. TOULOUSE (HAUTE GARONNE) 9 Rue des Penesces. (L & C) GERMANY, STUTTGART (7000)—Union Special Maschinenfabrik, G.m.b.H., Schwabstr. 33—Dr. K. Schulz, Managing Director. Th. W. Baanstr. Director of Sales, BRANCHES AT: BERLIN, BIELEFELD, EBNING, FRANKFURT, HAMBURG, KOLN, MUNCHEN, OCHTRUP. (L & C) GREAT BRITAIN—(Textile Machinery)—ENGLAND LE2 5LN—OADBY (NR. LEICESTER)—Union Special Machine Company, Ltd., Mandervell Road, Industrial Estate. Mr. J. C. Spencer, Manager. LEEDS—60 Merriion Street. LONDON—184-186 Old St. (A. W. J. Brownlee, Manager). SALES OFFICES: BRISTOL, L. J. Heard, 19 The Kings, SCOTLAND, MILNGAVIE (GLASGOW)—Derrick R. Robinson, 48 Clochar Avenue. SUB-AGENTS: LONDON, W. 1—C. Johnson & Son (Sewing Machinery), Ltd., 58 Great Titchfield Street. MANCHESTER 19—S. A. Smith, (Manchester) Ltd., Park Grove Works, Levenshulme. NORTHERN IRELAND—BELFAST 15, Aktex Ltd. 186 Cavehill Road. SCOTLAND, GLASGOW S.E.—Allardice & Co., 9 Stevenson Street. (C) (Bag Closing and Bag Making Machines) SCOTLAND, DUNDEE—Thomas C. Keay, Ltd., 15 Baltic Street—Agent for entire British Isles. GREECE, ATHENS—Georgos Yannakouras-Dimoulis, 30 Petraki St. (L & C) ICELAND, REYKJAVIK—Magnus Thorgerisson, Skolavordustig 1a (L & C) IRELAND, DUBLIN—(Textile Machines) W. Blythman, 224 Parnell Street (L & C) (Bag Closing and Bag Making Machines) Thomas C. Keay, Ltd., 15 Baltic St., Dundee, Scotland. ITALY, I 20121 MILANO—Giovanni Conti & Nipoti, Via Varese 18. (L & C) MALTA, VALLETTA—Frank Borda & Sons, Ltd. 51/41 Zachary Street (L & C) THE NETHERLANDS, AMSTERDAM—N. V. Machinehandel C. & H. Verbeek, Kloveniersburgwal 177. Offices at: ARNHEM, ENSCHEDE, GRONINGEN, ROTTERDAM, SIT- TARD, TILBURG. (L & C) NORWAY, MANGELERUD—Jac. Jacobsen A/S, Enebakkveien 117, BERGEN—Bjornsonsgt 24. (C & L) PORTUGAL, OPORTO—Rost & Janus, Succs. Lda., Rua Barao de Forrester 91A. (L) SPAIN, BARCELONA—Rapida, S. A., Via Layetona 37. (L & C) SWEDEN, GOTEBOG 5—Jac. Jacobsen A/B, Mohndalsvagen 91. Branch at: BORAS, Lunnegatan 4. Also in MALMO and STOCKHOLM. (L) SWITZERLAND, URDORF (ZH) 8902—Bourquin & Cie., Vogel-aust. (L-Button-Sewer) YUGOSLAVIA, KIRCHEIM (7312)—Josef Scharzer Bosslerstr 33. (L & C)

LATIN AMERICA

ARGENTINA, BUENOS AIRES—Pamaco Costura S.A.C.I.-Y.F. San Jose 350. (Union Special Machine Company). (L & C) BOLIVIA—Lowenstein & Stewart, S.A.C., Calle Santo Domingo 1140, Santiago, Chile. (L & C) BRAZIL, SAO PAULO—Pancostura S.A.—Industria e Comercio, Alameda, Cleveland, 444. Branches at PORTO ALEGRE—Rua Voluntarios da Patria 533; RECIFE—Rua Princesa Isabel 105; RIO DE JANEIRO—Rua Alexandre Mackenzie 117. (C & L) CHILE, SANTIAGO—Lowenstein & Stewart, S.A.C., Calle Santa Domingo 1140. (L & C) COLOMBIA, BOGOTA—Mecalzado, Mercantil, S.A., Carrera 30 #12-99. Branches at BARRANQUILLA—Carrera 45-B #34-54. BUCARAMANGA—Calle 34 #17-45. CALI—Carrera 7 #13-33/35. MANIZALES—E. Breslauer, Carrera 22 #18.44. MEDELLIN—Carrera 51, 36-18. (L & C) COSTA RICA, SAN JOSE—Enrique Rodriguez S., P.O. Box 1949. (L & C) DOMINICAN REPUBLIC, SANTA DOMINGO—Roberto Dominquez, G., Calle Dr. Pedro Urena 19. (L & C)

ECUADOR, GUAYAQUIL—Distribuidora Richard O. Custer, S.A., Malecon Simon Bolivar #2308. Branch at QUITO—Avenida Patria 76B. (L & C) EL SALVADOR, SAN SALVADOR—Distribuidora Union Special de El Salvador, Colonia Yairo. (L) GUATEMALA, GUATEMALA—Union Textil Gunter Henning & CIA., LTDA., 8a Avenida 10-43, Zona 1 (L & C) HONDURAS, SAN PEDRO SULA—Jacobo E. Handel, P.O. Box 559. TEGUCIGALPA—Carlos Handal, P.O. Box 517. (L & C) MEXICO, MONTERREY, N.L.—Talleres Perez Zozayo, S.A. de C.V., Cuauhtemoc Norte 335. Branches at: GUADALAJARA, JAL., Hidalgo 45 y 47; MEXICO, D.F.—Distribuidora Union Especial, S.A. de C.V., Ave., Pino Suarez 99-a (Apartado 28070); SAN LUIS POTOSI, S.L.P.—J. de los Reyes 80. (L) NICARAGUA, MANAGUA—Casa Hentgen, 3A Calle N.O. #303. (L) PANAMA, PANAMA—International de Comercio, S.A., Banco de Colombia Building, P.O. Box 1275. PERU, LIMA, Breña—United Agencies, S.A. (Peru) Av. Alfonso Ugarte 1445-1447. (L & C) PUERTO RICO, SAN JUAN—Abarca Warehouse Corp., P.O. Box 2352. (L & C) SURINAM, PARAMARIBO—Kirpalani's, Ltd., 17-27 Maagden St. (L & C) URUGUAY, MONTEVIDEO—Storer & Cia., S.A., Uruguayua, Mercedes 1312. (L) VENEZUELA, CARACAS—H. Blohm, S.A., Dr. Paul A. Chorro 29. (L)

NEAR EAST

CYPRUS, NICOSIA—Christodoulides Bros. & Co., 94 Tri-cauppiis St. (L) IRAN, TEHRAN—Sava Trading Corp., Ave. Bozarijomehri 881 P.O. Box 1720. Seray Saadiyeh. (L & C) IRAQ, BAGHDAD—Sons of O. O. Agopian (IRAQ), P.O. Box 2021, Alwiyah. (L & C) ISRAEL, TEL AVIV—L. Taube, Ltd., 15 Lilienblom St. (L) JORDAN—Bandar & Aractingi, B.P. 1144—Damas, Syria (L & C) LEBANON, BEIRUT—Ibrahim R. Audi & Cie., 11 Rue Patri-arche Hoyek. (L & C) SYRIA, DAMAS—Bandar & Aractingi, B.P. 1144. (L & C) TURKEY, ISTANBUL—M. Benmayor, Mahmutpasa Abut Efrandi Han Nr. 46-47. (L & C) U.A.R., Cairo—Mitr Import & Export Co., 6 Rue Adiy-Tech. Sub-Agent—A. Kovaldijan, S.A.R.L. 200 Sharie Shubra. (L & C)

NEW ZEALAND

SOLE DISTRIBUTOR: H. A. Tuck & Co., Ltd., 171 Albert St. AUCKLAND. BRANCH AT: WELLINGTON, Lees Bldg., Nelson St. (L) Also—New Caledonia, Cook Islands, Ellice Islands, Gilbert Islands, New Hebrides, Samoa (American), Tahiti, and Tonga. SUB-AGENTS: Glendernid, Ltd., CHRIST-CHURCH—90 Orbell St. DUNEDIN—192-196 Castle St., P.O. Box 40. (C) FIJI SUVA—Karl R. Fleischman, P.O. Box 602. (L) SAMOA (WESTERN), APIA—S. C. Percival, P.O. Box 204. (L)

PACIFIC ISLANDS

HAWAII, HONOLULU—Altsew, Inc., 1892-D Kalakaua Ave. (Textile L & C). (Bag Closing and Bag Making Machines) H. S. Gray Co., 759 Puuloa Rd. PHILIPPINE ISLANDS, MAKATI, RIZAL—Atkins, Kroll & Co., Inc., 7232 Malugay Street, (Buendia Extension). Branch at CEBU. (L & C)

WEST INDIES FEDERATION, JAMAICA

JAMAICA, KINGSTON—Morris E. Parkin, 67 Church Street. (L) TRINIDAD, PORT OF SPAIN—Ackrill & Co., 17 Henry St. (L & C) Also—BARBADOS, GRENADA, TOBAGO.

Additional Sales Agents for (L) LEWIS and (C) COLUMBIA Machines

4-68

AUSTRIA IV, VIENNA—Franz Koerpert & Sohne, K.G., Wiedner Hauptstrasse 36. (C) BELGIUM, BRUSSELS—N. V. Machinehandel C & H Verbeek, Kruidentuinlaan 57a, Buyl Bldg. (L) FRANCE, PARIS—Societe G. Arnan & Cie., 14 Rue Commines (L) GERMANY, KREFELD—Herbert Jonnsen, Alte Linnerstr. 104 (C. tie mach.) GREAT BRITAIN—ENGLAND, LONDON, E.C.2—Eastman Machine Company, Ltd., 128-132 Curtain Road. CROY-DON, 89 Beddington Lane. LEEDS—60 Merriion Street. MANCHESTER, 105-107A Corporation Street. SCOTLAND, GLASGOW S2—11 Drumsroch Place, Torryglen. NORTHERN IRELAND, BELFAST 14—W. F. Maxwell, 20 Teadbun Park. REPUBLIC OF IRELAND, DUBLIN—Wm. Blythman, Ltd., 223/4 Parnell Street. (L)

ISRAEL, TEL AVIV—Israel Sewing Machine Co., 22 Yehuda Halevy St. (C) MEXICO, MEXICO, D.F.—Casa Diaz de Maquina de Coser, Av. Republica Del Salvador 89-93 (C) MOROCCO, CASABLANCA—Durkopp Coudeux, 25 Rue Bascu-nana. (C)

REPUBLIC OF SOUTH AFRICA, JOHANNESBURG—African Sewing Machine Company (Pty.) Ltd., 113 President Street. Branches at: CAPE TOWN—110 Plein St., DURBAN, (C) RHODESIA, FEDERATION OF RHODESIA & NYASALAND, BULAWAYO—African Sewing Machine Company (Rhodesia) (Pvt.) Ltd., 2 Leonidas House, 138 Rhodes Ave. (C) SWEDEN, BORAS—Husvarna, Industrimaskiner A/B—Katrinedalsgatan 13. Branches: GOTEBOG—Stigbergsgiden 1 MALMO—Isak Staktaregatan 9—OREBRO—Stortorget 19—STOCKHOLM—Brunnsgatan 6-8. (C) SWITZERLAND, ZURICH—Fritz Zellwegger & Sohne, Sei-naustr. 27. (L except Button Sewer) Guttinger A.G., Stihlstrasse 37. (C) URUGUAY, MONTEVIDEO—C. Brandes & Cia., S. A. Calle Pincan 658-60. (C)



Union Special[®]
INDUSTRIAL SEWING MACHINES

UNION SPECIAL maintains sales and service facilities throughout the world. These offices will aid you in the selection of the right sewing equipment for your particular operation. Union Special representatives and service men are factory trained and are able to serve your needs promptly and efficiently. Whatever your location, there is a Union Special Representative to serve you. Check with him today.

ATLANTA, GA.

BOSTON, MASS.

CHICAGO, ILL.

DALLAS, TEXAS

LOS ANGELES, CAL.

NEW YORK, N. Y.

PHILADELPHIA, PA.

MONTREAL, CANADA

TORONTO, CANADA

BRUSSELS, BELGIUM

LEICESTER, ENGLAND

LONDON, ENGLAND

PARIS, FRANCE

STUTT GART, GERMANY

Representatives and distributors in all important industrial cities throughout the world.

Union Special

MACHINE COMPANY