

Singer 15-96

Singer 15-97

Singer 15-98

Form 19603
(1140)
Printed in U. S. A.

LIST OF PARTS



FOR FAMILY SHOPS

MACHINES
Nos. 15-96, 15-97 and 15-98

THE SINGER MANUFACTURING COMPANY

INDEX

**Genuine Singer Needles should be used
 in Singer Machines.
 These Needles and their Containers
 are marked with the
 Company's Trade Mark "SIMANCO." 1**

**Needles in Containers marked
 "For Singer Machines"
 are not Singer made needles. 2**

	Page
Accessories.....	27
Attachment Set.....	27
Bias Gauge.....	28
Bobbin Winder.....	28
Braider.....	29
Controllers (Bakelite).....	16
Controller Holder.....	17
Corder (Bow).....	29
Feed Cover Plate.....	29
Feller (Foot).....	29
Finger Guard.....	29
Foot Controllers (Bakelite).....	14
Hemmer (Foot).....	29
Hemstitcher.....	30
Knee Lever Parts.....	18
Machine No. 15-96.....	5
" " 15-97.....	10
" " 15-98.....	11
Motor Parts.....	12
Numerical List of Parts.....	33
Ruffler Shirring Plate.....	31
Quilter.....	31
Presser Feet.....	30
Presser Foot with Graduated Adjustable Guides.....	30
Singerlight No. 193294.....	23
" " 193518.....	26
" " Lamp.....	27
Special Attachments.....	32
Treadle Controllers for Stands Nos. 25281, 25282 and 25294.....	19
Treadle Controllers for Stands Nos. 46909, 46912 and 46913.....	20
Under Braider.....	31

INSTRUCTIONS FOR ORDERING

5

In ordering from this list, use ONLY the part NUMBER in the FIRST column.

The number stamped on a Sewing Machine Part is in every case the number of the single part only.

Every combination of parts sent out as such has its specific number, which, although not stamped on the parts, must be used when ordering the combination.

Each number always indicates the SAME PART in whatever list it appears, or for whatever machine.

The letters after some of the numbers indicate the style of finish only, as follows:

- A-Hardened, Polished, Nickel Plated and Buffed
- A.A-Buffed and Chromium Plated
- A.B-Hardened, Polished, Buffed and Chromium Plated
- A.C-Brown Baking Enamel Finish
- A.D-Gray Baking Enamel Finish
- A.E-Hardened, Bright Rumbled and Nickel Plated
- A.F-Hardened, Bright Rumbled, Nickel Plated, Bright Rumbled and Chromium Plated
- B-Polished, Nickel Plated and Buffed
- C-Hardened Only
- C.R-Hardened and Merlized
- D-Polished Only
- E-Soft, Not Polished
- F-Hardened and Polished
- F.J-Hardened, Polished and Nickel Plated
- G-Bright Rumbled and Nickel Plated
- H-Blued
- J-Nickel Plated Only
- K-Hardened and Nickel Plated
- L-Brass Plated
- M-Oxidized
- N-Japanned, Dull
- P-Japanned, Bright
- P.P-Wrinkle Finish
- R-Merlized
- S-Cadmium Plated
- T-Copper Plated
- T.A-Hardened, Polished, Copper and Nickel Plated and Buffed
- T.B-Copper and Nickel Plated and Polished
- T.J-Copper and Nickel Plated Only
- T.K-Hardened, Copper and Nickel Plated
- T.L-Copper and Brass Plated
- T.M-Copper Plated and Oxidized
- U-Zinc Plated
- V-Silver Plated
- W-Polished and Nickel Plated
- X-Black Oxide, for Iron and Steel
- X.C-Hardened and Black Oxide, for Iron or Steel
- Y-Black Nickel Plated Only
- Z-Chromium Plated
- Z.A-Hardened, Polished, Nickel Plated, Buffed and Chromium Plated
- Z.B-Polished, Nickel Plated, Buffed and Chromium Plated
- Z.C-Hardened and Chromium Plated
- Z.D-Polished and Chromium Plated
- Z.G-Bright Rumbled, Nickel Plated, Bright Rumbled and Chromium Plated
- Z.J-Nickel and Chromium Plated
- Z.T-Copper and Chromium Plated

These letters MUST BE USED when they appear in the list; and AFTER the number as in the list.

In this series:

1 to 1500, 50001 to 51500 and 140001 to 142000

are Screw Numbers

1501 to 1800 and 51501 to 51800 are Nut Numbers

1801 to 2000 and 51801 to 52000 are Roller Numbers

2001 to 50000 and 52001 to 140000 and 142001 to

190000 are Sewing Machine Parts, 190001 and upward

are numbers of Electrical Parts.

The figures in the second column refer only to the plates,

illustrating the parts, and are NOT TO BE USED in ordering.

Parts marked with an asterisk (*) are furnished only when

repairs are made at factory.

LIST OF PARTS COMPLETE

FOR

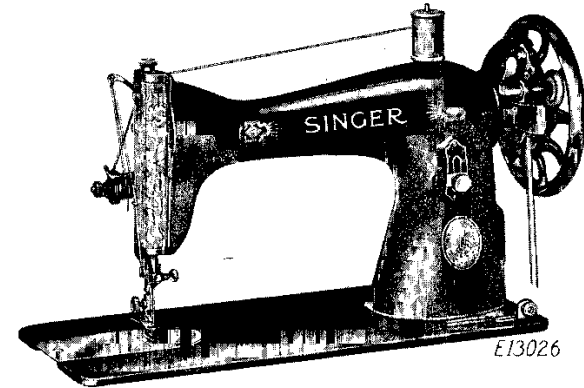

MACHINE No. 15-96

FOR FAMILY USE. C. B. SHUTTLE. DROP FEED.
BALANCED MACHINE.

No.	Plate	Name
*125106	----	Arm with 435C, 448C, 15404, 15486, 15498 and two 15405.....
2002	21471	Arm Dowel Pin (2).....
125331	21471	" Oil Pad (felt) for oiling Arm Shaft Back Bearing.....
125333	21471	Arm Oil Pad Spring.....
125334	21471	" " " " Cap.....
138E	21471	" Screw (2).....
125042	21471	" Shaft.....
15498	21471	" " Bushing.....
435C	21471	" " " Set Screw.....
125425	21471	" Side Cover.....
51224B	21471	" " " Thumb Screw.....
2007	21471	" Spool Pin.....
8879	21471	" " " Washer (cloth).....
15282	21471	Balance Wheel, 2 1/4 in. pulley.....
*125107	----	Bed.....
256B	21471	Clamp Stop Motion Clamp Screw.....

PARTS FOR MACHINE No. 15-96

No.	Plate	Name
248A	21471	Clamp Stop Motion Clamp Stop Screw.....
2020	21471	" " " " Washer.....
15313	21471	" " " Flanged Bushing with two 462C.....
462C	21471	Clamp Stop Motion Flanged Bushing Set Screw (2).....
15314	21471	Clamp Stop Motion complete, Nos. 248A, 256B, 2020 and 15313.....
125021	21471	Crank Connecting Rod with 125044 and two 896C.....
896C	21471	Crank Connecting Rod Cap Screw.....
375C	21471	" " " Hinge Screw.....
1518J	21471	" " " " Nut....
125044	21471	" " " 011 Pad (felt)....
15432	21474	Face Plate with 857B,15410,15412,15428, 50292B and 125423.....
15408	-----	Face Plate Tension Seat.....
15428	21474	" " " " 15408 with 15395
55644	21474	Face Plate complete, Nos. 15432 and 15471.....
190B	21474	Face Plate Screw.....
125422	-----	" " Thread Guard.....
125423	21474	" " " " 125422 with 125424
125424	-----	" " " " Rivet.....
2835	21472	Feed Bar.....
315C	21472	" " Screw Center.....
15445	-----	" " " " 315C with 1519J (2)
1519J	21472	" " " " Nut.....
125045	21471	" Cam and Counterbalance with 1285C..
1285C	21471	" " " " Position Screw
15279	21474	" Dog,12 teeth (14 teeth to the inch) for 15280, 15316 and 15317.....
208E	21474	Feed Dog Screw (2).....
125046	21471	" Forked Connection.....
125085	-----	" " " " 125046 with 125335
1381C	21471	" " " " Hinge Screw (ec- centric).....
1520J	21471	Feed Forked Connection Hinge Screw Nut..
125047	21471	" " " " Slide Block.....
125335	-----	" " " " " 125047 with 1085E.....
1085E	21471	Feed Forked Connection Slide Block Screw Stud.....
2816	21472	Feed Lifting Rock Shaft.....
2836	-----	Feed Lifting Rock Shaft complete, Nos. 2509 and 2816.....
2509	21472	Feed Lifting Rock Shaft Crank with 157J and 1813.....
157J	21472	Feed Lifting Rock Shaft Crank Clamping Screw.....

PARTS FOR MACHINE No. 15-96

No.	Plate	Name
1813	21472	Feed Lifting Rock Shaft Crank Roller and Stud.....
307C	21472	Feed Lifting Rock Shaft Screw Center....
56814	-----	" " " " " 307C with 1513J (2).....
1513J	21472	Feed Lifting Rock Shaft Screw Center Nut
125101	21471	" Regulator.....
8217	21471	" " Friction Washer.....
50353E	21471	" " Hinge Screw.....
51225B	21471	" " Thumb Screw.....
15297	21472	" Rock Shaft.....
307C	21472	" " " Screw Center.....
56814	-----	" " " " " 307C with 1513J (2).....
1513J	21472	Feed Rock Shaft Screw Center Nut.....
51045C	21471	Machine Hinge Connection Set Screw.....
125079	21471	Needle Bar.....
125052	21471	" " Bushing.....
125072	21471	" " " 011 Pad (felt).....
1498C	21471	" " " Set Screw.....
15248	21471	" " Connecting Link with 51002E..
15374	-----	" " " " " 15248 with 2052.....
51002E	21471	Needle Bar Connecting Link Adjusting Screw.....
570C	21471	Needle Bar Connecting Link Hinge Screw..
1520R	21471	" " " " " " Nut
2052	21471	" " " Stud with 155C.....
155C	21471	" " " " Set Screw....
125095	21471	" " Thread Guard.....
251A	21471	" " " " Screw.....
2054	21471	" Clamp with 552C.....
552C	21471	" " Thumb Screw.....
125055	21472	Oscillating Rock Shaft with 125056.....
125056	21472	" " " " Oil Wick (braided cotton).....
307C	21472	Oscillating Rock Shaft Screw Center....
56814	-----	" " " " " 307C with 1513J (2).....
1513J	21472	Oscillating Rock Shaft Screw Center Nut.
2510	21472	" Shaft.....
125057	21472	" " Crank.....
125059	-----	" " " " 125057 with 125330 and two 462C.....
462C	21472	Oscillating Shaft Crank Set Screw (2)...
125330	21472	" " " " Slide Block with Stud.....
125061	21471	Presser Bar.....
55621	21471	" " Lifter.....
15486	21471	" " " Hinge Stud.....

No.	Plate	Name
448C	21471	Presser Bar Lifter Hinge Stud Set Screw.
80011	21471	" " Spring.....
2068	21471	" " " Bracket with 453C....
453C	21471	" " " " Set Screw....
2070	21471	" " " Washer.....
45329	21474	" Foot Hinge Pin.....
45319	21474	" " Plate.....
45320	21474	" " Shank.....
45321	21474	Presser Foot (hinged) complete, Nos. 45319, 45320 and 45329.....
51224B	21474	Presser Foot Thumb Screw.....
51228ZJ	21471	Pressure Regulating Thumb Screw.....
66773	-----	" " " " 51228ZJ with 66752.....
66752	21471	Pressure Regulating Thumb Screw Plug (felt).....
2518	21473	Shuttle Bobbin.....
15140	21473	" " Case Latch.....
2973	21473	" " " " Lever.....
2974	21473	" " " " Fulcrum Pin.....
2975	21473	Shuttle Bobbin Case Latch Spring.....
592E	21473	" " " " Stop Screw....
15141	21473	Shuttle Bobbin Case Hinge, Nos. 2973, 2974 and 15140.....
15277	21473	Shuttle Bobbin Case complete, Nos. 591F, 592E, 2975, 15141 and 15278.....
2515	21473	Shuttle Body.....
591F	21473	" Tension Regulating Screw.....
15278	21473	" " Spring.....
125018	21473	" 1 11/16 in. diam., Nos. 2515, 2518 and 15277.....
125064	21472	Shuttle Driver with 125065 and two each 462C and 51229E.....
125065	21472	Shuttle Driver Cushion Spring.....
51229E	21472	" " " " Screw (2).
462C	21472	" " Set Screw (2).....
2531	21473	" Race Back.....
2532	21473	" " " Position Pin (2).....
125080	21473	" " " Spring.....
648J	21473	" " " " Screw.....
2530	21473	" " Body.....
15420	21473	" " " 2530 with 2535 and two 662J.....
2535	21473	Shuttle Race Cap.....
662J	21473	" " " Screw (2).....
2528	21473	Shuttle Race complete, Nos. 648J, 2531, 15420, 125080 and two 2532.....
145J	21473	Shuttle Race Screw (2).....
15188	21474	" " Slide.....

No.	Plate	Name
2824	21474	Shuttle Race Slide Spring.....
51282J	21474	" " " " Screw.....
15147	21474	Shuttle Race Slide complete, Nos. 2824, 15188 and two 51282J.....
125103	21471	Stitch Indicator.....
125104	21471	" " " Plate.....
140202S	21471	" " " " Screw (2).....
2102	21474	Tension Disc.....
1560B	21474	" Regulating Thumb Nut.....
32572	21474	" Releasing Disc.....
15238	21474	" " Pin.....
13710	21474	" Spring.....
50291W	21474	" Stud.....
15410	-----	" " Bushing.....
50292B	21474	" " Set Screw.....
15471	-----	Tension complete, Nos. 1560B, 13710, 15238, 32572, 50291W, 55645 and two 2102.....
15395	21474	Tension Thread Guard.....
26075	21471	Thread Cutter and Holder.....
15272	21471	" Take-up Cam with 1293C.....
15434	-----	" " " 15272 with 570C and 1520R.....
1293C	21471	Thread Take-up Cam Position Screw.....
15492	21471	" " Lever with 1322 and 50527C.....
50527C	21471	Thread Take-up Lever Hinge Screw.....
1822	21471	" " " Roller and Stud....
55645	21474	" " Spring.....
15412	21474	" " " Regulator.....
857B	21474	" " " " Set Screw
15316	-----	Throat Plate, large needle hole, for 15279.....
15280	21474	Throat Plate, medium needle hole, for 15279.....
15317	-----	Throat Plate, small needle hole, for 15279.....
Note: Throat Plate No. 15280 is regularly furnished with this machine.		
691A	21474	Throat Plate Screw (2).....
*15404	-----	Trade Mark.....
15405	-----	" " Rivet (2).....

MACHINE No. 15-97

FOR FAMILY USE. C. B. SHUTTLE. DROP FEED.
BALANCED MACHINE.

NOTE: THIS MACHINE IS THE NO. 15-96 MACHINE WITH A
B. R. MOTOR. MOULDED SINGERLIGHT AND THE
FOLLOWING EXCEPTION:

No.	Plate	Name
32672	21471	Balance Wheel, 3 1/4 in. pulley, in place of 15282.....

**Genuine Singer Needles should be used
in Singer Machines.
These Needles and their Containers
are marked with the
Company's Trade Mark "SIMANCO." 1**

**Needles in Containers marked
"For Singer Machines"
are not Singer made needles. 2**

MACHINE No. 15-98

FOR FAMILY USE. C. B. SHUTTLE. DROP FEED.
BALANCED MACHINE. HAND ATTACHMENT.

NOTE: THIS MACHINE IS THE NO. 15-96 MACHINE
WITH A HAND ATTACHMENT.

HAND ATTACHMENT PARTS

No.	Plate	Name
94050	21476	Body.....
94027	21476	" Bracket.....
183E	21476	" " Screw (2).....
94028	21476	Crank Handle (wood).....
94029	21476	" " Spindle.....
94030	21476	" " " Flange (loose).....
94069	21476	" Hinge Pin.....
94031	21476	" Lever.....
94032	21476	" " Lock Pin.....
94033	21476	" " " " Head.....
8282	21476	" " " " Spring.....
94034	----	Crank complete, Nos. 94028 to 94031.....
94046	21476	Driver.....
94036	21476	" Finger.....
94041	----	" " 94036 with SS567E, 94039 and 94040.....
94039	21476	Driver Finger Driving Pad (rawhide).....
94040	21476	" " " " Plate.....
SS567E	21476	" " " " and Plate Screw.....
94044	21476	Driver Finger Hinge Pin.....
94037	21476	" " Latch.....
SS565E	21476	" " " Screw Stud.....
94038	21476	" " " Spring.....
94051	21476	Gear with 8282, 94032 and 94033.....
94016	21476	" Cover.....
399A	21476	" " Screw (2).....
SS599F	21476	" Screw Stud.....
94048	21476	Pinion.....
SS600F	21476	" Screw Stud.....
80028	21476	" Dowel Pin.....
94052	21476	Hand Attachment complete, Nos. SS565E, SS566C, SS599F, SS600F, 80028, 94016, 94027, 94034, 94037, 94038, 94041, 94044, 94046, 94048, 94050, 94051, 94069 and two each 183E and 399A.....
SS566C	21476	Hand Attachment Screw.....

MOTOR PARTS

No.	Plate	Name
193476	-----	Armature complete for B.R. 3 Motor.....
193477	-----	Armature complete for B.R. 5 Motor.....
193318	20207	Armature complete for B.R. 6 and B.R. 7 Motors.....
193478	-----	Armature complete for B.R. 8 Motor.....
193479	-----	Armature complete for B.R. 9 Motor.....
193480	-----	Armature complete for B.R. 10 and B.R. 92 Motors.....
193481	-----	Armature complete for B.R. 11 and B.R. 12 Motors.....
193482	-----	Armature complete for B.R. 15 Motor.....
193483	-----	Armature complete for B.R. 87 Motor.....
193484	-----	Armature complete for B.R. 90 Motor.....
193230	20207	" Shaft Bearing Sleeve Cap (commutator end).....
194494	20207	Armature Shaft Grease Cup Body (2).....
194490	20207	" " " " Wick (felt) (2).....
194326	20207	Armature Shaft Grease Cup Wick Spring (2).....
191097	20207	Armature Thrust Washer (commutator end) fibre.....
701400	20207	Armature Thrust Washer (pulley end) fibre.....
191098	20207	Armature Thrust Washer (pulley end) (peerless paper).....
193066	20207	Belt (moulded) for Spoked Balance Wheel No. 15282.....
193077	-----	Belt (moulded) for Disc Balance Wheel No. 32672.....
190782	20207	Brush (carbon) for 32 to 145 volts (2)..
192947	-----	" " " 150 to 250 volts (2)..
193229	20207	" Cap (2).....
192083	20207	" Spring (2).....
193228	20207	" Tube (2).....
193238	20207	" " Terminal (2).....
190059	20207	Commutator complete.....
194295	20207	End Covers complete, Nos. two each 194326, 194490 and 194494.....
51206R	20207	End Cover Screw (2).....
193236	20207	Fan.....
193440	-----	Field Coil complete for B.R. 3 Motor...
193443	-----	Field Coil complete for B.R. 5 Motor....
193446	-----	Field Coil complete for B.R. 6 Motor....
193449	20207	Field Coil complete for B.R. 7 Motor....
193452	-----	Field Coil complete for B.R. 8 Motor....

MOTOR PARTS

No.	Plate	Name
193455	-----	Field Coil complete for B.R. 9 Motor....
193458	-----	Field Coil complete for B.R. 10 and B.R. 11 Motors.....
193461	-----	Field Coil complete for B.R. 12 Motor...
193464	-----	Field Coil complete for B.R. 15 Motor...
193467	-----	Field Coil complete for B.R. 87 Motor...
193470	-----	Field Coil complete for B.R. 90 Motor...
193473	-----	Field Coil complete for B.R. 92 Motor...
190563	-----	" " Retainer.....
192240	-----	" " Tube (paper).....
193241	20207	Field Core complete.....
193242	20207	" " Insulation.....
194967	-----	" " Shield (moulded) for B.R. 7 Motor.....
194968	-----	Field Core Shield (moulded) for all B.R. Motors except B.R. 7 Motor.....
192851	-----	Lead Cord complete with Three-Pin Terminal (female half) from lamp socket to Three-Pin Terminal, for knee or treadle control.....
192641	20207	Motor Bracket.....
50632CR	20207	" " Screw.....
190058	20207	" " Retaining Washer (fibre).....
191417	20207	Motor Bracket Screw Washer.....
193287	20207	Motor Bracket complete, Nos. 50632CR, 51208E, 190058, 191417, 192641 and 701513.....
51208E	20207	Motor Screw.....
701513	20207	" " Retaining Washer (fibre)....
193231	20207	Pulley (moulded).....
51207C	20207	" Position Screw.....
51093R	21378	Three-Pin Terminal (female half) Housing Screw (2).....
1768R	21378	Three-Pin Terminal (female half) Housing Screw Nut (2).....
192692	-----	Three-Pin Terminal (female half) Insert Clamp (3).....
194533	-----	Three-Pin Terminal (female half) complete for 192851, Nos. two each 1768R, 51093R and three 192692.....
51582	20207	Three-Pin Terminal Body (male half) Post Thumb Nut (3).....
701719	20207	Three-Pin Terminal Body (male half) Post Washer (3).....
192797	20207	Three-Pin Terminal Body (male half) complete, Nos. three each 51582 and 701719.....
145R	20207	Three-Pin Terminal Body (male half) Screw.....
190613	20207	Tube filled with Singer Motor Lubricant (packed in carton).....

FOOT CONTROLLERS (Bakelite)

No.	Plate	Name
194583	-----	Controller complete, for 32 to 55 volts, A.C. or D.C. Motor, Nos. 194321, 194569, 194573, 194574, 899287, two 964317 and four each 140099R and 194407.....
194584	21378	Controller complete, for 95 to 145 volts, A.C. or D.C. Motor, Nos. 194321, 194570, 194573, 194574, 899815, two 964317 and four each 140099R and 194407.....
194585	-----	Controller complete, for 150 to 250 volts, A.C. or D.C. Motor, Nos. 194321, 194571, 194573, 194574, 899287, two 964317 and four each 140099R and 194407.....
194572	20210	Controller Base.....
194569	-----	" " 194572 with 192211, 194418, 194774, 194775 and two each 23258, 140100R, 140103R, 194404, 194514 and 931090, for 194583.....
194570	-----	Controller Base 194572 with 192140, 194418, 194774, 194775 and two each 23258, 140100R, 140103R, 194404, 194514 and 931090, for 194584.....
194571	-----	Controller Base 194572 with 192141, 194418, 194774, 194775 and two each 23258, 140100R, 140103R, 194404, 194514 and 931090, for 194585.....
194407	21378	Controller Base Cushion (rubber) (4)....
140099R	21378	" " Screw (4).....
194573	21378	" Cover.....
194321	21378	" Foot Pedal.....
194574	21378	Controller Lead Cord complete with Three-Pin Terminal (female half) from lamp socket to Three-Pin Terminal and controller.....
192211	-----	Controller Resistance Unit, for 32 to 55 volts.....
192140	21378	Controller Resistance Unit, for 95 to 145 volts.....
192141	-----	Controller Resistance Unit, for 150 to 250 volts.....
194774	21378	Controller Resistance Unit Adjusting Nut
194775	21378	" " " " " "
		Lock Spring.....
194416	21378	Controller Resistance Unit Bell Crank...

No.	Plate	Name
51340C	21378	Controller Resistance Unit Bell Crank Hinge Screw.....
1607J	21378	Controller Resistance Unit Bell Crank Hinge Screw Nut.....
194404	21378	Controller Resistance Unit Bell Crank Spring (2).....
194402	21378	Controller Resistance Unit Bell Crank Spring Bracket.....
194418	-----	Controller Resistance Unit Bell Crank Spring Bracket 194402 with 194416, 194773 and two each 1607J and 51340C
140100R	-----	Controller Resistance Unit Bell Crank Spring Bracket Screw (2).....
194514	-----	Controller Resistance Unit Bell Crank Spring Bracket Screw Insulating Disc (2).....
140103R	21378	Controller Resistance Unit Screw (2)....
931090	-----	" " " " Washer (asbestos) (2).....
23258	21378	Controller Resistance Unit Screw Washer (steel) (2).....
193384	21378	Controller Resistance Unit Short Circuiting Contact.....
51327J	21378	Controller Resistance Unit Short Circuiting Contact Screw.....
194773	21378	Controller Resistance Unit Yoke.....
51340C	21378	" " " " Hinge Screw.....
1607J	21378	Controller Resistance Unit Yoke Hinge Screw Nut.....
*899815	-----	Name Plate for 194584.....
*899287	-----	" " " 194583 and 194585.....
964317	-----	" " Drive Screw (2).....
51093R	21378	Three-Pin Terminal (female half) Housing Screw (2).....
1768R	21378	Three-Pin Terminal (female half) Housing Screw Nut (2).....
192692	-----	Three-Pin Terminal (female half) Insert Clamp (3).....
194521	21378	Three-Pin Terminal (female half) complete for 194574, Nos. two each 1768R, 51093R and three 192692.....

CONTROLLERS (Bakelite)
CONVERTIBLE FOR FOOT OR KNEE CONTROL
 FOR SETS Nos. 40, 47, 50, 56, 401 AND 402

No.	Plate	Name
194587	-----	Controller complete, for 32 to 55 volts, A.C. or D.C. Motor, Nos. 194321, 194569, 194573, 194579, 899287, two 964317 and four each 140099R and 194407.....
194588	20210	Controller complete, for 95 to 145 volts, A.C. or D.C. Motor, Nos. 194321, 194570, 194573, 194579, 899816, two 964317 and four each 140099R and 194407.....
194589	-----	Controller complete, for 150 to 250 volts, A.C. or D.C. Motor, Nos. 194321, 194571, 194573, 194579, 899287, two 964317 and four each 140099R and 194407.....
194572	20210	Controller Base.....
194569	-----	" " 194572 with 192211, 194418, 194774, 194775 and two each 23258, 140100R, 140103R, 194404, 194514 and 931090, for 194587.....
194570	-----	Controller Base 194572 with 192140, 194418, 194774, 194775 and two each 23258, 140100R, 140103R, 194404, 194514 and 931090, for 194588.....
194571	-----	Controller Base 194572 with 192141, 194418, 194774, 194775 and two each 23258, 140100R, 140103R, 194404, 194514 and 931090, for 194589.....
194407	20210	Controller Base Cushion (rubber) (4)....
140099R	20210	" " Screw (4).....
194573	20210	" Cover.....
194321	20210	" Foot Pedal.....
194579	20210	Controller Lead complete.....
192211	-----	" Resistance Unit, for 32 to 55 volts.....
192140	20210	Controller Resistance Unit, for 95 to 145 volts.....
192141	-----	Controller Resistance Unit, for 150 to 250 volts.....
194774	20210	Controller Resistance Unit Adjusting Nut
194775	20210	" " " " " "
		Lock Spring.....
194416	20210	Controller Resistance Unit Bell Crank...

No.	Plate	Name
51340C	20210	Controller Resistance Unit Bell Crank Hinge Screw.....
1607J	20210	Controller Resistance Unit Bell Crank Hinge Screw Nut (2).....
194404	20210	Controller Resistance Unit Bell Crank Spring (2).....
194402	20210	Controller Resistance Unit Bell Crank Spring Bracket.....
194418	-----	Controller Resistance Unit Bell Crank Spring Bracket 194402 with 194416, 194773 and two each 1607J and 51340C
140100R	-----	Controller Resistance Unit Bell Crank Spring Bracket Screw (2).....
194514	-----	Controller Resistance Unit Bell Crank Spring Bracket Screw Insulating Disc (2).....
140103R	20210	Controller Resistance Unit Screw (2)....
931090	-----	" " " " Washer (asbestos) (2).....
23258	20210	Controller Resistance Unit Screw Washer (steel) (2).....
193384	20210	Controller Resistance Unit Short Circuiting Contact.....
51327J	20210	Controller Resistance Unit Short Circuiting Contact Screw.....
194773	20210	Controller Resistance Unit Yoke.....
51340C	20210	" " " " Hinge Screw.....
1607J	20210	Controller Resistance Unit Yoke Hinge Screw Nut.....
*899816	-----	Name Plate for 194588.....
*899287	-----	" " " 194587 and 194589.....
964317	-----	" " Drive Screw (2).....

CONTROLLER HOLDER

No.	Plate	Name
136136	20211	Controller Holder with four wood screws 3/8 in. No. 4 R.H.M.F., for Bakelite Controllers Nos. 194587 to 194589...

ELECTRICAL TRIMMINGS

No.	Plate	Name
192142	20211	Controller Lead Bushing, for Machine Lifting Plate.....
192143	20211	Controller Lead Bushing Retaining Spring for 192142.....
194546	20211	Controller Lead Tube.....
192918	20211	" " " Clamp.....

KNEE LEVER PARTS

FOR SETS Nos. 40, 47, 50, 56, 401 and 402

No.	Plate	Name
194437	20211	Knee Lever.....
194436	-----	" " 194437 with 1611TM, 140107TM, 194438, 194470 and 194545.....
194549	20211	Knee Lever Connecting Link.....
140105TM	20211	" " " " Hinge Screw..
1550TM	20211	" " " " " " " Nut.....
194438	20211	Knee Lever Extension.....
194550	20211	" " " " Hinged Bracket....
194551	20211	" " " " " " " Frame
194431	-----	" " " " " " " 194551 with 1550TM, 1708J, 140105TM, 140106J, 194434, 194549 and 194550..
140106J	20211	Knee Lever Extension Hinged Bracket Hinge Screw.....
1708J	20211	Knee Lever Extension Hinged Bracket Hinge Screw Nut.....
194434	20211	Knee Lever Extension Hinged Bracket Spring.....
51224TM	20211	Knee Lever Extension Thumb Screw.....
5480	20211	" " " " " Friction Washer.....
140107TM	20211	Knee Lever Hinge Screw.....
194545	20211	" " " " " Friction Washer..
1611TM	20211	" " " " " Nut.....
194470	20211	" " " " " Washer.....
194430	20211	Knee Lever with Controller Operating Unit complete, Nos. 5480, 51224TM, 194431, 194436 and four wood screws 5/8 in. No. 6 R.H.....

TREADLE CONTROLLERS (Bakelite)

FOR STANDS Nos. 25281, 25282 and 25294

No.	Plate	Name
194384	-----	Controller complete, for 32 to 55 volts, A.C. or D.C. Motor, Nos. 194426, 194455, 194491 and two 140102R.....
194385	20212	Controller complete, for 95 to 145 volts, A.C. or D.C. Motor, Nos. 194454, 194455, 194492 and two 140102R
194386	-----	Controller complete, for 150 to 250 volts, A.C. or D.C. Motor, Nos. 194426, 194455, 194493 and two 140102R
194322	20212	Controller Base.....
194491	-----	" " 194322 with 23258, 192211, 193908, 194422, 194479, 194774, 194775 and two each 140100R, 140103R, 194421, 194514 and 931090, for 194384.....
194492	-----	Controller Base 194322 with 23258, 192140, 193908, 194422, 194479, 194774, 194775 and two each 140100R, 140103R, 194421, 194514 and 931090, for 194385
194493	-----	Controller Base 194322 with 23258, 192141, 193908, 194422, 194479, 194774, 194775 and two each 140100R, 140103R, 194421, 194514 and 931090, for 194386
198001	20213	Controller Bracket for Cabinet Tables...
198002	20213	" " " " Cover Sets.....
51119J	20213	" " " " Screw (2).....
194323	-----	" " " " Cover.....
194454	20212	" " " " 194323 with 899691 and two 964317, for 194385.....
194426	-----	Controller Cover 194323 with 899287 and two 964317, for 194384 and 194386...
140102R	20212	Controller Cover Screw (2).....
194455	20212	Controller Lead complete.....
193908	20212	" " " " Clamp.....
194479	20212	" " " " " Insulation.....
192866	20213	" " " " Pitman Rod Connection.....
192211	-----	" " " " Resistance Unit for 32 to 55 volts.....
192140	20212	Controller Resistance Unit for 95 to 145 volts.....
192141	-----	Controller Resistance Unit for 150 to 250 volts.....
194774	20212	Controller Resistance Unit Adjusting Nut
194775	20212	" " " " " " " Lock Spring.....

TREADLE CONTROLLERS

No.	Plate	Name
194416	20212	Controller Resistance Unit Bell Crank...
194324	20212	" " " " "
		Connecting Link.....
140101C	20212	Controller Resistance Unit Bell Crank
		Connecting Link Hinge Screw.....
1607J	20212	Controller Resistance Unit Bell Crank
		Connecting Link Hinge Screw Nut.....
51340C	20212	Controller Resistance Unit Bell Crank
		Hinge Screw.....
1607J	20212	Controller Resistance Unit Bell Crank
		Hinge Screw Nut (2).....
194421	20212	Controller Resistance Unit Bell Crank
		Spring (2).....
194402	20212	Controller Resistance Unit Bell Crank
		Spring Bracket.....
194422	-----	Controller Resistance Unit Bell Crank
		Spring Bracket 194402 with 51340C,
		140101C, 194324, 194416, 194773 and two
		1607J.....
140100R	-----	Controller Resistance Unit Bell Crank
		Spring Bracket Screw (2).....
194514	-----	Controller Resistance Unit Bell Crank
		Spring Bracket Screw Insulating Disc
		(2).....
140103R	20212	Controller Resistance Unit Screw (2)....
931090	-----	" " " " Washer
		(asbestos) (2).....
23258	20212	Controller Resistance Unit Screw Washer
		(steel).....
193384	20212	Controller Resistance Unit Short Circuit-
		ing Contact.....
51327J	20212	Controller Resistance Unit Short Circuit-
		ing Contact Screw.....
194773	20212	Controller Resistance Unit Yoke.....
*899691	-----	Name Plate for 194454.....
*899287	-----	" " " 194426.....
964317	-----	" " Drive Screw (2).....

TREADLE CONTROLLERS (Bakelite)

FOR STANDS Nos. 46909, 46912 and 46913

No.	Plate	Name
194381	-----	Controller complete, for 32 to 55 volts,
		A.C. or D.C. Motor, Nos. 194423,
		194426, 194491 and two 140102R.....
194382	20214	Controller complete, for 95 to 145 volts,
		A.C. or D.C. Motor, Nos. 194423,
		194425, 194492 and two 140102R.....

TREADLE CONTROLLERS

No.	Plate	Name
194383	-----	Controller complete, for 150 to 250
		volts, A.C. or D.C. Motor, Nos.
		194423, 194426, 194493 and two 140102R
194322	20214	Controller Base.....
194491	-----	" 194322 with 23258, 192211,
		193908, 194422, 194479, 194774, 194775,
		two each 140100R, 140103R, 194421,
		194514 and 931090.....
194492	-----	Controller Base 194322 with 23258,
		192140, 193908, 194422, 194479, 194774,
		194775, two each 140100R, 140103R,
		194421, 194514 and 931090.....
194493	-----	Controller Base 194322 with 23258,
		192141, 193908, 194422, 194479, 194774,
		194775, two each 140100R, 140103R,
		194421, 194514 and 931090.....
198162	20215	Controller Bracket for 198164.....
194399	-----	" " " 194468.....
198164	20215	" " 198162 with 198163 and
		three 51119R, for Stands Nos. 46909
		and 46912.....
194468	20215	Controller Bracket 194399 with 126R and
		1549R, for Stand No. 46913.....
198163	20215	Controller Bracket Clamp for 198164.....
51119R	20215	" " " Screw for 198164
		(3).....
126R	20215	Controller Bracket Screw for 194468.....
1549R	20215	" " " Nut for 194468.
194323	-----	" Cover.....
194425	20214	" 194323 with 899688 and
		two 964317, for 194382.....
194426	-----	Controller Cover 194323 with 899287 and
		two 964317, for 194381 and 194383...
140102R	20214	Controller Cover Screw (2).....
194423	20214	Controller Lead complete, from control-
		ler to Three-Pin Terminal.....
193908	20214	Controller Lead Clamp.....
194479	20214	" " " Insulation.....
198169	20215	" Pitman Rod Connection for Stands
		Nos. 46909 and 46912.....
193828	20215	Controller Pitman Rod Connection for
		Stand No. 46913.....
192211	-----	Controller Resistance Unit for 32 to 55
		volts.....
192140	20214	Controller Resistance Unit for 95 to 145
		volts.....
192141	-----	Controller Resistance Unit for 150 to
		250 volts.....
194774	20214	Controller Resistance Unit Adjusting Nut
194775	20214	" " " "
		Lock Spring.....

No.	Plate	Name
194416	20214	Controller Resistance Unit Bell Crank...
194324	20214	" " " " " Con- necting Link.....
140101C	20214	Controller Resistance Unit Bell Crank Connecting Link Hinge Screw.....
1607J	20214	Controller Resistance Unit Bell Crank Connecting Link Hinge Screw Nut.....
51340C	20214	Controller Resistance Unit Bell Crank Hinge Screw.....
1607J	20214	Controller Resistance Unit Bell Crank Hinge Screw Nut (2).....
194421	20214	Controller Resistance Unit Bell Crank Spring (2).....
194402	20214	Controller Resistance Unit Bell Crank Spring Bracket.....
194422	-----	Controller Resistance Unit Bell Crank Spring Bracket 194402 with 51340C, 140101C, 194324, 194416, 194773 and two 1607J.....
140100R	-----	Controller Resistance Unit Bell Crank Spring Bracket Screw (2).....
194514	-----	Controller Resistance Unit Bell Crank Spring Bracket Screw Insulating Disc (2).....
140103R	20214	Controller Resistance Unit Screw (2)....
931090	-----	" " " " Washer (asbestos) (2).....
23258	20214	Controller Resistance Unit Screw Washer (steel).....
193384	20214	Controller Resistance Unit Short Circuit- ing Contact.....
51327J	20214	Controller Resistance Unit Short Circuit- ing Contact Screw.....
194773	20214	Controller Resistance Unit Yoke.....
792R	20215	" Screw.....
*899688	-----	Name Plate for 194425.....
*899287	-----	" " " 194426.....
964317	-----	" " Drive Screw (2).....

ELECTRICAL TRIMMINGS

No.	Plate	Name
192142	20215	Controller Lead Bushing (for Machine Lifting Plate) for Stand No. 46913..
192143	20215	Controller Lead Bushing Retaining Spring for 192142, for Stand No. 46913.....
192912	20215	Controller Lead Tube for Stands Nos. 46909 and 46912.....
192912	20215	Controller Lead Tube (long) for Stand No. 46913.....
192918	20215	Controller Lead Tube Clamp.....

SINGERLIGHTS

SINGERLIGHT No. 193294
FOR THREE-PIN TERMINAL

FOR USE WHEN ARM IS SLOTTED FOR SINGERLIGHT BRACKET

No.	Plate	Name
*193495	-----	Singerlight Bracket.....
193941	21480	" " 193495 with 193942..
*193254	-----	" Lamp Contact Lead Terminal for 194594.....
*193633	-----	Singerlight Lamp Contact Lead Terminal for 193634.....
*193278	-----	Singerlight Lamp Contact Lead Terminal Plate for 193634.....
*193634	-----	Singerlight Lamp Contact Lead Terminal Plate 193278 with 193633, for 194607
51203	21480	Singerlight Lamp Contact Lead Terminal Screw (brass) for 194594 and 194607.
*193253	-----	Singerlight Lamp Contact Plunger.....
*193251	-----	" " " " Bushing
*193252	-----	" " " " Spring (2).....
193829	21480	Singerlight Lead Strain Relief Disc for 194592.....
50566	21480	Singerlight Lead Terminal Screw (brass) for 194592 (2).....
51290	-----	Singerlight Lead Terminal Screw (brass) for 194605.....
193289	21480	Singerlight Lead complete.....
198240	-----	Singerlight Lead complete for Switzer- land.....
198122	-----	Singerlight Lead complete for Denmark...
425001	-----	Singerlight Lead complete for V.D.E....
198131	-----	Singerlight Lead complete for Australia.
193940	21480	" Nipple for 194305.....
193939	-----	" " 194306.....
*193937	-----	" " Cap with 193938.....
193936	21480	" " 193937 with 50564J.....
*193938	-----	Singerlight Nipple Cap Insert.....
50564J	21480	" " " Set Screw.....
193512	21480	" " Insulating Collar....
51602R	21480	" " Nut.....
701909	21480	" " Insulating Washer (fibre).....
193509	21480	Singerlight Nipple Washer (felt) (2)...
193272	21480	" Shade.....
193421	21480	" " 193272 with 193401....

No.	Plate	Name
193437	21480	Singerlight Shade Friction Washer.....
*193267	-----	" " Position Pin (2).....
193401	21480	" " Reflector.....
*194596	-----	" Socket Body with 193255 and two 193251.....
194594	21480	Singerlight Socket Body 194596 with 51399K, 193254, 193256 to 193258, 194659 and two each 51203, 193252, 193253 and 193267, for 194593.....
194607	-----	Singerlight Socket Body 194596 with 51399K, 193257, 193258, 193634, 193635, 194659 and two each 51203, 193252, 193253 and 193267, for 194606
*194593	-----	Singerlight Socket Body 194594 with 194305, for 194592.....
*194606	-----	Singerlight Socket Body 194607 with 194306, for 194605.....
194592	-----	Singerlight Socket and Switch complete, Nos. 193829, 193936, 194593, two 50566 and three 51385CR.....
194605	-----	Singerlight Socket and Switch complete (V.D.E. Type) Nos. 193271, 193936, 194606, two 51290 and three 51385CR.
*193942	-----	Singerlight Steady Pin.....
*193259	-----	" Toggle Switch Contact.....
*193271	-----	" " Flash Disc for 194605.....
*194660	-----	Singerlight Toggle Switch Frame.....
51399K	21480	" " " " Screw...
194599	21480	" " " Operating Lever
*194661	-----	" " " " " "
		Hinge Pin.....
194659	21480	Singerlight Toggle Switch complete, Nos. 193259, 193387, 193765, 194599, 194660, 194661 and 194695.....
*194304	21480	Singerlight Toggle Switch Shell.....
*194305	-----	" " " " 194304 with 51602R, 193512 and 193940, for 194593.....
*194306	-----	Singerlight Toggle Switch Shell 194304 with 51602R, 193512 and 193939, for 194606.....
51385CR	21480	Singerlight Toggle Switch Shell Screw...
*193258	-----	" " " Spring Contact (left).....
*193257	-----	Singerlight Toggle Switch Spring Contact (right).....
51203	21480	Singerlight Toggle Switch Spring Contact (right) Screw (brass).....
*193256	-----	Singerlight Toggle Switch Spring Contact Lead Terminal for 194594.....

No.	Plate	Name
*193633	-----	Singerlight Toggle Switch Spring Contact Lead Terminal for 193635.....
*193276	-----	Singerlight Toggle Switch Spring Contact Lead Terminal Plate for 193635.....
*193635	-----	Singerlight Toggle Switch Spring Contact Lead Terminal Plate 193276 with 193633, for 194607.....
*193255	-----	Singerlight Toggle Switch Spring Contact Lead Terminal Stud.....
*193387	-----	Singerlight Toggle Switch Toggle Lever..
*194695	-----	" " " " " "
		Spring.....
*193765	-----	Singerlight Toggle Switch Toggle Lever Spring Washer.....
193294	21480	Singerlight (moulded, less lamp) com- plete, Nos. 691J, 97359, 193289, 193421, 193437, 193941, 194592, 701909 and two 193509.....
193294	-----	Singerlight (moulded, less lamp) com- plete, Nos. 691J, 97359, 193421, 193437, 193941, 194605, 198240, 701909 and two 193509.....
(Switzerland)		
193294	-----	Singerlight (moulded, less lamp) com- plete, Nos. 691J, 97359, 193421, 193437, 193941, 194605, 198122, 701909 and two 193509.....
(Denmark)		
193294	-----	Singerlight (moulded, less lamp) com- plete, Nos. 691J, 97359, 193421, 193437, 193941, 194605, 425001, 701909 and two 193509.....
(V.D.E.)		
193294	-----	Singerlight (moulded, less lamp) com- plete, Nos. 691J, 97359, 193421, 193437, 193941, 194592, 198131, 701909 and two 193509.....
(Australia)		
691J	21480	Singerlight Screw.....
97359	21480	" " Retaining Washer (fibre).....

SINGERLIGHT No. 193518

FOR USE WHEN ARM IS SLOTTED FOR SINGERLIGHT BRACKET

THIS SINGERLIGHT IS THE SAME AS 193294 WITH THE

FOLLOWING EXCEPTIONS:

No.	Plate	Name
194022	21480	Singerlight Lead Cord (8 ft. long) and Plug complete, in place of 193289...
198246	-----	Singerlight Flexible Lead Cord (8 ft. long) and Plug complete, for Switzerland, in place of 198240.....
198127	-----	Singerlight Flexible Lead Cord (8 ft. long) and Plug complete, for Denmark, in place of 198122.....
198119	-----	Singerlight Flexible Lead Cord (8 ft. long) and Plug complete, for V.D.E., in place of 425001.....
198318	-----	Singerlight Flexible Lead Cord (8 ft. long) and Plug complete, for Australia, in place of 198131.....
193518	21480	Singerlight (moulded, less lamp) complete, Nos. 691J, 97359, 193421, 193437, 193941, 194022, 194592, 701909 and two 193509.....
193518 (Switzerland)	-----	Singerlight (moulded, less lamp) complete, Nos. 691J, 97359, 193421, 193437, 193941, 194605, 198246, 701909 and two 193509.....
193518 (Denmark)	-----	Singerlight (moulded, less lamp) complete, Nos. 691J, 97359, 193421, 193437, 193941, 194605, 198127, 701909 and two 193509.....
193518 (V.D.E.)	-----	Singerlight (moulded, less lamp) complete, Nos. 691J, 97359, 193421, 193437, 193941, 194605, 198119, 701909 and two 193509.....
193518 (Australia)	-----	Singerlight (moulded, less lamp) complete, Nos. 691J, 97359, 193421, 193437, 193941, 194592, 198318, 701909 and two 193509.....

SINGERLIGHT LAMP

No.	Plate	Name
194120	21480	Singerlight Lamp.....

Note: When ordering No. 194120, state voltage required. We are prepared to furnish the following voltages:

32
50
110 to 120
200 to 220
230 to 250

ACCESSORIES

No.	Plate	Name
120862	21479	Oil Can, contents 1 1/3 fl. oz. (filled with household oil).....
120329	-----	Machine Cover.....

ATTACHMENT SET

No.	Plate	Name
8879	21477	Arm Spool Pin Washer (cloth).....
121461	21477	Binder Folder.....
51104B	21477	" " Screw.....
120565	21477	" " Washer.....
121463	21477	" Foot.....
121464	21477	Binder complete, Nos. 51104B, 120565, 121461 and 121463.....
25527	21477	Cloth Guide.....
50053B	21477	" " Thumb Screw.....
35931	21477	Hemmer (adjustable).....
120842	21477	" (foot) flat bottom for 5/64 in. hem.....
25537	21477	Screw Driver (machine).....
120378	21477	" " (shuttle tension).....
2518	21477	Shuttle Bobbin (5).....
36583	21477	Tucker complete.....
120309	-----	Attachment Set, Nos. 8879, 25527, 25537, 35931, 36583, 50053B, 120378, 120842, 121464 and five 2518.....

ATTACHMENT SET

No.	Plate	Name
120598	21477	Ruffler for one, six and twelve stitch ruffling.....
120603	21477	Attachment Set complete, Nos. 120309 and 120598.....

BIAS GAUGE

No.	Plate	Name
25525	21479	Bias Gauge.....

BOBBIN WINDER

FOR BALANCE WHEEL No. 15282 or No. 32672

No.	Plate	Name
15072	21475	Bobbin Position Pin.....
125324	21475	Bracket (belt cover).....
158E	21475	" Screw (2).....
66670	21475	Frame.....
125366	-----	" 66670 with 15288 and 125068.....
51319R	21475	" Hinge Screw.....
66601	21475	" Spring.....
15287	21475	Friction Ring (rubber).....
15288	21475	Pulley.....
125068	21475	Spindle with 15072.....
125376	21475	Stop Latch.....
51303R	21475	" " Hinge Screw.....
66775	21475	" " Spring.....
125395	21475	Tension Bracket.....
45845	21475	" Disc.....
45847	21475	" " Spring.....
1401382B	21475	" Screw.....
45846	21475	" " Washer.....
125396	21475	Tension Bracket complete, Nos. 45845 to 45847, 125395 and 1401382B.....
193B	21475	Tension Bracket Screw.....
7071	21475	" " " Washer.....
125326	21475	Tripping Arm.....
190R	21475	" " Screw.....
125327	21475	Bobbin Winder complete, Nos. 190R, 15287, 51303R, 51319R, 66601, 66775, 125324, 125326, 125366 and 125376.....

BRAIDER

No.	Plate	Name
25510	21478	Braider.....
289B	21478	" Thumb Screw.....

CORDER (Bow)

FOR TOP CORDING

No.	Plate	Name
26399	21479	Corder Bow complete.....
190J	21479	" Screw.....

FELLER (Foot)

No.	Plate	Name
36835	21478	Feller (foot).....

FEED COVER PLATE

No.	Plate	Name
15359	21479	Feed Cover Plate.....

FINGER GUARD

No.	Plate	Name
121725	21478	Finger Guard.....

HEMMER (Foot)

No.	Plate	Name
25893	21478	Hemmer (foot) for 1/4 in. hem.....

HEMSTITCHER

No.	Plate	Name
120687	21478	Hemstitcher with Yielding Presser Plate.

PRESSER FOOT WITH GRADUATED
ADJUSTABLE GUIDES

No.	Plate	Name
121717	21479	Presser Foot.....
35002	21479	" " Extension.....
35003	21479	Presser Foot Graduated Adjustable Guide (long, left).....
35004	21479	Presser Foot Graduated Adjustable Guide (long, right).....
35005	21479	Presser Foot Graduated Adjustable Guide (short, right).....
35006	21479	Presser Foot Graduated Adjustable Guide (short, right) flush.....
35135	21479	Presser Foot Graduated Adjustable Guide Clamp.....
35206	21479	Presser Foot Graduated Adjustable Guide Clamp Lever.....
337D	21479	Presser Foot Graduated Adjustable Guide Clamp Screw.....
121718	21479	Presser Foot with Extension and Gradu- ated Adjustable Guides complete, Nos. 337D, 35002 to 35006, 35135, 35206 and 121717.....

PRESSER FEET

No.	Plate	Name
15429	21478	Presser Foot (needle hole on right hand side) for stitching on edge and in- serting braid.....
125035	21478	Presser Foot (needle hole on left hand side) for stitching on edge and in- serting braid.....
36058	21478	Presser Foot with 665B and 36059, for blind stitch cording, to turn small curves.....

No.	Plate	Name
36059	21478	Presser Foot Cord Guide.....
Note: When ordering No. 36058 or 36059, send sample of cord for which it is to be used.		
665B	21478	Presser Foot Cord Guide Screw.....
2506	21478	Feed Dog for 2831, for 36058.....
2831	21478	Throat Plate, large needle hole, for 2506.....
36067	21478	Presser Foot, for braiding, for art work, for braid 1/16 in. to 3/16 in. wide.....
Note: When ordering No. 36067, state the size or send sample of braid for which it is to be used.		
25978	21478	Presser Foot (single toe) for gathering.
121441	21478	" " (double toe) for gathering.

QUILTER

No.	Plate	Name
35932	21478	Quilter.....

RUFFLER SHIRRING PLATE
(UNIVERSAL)

No.	Plate	Name
121170	21479	Ruffler Shirring Plate (universal) with 51395W.....
51395W	21479	Ruffler Shirring Plate Thumb Screw.....

UNDER BRAIDER

No.	Plate	Name
121547	21479	Under Braider.....
25637	21479	" " Foot.....

SPECIAL ATTACHMENTS

FOR COMPONENT PARTS OF THESE ATTACHMENTS,
REFER TO FORM I9385, LIST OF PARTS FOR SINGER
FASHION AIDS.

No.	Plate	Name
121795	-----	Buttonhole Attachment complete.....
121094	-----	Darning Foot (spring) complete.....
36865	-----	Edge Stitcher.....
26538	-----	Embroidery Attachment complete for one thread.....
35505	-----	Embroidery Attachment complete for two threads.....
121387	-----	Hemstitching and Picoting Attachment complete.....
121634	-----	Needle Threader and Seam Ripper com- plete.....
121255	-----	Singercraft Fagoter complete.....
121079	-----	Singercraft Guide complete.....
35985	-----	Tubular Trimming Attachment complete....
121706	-----	Zigzag Attachment (adjustable) com- plete.....

Genuine Singer Needles should be used
in Singer Machines.
These Needles and their Containers
are marked with the
Company's Trade Mark "SIMANCO" 1

Needles in Containers marked
"For Singer Machines"
are not Singer made needles. 2

NUMERICAL LIST OF PARTS

No.	Plate	Name
126R	20215	Controller Bracket Screw for 194468.....
138E	21471	Arm Screw (2).....
145J	21473	Shuttle Race Screw (2).....
145R	20207	Three-Pin Terminal Body (male half) Screw.....
155C	21471	Needle Bar Connecting Stud Set Screw for 2052.....
157J	21472	Feed Lifting Rock Shaft Crank Clamping Screw for 2509.....
158E	21475	Bobbin Winder Bracket Screw (2).....
183E	21476	Hand Attachment Body Bracket Screw for 94052, for 15-98 Machine (2).....
190B	21474	Face Plate Screw.....
190J	21479	Corder Screw.....
190R	21475	Bobbin Winder Tripping Arm Screw for 125327.....
193B	21475	Bobbin Winder Tension Bracket Screw.....
208E	21474	Feed Dog Screw (2).....
248A	21471	Clamp Stop Motion Clamp Stop Screw for 15314.....
251A	21471	Needle Bar Thread Guard Screw.....
256B	21471	Clamp Stop Motion Clamp Screw for 15314.
289B	21478	Braider Thumb Screw.....
307C	21472	Feed Lifting Rock Shaft Screw Center for 56814.....
307C	21472	Feed Rock Shaft Screw Center for 56814..
307C	21472	Oscillating Rock Shaft Screw Center for 56814.....
337D	21479	Presser Foot Graduated Adjustable Guide Clamp Screw for 121718.....
315C	21472	Feed Bar Screw Center for 15445.....
375C	21471	Crank Connecting Rod Hinge Screw.....
399A	21476	Hand Attachment Gear Cover Screw for 94052, for 15-98 Machine (2).....
435C	21471	Arm Shaft Bushing Set Screw for 125106..
448C	21471	Presser Bar Lifter Hinge Stud Set Screw for 125106.....
453C	21471	Presser Bar Spring Bracket Set Screw for 2068.....
462C	21471	Clamp Stop Motion Flanged Bushing Set Screw for 15313 (2).....
462C	21472	Oscillating Shaft Crank Set Screw for 125059 (2).....
462C	21472	Shuttle Driver Set Screw for 125064 (2)..
552C	21471	Needle Clamp Thumb Screw for 2054.....
SS565E	21476	Hand Attachment Driver Finger Latch Screw Stud for 94052, for 15-98 Ma- chine.....

No.	Plate	Name
SS566C	21476	Hand Attachment Screw for 94052, for 15-98 Machine.....
SS567E	21476	Hand Attachment Driver Finger Driving Pad and Plate Screw for 94041, for 15-98 Machine.....
570C	21471	Needle Bar Connecting Link Hinge Screw for 15434.....
591F	21473	Shuttle Tension Regulating Screw for 15277.....
592E	21473	Shuttle Bobbin Case Latch Stop Screw for 15277.....
SS599F	21476	Hand Attachment Gear Screw Stud for 94052, for 15-98 Machine.....
SS600F	21476	Hand Attachment Pinion Screw Stud for 94052, for 15-98 Machine.....
648J	21473	Shuttle Race Back Spring Screw for 2528.
662J	21473	" " Cap Screw for 15420 (2)....
665B	21478	Presser Foot Cord Guide Screw for 36058.
691A	21474	Throat Plate Screw (2).....
691J	21480	Singerlight Screw for 193294 and 193518.
792R	20215	Controller Screw.....
857B	21474	Thread Take-up Spring Regulator Set Screw for 15432.....
896C	21471	Crank Connecting Rod Cap Screw for 125021.....
1085E	21471	Feed Forked Connection Slide Block Screw Stud for 125335.....
1285C	21471	Feed Cam and Counterbalance Position Screw for 125045.....
1293C	21471	Thread Take-up Cam Position Screw for 15272.....
1381C	21471	Feed Forked Connection Hinge Screw (eccentric).....
1498C	21471	Needle Bar Bushing Set Screw.....
1513J	21472	Feed Lifting Rock Shaft Screw Center Nut for 56814.....
1513J	21472	Feed Rock Shaft Screw Center Nut for 56814.....
1513J	21472	Oscillating Rock Shaft Screw Center Nut for 56814.....
1518J	21471	Crank Connecting Rod Hinge Screw Nut....
1519J	21472	Feed Bar Screw Center Nut for 15445.....
1520J	21471	" Forked Connection Hinge Screw Nut..
1520R	21471	Needle Bar Connecting Link Hinge Screw Nut for 15434.....
1549R	20215	Controller Bracket Screw Nut for 194468.
1550TM	20211	Knee Lever Connecting Link Hinge Screw Nut for 194431.....
1560B	21474	Tension Regulating Thumb Nut for 15471..
1607J	20214	Controller Resistance Unit Bell Crank Connecting Link Hinge Screw Nut for 194422.....

No.	Plate	Name
1607J	20212	Controller Resistance Unit Bell Crank Hinge Screw Nut for 194418 and 194422 (2).....
1607J	21378	Controller Resistance Unit Yoke Hinge Screw Nut for 194418.....
1611TM	20211	Knee Lever Hinge Screw Nut for 194436...
1708J	20211	" " Extension Hinged Bracket Hinge Screw Nut for 194431.....
1768R	21378	Three-Pin Terminal (female half) Housing Screw Nut for 194521 and 194533 (2).
1813	21472	Feed Lifting Rock Shaft Crank Roller and Stud for 2509.....
1822	21471	Thread Take-up Lever Roller and Stud for 15492.....
2002	21471	ARM Dowel Pin (2).....
2007	21471	" Spool Pin.....
2020	21471	Clamp Stop Motion Clamp Washer for 15314
2052	21471	Needle Bar Connecting Stud with 155C, for 15374.....
2054	21471	Needle Clamp with 552C.....
2068	21471	Presser Bar Spring Bracket with 453C....
2070	21471	" " " Washer.....
2102	21474	Tension Disc for 15471.....
2506	21478	Feed Dog for 2831 for 36058.....
2509	21472	" Lifting Rock Shaft Crank with 157J and 1813, for 2836.....
2510	21472	Oscillating Shaft.....
2515	21473	Shuttle Body for 125018.....
2518	21473	" Bobbin for 120309 and 125018....
2528	21473	Shuttle Race complete, Nos. 648J, 2531, 15420, 125080 and two 2532.....
2530	21473	Shuttle Race Body for 15420.....
2531	21473	" " Back for 2528.....
2532	21473	" " " Position Pin for 2528 (2).....
2535	21473	Shuttle Race Cap for 15420.....
2816	21472	Feed Lifting Rock Shaft for 2836.....
2824	21474	Shuttle Race Slide Spring for 15147....
2831	21478	Throat Plate, large needle hole, for 2506.....
2835	21472	Feed Bar.....
2836	-----	Feed Lifting Rock Shaft complete, Nos. 2509 and 2816.....
2973	21473	Shuttle Bobbin Case Latch Lever for 15141.....
2974	21473	Shuttle Bobbin Case Latch Lever Fulcrum Pin for 15141.....
2975	21473	Shuttle Bobbin Case Latch Spring for 15277
5480	20211	Knee Lever Extension Thumb Screw Friction Washer for 194430.....

NUMERICAL LIST OF PARTS

No.	Plate	Name
7071	21475	Bobbin Winder Tension Bracket Screw Washer.....
8217	21471	Feed Regulator Friction Washer.....
8282	21476	Hand Attachment Crank Lever Lock Pin Spring for 94051, for 15-98 Machine.
8879	21471	Arm Spool Pin Washer (cloth) for 120309.
13710	21474	Tension Spring for 15471.....
15072	21475	Bobbin Winder Bobbin Position Pin for 125068.....
15140	21473	Shuttle Bobbin Case Latch for 15141.....
15141	21473	Shuttle Bobbin Case Hinge for 15277, Nos. 2973, 2974 and 15140.....
15147	21474	Shuttle Race Slide complete, Nos. 2824, 15188 and two 51282J.....
15188	21474	Shuttle Race Slide for 15147.....
15238	21474	Tension Releasing Pin for 15471.....
15248	21471	Needle Bar Connecting Link with 51002E, for 15374.....
15272	21471	Thread Take-up Cam with 1293C, for 15434
15277	21473	Shuttle Bobbin Case complete for 125018, Nos. 591F, 592E, 2975, 15141 and 15278.
15278	21473	Shuttle Tension Spring for 15277.....
15279	21474	Feed Dog, 12 teeth (14 teeth to the inch) for 15280, 15316 and 15317....
15280	21474	Throat Plate (medium needle hole) for 15279.....
15282	21471	Balance Wheel, 2 1/4 in. pulley.....
15287	21475	Bobbin Winder Friction Ring (rubber) for 125327.....
15288	21475	Bobbin Winder Pulley for 125366.....
15297	21472	Feed Rock Shaft.....
15313	21471	Clamp Stop Motion Flanged Bushing with two 462C, for 15314.....
15314	21471	Clamp Stop Motion complete, Nos. 248A, 256B, 2020 and 15313.....
15316	-----	Throat Plate, large needle hole, for 15279.....
15317	-----	Throat Plate, small needle hole, for 15279.....
15359	21479	Feed Cover Plate.....
15374	-----	Needle Bar Connecting Link 15248 with 2052.....
15396	21474	Tension Thread Guard for 15428.....
*15404	-----	Trade Mark for 125106.....
15405	-----	" " Rivet for 125106 (2).....
15408	-----	Face Plate Tension Seat for 15428.....
15410	-----	Tension Stud Bushing for 15432.....
15412	21474	Thread Take-up Spring Regulator for 15432.....
15420	21473	Shuttle Race Body 2530 with 2535 and two 662J, for 2528.....

NUMERICAL LIST OF PARTS

No.	Plate	Name
15428	21474	Face Plate Tension Seat 15408 with 15395, for 15432.....
15429	21478	Presser Foot (needle hole on right hand side) for stitching on edge and inserting braid.....
15432	21474	Face Plate with 857B, 15410, 15412, 15428, 50292B and 125423, for 55644.....
15434	-----	Thread Take-up Cam 15272 with 570C and 1520R.....
15445	-----	Feed Bar Screw Center 315C with 1519J (2).....
15471	-----	Tension complete for 55644, Nos. 1560B, 13710, 15238, 32572, 50291W, 55645 and two 2102.....
15486	21471	Presser Bar Lifter Hinge Stud for 125106
15492	21471	Thread Take-up Lever with 1822 and 50527C.....
15498	21471	Arm Shaft Bushing for 125106.....
23258	21378	Controller Resistance Unit Screw Washer (steel) for 194491 to 194493 and 194569 to 194571.....
25510	21478	Braider.....
25525	21479	Bias Gauge.....
25527	21477	Cloth Guide for 120309.....
25537	21477	Screw Driver Machine for 120309.....
25637	21479	Under Braider Foot.....
25693	21478	Hemmer Foot for 1/4 in. hem.....
25978	21478	Presser Foot (single toe) for gathering.
26075	21471	Thread Cutter and Holder.....
26399	21479	Corder Bow complete.....
26538	-----	Embroidery Attachment complete for one thread.....
32572	21474	Tension Releasing Disc for 15471.....
32672	21471	Balance Wheel, 3 1/4 in. pulley, for 15-97 Machine.....
35002	21479	Presser Foot Extension for 121718.....
35003	21479	" " Graduated Adjustable Guide (long, left) for 121718.....
35004	21479	Presser Foot Graduated Adjustable Guide (long, right) for 121718.....
35005	21479	Presser Foot Graduated Adjustable Guide (short, right) for 121718.....
35006	21479	Presser Foot Graduated Adjustable Guide (short, right) flush, for 121718....
35135	21479	Presser Foot Graduated Adjustable Guide Clamp for 121718.....
35206	21479	Presser Foot Graduated Adjustable Guide Clamp Lever for 121718.....
35505	-----	Embroidery Attachment complete for two threads.....

No.	Plate	Name
35931	21477	Hemmer (adjustable) for 120309.....
35932	21478	Quilter.....
35985	-----	Tubular Trimming Attachment complete....
36058	21478	Presser Foot with 665B and 36059 for blind stitch cording to turn small curves.....
36059	21478	Presser Foot Cord Guide for 36058.....
36067	21478	" " for braiding, for art work, for braid 1/16 in. to 3/16 in. wide.
36583	21477	Tucker complete for 120309.....
36835	21478	Feller (foot).....
36865	-----	Edge Stitcher.....
45319	21474	Presser Foot Plate for 45321.....
45320	21474	" " Shank for 45321.....
45321	21474	Presser Foot (hinged) complete, Nos. 45319, 45320 and 45329.....
45329	21474	Presser Foot Hinge Pin for 45321.....
45845	21475	Bobbin Winder Tension Disc for 125396...
45846	21475	" " " Screw Washer for 125396.....
45847	21475	Bobbin Winder Tension Disc Spring for 125396.....
50053B	21477	Cloth Guide Thumb Screw for 120309.....
50291W	21474	Tension Stud for 15471.....
50292B	21474	" " Set Screw for 15432.....
50353E	21471	Feed Regulator Hinge Screw.....
50527C	21471	Thread Take-up Lever Hinge Screw for 15492.....
50564J	21480	Singerlight Nipple Cap Set Screw for 193936.....
50566	21480	Singerlight Lead Terminal Screw (brass) for 194592 (2).....
506320R	20207	Motor Bracket Screw for 193287.....
51002E	21471	Needle Bar Connecting Link Adjusting Screw for 15248.....
51045C	21471	Machine Hinge Connection Set Screw.....
51093R	21378	Three-Pin Terminal (female half) Housing Screw for 194521 and 194533 (2)....
51104B	21477	Binder Folder Screw for 121464.....
51119J	20213	Controller Bracket Screw (2).....
51119R	20215	" " Clamp Screw for 198164 (3).....
51203	21480	Singerlight Lamp Contact Lead Terminal Screw (brass) for 194594 and 194607.
51203	21480	Singerlight Toggle Switch Spring Contact (right) Screw (brass) for 194594 and 194607.....
51206R	20207	End Cover Screw (2).....
51207C	20207	Pulley Position Screw.....
51208B	20207	Motor Screw for 193287.....

No.	Plate	Name
51224B	21471	Arm Side Cover Thumb Screw.....
51224B	21474	Presser Foot Thumb Screw.....
51224TM	20211	Knee Lever Extension Thumb Screw for 194430.....
51225B	21471	Feed Regulator Thumb Screw.....
51228ZJ	21471	Pressure Regulating Thumb Screw for 66773.....
51229E	21472	Shuttle Driver Cushion Spring Screw for 125064 (2).....
51282J	21474	Shuttle Face Slide Spring Screw for 15147.....
51290	-----	Singerlight Lead Terminal Screw (brass) for 194605.....
51303R	21475	Bobbin Winder Stop Latch Hinge Screw for 125327.....
51319R	21475	Bobbin Winder Frame Hinge Screw for 125327.....
51327J	21378	Controller Resistance Unit Short Circuit- ing Contact Screw.....
51340C	21378	Controller Resistance Unit Bell Crank Hinge Screw for 194418 and 194422...
51340C	21378	Controller Resistance Unit Yoke Hinge Screw for 194418.....
51385CR	21480	Singerlight Toggle Switch Shell Screw for 194592 and 194605.....
51395W	21479	Ruffler Shirring Plate Thumb Screw for 121170.....
51399K	21480	Singerlight Toggle Switch Frame Screw for 194594 and 194607.....
51582	20207	Three-Pin Terminal Body (male half) Post Thumb Nut for 192797 (3).....
51602R	21480	Singerlight Nipple Nut for 194305 and 194306.....
55621	21471	Presser Bar Lifter.....
55644	21474	Face Plate complete, Nos.15432 and 15471
55645	21474	Thread Take-up Spring for 15471.....
56814	-----	Feed Lifting Rock Shaft Screw Center 307C with 1513J (2).....
56814	-----	Feed Rock Shaft Screw Center 307C with 1513J (2).....
56814	-----	Oscillating Rock Shaft Screw Center 307C with 1513J (2).....
66601	21475	Bobbin Winder Frame Spring for 125327...
66670	21475	" " " for 125366.....
66752	21471	Pressure Regulating Thumb Screw Plug (felt) for 66773.....
66773	-----	Pressure Regulating Thumb Screw 51228ZJ with 66752.....

NUMERICAL LIST OF PARTS

No.	Plate	Name
66775	21475	Bobbin Winder Stop Latch Spring for 125327.....
80011	21471	Presser Bar Spring.....
80028	21476	Hand Attachment Pinion Dowel Pin for 94052, for 15-98 Machine.....
94016	21476	Hand Attachment Gear Cover for 94052, for 15-98 Machine.....
94027	21476	Hand Attachment Body Bracket for 94052, for 15-98 Machine.....
94028	21476	Hand Attachment Crank Handle (wood) for 94034, for 15-98 Machine.....
94029	21476	Hand Attachment Crank Handle Spindle for 94034, for 15-98 Machine.....
94030	21476	Hand Attachment Crank Handle Spindle Flange (loose) for 94034, for 15-98 Machine.....
94031	21476	Hand Attachment Crank Lever for 94034, for 15-98 Machine.....
94032	21476	Hand Attachment Crank Lever Lock Pin for 94051, for 15-98 Machine.....
94033	21476	Hand Attachment Crank Lever Lock Pin Head for 94051, for 15-98 Machine...
94034	-----	Hand Attachment Crank complete for 94052, for 15-98 Machine, Nos. 94028 to 94031.....
94036	21476	Hand Attachment Driver Finger for 94041, for 15-98 Machine.....
94037	21476	Hand Attachment Driver Finger Latch for 94052, for 15-98 Machine.....
94038	21476	Hand Attachment Driver Finger Latch Spring for 94052, for 15-98 Machine.
94039	21476	Hand Attachment Driver Finger Driving Pad (rawhide) for 94041, for 15-98 Machine.....
94040	21476	Hand Attachment Driver Finger Driving Pad Plate for 94041, for 15-98 Ma- chine.....
94041	-----	Hand Attachment Driver Finger 94036 with SS567E, 94039 and 94040, for 94052, for 15-98 Machine.....
94044	21476	Hand Attachment Driver Finger Hinge Pin for 94052, for 15-98 Machine.....
94046	21476	Hand Attachment Driver for 94052, for 15-98 Machine.....
94048	21476	Hand Attachment Pinion for 94052, for 15-98 Machine.....
94050	21476	Hand Attachment Body for 94052, for 15-98 Machine.....
94051	21476	Hand Attachment Gear with 8282, 94032 and 94033, for 94052, for 15-98 Ma- chine.....

NUMERICAL LIST OF PARTS

No.	Plate	Name
94052	21476	Hand Attachment complete for 15-98 Ma- chine, Nos. SS565E, SS566C, SS599F, SS600F, 80028, 94016, 94027, 94034, 94037, 94038, 94041, 94044, 94046, 94048, 94050, 94051, 94069 and two each 183E and 399A.....
94069	21476	Hand Attachment Crank Hinge Pin for 94052, for 15-98 Machine.....
97359	21480	Singerlight Screw Retaining Washer (fibre) for 193294 and 193518.....
120309	-----	Attachment Set Nos. 8879, 25527, 25537, 35931, 36583, 50053B, 120378, 120842, 121464 and five 2518, for 120603....
120329	-----	Machine Cover (Accessories).....
120378	21477	Screw Driver (shuttle tension) for 120309.....
120565	21477	Binder Folder Screw Washer for 121464...
120603	21477	Attachment Set complete, Nos. 120309 and 120598.....
120687	21478	Hemstitcher with Yielding Presser Plate.
120842	21477	Hemmer Foot (flat bottom) for 5/64 in. hem for 120309.....
120882	21479	Oil Can, contents 1 1/3 fl. oz. (filled with household oil).....
121079	-----	Singercraft Guide complete.....
121094	-----	Darning Foot (spring) complete.....
121170	21479	Ruffler Shirring Plate (universal) with 51395W.....
121255	-----	Singercraft Fagoter complete.....
121387	-----	Hemstitching and Picoting Attachment complete.....
121441	21478	Presser Foot (double toe) for gathering.
121461	21477	Binder Folder for 121464.....
121463	21477	" Foot for 121464.....
121464	21477	Binder complete for 120309, Nos. 51104B, 120565, 121461 and 121463.....
121547	21479	Under Braider.....
121634	-----	Needle Threader and Seam Ripper complete
121706	-----	Zigzag Attachment (adjustable) complete.
121717	21479	Presser Foot for 121718.....
121718	21479	Presser Foot with Extension and Gradu- ated Adjustable Guides complete, Nos. 337D, 35002 to 35006, 35135, 35206 and 121717.....
121725	21478	Finger Guard.....
121795	-----	Buttonhole Attachment complete.....
125018	21473	Shuttle, 1 11/16 in. diam., Nos. 2515, 2518 and 15277.....
125021	21471	Crank Connecting Rod with 125044 and two 896C.....

NUMERICAL LIST OF PARTS

No.	Plate	Name
125035	21478	Presser Foot (needle hole on left hand side) for stitching on edge and inserting braid.....
125042	21471	Arm Shaft.....
125044	21471	Crank Connecting Rod Oil Pad (felt) for 125021.....
125045	21471	Feed Cam and Counterbalance with 1285C..
125046	21471	" Forked Connection for 125085.....
125047	21471	" " " Slide Block for 125335.....
125052	21471	Needle Bar Bushing.....
125055	21472	Oscillating Rock Shaft with 125056.....
125056	21472	" " " Oil Wick (braided cotton) for 125055.....
125057	21472	Oscillating Shaft Crank for 125059.....
125059	-----	" " " 125057 with 125330 and two 462C.....
125061	21471	Presser Bar.....
125064	21472	Shuttle Driver with 125065 and two each 462C and 51229E.....
125065	21472	Shuttle Driver Cushion Spring for 125064
125068	21475	Bobbin Winder Spindle with 15072, for 125366.....
125072	21471	Needle Bar Bushing Oil Pad (felt).....
125079	21471	" Bar.....
125080	21473	Shuttle Race Back Spring for 2528.....
125085	-----	Feed Forked Connection 125046 with 125335.....
125095	21471	Needle Bar Thread Guard.....
125101	21471	Feed Regulator.....
125103	21471	Stitch Indicator.....
125104	21471	" " Plate.....
*125106	-----	Arm with 435C, 448C, 15404, 15486, 15498 and two 15405.....
*125107	-----	Bed.....
125324	21475	Bobbin Winder Bracket (belt cover) for 125327.....
125326	21475	Bobbin Winder Tripping Arm for 125327...
125327	21475	Bobbin Winder complete for Balance Wheel No. 15282 or No. 32672, Nos. 190R, 15287, 51303R, 51319R, 66601, 66775, 125324, 125326, 125366 and 125376...
125330	21472	Oscillating Shaft Crank Slide Block with Stud for 125059.....
125331	21471	Arm Oil Pad (felt) for oiling Arm Shaft Back Bearing.....
125333	21471	Arm Oil Pad Spring.....
125334	21471	" " " Cap.....
125335	-----	Feed Forked Connection Slide Block 125047 with 1085E, for 125085.....

NUMERICAL LIST OF PARTS

No.	Plate	Name
125366	-----	Bobbin Winder Frame 66670 with 15288 and 125068, for 125327.....
125376	21475	* Bobbin Winder Stop Latch for 125327.....
125395	21475	" " Tension Bracket for 125396
125396	21475	Bobbin Winder Tension Bracket complete, Nos. 45845 to 45847, 125396 and 1401382B.....
125422	-----	Face Plate Thread Guard for 125423.....
125423	21474	" " " " 125422 with 125424, for 15432.....
125424	-----	Face Plate Thread Guard Rivet for 125423
125425	21471	Arm Side Cover.....
136136	20211	Controller Holder with four wood screws 3/8 in. No. 4 R.H.M.F. for Bakelite Controllers No. 194587 to 194589....
140099R	21378	Controller Base Screw for 194583 to 194585 and 194587 to 194589 (4)....
140100R	-----	Controller Resistance Unit Bell Crank Spring Bracket Screw for 194491 to 194493 and 194569 to 194571 (2).....
140101C	20212	Controller Resistance Unit Bell Crank Connecting Link Hinge Screw for 194422.....
140102R	20212	Controller Cover Screw for 194381 to 194386 (2).....
140103R	21378	Controller Resistance Unit Screw for 194491 to 194493 and 194569 to 194571 (2).....
140105TM	20211	Knee Lever Connecting Link Hinge Screw for 194431.....
140106J	20211	Knee Lever Extension Hinged Bracket Hinge Screw for 194431.....
140107TM	20211	Knee Lever Hinge Screw for 194436.....
1401382B	21475	Bobbin Winder Tension Screw for 125396..
140202S	21471	Stitch Indicator Plate Screw (2).....
190058	20207	Motor Bracket Screw Retaining Washer (fibre) for 193287.....
190059	20207	Commutator complete.....
190083	20207	Brush Spring (2).....
190563	-----	Field Coil Retainer.....
190613	20207	Tube filled with Singer Motor Lubricant (packed in carton).....
190782	20207	Brush (carbon) for 32 to 145 volts (2)..
191097	20207	Armature Thrust Washer (commutator end) fibre.....
191098	20207	Armature Thrust Washer (pulley end) (peerless paper).....
191417	20207	Motor Bracket Screw Washer for 193287...
192140	21378	Controller Resistance Unit for 95 to 145 volts for 194492 and 194570.....

No.	Plate	Name
192141	-----	Controller Resistance Unit for 150 to 250 volts for 194493 and 194571.....
192142	20211	Controller Lead Bushing (for Machine Lifting Plate) for Stand No. 46913...
192143	20215	Controller Lead Bushing Retaining Spring for 192142, for Stand No. 46913.....
192211	-----	Controller Resistance Unit for 32 to 55 volts for 194491 and 194569.....
192240	-----	Field Coil Tube (paper).....
192641	20207	Motor Bracket for 193287.....
192692	-----	Three-Pin Terminal (female half) Insert Clamp for 194521 and 194533 (3).....
192797	20207	Three-Pin Terminal Body (male half) complete, Nos. three each 51582 and 701719.....
192851	-----	Lead Cord complete with Three-Pin Terminal (female half) from lamp socket to Three-Pin Terminal for knee or treadle control.....
192866	20213	Controller Pitman Rod Connection.....
192912	20215	" Lead Tube for Stands Nos. 46909 and 46912.....
192912	20215	Controller Lead Tube (long) for Stand No. 46913.....
192918	20211	Controller Lead Tube Clamp.....
192947	-----	Brush Carbon for 150 to 250 volts (2)...
193066	20207	Belt (moulded) for Spoked Balance Wheel No. 15282.....
193077	-----	Belt (moulded) for Disc Balance Wheel No. 32872.....
193228	20207	Brush Tube (2).....
193229	20207	" Cap (2).....
193230	20207	Armature Shaft Bearing Sleeve Cap (commutator end).....
193231	20207	Pulley (moulded).....
193236	20207	Fan.....
193238	20207	Brush Tube Terminal (2).....
193241	20207	Field Core complete.....
193242	20207	" " Insulation.....
*193251	-----	Singerlight Lamp Contact Plunger Bushing for 194596.....
*193252	-----	Singerlight Lamp Contact Plunger Spring for 194594 and 194607 (2).....
*193253	-----	Singerlight Lamp Contact Plunger for 194594 and 194607.....
*193254	-----	Singerlight Lamp Contact Lead Terminal for 194594.....
*193255	-----	Singerlight Toggle Switch Spring Contact Lead Terminal Stud for 194596.....
*193256	-----	Singerlight Toggle Switch Spring Contact Lead Terminal for 194594.....

No.	Plate	Name
*193257	-----	Singerlight Toggle Switch Spring Contact (right) for 194594 and 194607.....
*193258	-----	Singerlight Toggle Switch Spring Contact (left) for 194594 and 194607.....
*193259	-----	Singerlight Toggle Switch Contact for 194659.....
*193267	-----	Singerlight Shade Position Pin for 194594 and 194607 (2).....
*193271	-----	Singerlight Toggle Switch Flash Disc for 194606.....
193272	21480	Singerlight Shade for 193421.....
*193276	-----	" Toggle Switch Spring Contact Lead Terminal Plate for 193635.....
*193278	-----	Singerlight Lamp Contact Lead Terminal Plate for 193634.....
193287	20207	Motor Bracket complete, Nos. 50632CR, 51208B, 190058, 191417, 192641 and 701513.....
193289	21480	Singerlight Lead complete for 193294....
193294	21480	Singerlight (moulded, less lamp) complete, Nos. 691J, 97359, 193289, 193421, 193437, 193941, 194592, 701909 and two 193509.....
193294	-----	Singerlight (moulded, less lamp) complete, Nos. 691J, 97359, 193421, 193437, 193941, 194605, 198240, 701909 and two 193509.....
193294	-----	(Switzerland)
193294	-----	Singerlight (moulded, less lamp) complete, Nos. 691J, 97359, 193421, 193437, 193941, 194605, 198122, 701909 and two 193509.....
193294	-----	(Denmark)
193294	-----	Singerlight (moulded, less lamp) complete, Nos. 691J, 97359, 193421, 193437, 193941, 194605, 425001, 701909 and two 193509.....
193294	-----	(Australia)
193294	-----	Singerlight (moulded, less lamp) complete, Nos. 691J, 97359, 193421, 193437, 193941, 194592, 198131, 701909 and two 193509.....
193318	20207	Armature complete for B.R. 6 and B.R. 7 Motors.....
193384	21378	Controller Resistance Unit Short Circuiting Contact.....
*193387	-----	Singerlight Toggle Switch Toggle Lever for 194659.....
193401	21480	Singerlight Shade Reflector for 193421..
193421	21480	" " 193272 with 193401 for 193294 and 193518.....
193437	21480	Singerlight Shade Friction Washer for 193294 and 193518.....

No.	Plate	Name
193440	-----	Field Coil complete for B.R. 3 Motor....
193443	-----	Field Coil complete for B.R. 5 Motor....
193446	-----	Field Coil complete for B.R. 6 Motor....
193449	20207	Field Coil complete for B.R. 7 Motor....
193452	-----	Field Coil complete for B.R. 8 Motor....
193455	-----	Field Coil complete for B.R. 9 Motor....
193458	-----	Field Coil complete for B.R. 10 and B.R. 11 Motors.....
193461	-----	Field Coil complete for B.R. 12 Motor....
193464	-----	Field Coil complete for B.R. 15 Motor...
193467	-----	Field Coil complete for B.R. 87 Motor...
193470	-----	Field Coil complete for B.R. 90 Motor...
193473	-----	Field Coil complete for B.R. 92 Motor...
193476	-----	Armature complete for B.R. 3 Motor.....
193477	-----	Armature complete for B.R. 5 Motor.....
193478	-----	Armature complete for B.R. 8 Motor.....
193479	-----	Armature complete for B.R. 9 Motor.....
193480	-----	Armature complete for B.R. 10 and B.R. 92 Motors.....
193481	-----	Armature complete for B.R. 11 and B.R. 12 Motors.....
193482	-----	Armature complete for B.R. 15 Motor.....
193483	-----	Armature complete for B.R. 87 Motor.....
193484	-----	Armature complete for B.R. 90 Motor.....
*193495	-----	Singerlight Bracket for 193941.....
193509	21480	" Nipple Washer (felt) for 193294 and 193518 (2).....
193512	21480	Singerlight Nipple Insulating Collar for 194305 and 194306.....
193518	21480	Singerlight (moulded, less lamp) com- plete, Nos.691J,97359,193421,193437, 193941,194022,194592,701909 and two 193509.....
193518	-----	Singerlight (moulded, less lamp) com- plete, Nos.691J,97359,193421,193437, 193941,194605,198246,701909 and two 193509.....
(Switzerland)		
193518	-----	Singerlight (moulded, less lamp) com- plete, Nos.691J,97359,193421,193437, 193941,194605,198127,701909 and two 193509.....
(Denmark)		
193518	-----	Singerlight (moulded, less lamp) com- plete, Nos.691J,97359,193421,193437, 193941,194605,198119,701909 and two 193509.....
(V.D.E.)		
193518	-----	Singerlight (moulded, less lamp) com- plete, Nos.691J,97359,193421,193437, 193941,194592,198318,701909 and two 193509.....
(Australia)		
*193633	-----	Singerlight Lamp Contact Lead Terminal for 193634.....

No.	Plate	Name
*193633	-----	Singerlight Toggle Switch Spring Contact Lead Terminal for 193635.....
*193634	-----	Singerlight Lamp Contact Lead Terminal Plate 193278 with 193633, for 194607
*193635	-----	Singerlight Toggle Switch Spring Contact Lead Terminal Plate 193276 with 193633, for 194607.....
*193765	-----	Singerlight Toggle Switch Toggle Lever Spring Washer for 194659.....
193828	20215	Controller Pitman Rod Connection for Stand No. 46913.....
193829	21480	Singerlight Lead Strain Relief Disc for 194592.....
193908	20212	Controller Lead Clamp for 194491 to 194493.....
193936	21480	Singerlight Nipple Cap 193937 with 50564J, for 194592 and 194605.....
*193937	-----	Singerlight Nipple Cap with 193938, for 193936.....
*193938	-----	Singerlight Nipple Cap Insert for 193937
193939	-----	" " for 194306.....
193940	21480	" " for 194305.....
193941	21480	" Bracket 193495 with 193942, for 193294 and 193518.....
*193942	-----	Singerlight Steady Pin for 193941.....
194022	21480	Singerlight Lead Cord (8 ft. long) and Plug complete for 193518.....
194120	21480	Singerlight Lamp.....
Note: When ordering 194120, state voltage required.		
194295	20207	End Covers complete, Nos. two each 194326, 194490 and 194494.....
*194304	21480	Singerlight Toggle Switch Shell for 194305 and 194306.....
*194305	-----	Singerlight Toggle Switch Shell 194304 with 51602R, 193512 and 193940, for 194593.....
*194306	-----	Singerlight Toggle Switch Shell 194304 with 51602R, 193512 and 193939, for 194606.....
194321	21378	Controller Foot Pedal for 194583 to 194585 and 194587 to 194589.....
194322	20212	Controller Base for 194491 to 194493....
194323	-----	" Cover for 194425, 194426 and 194454.....
194324	20212	Controller Resistance Unit Bell Crank Connecting Link for 194422.....

NUMERICAL LIST OF PARTS

No.	Plate	Name
194326	20207	Armature Shaft Grease Cup Wick Spring for 194295 (2).....
Nos. 194381 to 194383 for Stands Nos. 46909, 46912 and 46913		
194381	-----	Controller complete for 32 to 55 volts, A.C. or D.C. Motor, Nos. 194423, 194426, 194491 and two 140102R.....
194382	20214	Controller complete for 95 to 145 volts, A.C. or D.C. Motor, Nos. 194423, 194425, 194492 and two 140102R.....
194383	-----	Controller complete for 150 to 250 volts, A.C. or D.C. Motor, Nos. 194423, 194426, 194493 and two 140102R
Nos. 194384 to 194386 for Stands No. 25281, 25282 and 25294		
194384	-----	Controller complete for 32 to 55 volts, A.C. or D.C. Motor, Nos. 194426, 194455, 194491 and two 140102R.....
194385	20212	Controller complete for 95 to 145 volts, A.C. or D.C. Motor, Nos. 194454, 194435, 194492 and two 140102R.....
194386	-----	Controller complete for 150 to 250 volts, A.C. or D.C. Motor, Nos. 194426, 194455, 194493 and two 140102R
194399	-----	Controller Bracket for 194468.....
194402	21378	" Resistance Unit Bell Crank Spring Bracket for 194418 and 194422
194404	21378	Controller Resistance Unit Bell Crank Spring for 194569 to 194571 (2).....
194407	21378	Controller Base Cushion (rubber) for 194583 to 194585, 194587 to 194589 (4).....
194416	21378	Controller Resistance Unit Bell Crank for 194418 and 194422.....
194418	-----	Controller Resistance Unit Bell Crank Spring Bracket 194402 with 194416, 194773 and two each 1607J and 51340C, for 194569 to 194571.....
194421	20212	Controller Resistance Unit Bell Crank Spring for 194491 to 194493 (2).....
194422	-----	Controller Resistance Unit Bell Crank Spring Bracket 194402 with 51340C, 140101C, 194324, 194416, 194773 and two 1607J, for 194491 to 194493.....
194423	20214	Controller Lead complete from Controller to Three-Pin Terminal for 194381 to 194383.....

NUMERICAL LIST OF PARTS

No.	Plate	Name
194425	20214	Controller Cover 194323 with 899688 and two 964317, for 194382.....
194426	-----	Controller Cover 194323 with 899287 and two 964317, for 194381, 194383, 194384 and 194386.....
194430	20211	Knee Lever with Controller Operating Unit complete for Sets Nos. 40, 47, 50, 56, 401 and 402, Nos. 5480, 51224TM, 194431, 194436 and four wood screws 5/8 in. No. 6 R.H.....
194431	-----	Knee Lever Extension Hinged Bracket Frame 194551 with 1550TM, 1708J, 140105TM, 140106J, 194434, 194549 and 194550, for 194430.....
194434	20211	Knee Lever Extension Hinged Bracket Spring for 194431.....
194436	-----	Knee Lever 194437 with 1611TM, 140107TM, 194438, 194470 and 194545, for 194430
194437	20211	Knee Lever for 194436.....
194438	20211	" " Extension for 194436.....
194454	20212	Controller Cover 194323 with 899691 and two 964317, for 194385.....
194455	20212	Controller Lead complete for 194384 to 194386.....
194468	20215	Controller Bracket 194399 with 126R and 1549R, for Stand No. 46913.....
194470	20211	Knee Lever Hinge Screw Washer for 194436
194479	20212	Controller Lead Clamp Insulation for 194491 to 194493.....
194490	20207	Armature Shaft Grease Cup Wick (felt) for 194295 (2).....
194491	-----	Controller Base 194322 with 23258, 192211, 193908, 194422, 194479, 194774, 194775, two each 140100R, 140103R, 194421, 194514 and 931090, for 194381 and 194384.....
194492	-----	Controller Base 194322 with 23258, 192140, 193908, 194422, 194479, 194774, 194775, two each 140100R, 140103R, 194421, 194514 and 931090, for 194382 and 194385.....
194493	-----	Controller Base 194322 with 23258, 192141, 193908, 194422, 194479, 194774, 194775, two each 140100R, 140103R, 194421, 194514 and 931090, for 194383 and 194386.....
194494	20207	Armature Shaft Grease Cup Body for 194295 (2).....
194514	-----	Controller Resistance Unit Bell Crank Spring Bracket Screw Insulating Disc for 194491 to 194493 and 194569 to 194571 (2).....

No.	Plate	Name
194521	21378	Three-Pin Terminal (female half) complete for 194574, Nos. two each 1768R, 51093R and three 192692.....
194533	-----	Three-Pin Terminal (female half) complete for 192851, Nos. two each 1768R, 51093R and three 192692.....
194545	20211	Knee Lever Hinge Screw Friction Washer for 194436.....
194546	20211	Controller Lead Tube.....
194549	20211	Knee Lever Connecting Link for 194431...
194550	20211	" " Extension Hinged Bracket for 194431.....
194551	20211	Knee Lever Extension Hinged Bracket Frame for 194431.....
194569	-----	Controller Base 194572 with 192211, 194418, 194774, 194775 and two each 23258, 140100R, 140103R, 194404, 194514 and 931090, for 194583 and 194587...
194570	-----	Controller Base 194572 with 192140, 194418, 194774, 194775 and two each 23258, 140100R, 140103R, 194404, 194514 and 931090, for 194584 and 194588...
194571	-----	Controller Base 194572 with 192141, 194418, 194774, 194775 and two each 23258, 140100R, 140103R, 194404, 194514 and 931090, for 194585 and 194589...
194572	20210	Controller Base for 194569 to 194571....
194573	21378	" Cover for 194583 to 194585 and 194587 to 194589.....
194574	21378	Controller Lead Cord complete with Three-Pin Terminal (female half) from lamp socket to Three-Pin Terminal and controller for 194583 to 194585.....
194579	20210	Controller Lead Complete for 194587 to 194589.....
194583	-----	Controller complete for 32 to 55 volts, A.C. or D.C. Motor, Nos. 194321, 194569, 194573, 194574, 899287, two 964317 and four each 140099R and 194407.....
194584	21378	Controller complete for 95 to 145 volts, A.C. or D.C. Motor, Nos. 194321, 194570, 194573, 194574, 899815, two 964317 and four each 140099R and 194407.....

No.	Plate	Name
194585	-----	Controller complete for 150 to 250 volts, A.C. or D.C. Motor, Nos. 194321, 194571, 194573, 194574, 899287, two 964317 and four each 140099R and 194407.....
		Nos. 194587 to 194589 for Electric Cabinet Table Sets Nos. 40, 47, 50, 56, 401 and 402, Convertible for Foot or Knee Control
194587	-----	Controller complete for 32 to 55 volts, A.C. or D.C. Motor, Nos. 194321, 194569, 194573, 194579, 899287, two 964317 and four each 140099R and 194407.....
194588	20210	Controller complete for 95 to 145 volts, A.C. or D.C. Motor, Nos. 194321, 194570, 194573, 194579, 899816, two 964317 and four each 140099R and 194407.....
194589	-----	Controller complete for 150 to 250 volts, A.C. or D.C. Motor, Nos. 194321, 194571, 194573, 194579, 899287, two 964317 and four each 140099R and 194407.....
194592	-----	Singerlight Socket and Switch complete for 193294 and 193518, Nos. 193829, 193936, 194593, two 50566 and three 51385CR.....
*194593	-----	Singerlight Socket Body 194594 with 194306, for 194592.....
194594	21480	Singerlight Socket Body 194596 with 51399K, 193254, 193256 to 193258, 194659 and two each 51203, 193252, 193253 and 193267, for 194593.....
*194596	-----	Singerlight Socket Body with 193255 and two 193251, for 194594 and 194607...
194599	21480	Singerlight Toggle Switch Operating Lever for 194659.....
194605	-----	Singerlight Socket and Switch complete (V.D.E. Type) for 193294 and 193518, Nos. 193271, 193936, 194606, two 51290 and three 51385CR.....
*194606	-----	Singerlight Socket Body 194607 with 194306, for 194605.....
194607	-----	Singerlight Socket Body 194596 with 51399K, 193257, 193258, 193634, 193635, 194659 and two each 51203, 193252, 193253 and 193267, for 194606.....

NUMERICAL LIST OF PARTS

No.	Plate	Name
194659	21480	Singerlight Toggle Switch complete for 194594 and 194607, Nos. 193259, 193387, 193765, 194599, 194660, 194661 and 194695.....
*194660	-----	Singerlight Toggle Switch Frame for 194659.....
*194661	-----	Singerlight Toggle Switch Operating Lever Hinge Pin for 194659.....
*194695	-----	Singerlight Toggle Switch Toggle Lever Spring for 194659.....
194773	21378	Controller Resistance Unit Yoke for 194418 and 194422.....
194774	21378	Controller Resistance Unit Adjusting Nut for 194491 to 194493 and 194569 to 194571.....
194775	21378	Controller Resistance Unit Adjusting Nut Lock Spring for 194491 to 194493 and 194569 to 194571.....
194967	-----	Field Core Shield (moulded) for B.R. 7 Motor.....
194968	-----	Field Core Shield (moulded) for all B.R. Motors except B.R. 7 Motor.....
198001	20213	Controller Bracket for Cabinet Tables...
198002	20213	" " " Cover Sets.....
198119	-----	Singerlight Flexible Lead Cord (8 ft. long) and Plug complete for V.D.E., for 193518.....
198122	-----	Singerlight Lead complete for Denmark for 193294.....
198127	-----	Singerlight Flexible Lead Cord (8 ft. long) and Plug complete for Denmark, for 193518.....
198131	-----	Singerlight Lead complete for Australia, for 193294.....
198162	20215	Controller Bracket for 198164.....
198163	20215	" " Clamp for 198164.....
198164	20215	" " 198162 with 198163 and three 51119R, for Stands Nos. 46909 and 46912.....
198169	20215	Controller Pitman Rod Connection for Stands Nos. 46909 and 46912.....
198240	-----	Singerlight Lead complete for Switzerland for 193294.....
198246	-----	Singerlight Flexible Lead Cord (8 ft. long) and Plug complete, for Switzerland, for 193518.....
198318	-----	Singerlight Flexible Lead Cord (8 ft. long) and Plug complete for Australia, for 193518.....
425001	-----	Singerlight Lead complete for V.D.E., for 193294.....

NUMERICAL LIST OF PARTS

No.	Plate	Name
701400	20207	Armature Thrust Washer (pulley end) fibre.....
701513	20207	Motor Screw Retaining Washer (fibre) for 193287.....
701719	20207	Three-Pin Terminal Body (male half) Post Washer for 192797 (3).....
701909	21480	Singerlight Nipple Nut Insulating Washer (fibre) for 193294 and 193518.....
*899287	-----	Name Plate for 194426, 194583, 194585, 194587 and 194589.....
*899688	-----	Name Plate for 194425.....
*899691	-----	" " for 194454.....
*899815	-----	" " for 194584.....
*899816	-----	" " for 194588.....
931090	-----	Controller Resistance Unit Screw Washer (asbestos) for 194491 to 194493 and 194569 to 194571 (2).....
964317	-----	Name Plate Drive Screw for 194425, 194426, 194454, 194583 to 194585 and 194587 to 194589 (2).....

**Genuine Singer Needles should be used
in Singer Machines.
These Needles and their Containers
are marked with the
Company's Trade Mark "SIMANCO." 1**

**Needles in Containers marked
"For Singer Machines"
are not Singer made needles. 2**

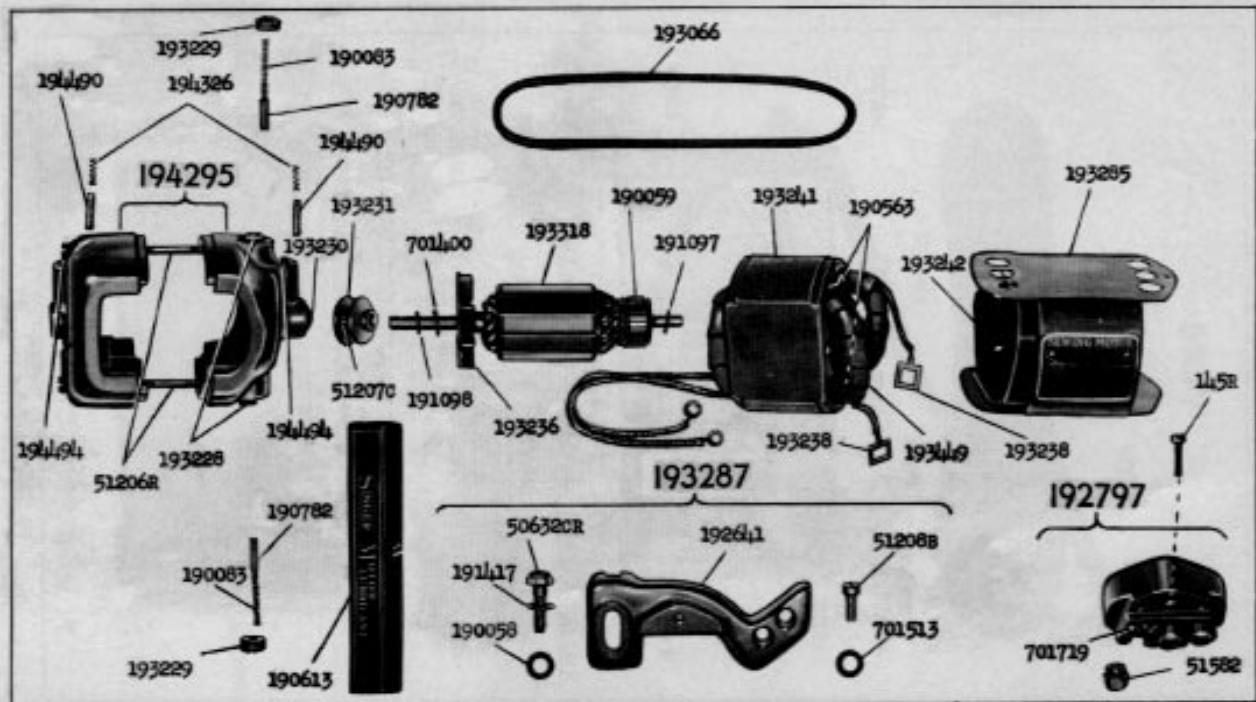

20207 - 1/3

20210 - 1/2

194588

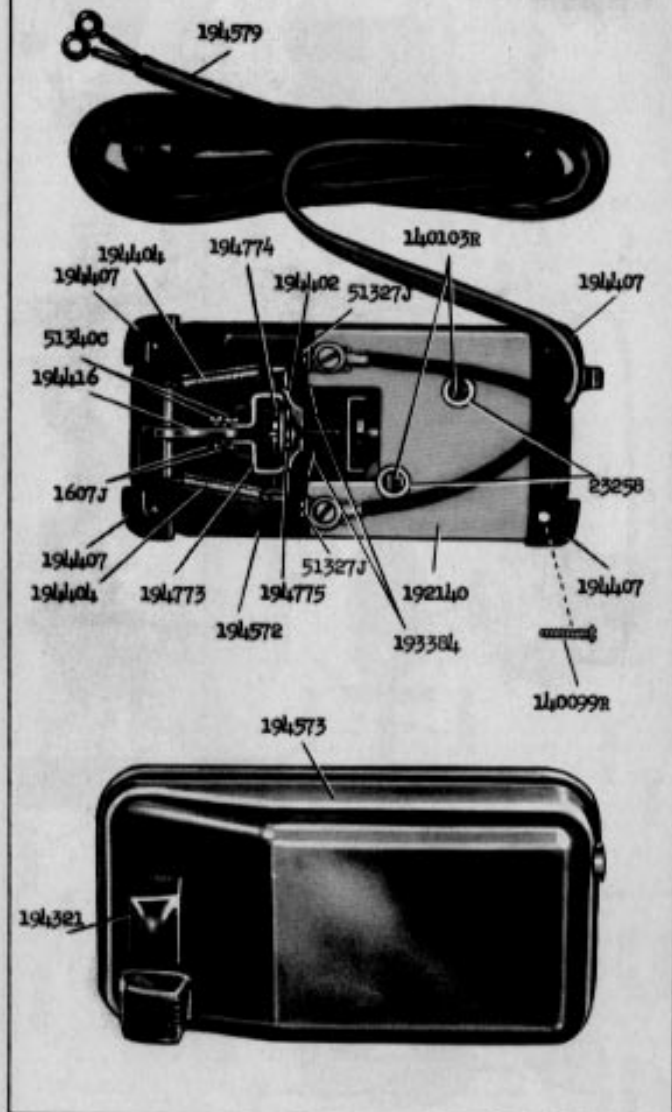

20211 - 1/2

194430

194474

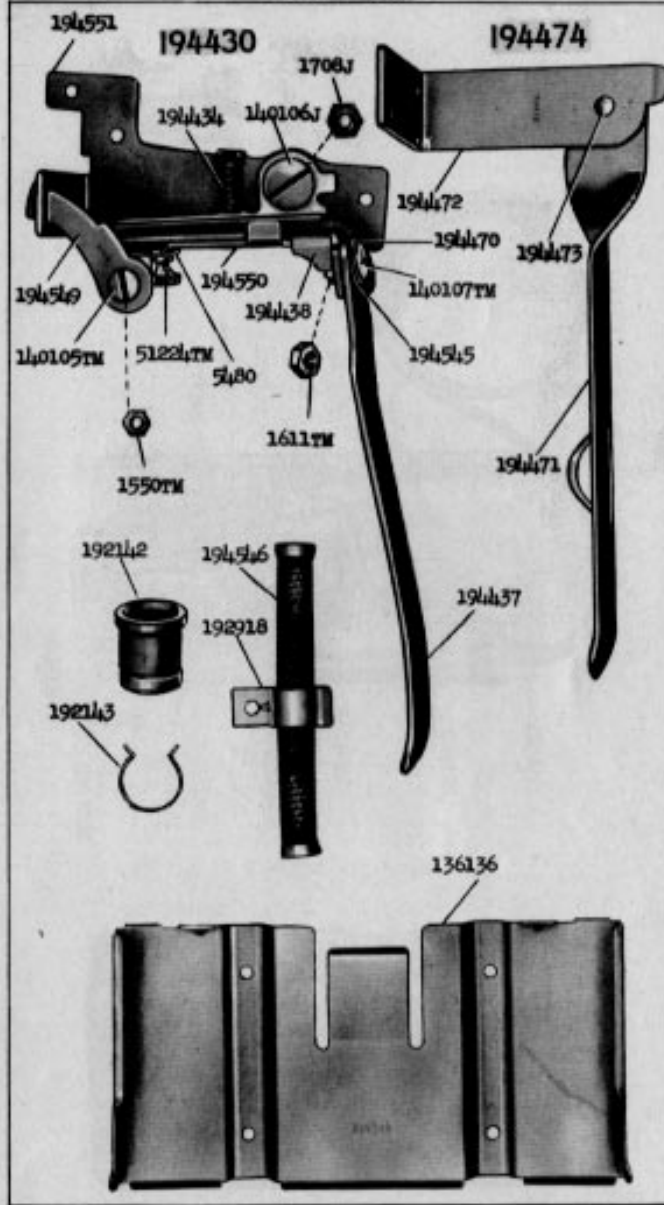

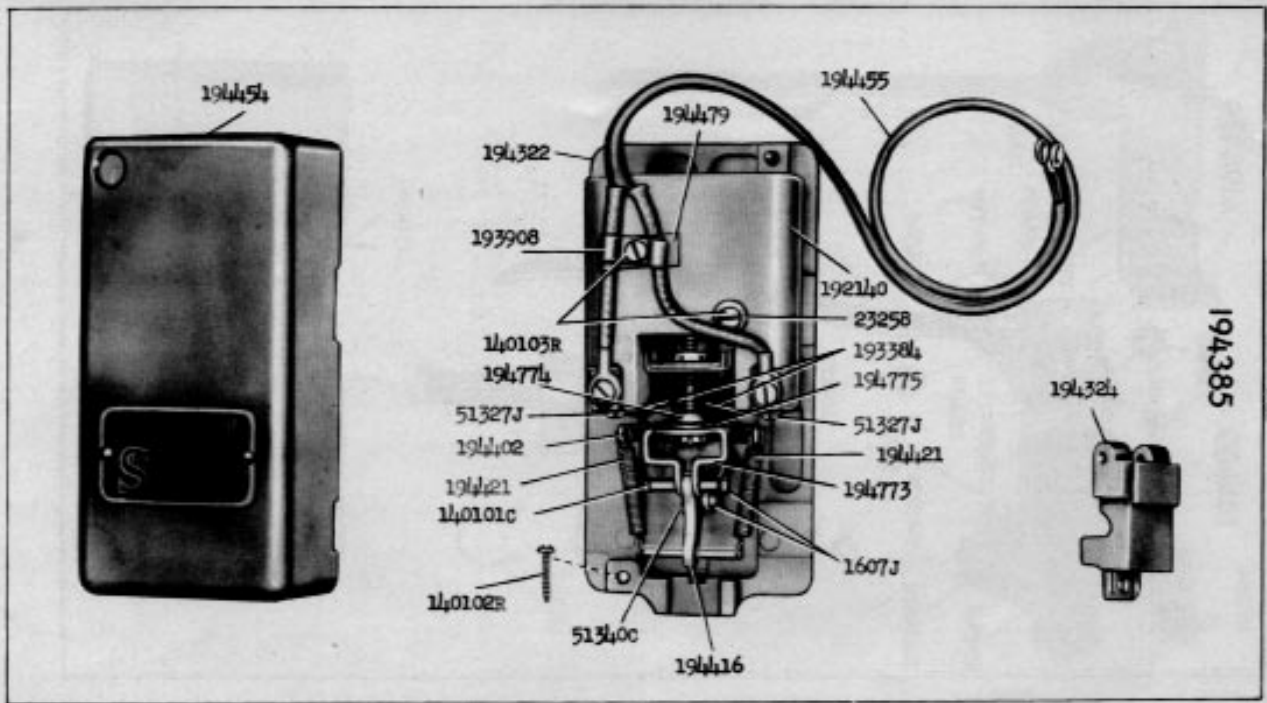

20213 - 2/3

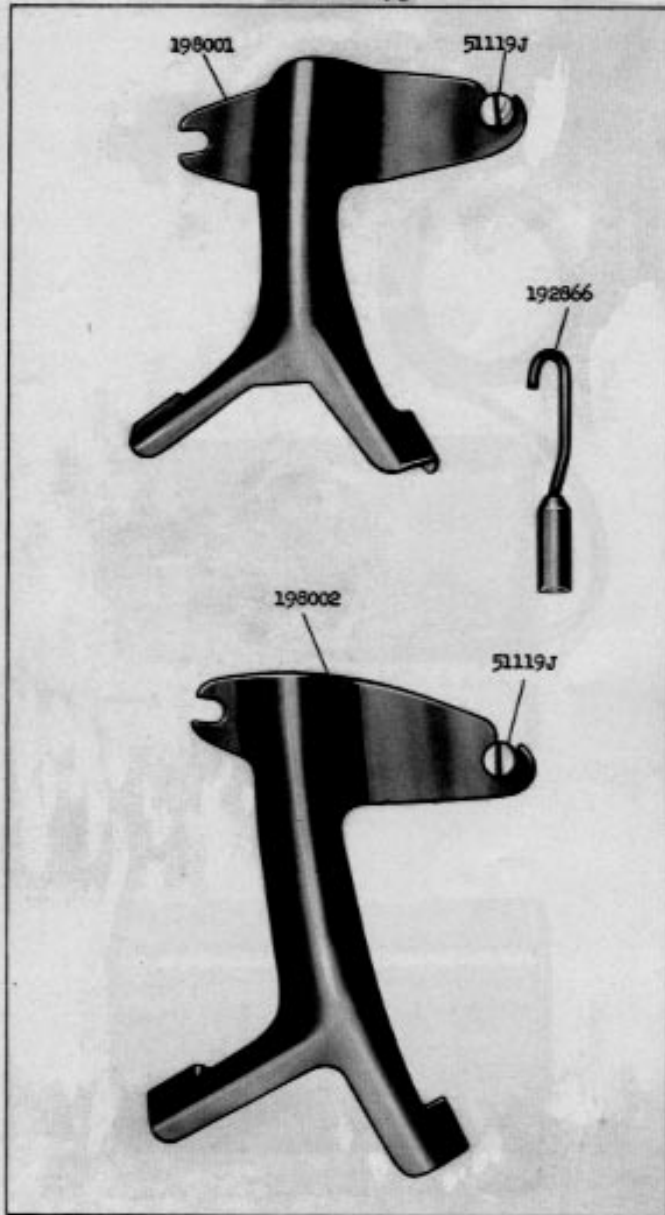

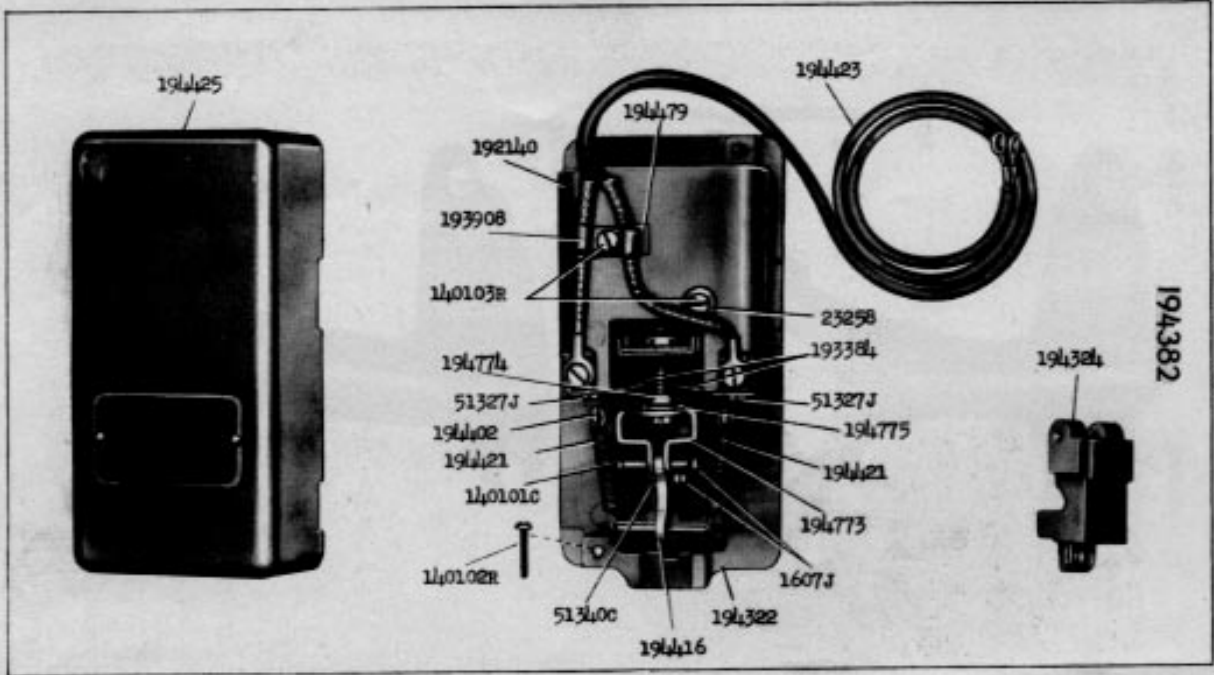

20215 - 1/2

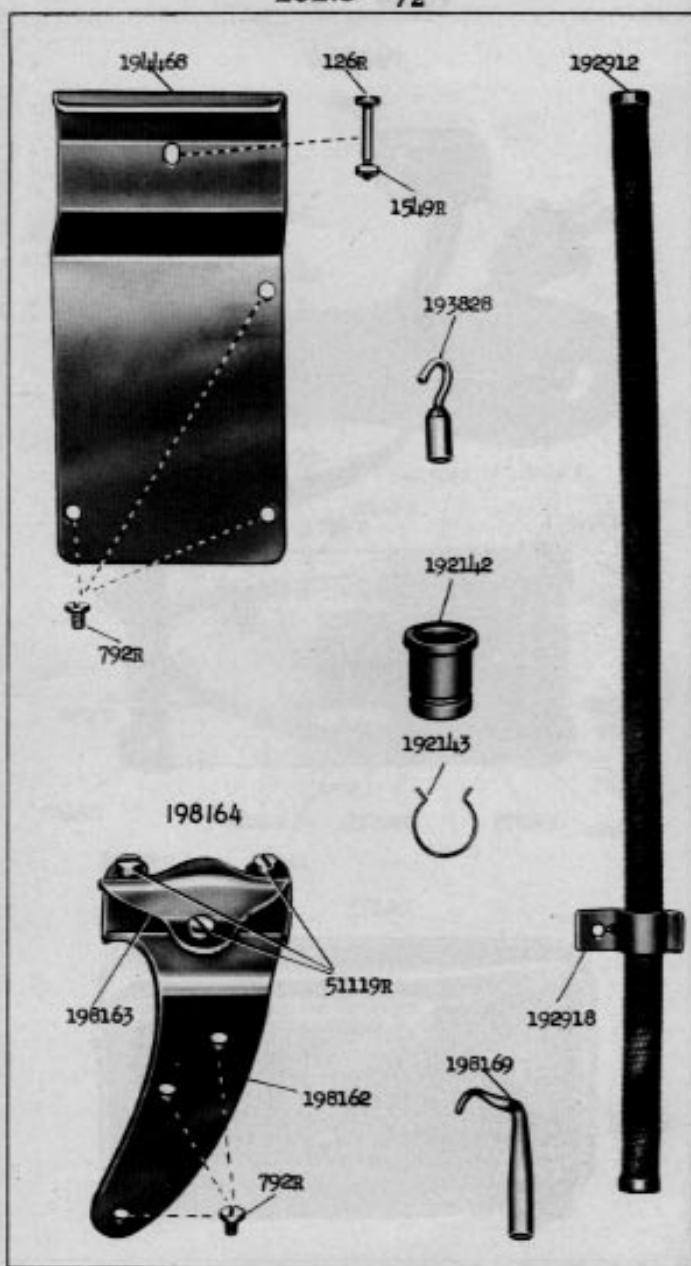

21378 - 1/2

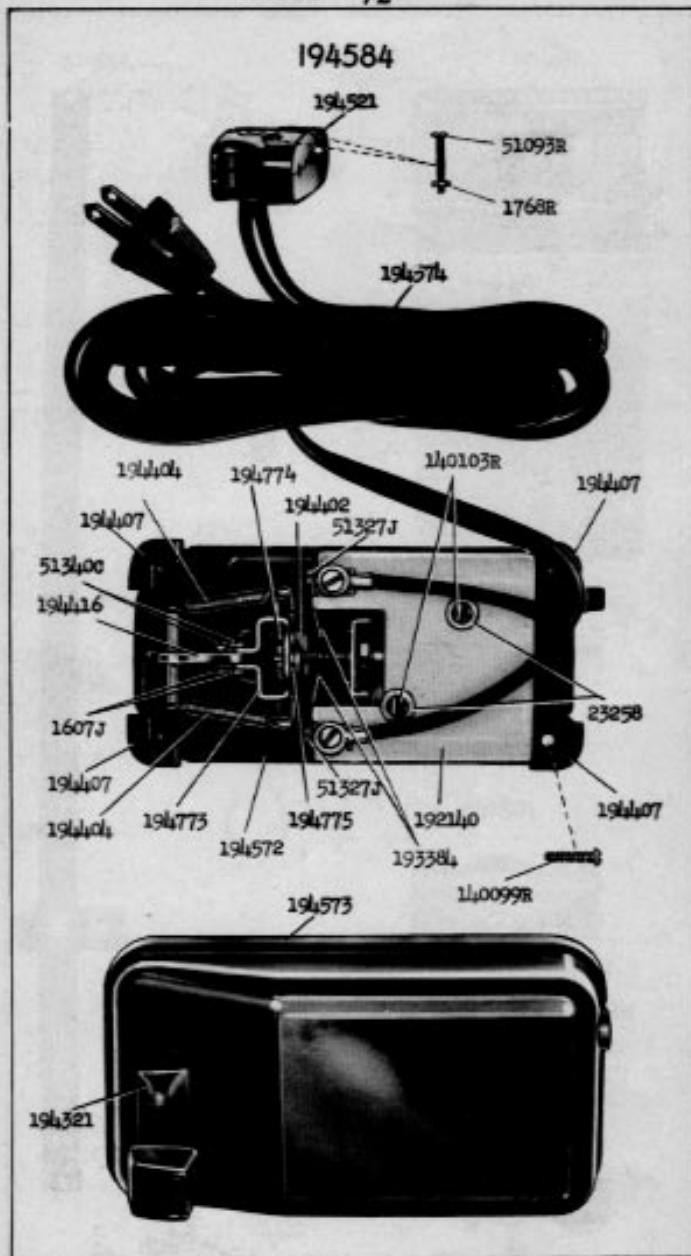

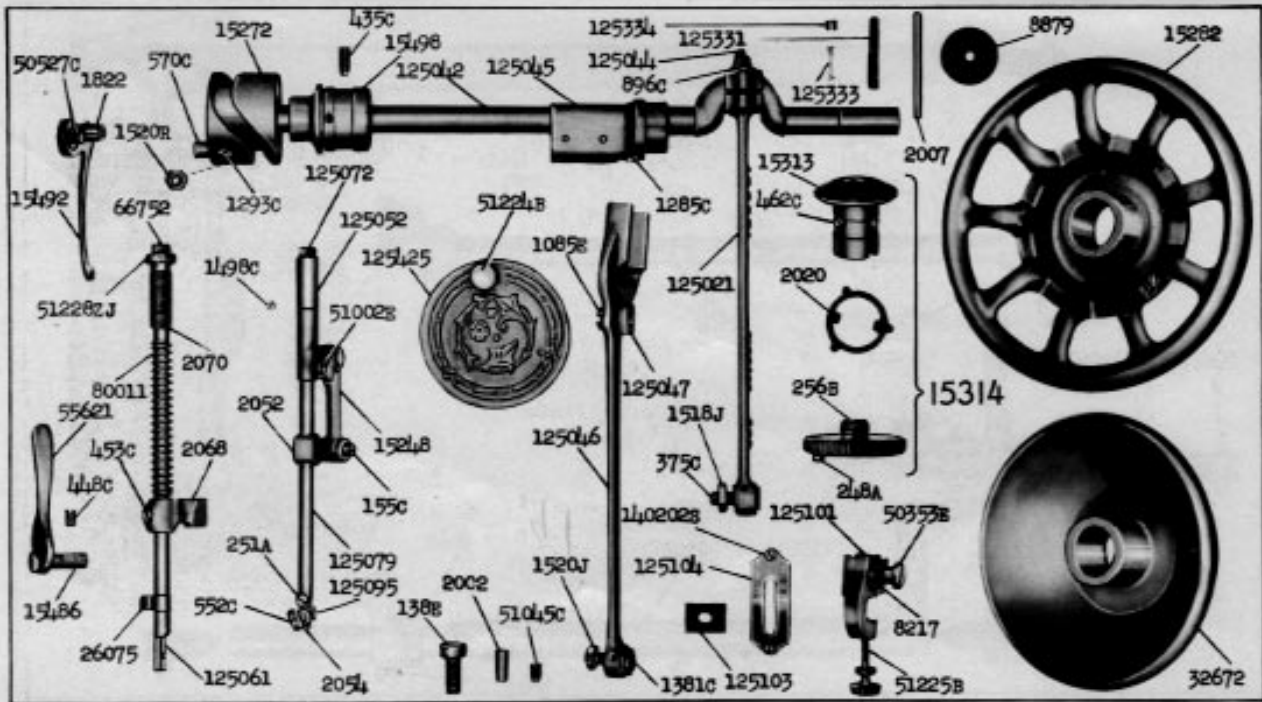

21471 - 1/3

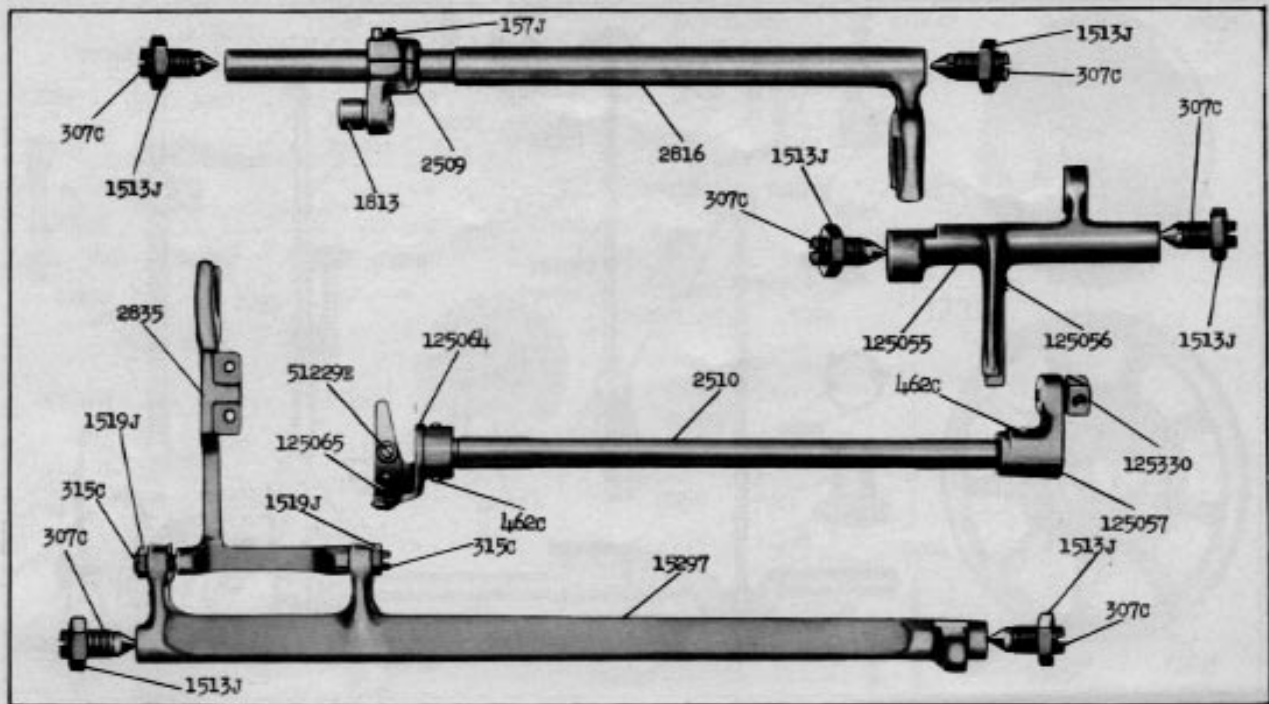

21472 - 1/2

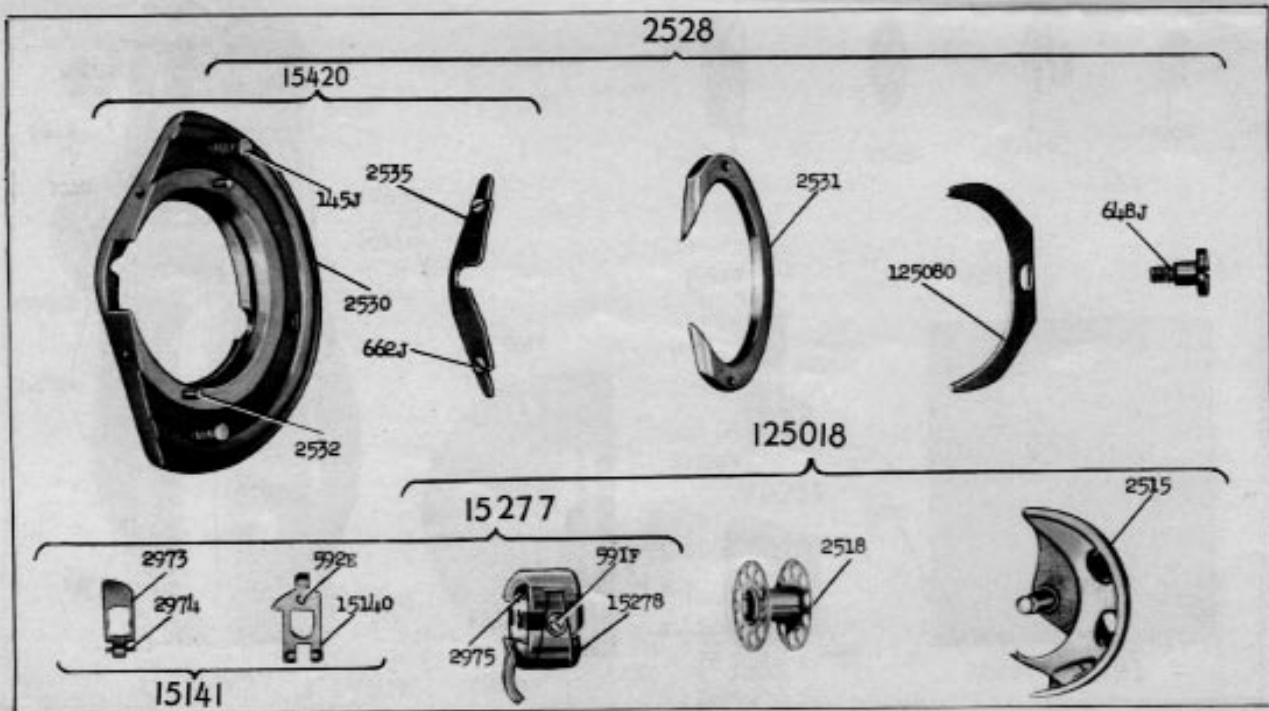

21473 - 2/3

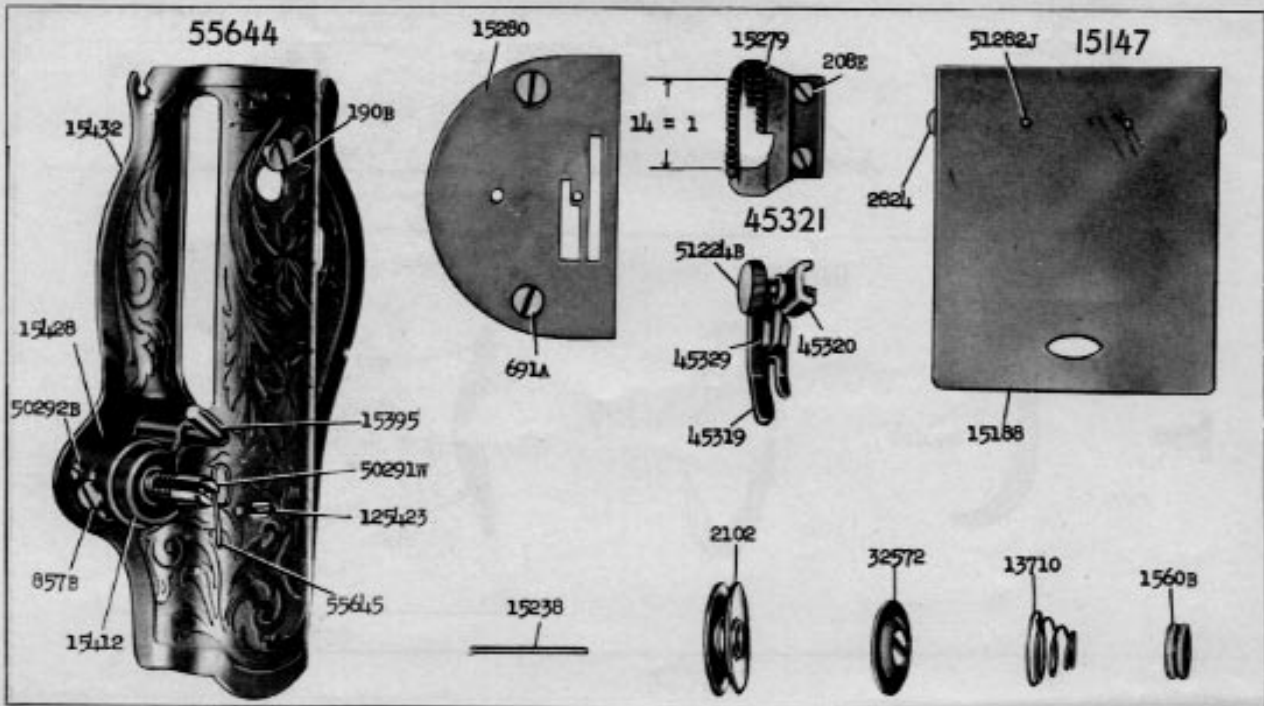

21474 - 2/3

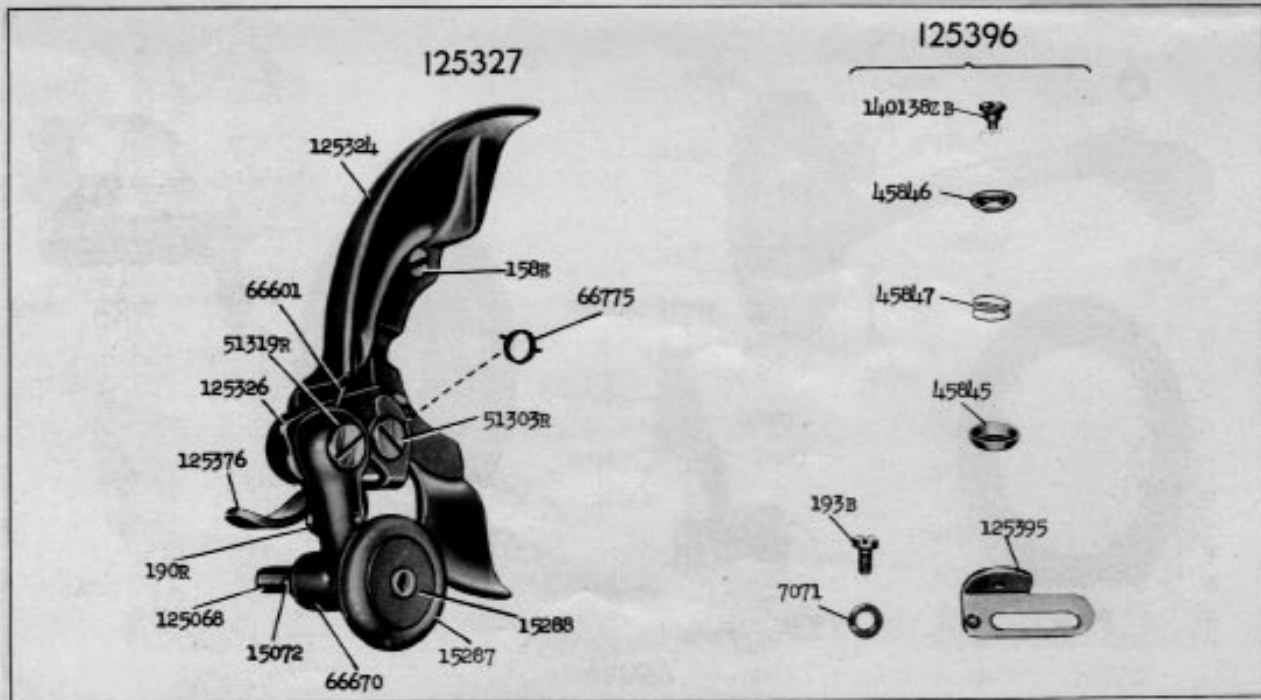

21475 - 2/3

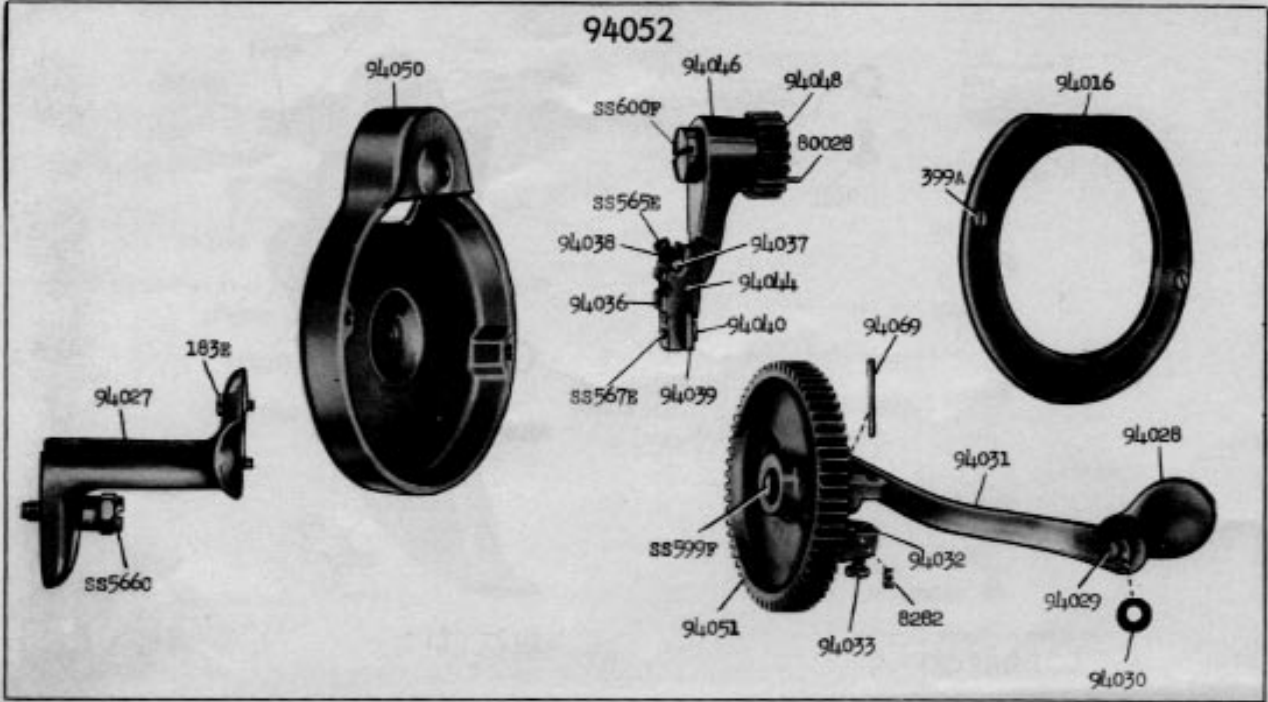

21476 - 1/2

21477 - 1/2

120603

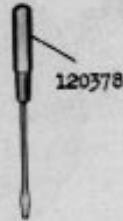
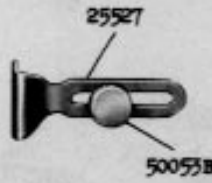
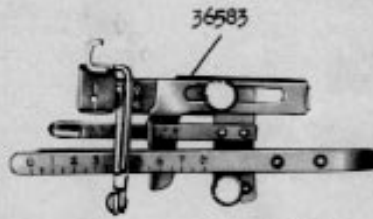
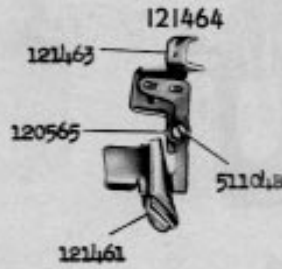
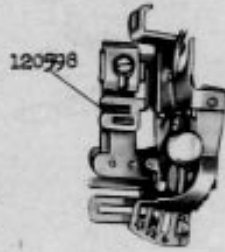

2518



21478 - 1/2

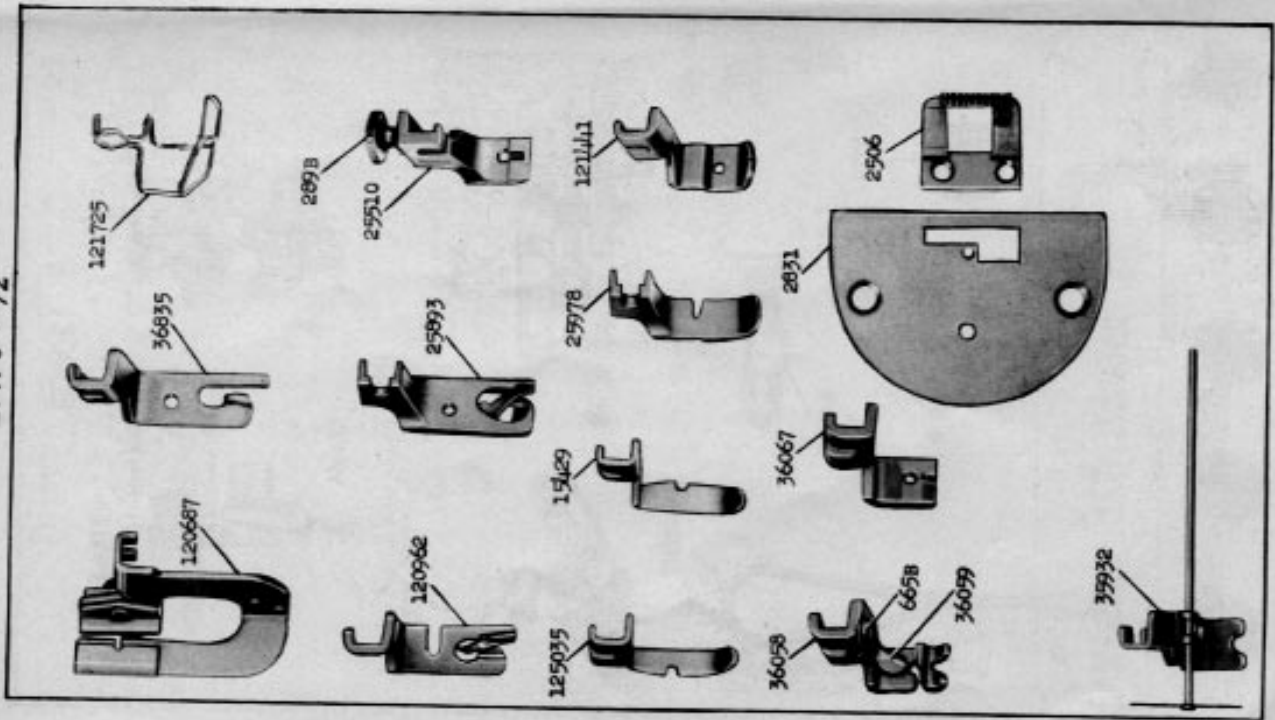

21479 - 1/2

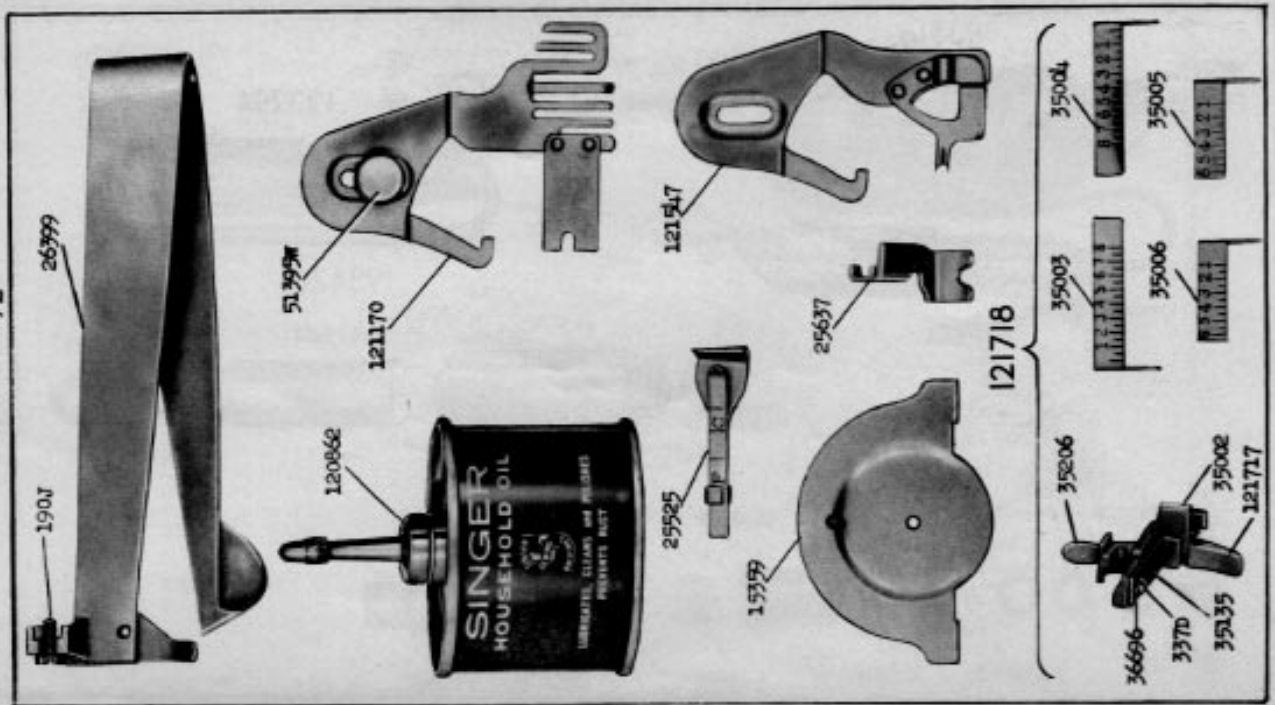

193518



194022



193294

193421

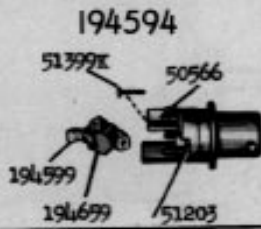
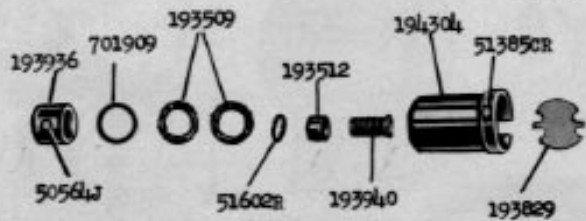
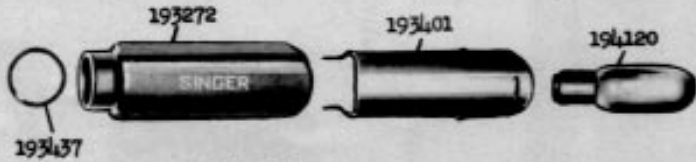

21480 - 1/3