

PRICE LIST

OF

PARTS



MACHINES

Nos. 10-1 and 10-3

THE SINGER MANUFACTURING COMPANY

INDEX.

	PAGE
ACCESSORIES	17
BINDING GUIDE (ADJUSTABLE)	17
BOBBIN WINDERS	18
DRIVING ATTACHMENT	21
EDGE GUIDE	18
FOOT LIFTER PARTS	22
IRON WORK AND TRIMMINGS FOR 5278	23
MACHINE No. 10-1	5
" " 10-3	11
NUMERICAL LIST OF PARTS	29
OBSOLETE PARTS	26

INSTRUCTIONS FOR ORDERING

In ordering from this list, use **ONLY** the **PART** number in the **FIRST** column.

The number stamped on a Sewing Machine part is in every case the number of the single part only.

Every combination of parts sent out as such has its specific number, which, although not stamped on the parts, must be used when ordering the combination.

Each number always indicates the **SAME PART** in whatever list it appears, or for whatever machine.

The letters after some of the numbers indicate the style of finish only, as follows:

- A. Hardened, Polished and Plated.
- B. Polished and Plated.
- C. Hardened only.
- D. Polished only.
- E. Soft, not Polished.
- F. Hardened and Polished.
- H. Blued.

These letters **MUST BE USED** *when* they appear in the list, and **AFTER** the number *as* in the list.

In this series

1 to 1500 and 50001 to 51500 are Screw Numbers.

1501 to 1800 are Nut Numbers.

1801 to 2000 are Roller Numbers.

2001 to 50000 are numbers of Machine Parts.

The figures in the second column refer only to the plates, illustrating the parts, and are **NOT TO BE USED** in ordering.

Parts marked with an asterisk (*) are furnished only when repairs are made at factory.

LIST OF PARTS COMPLETE

FOR

MACHINE NO. 10-1

UPPER FEED, CYLINDER SHUTTLE NO. 11851; PRESSER FEED
POINTS, FOR $\frac{1}{8}$, $\frac{1}{10}$ AND $\frac{1}{2}$ INCH "SET" STITCH; SINGER
DRIVING ATTACHMENT. FOR HARNESS TUGS AND
HEAVY LEATHER UP TO $\frac{3}{4}$ INCH IN THICKNESS.

NO.	PLATE	NAME	EACH
*11001	—	Arm	\$35 00
8702	3568	" Dowel Pin	15
496E	604	" Screw	15
11067	3551	" Shaft	8 50
9103	3552	" " Bushing	1 00
434c	606	" " " Set Screw	04
11068	3551	" Side Cover	50
65D	604	" " " Screw	12
8708	3568	" Spool Pin	05
11241	608	" " " Washer (cloth)..per 100	25
8982	3550	Balance Wheel with two 344c.....	4 00
8983	3568	" " Pin	10
344c	605	" " Set Screw	08
11054	601	Crank Connecting Rod with 9141 and two 129E	1 75
*9141	—	Crank Connecting Rod Cap.....	—
129E	605	" " " " Screw	04
369c	604	" " " Hinge Screw....	20
1509E	606	" " " " " Nut	06
*11004	—	Cylinder	35 00
11005	3551	" Cover	25
335D	606	" " Screw	02
11069	3551	Feed Bar	3 00
11070	3552	" " Cap	75
145D	3570	" " " Screw (long)	04
159D	605	" " " " (short)	03
19546	603	" " Guide Bracket with 453c.....	1 25
19547	3552	" " " Cap	20
190D	605	" " " " " Screw	03
2117	3568	" " " " Pin	01
453c	605	" " " " Set Screw.....	02
11071	3551	" " Hinge Bracket with 145D, 193E, 434c and 445c.....	3 00
145D	3570	Feed Bar Hinge Bracket Adjusting Screw	04
11035	603	" " " " Guide	1 00

PARTS FOR MACHINE NO. 10-1

NO.	PLATE	NAME	EACH
134D	3570	Feed Bar Hinge Bracket Guide Screw...	\$ 05
434c	606	" " " " Set Screw	
		(long)	04
445c	605	Feed Bar Hinge Bracket Set Screw	
		(short)	03
190D	605	Feed Bar Hinge Bracket Stop Screw....	03
1550H	3571	" " " " " "	
		Nut	03
11072	3568	Feed Bar Hinge Pin.....	25
193F	3570	" " " " Set Screw.....	03
11073	3553	" Cam with two 445c.....	1 25
445c	605	" " Set Screw.....	03
11074	3553	" Connecting Rod with two each 145D	
		and 1528D.....	2 00
145D	3570	Feed Connecting Rod Adjusting Screw..	04
1528D	3571	" " " " " "	
		Nut	03
567D	3570	Feed Connecting Rod Hinge Screw.....	15
11014	3554	" Point	1 50
Note:--When ordering No. 11014 give stitches to inch.			
11075	3554	Feed Point Packing.....	10
166D	605	" " Screw	07
19528	3553	" Regulator with 453c.....	1 75
912c	3570	" " Adjusting Screw.....	15
1596D	606	" " " " Nut ...	06
11094	3554	" " " " Sleeve..	15
3012	3568	" " Pin	01
453c	605	" " Set Screw	02
11065	3553	" " Shaft	1 00
11076	3553	" " Crank with 453c,	
		1513E and 1965.....	1 25
3012	3568	Feed Regulator Shaft Crank Pin.....	01
1965	3571	" " " " Roller with	
		50171c.....	45
50171c	3554	Feed Regulator Shaft Crank Roller Screw	
		Stud	20
1513E	606	Feed Regulator Shaft Crank Roller Screw	
		Stud Nut	05
453c	605	Feed Regulator Shaft Crank Set Screw..	02
11077	3553	" Shaft	60
11093	3553	" " Crank with 453c.....	90
3012	3568	" " " Pin	01
453c	605	" " Set Screw	02
9119	3554	" " " Slide Block	35
11078	3554	" " " " " 9119 with	
		1325c	50

PARTS FOR MACHINE NO. 10-1

NO.	PLATE	NAME	EACH
1325c	3554	Feed Shaft Crank Slide Block Screw	
		Stud	\$ 12
1513E	606	Feed Shaft Crank Slide Block Screw	
		Stud Nut	05
11079	3553	Feed Shaft Driving Crank with 453c.....	1 50
3012	3568	" " " " Pin	01
453c	605	" " " " Set Screw....	02
11080	3552	Needle Bar	1 00
8746	603	" " Connecting Link.....	1 25
370c	604	" " " " Hinge	
		Screw	18
1509E	606	Needle Bar Connecting Link Hinge	
		Screw Nut	06
9057	602	Needle Bar Connecting Stud with two	
		437c	2 00
437c	606	Needle Bar Connecting Stud Set Screw..	04
257E	606	" " Screw Bushing.....	20
9060	3554	" Clamp with 149F and 8749.....	90
8749	3554	" " Gib	25
149F	605	" " Screw	06
11017	602	" Plate	75
381D	605	" " Screw	06
19533	3551	Oil Cup	80
11917	3551	" " Cover	25
9084	3568	" " " Hinge Pin	02
2205	3566	" " " Latch Spring	04
207F	3570	" " " " " Screw	02
11919	3566	" " Thread Eyelet	05
8953	3566	" or Wax Stripper (felt).....	03
8482	3567	" " " Washer (steel) for	
		19533	01
11918	3567	Oil or Wax Stripper Washer (steel) for	
		11917	03
207F	3570	Oil or Wax Stripper Washer Screw.....	02
19534	3551	Oil Cup complete, Nos. 2205, 8482, 9084,	
		11917 to 11919, 19533, two 8953 and	
		three 207F	1 25
135D	605	Oil Cup Screw.....	05
11081	3551	Oscillating Rock Shaft.....	8 00
11082	---	Oscillating Rock Shaft complete, Nos.	
		1503E, 8752, 11081 and 11165.....	9 35
8752	601	Oscillating Rock Shaft Hinge Pin.....	1 25
1503E	606	" " " " Nut ..	10
11165	3566	" " " Oil Pad (felt)...	01
11018	601	" Shaft	2 00
11083	3552	" " Crank with 445c, 1513E	
		and 9120	1 50

NO.	PLATE	NAME	EACH
8873	3568	Oscillating Shaft Crank Pin.....	\$ 05
445c	605	" " " Set Screw.....	03
9119	3554	" " " Slide Block.....	35
190d	605	" " " " " Cap Screw	03
5968	3554	Oscillating Shaft Crank Slide Block Cap Screw Washer	02
9120	3554	Oscillating Shaft Crank Slide Block com- plete, Nos. 190d, 1016c, 5968 and 9119...	60
1016c	3554	Oscillating Shaft Crank Slide Block Screw Stud	25
1513E	606	Oscillating Shaft Crank Slide Block Screw Stud Nut.....	05
11058	3552	Presser Bar	1 25
11059	—	" " 11058 with 2049, 11023, 11063 and two 399E.....	2 25
11060	3552	Presser Bar Clutch.....	1 70
11061	—	Presser Bar Clutch complete, Nos. 164d, 1916, 11060 and 4154.....	2 00
11062	3552	Presser Bar Clutch Hinge Bracket with 159d	2 50
159d	605	Presser Bar Clutch Hinge Bracket Ad- justing Screw	03
25F	604	Presser Bar Clutch Hinge Screw.....	15
1916	3571	" " " Roller	20
164d	605	" " " " " Screw	04
41544	3567	" " " " " Washer	05
16960	602	" " " Lifter with 8761 and 8763...	1 25
8760	3567	" " " Friction Washer.....	03
16d	604	" " " Hinge Screw.....	20
8761	3568	" " " Stop Pin.....	05
11024	601	" " " Lifting Bell Crank.....	4 00
11025	601	" " " " " Adjust- ing Arm with 1513E and 1882.....	2 00
1882	606	Presser Bar Lifting Bell Crank Adjust- ing Arm Roller with 604c.....	45
604c	3569	Presser Bar Lifting Bell Crank Adjust- ing Arm Roller Screw.....	15
1513E	606	Presser Bar Lifting Bell Crank Adjust- ing Arm Roller Screw Nut.....	05
611F	605	Presser Bar Lifting Bell Crank Adjust- ing Arm Screw	12
752d	604	Presser Bar Lifting Bell Crank Hinge Screw	40
1505E	3571	Presser Bar Lifting Bell Crank Hinge Screw Nut	08

NO.	PLATE	NAME	EACH
8715	3567	Presser Bar Lifting Bell Crank Hinge Screw Nut Washer.....	\$ 25
11026	601	Presser Bar Lifting Link.....	75
65d	604	" " " " " Hinge Screw....	12
8763	3568	" " " " " Stud	25
7958	3568	" " " " " Pin	01
8765	3567	Presser Bar Lifting Link Hinge Stud Washer	04
11063	3554	Presser Bar Rack.....	60
399E	3554	" " " " " Screw	02
257E	606	" " " " " Screw Bushing.....	20
11031	601	" " " " " Spring (flat).....	1 50
11033	602	" " " " " (spiral)	15
11064	3554	" " " " " Collar	75
11032	602	" " " " " Bracket	25
381d	605	" " " " " Screw	06
4389	3568	" " " " " Guide Pin.....	02
609d	606	" " " " " Regulating Thumb Screw	45
1606E	3571	Presser Bar Spring Regulating Thumb Screw Lock Nut.....	05
1326E	3569	Pressure Regulating Thumb Screw.....	35
1638d	3571	" " " " " Lock Nut	12
11910	3555	Shuttle Bobbin	25
11852	3555	" " " Cylinder	2 50
8961	3555	" " " Hinge Pin.....	02
11853	3555	" " " Latch	15
2027	3555	" " " " Pin	01
19869	3555	" " " " Spring	01
19870	3555	" " " Frame	2 75
773H	3555	" " " Tension Regulating Screw.....	05
8964	3555	" " " Spring	40
19871	3555	Shuttle (cylinder) 3 in. diam., complete, Nos. 773H, 2027, 8961, 8964, 11852, 11853, 11910, 19869 and 19870.....	6 00
8965	602	Shuttle Driver with 445c.....	3 00
8873	3568	" " " Pin	05
445c	605	" " " Set Screw	03
11039	603	" " " Race Cap	1 50
11095	—	Shuttle Race Cap complete, Nos. 11039, 11040 and two 233d.....	1 85
11040	3566	Shuttle Race Cap Latch Spring.....	30
233d	605	" " " " " Screw ...	02
96d	605	" " " " " Screw	05
11038	603	" " " " " Ring	1 50
381d	605	" " " " " Screw	06

PARTS FOR MACHINE NO. 10-1

NO.	PLATE	NAME	EACH
11084	3552	Tension Bracket with two 2049.....	\$4 50
	135D 605	Tension Bracket Screw.....	05
	2049 3568	" " Thread Guide Pin.....	01
11085	3556	" " " " Roller ..	25
11086	3556	" " " " " Cap	20
		" " " " " Pin	10
11087	3556	Tension Bracket Thread Guide Roller Pin	10
8879	3556	Tension Friction Washer (cloth).....	01
11043	3556	" " " (steel)	03
1560c	606	" Regulating Thumb Nut.....	04
8905	3556	" " " " Washer	01
632D	606	Tension Screw Stud.....	30
8791	3556	" Spring	10
11044	3556	" Wheel	75
11042	—	Tension (wheel) complete, Nos. 632D, 1560c, 8791, 8905, 11043, 11044 and two 8879	1 25
11950	3556	Thread Eyelet (side of arm).....	05
2102	3556	" Retaining Disc.....	05
1560c	606	" " Regulating Thumb Nut.....	04
8905	3556	" " " " " Washer	01
686D	3570	Thread Retaining Screw Stud.....	25
2103	3556	" " Spring	03
11041	—	Thread Retainer complete, Nos. 686D, 1560c, 2103, 8905 and two 2102.....	45
9123	3551	Thread Take-up Cam with two 432c.....	8 50
8714	3568	" " " Pin	15
432c	3570	" " " Set Screw.....	04
11096	—	" " Lever	2 50
11097	3553	Thread Take-up Lever complete, Nos. 1513E, 1883, 1948 and 11096.....	3 15
	10D 605	Thread Take-up Lever Hinge Screw....	25
	1883 606	" " " Roller and Screw Stud	35
1513E	606	Thread Take-up Lever Roller and Screw Stud Nut.....	05
1948	3571	Thread Take-up Lever Thread Guiding Roller and Screw Stud.....	25
16947	3556	Thread Take-up Spring.....	10
19614	3556	" " " Hook	05
11090	3556	" " " Lever with 11085 to 11087, 11091 and 19614.....	1 50
32888	3556	Thread Take-up Spring Lever Regulator with 9046 and 19614.....	1 50

PARTS FOR MACHINE NO. 10-1

NO.	PLATE	NAME	EACH
9046	3556	Thread Take-up Spring Lever Regulator Pin	\$ 05
	164D 605	Thread Take-up Spring Lever Regulator Screw	04
11085	3556	Thread Take-up Spring Lever Roller....	25
11086	3556	" " " " " Cap	20
11087	3556	" " " " " Pin	10
1925	3571	" " " " Stop with 961c	25
	961c	Thread Take-up Spring Lever Stop Screw	12
11091	3556	" " " " Thread Guide Pin	02

LIST OF PARTS COMPLETE

FOR

MACHINE NO. 10-3

UPPER FEED, 4 INCH HIGH POINT CYLINDER SHUTTLE, FLAT PRESSER BAR SPRING, HEAVY FEED PARTS, S. D. A., FOOT LIFTER; FITTED WITH ADJUSTABLE TUBE GUIDE. FOR BINDING THE EDGE OF COCOA MATS WITH ROPE BINDING.

NO.	PLATE	NAME	EACH
*11098	—	Arm	\$40 00
19785	3568	" Dowel Pin	20
	496E 604	" Screw	15
11099	3557	" Shaft	8 50
	9103 3552	" " Bushing	1 00
	434c 606	" " " Set Screw.....	04
11100	3557	" Side Cover (lower).....	25
	190D 605	" " " " Screw	03
32851	3557	" " " (upper)	25
	2049 3568	" " " " Pin	01
	771D 3570	" " " " Thumb Screw	10
	8708 3568	" Spool Pin	05
11211	608	" " " Washer (cloth) ..per 100	25
32852	3550	Balance Wheel with two 344c.....	6 00
	8983 3568	" " Pin	10
	344c 605	" " Set Screw.....	08
32853	3557	Crank Connecting Rod with 9141 and two 575E	5 00
*9141	—	Crank Connecting Rod Cap.....	—
	575E 3570	" " " " Screw	05
	369c 604	" " " Hinge Screw....	20
	1509E 606	" " " " " Nut	06

PARTS FOR MACHINE NO. 10-3

NO.	PLATE	NAME	EACH
*32854	—	Cylinder	\$40 00
32855	3557	" Cover	50
219d	3570	" " Screw	02
11069	3551	Feed Bar	3 00
32856	3558	" " Cap	75
145d	3570	" " " Screw (long)	01
159d	605	" " " " (short)	03
19546	603	" " Guide Bracket with 453c	1 25
19547	3552	" " " " Cap	20
190d	605	" " " " " Screw	03
2117	3568	" " " " " Pin	01
453c	605	" " " " " Set Screw	02
11071	3551	" " Hinge Bracket with 145d, 193e, 431c and 445c	3 00
145d	3570	Feed Bar Hinge Bracket Adjusting Screw	04
32857	3558	" " " " Guide	1 50
134d	3570	" " " " " Screw	05
431c	606	" " " " " Set Screw (long)	01
445c	605	" " " " " " (short)	03
11072	3568	" " " " " Pin	25
193f	3570	" " " " " Set Screw	03
32858	3559	" " Cam with two 431c	3 00
434c	606	" " " " " Set Screw	04
11074	3553	" " Connecting Rod with two each 145d and 1528d	2 00
145d	3570	Feed Connecting Rod Adjusting Screw	04
1528d	3571	" " " " " " "	03
567d	3570	Nut	03
32859	3559	Feed Connecting Rod Hinge Screw	15
912c	3570	" " Regulator with 231c and 445c	4 00
1596d	606	" " " " " Adjusting Screw	15
11094	3554	" " " " " Nut	06
231c	3570	" " " " " Sleeve	15
8873	3568	" " " " " Stop Screw	03
445c	605	Feed Regulator Pin	05
32860	3557	" " " " " Set Screw	03
32861	3567	" " " " " Shaft	2 00
445c	605	" " " " " Collar with two 445c	50
32862	3559	Feed Regulator Shaft Collar Set Screw	03
8873	3568	" " " " " Crank with 1513e, 1965 and two 445c	5 00
1965	3571	Feed Regulator Shaft Crank Pin	05
50171c	3554	" " " " " Roller with 50171c	45
50171c	3554	Feed Regulator Shaft Crank Roller Screw Stud	20

PARTS FOR MACHINE NO. 10-3

NO.	PLATE	NAME	EACH
1513E	606	Feed Regulator Shaft Crank Roller Screw Stud Nut	\$ 05
445c	605	Feed Regulator Shaft Crank Set Screw	03
32863	3559	" " Shaft	1 25
32864	3559	" " Crank with 445c	3 00
8873	3568	" " " Pin	05
445c	605	" " " Set Screw	03
9119	3554	" " " Slide Block	35
32865	3554	" " " " " 9119 with 50171c	60
50171c	3554	Feed Shaft Crank Slide Block Screw Stud	20
1513E	606	Feed Shaft Crank Slide Block Screw Stud Nut	05
32866	3559	Feed Shaft Driving Crank with two 445c	4 50
8873	3568	" " " " " Pin	05
445c	605	" " " " " Set Screw	03
32867	3560	Feeding Foot	3 00
50172d	3560	" " " Screw	08
1599d	3560	" " " " Nut	05
17738	3560	" " " " Washer	05
8758	3558	Lifting Presser Bar	1 25
32868	3559	" " " " Bracket with 362f	2 50
362f	3570	" " " " " Set Screw	05
11023	3567	" " " " Collar with 453c	25
2049	3568	" " " " " Pin	01
453c	605	" " " " " Set Screw	02
32869	3557	" " " " Spring (flat)	1 25
32870	3558	" " " " " Bracket (back) with 4389	1 00
381d	605	Lifting Presser Bar Spring Bracket (back) Screw	06
32871	3558	Lifting Presser Bar Spring Bracket (front)	1 00
381d	605	Lifting Presser Bar Spring Bracket (front) Screw	06
4389	3568	Lifting Presser Bar Spring Guide Pin	02
340d	3570	" " " " " Regulating Screw	06
32872	3560	Lifting Presser Foot with 32873 and two 168d	4 50
168d	3560	Lifting Presser Foot Clamping Screw	04
32873	3560	" " " " Needle Hole Bush- ing	25
32874	3558	Needle Bar with 191f	1 50
8746	603	" " " Connecting Link	1 25

NO.	PLATE	NAME	EACH
370c	604	Needle Bar Connecting Link Hinge Screw	\$ 18
1509E	606	Needle Bar Connecting Link Hinge Screw Nut	06
32875	3560	Needle Bar Connecting Stud with two 1149F	3 00
1149F	3560	Needle Bar Connecting Stud Clamping Screw	04
32876	3561	Needle Plate	7 00
575D	3570	" " Screw	05
191F	3570	" Set Screw	03
11081	3551	Oscillating Rock Shaft	8 00
11082	—	Oscillating Rock Shaft complete, Nos. 1503E, 8752, 11081 and 11165	9 35
8752	601	Oscillating Rock Shaft Hinge Pin	1 25
1503E	606	" " " " Nut	10
11165	3566	" " " Oil Pad (felt)	01
32877	3557	" Shaft	2 00
32878	—	" Crank	3 00
32879	3561	Oscillating Shaft Crank complete, Nos. 445c, 1513E, 9120 and 32878	3 75
8873	3568	Oscillating Shaft Crank Pin	05
445c	605	" " " Set Screw	03
9119	3554	" " " Slide Block	35
190D	605	" " " " Cap Screw	03
5968	3554	Oscillating Shaft Crank Slide Block Cap Screw Washer	02
9120	3554	Oscillating Shaft Crank Slide Block complete, Nos. 190D, 1016c, 5968 and 9119	60
1016c	3554	Oscillating Shaft Crank Slide Block Screw Stud	25
1513E	606	Oscillating Shaft Crank Slide Block Screw Stud Nut	05
32880	3558	Presser Bar	1 25
16996	3558	" " Lifter with 8761 and 8763	1 25
8760	3567	" " " Friction Washer	03
16D	604	" " " Hinge Screw	20
8761	3568	" " " Stop Pin	05
9146	3562	" " Lifting Bell Crank	7 50
11025	601	" " " " Adjusting Arm with 1513E and 1882	2 00
1882	606	Presser Bar Lifting Bell Crank Adjusting Arm Roller with 604c	45
604c	3569	Presser Bar Lifting Bell Crank Adjusting Arm Roller Screw	15
1513E	606	Presser Bar Lifting Bell Crank Adjusting Arm Roller Screw Nut	05

NO.	PLATE	NAME	EACH
611F	605	Presser Bar Lifting Bell Crank Adjusting Arm Screw	\$ 12
752D	604	Presser Bar Lifting Bell Crank Hinge Screw	40
1595E	3571	Presser Bar Lifting Bell Crank Hinge Screw Nut	08
8715	3567	Presser Bar Lifting Bell Crank Hinge Screw Nut Washer	25
9108	3560	Presser Bar Lifting Bracket with 523F	2 00
523F	3560	" " " " Set Screw	15
32881	3558	" " " Link	75
8763	3568	" " " " Hinge Stud for 16996	25
9140	3560	Presser Bar Lifting Link Hinge Stud for 11071	40
7958	3568	Presser Bar Lifting Link Hinge Stud Pin	01
8765	3567	Presser Bar Lifting Link Hinge Stud Washer	04
913E	3569	Presser Bar Screw Bushing	40
11031	601	" " Spring (flat)	1 50
11032	602	" " " Bracket	25
381D	605	" " " " Screw	06
4389	3568	" " " Guide Pin	02
609D	606	" " " Regulating Thumb Screw	45
1606E	3571	Presser Bar Spring Regulating Thumb Screw Lock Nut	05
16901	3563	Shuttle Bobbin	50
8776	3564	" Cylinder	5 50
8777	3564	" " Hinge Pin	10
8778	3564	" " Latch Spring	25
330D	3564	" " " " Screw	02
19843	3564	" Frame	8 00
1323F	3564	" Tension Regulating Screw	05
8780	3564	" " Spring	50
19844	3563	Shuttle (cylinder) 4 in. diam., complete, Nos. 330D, 1323F, 8776 to 8778, 8780, 16901 and 19843	12 00
32882	3561	Shuttle Driver with 445c	5 00
8873	3568	" " Pin	05
445c	605	" " Set Screw	03
32883	3565	" Race Ring (inside)	5 00
32884	3565	" " " (outside)	9 00
32885	3565	" " " Cap	2 50
96D	605	" " " " Screw	05
50173D	3570	" " " " Screw	10
11084	3552	Tension Bracket with 11085 to 11087 and two 2049	4 50

PARTS FOR MACHINE NO. 10-3

NO.	PLATE	NAME	EACH
135D	605	Tension Bracket Screw.....	\$ 05
2049	3568	" " Thread Guide Pin.....	01
11085	3556	" " " " Roller ...	25
11086	3556	" " " " Cap	20
11087	3556	" " " " Pin	10
8879	3556	" Friction Washer (cloth).....	01
11043	3556	" " " (steel).....	03
1560c	606	" Regulating Thumb Nut.....	04
8905	3556	" " " " Washer	01
632D	606	" Screw Stud.....	30
8791	3556	" Spring	10
11044	3556	" Wheel	75
11042	—	Tension (wheel) complete, Nos. 632D, 1560c, 8791, 8905, 11043, 11044 and two 8879	1 25
11950	3556	Thread Eyelet (side of arm).....	05
8786	3566	" Retaining Disc.....	15
1535E	3566	" " Regulating Thumb Nut	10
8787	3566	" " " " "	"
		Washer	01
406D	3566	Thread Retaining Screw Stud.....	25
8788	3566	" " Spring	25
8785	—	Thread Retainer complete, Nos. 406D, 1535E, 8787, 8788 and two 8786.....	90
32886	3562	Thread Take-up Cam with two 432c....	15 00
8983	3568	" " " Pin	10
432c	3570	" " " Set Screw.....	04
32887	3561	" " Lever with 1513E and 1865	3 00
10D	605	Thread Take-up Lever Hinge Screw....	25
1865	3571	" " " Roller and Screw Stud	45
1513E	606	Thread Take-up Lever Roller and Screw Stud Nut.....	05
16947	3556	Thread Take-up Spring.....	10
19614	3556	" " " Hook	05
11090	3556	" " " Lever with 11085 to 11087, 11091 and 19614.....	1 50
32888	3556	Thread Take-up Spring Lever Regulator with 9046 and 19614.....	1 50
9046	3556	Thread Take-up Spring Lever Regulator Pin	05
164D	605	Thread Take-up Spring Lever Regulator Screw	04
11085	3556	Thread Take-up Spring Lever Roller....	25
11086	3556	" " " " " Cap	20

PARTS FOR MACHINE NO. 10-3

NO.	PLATE	NAME	EACH
11087	3556	Thread Take-up Spring Lever Roller Pin	\$ 10
1925	3571	" " " " Stop with 961c	25
961c	3569	Thread Take-up Spring Lever Stop Screw	12
11091	3556	Thread Take-up Spring Lever Thread Guide Pin.....	02

ACCESSORIES

NO.	PLATE	NAME	EACH
490E	3569	Bolt with 1600E, to secure machine to power table.....	\$ 06
1600E	3571	Bolt Nut.....	02
9281	3567	" Washer	01
25955	6047	Oiler with 25956.....	15
25956	6047	" Spout, 8½ in. long.....	07
11831	6047	Screw Driver (large).....	20
26026	6047	" " (small)	10
4822	3575	Wrench for 1528.....	05
8909	3575	" " 523, 1513 and 1596.....	10
8910	3575	" " 344, 611 and 1509.....	25
8911	3575	" " 1503	15
9155	3575	" " 1595	50
25200	3575	" " 340 and 362.....	10

BINDING GUIDE (Adjustable)

FOR 10-3 MACHINE

NO.	PLATE	NAME	EACH
36508	—	Binding Guide (left).....	\$ 4 00
164D	3576	" " " Screw	04
36509	—	" " (right)	1 00
217F	3576	" " " Screw	03
36510	3576	Binding Guide (adjustable) complete, Nos. 36508, 36509 and two 217F.....	5 00
36511	3576	Binding Guide Bracket.....	1 00
164D	3576	" " " Screw	04

EDGE GUIDE

FOR 10.3 MACHINE

NO.	PLATE	NAME	EACH
36512	3577	Edge Guide (lower)	\$ 2 00
96D	3577	" " " Screw	05
36513	3577	" " (upper)	2 00
164D	3577	" " " Screw	04
36514	—	Edge Guide complete, Nos. 36512, 36513 and two 164D.	4 10

BOBBIN WINDERS

BOBBIN WINDER (HAND)

NO.	PLATE	NAME	EACH
11755	—	Belt	\$ 05
11756	—	" 11755 with 25028.	05
25028	3566	" Hook	01
11758	6054	Frame	50
11759	6054	Pulley	25
11760	6054	" Driving Wheel	50
8380	6054	" " " Handle (wood)	03
11762	6054	" " " " S t u d	10
8382	3567	" " " " "	10
		Washer	01
11761	—	Pulley Driving Wheel Handle complete, Nos. 8380, 8382 and 11762.	10
11763	6054	Pulley Driving Wheel Stud	10
2269	3583	" " " " Pin	01
11764	3567	" " " " Washer	01
11765	6054	Spindle	40
11754	3562	Bobbin Winder (hand) complete, Nos. 2269, 11756, 11758 to 11761 and 11763 to 11765	2 00
134D	3570	Bobbin Winder Screw	05

(BOBBIN WINDER Automatic)

FOR 11910, OBSOLETE

NO.	PLATE	NAME	EACH
9062	607	Stand with 178c.	\$ 25
9063	607	" Shaft	04
9064	3567	" " Collar	03
9065	607	" " Pulley	25
178c	605	" " Set Screw	03

BOBBIN WINDERS

NO.	PLATE	NAME	EACH
9066	607	Spindle	\$ 10
9067	607	" Frame	15
9068	607	" " Spring	10
7958	3568	" " " Pin	01
2448	607	" Pulley	15
9069	607	Stop Latch	15
9070	607	" " Bracket with 178c.	20
	178c	" " " Set Screw	03
	24D	" " Hinge Screw	08
1541D	3571	Tension Regulating Thumb Nut	05
	470D	" Spool Pin with fixed cone	25
8018	3567	" " " Adjustable Cone	05
8019	3572	" " " " " Spring	02
9071	—	Tension Spool Pin complete, Nos. 470D, 1541D, 8018 and 8019.	25
9074	607	Tension Thread Guide Pin	03
9061	607	Bobbin Winder (automatic) complete, Nos. 24D, 2448, 7958, 9062 to 9071, 9074 and two wood screws 1 in. No. 7.	1 50

BOBBIN WINDER

(SWINGING AUTOMATIC, RIGHT HAND)

FOR FLAT OR ROUND BELT

FOR 11910

BOBBIN WINDER PARTS

NO.	PLATE	NAME	EACH
41439	3579	Base with 458c, 27916 and two 28084.	\$ 50
41398	3583	Bobbin Carrier Key	05
27916	3583	Brake (leather)	02
28084	3583	" Rivet	01
41440	3581	Frame	35
41441	3581	" Hinge Pin	10
	458c	" " " Set Screw	02
	4784	" Oil Pad	01
41442	3581	" Spring	05
41443	3581	Pulley with 155c.	60
	155c	" Set Screw	03
41444	3579	Spindle with 41398.	25
41557	3579	Stop Latch	15
41446	3579	" " Hinge Pin	10
	2269	" " Pin	01
41447	3581	Tripping Arm with 176D.	20
	176D	" " Clamping Screw	03
41558	3579	Bobbin Winder, Nos. 2269, 41439 to 41444, 41446, 41447, 41557, two 4784 and three wood screws 1 in. No. 7.	2 25

BOBBIN WINDERS

THREAD UNWINDER PARTS

NO.	PLATE	NAME	EACH
27555	3582	Spool Pin	\$ 08
41450	3582	" Rest	20
41451	—	" " 41450 with 138B and 27555....	35
138B	3583	" " Set Screw	05
27557	3582	" Stand with 138B.....	25
41514	3582	" Weight, 4 in. diam., with 41515....	15
41515	3583	" " Centre Pin	05
2102	3583	Tension Disc	05
1560c	3583	" Regulating Thumb Nut.....	04
637F	3583	" Screw Stud	08
2103	3583	" Spring	03
5769	3583	" Thread Eyelet	03
41452	3582	Thread Guard	40
27560	3582	" " Rod, 26 in. long.....	30
138B	3583	" " Set Screw	05
330D	3583	" " Set Screw	02
41453	—	Thread Guard complete, Nos. 330D, 637F, 1560c, 2103, 5769, 41452 and two 2102....	70
41454	3582	Thread Unwinder complete, for one large spool, Nos. 27557, 27560, 41451, 41453, 41514 and three wood screws 1¼ in. No. 12	1 75
41559	—	Bobbin Winder (swinging automatic, right hand) complete, Nos. 41454 and 41558	4 00

BOBBIN WINDER

(SWINGING AUTOMATIC, RIGHT HAND)

FOR FLAT OR ROUND BELT

FOR 16901

This Bobbin Winder is the same as 41559 with the following exceptions :

NO.	PLATE	NAME	EACH
41550	3580	Base with 458c, 27916 and two 28084, in place of 41439.....	\$ 50
41551	3583	Bobbin Position Pin, in place of 41398....	05
41552	3580	Spindle, in place of 41441.....	25
41553	3583	" Collar with 41551 and two 449c..	50
449c	3583	" " Set Screw	02
41554	3580	Stop Latch, in place of 41557.....	15
11107	3580	" " Hinge Pin, in place of 41446.	10

BOBBIN WINDERS

NO.	PLATE	NAME	EACH
41555	3580	Bobbin Winder, Nos. 2269, 11107, 41440 to 41443, 41447, 41550, 41552 to 41554 and two 4784, in place of 41558.....	\$ 2 85
41556	—	Bobbin Winder (swinging automatic, right hand) complete, Nos. 41454 and 41555	4 60

DRIVING ATTACHMENT

FOR 10-1 MACHINE

NO.	PLATE	NAME	EACH
8982	3550	Balance Wheel with two 344c.....	\$ 4 00
8983	3568	" " Pin	10
344c	605	" " Set Screw	08
8984	608	Brake Block (wood).....	05
9D	605	" " Screw	20
8985	3550	Friction Pulley with 8986.....	2 75
8986	608	" " Centre Bearing	25
8987	3550	" Ring (paper)	10
401E	605	" " Screw	02
8988	3550	Lever	1 00
8990	3550	" Bracket	1 00
497E	604	" " Bolt with 1522E.....	05
1522E	606	" " " Nut	02
134D	3570	" Screw	05
8991	608	" " Washer	06
8992	608	" Spring	20
32891	608	" " Hook	15
1520E	3571	" " " Nut	03
9091	3550	Shaft Driving Pulley, 10 in. diam., 1½ in. face, 1⅞ in. bore (sectional) with two 597c	80
597c	3570	Shaft Driving Pulley Clamping Screw...	08
27636	3550	Treadle	30
9082	3572	" Bearing Cotter Pin.....	01
27637	3550	" Pitman Rod (lower).....	05
27638	3572	" " " Spring	03
27639	3550	" " " (upper)	05
9079	3550	" " " Clamp with 354c....	12
354c	3570	" " " " Screw	06
27640	3550	Treadle Pitman complete, Nos. 2762, 9079 and 27637 to 27639.....	35
2878	3550	Treadle Stand	15
2762	3572	" Stop Collar with 362F.....	10
362F	3572	" " " Set Screw	05
27642	—	Treadle complete, Nos. 2878, 9082, 27636 and four wood screws 1 in. No. 16.....	45

DRIVING ATTACHMENT

NO.	PLATE	NAME	EACH
27643	---	Treadle and Pitman complete, Nos. 27640 and 27642	\$ 80
32895	---	Driving Attachment complete, Nos. 9d, 134d, 1520e, 8982 to 8985, 8987, 8988, 8990 to 8992, 9091, 27643, 32891, two 497e and four 401e.....	11 50

DRIVING ATTACHMENT

FOR 10-3 MACHINE

This Driving Attachment is the same as 32895 with the following exceptions:

NO.	PLATE	NAME	EACH
32852	3550	Balance Wheel with two 344c, in place of 8982	\$ 6 00
32889	3550	Lever, in place of 8988.....	3 00
32890	3550	" Bracket, in place of 8990.....	2 00
32892	---	Driving Attachment complete, Nos. 9d, 134d, 1520e, 8983 to 8985, 8987, 8991, 8992, 9091, 27643, 32852, 32889 to 32891, two 497e and four 401e.....	16 50

FOOT LIFTER PARTS

FOR 10-1 MACHINE

NO.	PLATE	NAME	EACH
13351	---	Chain, 46 in. to 55 in. long.....	\$ 30

Note:—When ordering No. 13351 give length required.

4879	608	Chain Connecting Link.....	03
11023	3567	Lifting Collar with 453c.....	25
2049	3568	" " Pin	01
453c	605	" " Set Screw.....	02
11027	601	" Lever	1 50
11028	602	" " Bracket	60
2117	3568	" " Dowel Pin.....	01
135d	605	" " Screw	05
11029	3568	" " Hinge Pin	02
19520	608	" " Spring	15
32d	3570	" " Screw	10
4881	609	Treadle	30
4882	608	" Shaft	05

FOOT LIFTER PARTS

NO.	PLATE	NAME	EACH
4883	608	Treadle Spring	\$ 10
4884	609	" Stand	25
4885	609	Treadle complete, Nos. 4879, 4881 to 4884 and two wood screws 1 in. No. 16.....	75
11092	---	Foot Lifter complete, Nos. 32d, 135d, 2049, 2117, 4885, 11023, 11027 to 11029, 13351 and 19520.....	3 45

FOOT LIFTER PARTS

FOR 10-3 MACHINE

NO.	PLATE	NAME	EACH
13351	---	Chain, 46 in. to 55 in. long.....	\$ 30

Note:—When ordering No. 13351 give length required.

4879	608	Chain Connecting Link.....	03
11023	3567	Lifting Collar with 453c.....	25
2049	3568	" " Pin	01
453c	605	" " Set Screw.....	02
32893	3562	" Lever	2 25
8055	3568	" " Hinge Pin.....	03
19520	608	" " Spring	15
32d	3570	" " Screw	10
4881	609	Treadle	30
4882	608	" Shaft	05
4883	608	" Spring	10
4884	609	" Stand	25
4885	609	Treadle complete, Nos. 4879, 4881 to 4884 and two wood screws 1 in. No. 16.....	75
32894	---	Foot Lifter complete, Nos. 32d, 2049, 4885, 8055, 11023, 13351, 19520 and 32893.....	3 85

IRON WORK AND TRIM-
MINGS FOR 5278

FOR 10-3 MACHINE

IRON WORK

NO.	PLATE	NAME	EACH
27279	---	Brace	\$ 50
27006	610	" 27279 with 499g and two each 12620 and wood screws 1½ in. No. 14.....	30

NO.	PLATE	NAME	EACH
499E	3569	Brace Bolt with 1522E.....	\$ 05
1522E	606	" " Nut	02
12620	3567	" " Washer	02
27015	609	Floor Stand Foot, 5 in. with six wood screws 1½ in. No. 16.....	25
27022	609	Floor Stand Journal Box with 27029, 27030 and two 121E.....	35
27026	609	Floor Stand Journal Box Bracket, 6 in. high, with 421E and 1507E.....	25
27028	609	Floor Stand Journal Box Bracket Adjusting Slide.....	05
492E	3569	Floor Stand Journal Box Bracket Bolt with 1522E.....	06
1522E	606	Floor Stand Journal Box Bracket Bolt Nut	02
12620	3567	Floor Stand Journal Box Bracket Bolt Washer	02
27029	608	Floor Stand Journal Box Oil Feeder (felt)	02
27030	—	Floor Stand Journal Box Oil Reservoir.....	10
121E	3570	" " " " Screw	06
421E	3569	" " " " Set Screw.....	08
1507E	3571	" " " " " Nut	05
27018	—	Floor Stand complete, Nos. 492E, 12620, 27015, 27022, 27026 and 27028.....	95
27038	610	Leg, 16 in. wide.....	1 05
27215	—	Leg complete, Nos. 489E, 27022, 27025, 27028, 27038, four 494E and six 12620.....	2 05
494E	3569	Leg Foot Screw.....	05
12620	3567	" " " Washer	02
27022	609	" Journal Box with 27029, 27030 and two 121E.....	35
27025	609	Leg Journal Box Bracket, 6 in. drop, with 421E and 1507E.....	20
27028	609	Leg Journal Box Bracket Adjusting Slide	05
489E	3569	" " " " Bolt with 1522E	08
1522E	606	" " " " " Nut	02
12620	3567	" " " " " Washer	02
27029	608	" " " " Oil Feeder (felt).....	02
27030	—	" " " " Reservoir	10
121E	3570	" " " " Screw	06
421E	3569	" " " " Set Screw.....	08
1507E	3571	" " " " " Nut	05
27241	610	Leg (sectional) 32 in. to 35 in. wide, Nos. 27122 and two each 497E, 12620 and 27240	1 20

NO.	PLATE	NAME	EACH
27122	610	Leg Cross Bar (curved).....	\$ 30
497E	604	" " " Bolt with 1522E.....	05
1522E	606	" " " " Nut	02
12620	3567	" " " " Washer	02
27240	610	" Side Section	45
—	—	Pulley (solid) 10 in. diam., 3 in. face, 1⅝ in. bore.....	
27097	610	Rail, 19 in., single flat, with two 492E and four each 12620 and wood screws 1½ in. No. 14.....	30
27102	610	Rail, 45½ in., double flat, with two 492E, four 12620, six wood screws 1 in. No. 10 and twelve wood screws 1½ in. No. 14.....	1 00
492E	3569	Rail Bolt with 1522E.....	06
1522E	606	" " Nut	02
12620	3567	" " Washer	02
27108	608	Shaft Collar with 432c.....	15
432c	3570	" " Set Screw.....	04
—	—	Eight feet, eight inches of 1¼ in. Flat Belting	
—	—	Four feet, seven inches of 1⅝ in. Shafting	
27247	—	Iron Work complete, Nos. 27018, pulley (solid) 10 in. diam., 3 in. face, 1⅝ in. bore, two each 27006, 27097, 27108, 27215, four each 27102, 27241, four feet seven inches of 1⅝ in. shafting, eight feet eight inches of 1¼ in. flat belting and sixteen each 494E and 12620.....	19 50

TRIMMINGS

NO.	PLATE	NAME	EACH
27248	611	Sliding Table Mat Stop (back) with five wood screws 1 in. No. 12.....	\$ 1 50
27249	611	Sliding Table Mat Stop (front) with five wood screws 1 in. No. 12.....	1 25
41022	611	Sliding Table Rail, 18 in. long, with seven wood screws ½ in. No. 4.....	25
41023	611	Sliding Table Rail, 28⅝ in. long, with ten wood screws ½ in. No. 4.....	35
27191	611	Sliding Table Rail, 46⅝ in. long, with fifteen wood screws ½ in. No. 4.....	60
27199	611	Sliding Table Rail, 50⅝ in. long, with seventeen wood screws ½ in. No. 4.....	60
41024	611	Sliding Table Rail (flat) 18 in. long, with seven wood screws ½ in. No. 4.....	15

NO.	PLATE	NAME	EACH
41025	611	Sliding Table Rail (flat) 28 $\frac{3}{4}$ in. long, with ten wood screws $\frac{1}{2}$ in. No. 4.....	\$ 20
27192	611	Sliding Table Rail (flat) 46 $\frac{5}{8}$ in. long, with fifteen wood screws $\frac{1}{2}$ in. No. 4..	35
27200	611	Sliding Table Rail (flat) 50 $\frac{3}{8}$ in. long, with seventeen wood screws $\frac{1}{2}$ in. No. 4	35
27193	608	Sliding Table Roller (flat face) with 196F, for 27197.....	20
27194	608	Sliding Table Roller (grooved face) with 196F, for 27198.....	20
27195	608	Sliding Table Roller Bracket.....	15
27196	608	" " " Pin.....	05
196F	3570	" " " " Set Screw.....	02
27197	—	Sliding Table Roller (flat face) complete, Nos. 27193, 27195, 27196 and four wood screws 1 in. No. 8.....	40
27198	—	Sliding Table Roller (grooved face) complete, Nos. 27194 to 27196 and four wood screws 1 in. No. 8.....	40
27250	609	Sliding Table Stop with two wood screws $\frac{1}{4}$ in. No. 12.....	50

OBSOLETE PARTS

NO.	PLATE	NAME	EACH
11002	3567	Arm Screw Washer.....	\$ 10
9059	601	" Shaft.....	8 50
8923	602	" Bushing.....	1 00
*11003	—	" Side Plate.....	—
135D	605	" " " Screw.....	05
8926	3551	Crank Connecting Rod with 9141 and two 129E.....	1 75
11047	601	Feed Bar.....	2 50
11049	603	" " Cap.....	75
11021	603	" Guide Bracket Cap with 9042..	60
11048	601	" Hinge Bracket with 145D, 434C and 445C.....	2 50
2049	3568	Feed Bar Pin.....	01
8734	3572	" Spring.....	08
11050	603	" Bracket with 9042.....	75
190D	605	" " " Screw.....	03
9042	3572	" " " Hook.....	01
9043	3567	" Washer.....	10
11006	603	" Cam with two 445C.....	1 25
11051	601	" Connecting Rod.....	40

NO.	PLATE	NAME	EACH
65D	604	Feed Connecting Rod Hinge Screw.....	\$ 12
11015	—	" Point, use 11014.....	1 50
11016	—	" " ".....	1 50
11007	602	" Regulator with 453C.....	1 25
753D	604	" " Adjusting Screw.....	20
11009	602	" " Shaft.....	50
11010	602	" " " Crank with 453C, 1518E and 1845.....	1 25
1845	606	Feed Regulator Shaft Crank Roller and Screw Stud.....	30
1518E	3571	Feed Regulator Shaft Crank Roller and Screw Stud Nut.....	04
11011	601	Feed Shaft.....	75
11013	603	" " Crank (back) with 453C and 1804.....	1 00
3012	3568	Feed Shaft Crank (back) Pin.....	01
1804	606	" " " Roller and Stud.....	25
453C	605	Feed Shaft Crank (back) Set Screw.....	02
11012	602	" " " (front) with 453C.....	75
3012	3568	" " " " Pin.....	01
453C	605	" " " " Set Screw.....	02
5667	609	Foot Lever.....	15
5668	609	" " 5667 with 5669, 5671 and three wood screws $\frac{1}{2}$ in. No. 16.....	40
5669	609	Foot Lever Bracket.....	10
5671	3568	" " Hinge Pin.....	01
5672	608	" " Lifting Spring.....	03
8745	3552	Needle Bar.....	1 50
11056	3551	Oscillating Rock Shaft.....	7 50
11057	—	Oscillating Rock Shaft complete, Nos. 1503E, 8752, 11056 and 11165.....	8 75
8954	601	Oscillating Rock Shaft with two each 8980 and 8989, for 8752.....	7 50
8980	3572	Oscillating Rock Shaft Steel Plate.....	15
8989	3572	" " " " " Rivet.....	01
8957	602	" Shaft Crank with 445C and 1803.....	1 00
1803	606	Oscillating Shaft Crank Roller and Stud.....	45
11019	3552	Presser Bar.....	1 25
11036	602	" " Clutch.....	2 00
11055	—	Presser Bar Clutch complete, Nos. 164D, 1916, 11036 and 41544.....	2 30
11034	602	Presser Bar Clutch Hinge Bracket with 159D.....	1 25
8759	3573	Presser Bar Lifter with 8761.....	1 25

OBSOLETE PARTS

NO.	PLATE	NAME	EACH
572E	604	Pressure Regulating Thumb Screw.....	\$ 50
8959	—	Shuttle Bobbin, use 11910.....	25
8960	3574	“ Cylinder	2 50
8962	3574	“ “ Latch Spring.....	15
223D	605	“ “ “ “ Screw	02
8963	3574	“ Frame	2 75
8958	—	Shuttle (cylinder) 3 in. diam., complete, Nos. 223D, 773H, 8960 to 8964 and 11910, use 19871	6 00
11854	3574	Shuttle Cylinder Latch Spring.....	03
590E	3574	“ “ “ “ Screw	02
11855	3574	“ Frame	2 75
11851	—	Shuttle (cylinder) 3 in. diam., complete, Nos. 590E, 773H, 2027, 8961, 8964, 11852 to 11855 and 11910, use 19871.....	6 00
11045	601	Thread Take-up Cam with two 432C.....	6 00
8968	602	“ “ Lever with 1513E and 1883	2 00
11088	—	Thread Take-up Lever for 11089.....	2 50
11731	3572	“ “ “ Roller	25
11732	3572	“ “ “ “ Pin	03
11733	3572	“ “ “ “ Plate	10
11735	3572	“ “ “ “ “ Rivet	01
11089	3573	Thread Take-up Lever complete, Nos. 1513E, 1883, 11088, 11731 to 11733 and two 11735, use 11097.....	3 30
11052	3572	Thread Take-up Spring.....	08
8077	3572	“ “ “ Hook	01
8799	—	“ “ “ Regulator	15
11066	3572	“ “ “ “ with 8077 and 9046.....	1 50
164D	605	Thread Take-up Spring Regulator Screw	04
41544	3567	“ “ “ “ “ “ Washer	05
11046	3572	Thread Take-up Spring Staple.....	10
164D	605	“ “ “ “ Screw	04
41544	3567	“ “ “ “ “ “ Washer	05

PLATE 601-ONE-FOURTH SIZE

9059 11018 11054 11031 11027 11047 11051 11011

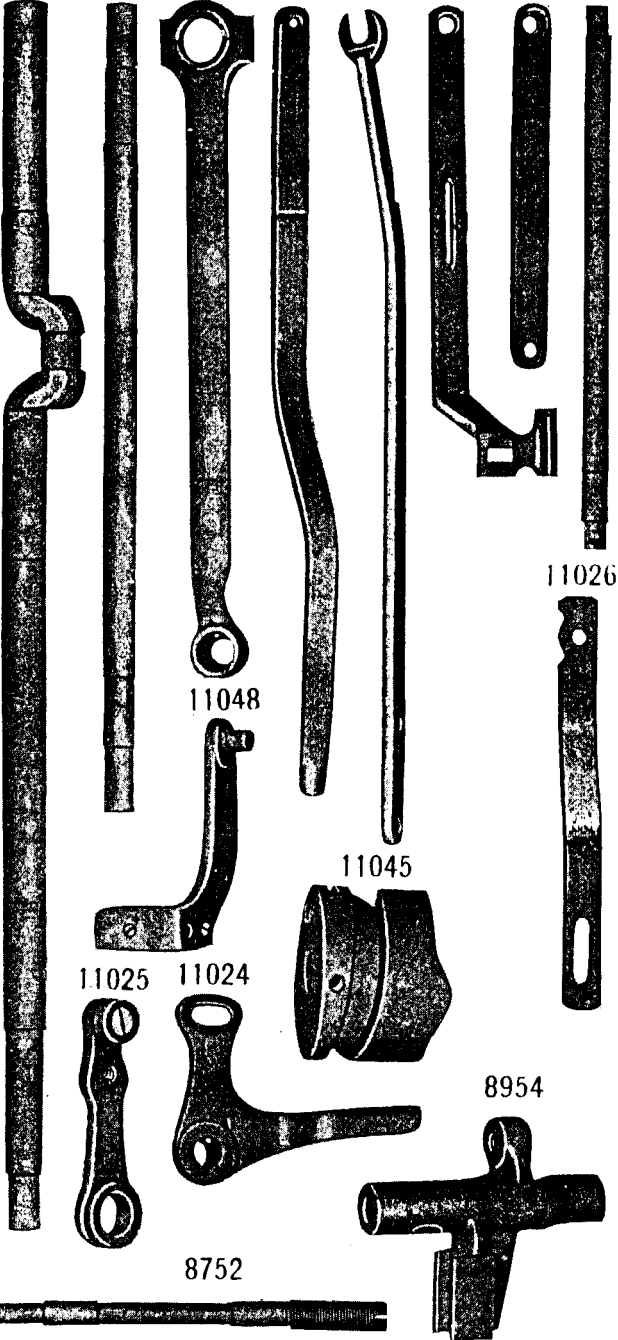


PLATE 602—ONE-HALF SIZE

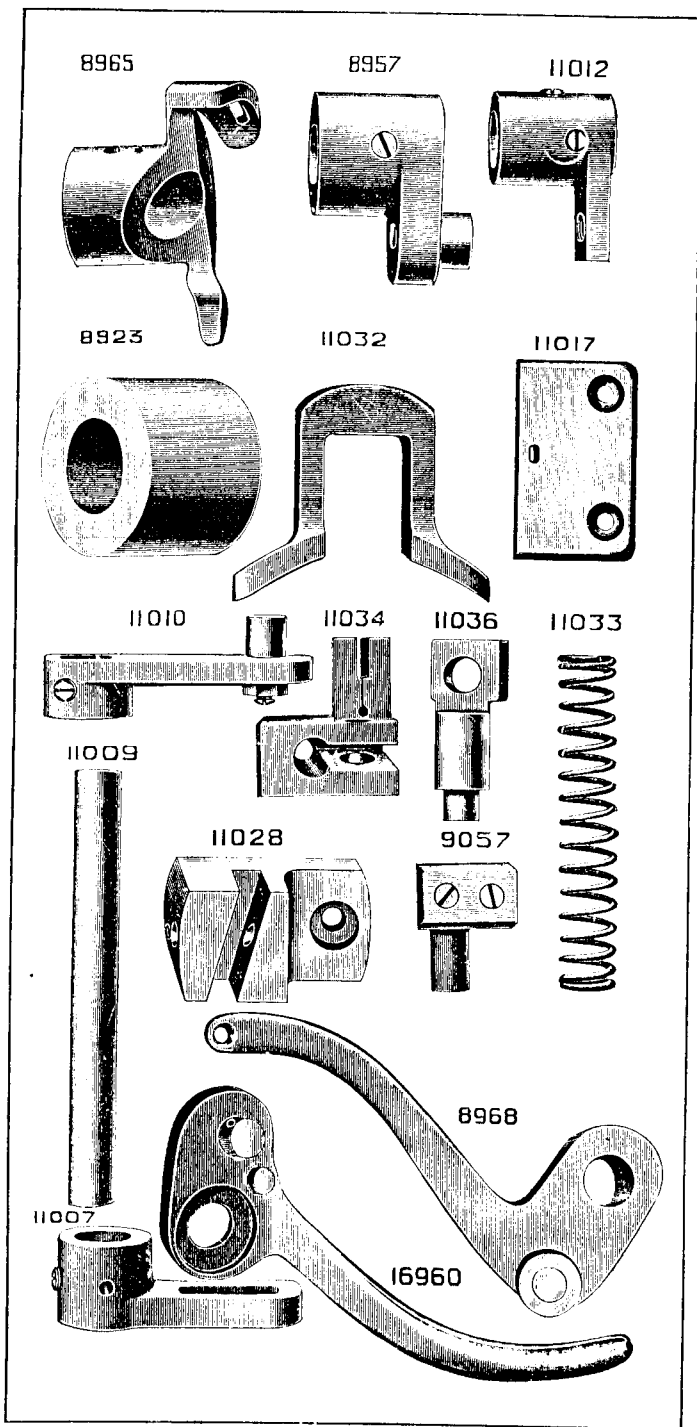


PLATE 603—ONE-HALF SIZE

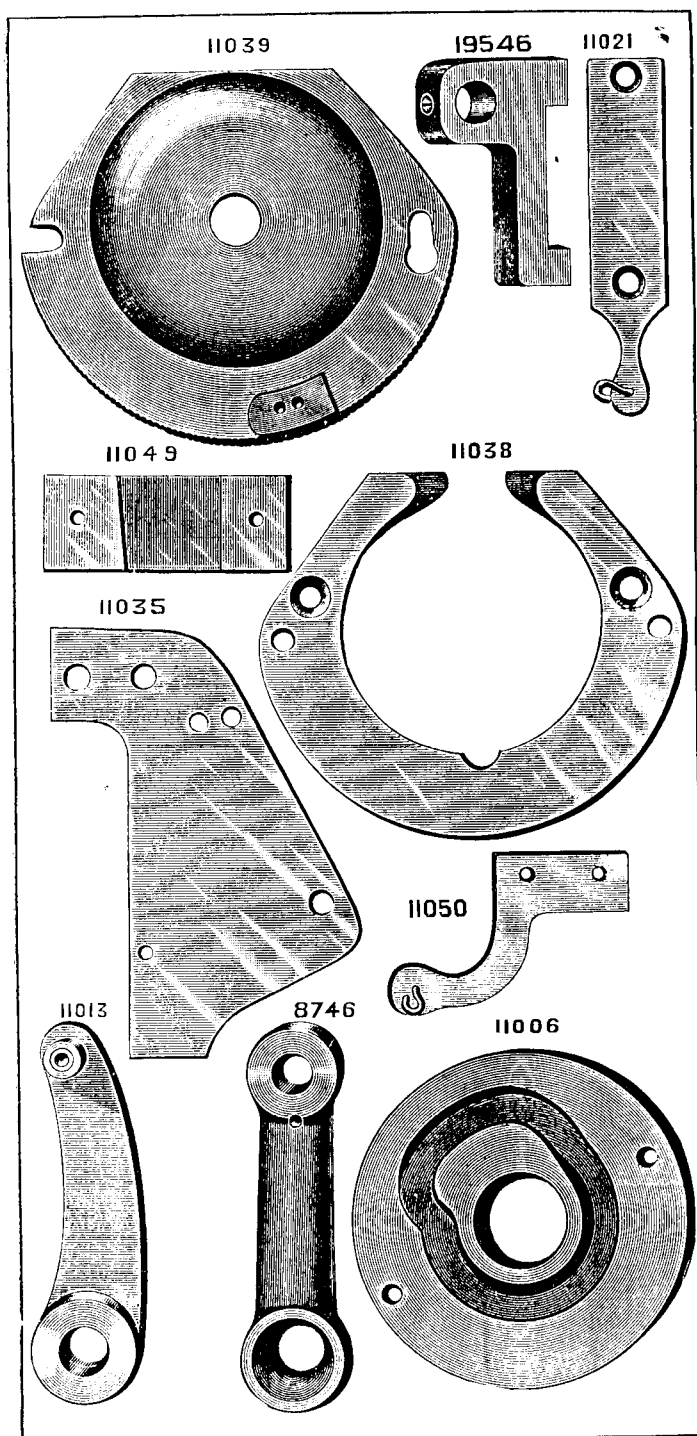


PLATE 604—FULL SIZE

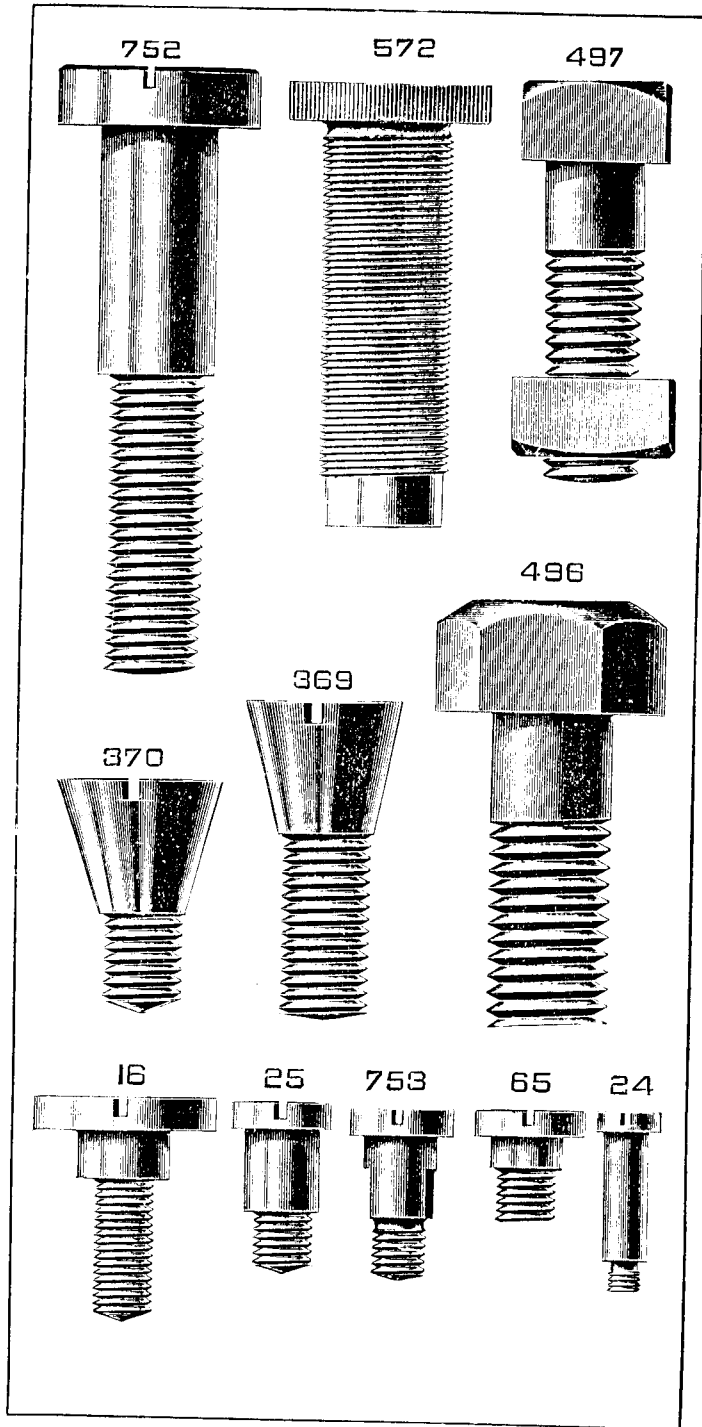


PLATE 605—FULL SIZE

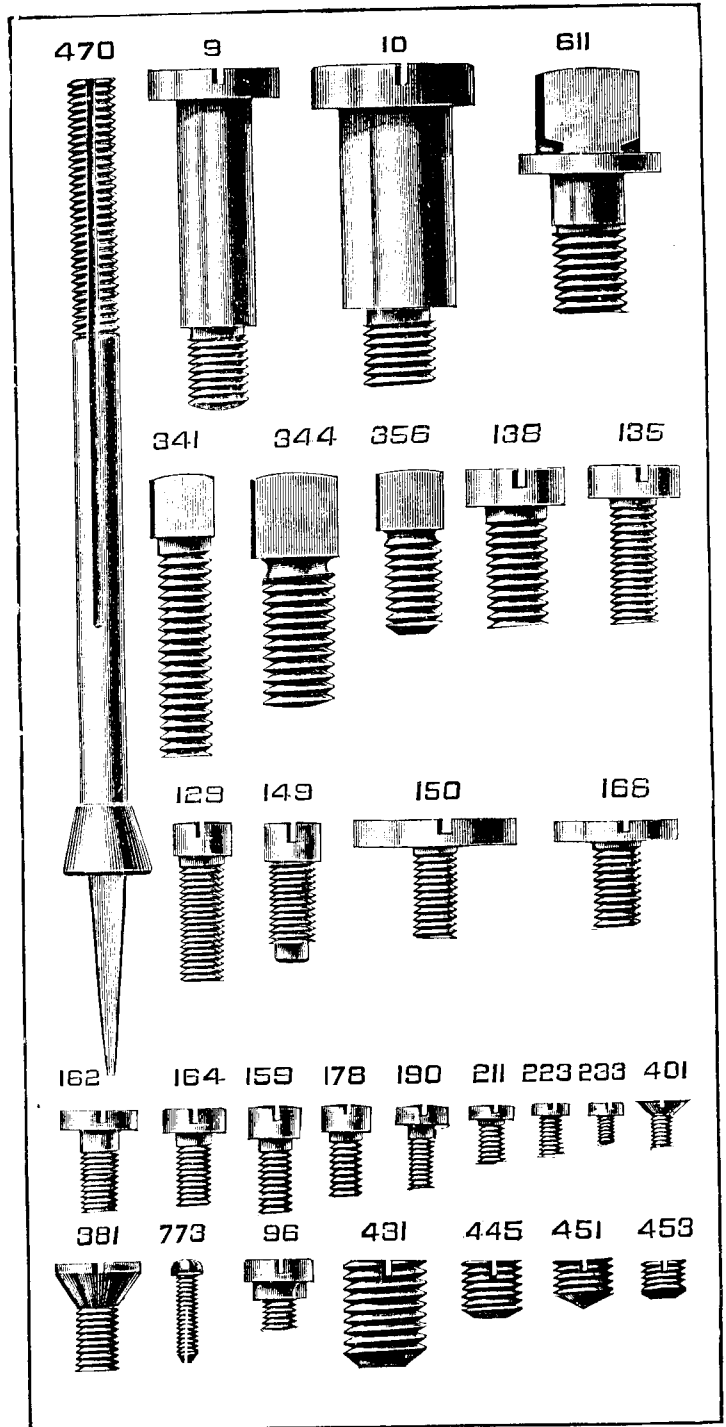


PLATE 606—FULL SIZE

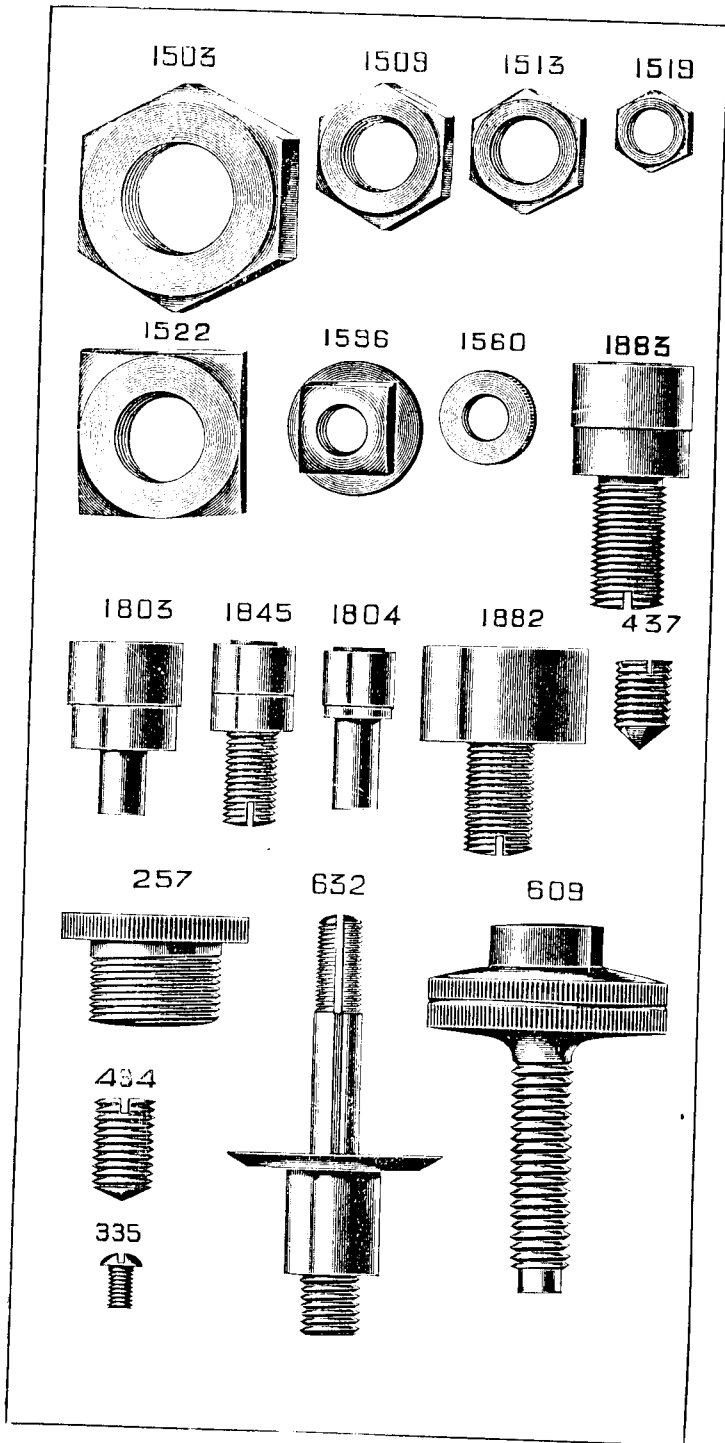


PLATE 607—ONE-HALF SIZE

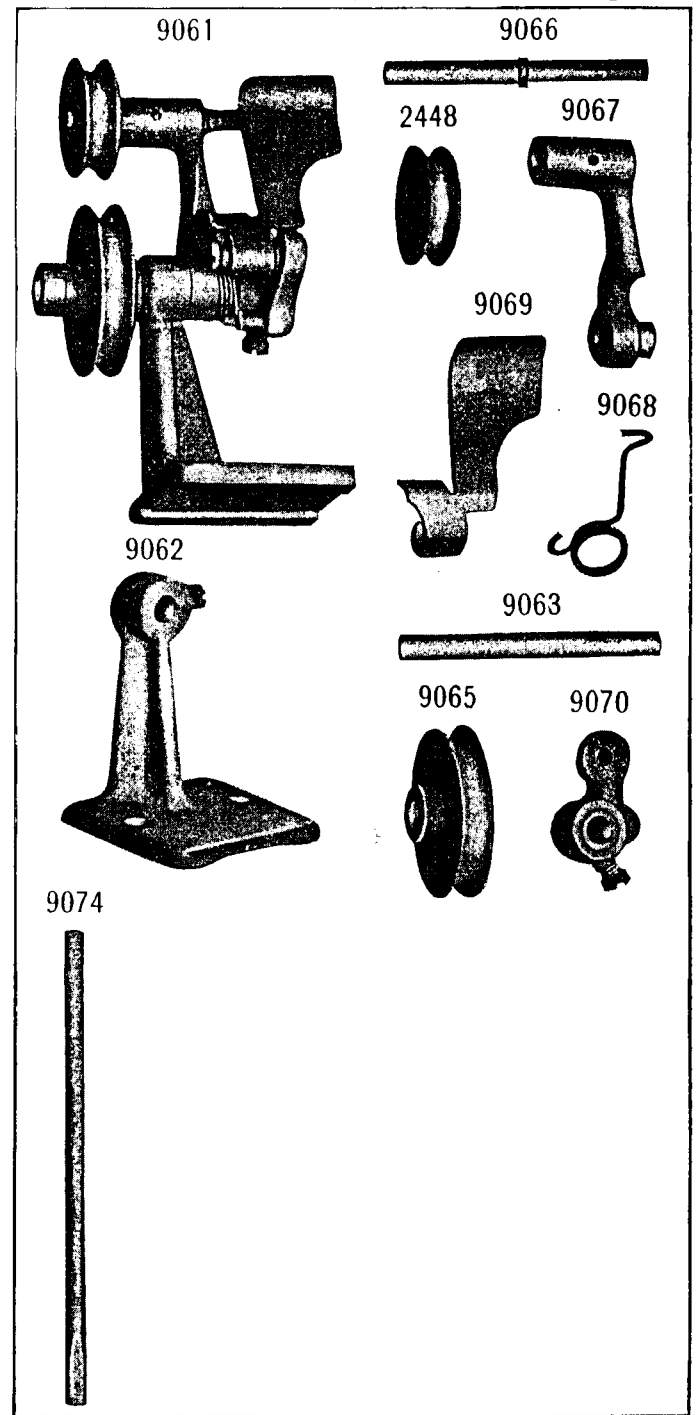


PLATE 608—ONE-HALF SIZE

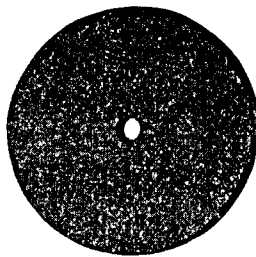
8984



8986



8991



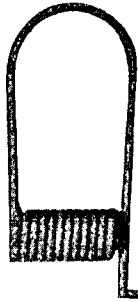
8992



32891



4883



4879



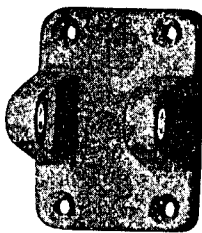
4882



27108



27195



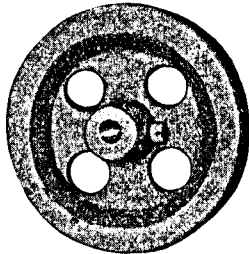
5672



19520



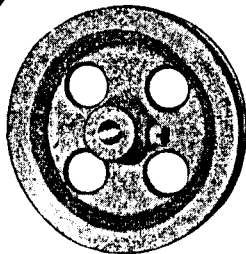
27193



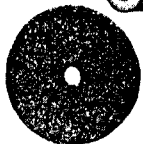
27196



27194



11241

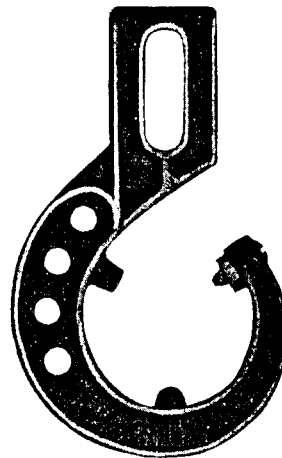


27029

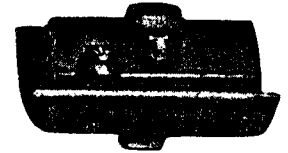


PLATE 609—ONE-FOURTH SIZE

27025



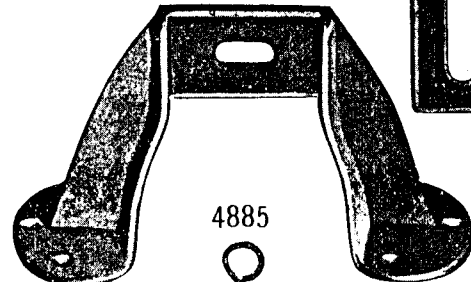
27022



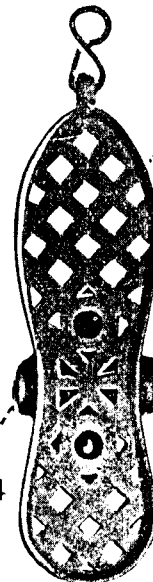
27026



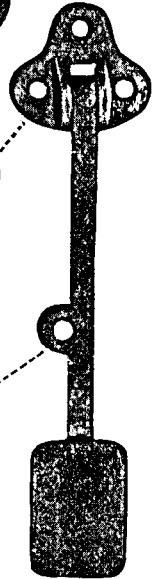
27015



4885



5668



27028



4881

5669

27250



4884

5667

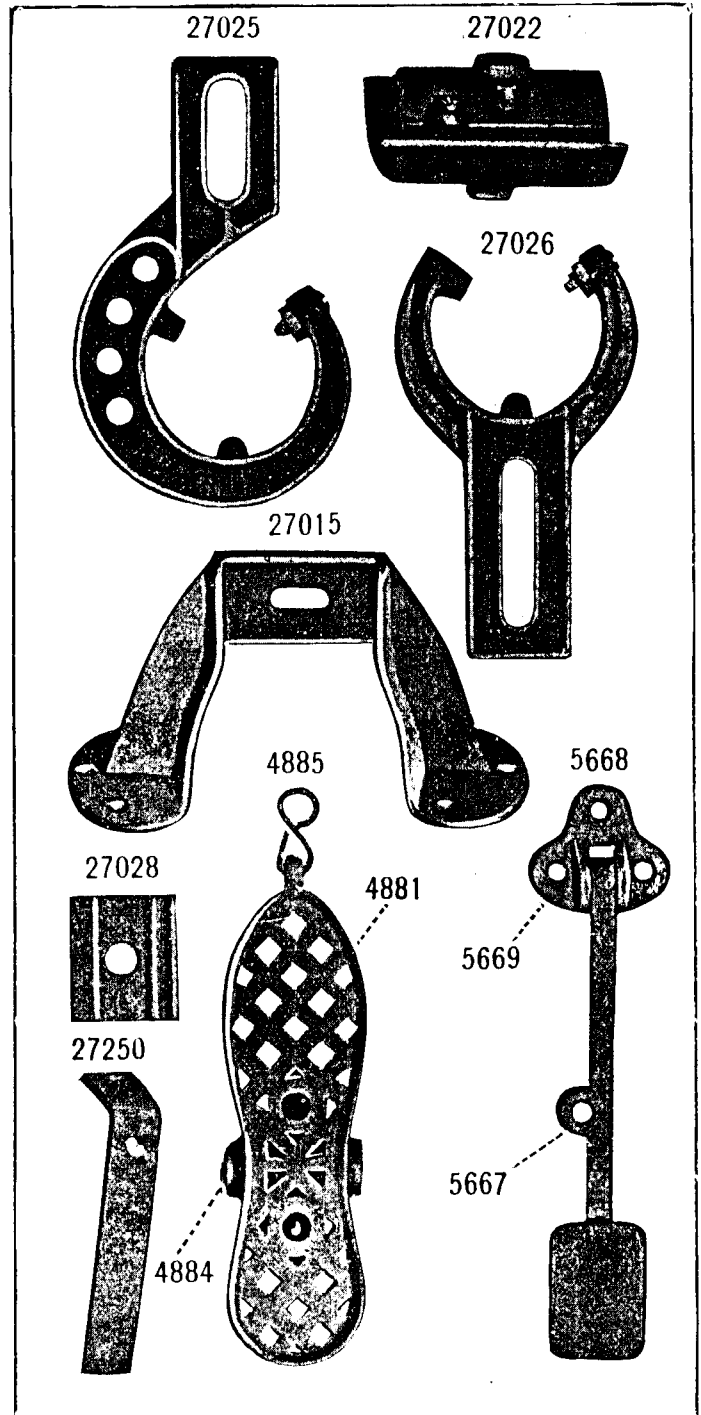


PLATE 610—ONE-NINTH SIZE

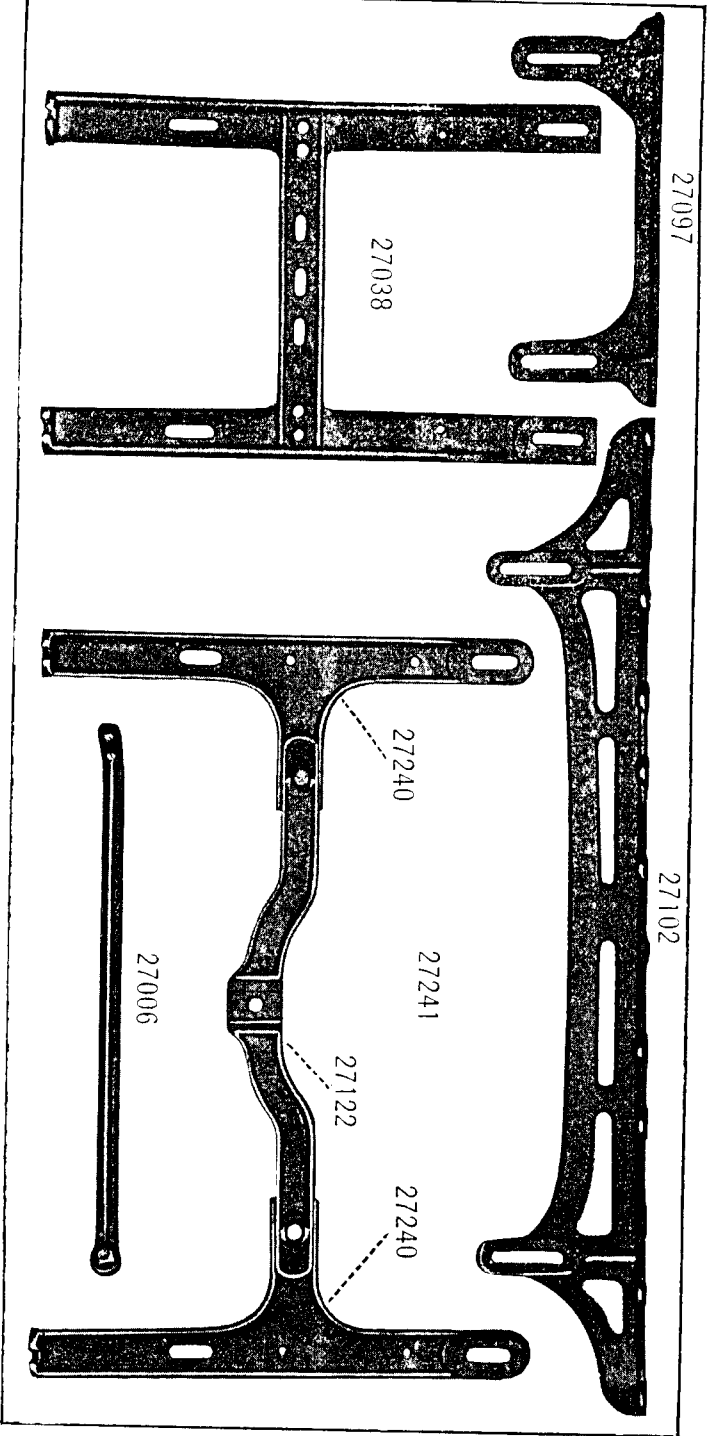


PLATE 611—ONE-TENTH SIZE

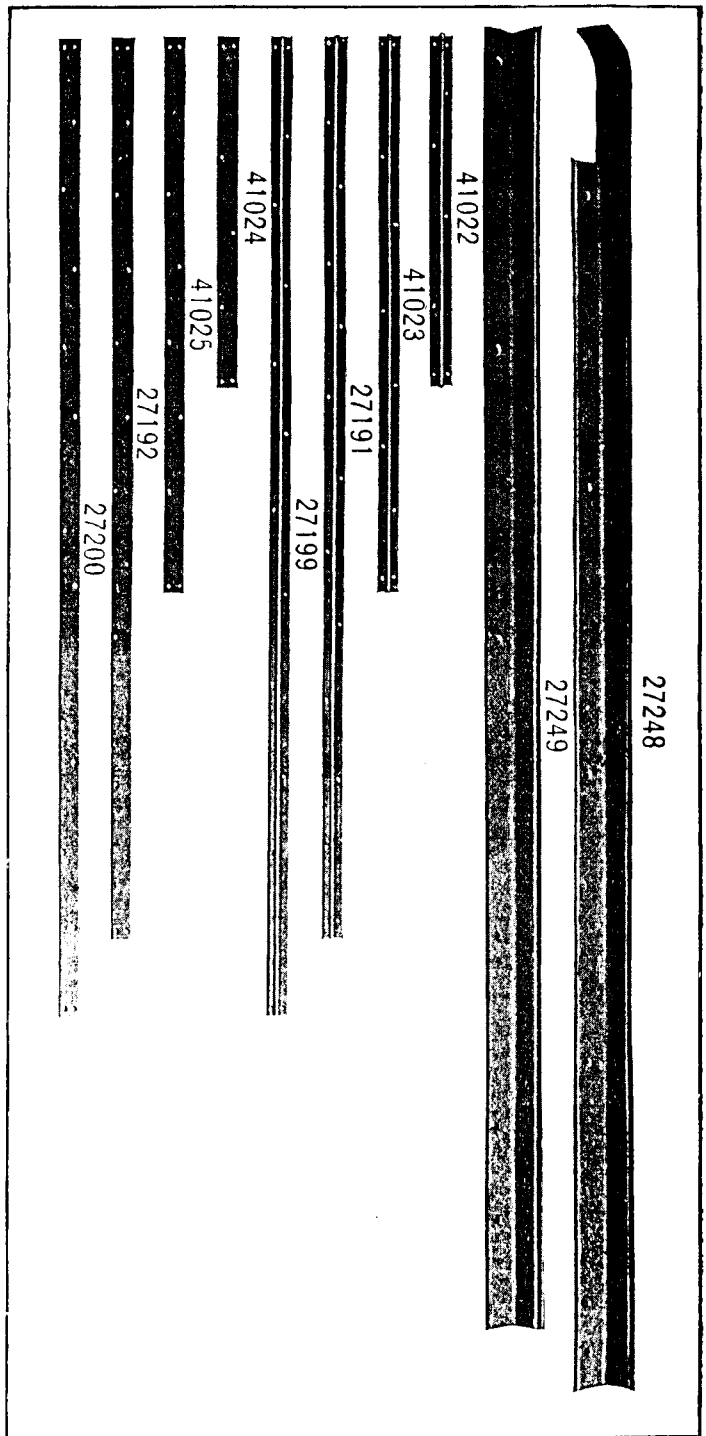


PLATE 3550—ONE-NINTH SIZE

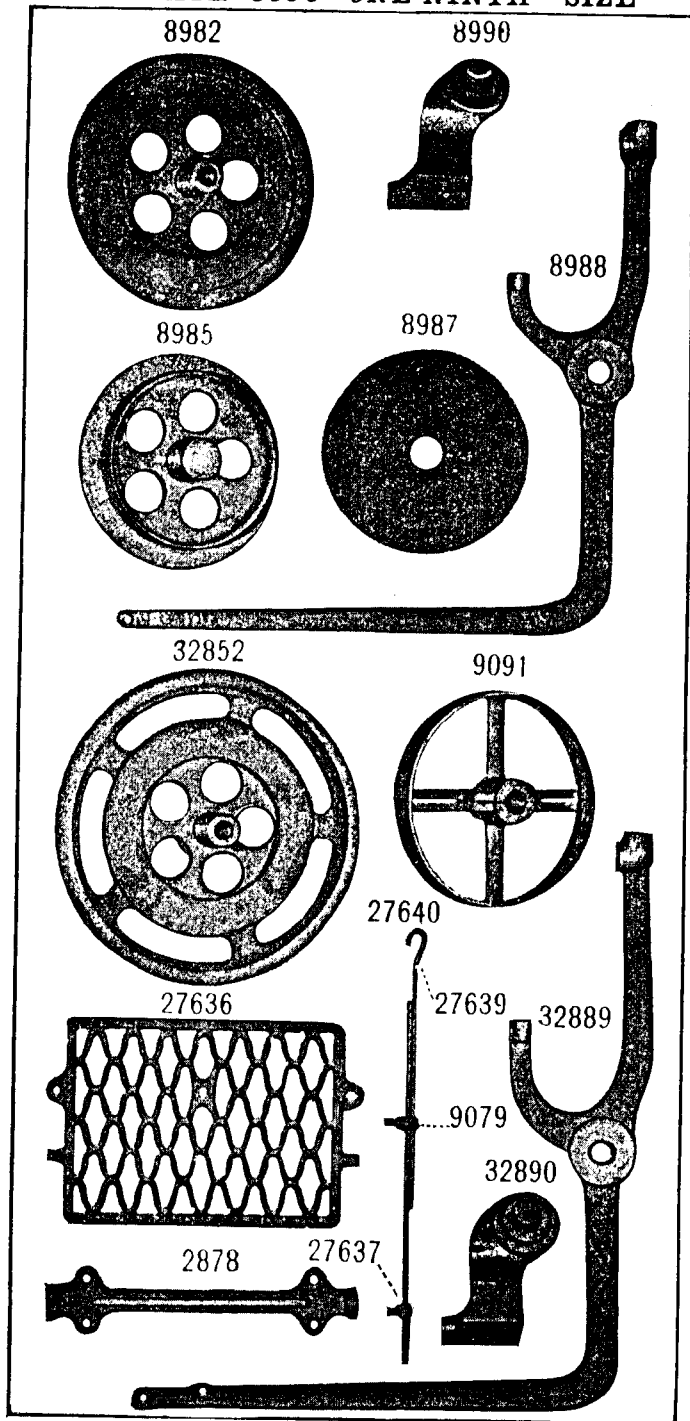


PLATE 3551—ONE-FOURTH SIZE

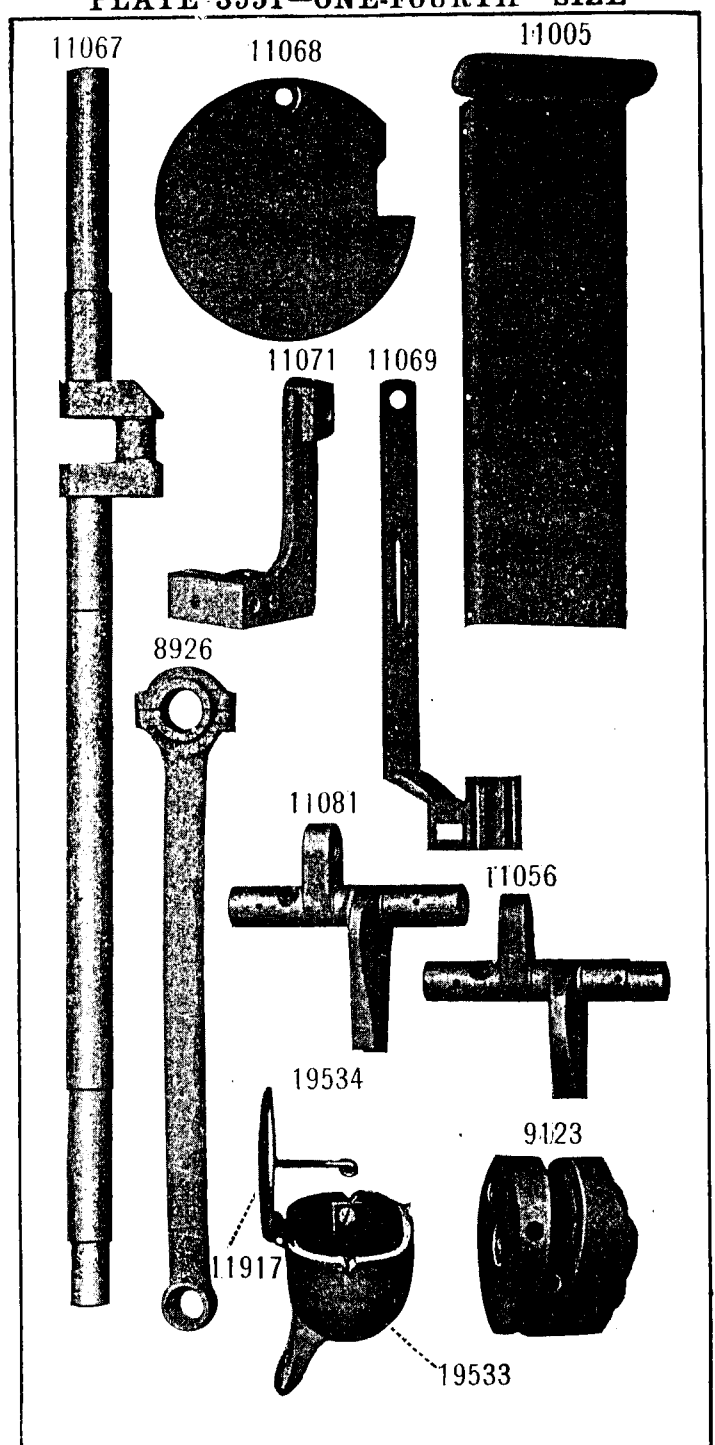


PLATE 3552—ONE-HALF SIZE

8745 11080 11019 11058

11062

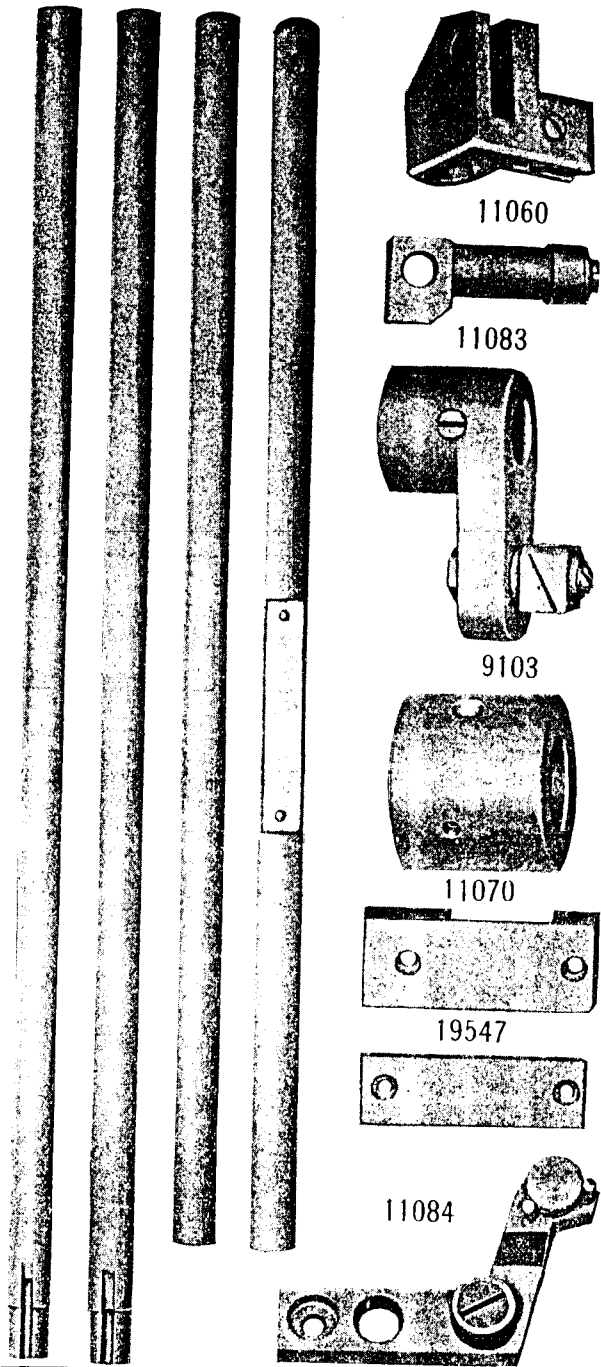


PLATE 3553—ONE-HALF SIZE

11073

11076

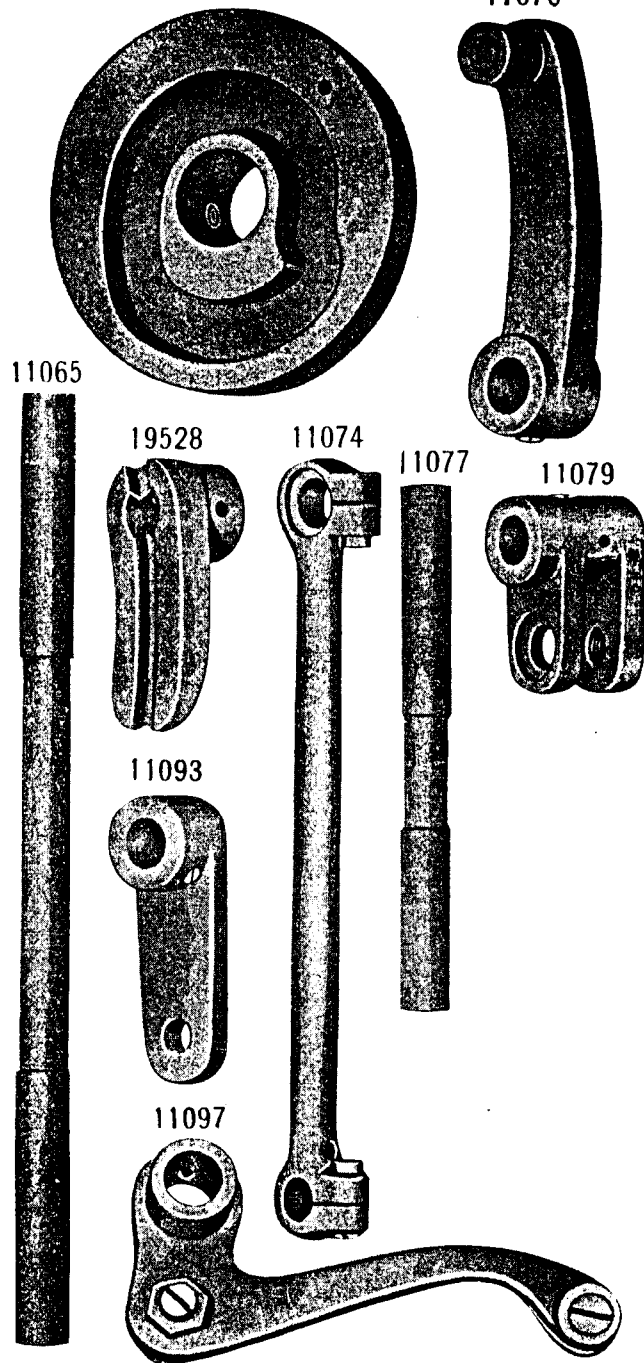
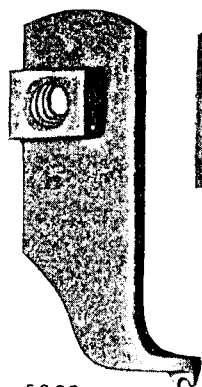
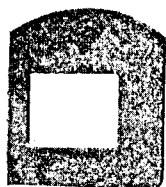


PLATE 3554—FULL SIZE

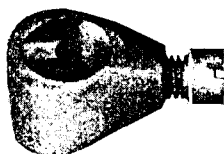
11014



11075



9060



11094



8749



11063



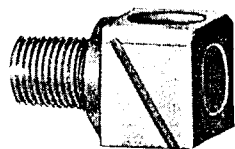
5968



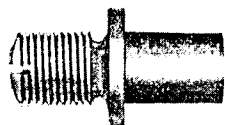
11064



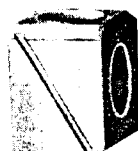
11078



1325



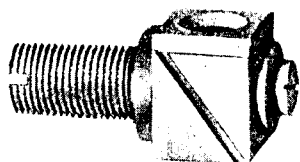
9119



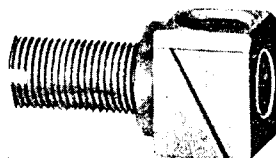
399



9120



32865



1016

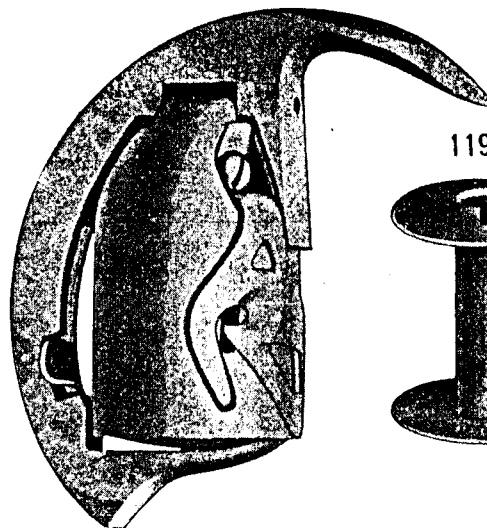


50171

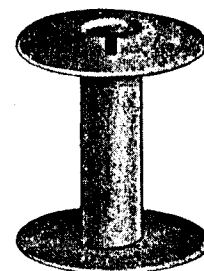


PLATE 3555—FULL SIZE

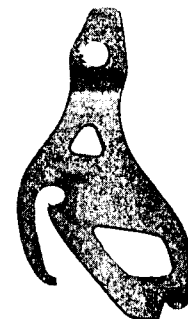
19871



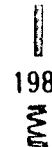
11910



8964



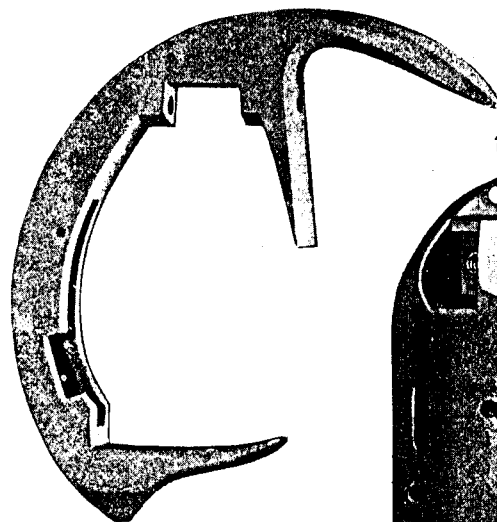
11853 2027 8961 773



19869



19870

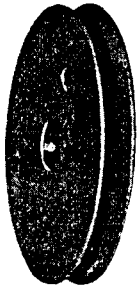


11852

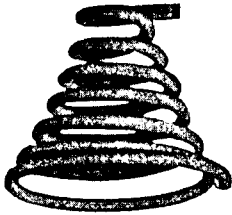


PLATE 3556—FULL SIZE

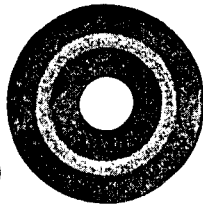
11044



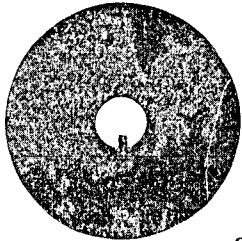
8791



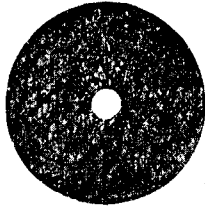
2102



11043



8879



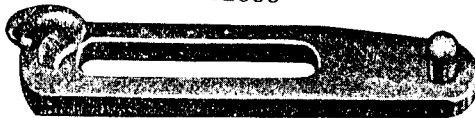
2103



9046



32888



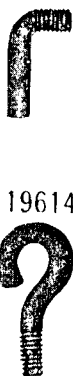
11950



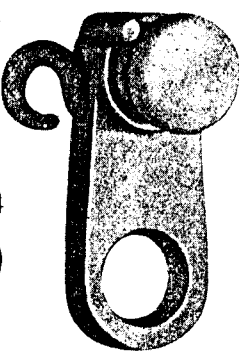
16947



11091



11090



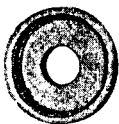
19614



11087



11086



11085



8905

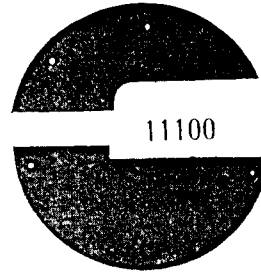


PLATE 3557—ONE-FOURTH SIZE

11099



32851



11100

32855

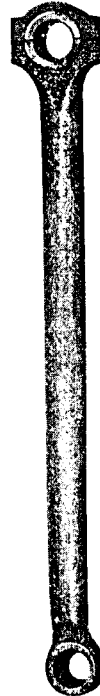


32877

32869



32853



32860



PLATE 3558—ONE-HALF SIZE

8758 32874 32880 32881

16996

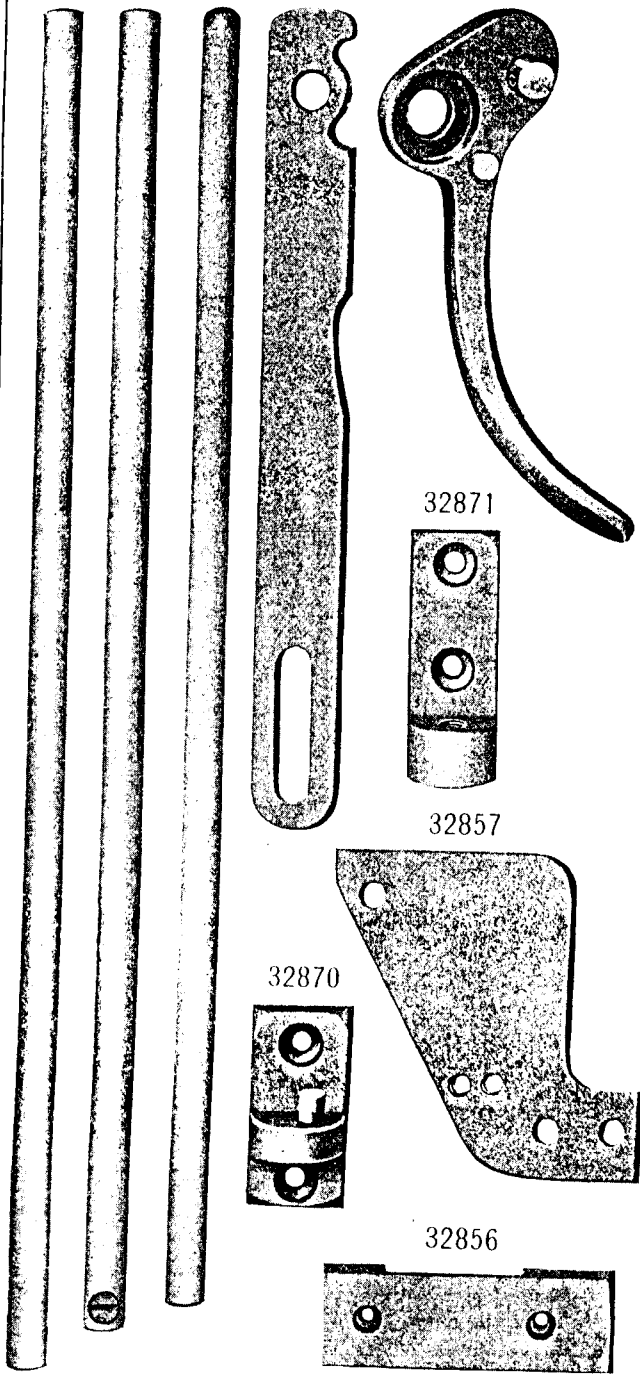


PLATE 3559—ONE-HALF SIZE

32858

32864

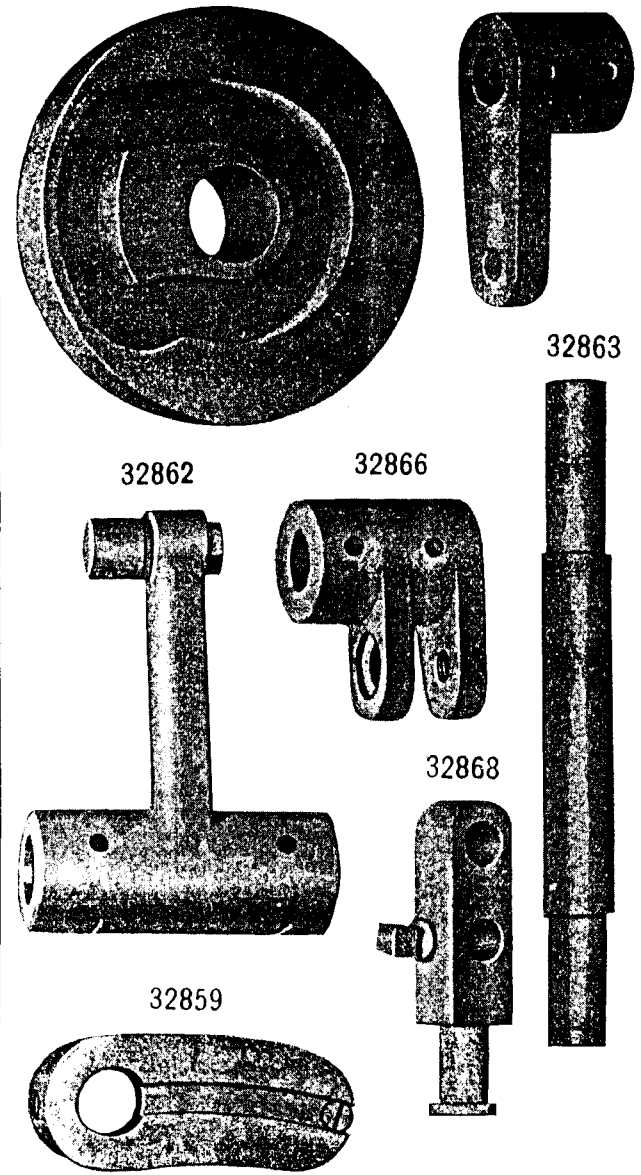
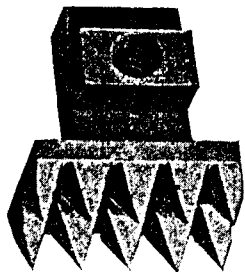
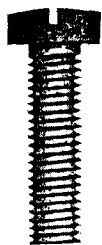


PLATE 3560—FULL SIZE

32867



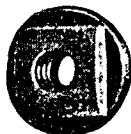
50172



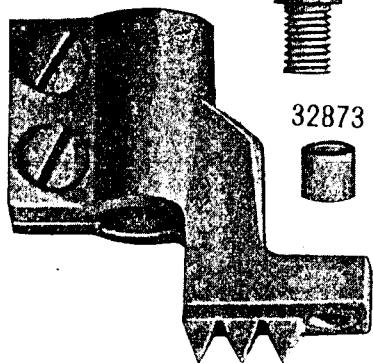
17738



1599



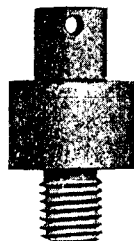
32872



168



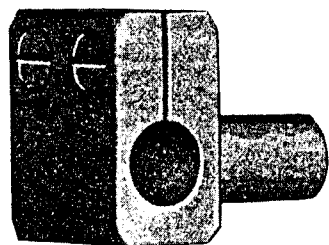
9140



32873



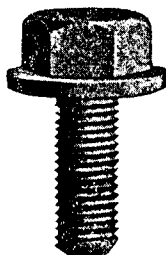
32875



1149



523



9108

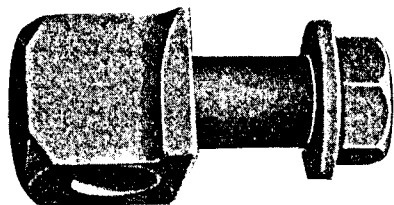
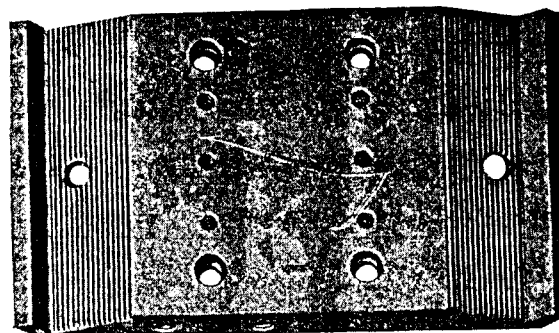
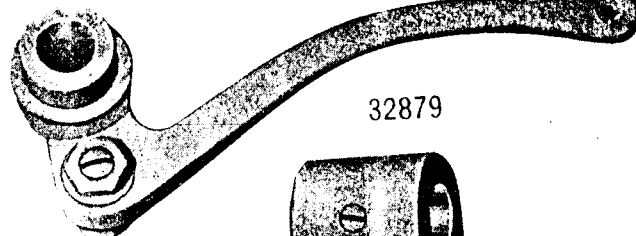


PLATE 3561—ONE-HALF SIZE

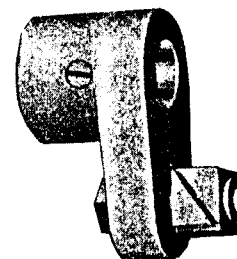
32876



32887



32879



32882

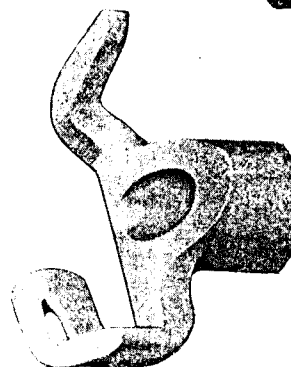
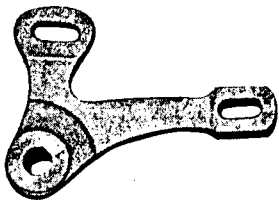
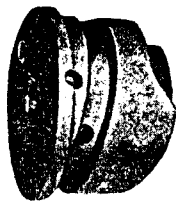


PLATE 3562—ONE-FOURTH SIZE

9146



32886



32893



11754

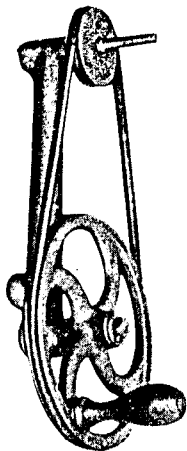
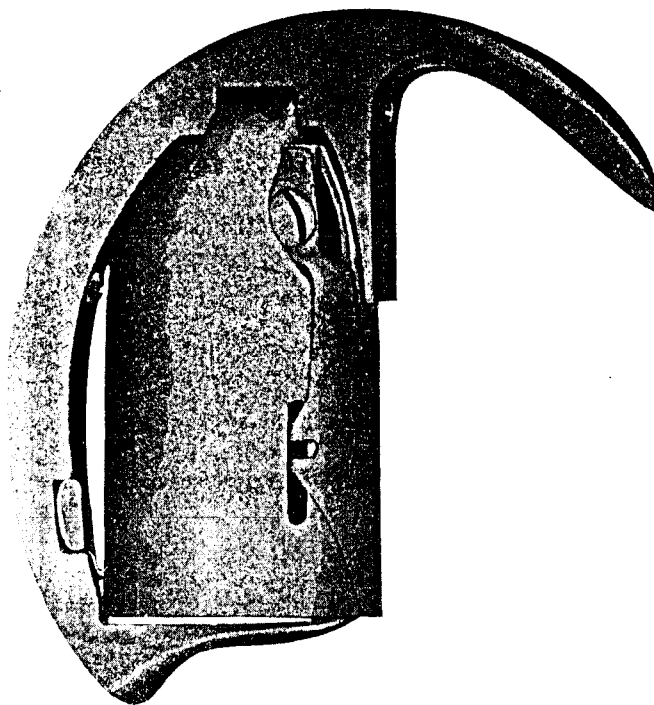


PLATE 3563—FULL SIZE

19844



16901

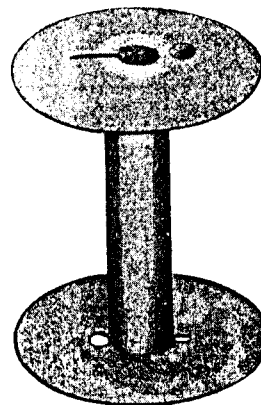
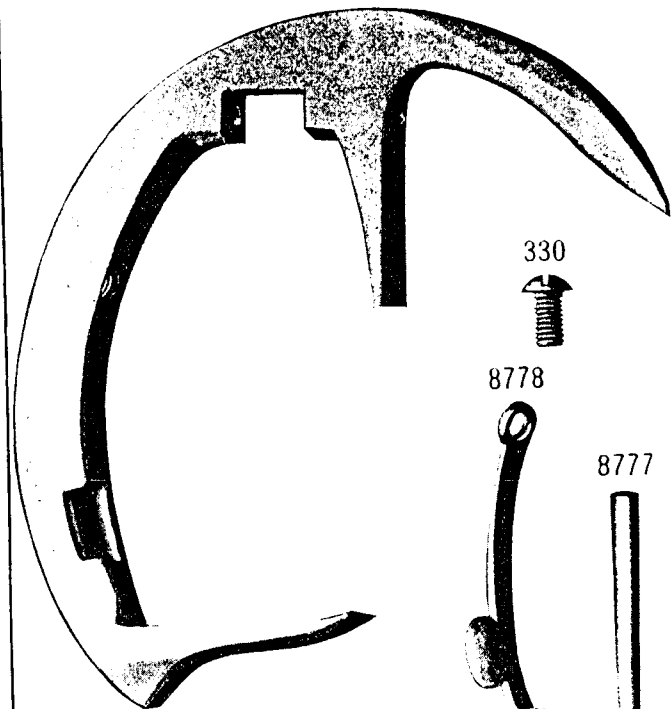


PLATE 3564—FULL SIZE

19843



330



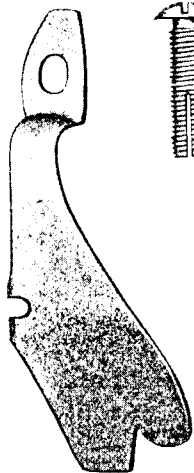
8778



8777



8780



1323



8776

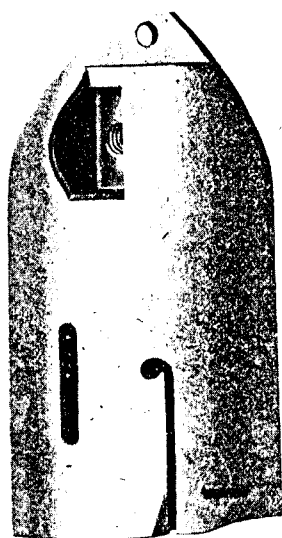
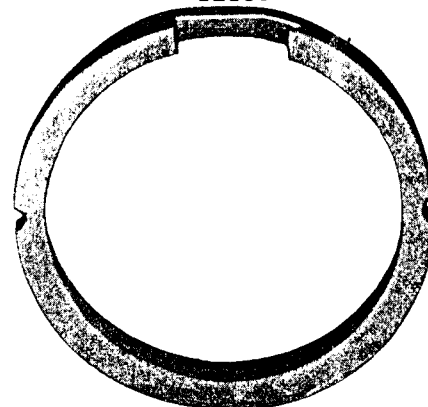
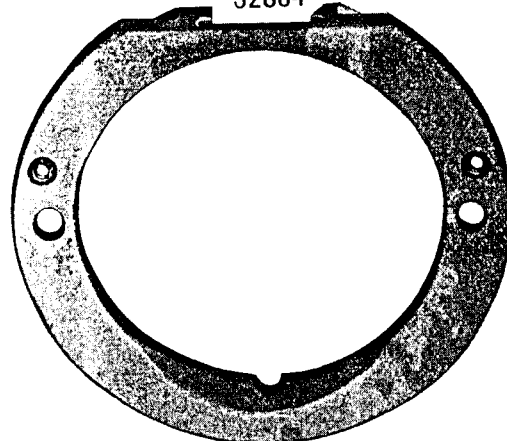


PLATE 3565—ONE-HALF SIZE

32883



32884



32885

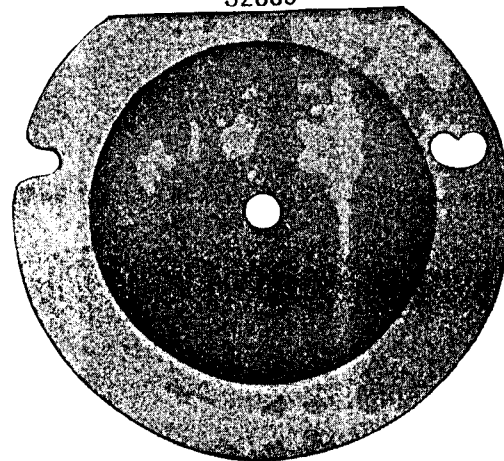


PLATE 3566—FULL SIZE

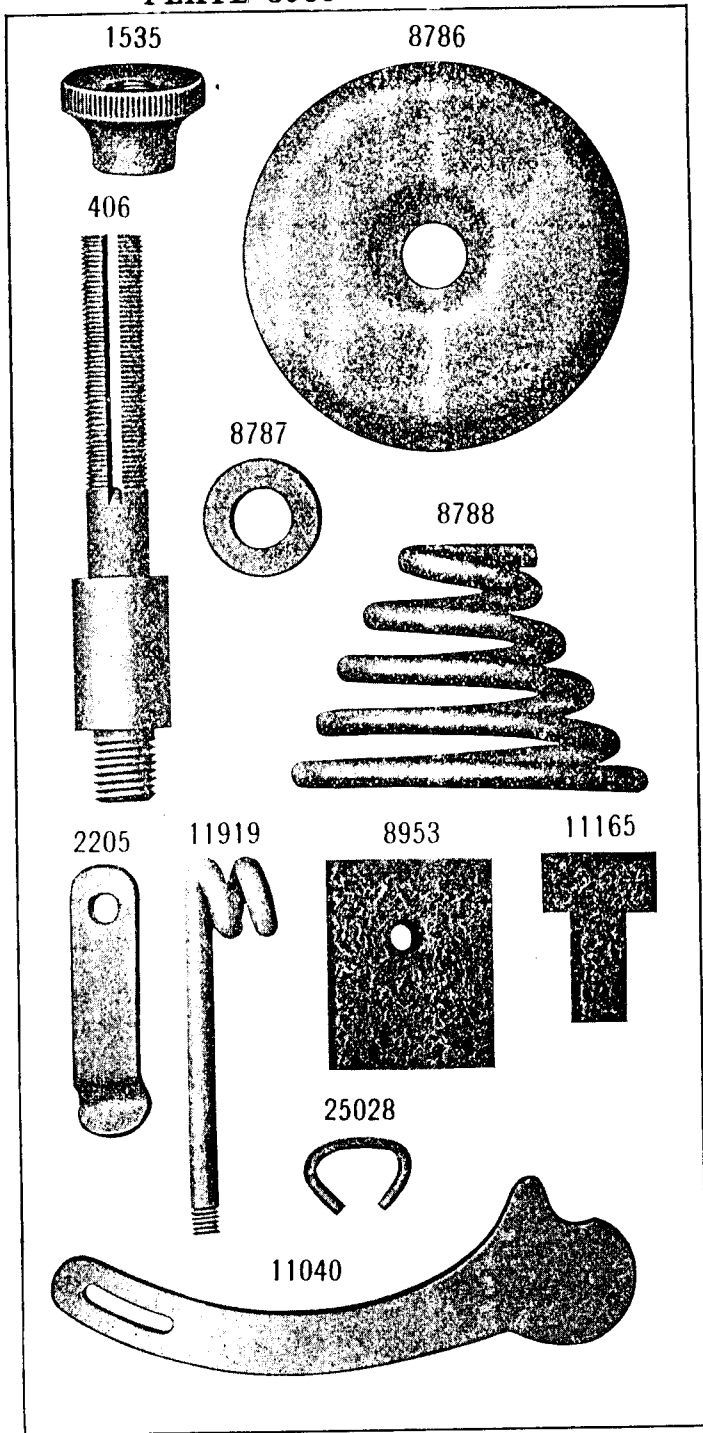


PLATE 3567—FULL SIZE

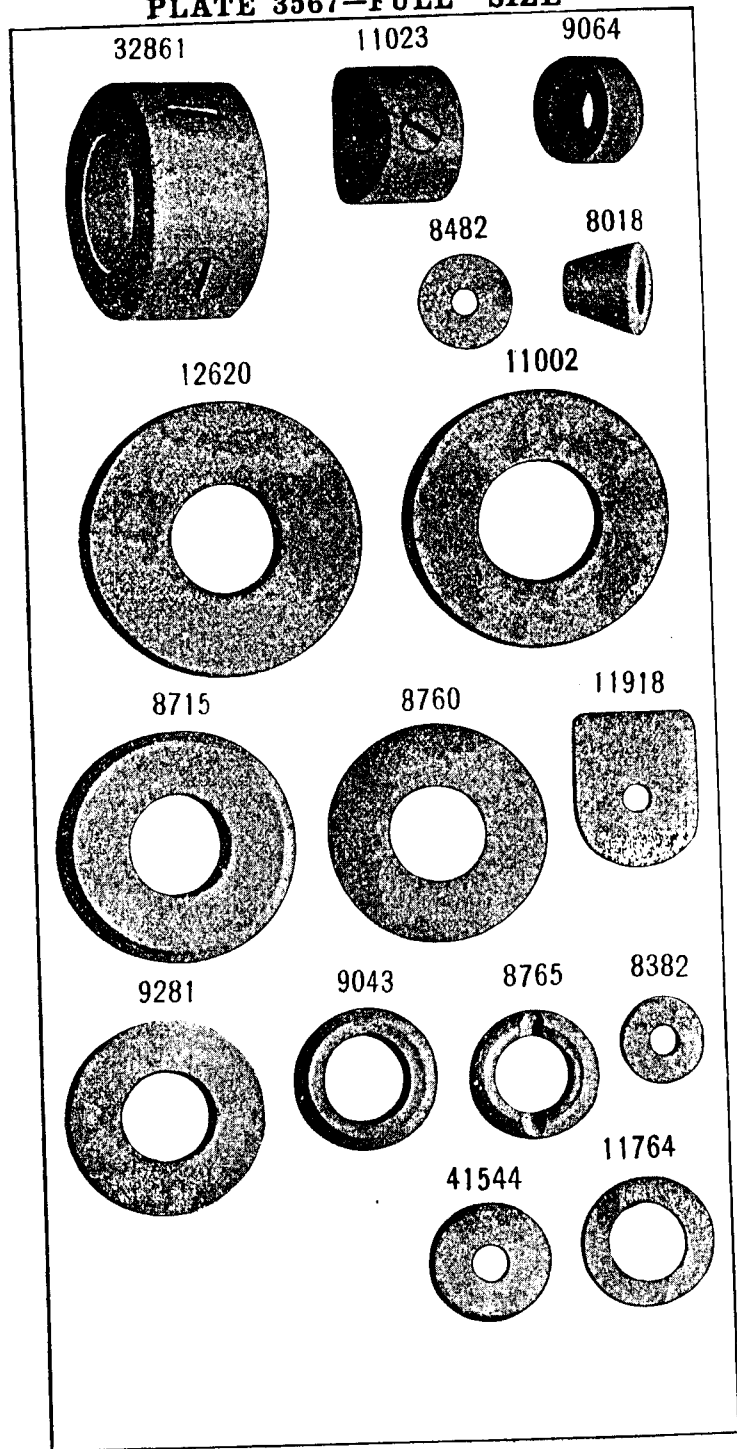


PLATE 3568—FULL SIZE

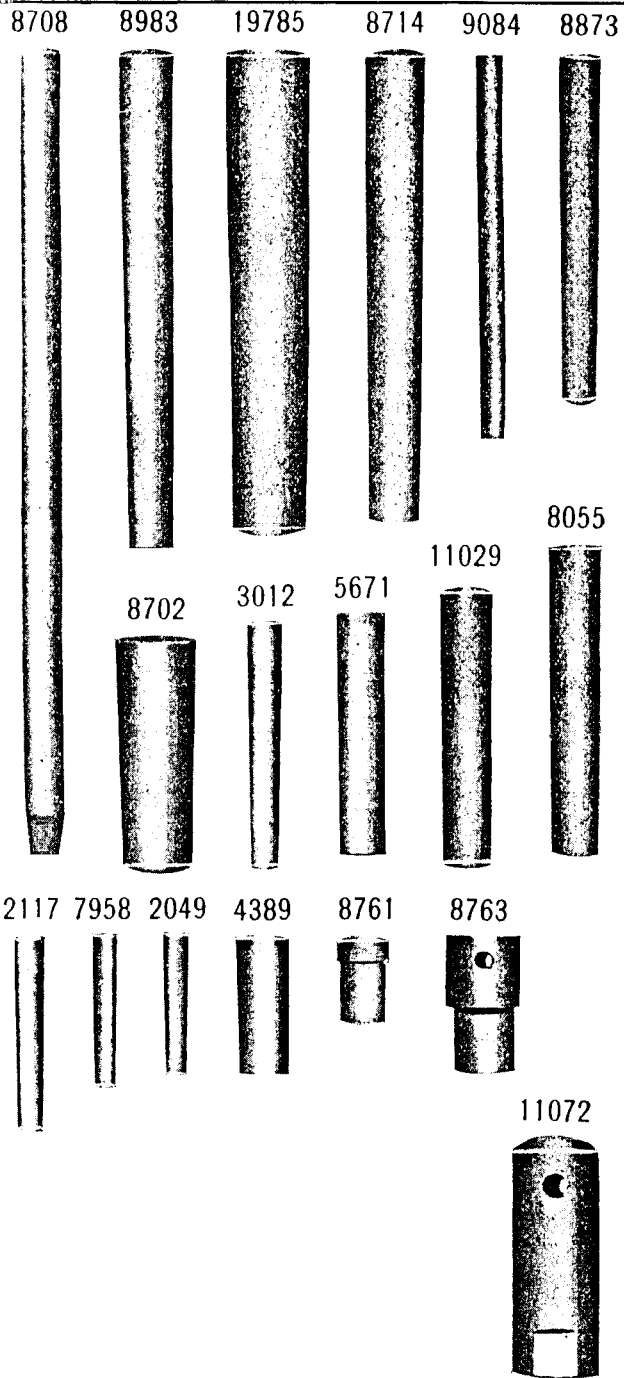


PLATE 3569—FULL SIZE

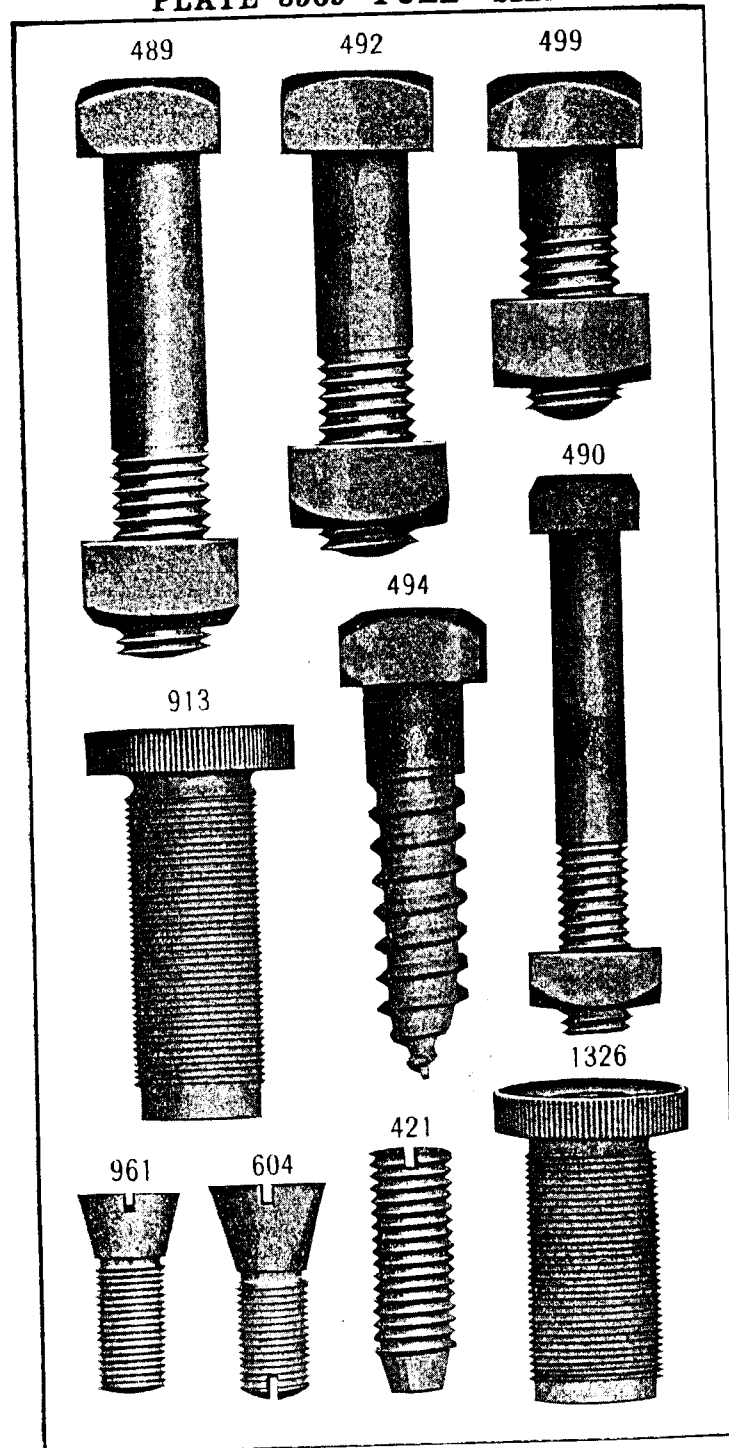


PLATE 3570—FULL SIZE

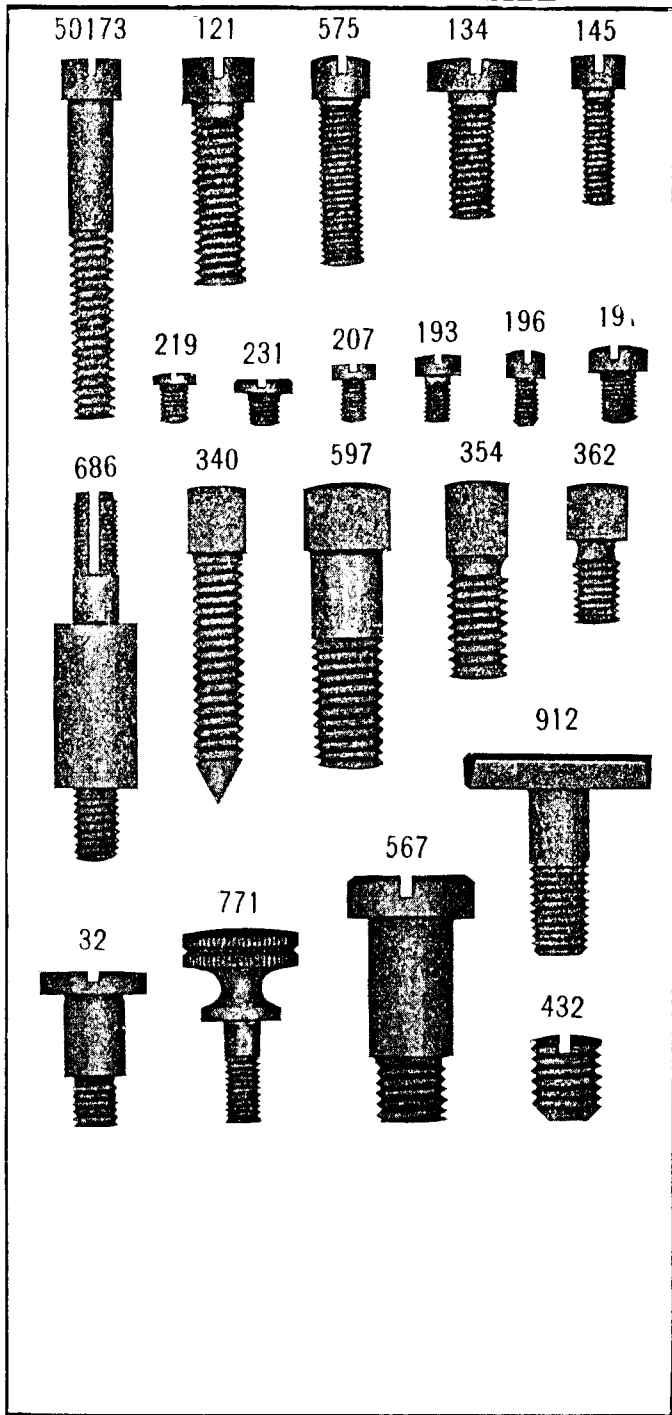


PLATE 3571—FULL-SIZE

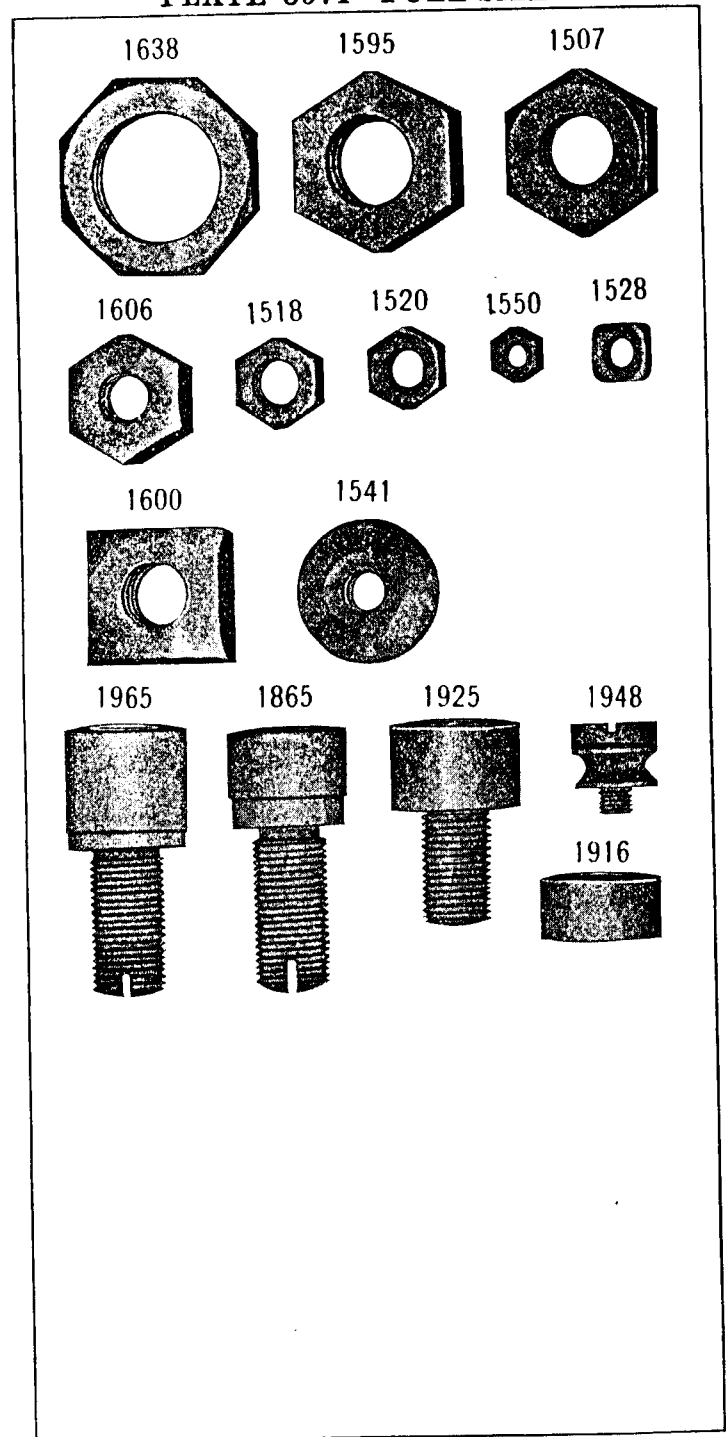
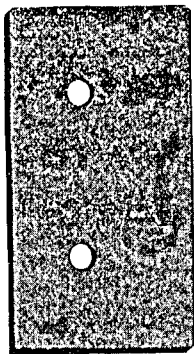


PLATE 3572—FULL SIZE

8980



8989



11735



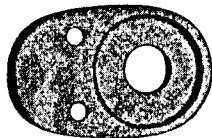
11732



11731



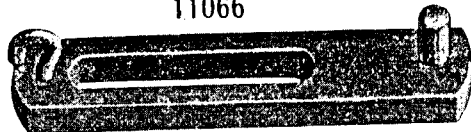
11733



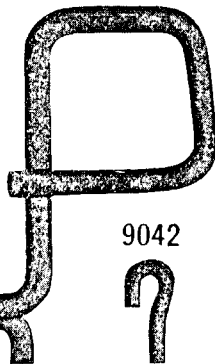
8077



11066



11046



27638



8734



8019



9042



9082



11052



2762

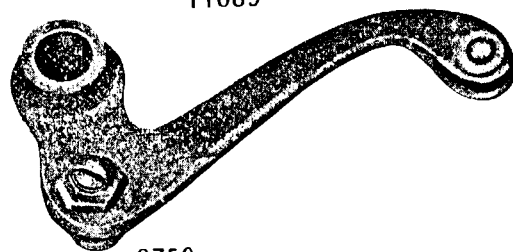


362



PLATE 3573—ONE-HALF SIZE

11089



8759

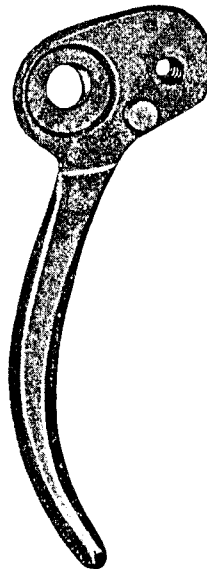
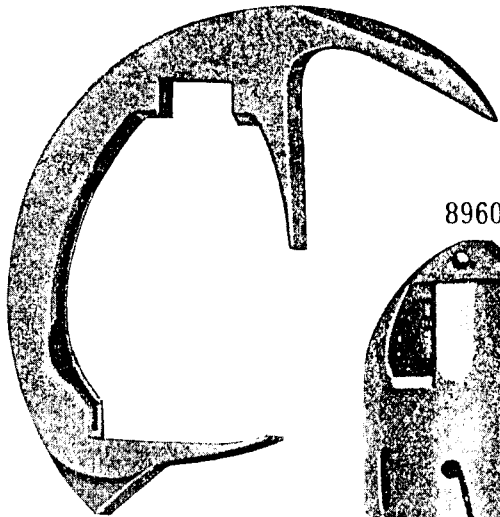
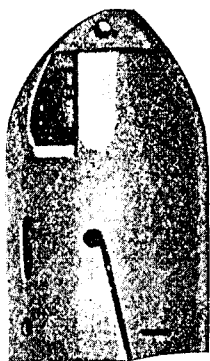


PLATE 3574—FULL SIZE

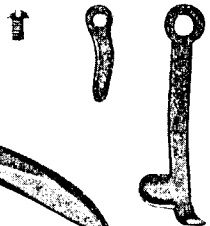
8963



8960



590 11854 8962



11855

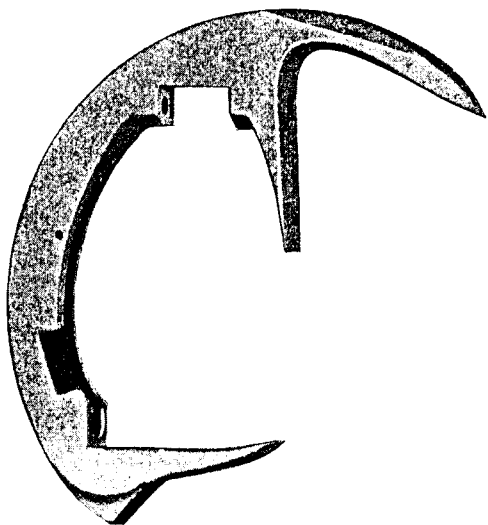
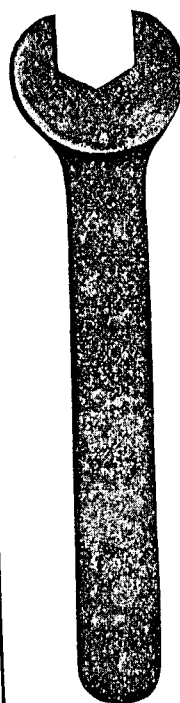
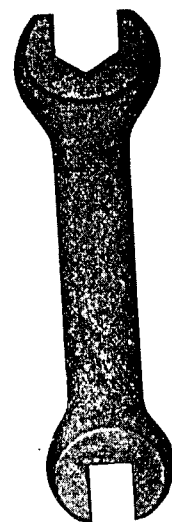


PLATE 3575—ONE-HALF SIZE

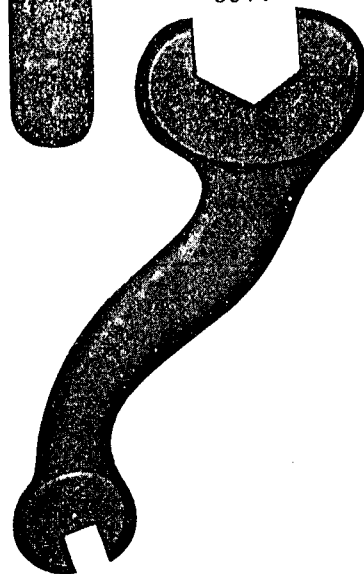
9155



8910



8911



8909



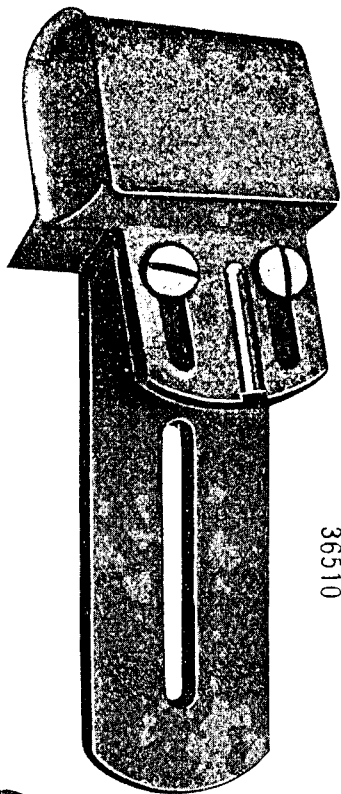
25200



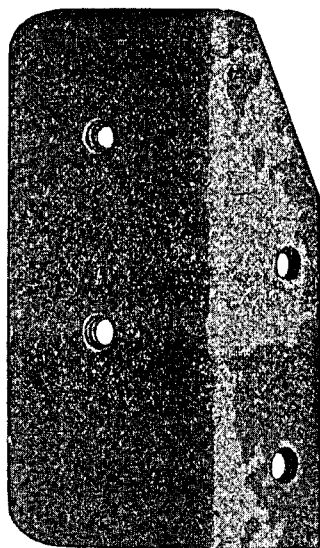
4822



PLATE 3576—FULL SIZE



36510



36511

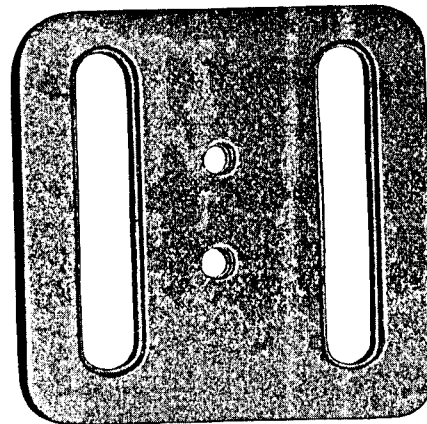


217

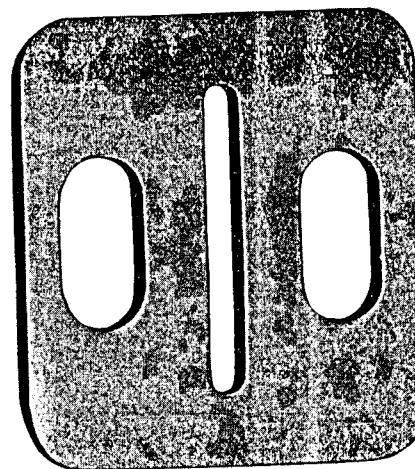


164

PLATE 3577—FULL SIZE



36512



36513



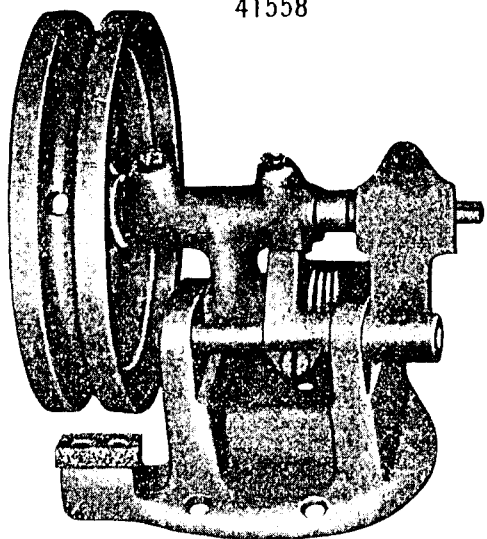
96



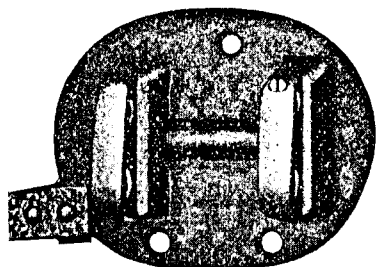
164

PLATE 3579—ONE-HALF SIZE

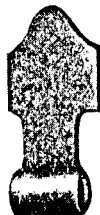
41558



41439



41557



41444

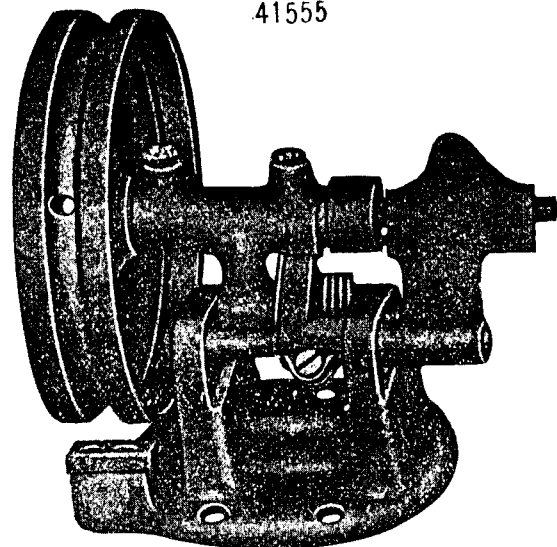


41446

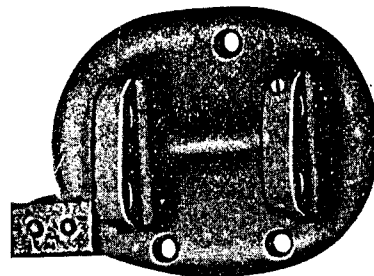


PLATE 3580—ONE-HALF SIZE

41555



41550



41554



41552

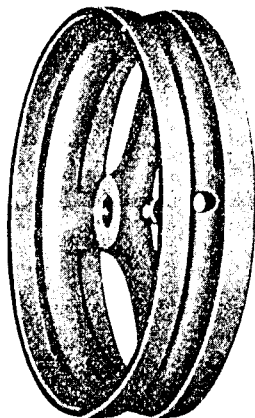


11107



PLATE 3581—ONE-HALF SIZE

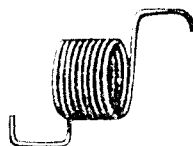
41443



41447



41442



41441



41440

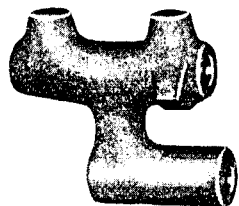


PLATE 3582—ONE-FOURTH-SIZE

41454



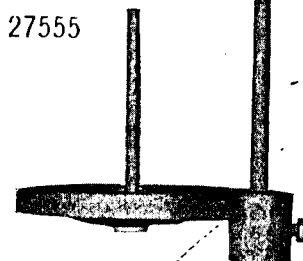
41452

41514



27560

27555



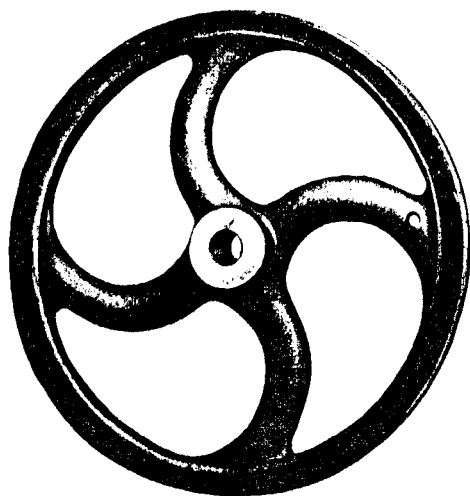
41450

27557



PLATE 6054—ONE-HALF SIZE

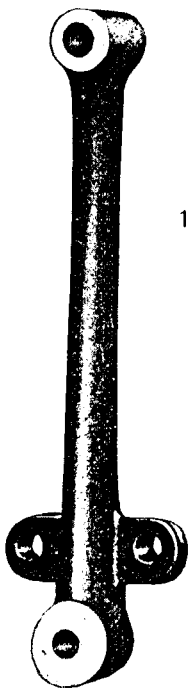
11760



11765



11758



11759



8380



11762



11763

