

SINGER
191K1,K2,K3

ILLUSTRATED
LIST OF PARTS
FOR
Nos. 191K1 to 191K3
MACHINES

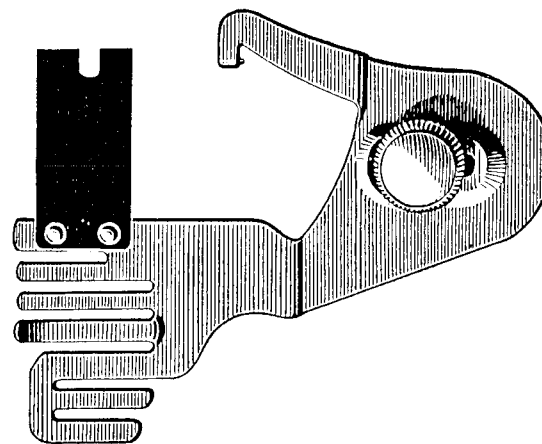

121170



121547

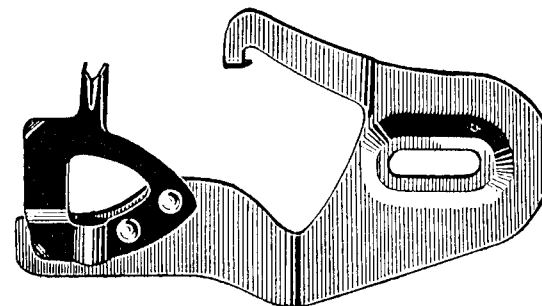

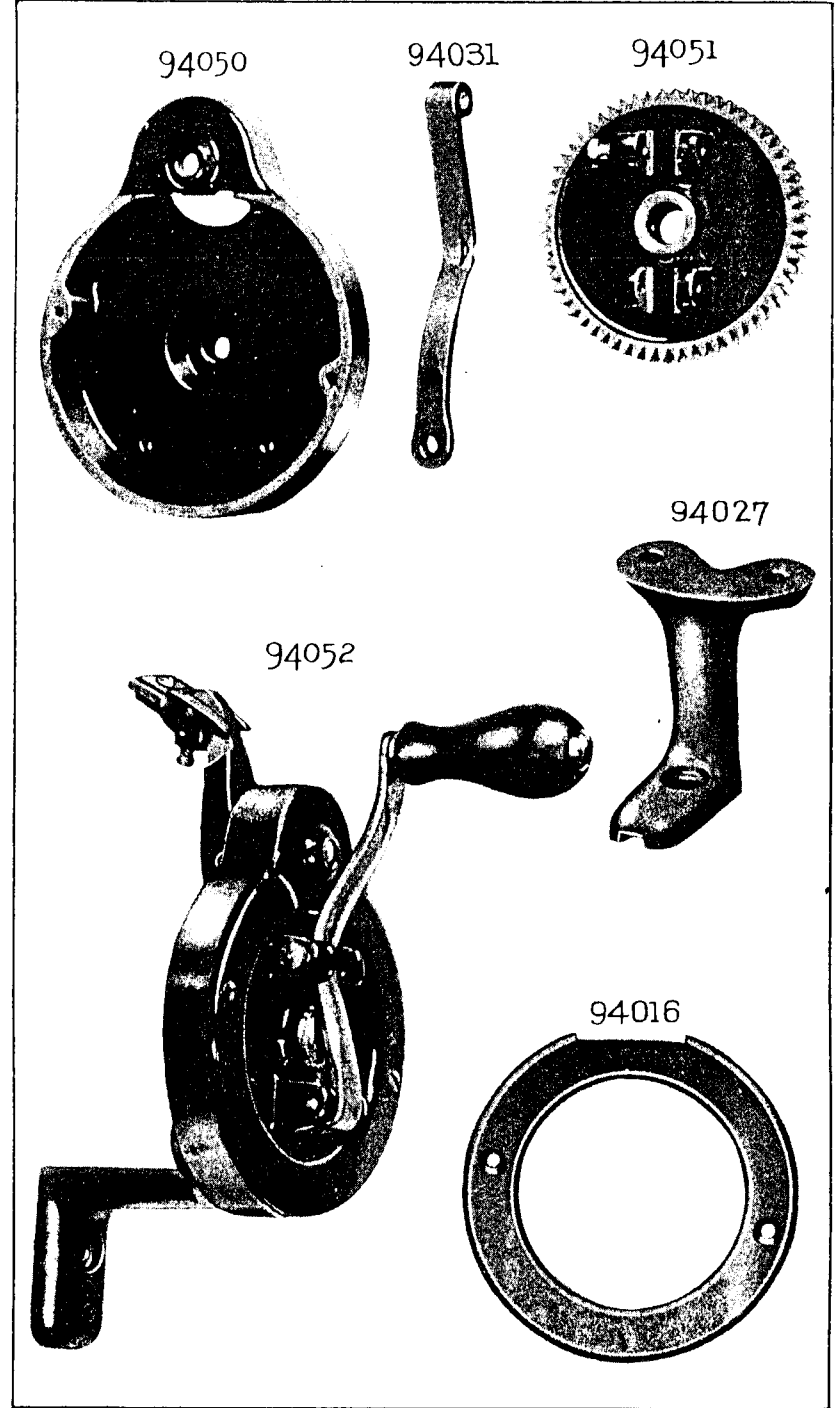
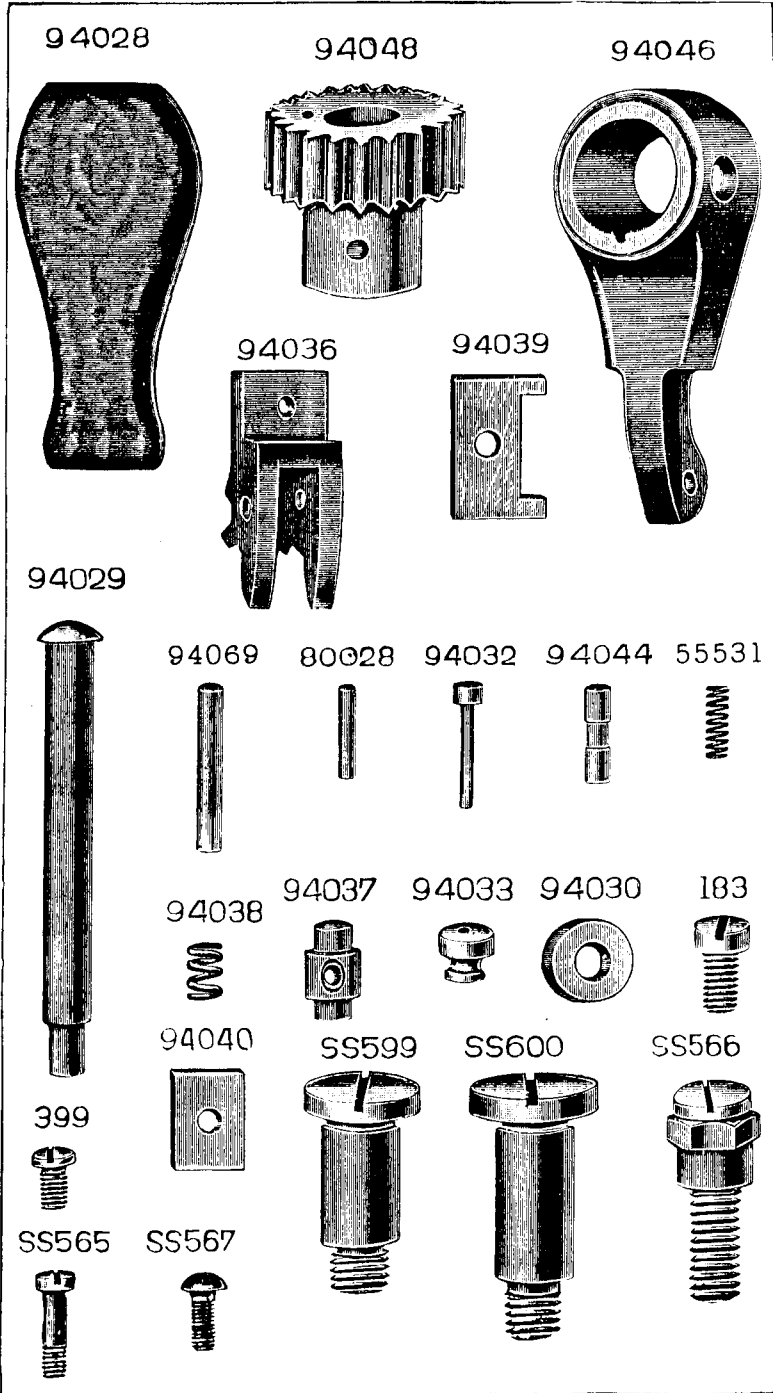

SS 528



96425



96426



96844

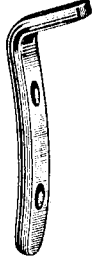

96427



96845



W95



86742

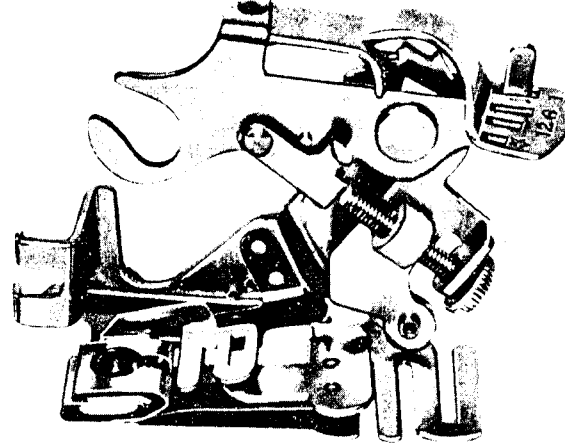

121441



36865

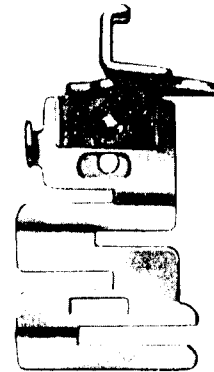

121464

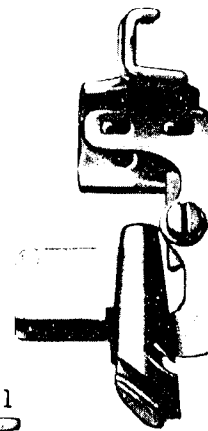

161295



161294



35931

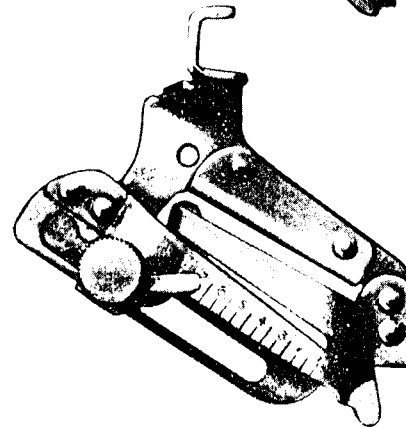

8879

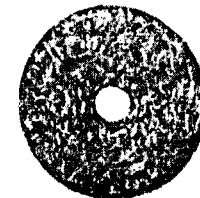

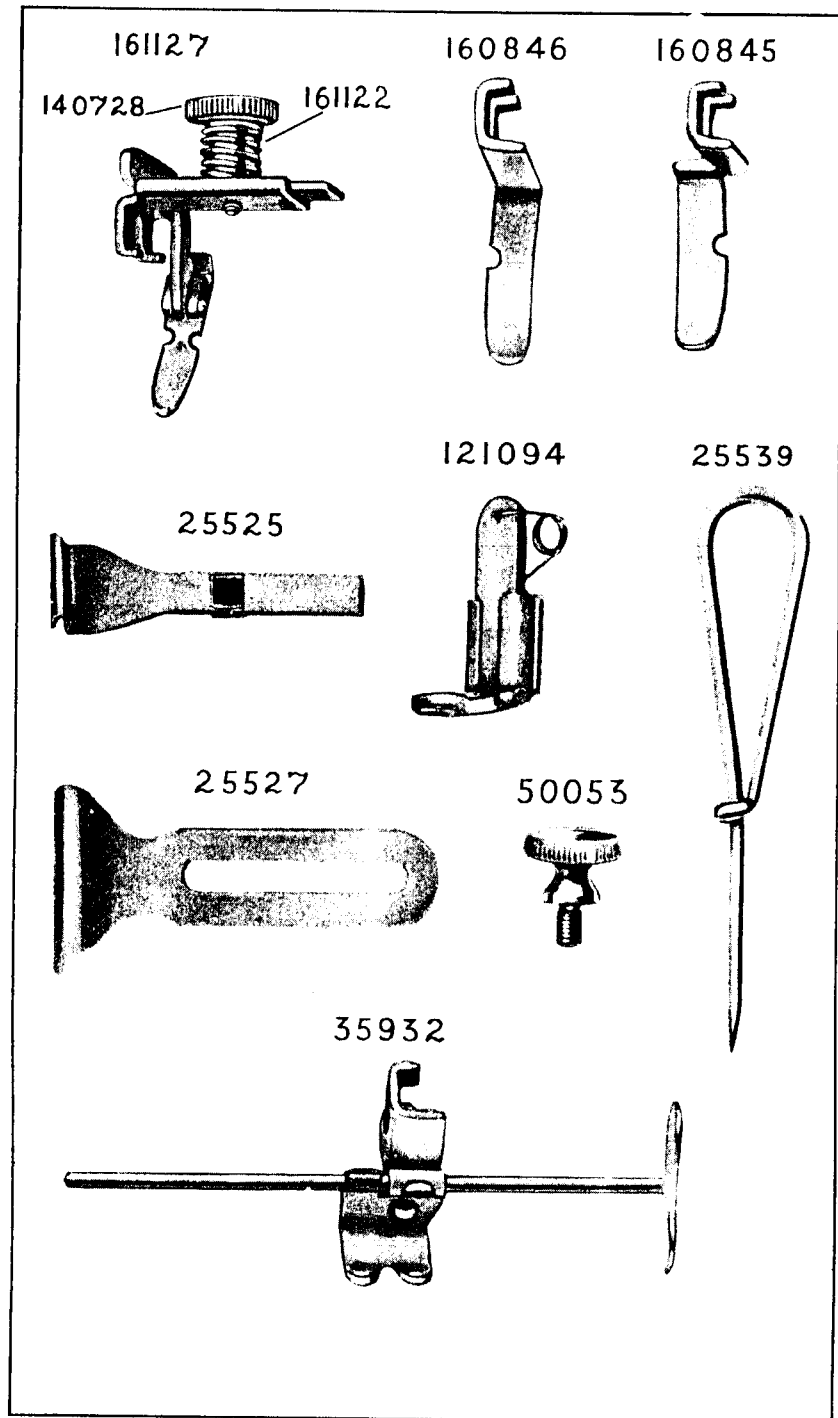
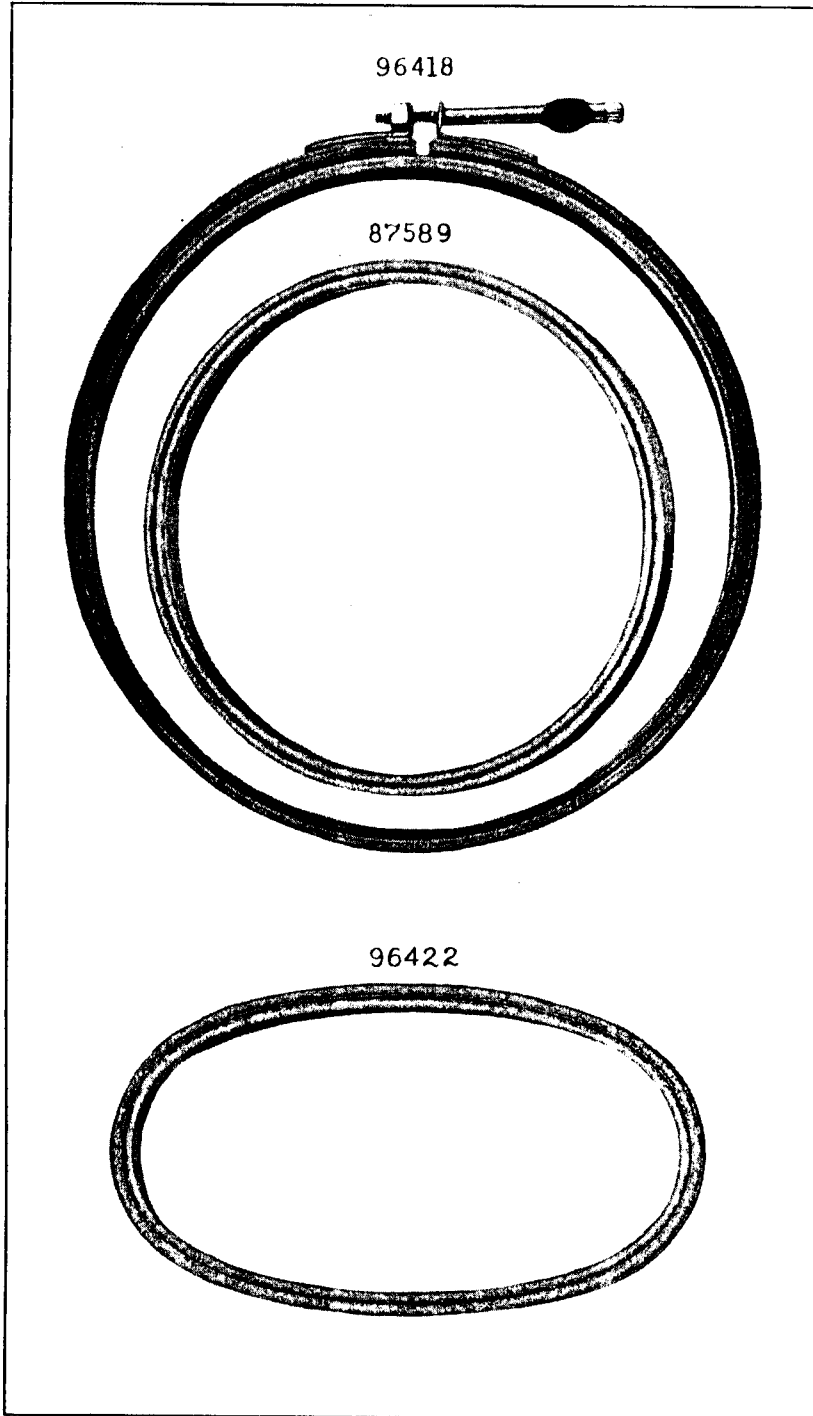

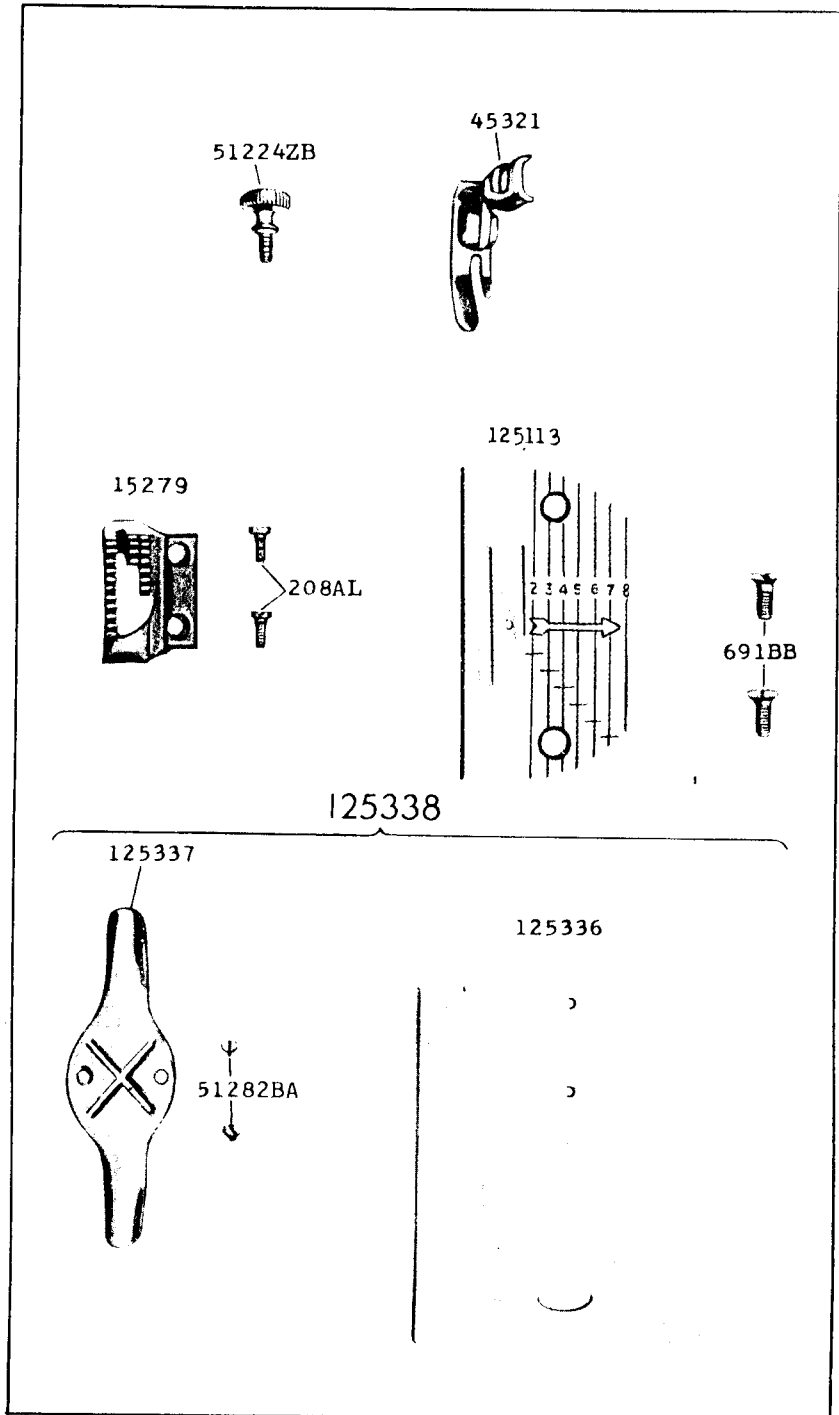
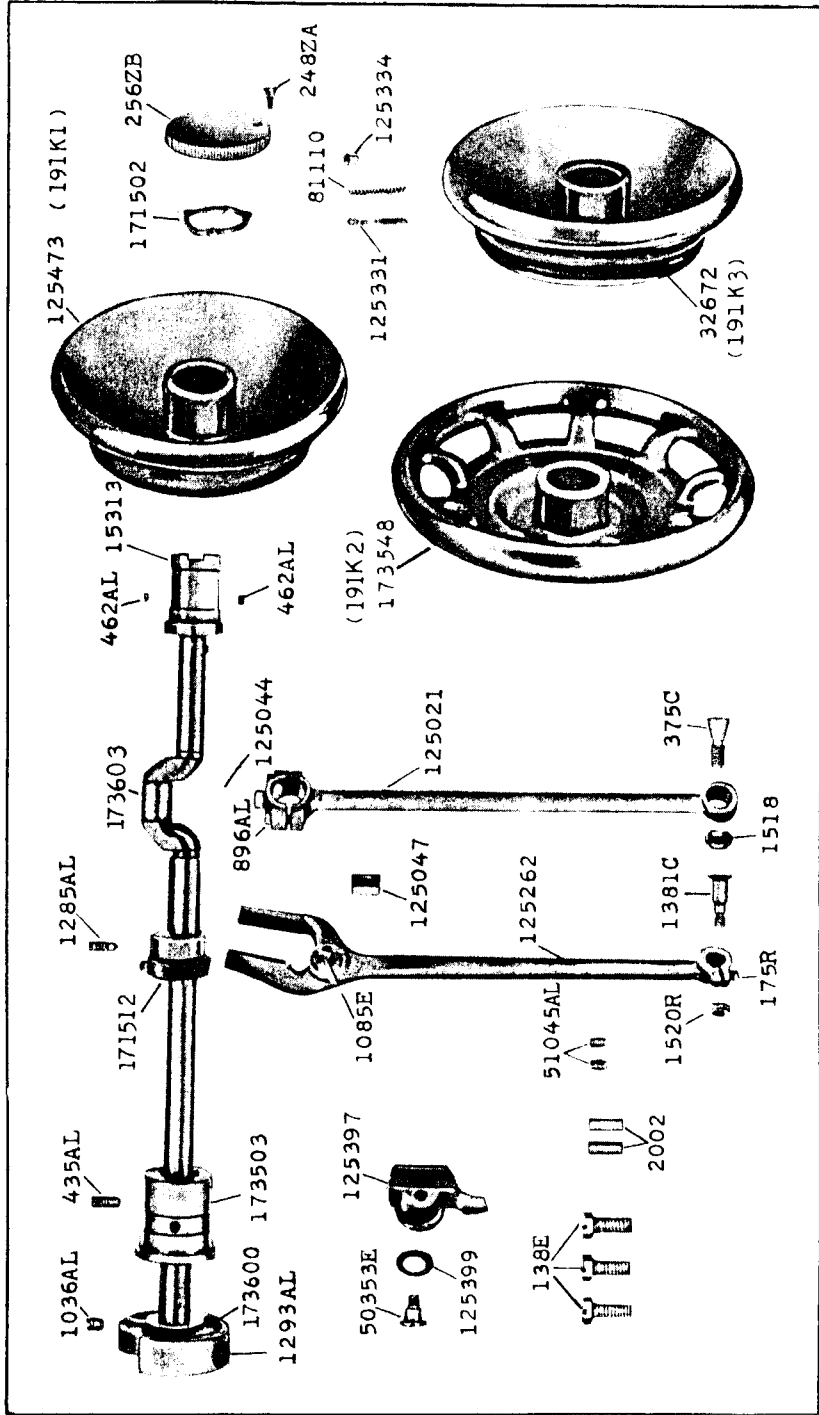

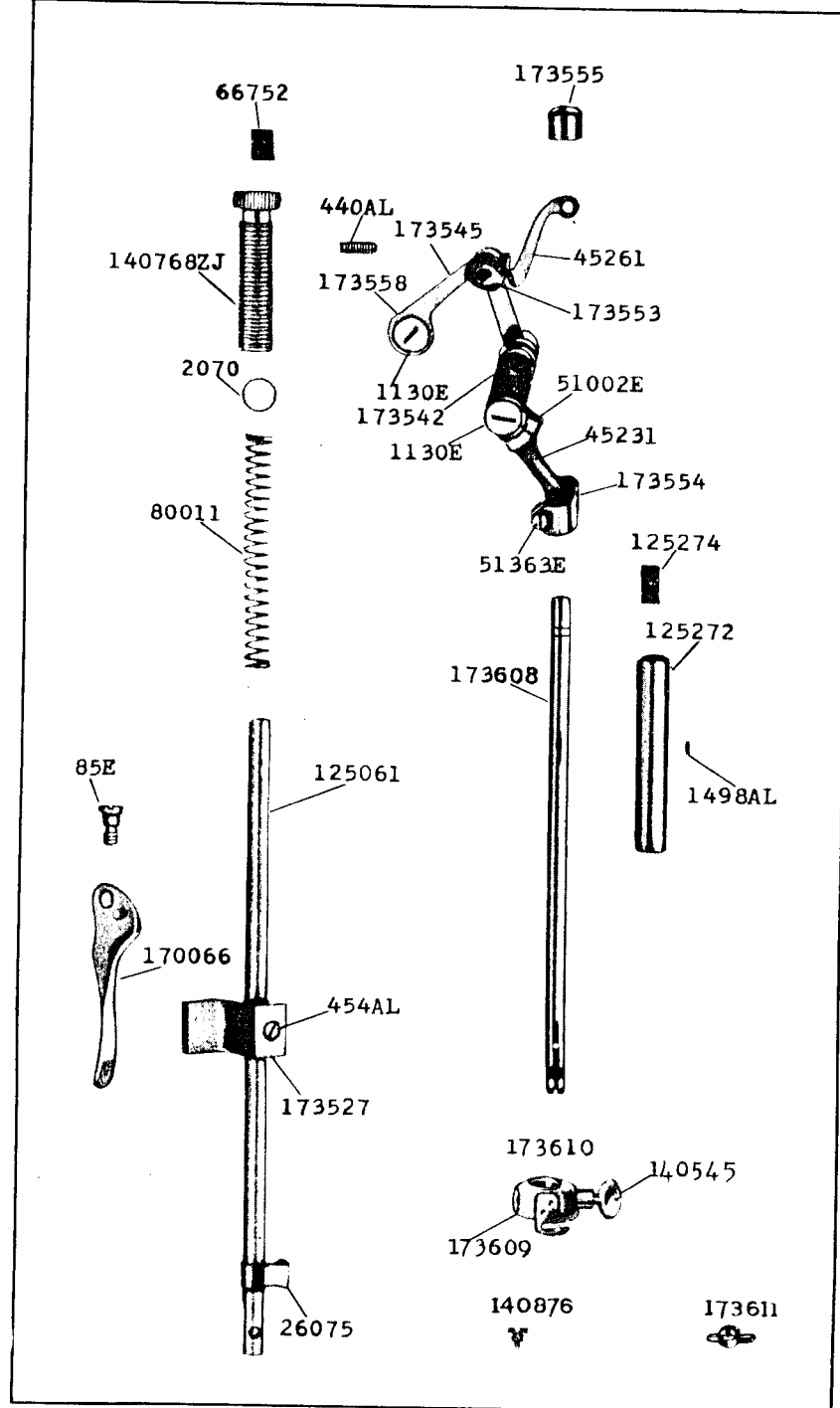
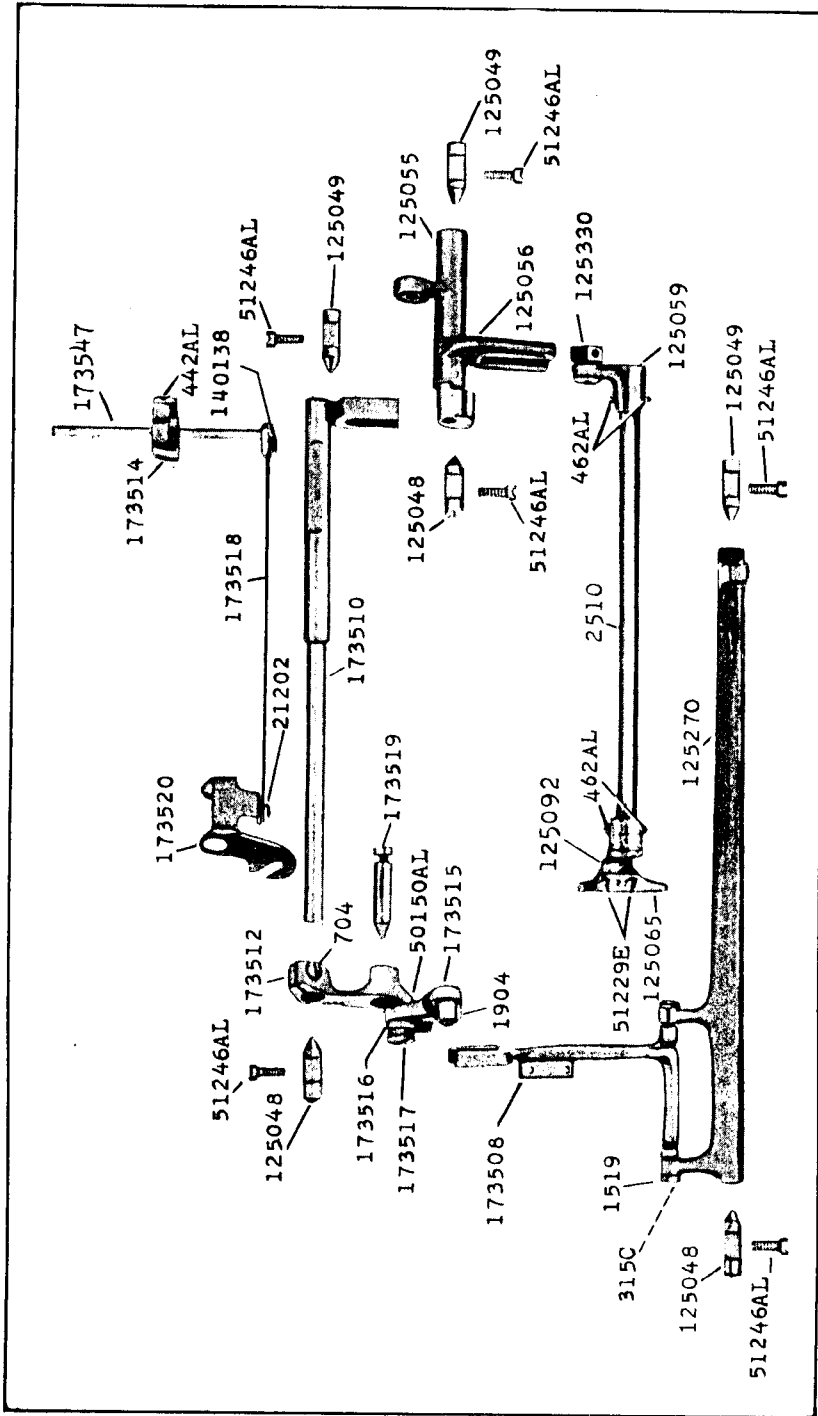

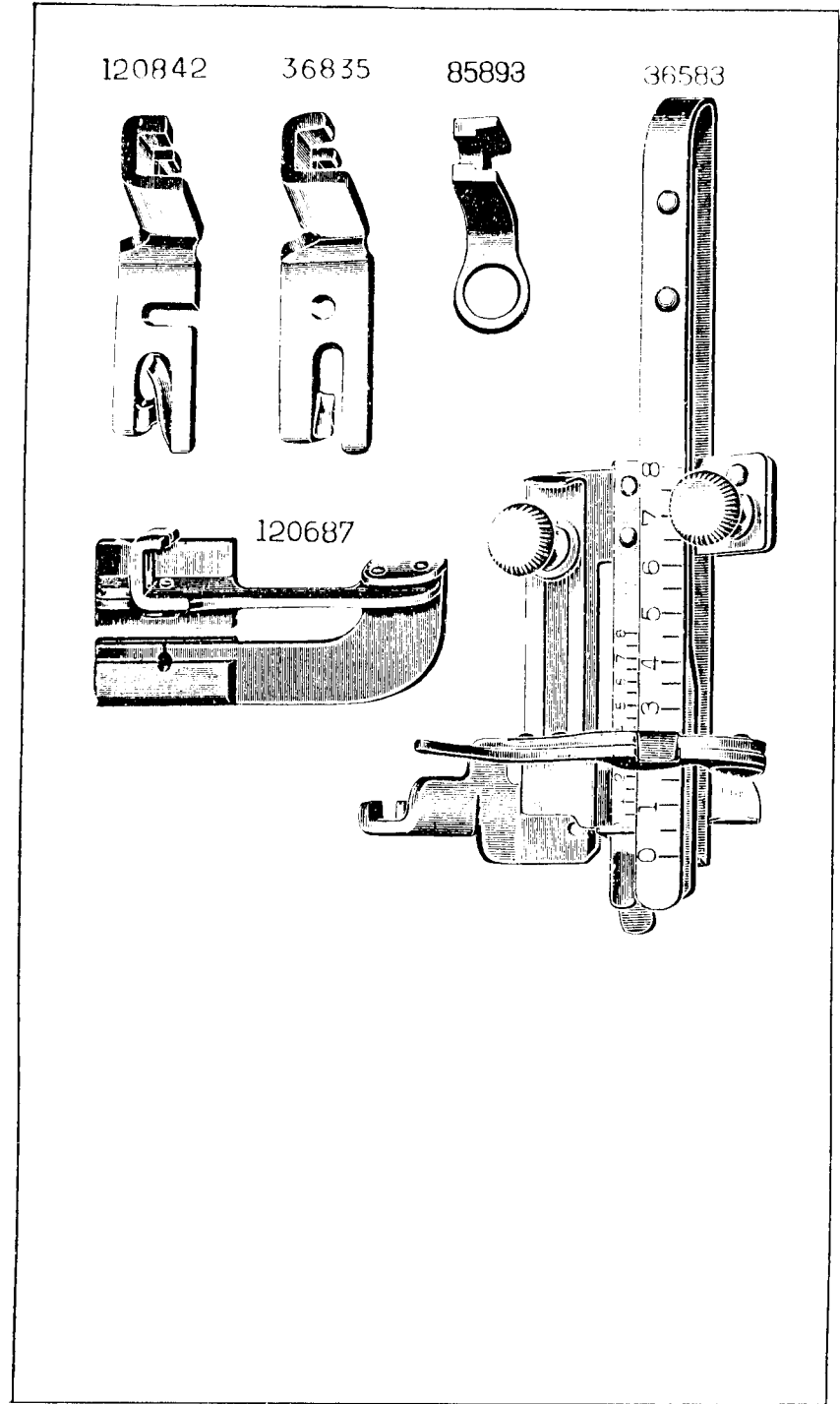
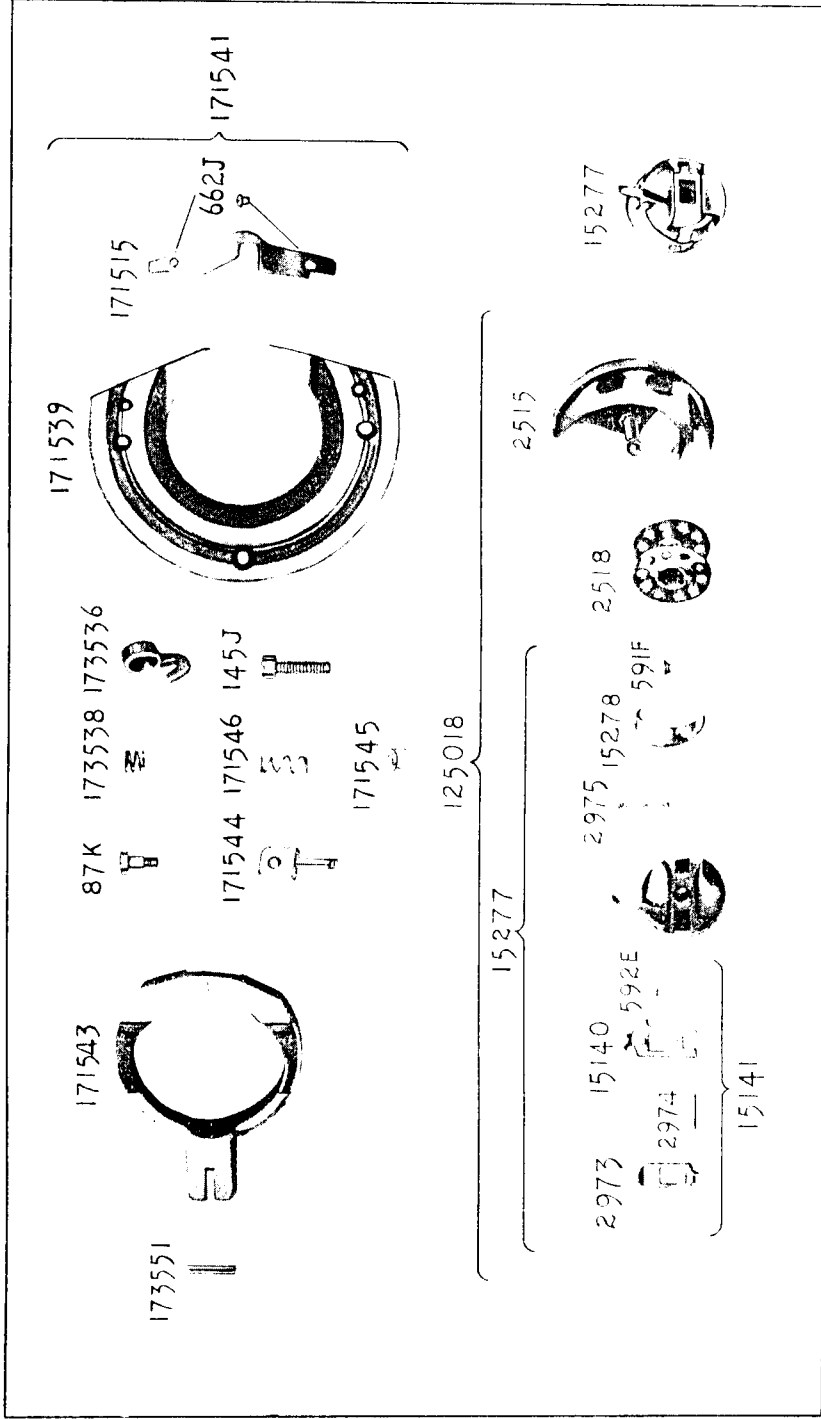

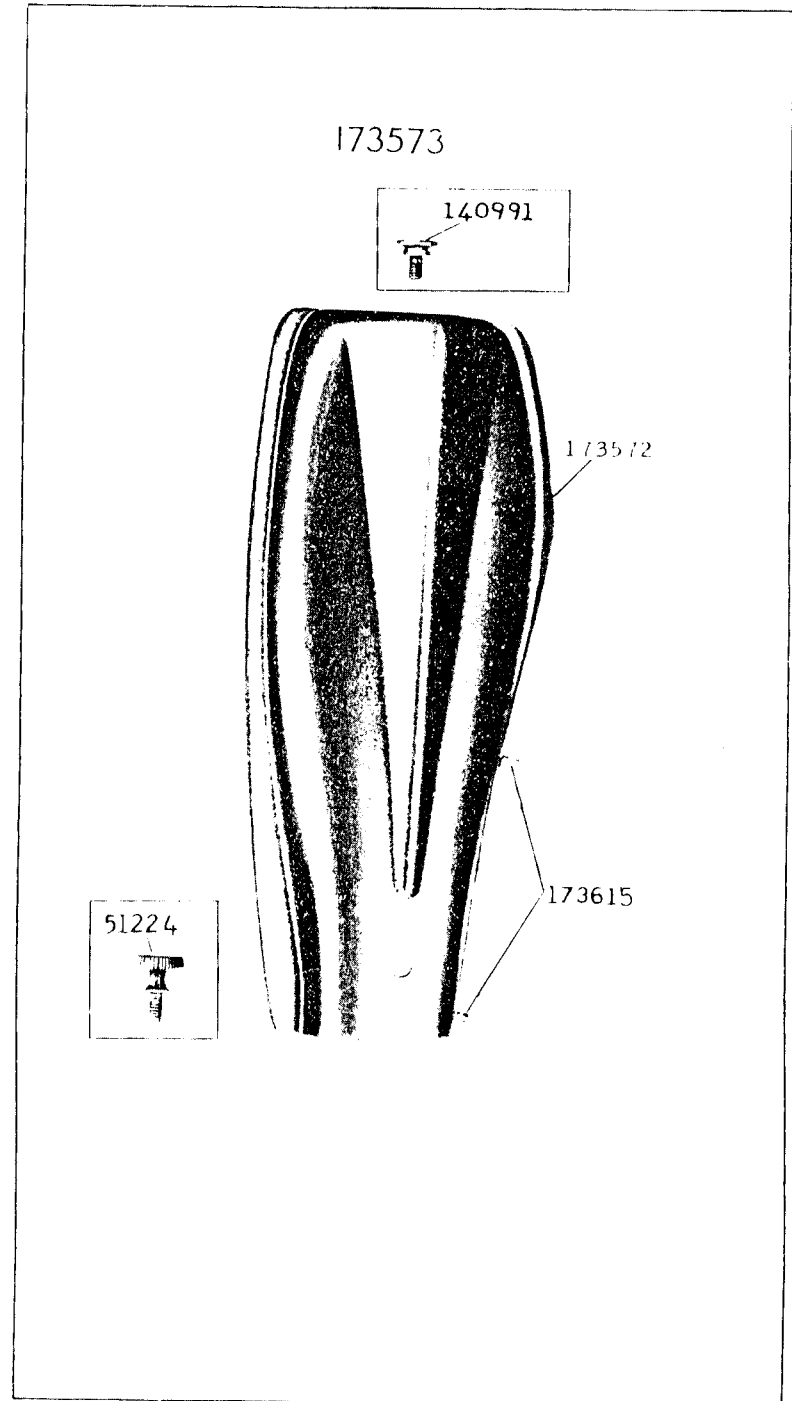
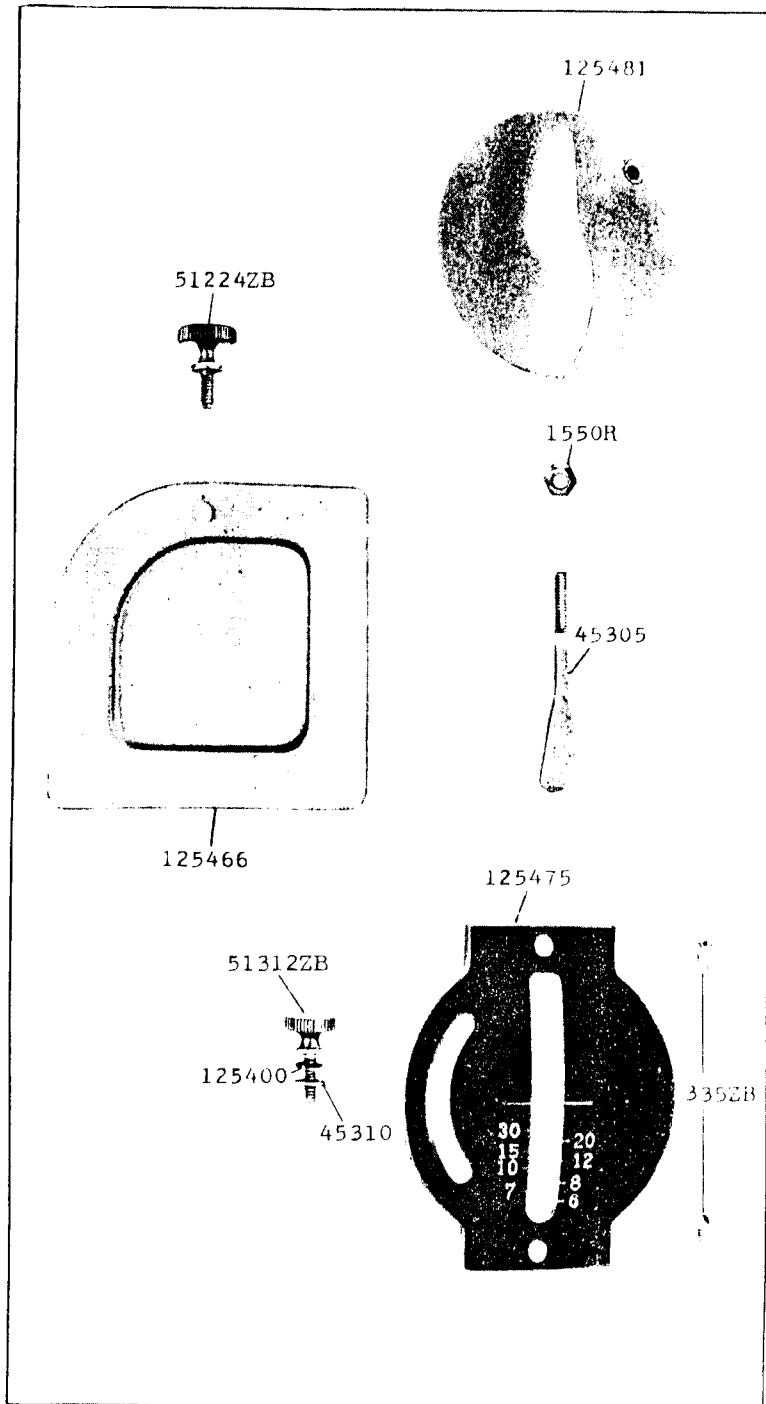

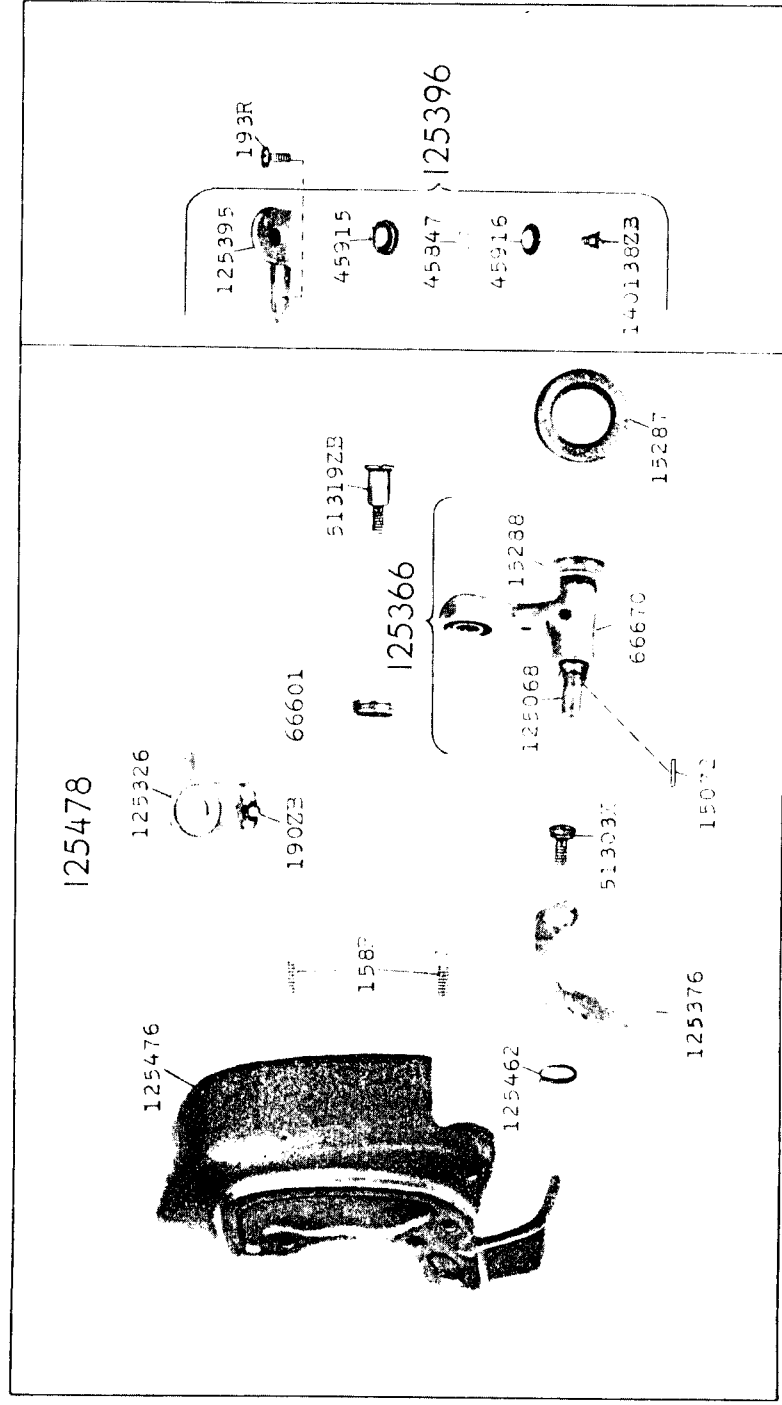
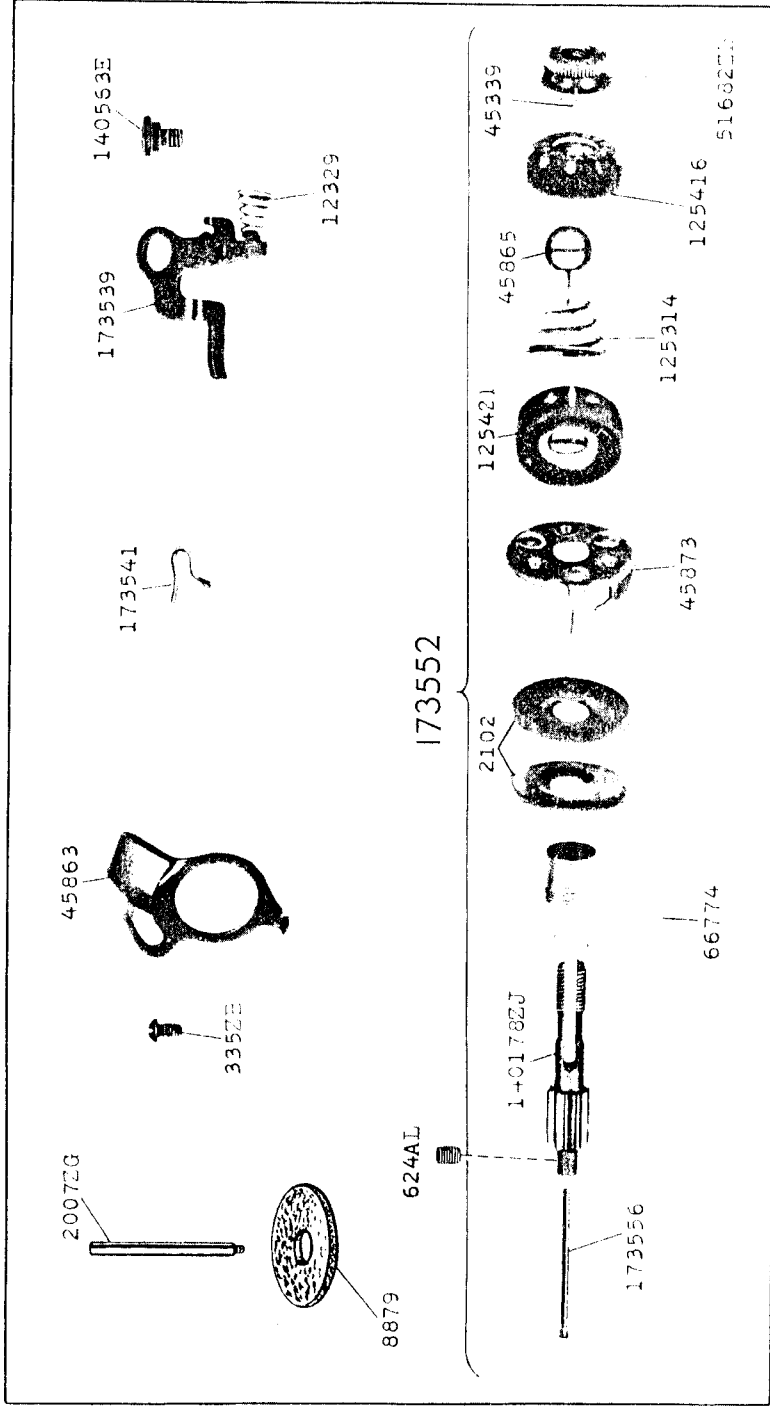

LIST OF PARTS

FOR

191K1 to 191K3 Machines

CONTENTS

	Page
Parts complete for 191K1 to 191K3 Machines	27
Attachments	35
Bobbin Winder	34
Embroidery Hoops	37
Hand Attachment	39
Numerical List of Parts	41

INSTRUCTIONS FOR ORDERING

In ordering from this List the prefix and affix letters with the part number MUST BE quoted exactly as they are shown in the first column.

A number always indicates the same part in whatever List it may appear, or for whatever machine.

The affix letters and code numbers (where shown) indicate the style of finish, as follows:—

New Code	Old Code	
801	A.	Hardened, Polished, Nickel Plated and Buffed.
802	B.	Polished, Nickel Plated and Buffed.
803	C.	Hardened only.
804	D.	Polished only.
805	E.	Soft, Not Polished.
806	F.	Hardened and Polished.
807	G.	Bright Rumbled and Nickel Plated.
808	H.	Blued.
809	J.	Nickel Plated only.
810	K.	Hardened and Nickel Plated.
811	L.	Brass Plated.
812	M.	Oxidized.
813	R.	Phosphate Coating Formed on Surface of Iron or Steel.
814	S.	Cadmium Plated.
815	T.	Copper Plated.
816	U.	Zinc Plated.
817	V.	Silver Plated.
818	W.	Polished and Nickel Plated.
819	X.	Black Oxide for Iron and Steel.
820	Y.	Black Nickel Plated only.
821	Z.	Chromium Plated.
822	A.A.	Buffed and Chromium Plated.
823	A.B.	Hardened, Polished, Buffed and Chromium Plated.
824	A.E.	Hardened, Bright Rumbled and Nickel Plated.
825	A.F.	Hardened, Bright Rumbled, Nickel Plated, Bright Rumbled and Chromium Plated.
826	A.G.	Alumilite (Plain).
827	A.H.	Alumilite (Dyed). Colour must be stated.†
828	A.J.	Polished, Nickel Plated and Chromium Plated.
829	A.K.	Hardened, Polished, Nickel Plated and Chromium Plated.
830	A.L.	Heat Treated for Toughness.
831	A.L.D.	Heat Treated for Toughness and Polished.
832	A.L.J.	Heat Treated for Toughness and Nickel Plated.
833	A.L.X.	Heat Treated for Toughness and Black Oxide.
834	A.L.Z.B.	Heat Treated for Toughness, Polished, Nickel Plated, Buffed and Chromium Plated.
835	A.S.	Black Moulded Phenolic.
836	A.T.	Beige Moulded Phenolic.
837	A.U.	Brown Moulded Phenolic.
838		
839	B.A.	Chrome Nickel, Satin Finish.
840	B.B.	Hardened and Chrome Nickel, Satin Finish.
841	C.F.	Hardened and Phosphate Coating Formed on Surface of Steel.
842	C.U.	Hardened and Zinc Plated.
843	F.J.	Hardened, Polished and Nickel Plated.
844	T.A.	Hardened, Polished, Copper and Nickel Plated and Buffed.
845	T.B.	Copper and Nickel Plated and Polished.
846	T.J.	Copper and Nickel Plated only.
847	T.K.	Hardened, Copper and Nickel Plated.
848	T.L.	Copper and Brass Plated.
849	T.M.	Copper Plated and Oxidized.
850	X.C.	Hardened and Black Oxide for Iron and Steel.
851	Z.A.	Hardened, Polished, Nickel Plated, Buffed and Chromium Plated.
852	Z.B.	Polished, Nickel Plated, Buffed and Chromium Plated.
853	Z.C.	Hardened and Chromium Plated.
854	Z.D.	Polished and Chromium Plated.
855	Z.G.	Bright Rumbled, Nickel Plated, Bright Rumbled and Chromium Plated.
856	Z.J.	Nickel and Chromium Plated.
857	Z.T.	Copper and Chromium Plated.
858	A.L.Z.J.	Heat Treated for Toughness, Nickel and Chromium Plated.

Parts marked with an asterisk (*) are furnished only when repairs are made at Factory.

PARTS COMPLETE

FOR

Nos. 191K1 to 191K3 MACHINES

Lock Stitch, C.B. Oscillating Shuttle, Reversible Feed, Link Take-up, Feed Throw-out Device for Darning and Embroidery for Family Use.

No.	Plate	
*173601		Arm
NOTE. Arm cannot be supplied separately and can only be sent as a unit, Arm and Bed assembled.		
†173501		Arm and Bed, with Nos. 81110, 125331, 125334 and four 1105431.
2002	2816	" Dowel Pin (2)
125331	2816	" Oil Pad (left) for oiling Arm Shaft Back Bearing
81110	2816	" " " Spring
125334	2816	" " " Cap
138e	2816	" Screw (3)
173603	2816	" Shaft
173559	-	" " 173603 with 171509, 171512, 173503 and 173600 ...
173503	2816	" " Bushing
435al	2816	" " " Set Screw
171509	-	" " Counterbalance with 1285al
1285al	2816	" " " Position Screw
†125466	26001	" Side Cover
51224zb	26001	" " " Thumb Screw
2007zg	26007	" Spool Pin
*173602		Bed
NOTE. Bed cannot be supplied separately and can only be sent as a unit, Arm and Bed assembled.		
256zb	2816	Clamp Stop Motion Clamp Screw
248za	2816	" " " " Stop Screw
171502	2816	" " " " Washer
*15312	-	" " " Flanged Bushing
15313	2816	" " " " 15312 with two 462al ...
2022	-	" " " " Pin
462al	2816	" " " " Set Screw
15314	-	Clamp Stop Motion, complete, Nos. 248za, 256zb, 15313 and 171502 (for Agents only)

† In ordering it is necessary to state Colour of Machine.

No.	Plate					
125021	2816	Crank Connecting Rod with 125044 and two 896al
896al	2816	" " " " Cap Screw
375c	2816	" " " " Hinge Screw
1518r	2816	" " " " " Nut
125044	2816	" " " " Oil Pad (felt)
173504zb	---	Face Plate for 173505zb
†173572	26002	" " " 173573
173505zb	---	Face Plate , complete, Nos. 173504zb, two each 32755 and 173616 for Black Machines
173573	26002	Face Plate , complete, Nos. 173572, two each 32755 and 173616 (for Two-Tone finish machines)
140991zb	26002	Face Plate Screw
32755	-	" " Thread Guard
173615	26002	" " " " 32755 with 173616 (<i>for Agents only</i>)
173616	-	" " " " Rivet
51224zb	26002	" " Thumb Screw
173508	2818	Feed Bar
1904	2818	" " Roller
1813	-	" " " and Stud, Nos. 1904 and 125060
*125060	-	" " " Stud
315c	2818	" " Screw Centre
15445	-	" " " " 315c with 1519r (2)
1519r	2818	" " " " Nut
171512	2816	Feed Cam with 1285al
1285al	2816	" " Position Screw
15279	2817	Feed Dog , 12 teeth (14 teeth to the inch)
208al	2817	" " Screw (2)
125262	2816	Feed Forked Connection with 175r
125340	-	" " " 125262 with 125335
175r	2816	" " " Adjusting Screw
1381c	2816	" " " Hinge Screw (eccentric)
1520r	2816	" " " " Nut
125017	2816	" " " Slide Block
125335	-	" " " " " 125017 with 1085e
1085e	2816	" " " " " Screw Stud
173510u	2818	Feed Lifting Rock Shaft
173511	---	" " " " with Feed Throw-out Assembly, complete, Nos. 173510u, 173513 and 173520x
173512	2818	Feed Lifting Rock Shaft Crank with 704x and 50150al
704x	2818	" " " " " Clamping Screw

† In ordering it is necessary to state Colour of Machine.

No.	Plate					
173513	---	Feed Lifting Rock Shaft Crank with Feed Throw-out Lever, complete, Nos. 173512 and 173515 to 173517u
125018	2818	Feed Lifting Rock Shaft Centre (left)
125049	2818	" " " " " (right)
51246al	2818	" " " " " Set Screw (2)
125397	2816	Feed Regulator
125398	-	" " 125397 with 125381
50353e	2816	" " Hinge Screw
125399	2816	" " " " Friction Washer
45305	26001	Feed Reversing Handle
125381	-	" " " 45305 with 1550r
1550r	26001	" " " Lock Nut
125270u	2818	Feed Rock Shaft
125048	2818	" " " Centre (left)
125049	2818	" " " " (right)
51246al	2818	" " " " Set Screw (2)
†173514	2818	Feed Throw-out Knob with 442al
442al	2818	" " " Set Screw
173547	2818	" " " Shaft and Bobbin Winder Spool Pin
173515	2818	" " " Lever with 1813
173516	2818	" " " Tension Spring
173517u	2818	" " " " " Hinge Stud
50150al	2818	" " " " " " " Set Screw
173518u	2818	" " " Pitman Rod
21202j	2818	" " " " Washer (2)
140138j	2818	" " " " " Screw (2)
173519x	2818	" " " Plunger
173520x	2818	" " " Bracket
†125473	2816	Hand Wheel , 2½" pulley, for 191K1 Machine
†173518	2816	" " (spoked), 2½" pulley, for 191K2 Machine
†32672	2816	" " (disc), 3½" pulley, for 191K3 Machine
120842	2821	Hemmer (foot) ¼" hem (packed with accessories)
51045al	2816	Machine Hinge Connection Set Screw (2)
15271	-	Needle , size 14
173608	2819	Needle Bar
*125272	2819	" " Bushing
125273	-	" " " 125272 with 125274
125274	2819	" " " Oil Pad (felt)
1498al	2819	" " " Set Screw

† In ordering it is necessary to state Colour of Machine.

No.	Plate				
45231	2819	Needle Bar	Connecting Link with 51002e
173524	---	"	"	"	" 45231 with 173551
51002e	2819	"	"	"	" Adjusting Screw
1130e	2819	"	"	"	" Cap Screw
173554	2819	"	"	"	" Stud with 51363e
51363e	2819	"	"	"	" Set Screw
173600	2816	"	"	"	" Crank with 1036al and 1293al
1293al	2816	"	"	"	" Position Screw
173555	2819	"	"	"	" Hole Plug
173609	2819	Needle Clamp
173610	2819	"	"	"	" 173609 with 140545e
173611	2819	"	"	"	" Gib
140876k	2819	"	"	"	" Locating Screw
140545e	2819	"	"	"	" Thumb Screw
140543L	---	Number Plate Drive Screw
125055u	2818	Oscillating Rock Shaft	with 125056
125048	2818	"	"	"	" Centre (left)
51246al	2818	"	"	"	" (") Set Screw
125049	2818	"	"	"	" (right)
51246al	2818	"	"	"	" (") Set Screw
125056	2818	"	"	"	" Oil Wick (braided cotton)
2510	2818	Oscillating Shaft
*125063	---	"	"	"	" 2510 with 2049 and 125062
*125086	---	"	"	"	" 125063 with 125058u, 125065 and two 51229e
*125057u	---	"	"	"	" Crank
*125058u	---	"	"	"	" 125057u with 462al and 125330
125059	2818	"	"	"	" 125057u with 125330 and two 462al <i>(for Agents only)</i>
2049	---	"	"	"	" Pin
462al	2818	"	"	"	" Set Screw
*15170	---	"	"	"	" Slide Block
125330	2818	"	"	"	" 15170 with 125060
*125060	---	"	"	"	" Stud
125061	2819	Presser Bar
173527	2819	"	"	"	" Guide Bracket with 454al
454al	2819	"	"	"	" Set Screw
170066	2819	"	"	"	" Lifter
85e	2819	"	"	"	" Hinge Stud
80011	2819	"	"	"	" Spring
2070	2819	"	"	"	" Washer
45329	---	Presser Foot	Hinge Pin
*45319	---	"	"	"	" Plate
*32774	---	"	"	"	" Shank
45321	2817	"	"	"	" (hinged) complete, Nos. 32774, 45319 and 45329
51224zb	2817	"	"	"	" Thumb Screw

No.	Plate				
*140768zb	2819	Pressure Regulating Thumb Screw
173557	---	"	"	"	" 140768zb with 66752
66752	2819	"	"	"	" Plug (felt)
2518	2820	Shuttle Bobbin (5), 1 in machine, 4 packed with accessories
15140	2820	"	"	"	" Case Latch
2973	2820	"	"	"	" Lever
2974	2820	"	"	"	" Fulcrum Pin
2975	2820	"	"	"	" Spring
592e	2820	"	"	"	" Stop Screw
15141	2820	"	"	"	" Hinge, Nos. 2973, 2974 and 15140
15277	2820	"	"	"	" Nos. 592e, 2975 and 15141
2515	2820	"	"	"	" Body
5911	2820	"	"	"	" Tension Regulating Screw
15278	2820	"	"	"	" Spring
125018	2820	Shuttle, 1 1/16" diam., complete, Nos. 2515, 2518 and 15277
*125062	---	Shuttle Driver
125092	2818	"	"	"	" 125062 with two 462al
125064	---	"	"	"	" 125092 with 125065 and two 51229e <i>(for Agent only)</i>
125065	2818	"	"	"	" Cushion Spring
51229e	2818	"	"	"	" Screw
2049	---	"	"	"	" Pin
462al	2818	"	"	"	" Set Screw
171539	2820	Shuttle Race Body
171540	---	"	"	"	" 171539 with 171545 and two 662j <i>(for Agents only)</i>
171545	2820	"	"	"	" Cap
662j	2820	"	"	"	" Screw
171541	2820	Shuttle Race, complete, Nos. 171545, 171539, 171543 to 171546, 173551, two each 87k, 662j, 173536 and 173538
171542	---	Shuttle Race, complete, Nos. 2515, 171545, 171539, 171543 to 171546, 173551, two each 87k, 662j, 173536 and 173538
171543	2820	Shuttle Race Gate
173551	2820	"	"	"	" Hinge Pin
171544	2820	"	"	"	" Stud
171545	2820	"	"	"	" Nut
171546	2820	"	"	"	" Spring
173536	2820	"	"	"	" Latch
87k	2820	"	"	"	" Screw
173538	2820	"	"	"	" Spring
145j	2820	"	"	"	" Screw (2)

No.	Plate						
125336	2817	Shuttle Race Slide
125337	2817	" " " Spring
51282zj	2817	" " " " Screw
125338	2817	Shuttle Race Slide, complete, Nos. 125336, 125337 and two 51282zj
45863	26007	Slack Thread Regulator and Tension Thread Guide
335zb	26007	" " " Screw
†125475	26001	Stitch Indicator Plate
335zb	26001	" " " Screw (2)
125481	26001	" Regulating Plate
125479	---	" " " 125481 with 45310, 51312zb, 125400 and 125475
51312zb	26001	" " " Thumb Screw
125400	26001	" " " " Friction Washer
45310	26001	" " " " Washer (fibre)
2102	26007	Tension Disc
†125421	26007	" Indicator
†125416	26007	" " Flange
45865	26007	" " " Stop Washer
51682zb	26007	" Regulating Thumb Nut with 45339
45339	26007	" " " " Engaging Pin
173539	26007	" Releasing Lever...
140563e	26007	" " " Hinge Screw
12329	26007	" " " Spring
173556	26007	" " " Pin
125314	26007	" Spring
140178zj	26007	" Stud
45352	-	" " 140178zj with 51682zb
624al	26007	" " Set Screw
173552	26007	Tension (graduated), complete, Nos. 45352, 45865, 45873, 66774, 125314, 125416, 125421, 173556 and two 2102
26075	2819	Thread Gutter and Holder
173541	26007	" Guard (head of arm, upper)
173542	2819	Thread Take-up Crank
173566	-	" " " 173542 with 1130e and 173524
1036al	2816	" " " Set Screw

† In ordering it is necessary to state Column of Machine.

No.	Plate						
45261	2819	Thread Take-up Lever
173563		" " " 45261 with 173545 and 173553
173564		" " " complete, Nos. 1130e, 173558 and 173563
173565		" " " 173564 with 173566
173553	2819	" " " Hinge Stud
173545	2819	" " " Link
173558	2819	" " " " Hinge Stud
1130e	2819	" " " " " " Cap Screw
440al	2819	" " " " " " Set Screw
66774	26007	Thread Take-up Spring
45873	26007	" " " Thread Guard
125413	2817	Throat Plate for 15279
691za	2817	" " " Screw (2)
140543L	-	Trademark Drive Screw

Bobbin Winder

For HAND WHEELS Nos. 32672, 125473 and 173548

No.	Plate						
†125476	26009	Bracket (belt cover)
158j	26009	" Screw (2)
†66670	26009	Frame
125366	26009	" 66670 with 15288 and 125068
51319r	26009	" Hinge Screw
66601	26009	" Spring
†15287	26009	Friction Ring (rubber)
15288	26009	Pulley
125068	26009	Spindle
125376	26009	Stop Latch
51303x	26009	" " Hinge Screw
125462	26009	" " Spring
125395	26009	Tension Bracket
125396	26009	" " complete, Nos. 45847, 45915, 45916, 125395 and 140138zb
193zb	26009	" " Screw
45915	26009	" Disc
45916	26009	" " Screw Washer
45847	26009	" " Spring
140138zb	26009	" Screw
125326	26009	Tripping Arm
190r	26009	" " Screw
†125478	26009	Bobbin Winder (automatic), complete, Nos. 190r, 15287, 51303x, 51319r, 66601, 125326, 125366, 125376, 125462 and 125476

† In ordering it is necessary to state Colour of Machine.

Attachments

ATTACHMENT SET No. 161324

(Packed in Cardboard Box)

(For All Countries except Denmark, Norway, Sweden and Switzerland)

No.	Plate						
121464	2574	Binder
25527b	2719	Cloth Guide
50053b	2719	" " Thumb Screw
121441	2574	Gathering Foot (double toe)
161307	-	Needle Threader (wire)
15x1	-	Needles, three each sizes 11 and 14
161127	2719	Presser Foot (hinged, adjustable) for sewing on the right or left side of the needle, for Edge Stitching, Cording and Slide Fastener Work
86742	2574	Ruffler
161294	2574	Screw Driver (machine)
161295	2574	" " (bobbin case) (120378 will be supplied until stock is exhausted)
8879	2574	Spool Pin Washer (cloth)
120861	-	Tin of Oil (3 oz.)
161324	-	Attachment Set, complete, Nos. 25527b, 50053b, 86742, 120861, 121441, 121464, 161127, 161294, 161295, 161307, two 8879 and six needles 15x1 (three each sizes 11 and 14)

ATTACHMENT SET No. 161325

(Packed in Cardboard Box)

(For Denmark, Norway, Sweden and Switzerland)

This is the same as Set No. 161324 with the following addition :

121094	2719	Darning Foot
161325	-	Attachment Set, complete, Nos. 25527b, 50053b, 86742, 120861, 121094, 121441, 121464, 161127, 161294, 161295, 161307, two 8879 and six needles 15x1 (three each sizes 11 and 14)

Fashion Aids

Available for separate purchase

25525	2719	Bias Gauge
86649		Blind Stitch Attachment
86718		Buttonhole Attachment
121094	2719	Darning Foot (spring)
36865	2574	Edge Stitcher
85893	2821	Embroidery Foot (for art work)
36835	2821	Feller (foot)
86192		Gathering Foot (slotted)
35931	2574	Hemmer (adjustable)
120687	2821	Imitation Hemstitching Attachment with Yielding Presser Plate
160845	2719	Presser Foot (left toe) for Edge Stitching, Cording and Slide Fastener Work
160846	2719	Presser Foot (right toe) for Edge Stitching, Cording and Slide Fastener Work
35932	2719	Quilter
121170	909	Ruffler Shirring Plate
25539	2719	Stiletto
36583	2821	Tucker
121547	909	Under Braider

Embroidery Hoops

(Plain)

(Birch)

No.	Plate	
101336		Hoop (inner)
101337		" (outer)
87586		" (round) 5½" diam. × 7 ^m high, Nos. 101336 and 101337
101346		" (inner)
101347		" (outer)
96416		" (round) 7" diam. × 7 ^m high, Nos. 101346 and 101347
101338		" (inner)
101339		" (outer)
87589	2659	" (round) 8" diam. × 7 ^m high, Nos. 101338 and 101339
101340		" (inner)
101341		" (outer)
87593		" (round) 10" diam. × 7 ^m high, Nos. 101340 and 101341
101342		" (inner)
101343		" (outer)
87595		" (round) 12" diam. × 7 ^m high, Nos. 101342 and 101343
101358		" (inner)
101359		" (outer)
96422	2659	" (oval) 9" × 4½" × 7 ^m high, Nos. 101358 and 101359
101344		" (inner)
101345		" (outer)
87597		" (oval) 12" × 5½" × 7 ^m high, Nos. 101344 and 101345

Embroidery Hoops

(With Spring)

(Birch)

No.	Plate	
101361		Hoop (inner) for 101246
101365		" (outer) with Spring, for 101246
101246		" (round) 10" diam. × 7 ^m high, Nos. 101364 and 101365

Embroidery Hoops

(With Clamp)

(Birch)

No.	Plate	
101348	--	Hoop (inner)
101349	--	" (outer) with SS528j, NN95j, two 96425 and four 96427 ...
96417	--	" (round) 5 $\frac{1}{8}$ " diam. \times 7 $\frac{m}{m}$ high, Nos. 101348 and 101349 ...
101350	--	" (inner)
101351	--	" (outer) with SS528j, NN95j, two 96426 and four 96427 ...
96418	2659	" (round) 7" diam. \times 7 $\frac{m}{m}$ high, Nos. 101350 and 101351 ...
101352	--	" (inner)
101353	--	" (outer) with SS528j, NN95j, two 96426 and four 96427 ...
96419	--	" (round) 8" diam. \times 7 $\frac{m}{m}$ high, Nos. 101352 and 101353 ...
101354	--	" (inner)
101355	--	" (outer) with SS528j, NN95j, two 96426 and four 96427 ...
96420	--	" (round) 10" diam. \times 7 $\frac{m}{m}$ high, Nos. 101354 and 101355 ...
101356	--	" (inner)
101357	--	" (outer) with SS528j, NN95j, two 96844 and four 96845 ...
96421	--	" (round) 12" diam. \times 4 $\frac{1}{2}$ " high, Nos. 101356 and 101357 ...
101360	--	" (inner)
101361	--	" (outer) with SS528j, NN95j, 96425, 96426 and four 96427 ...
96423	--	" (oval) 9" \times 4 $\frac{1}{2}$ " \times 7 $\frac{m}{m}$ high, Nos. 101360 and 101361 ...
101362	--	" (inner)
101363	--	" (outer) with SS528j, NN95j, 96425, 96426 and four 96427 ...
96424	--	" (oval) 12" \times 5 $\frac{1}{2}$ " \times 7 $\frac{m}{m}$ high, Nos. 101362 and 101363 ...
96425	2399	Clamping Bracket for 101349, 101361 and 101363 ...
96426	2399	" " " 101351, 101353, 101355, 101361 and 101363 ...
96844	2399	" " " 101357
96427	2399	" " Rivet for 101349, 101351, 101353, 101355, 101361 and 101363 ...
96845	2399	" " Rivet for 101357
SS528j	2399	" " Screw
NN95j	2399	" " " Nut

Hand Attachment

No.	Plate	
†94050	2284	Body
†94027	2284	" Bracket
183e	2114	" " Screw
†94028	2114	Crank Handle
94029b	2114	" " Spindle
94069	2114	" Hinge Pin
94031za	2284	" Lever
94032	2114	" " Lock Pin
94033zb	2114	" " " " Head
55531	2114	" " " " Spring
94034b	--	Crank, complete, Nos. 94028, 94029b and 94031za ...
†94046	2114	Driver
94070	--	" 94046 with 80028 and 94048
94036	2114	" Finger
94041	--	" " 94036 with SS567e, 94039 and 94040 ...
94039	2114	" " Driving Pad (raw-bide)
94040	2114	" " " " Plate
SS567e	2114	" " " " and Plate Binding Screw ...
94044	2114	" " Hinge Pin
94037	2114	" " Latch
SS565e	2114	" " " Screw Stud
94038	2114	" " " Spring
†94051	2284	Gear with 55531, 94032 and 94033zb
†94016	2284	" Cover
399za	2114	" " Screw
SS599f	2114	" " Screw Stud
94048	2114	Pinion
80028	2114	" Dowel Pin
SS600f	2114	" " Screw Stud
†94052	2284	Hand Attachment , complete, Nos. SS565e, SS566e, SS599f, SS600f, 94016, 94027, 94034b, 94037, 94038, 94041, 94044, 94050, 94051, 94069, 94070, two each 183e and 399za ...
SS566e	2114	Hand Attachment Screw

† In ordering it is necessary to state Colour of Machine.

Numerical List of Parts

No.	Plate	
85c	2819	Presser Bar Lifter Hinge Stud
87k	2820	Shuttle Race Gate Latch Screw for 171541 and 171542
NN95j	2399	Embroidery Hoop Clamping Bracket Screw Nut for 101349, 101351, 101353, 101355, 101357, 101361 and 101363
138e	2816	Arm Screw
145j	2820	Shuttle Race Screw
158j	26009	Bobbin Winder Bracket Screw
175r	2816	Feed Forked Connection Adjusting Screw for 125262
183e	2114	Hand Attachment Body Bracket Screw for 94052
190r	26009	Bobbin Winder Tripping Arm Screw for 125478
193zb	26009	Bobbin Winder Tension Bracket Screw
208al	2817	Feed Dog Screw
248za	2816	Clamp Stop Motion Clamp Stop Screw for 15314
256zb	2816	Clamp Stop Motion Clamp Screw for 15314
315c	2818	Feed Bar Screw Centre for 15445
335zb	26007	Slack Thread Regulator Screw
335zb	26001	Stitch Indicator Plate Screw
375c	2816	Crank Connecting Rod Hinge Screw
399za	2114	Hand Attachment Gear Cover Screw for 94052
435al	2816	Arm Shaft Bushing Set Screw
440al	2819	Thread Take-up Lever Link Hinge Stud Set Screw
442al	2818	Feed Throw-out Knob Set Screw for 173514
454al	2819	Presser Bar Guide Bracket Set Screw for 173527
462al	2816	Clamp Stop Motion Flanged Bushing Set Screw for 15313
462al	2818	Oscillating Shaft Crank Set Screw for 125058u and 125059
462al	2818	Shuttle Driver Set Screw for 125692
SS528j	2399	Embroidery Hoop Clamping Bracket Screw for 101349, 101351, 101353, 101355, 101357, 101361 and 101363
SS565c	2114	Hand Attachment Driver Finger Latch Screw Stud for 94052

No.	Plate	
SS566c	2114	Hand Attachment Screw for 94052 ...
SS567c	2114	Hand Attachment Driver Finger Driving Pad and Plate Binding Screw for 94041 ...
591f	2820	Shuttle Tension Regulating Screw ...
592e	2820	Shuttle Bobbin Case Latch Stop Screw for 15277 ...
SS599f	2114	Hand Attachment Gear Screw Stud for 94052 ...
SS600f	2114	Hand Attachment Pinion Screw Stud for 94052 ...
624al	26007	Tension Stud Set Screw ...
662j	2820	Shuttle Race Cap Screw for 171540 to 171542 ...
691za	2817	Throat Plate Screw ...
704x	2818	Feed Lifting Rock Shaft Crank Clamping Screw for 173512 ...
896al	2816	Crank Connecting Rod Cap Screw for 125021 ...
1036al	2816	Thread Take-up Crank Set Screw for 173600 ...
1085c	2816	Feed Forked Connection Slide Block Screw Stud for 125335 ...
1136e	2819	Needle Bar Connecting Link Cap Screw for 173564 ...
1130e	2819	Thread Take-up Lever Link Hinge Stud Cap Screw for 173566 ...
1285al	2816	Arm Shaft Counterbalance Position Screw for 171509 ...
1285al	2816	Feed Cam Position Screw for 171512 ...
1293al	2816	Needle Bar Crank Position Screw for 173600 ...
1381c	2816	Feed Forked Connection Hinge Screw (eccentric) ...
1498al	2819	Needle Bar Bushing Set Screw ...
1518r	2816	Crank Connecting Rod Hinge Screw Nut ...
1519r	2818	Feed Bar Screw Centre Nut for 15445 ...
1520r	2816	Feed Forked Connection Hinge Screw Nut ...
1550r	26001	Feed Reversing Handle Lock Nut for 125381 ...
1813	- -	Feed Bar Roller and Stud, Nos. 1904 and 125060 for 173515 ...
1904	2818	Feed Bar Roller for 1813 ...
2002	2816	Arm Dowel Pin ...
2007zg	26007	Arm Spool Pin ...
2022	- -	Clamp Stop Motion Flanged Bushing Pin ...
2049	- -	Oscillating Shaft Crank Pin for 125063 ...
2049	- -	Shuttle Driver Pin ...
2070	2819	Presser Bar Spring Washer ...
2102	26007	Tension Disc for 173552 ...
2510	2818	Oscillating Shaft for 125063 ...
2515	2820	Shuttle Body for 125018 and 171542 ...
2518	2820	Shuttle Bobbin for 125018 (5) (1 in machine, 4 packed with accessories) ...

No.	Plate	
2973	2820	Shuttle Bobbin Case Latch Lever for 15141 ...
2974	2820	Shuttle Bobbin Case Latch Lever Fulcrum Pin for 15141 ...
2975	2820	Shuttle Bobbin Case Latch Spring for 15277 ...
8879	2574	Spool Pin Washer (cloth) for 161324 and 161325 ...
12329	26007	Tension Releasing Lever Spring ...
15140	2820	Shuttle Bobbin Case Latch for 15141 ...
15141	2820	Shuttle Bobbin Case Hinge, Nos. 2973, 2974 and 15140 for 15277 ...
*15170	- -	Oscillating Shaft Crank Slide Block for 125330 ...
15277	2820	Shuttle Bobbin Case, Nos. 592e, 2975 and 15141 for 125018 ...
15278	2820	Shuttle Tension Spring ...
15279	2817	Feed Dog, 12 teeth (14 teeth to the inch) ...
†15287	26009	Bobbin Winder Friction Ring (rubber) for 125478 ...
15288	26009	Bobbin Winder Pulley for 125366 ...
*15312	- -	Clamp Stop Motion Flanged Bushing for 15313 ...
15313	2816	Clamp Stop Motion Flanged Bushing 15312, with two 462al, for 15314 ...
15314	- -	Clamp Stop Motion, complete, Nos. 248za, 256zb, 15313 and 171502 (for Agents only) ...
15415	- -	Feed Bar Screw Centre 315c with 15419r ...
21202j	2818	Feed Throw out Pitman Rod Washer ...
25525	2719	Bias Gauge ...
25527b	2719	Cloth Guide for 161324 and 161325 ...
25539	2719	Stiletto ...
26075	2819	Thread Cutter and Holder ...
†32672	2816	Hand Wheel (disc), 3¼" pulley, for 191K3 Machine ...
32755	- -	Face Plate Thread Guard for 173505zb, 173573 and 173615 ...
*32774	- -	Presser Foot Shank for 45321 ...
35931	2574	Hemmer (adjustable) ...
35932	2719	Quilter ...
36583	2821	Tucker ...
36835	2821	Feller (foot) ...
36865	2574	Edge Stitcher ...

† In ordering it is necessary to state Colour of Machine.

No.	Plate	
45231	2819	Needle Bar Connecting Link with 51002e, for 173524
45261	2819	Thread Take-up Lever for 173563
45305	26001	Feed Reversing Handle for 125381
45310	26601	Stitch Regulating Thumb Screw Washer (fibre) for 125479
*45319	---	Presser Foot Plate for 45321
45321	2817	Presser Foot (binged) complete, Nos. 32774, 45319 and 45329
45329	---	Presser Foot Hinge Pin for 45321
45339	26007	Tension Regulating Thumb Nut Engaging Pin for 51682zb
45352	---	Tension Stud 140178zj with 51682zb for 173552
45847	26009	Bobbin Winder Tension Disc Spring for 125396
45863	26007	Slack Thread Regulator and Tension Thread Guide
45865	26007	Tension Indicator Flange Stop Washer for 173552
45873	26007	Thread Take-up Spring Thread Guard for 173552
45915	26009	Bobbin Winder Tension Disc for 125396
45916	26009	Bobbin Winder Tension Disc Screw Washer for 125396
50053b	2719	Cloth Guide and Under Braider Thumb Screw for 161324 and 161325
50150al	2818	Feed Throw-out Lever Tension Spring Hinge Stud Set Screw for 173512
50353e	2816	Feed Regulator Hinge Screw
51002e	2819	Needle Bar Connecting Link Adjusting Screw for 45231
51045al	2816	Machine Hinge Connection Set Screw
51224zb	26001	Arm Side Cover Thumb Screw
51224zb	26002	Face Plate Thumb Screw
51224zb	2817	Presser Foot Thumb Screw
51229e	2818	Shuttle Driver Cushion Spring Screw for 125064 and 125086
51246al	2818	Feed Lifting Rock Shaft Centre Set Screw
51246al	2818	Feed Rock Shaft Centre Set Screw
51246al	2818	Oscillating Rock Shaft Centre (left) Set Screw
51246al	2818	Oscillating Rock Shaft Centre (right) Set Screw
51282zj	2817	Shuttle Race Slide Spring Screw for 125338
51303x	26009	Bobbin Winder Stop Latch Hinge Screw for 125478

No.	Plate	
51312zb	26001	Stitch Regulating Thumb Screw for 125479
51319r	26009	Bobbin Winder Frame Hinge Screw for 125478
51363e	2819	Needle Bar Connecting Stud Set Screw for 173554
51682zb	26007	Tension Regulating Thumb Nut with 45339 for 45352
55531	2114	Hand Attachment Crank Lever Lock Pin Spring for 94051
66601	26009	Bobbin Winder Frame Spring for 125478
†66670	26009	Bobbin Winder Frame for 125366
66752	2819	Pressure Regulating Thumb Screw Plug (felt) for 173557
66774	26007	Thread Take-up Spring for 173552
80041	2819	Presser Bar Spring
80028	2114	Hand Attachment Pinion Dowel Pin for 94070
81110	2816	Arm Oil Pad Spring for 173501
85893	2821	Embroidery Foot (for art work)
86192	---	Gathering Foot (slotted)
86649	---	Blind Stitch Attachment
86718	---	Buttonhole Attachment
86742	2574	Ruttler for 161324 and 161325
87586	---	Embroidery Hoop (round, birch) 5 $\frac{5}{8}$ " diam. \times 7 $\frac{m}{m}$ high, Nos. 101336 and 101337
87589	2659	Embroidery Hoop (round, birch) 8" diam. \times 7 $\frac{m}{m}$ high, Nos. 101338 and 101339
87593	---	Embroidery Hoop (round, birch) 10" diam. \times 7 $\frac{m}{m}$ high, Nos. 101340 and 101341
87595	---	Embroidery Hoop (round, birch) 12" diam. \times 7 $\frac{m}{m}$ high, Nos. 101342 and 101343
87597	---	Embroidery Hoop (oval, birch) 12" \times 5 $\frac{1}{2}$ " \times 7 $\frac{m}{m}$ high, Nos. 101344 and 101345
†94016	2284	Hand Attachment Gear Cover for 94052
†94027	2284	Hand Attachment Body Bracket for 94052
†94028	2114	Hand Attachment Crank Handle for 94034b
94029b	2114	Hand Attachment Crank Handle Spindle for 94034b
94031za	2284	Hand Attachment Crank Lever for 94034b
94032	2114	Hand Attachment Crank Lever Lock Pin for 94051
94033zb	2114	Hand Attachment Crank Lever Lock Pin Head for 94051
94034b	---	Hand Attachment Crank, complete, Nos. 94028, 94029b and 94031za for 94052

† In ordering it is necessary to state Colour of Machine.

No.	Plate	
94036	2114	Hand Attachment Driver Finger for 94041
94037	2114	Hand Attachment Driver Finger Latch for 94052
94038	2114	Hand Attachment Driver Finger Latch Spring for 94052
94039	2114	Hand Attachment Driver Finger Driving Pad (raw-hide) for 94041
94040	2114	Hand Attachment Driver Finger Driving Pad Plate for 94041
94041	--	Hand Attachment Driver Finger 94036, with SS567e, 94039 and 94040, for 94052
94044	2114	Hand Attachment Driver Finger Hinge Pin for 94052
†94046	2114	Hand Attachment Driver for 94070
94048	2114	Hand Attachment Pinion for 94070
†94050	2284	Hand Attachment Body for 94052
†94051	2284	Hand Attachment Gear with 55531, 94032 and 94033zb, for 94052
†94052	2284	Hand Attachment, complete, Nos. SS565e, SS566e, SS599f, SS600f, 94016, 94027, 94034b, 94037, 94038, 94041, 94044, 94050, 94051, 94069, 94070, two each 183e and 399za
94069	2114	Hand Attachment Crank Hinge Pin for 94052
94070	--	Hand Attachment Driver 94016 with 80028 and 94048, for 94052
96416	--	Embroidery Hoop (round, birch) 7" diam. × 7 ^m / ₁₆ " high, Nos. 101346 and 101347
96417	--	Embroidery Hoop (round, birch) 5 ¹ / ₂ " diam. × 7 ^m / ₁₆ " high, Nos. 101348 and 101349
96418	2659	Embroidery Hoop (round, birch) 7" diam. × 7 ^m / ₁₆ " high, Nos. 101350 and 101351
96419	--	Embroidery Hoop (round, birch) 8" diam. × 7 ^m / ₁₆ " high, Nos. 101352 and 101353
96420	--	Embroidery Hoop (round, birch) 10" diam. × 7 ^m / ₁₆ " high, Nos. 101354 and 101355
96421	--	Embroidery Hoop (round, birch) 12" diam. × 7 ^m / ₁₆ " high, Nos. 101356 and 101357
96422	2659	Embroidery Hoop (oval, birch) 9" × 4 ¹ / ₂ " × 7 ^m / ₁₆ " high, Nos. 101358 and 101359
96423	--	Embroidery Hoop (oval, birch) 9" × 4 ¹ / ₂ " × 7 ^m / ₁₆ " high, Nos. 101360 and 101361
96424	--	Embroidery Hoop (oval, birch) 12" × 5 ¹ / ₂ " × 7 ^m / ₁₆ " high, Nos. 101362 and 101363

† In ordering it is necessary to state Colour of Machine.

No.	Plate	
96425	2399	Embroidery Hoop Clamping Bracket for 101349, 101361 and 101363
96426	2399	Embroidery Hoop Clamping Bracket for 101351, 101353, 101355, 101361 and 101363
96427	2399	Embroidery Hoop Clamping Bracket Rivet for 101349, 101351, 101353, 101355, 101361 and 101363
96844	2399	Embroidery Hoop Clamping Bracket for 101357
96845	2399	Embroidery Hoop Clamping Bracket Rivet for 101357
101246	--	Embroidery Hoop (round, birch) 10" diam. × 7 ^m / ₁₆ " high, complete, Nos. 101364 and 101365
101336	--	Embroidery Hoop (inner) for 87586
101337	--	Embroidery Hoop (outer) for 87586
101338	--	Embroidery Hoop (inner) for 87589
101339	--	Embroidery Hoop (outer) for 87589
101340	--	Embroidery Hoop (inner) for 87593
101341	--	Embroidery Hoop (outer) for 87593
101342	--	Embroidery Hoop (inner) for 87595
101343	--	Embroidery Hoop (outer) for 87595
101344	--	Embroidery Hoop (inner) for 87597
101345	--	Embroidery Hoop (outer) for 87597
101346	--	Embroidery Hoop (inner) for 96416
101347	--	Embroidery Hoop (outer) for 96416
101348	--	Embroidery Hoop (inner) for 96417
101349	--	Embroidery Hoop (outer) with SS528j, NN95j, two 96425 and four 96427, for 96417
101350	--	Embroidery Hoop (inner) for 96418
101351	--	Embroidery Hoop (outer) with SS528j, NN95j, two 96426 and four 96427, for 96418
101352	--	Embroidery Hoop (inner) for 96419
101353	--	Embroidery Hoop (outer) with SS528j, NN95j, two 96426 and four 96427, for 96419
101354	--	Embroidery Hoop (inner) for 96420
101355	--	Embroidery Hoop (outer) with SS528j, NN95j, two 96426 and four 96427, for 96420
101356	--	Embroidery Hoop (inner) for 96421
101357	--	Embroidery Hoop (outer) with SS528j, NN95j, two 96844 and four 96845, for 96421

No.	Plate		
101358	—	Embroidery Hoop (inner) for 96422	...
101359	—	Embroidery Hoop (outer) for 96422	...
101360	---	Embroidery Hoop (inner) for 96423	...
101361	---	Embroidery Hoop (outer) with SS528j, NN95j, 96425, 96426 and four 96427 for 96423
101362	--	Embroidery Hoop (inner) for 96424	...
101363	---	Embroidery Hoop (outer) with SS528j, NN95j, 96425, 96426 and four 96427, for 96424
101364	--	Embroidery Hoop (inner) for 101246	...
101365	---	Embroidery Hoop (outer) with Spring, for 101246
120687	2821	Imitation Hemstitching Attachment, with yielding presser plate
120842	2821	Hemmer (foot), $\frac{5}{8}$ " hem (packed with accessories)
120861	-	Tin of Oil (3 oz.) for 161324 and 161325	...
121094	2719	Darning Foot (spring) for 161325	...
121170	909	Ruffler Shirring Plate
121441	2574	Gathering Foot (double toe) for 161324 and 161325
121464	2574	Binder for 161324 and 161325
121547	909	Under Braider
125018	2820	Shuttle, $1\frac{1}{8}$ " diam., complete, Nos. 2515, 2518 and 15277
125021	2816	Crank Connecting Rod with 125044 and two 896al
125044	2816	Crank Connecting Rod Oil Pad (felt) for 125021
125047	2816	Feed Forked Connection Slide Block for 125335
125048	2818	Feed Lifting Rock Shaft Centre (left)	...
125048	2818	Feed Rock Shaft Centre (left)
125048	2818	Oscillating Rock Shaft Centre (left)	...
125049	2818	Feed Lifting Rock Shaft Centre (right)	...
125049	2818	Feed Rock Shaft Centre (right)
125049	2818	Oscillating Rock Shaft Centre (right)	...
125055u	2818	Oscillating Rock Shaft with 125056	...
125056	2818	Oscillating Rock Shaft Oil Wick (braided cotton) for 125055u
*125057u	---	Oscillating Shaft Crank for 125058u and 125059
*125058u		Oscillating Shaft Crank 125057u with 462al and 125330 for 125086

No.	Plate		
125059	2818	Oscillating Shaft Crank 125057u with 125330 and two 462al (<i>for Agents only</i>)
*125060	-	Feed Bar Roller Stud for 1813
*125060	-	Oscillating Shaft Crank Slide Block Stud for 125330
125061	2819	Presser Bar
*125062	---	Shuttle Driver for 125063 and 125092	...
*125063	---	Oscillating Shaft 2510 with 2049 and 125062 for 125086
125064	---	Shuttle Driver 125092 with 125065 and two 51229e (<i>for Agents only</i>)
125065	2818	Shuttle Driver Cushion Spring for 125064 and 125086
125068	26009	Bobbin Winder Spindle for 125366	...
*125086	---	Oscillating Shaft 125063 with 125058u, 125065 and two 51229e
125092	2818	Shuttle Driver 125062, with two 462al for 125064
125113	2817	Throat Plate for 15279	...
125262	2816	Feed Forked Connection with 175r for 125340	...
125270u	2818	Feed Rock Shaft
*125272	2819	Needle Bar Bushing for 125273
125273	-	Needle Bar Bushing 125272 with 125274	...
125274	2819	Needle Bar Bushing Oil Pad (felt) for 125273	...
125314	26007	Tension Spring for 173552
125326	26009	Bobbin Winder Tripping Arm for 125478	...
125330	2818	Oscillating Shaft Crank Slide Block 15170, with 125060, for 125058u and 125059
125331	2816	Arm Oil Pad (felt) for oiling Arm Shaft Back Bearing for 173501
125334	2816	Arm Oil Pad Spring Cap for 173501	...
125335	-	Feed Forked Connection Slide Block 125047, with 1085e, for 125340
125336	2817	Shuttle Race Slide for 125338
125337	2817	Shuttle Race Slide Spring for 125338	...
125338	2817	Shuttle Race Slide, complete, Nos. 125336, 125337 and two 51282zj
125340	---	Feed Forked Connection 125262 with 125335	...
125366	26009	Bobbin Winder Frame 66670 with 15288 and 125068 for 125478
125376	26009	Bobbin Winder Stop Latch for 125478	...
125381		Feed Reversing Handle 45305 with 1550r for 125398
125395	26009	Bobbin Winder Tension Bracket for 125396	...

No.	Plate	
125396	26009	Bobbin Winder Tension Bracket, complete, Nos. 45847, 45915, 45916, 125395 and 140138zb
125397	2816	Feed Regulator for 125398
125398	—	Feed Regulator 125397 with 125381
125399	2816	Feed Regulator Hinge Screw Friction Washer
125400	26001	Stitch Regulating Thumb Screw Friction Washer for 125479
†125416	26007	Tension Indicator Flange, for 173552
†125421	26007	Tension Indicator for 173552
125462	26009	Bobbin Winder Stop Latch Spring for 125478
†125466	26001	Arm Side Cover
†125473	2816	Hand Wheel, 2½" pulley, for 191K1 Machine
†125475	26001	Stitch Indicator Plate for 125479
†125476	26009	Bobbin Winder Bracket (belt cover) for 125478
†125478	26009	Bobbin Winder (automatic), complete, Nos. 190r, 15287, 51303x, 51319r, 66601, 125326, 125366, 125376, 125462 and 125476 for Hand Wheels Nos. 32672, 125473 and 173548
125479	-	Stitch Regulating Plate 125381 with 45310, 51312zb, 125400 and 125475
125481	26001	Stitch Regulating Plate for 125479

† In ordering it is necessary to state Colour of Machine.

No.	Plate	
140138j	2818	Feed Throw-out Pitman Rod Washer Screw
140138zb	26009	Bobbin Winder Tension Screw for 125396
140178zj	26007	Tension Stud for 45352
140543L	-	Number Plate Drive Screw for 173501
140543L	---	Trademark Drive Screw for 173501
140545e	2819	Needle Clamp Thumb Screw for 173610
140563e	26007	Tension Releasing Lever Hinge Screw
*140768zb	2819	Pressure Regulating Thumb Screw for 173557
140876k	2819	Needle Clamp Gib Locating Screw
140991zb	26002	Face Plate Screw
160845	2719	Presser Foot (left toe) for Edge Stitching, Cording and Slide Fastener Work
160846	2719	Presser Foot (right toe) for Edge Stitching, Cording and Slide Fastener Work
161127	2719	Presser Foot (hinged, adjustable) for sewing on the right or left side of the needle, for Edge Stitching, Cording and Slide Fastener Work, for 161324 and 161325
161294	2574	Screw Driver (machine) for 161324 and 161325
161295	2574	Screw Driver (bobbin case) for 161324 and 161325
161307	-	Needle Threader (wire) for 161324 and 161325
161324	-	Attachment Set (packed in cardboard box) complete, Nos. 25527b, 50053b, 86742, 120861, 121441, 121464, 161127, 161294, 161295, 161307, two 8879 and six needles 15 × 1 (three each sizes 11 and 14) for All Countries except Denmark, Norway, Sweden and Switzerland
161325	-	Attachment Set (packed in cardboard box) complete, Nos. 25527b, 50053b, 86742, 120861, 121094, 121441, 121464, 161127, 161294, 161295, 161307, two 8879 and six needles 15 × 1 (three each sizes 11 and 14) for Denmark, Norway, Sweden and Switzerland

No.	Plate	
170066	2819	Presser Bar Lifter
171502	2816	Clamp Stop Motion Clamp Washer for 15314
171509	—	Arm Shaft Counterbalance with 1285al for 173559
171512	2816	Feed Cam with 1285al for 173559
171515	2820	Shuttle Race Cap for 171540 to 171542 ...
171539	2820	Shuttle Race Body for 171540 to 171542 ...
171540	—	Shuttle Race Body 171539 with 171515 and two 662j (for Agents only)
171541	2820	Shuttle Race, complete, Nos. 171515, 171539, 171543 to 171546, 173551, two each 87k, 662j, 173536 and 173538
171542	—	Shuttle Race, complete, Nos. 2515, 171515, 171539, 171543 to 171546, 173551, two each 87k, 662j, 173536 and 173538 (for Agents only)
171543	2820	Shuttle Race Gate for 171541 and 171542 ...
171544	2820	Shuttle Race Gate Hinge Stud for 171541 and 171542
171545	2820	Shuttle Race Gate Hinge Stud Nut for 171541 and 171542
171546	2820	Shuttle Race Gate Hinge Stud Spring for 171541 and 171542
†173501	—	Arm and Bed, with Nos. 81110, 125331, 125334 and four 140543L
173503	2816	Arm Shaft Bushing for 173559
173504zb	—	Face Plate for 173505zb
173505zb	—	Face Plate, complete, Nos. 173504zb, two each 32755 and 173616 for Black Machines
173508	2818	Feed Bar
173510u	2818	Feed Lifting Rock Shaft for 173511
173511	—	Feed Lifting Rock Shaft with Feed Throw-out Assembly, complete, Nos. 173510u, 173513 and 173520x
173512	2818	Feed Lifting Rock Shaft Crank, with 704x and 50150al for 173513
173513	—	Feed Lifting Rock Shaft Crank with Feed Throw-out Lever, complete, Nos. 173512 and 173515 to 173517u for 173511 ...
†173514	2818	Feed Throw-out Knob with 442al
173515	2818	Feed Throw-out Lever with 1813 for 173513
173516	2818	Feed Throw-out Lever Tension Spring for 173513
173517u	2818	Feed Throw-out Lever Tension Spring Hinge Stud for 173513

† In ordering it is necessary to state Colour of Machine.

N	Plate	
173518u	2818	Feed Throw-out Pitman Rod
173519x	2818	Feed Throw-out Plunger
173520x	2818	Feed Throw-out Plunger Bracket for 173511
173524	—	Needle Bar Connecting Link 45231 with 173554 for 173566
173527	2819	Presser Bar Guide Bracket with 454al
173536	2820	Shuttle Race Gate Latch for 171541 and 171542
173538	2820	Shuttle Race Gate Latch Spring for 171541 and 171542
173539	26007	Tension Releasing Lever... ..
173541	26007	Thread Guard (head of arm, upper)
173542	2819	Thread Take-up Crank for 173566
173545	2819	Thread Take-up Lever Link for 173563
173547	2818	Feed Throw-out Knob Shaft and Bobbin Winder Spool Pin
+173548	2816	Hand Wheel (spoked), 2½" pulley, for 191K2 Machine
173551	2820	Shuttle Race Gate Hinge Pin for 171541 and 171542
173552	26007	Tension (graduated), complete, Nos. 45352, 45865, 45873, 66774, 125314, 125416, 125421, 173556 and two 2192
173553	2819	Thread Take-up Lever Hinge Stud for 173563
173554	2819	Needle Bar Connecting Stud with 51363e for 173524
173555	2819	Needle Bar Hole Plug
173556	26007	Tension Releasing Pin for 173552
173557	—	Pressure Regulating Thumb Screw 140768zb with 66752
173558	2819	Thread Take-up Lever Link Hinge Stud for 173564
173559	—	Arm Shaft 173663 with 171509, 171512, 173503 and 173600
173563	—	Thread Take-up Lever 45261 with 173545 and 173553 for 173564
173564	—	Thread Take-up Lever, complete, Nos. 1130e, 173558 and 173563 for 173565
173565	—	Thread Take-up Lever 173564 with 173566
173566	—	Thread Take-up Crank 173542 with 1130e and 173524 for 173565
†173572	26002	Face Plate for 173573
173573	26002	Face Plate, complete, Nos. 173572, two each 32755 and 173616 (for Two-Tone finish machines)

+ In ordering it is necessary to state Colour of Machine.

NUMERICAL LIST OF PARTS

No.	Plate	
173600	2816	Needle Bar Crank with 1036al and 1293al for 173559
*173601	—	Arm
*173602	—	Bed
173603	2816	Arm Shaft for 173559
173608	2819	Needle Bar
173609	2819	Needle Clamp for 173610
173610	2819	Needle Clamp 173609 with 140545c
173611	2819	Needle Clamp Gib
173615	26002	Face Plate Thread Guard 32755 with 173616 (for Agents only)
173616	—	Face Plate Thread Guard Rivet for 173565zb, 173573 and 173615