

SINGER
188U

FORM U142

Rev. (573)

MACHINE PARTS CHART **for**

SINGER*

188u

* A Trademark of THE SINGER COMPANY
Copyright © 1973 THE SINGER COMPANY
All Rights Reserved Throughout the World -

SINGER^{*}

188u

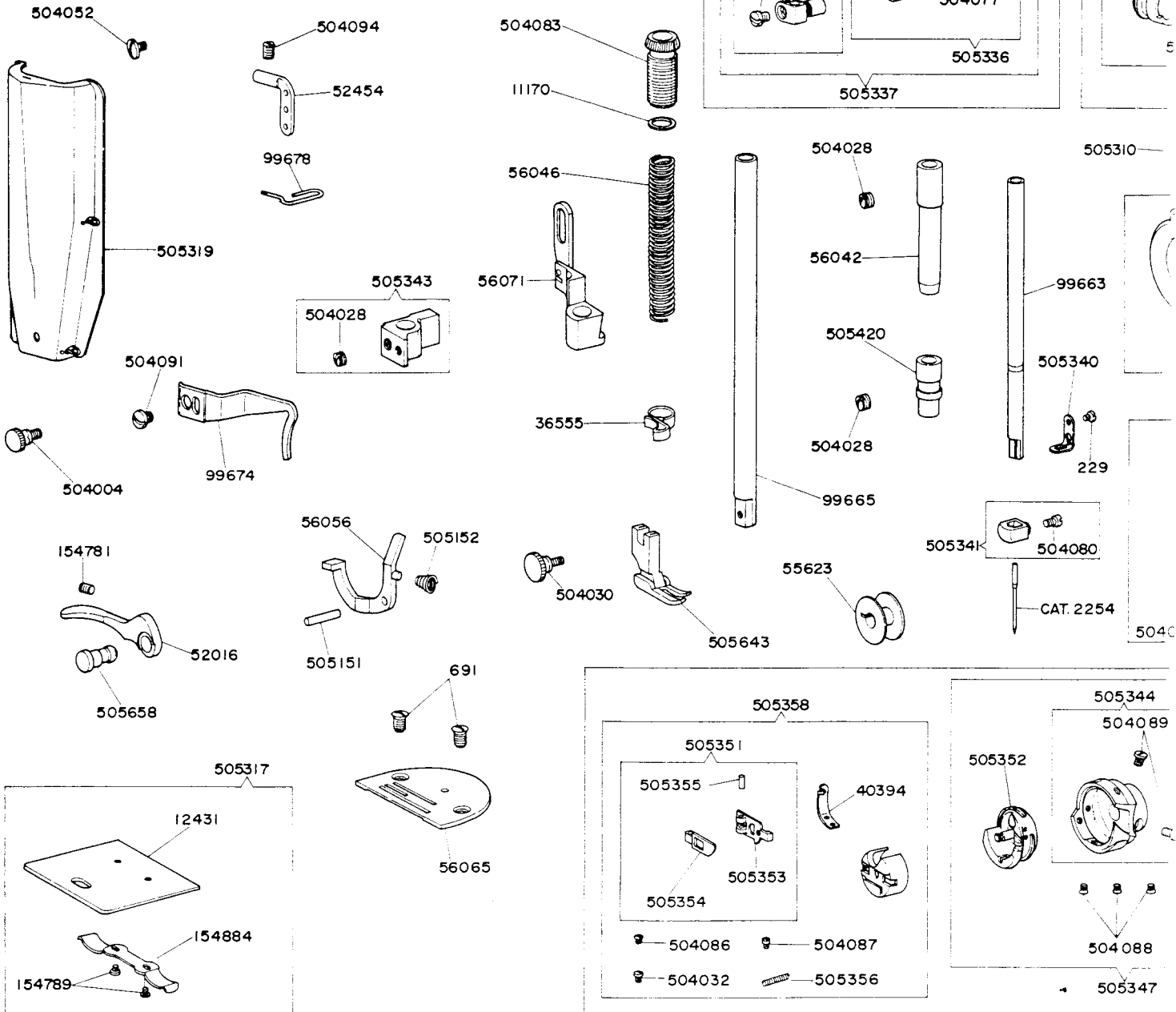
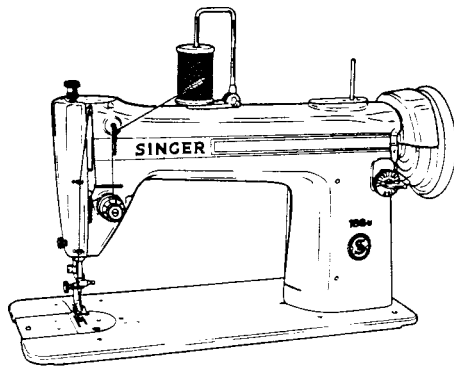

NUMERICAL LIST OF PARTS FOR MACHINE 188U

<u>PART NO.</u>	<u>DESCRIPTION</u>	<u>PART NO.</u>	<u>DESCRIPTION</u>
505332	Feed Reverse Lever with two 504075	504509 (809)	Lifting Lever Connecting Rod Lock Nut
505333	Feed Rock Shaft	505384	Bell Crank complete, Nos. 56073, 505417, 505418 and 505419
505335	Feed Rock Shaft Crank with 504019	505385	Lifting Lever
505336	Needle Bar Connecting Link with 504077	505386	Lifting Lever Connecting Rod
505337	Needle Bar Connecting Link 505336 with 505338	505387	Lifting Lever Connecting Rod Joint
505338	Needle Bar Connecting Stud with 504078	505417	Bell Crank
505339	Needle Bar Crank with 504095, 504101 and 504120	505418	Bell Crank Bracket
505340	Needle Bar Thread Guard	505419	Bell Crank Hinge Pin
505341	Needle Clamp with 504080		
505343	Presser Bar Guide Bracket with 504028		
505344	Rotating Hook with two 504089		
505347	Rotating Hook 505344 with 504088, 504099, 505352, 505360 and 505364		
505348	Rotating Hook 505347 with 505358	55623	Rotating Hook Bobbin (5)
505351	Rotating Hook Bobbin Case Hinge Nos. 505353, 505354 and 505355	541513	Screw Driver (large)
		541514	Screw Driver (small)
505352	Rotating Hook Bobbin Case Holder	541515 (001)	Cloth Guide (purchased part)
505353	Rotating Hook Bobbin Case Latch	541516 (001)	Hemmer Foot (1/8" hem) (purchased part)
505354	Rotating Hook Bobbin Case Latch Lever	541536	Accessory Box
505355	Rotating Hook Bobbin Case Latch Lever Fulcrum Pin	546922	Oiler with Oil Spout (130 cc filled with Singer Type "A" Oil) (for treadle operation)
505356	Rotating Hook Bobbin Case Latch Spring	546923	Oiler with Oil Spout (130 cc filled with Singer Type "B" Oil) (for motor drive)
505357	Rotating Hook Shaft Bushing (front)		
505358	Rotating Hook Bobbin Case with 40394, 504032, 504086, 504087, 505351 and 505356	549281 (001)	Cloth Guide Thumb Screw (purchased part)
505360	Rotating Hook Section	CAT.2254	Needle (16 x 231 #14) (3)
505361	Rotating Hook Shaft Bevel Gear with two 504101		
505362	Rotating Hook Shaft Bevel Gear Case (two pieces) with 140184 and three 504071		
			<u>BOBBIN WINDER</u> (Supplied with Machine)
505364	Rotating Hook Thread Guard		For Treadle Operation:
505365	Spool Holder Base	20437	Bobbin Winder Screw Washer
505367	Spool Holder Wire	504098 (852)	Bobbin Winder Screw
505368	Spool Holder complete, Nos. 504093, 505365 and 505367	505395	Bobbin Winder Tension Bracket complete
		546907 (001)	Bobbin Winder complete (purchased part)
505369	Tension Releasing Pin		For Motor Drive:
505371	Thread Take-up Crank	505655 (001)	Universal Bobbin Winder complete with two Nails (purchased part)
505372	Thread Take-up Lever Link Hinge Pin		
505373	Thread Take-up complete, Nos. 166035, 504057, 505337, 505371 and 505372		
505374	Thread Take-up Spring Regulator		
505375	Belt Cover		
505407	Feed Bar Screw Center 504068 with 504502 (2)		
505408	Feed Lifting Rock Shaft Screw Center 504072 with 504504 (2)		
505408	Feed Rock Shaft Screw Center 504072 with 504504 (2)		
505409	Thread Take-up Spring Regulator 505374 with 504047		
505414	Arm Shaft (horizontal) Flanged Bushing (front) Oil Tube		
505420	Needle Bar Bushing (lower)		
505427	Rotating Hook Shaft Retainer Collar with two 504048		
505428	Arm Shaft (horizontal) Flanged Bushing (front)		
505508	Arm Oil Tube (front of arm, back)		
505511	Arm Oil Tube (front of arm, front)		
505513	Arm Oil Tube Packing (cotton) (4)		
505643	Presser Foot (spring hinged)		
505658	Presser Bar Lifter Pin		
545045 (833)	Feed Regulator Hinge Stud Set Screw		
545115 (829)	Spool Holder Base Screw		
545479	Tension Regulating Thumb Nut		
546320	Hand Wheel (for treadle operation)		
546321	Tension Stud		
546901	Tension Stud 546321 with 545479		
546902	Tension complete, Nos. 32758, 99691, 125314, 505369, 505409, 549857, 549858, 546901 and two 2102		
546936	Hand Wheel (for electric drive)		
549857	Tension Indicator		
549858	Tension Indicator Flange		
CAT.2254	Needle (16 x 231 #14)		

KNEE LIFTER PARTS
(Fitted to Machine)

866 (852)	Lifting Lever Hinge Screw
56071	Presser Bar Lifting and Releasing Lever Bracket
56073	Bell Crank Spring
504099 (809)	Bell Crank Bracket Screw (2)
504100 (852)	Lifting Lever Connecting Rod Joint Hinge Screw

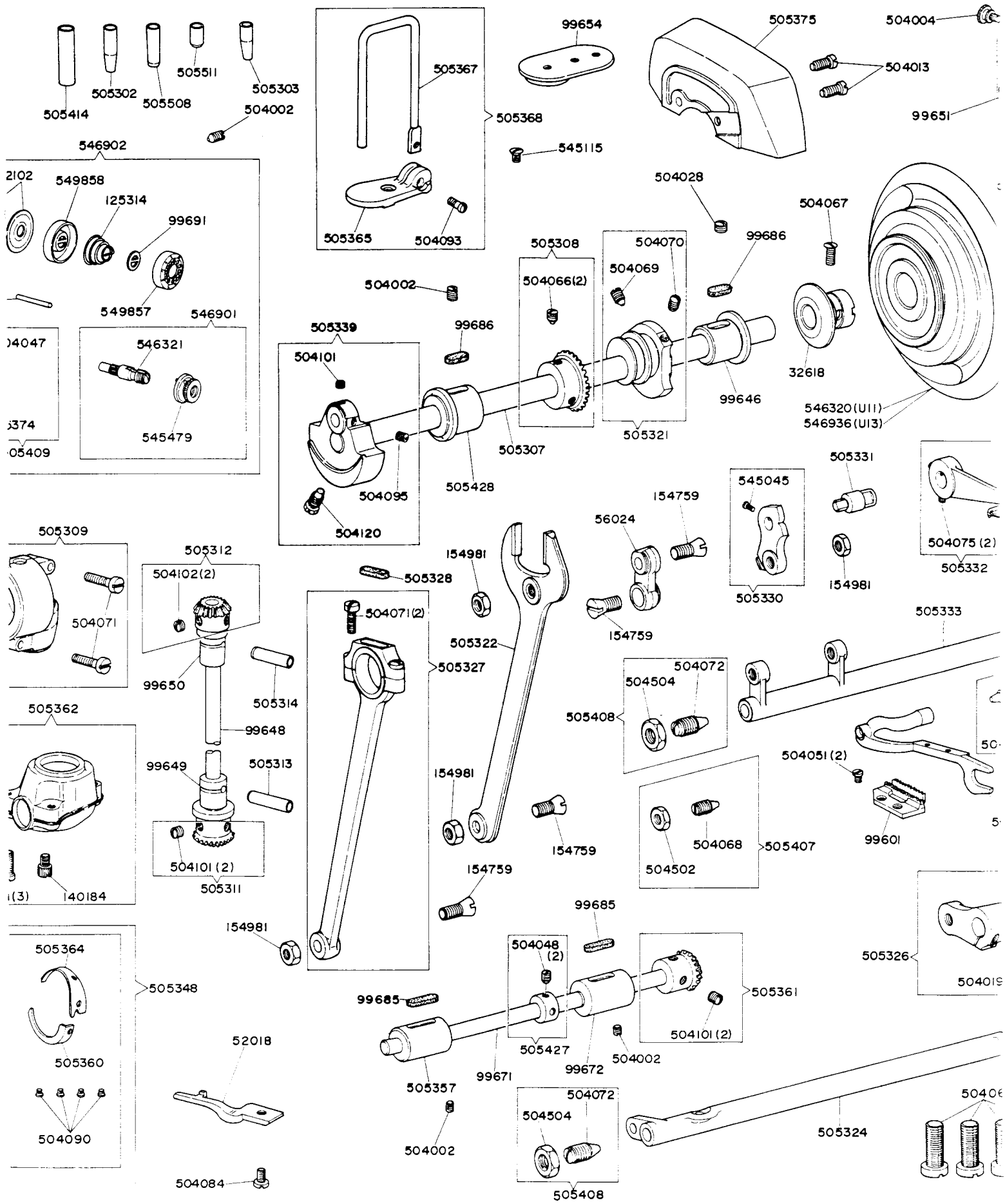

ATTACHMENTS AND ACCESSORIES

CAT. 2254

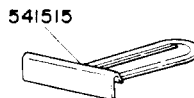
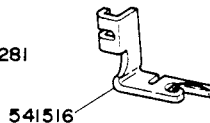
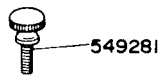
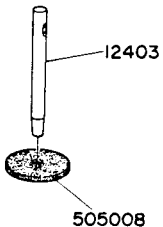
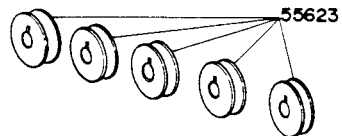

541514

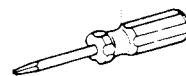

546922 "A" OIL (U11)
546923 "B" OIL (U13)

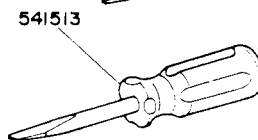

BOBBIN WINDER FOR MOTOR DRIVE

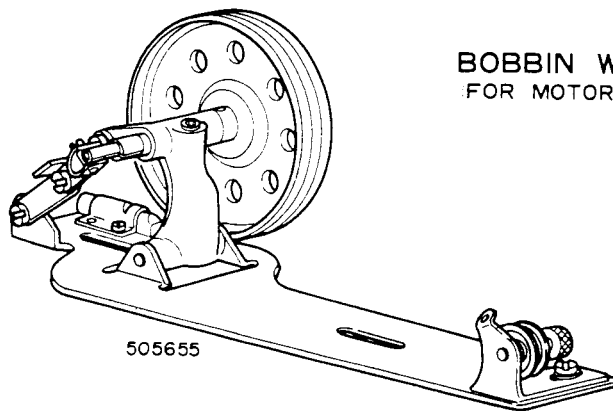

BOBBIN WINDER FOR TREADLE OPERATOR

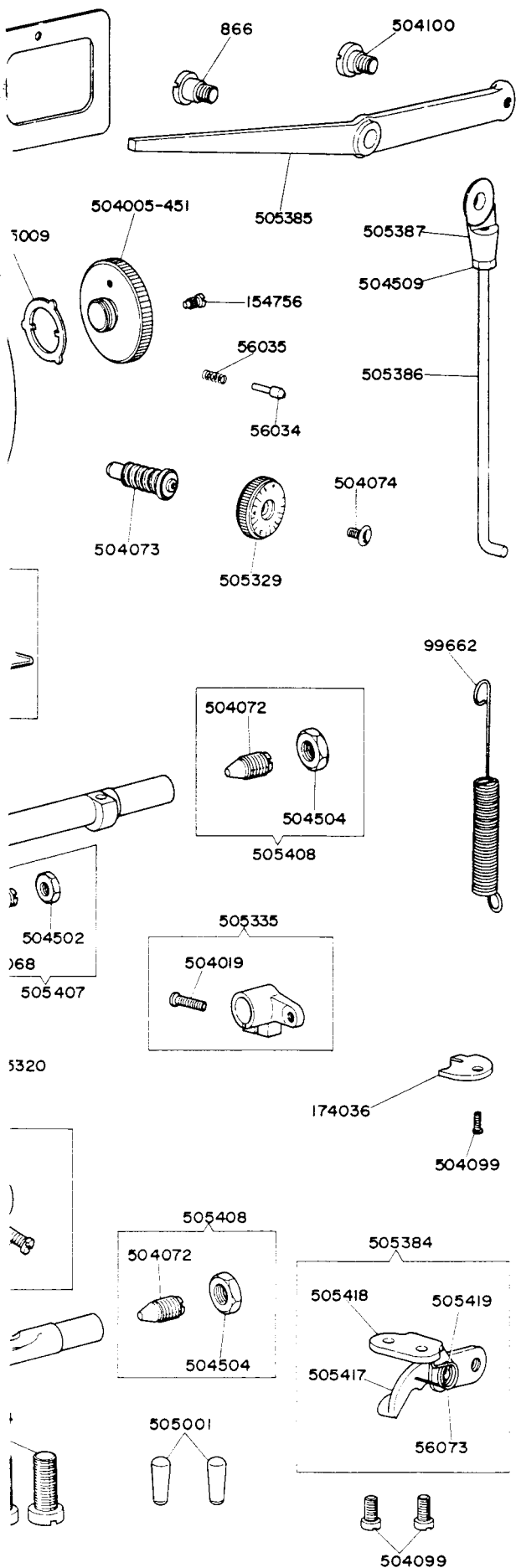
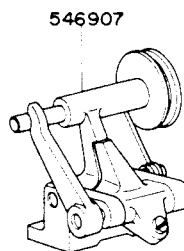
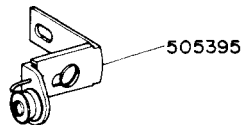

NUMERICAL LIST OF PARTS FOR MACHINE 188U

<u>PART NO.</u>	<u>DESCRIPTION</u>	<u>PART NO.</u>	<u>DESCRIPTION</u>
229 (807)	Needle Bar Thread Guard Screw	504048 (830)	Rotating Hook Shaft Retainer Collar Screw (2)
691 (850)	Throat Plate Screw (2)	504051 (850)	Feed Dog Screw (2)
2102	Tension Disc (2)	504052 (809)	Face Plate Screw
11170	Presser Bar Spring Washer	504057 (805)	Needle Bar Connecting Link Cap Screw
12403	Arm Top Cover Spool Pin and Thread Eyelet	504064 (805)	Arm Screw (4)
12431	Bed Slide	504066 (833)	Arm Shaft (horizontal) Bevel Gear Set Screw (2)
32618	Clamp Stop Motion Flanged Bushing	504067 (850)	Clamp Stop Motion Flanged Bushing Set Screw
32758	Thread Take-up Spring	504068 (803)	Feed Bar Screw Center (2)
36555	Thread Cutter and Holder	504069 (833)	Feed and Feed Lifting Eccentric Position Screw
40394	Rotating Hook Bobbin Case Tension Spring	504070 (850)	Feed and Feed Lifting Eccentric Set Screw
52016	Presser Bar Lifter	504071 (833)	Arm Shaft (horizontal) Bevel Gear Case Screw (2)
52018	Rotating Hook Bobbin Case Holder Position Bracket	504071 (833)	Feed Lifting Rock Shaft Crank Connecting Rod Cap Screw (2)
52022	Thread Take-up Lever	504071 (833)	Rotating Hook Shaft Bevel Gear Case Screw (3)
52024	Thread Take-up Lever Link	504072 (803)	Feed Lifting Rock Shaft Screw Center (2)
52454	Thread Retainer	504072 (803)	Feed Rock Shaft Screw Center (2)
55623	Rotating Hook Bobbin	504073 (803)	Feed Regulating Stud
56024	Feed Connecting Link	504074 (852)	Feed Regulating Stud Head Cap Screw
56034	Feed Regulating Stud Lock Pin	504075 (830)	Feed Reverse Lever Set Screw (2)
56035	Feed Regulating Stud Lock Pin Spring	504077 (803)	Needle Bar Connecting Link Adjusting Screw
56042	Needle Bar Bushing (upper)	504078 (806)	Needle Bar Connecting Stud Clamping Screw
56046	Presser Bar Spring	504080 (851)	Needle Clamp Screw
56056	Tension Releasing Lever	504083 (852)	Pressure Regulating Thumb Screw
56065	Throat Plate (large needle hole)	504084 (810)	Rotating Hook Bobbin Case Holder Position Bracket Screw
99601	Feed Dog	504086 (806)	Rotating Hook Bobbin Case Tension Regulating Screw
99646	Arm Shaft (horizontal) Flanged Bushing (back)	504087 (806)	Rotating Hook Bobbin Case Tension Spring Screw
99648	Arm Shaft (upright)	504088 (803)	Rotating Hook Section Screw (3)
99649	Arm Shaft (upright) Flanged Bushing (lower)	504089 (832)	Rotating Hook Set Screw (2)
99650	Arm Shaft (upright) Flanged Bushing (upper)	504090 (803)	Rotating Hook Thread Guard Screw (4)
99651	Arm Side Cover	504091 (810)	Slack Thread Regulator Adjusting Screw
99654	Arm Top Cover	504093 (809)	Spool Holder Wire Hinge Screw
99662	Feed Reverse Lever Return Spring	504094 (833)	Thread Retainer Set Screw
99663	Needle Bar (hollow)	504095 (850)	Thread Take-up Crank Position Screw
99665	Presser Bar (hollow)	504099 (809)	Feed Regulator Spring Bracket (hook) Screw
99671	Rotating Hook Shaft	504101 (850)	Arm Shaft (upright) Bevel Gear (lower) Set Screw (2)
99672	Rotating Hook Shaft Bushing (back)	504101 (850)	Rotating Hook Shaft Bevel Gear Set Screw (2)
99674	Slack Thread Regulator	504101 (850)	Thread Take-up Crank Set Screw
99678	Thread Guard (side of arm)	504102 (833)	Arm Shaft (upright) Bevel Gear (upper) Set Screw (2)
99685	Rotating Hook Shaft Bushing (back and front) Oil Pad (felt) (2)	504120 (850)	Needle Bar Crank Position Screw
99686	Arm Shaft (horizontal) Flanged Bushing (back and front) Oil Pad (felt) (2)	504502 (819)	Feed Bar Screw Center Nut (2)
99691	Tension Indicator Flange Washer	504504 (819)	Feed Lifting Rock Shaft Screw Center Nut (2)
125314	Tension Spring	504504 (819)	Feed Rock Shaft Screw Center Nut (2)
140184	Rotating Hook Shaft Bevel Gear Case Drain Plug	505001	Arm Dowel Pin (2)
154756 (851)	Clamp Stop Motion Clamp Stop Screw	505008	Arm Spool Pin Washer (felt)
154759 (850)	Feed Connecting Link Hinge Screw (2)	505009	Clamp Stop Motion Clamp Washer
154759 (850)	Feed Forked Connection Hinge Screw	505151	Tension Releasing Lever Hinge Pin
154759 (850)	Feed Lifting Rock Shaft Crank Connecting Rod Hinge Screw	505152	Tension Releasing Lever Spring
154781 (850)	Presser Bar Lifter Pin Set Screw	505302	Arm Oil Tube for Oiling 505337
154789 (809)	Bed Slide Spring Screw (2)	505303	Arm Oil Tube for Oiling 505321 and 505322
154884	Bed Slide Spring	505307	Arm Shaft (horizontal)
154981 (819)	Feed Connecting Link Hinge Screw Nut (2)	505308	Arm Shaft (horizontal) Bevel Gear with two 504066
154981 (819)	Feed Forked Connection Hinge Screw Nut	505309	Arm Shaft (horizontal) Bevel Gear Case (two pieces) with two 504071
154981 (819)	Feed Lifting Rock Shaft Crank Connecting Rod Hinge Screw Nut	505310	Arm Shaft (horizontal) Bevel Gear Case Position Pin
166035	Thread Take-up Lever complete, Nos. 52022 and 52024	505311	Arm Shaft (upright) Bevel Gear (lower) with two 504101
174036	Feed Regulator Spring Bracket (hook)	505312	Arm Shaft (upright) Bevel Gear (upper) with two 504102
504002 (850)	Arm Shaft (horizontal) Flanged Bushing (front) Set Screw	505313	Arm Shaft (upright) Oil Tube (lower)
504002 (850)	Rotating Hook Shaft Bushing (back) Set Screw	505314	Arm Shaft (upright) Oil Tube (upper)
504002 (850)	Rotating Hook Shaft Bushing (front) Set Screw	505317	Bed Slide complete, Nos. 12431, 154884 and two 154789
504002 (850)	Thread Take-up Lever Link Hinge Pin Set Screw	505319	Face Plate with two each 173616 and 505134
504002 (850)	Thread Take-up Spring Regulator Set Screw	505320	Feed Bar
504004 (852)	Arm Side Cover Thumb Screw	505321	Feed and Feed Lifting Eccentric with 504069 and 504070
504004 (852)	Face Plate Thumb Screw	505322	Feed Forked Connection
504005 (451)	Clamp Stop Motion Clamp Screw (Spec. 1039)	505324	Feed Lifting Rock Shaft with 504751
504013 (850)	Belt Cover and Bobbin Winder Tension Bracket Screw	505326	Feed Lifting Rock Shaft Crank with 504019
504013 (850)	Belt Cover Screw	505327	Feed Lifting Rock Shaft Crank Connecting Rod with two 504071
504019 (808)	Feed Lifting Rock Shaft Crank Clamping Screw	505328	Feed Lifting Rock Shaft Crank Connecting Rod Cap Oil Pad (felt)
504019 (808)	Feed Rock Shaft Crank Clamping Screw	505329	Feed Regulating Stud Head
504028 (850)	Arm Shaft (horizontal) Flanged Bushing (back) Set Screw	505330	Feed Regulator with 545045
504028 (850)	Needle Bar Bushing (lower) Set Screw	505331	Feed Regulator Hinge Stud
504028 (850)	Needle Bar Bushing (upper) Set Screw		
504028 (828)	Presser Bar Guide Bracket Set Screw		
504030 (854)	Presser Foot Thumb Screw		
504032 (805)	Rotating Hook Bobbin Case Latch Stop Screw		
504047 (830)	Tension Stud Set Screw		