

Form 18434
March, 1930
PRINTED IN U. S. A.

LIST OF PARTS

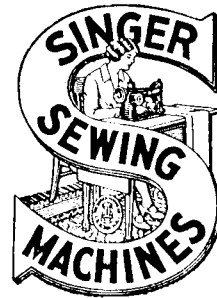

MACHINE No. 147-36

THE SINGER MANUFACTURING COMPANY

COPYRIGHT, U. S. A., 1925, 1928 AND 1930
BY THE SINGER MANUFACTURING CO.
ALL RIGHTS RESERVED FOR ALL COUNTRIES

INDEX

	PAGE
ACCESSORIES	17
BELT GUARD.....	18
BENCH STAND.....	18
EDGE FOLDERS AND STRIP GUIDES	18
FOOT LIFTER PARTS.....	19
KNEE LIFTER PARTS.....	19
MACHINE BASE.....	20
MACHINE No. 147-36.....	7
NUMERICAL LIST OF PARTS.....	23
OBSOLETE PARTS.....	21
THREAD UNWINDER.....	20

INSTRUCTIONS FOR ORDERING

In ordering from this list, use **ONLY** the part NUMBER in the **FIRST** column.

The number stamped on a Sewing Machine part is in every case the number of the single part only.

Every combination of parts sent out as such has its specific number, which, although not stamped on the parts, must be used when ordering the combination.

Each number always indicates the **SAME PART** in whatever list it appears, or for whatever machine.

The letters after some of the numbers indicate the style of finish only, as follows:

- A—Hardened, Polished, Nickel Plated and Buffed
- B—Polished, Nickel Plated and Buffed
- C—Hardened Only
- D—Polished Only
- E—Soft, Not Polished
- F—Hardened and Polished
- H—Blued
- J—Nickel Plated Only
- K—Hardened and Nickel Plated
- L—Brass Plated
- M—Oxidized
- N—Japanned, Dull
- P—Japanned, Bright
- R—Merlized
- T—Copper Plated
- T. A.—Hardened, Polished, Copper and Nickel Plated and Buffed
- T. B.—Copper and Nickel Plated and Polished
- T. J.—Copper and Nickel Plated Only
- T. K.—Hardened, Copper and Nickel Plated
- T. M.—Copper Plated and Oxidized
- T. L.—Copper and Brass Plated
- U—Zinc Plated
- V—Silver Plated
- W—Polished and Nickel Plated
- Z—Chromium Plated
- Z. B.—Polished, Nickel Plated, Buffed and Chromium Plated
- Z. J.—Nickel and Chromium Plated

These letters **MUST BE USED** when they appear in the list; and **AFTER** the number **as** in the list.

In this series:

- 1 to 1500 and 50001 to 51500 are Screw Numbers
- 1501 to 1800 and 51501 to 51800 are Nut Numbers
- 1801 to 2000 and 51801 to 52000 are Roller Numbers
- 2001 to 50000 and 52001 and upward are numbers of Machine Parts

The figures in the second column refer only to the plates, illustrating the parts, and are **NOT TO BE USED** in ordering.

Parts marked with an asterisk (*) are furnished only when repairs are made at factory.

LIST OF PARTS COMPLETE

FOR

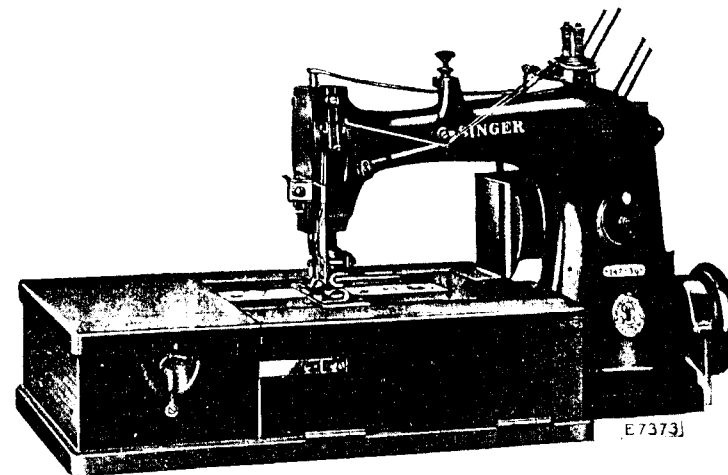

MACHINE No. 147-36

FOR SHIRTS, UNDERWEAR, CURTAIN WORK, ETC. HAS POSITIVE RUFFLING MECHANISM ADJUSTABLE FOR VARIOUS SIZE RUFFLE AND UPPER RIGHT HAND AND LOWER LEFT HAND EDGE FOLDER. TWO NEEDLES, TWO LOOPERS. GAUGES $\frac{3}{32}$ IN. TO $\frac{3}{8}$ IN. SPEED UP TO 3200, ACCORDING TO THE MATERIAL BEING STITCHED.

NO.	PLATE	NAME
*68028	---	Arm, upper and lower (solid) with 948b, 54034, 68051 and three 129b.....
42366	8901	Arm Oil Pad (braided cotton) for oiling Arm Rock Shaft Front Bearing.....
56006	8901	Arm Oil Pad (braided cotton) for oiling Arm Rock Shaft Intermediate Bearing.....
56003	8985	Arm Oil Tube with 52045, for oiling 54326
52045	8901	" " " Packing (braided cotton)..
54002	8902	" Rock Shaft.....
51079	---	" " " 54002 with 54004, 54005 and 64255.....
64386	8901	Arm Rock Shaft Bushing (back).....
56006	8901	" " " " Oil Pad (braided cotton).....

NO.	PLATE	NAME
446c	8901	Arm Rock Shaft Bushing (back) Set Screw
64388	8901	“ “ “ “ (intermediate)
423c	8901	“ “ “ “ “
		Set Screw
52045	8901	Arm Rock Shaft Bushing Oil Pad (braided cotton).....
54004	8901	Arm Rock Shaft Collar with two 453c...
453c	8901	“ “ “ “ Set Screw.....
54005	8901	“ “ “ Crank (back) with two 50083c.....
50083c	8901	Arm Rock Shaft Crank (back) Set Screw
64255	9882	“ “ “ “ (front) with 453c
2117	8901	“ “ “ “ “ Pin.....
453c	8901	“ “ “ “ “ Set Screw
54105	8901	“ “ “ Flanged Bushing (front)
52045	8901	“ “ “ “ “ Oil Pad (braided cotton).....
453c	8901	Arm Rock Shaft Flanged Bushing (front) Set Screw
*54359	—	Arm Rotary Shaft.....

NOTE: When No. 54359 is required for repairs, the Looper Driving Shaft and Feed Lifting Eccentric must be returned to the factory to be adjusted to the new part.

68060	—	Arm Rotary Shaft 54359 with 640b, 54008, 54088, 54113, 54383, 64351, 64355 and 68047.....
54367	8985	Arm Rotary Shaft Bushing (front).....
761E	8901	“ “ “ “ “ Set Screw.....
54007	8902	Arm Rotary Shaft Bushing (intermediate)
54089	—	“ “ “ “ “ 54007 with 64508 and 64805.....
64508	8902	Arm Rotary Shaft Bushing (intermediate) Oil Pad, long (braided cotton).....
64805	8985	Arm Rotary Shaft Bushing (intermediate) Oil Pad, short (braided cotton).....
422c	8901	Arm Rotary Shaft Bushing (intermediate) Set Screw (long).....
50084c	8901	Arm Rotary Shaft Bushing (intermediate) Set Screw (short).....
54008	8901	Arm Rotary Shaft Collar with three 1259c
1259c	8958	“ “ “ “ “ Set Screw.....
54009	8902	“ “ “ Flanged Bushing.....
54090	—	“ “ “ “ “ 54009 with 58039 and 64805.....

NO.	PLATE	NAME
58039	8902	Arm Rotary Shaft Flanged Bushing Oil Pad, long (braided cotton).....
64805	8985	Arm Rotary Shaft Flanged Bushing Oil Pad, short (braided cotton).....
159F	8901	Arm Rotary Shaft Flanged Bushing Screw
49013	8904	“ “ “ Front Bearing Oil Pad (braided cotton).....
144D	8901	Arm Rotary Shaft Screw.....
15196	8902	“ Side Cover (back).....
286D	8904	“ “ “ “ Thumb Screw....
54010	8904	“ “ “ (front).....
286D	8904	“ “ “ “ Thumb Screw....
64259	9914	Balance Wheel with two 430c.....
430c	8904	“ “ Set Screw.....
68029	9915	Cloth Plate.....
68030	9910	“ “ Oil Tube with 49092.....
49092	9910	“ “ “ “ Packing (felt).....
68031	9913	“ “ Slide (front).....
38419	8904	“ “ “ “ Spring.....
725J	8904	“ “ “ “ “ Screw... ..
68032	—	Cloth Plate Slide (front) complete, Nos. 38419, 68031 and two 725J.....
54012	8902	Cloth Plate Slide (left).....
38419	8904	“ “ “ “ Spring.....
725J	8904	Cloth Plate Slide (left) Spring Screw.....
54013	—	Cloth Plate Slide (left) complete, Nos. 38419, 54012 and two 725J.....
54057	9913	Cloth Plate Slide (right).....
38419	8904	“ “ “ “ Spring.....
725J	8904	“ “ “ “ “ Screw... ..
54058	—	Cloth Plate Slide (right) complete, Nos. 38419, 54057 and two 725J.....
68033	—	Cloth Plate complete, for $\frac{3}{8}$ in. to $\frac{3}{8}$ in. gauges, Nos. 54013, 54058, 68029, 68030 and 68032.....
1011F	8904	Cloth Plate Screw (left).....
50473F	8904	“ “ “ (right).....
68034	9915	“ “ Thread Guard.....
1235F	8904	“ “ “ “ Screw.....
54017	8902	Crank Connecting Rod with 6575, 54018, 54218, 54897, 57222 and two each 896E and 1057E.....
54088	—	Crank Connecting Rod 54017 with 50069c
50069c	8904	“ “ “ “ Ball Screw Stud
1516E	8904	“ “ “ “ “ Nut.....

NO.	PLATE	NAME
64268	8904	Crank Connecting Rod Ball Screw Stud Washer.....
*57222	—	Crank Connecting Rod Cap (lower).....
896E	8904	" " " " " Screw.....
*54018	—	" " " " " (upper).....
1057E	8904	" " " " " Screw.....
54897	8904	" " " " Oil Cup.....
54218	8904	" " " " Pad (braided cotton).....
6575	8904	Crank Connecting Rod Oil Pad Stop Pin.....
68231	9913	Edge Folder (upper) Holder.....
68232	9913	" " " " Arm.....
129D	9910	" " " " " Screw.....
176D	8958	" " " " " Screw.....
68035	9914	Face Plate.....
1094D	9910	" " " " Screw.....
286D	8904	" " " " Thumb Screw.....
54019	8902	Feed Bar with 50429c and two 453c.....
54020	8902	" " " " Connection.....
57225	8904	" " " " Hinge Pin.....
453c	8901	" " " " " Set Screw.....
54111	8902	" " " " " Connecting Rod with 1057E, 54112 and two 896E.....
54113	—	Feed Connecting Rod 54111 with 54025.....
*54112	—	" " " " " Cap.....
896E	8904	" " " " " " Screw.....
1057E	8904	" " " " " Clamping Screw.....
54023	9882	" " " " " Hinge Pin.....
21506	8904	" " " " " " Collar with 457c.....
457c	8904	Feed Connecting Rod Hinge Pin Collar Set Screw.....
68262	9906	Feed Dog, 15 teeth (16 teeth to the inch) for 68266.....
157D	8904	Feed Dog Screw.....
50429c	8904	" " " " " Stop Screw.....
*54024	—	" " " " " Eccentric.....
*23729	—	" " " " " Body.....
51061c	8958	" " " " " Set Screw.....
7071	8904	" " " " " Clamping Washer.....
217D	8904	" " " " " " Screw.....
54025	8985	Feed Eccentric (adjustable) complete, Nos. 217b, 1103c, 7071, 23729, 54024 and two 51061c.....
1103c	8904	Feed Regulating Screw.....
54026	9913	" " " " " Rocking Frame with 453c.....

NO.	PLATE	NAME
54077	—	Feed Rocking Frame 54026 with 21506, 54019, 54020, 54023 and 57225.....
57234	9882	Feed Rocking Frame Hinge Pin.....
57235	8985	" " " " " " Bushing.....
453c	8901	" " " " " " " " Set Screw.....
453c	8901	Feed Rocking Frame Hinge Pin Set Screw.....
54106	9883	Looper (back) closed eye.....
NOTE: When ordering No. 54106 state gauge of machine for which required.		
1147c	9883	Looper (back) Set Screw.....
54107	9883	" (front) closed eye.....
NOTE: When ordering No. 54107, state gauge of machine for which required.		
1120c	9883	Looper (front) Set Screw.....
54027	9883	" " " " " Carrier with two 171D.....
171D	8958	" " " " " Adjusting Screw.....
54227	9883	" " " " " Connection.....
54228	9883	" " " " " Shaft.....
54229	9883	" " " " " " Bushing.....
446c	8901	" " " " " " " " Set Screw.....
49013	8904	Looper Carrier Connection Shaft Oil Pad (braided cotton).....
54230	9883	Looper Carrier Driver with 54032 and four 175E.....
*54032	—	Looper Carrier Driver Cap.....
175E	8958	" " " " " " " " Screw.....
*54368	9909	" " " " " " " " Driving Shaft and Feed Lifting Eccentric with 227D and two 64315....
NOTE: When No. 54368 is required for repairs the Arm Rotary Shaft must be returned to the factory to be adjusted to the new part.		
54383	—	Looper Driving Shaft and Feed Lifting Eccentric 54368 with 54027, 54227, 54228 and 54230.....
*54034	—	Looper Driving Shaft and Feed Lifting Eccentric Bracket with 761E.....
54080	9908	Looper Driving Shaft and Feed Lifting Eccentric Bracket Bushing.....
761E	8901	Looper Driving Shaft and Feed Lifting Eccentric Bracket Bushing Set Screw..
948D	8958	Looper Driving Shaft and Feed Lifting Eccentric Bracket Screw.....

NO.	PLATE	NAME
64315	9909	Looper Driving Shaft and Feed Lifting Eccentric Oil Hole Plug.....
227D	8958	Looper Driving Shaft and Feed Lifting Eccentric Oil Hole Screw.....
40326	9910	Looper Driving Shaft and Feed Lifting Eccentric Oil Pad (braided cotton)....
640D	8958	Looper Driving Shaft and Feed Lifting Eccentric Screw.....
54061	9883	Looper Holder with 1120c and 1147c....
704W	8958	" " Screw.....
64319	9884	Needle Bar (hollow).....
54062	—	Needle Bar complete, for $\frac{3}{32}$ in. to $\frac{1}{4}$ in. gauges, Nos. 54064, 54065 and 64319..
54063	—	Needle Bar complete, for $\frac{3}{32}$ in. to $\frac{3}{8}$ in. gauges, Nos. 54064, 54066 and 64319..
38456	9882	Needle Bar Bushing (lower).....
1133E	8958	" " " " Set Screw...
64320	9882	" " " (upper).....
1133E	8958	" " " " Set Screw...
54326	9882	" " Connecting Link.....
54329	—	" " " " 54326 with 54327 and 54328.....
54327	9882	Needle Bar Connecting Link Hinge Stud
1520J	9910	" " " " " "
		Nut.....
54328	9882	Needle Bar Connecting Stud with 211F and two 187E.....
187E	8958	Needle Bar Connecting Stud Clamping Screw.....
54064	9884	Needle Clamp with two 1498F.....
54065	9884	" " Thread Guard, for $\frac{3}{32}$ in. to $\frac{1}{4}$ in. gauges, for 54062.....
54066	9884	Needle Clamp Thread Guard, for $\frac{3}{32}$ in. to $\frac{3}{8}$ in. gauges, for 54063.....
54067	9884	Needle Guard, for $\frac{3}{32}$ in. to $\frac{5}{32}$ in. gauges.
54068	9884	" " " $\frac{3}{16}$ in. to $\frac{9}{32}$ in. gauges.
54069	9884	" " " $\frac{5}{16}$ in. to $\frac{3}{8}$ in. gauges.
54038	9884	" " Holder.....
176D	8958	" " " Screw.....
217F	8904	" " " Screw.....
1498F	8958	" " Set Screw.....
54108	—	Oil Tube.....
54109	—	" " Bracket.....
49092	9910	" " Packing (felt).....
54110	9910	Oil Tube complete, for oiling Crank Connecting Rod (upper bearing), Nos. 49092, 54108 and 54109.....

NO.	PLATE	NAME
64330	9914	Presser Bar with 25303.....
25303	9908	" " Ball, size $\frac{1}{4}$ in.....
64331	9882	" " Bushing (lower).....
1133E	8958	" " " " Set Screw...
38456	9882	" " " (upper).....
1133E	8958	" " " " Set Screw...
54039	8985	" " Guide Bracket with 453c, 640w and 1963.....
640W	8958	Presser Bar Guide Bracket Adjusting Screw.....
11173	8985	Presser Bar Guide Bracket Guide.....
447C	8958	" " " " " Set Screw
1963	8985	" " " " Roller and Stud
453C	8901	" " " " " Set Screw.....
57257	9882	" " Lifter.....
57258	9882	" " " Hinge Pin.....
447C	8958	" " " " " Set Screw...
1872	8985	" " " Roller and Stud.....
1250C	9884	" " " Stop Screw.....
61047	9884	" " Lifting Bracket with 460c and 1872.....
68037	9914	Presser Bar Lifting Lever.....
61075	9884	" " " " Connecting Stud
460C	9908	" " " " " "
		Set Screw.....
68038	9914	Presser Bar Lifting Lever Extension.....
161D	8958	" " " " " Screw
802D	8958	" " " " Hinge Screw....
54040	9914	" " Spring (flat).....
38468	9910	" " " Stud.....
26276	9906	" Foot Hinge Pin.....
68263	—	" " Plate.....
68040	—	" " Shank with 442c and 1695J.
442C	9906	" " " Adjusting Screw.....
1695J	9906	" " " " " Nut
68264	9906	Presser Foot (hinged) complete, for $\frac{1}{4}$ in. to $\frac{3}{8}$ in. gauges, Nos. 26276, 68040 and 68263.....
190D	8958	Presser Foot Screw.....
574W	8958	Pressure Regulating Thumb Screw.....
1539W	9910	" " " " " Lock Nut.....
68042	9908	Ruffling Blade, for narrow edge margin..
68265	9908	" " " wide edge margin....
68043	9907	" " Driving Shaft.....
68233	9913	" " " " and Edge Folder (upper) Holder Arm Bracket...

NO.	PLATE	NAME
50326	9885	Tension (under thread) Screw Stud.....
59539	—	“ “ “ “ “ 50326c with 51570c.....
59534	9885	Tension (under thread) Spring.....
59537	9885	“ “ “ “ Bushing (large).....
59538	9885	Tension (under thread) Spring Bushing (small).....
17547	9885	Tension (under thread) Thread Guide...
54070	8996	“ (upper thread) Bracket.....
376D	8958	“ “ “ “ Screw...
2102	9885	“ “ “ Disc.....
51570	9885	“ “ “ Regulating Thumb Nut.....
32572	9885	Tension (upper thread) Releasing Disc...
54988	9885	“ “ “ “ Pin....
54071	9909	“ “ “ “ Shaft
54047	9908	“ “ “ “ “ Crank with 624c.....
54048	9909	Tension (upper thread) Releasing Shaft Crank Link.....
624c	8958	Tension (upper thread) Releasing Shaft Crank Set Screw.....
68261	9909	Tension (upper thread) Releasing Shaft Spring.....
316F	8958	Tension (upper thread) Releasing Shaft Stop Screw.....
1547J	9885	Tension (upper thread) Releasing Shaft Stop Screw Nut.....
50326c	9885	Tension (upper thread) Screw Stud.....
59539	—	“ “ “ “ “ 50326c with 51570c.....
59535	9885	Tension (upper thread) Spring.....
59537	9885	“ “ “ “ Bushing (large).....
59538	9885	Tension (upper thread) Spring Bushing (small).....
57076	9885	Tension (upper thread) Thread Guide (double).....
68078	9909	Thread (under) Eyelet (back).....
190D	8958	“ “ “ “ Screw....
54072	9909	“ “ “ (front).....
64351	9909	“ “ Nipper Cam with 465c..
465c	8958	“ “ “ “ Set Screw...
38210	9885	“ “ “ Spring (lower)..
38211	9885	“ “ “ “ (upper)

NO.	PLATE	NAME
46247	9885	Thread (under) Nipper Spring (upper) Stop.....
176D	8958	Thread (under) Nipper Spring Screw....
38475	9909	“ “ Take-up with 465c.....
465c	8958	“ “ “ Set Screw.....
54435	9909	“ “ “ Staple with 590b and 38481.....
54049	9914	Thread (under) Take-up Staple Bracket with 460c.....
965D	9910	Thread (under) Take-up Staple Bracket Screw.....
46041	9885	Thread (under) Take-up Staple Spring
190D	8958	“ “ “ “ “ Screw.....
38481	9909	Thread (under) Take-up Staple Thread Guard.....
590D	8958	Thread (under) Take-up Staple Thread Guard Screw.....
38482	9885	Thread (under) Take-up Stripper.....
207D	9908	“ “ “ “ Screw..
64355	9908	“ “ “ Thread Guard (brass).....
64356	9908	Thread (under) Take-up Thread Guard Steady Pin.....
460c	9908	Thread (under) Take-up Thread Guard Steady Pin Set Screw.....
54330	9908	Thread (upper) Controller.....
207D	9908	“ “ “ Screw.....
46009	9909	“ “ Eyelet.....
190D	8958	“ “ “ Screw.....
54094	9910	“ “ Take-up.....
54095	9910	“ “ “ Plate.....
68164	9910	“ “ “ “ Spring
1449D	9910	“ “ “ “ “ Screw.....
54096	—	Thread (upper) Take-up complete, Nos. 1449D, 54094, 54095 and 68164.....
211F	8958	Thread (upper) Take-up Set Screw.....
68266	9906	Throat Plate, for 1/4 in. to 3/8 in. gauges, for 68262.....
742F	9884	Throat Plate Screw.....

ACCESSORIES

NO.	PLATE	NAME
120643	9913	Hand Ruffling Blade.....
120344	8941	Oiler (copper plated) with 120345.....

NO.	PLATE	NAME
120345	8941	Oiler Spout, 5 in. long.....
26026	8941	Screw Driver (large).....
26485	8941	“ “ (small).....
38487	8941	Threading Wire.....
120341	8941	Tweezers (curved).....
8908	8941	Wrench for 1520.....
19221	8941	“ “ 1516.....
4822	8941	“ “ 1547.....

BELT GUARD

NO.	PLATE	NAME
68222	9879	Belt Guard with two wood screws 1 in. No. 12.....

BENCH STAND

NO.	PLATE	NAME
79611	-----	Bench Stand with 5604, 9370, two 41538, three wood screws 1¼ in. No. 14, four 60656 and sixteen wood screws ⅝ in. No. 7.....
41538	-----	Flush Bolt with Plate complete, Nos. 126247, 126248 and four brass wood screws ⅝ in. No. 4.....
126247	8952	Flush Bolt.....
126248	8952	“ “ Plate.....
60656	8952	Hinge.....
9370	8952	Slide Spring.....
5604	8952	“ “ Pin.....

EDGE FOLDERS AND STRIP GUIDES

NO.	PLATE	NAME
120541	9911	Edge Folder (lower, left hand) on Shank.
1423w	9910	“ “ “ Screw.....
120542	9911	“ “ (upper, right hand) on Bracket with 120546 and two 1161w.....
120546	9911	Edge Folder (upper) Separating Blade
1161w	9908	“ “ “ “ “ “ Screw.....
190d	8958	Edge Folder (upper) Screw.....
120649	9911	Ruffling Blade for 120655.....
120651	9911	Separating Blade for 120656.....
665d	9910	“ “ “ Screw.....
120652	9912	Strip Guide on Rod for 120654.....
120653	9912	“ “ Base with two 791c.....

NO.	PLATE	NAME
791c	9908	Strip Guide Set Screw.....
120654	-----	Strip Guide complete, to fasten to table, for baby ruffles, Nos. 120652, 120653 and three wood screws ¾ in. No. 6....
120655	9911	Strip Guide on Shank (quick threading) for 120656.....
120656	9911	Strip Guide complete, to fasten to machine, for 120654, Nos. 120651, 120655 and two 665d.....
190d	8958	Strip Guide Screw for 120656.....
120771	9911	Edge Folder on Shank for 120774.....
1443w	9910	“ “ Screw.....
120772	9911	Separating Blade for 120774.....
665d	9910	“ “ Screw.....
120773	9911	Strip Guide on Bracket for 120774.....
120774	9911	Edge Folder with Strip Guide complete, for flouncing and attaching baby ruffles in one operation, Nos. 120771 to 120773 and two each 665d and 1443w.....
190d	8958	Edge Folder and Strip Guide Screw.....

FOOT LIFTER PARTS

NO.	PLATE	NAME
6439	-----	Chain, 36 in. to 45 in., with 56864 and 56865.....

NOTE: When ordering No. 6439, state length required.

4879	8941	Chain Connecting Link.....
56864	8941	“ Hook (large).....
56865	8985	“ “ (small).....
126249	8980	Treadle.....
4882	8941	“ Shaft.....
126250	8911	“ Spring.....
126251	8980	“ Stand.....
126252	8980	Treadle complete, Nos. 4882, 126249 to 126251 and two wood screws 1 in. No. 16

KNEE LIFTER PARTS

NO.	PLATE	NAME
37563	-----	Chain, length 15 in., with 56864 and 56865
56864	8941	Chain Hook (large).....
56865	8985	“ “ (small).....
2763	8980	Rock Shaft.....
12242	8980	“ “ Hanger with two wood screws 1 in. No. 10.....

KNEE LIFTER PARTS

NO.	PLATE	NAME
6335	8980	Rock Shaft Knee Arm.....
6336	---	Rock Shaft Knee Arm complete, Nos. 2766, 2767 and 6335.....
2766	8980	Rock Shaft Knee Arm Hub with 356c....
356c	8985	" " " " " Set Screw....
2767	8980	" " " " Plate with 356c.....
356c	8985	" " " " " Set Screw.....
6337	8980	" " Lifting Bracket with two 356c
7125	8980	" " " " " Hook.....
356c	8985	" " " " " S e t Screw.....
356c	8985	Rock Shaft Lifting Bracket Set Screw...
2770	8980	" " Stop Dog with 356c.....
356c	8985	" " " " " Set Screw.....
23767	8980	Rock Shaft complete, Nos. 2763, 2770, 6336, 6337, 7125 and two 12242.....

MACHINE BASE

NO.	PLATE	NAME
68223	9879	Machine Base.....
51072E	9910	" " Bolt with 51581E.....
51581E	9910	" " " Nut.....
6055	9910	" " " " Washer.....
49123	8996	" " Oil Pipe.....
60884	8985	" " " Plug.....
57285	8996	" Cushion (felt).....
948E	8958	" Screw, to fasten machine to base
68224	---	Machine Base complete, Nos. 49123, 60884, 68223, three each 6055, 51072E and four each 948E and 57285.....

THREAD UNWINDER

FOR FOUR SPOOLS

NO.	PLATE	NAME
225395	8953	Spool Rest (for two spools) with 201018c
225388	8953	" " Rod.....
200383c	8985	" " " Set Screw.....
201018c	8985	" " " Set Screw.....
202490	8953	" Stand with 200383c.....
225391	8953	Thread Guide.....
201696J	9910	" " Lock Nut.....
225392	8953	" " Rod with 208E and 225393
208E	8985	" " " Screw.....
225393	9910	" " " Washer.....

THREAD UNWINDER

NO.	PLATE	NAME
225398	8953	Thread Unwinder complete, Nos. 201696J, 202490, 225388, 225392, two 225395, four 225391 and three wood screws $\frac{3}{8}$ in. No. 12.....
27739	8996	Thread Cone (wood) for large cones.....
225390	8996	" " Holder, for inverted cones..

NOTE: Nos. 27739 and 225390 are used with,
but not included in 225398

OBSOLETE PARTS

NO.	PLATE	NAME
54356	8980	Belt Guard with 1192c.....
27347	8985	" " Hinge Pin.....
1192c	8985	" " " " Set Screw.....
1192c	8985	" " " " Set Screw.....
68036	9906	Feed Dog, 14 teeth (16 teeth to the inch) for 68056.....
54357	8980	Machine Base with 1192c.....
54358	---	Machine Base with Belt Guard complete, Nos. 27347, 49123, 54356, 54357, 60884, three each 6055, 51072E and four each 948E and 57285.....
68039	---	Presser Foot Plate for 68041.....
68041	9906	Presser Foot (hinged) complete, Nos. 26276, 68039 and 68040.....
68044	9913	Ruffling Blade Driving Shaft Bracket....
54990	9908	Tension (upper thread) Releasing Shaft Spring, use 68261.....
68056	9906	Throat Plate for $\frac{1}{4}$ in. and $\frac{3}{8}$ in. gauges, for 68036.....

Genuine Singer Needles and their Con-
tainers are marked with the Company's
Trade Mark "SIMANCO." 1

Needles in Containers marked
"For Singer Machines"
are not Singer made needles. 2

NUMERICAL LIST OF PARTS
FOR
MACHINE No. 147-36

NUMERICAL LIST OF PARTS

NO. PLATE	NAME
41F 9910	Ruffling Blade Regulator Pitman Hinge Screw for 68076.....
129D 9910	Edge Folder (upper) Holder Arm Screw..
129D 9910	Ruffling Blade Regulator Bracket Screw for 68028.....
144D 8901	Arm Rotary Shaft Screw.....
157D 8904	Feed Dog Screw.....
159F 8901	Arm Rotary Shaft Flanged Bushing Screw
161D 8958	Presser Bar Lifting Lever Extension Screw
171D 8958	Looper Carrier Adjusting Screw for 54027
175E 8958	" " Driver Cap Screw for 54230.....
175E 8958	Slack Thread Regulator Holder Clamping Screw for 54042.....
176D 8958	Edge Folder (upper) Holder Screw.....
176D 8958	Needle Guard Holder Screw.....
176D 8958	Thread (under) Nipper Spring Screw....
187E 8958	Needle Bar Connecting Stud Clamping Screw for 54328.....
190D 8958	Presser Foot Screw.....
190D 8958	Slack Thread Controller Clamp Screw...
190D 8958	Thread (under) Eye'et (back) Screw.....
190D 8958	" " Take-up Staple Spring Screw.....
190D 8958	Thread (upper) Eyelet Screw.....
190D 8958	Edge Folder (upper) Screw.....
190D 8958	Strip Guide Screw for 120656.....
190D 8958	Edge Folder and Strip Guide Screw.....
207D 9908	Thread (under) Take-up Stripper Screw..
207D 9908	" (upper) Controller Screw.....
208E 8985	" Unwinder Thread Guide Rod Screw for 225392.....
211F 8958	Thread (upper) Take-up Set Screw for 54328.....
217D 8904	Feed Eccentric Clamping Washer Screw for 54025.....
217F 8904	Needle Guard Screw.....
226D 9908	Ruffling Blade Holder Cap Screw for 68071
227D 8958	Looper Driving Shaft and Feed Lifting Eccentric Oil Hole Screw for 54368....
286D 8904	Arm Side Cover (back) Thumb Screw...
286D 8904	" " " (front) Thumb Screw...
286D 8904	Face Plate Thumb Screw.....

NO.	PLATE	NAME
316f	8958	Tension (upper thread) Releasing Shaft Stop Screw.....
356c	8985	Rock Shaft Knee Arm Hub Set Screw for 2766.....
356c	8985	Rock Shaft Knee Plate Set Screw for 2767
356c	8985	" " Lifting Bracket Hook Set Screw for 6337.....
356c	8985	Rock Shaft Lifting Bracket Set Screw for 6337.....
356c	8985	Rock Shaft Stop Dog Set Screw for 2770.
376d	8958	Tension (upper thread) Bracket Screw...
422c	8901	Arm Rotary Shaft Bushing (intermediate) Set Screw (long).....
423c	8901	Arm Rock Shaft Bushing (intermediate) Set Screw.....
430c	8904	Balance Wheel Set Screw for 64259.....
442c	9906	Presser Foot Shank Adjusting Screw for 68040.....
446c	8901	Arm Rock Shaft Bushing (back) Set Screw
446c	8901	Looper Carrier Connection Shaft Bushing Set Screw.....
447c	8958	Presser Bar Guide Bracket Guide Set Screw.....
447c	8958	Presser Bar Lifter Hinge Pin Set Screw..
453c	8901	Arm Rock Shaft Collar Set Screw for 54004.....
453c	8901	Arm Rock Shaft Crank (front) Set Screw for 64255.....
453c	8901	Arm Rock Shaft Flanged Bushing (front) Set Screw.....
453c	8901	Feed Bar Hinge Pin Set Screw for 54019.
453c	8901	" Rocking Frame Hinge Pin Bushing Set Screw.....
453c	8901	Feed Rocking Frame Hinge Pin Set Screw for 54026.....
453c	8901	Presser Bar Guide Bracket Set Screw for 54039.....
457c	8904	Feed Connecting Rod Hinge Pin Collar Set Screw for 21506.....
460c	9908	Presser Bar Lifting Lever Connecting Stud Set Screw for 61047.....
460c	9908	Thread (under) Take-up Thread Guard Steady Pin Set Screw for 54049.....
465c	8958	Ruffling Blade Rock Shaft Collar Set Screw for 54369.....
465c	8958	Thread (under) Nipper Cam Set Screw for 64351.....

NO.	PLATE	NAME
465c	8958	Thread (under) Take-up Set Screw for 38475.....
574w	8958	Pressure Regulating Thumb Screw.....
590d	8958	Thread (under) Take-up Staple Thread Guard Screw for 54435.....
624c	8958	Tension (upper thread) Releasing Shaft Crank Set Screw for 54047.....
640d	8958	Looper Driving Shaft and Feed Lifting Eccentric Screw for 68060.....
640w	8958	Presser Bar Guide Bracket Adjusting Screw for 54039.....
665d	9910	Ruffling Blade Screw.....
665d	9910	Separating Blade Screw for 120656 and 120774.....
704w	8958	Looper Holder Screw.....
725j	8904	Cloth Plate Slide (front) Spring Screw for 68032.....
725j	8904	Cloth Plate Slide (left) Spring Screw for 54013.....
725j	8904	Cloth Plate Slide (right) Spring Screw for 54058.....
742f	9884	Throat Plate Screw.....
761e	8901	Arm Rotary Shaft Bushing (front) Set Screw.....
761e	8901	Looper Driving Shaft and Feed Lifting Eccentric Bracket Bushing Set Screw for 54034.....
791c	9908	Strip Guide Set Screw for 120653.....
802d	8958	Presser Bar Lifting Lever Hinge Screw...
896e	8904	Crank Connecting Rod Cap (lower) Screw for 54017.....
896e	8904	Feed Connecting Rod Cap Screw for 54111
896e	8904	Ruffling Blade Eccentric Connecting Rod Cap Screw for 54111.....
948d	8958	Looper Driving Shaft and Feed Lifting Eccentric Bracket Screw for 68028.....
948d	8958	Machine Screw, to fasten machine to base, for 54358 and 68224.....
965d	9910	Thread (under) Take-up Staple Bracket Screw.....
1011f	8904	Cloth Plate Screw (left).....
1019c	8958	Slack Thread Regulator Holder Shaft Collar Set Screw for 24292.....
1036c	8958	Ruffling Blade Eccentric Set Screw for 68047.....
1057d	8904	Ruffling Blade Rock Shaft Crank (front) Clamping Screw for 68055.....

NO.	PLATE	NAME
1057E	8904	Crank Connecting Rod Cap (upper) Screw for 54017.....
1057E	8904	Feed Connecting Rod Clamping Screw for 54111.....
1057E	8904	Ruffling Blade Eccentric Connecting Rod Clamping Screw for 54111.....
1094b	9910	Face Plate Screw.....
1103c	8904	Feed Regulating Screw for 54025.....
1120c	9883	Looper (front) Set Screw for 54061.....
1133E	8958	Needle Bar Bushing (lower) Set Screw....
1133E	8958	“ “ “ (upper) Set Screw....
1133E	8958	Presser Bar Bushing (lower) Set Screw....
1133E	8958	“ “ “ (upper) Set Screw....
1147c	9883	Looper (back) Set Screw for 54061.....
1161w	9908	Edge Folder (upper) Separating Blade Screw for 120542.....
1192c	8985	Belt Guard Hinge Pin Set Screw for 54357, obsolete.....
1192c	8985	Belt Guard Set Screw for 54356, obsolete
1235F	8904	Cloth Plate Thread Guard Screw.....
1250c	9884	Presser Bar Lifter Stop Screw.....
1253c	8958	Slack Thread Regulator Holder Shaft Set Screw for 54044.....
1259c	8958	Arm Rotary Shaft Collar Set Screw for 54008.....
1259c	8958	Ruffling Blade Regulator Crank Set Screw for 68052.....
1343b	9910	Ruffling Blade Driving Shaft and Edge Folder (upper) Holder Arm Bracket Screw.....
1423w	9910	Edge Folder (lower) Screw.....
1443w	9910	“ “ Screw for 120774.....
1449b	9910	Thread (upper) Take-up Plate Spring Screw for 54096.....
1492E	9910	Ruffling Blade Driving Shaft Connecting Stud Clamping Screw for 68045.....
1498F	8958	Needle Set Screw for 54064.....
1516E	8904	Crank Connecting Rod Ball Screw Stud Nut.....
1520j	9910	Needle Bar Connecting Link Hinge Stud Nut.....
1520j	9910	Ruffling Blade Regulator Pitman Hinge Screw Nut for 68076.....
1539w	9910	Pressure Regulating Thumb Screw Lock Nut.....
1547j	9885	Tension (upper thread) Releasing Shaft Stop Screw Nut.....

NO.	PLATE	NAME
1695j	9906	Presser Foot Shank Adjusting Screw Nut for 68040.....
1735R	9908	Ruffling Blade Holder Hinge Stud Nut for 68071.....
1872c	8985	Presser Bar Lifter Roller and Stud for 61047.....
1963	8985	Presser Bar Guide Bracket Roller and Stud for 54039.....
2102	9885	Tension (under thread) Disc.....
2102	9885	“ (upper thread) Disc.....
2117	8901	Arm Rock Shaft Crank (front) Pin.....
2763	8980	Rock Shaft for 23767.....
2766	8980	“ “ Knee Arm Hub with 356c, for 6336.....
2767	8980	Rock Shaft Knee Plate with 356c, for 6336
2770	8980	“ “ Stop Dog with 356c, for 23767
4822	8941	Wrench for 1547 (Accessories).....
4879	8941	Chain Connecting Link.....
4882	8941	Treadle Shaft for 126252.....
5604	8952	Bench Stand Slide Spring Pin for 79611..
6055	9910	Machine Base Bolt Nut Washer for 54358 and 68224.....
6335	8980	Rock Shaft Knee Arm for 6336.....
6336	----	Rock Shaft Knee Arm complete for 23767, Nos. 2766, 2767 and 6335.....
6337	8980	Rock Shaft Lifting Bracket with two 356c for 23767.....
6439	—	Chain, 36 in. to 45 in., with 56864 and 56865.....
NOTE: When ordering No. 6439, state length required.		
6575	8904	Crank Connecting Rod Oil Pad Stop Pin for 54017.....
7071	8904	Feed Eccentric Clamping Washer for 54025.....
7125	8980	Rock Shaft Lifting Bracket Hook for 23767.....
8908	8941	Wrench for 1520 (Accessories).....
9370	8952	Bench Stand Slide Spring for 79611.....
11173	8985	Presser Bar Guide Bracket Guide.....
12242	8980	Rock Shaft Hanger with two wood screws 1 in. No. 10, for 23767.....
14017	9908	Ruffling Blade Regulator Screw Washer for 68076.....
15196	8902	Arm Side Cover (back).....
17547	9885	Tension (under thread) Thread Guide....

NO.	PLATE	NAME
19221	8941	Wrench for 1516 (Accessories).....
21506	8904	Feed Connecting Rod Hinge Pin Collar with 457c, for 54077.....
*23729	—	Feed Eccentric Body for 54025.....
23767	8980	Rock Shaft complete, Nos. 2763, 2770, 6336, 6337, 7125 and two 12242.....
23866	9907	Ruffling Blade Regulator Crank Hinge Stud (eccentric).....
24203	9908	Ruffling Blade Holder for 68071.....
24292	9910	Slack Thread Regulator Holder Shaft Collar with 1019c.....
24581	9908	Ruffling Blade Holder Spring for 68071..
25303	9908	Presser Bar Ball, size ¼ in., for 64330...
26026	8941	Screw Driver (large) Accessories.....
26276	9906	Presser Foot Hinge Pin for 68041 and 68264.....
26485	8941	Screw Driver, small (Accessories).....
27347	8985	Belt Guard Hinge Pin for 54358, obsolete
27739	8996	Thread Unwinder Thread Cone (wood) for large cones, for 225398.....
32572	9885	Tension (upper thread) Releasing Disc...
37563	—	Chain, length 15 in. with 56864 and 56865
38210	9885	Thread (under) Nipper Spring (lower)...
38211	9885	“ “ “ “ (upper)...
38419	8904	Cloth Plate Slide (front) Spring for 68032
38419	8904	“ “ “ (left) “ “ 54013
38419	8904	“ “ “ (right) “ “ 54058
38456	9882	Needle Bar Bushing (lower).....
38456	9882	Presser Bar Bushing (upper).....
38468	9910	“ “ Spring Stud.....
38475	9909	Thread (under) Take-up with 465c.....
38481	9909	“ “ “ Staple Thread Guard for 54435.....
38482	9885	Thread (under) Take-up Stripper.....
38487	8941	Threading Wire (Accessories).....
40247	9907	Ruffling Blade Driving Shaft Connection Hinge Pin for 68074.....
40326	9910	Looper Driving Shaft and Feed Lifting Eccentric Oil Pad (braided cotton)....
41538	—	Bench Stand Flush Bolt with Plate com- plete for 79611, Nos. 126247, 126248 and four brass wood screws ⅝ in. No. 4
42366	8901	Arm Oil Pad (braided cotton) for oiling Arm Rock Shaft Front Bearing.....
46009	9909	Thread (upper) Eyelet.....
46041	9885	“ (under) Take-up Staple Spring...

NO.	PLATE	NAME
46247	9885	Thread (under) Nipper Spring (upper) Stop.....
49013	8904	Arm Rotary Shaft Front Bearing Oil Pad (braided cotton).....
49013	8904	Looper Carrier Connection Shaft Oil Pad (braided cotton).....
49092	9910	Cloth Plate Oil Tube Packing (felt) for 68030.....
49092	9910	Oil Tube Packing (felt) for 54110.....
49123	8996	Machine Base Oil Pipe for 54358 and 68224.....
50069c	8904	Crank Connecting Rod Ball Screw Stud for 54088.....
50083c	8901	Arm Rock Shaft Crank (back) Set Screw for 54005.....
50084c	8901	Arm Rotary Shaft Bushing (intermediate) Set Screw (short).....
50150c	8958	Slack Thread Regulator Set Screw for 54042.....
50200c	8958	Ruffling Blade Rock Shaft Crank (back) Set Screw for 128690.....
50326c	9885	Tension (under thread) Screw Stud for 59539.....
50326c	9885	Tension (upper thread) Screw Stud for 59539.....
50379F	9908	Ruffling Blade Driving Shaft Connection Hinge Pin Set Screw for 68055.....
50429c	8904	Feed Dog Stop Screw for 54019.....
50473F	8904	Cloth Plate Screw (right).....
50950c	9908	Ruffling Blade Regulator Screw Stud for 68076.....
51061c	8958	Feed Eccentric Body Set Screw for 54025
51072E	9910	Machine Base Bolt with 51581E for 54358 and 68224.....
51570c	9885	Tension (under thread) Regulating Thumb Nut for 59539.....
51570c	9885	Tension (upper thread) Regulating Thumb Nut for 59539.....
51581E	9910	Machine Base Bolt Nut for 51072.....
51584c	9908	Ruffling Blade Regulator Screw Stud Nut for 68076.....
52045	8901	Arm Oil Tube Packing (braided cotton) for 56003.....
52045	8901	Arm Rock Shaft Bushing Oil Pad (braided cotton).....
52045	8901	Arm Rock Shaft Flanged Bushing (front) Oil Pad (braided cotton).....

NO.	PLATE	NAME
52809	9908	Ruffling Blade Holder Spring Stop for 68071.....
54002	8902	Arm Rock Shaft for 54079.....
54004	8901	" " " Collar with two 453c, for 54079.....
54005	8901	Arm Rock Shaft Crank (back) with two 50083c, for 54079.....
54007	8902	Arm Rotary Shaft Bushing (intermediate) for 54089.....
54008	8901	Arm Rotary Shaft Collar with three 1259c for 68060.....
54009	8902	Arm Rotary Shaft Flanged Bushing for 54090.....
54010	8904	Arm Side Cover (front).....
54012	8902	Cloth Plate Slide (left) for 54013.....
54013	---	Cloth Plate Slide (left) complete for 68033, Nos. 38419, 54012 and two 725j.....
54017	8902	Crank Connecting Rod with 6575, 54018, 54218, 54897, 57222 and two each 896e and 1057e, for 54088.....
*54018	---	Crank Connecting Rod Cap (upper) for 54017.....
54019	8902	Feed Bar with 50429c and two 453c, for 54077.....
54020	8902	Feed Bar Connection for 54077.....
54023	9882	" Connecting Rod Hinge Pin for 54077.....
*54024	---	" Eccentric for 54025.....
54025	8985	Feed Eccentric (adjustable) complete for 54113, Nos. 217d, 1103c, 7071, 23729, 54024 and two 51061c.....
54026	9913	Feed Rocking Frame with 453c, for 54077.....
54027	9883	Looper Carrier with two 171b, for 54383.....
*54032	---	" " Driver Cap for 54230.....
*54034	---	" Driving Shaft and Feed Lifting Eccentric Bracket with 761e, for 68028.....
54038	9884	Needle Guard Holder.....
54039	8985	Presser Bar Guide Bracket with 453c, 640w and 1963.....
54040	9914	Presser Bar Spring (flat).....
54042	9908	Slack Thread Regulator Holder with 175e and two 50150c.....
54043	9910	Slack Thread Regulator Holder Shaft.....
54044	9908	" " " " " " Crank (forked) with 1253c.....
54047	9908	Tension (upper thread) Releasing Shaft Crank with 624c.....

NO.	PLATE	NAME
54048	9909	Tension (upper thread) Releasing Shaft Crank Link.....
54049	9914	Thread (under) Take-up Staple Bracket with 460c.....
54057	9913	Cloth Plate Slide (right) for 54058.....
54058	---	Cloth Plate Slide (right) complete for 68033, Nos. 38419, 54057 and two 725j.....
54061	9883	Looper Holder with 1120c and 1147c.....
54062	---	Needle Bar complete, for $\frac{3}{8}$ in. to $\frac{1}{4}$ in. gauges, Nos. 54064, 54065 and 64319..
54063	---	Needle Bar complete, for $\frac{3}{8}$ in. to $\frac{3}{8}$ in. gauges, Nos. 54064, 54066 and 64319..
54064	9884	Needle Clamp with two 1498F, for 54062 and 54063.....
54065	9884	Needle Clamp Thread Guard, for $\frac{3}{8}$ in. to $\frac{1}{4}$ in. gauges, for 54062.....
54066	9884	Needle Clamp Thread Guard, for $\frac{3}{8}$ in. to $\frac{3}{8}$ in. gauges, for 54063.....
54067	9884	Needle Guard for $\frac{3}{8}$ in. to $\frac{5}{8}$ in. gauges.....
54068	9884	" " " $\frac{3}{8}$ in. to $\frac{3}{8}$ in. gauges.....
54069	9884	" " " $\frac{5}{16}$ in. to $\frac{3}{8}$ in. gauges.....
54070	8996	Tension (upper thread) Bracket.....
54071	9909	" " " Releasing Shaft.....
54072	9909	Thread (under) Eyelet (front).....
54077	---	Feed Rocking Frame 54026 with 21506, 54019, 54020, 54023 and 57225.....
54079	---	Arm Rock Shaft 54002, with 54004, 54005 and 64255.....
54080	9908	Looper Driving Shaft and Feed Lifting Eccentric Bracket Bushing.....
54088	---	Crank Connecting Rod 54017 with 50069c for 68060.....
54089	---	Arm Rotary Shaft Bushing (intermediate) 54007 with 64508 and 64805.....
54090	---	Arm Rotary Shaft Flanged Bushing 54009 with 58039 and 64805.....
54094	9910	Thread (upper) Take-up for 54096.....
54095	9910	" " " Plate for 54096.....
54096	---	Thread (upper) Take-up complete, Nos. 1449b, 54094, 54095 and 68164.....
54105	8901	Arm Rock Shaft Flanged Bushing (front).....
54106	9883	Looper (back) closed eye.....

NOTE: When ordering No. 54106, state gauge of machine for which required.

NO.	PLATE	NAME
54107	9883	Looper (front) closed eye.....
		NOTE: When ordering No. 54107, state gauge of machine for which required.
54108	---	Oil Tube for 54110.....
54109	---	" " Bracket for 54110.....
54110	9910	Oil Tube complete, for oiling Crank Connecting Rod (upper bearing), Nos. 49092, 54108 and 54109.....
54111	8902	Feed Connecting Rod with 1057E, 54112 and two 896E, for 54113.....
54111	8902	Ruffling Blade Eccentric Connecting Rod with 1057E, 54112 and two 896E, for 68061.....
*54112	---	Feed Connecting Rod Cap for 54111.....
*54112	---	Ruffling Blade Eccentric Connection Rod Cap for 54111.....
54113	---	Feed Connecting Rod 54111 with 54025, for 68060.....
54157	9907	Ruffling Blade Regulator Pitman for 68076
54218	8904	Crank Connecting Rod Oil Pad (braided cotton) for 54017.....
54227	9883	Looper Carrier Connection for 54383.....
54228	9883	" " " Shaft for 54383
54229	9883	" " " Bushing
54230	9883	" " Driver with 54032 and four 175E, for 54383.....
54242	9908	Slack Thread Controller Clamp.....
54326	9882	Needle Bar Connecting Link for 54329..
54327	9882	" " " Hinge Stud for 54329.....
54328	9882	Needle Bar Connecting Stud with 211F and two 187E for 54329.....
54329	---	Needle Bar Connecting Link 54326 with 54327 and 54328.....
54330	9908	Thread (upper) Controller.....
54356	8980	Belt Guard with 1192c, for 54358, obsolete
54357	8980	Machine Base with 1192c for 54358, obsolete.....
54358	---	Machine Base with Belt Guard complete, Nos. 27347, 49123, 54356 54357, 60884, three each 6055, 51072E and four each 948E and 57285, obsolete.....
*54359	---	Arm Rotary Shaft for 68060.....

NOTE: When No. 54359 is required for repairs, the Looper Driving Shaft and Feed Lifting Eccentric must be returned to the factory to be adjusted to the new part.

NO.	PLATE	NAME
54367	8985	Arm Rotary Shaft Bushing (front).....
*54368	9909	Looper Driving Shaft and Feed Lifting Eccentric with 227D and two 64315, for 54383.....
		NOTE: When No. 54368 is required for repairs the Arm Rotary Shaft must be returned to the factory to be adjusted to the new part.
54369	9909	Ruffling Blade Rock Shaft Collar with two 465c.....
54381	9884	Slack Thread Controller.....
54383	---	Looper Driving Shaft and Feed Lifting Eccentric 54368, with 54027, 54227, 54228 and 54230, for 68060.....
54435	9909	Thread (under) Take-up Staple with 590D and 38481.....
54897	8904	Crank Connecting Rod Oil Cup for 54017
54988	9885	Tension (upper thread) Releasing Pin...
54990	9908	" " " " Shaft Spring, obsolete, use 68261.....
56003	8985	Arm Oil Tube with 52045 for oiling 54326
56006	8901	Arm Oil Pad (braided cotton) for oiling Arm Rock Shaft Intermediate Bearing
56006	8901	Arm Rock Shaft Bushing (back) Oil Pad (braided cotton).....
56864	8941	Chain Hook (large) for 6439 and 37563..
56865	8985	" " (small) for 6439 and 37563..
57076	9885	Tension (upper thread) Thread Guide (double).....
*57222	---	Crank Connecting Rod Cap (lower) for 54017.....
57225	8904	Feed Bar Hinge Pin for 54077.....
57234	9882	" Rocking Frame Hinge Pin.....
57235	8985	" " " " " Bushing.
57257	9882	Presser Bar Lifter.....
57258	9882	" " " Hinge Pin.....
57285	8996	Machine Cushion (felt) for 54358 and 68224.....
58039	8902	Arm Rotary Shaft Flanged Bushing Oil Pad, long (braided cotton) for 54090..
59534	9885	Tension (under thread) Spring.....
59535	9885	" (upper thread) Spring.....
59537	9885	" (under thread) Spring Bushing (large).....
59537	9885	Tension (upper thread) Spring Bushing (large).....

NO.	PLATE	NAME
59538	9885	Tension (under thread) Spring Bushing (small).....
59538	9885	Tension (upper thread) Spring Bushing (small).....
59539	---	Tension (under thread) Screw Stud 50326c with 51570c.....
59539	---	Tension (upper thread) Screw Stud 50326c with 51570c.....
60656	8952	Bench Stand Hinge for 79611.....
60884	8985	Machine Base Oil Pipe Plug for 5435S and 68224.....
61017	9884	Presser Bar Lifting Bracket with 460c and 1872.....
61075	9884	Presser Bar Lifting Lever Connecting Stud
64255	9882	Arm Rock Shaft Crank (front) with 453c, for 51079.....
64259	9914	Balance Wheel with two 430c.....
64268	8904	Crank Connecting Rod Ball Screw Stud Washer.....
64345	9909	Looper Driving Shaft and Feed Lifting Eccentric Oil Hole Plug for 54368.....
64319	9884	Needle Bar (hollow) for 54062 and 51063
64320	9882	" " Bushing (upper).....
64330	9914	Presser Bar with 25303.....
64331	9882	" " Bushing (lower).....
64337	9884	Slack Thread Regulator.....
64351	9909	Thread (under) Nipper Cam with 465c, for 68060.....
64355	9908	Thread (under) Take-up Thread Guard (brass) for 68060.....
64356	9908	Thread (under) Take-up Thread Guard Steady Pin.....
64386	8901	Arm Rock Shaft Bushing (back).....
64388	8901	" " " " (intermediate)
64568	8902	" Rotary Shaft Bushing (intermediate) Oil Pad, long (braided cotton) for 54089
64805	8985	Arm Rotary Shaft Bushing (intermediate) Oil Pad, short (braided cotton) for 54089
64805	8985	Arm Rotary Shaft Flanged Bushing Oil Pad, short (braided cotton) for 54990..
*68028	---	Arm, upper and lower (solid) with 948D, 54034, 68051 and three 129D.....
68029	9915	Cloth Plate for 68033.....
68030	9910	" " Oil Tube with 49092, for 68033
68031	9913	" " Slide (front) for 68032.....
68032	---	Cloth Plate Slide (front) complete for 68033, Nos. 38419, 68031 and two 7251

NO.	PLATE	NAME
68033	---	Cloth Plate complete, for $\frac{3}{16}$ in. to $\frac{3}{8}$ in. gauges, Nos. 54013, 54058, 68029, 68030 and 68032.....
68034	9915	Cloth Plate Thread Guard.....
68035	9914	Face Plate.....
68036	9906	Feed Dog, 14 teeth (16 teeth to the inch) for 68056, obsolete.....
68037	9914	Presser Bar Lifting Lever.....
68038	9914	" " " " Extension.....
68039	---	" Foot Plate for 68041, obsolete....
68040	---	" " Shank with 442c and 1695J, for 68041 and 68264.....
68041	9906	Presser Foot (hinged) complete, Nos. 26276, 68039 and 68040, obsolete.....
68042	9908	Ruffling Blade for narrow edge margin...
68043	9907	" " Driving Shaft for 68071...
68044	9913	" " " " Bracket, obsolete.....
68045	9907	Ruffling Blade Driving Shaft Connecting Stud with 1492E, for 68074.....
68046	9907	Ruffling Blade Driving Shaft Connection for 68074.....
68047	9907	Ruffling Blade Eccentric with two 1036c, for 68060.....
68048	9908	Ruffling Blade Holder Hinge Stud for 68071.....
68049	9908	Ruffling Blade Holder Hinge Stud Bracket for 68071.....
68050	9907	Ruffling Blade Regulator.....
68051	9913	" " " Bracket for 68028.....
68052	9907	Ruffling Blade Regulator Crank with two 1259c.....
68053	9913	Ruffling Blade Rock Shaft.....
68055	9907	" " " " Crank (front) with 1057D and 50379E, for 68074.....
68056	9906	Throat Plate, for $\frac{1}{4}$ in. and $\frac{3}{16}$ in. gauges, for 68036, obsolete.....
68060	---	Arm Rotary Shaft 54359 with 640D, 54008, 54088, 54113, 54383, 64351, 64355 and 68047.....
68061	---	Ruffling Blade Eccentric 68047 with 54111
68071	---	" " Holder Hinge Stud Bracket 68049 with 226D, 1735R, 24203, 24581, 52809, 68043 and 68048, for 68075....
68074	---	Ruffling Blade Driving Shaft Connection 68046 with 40247, 68045 and 68055....

NO.	PLATE	NAME
68075	—	Ruffling Blade Driving Shaft and Edge Folder (upper) Holder Arm Bracket 68233 with 68071.....
68076	—	Ruffling Blade Regulator Pitman 54157 with 41F, 1520, 14017, 50950c and 51584c.....
68078	9909	Thread (under) Eyelet (back).....
68164	9910	" (upper) Take-up Plate Spring for 54096.....
68222	9879	Belt Guard with two wood screws 1 in. No. 12.....
68223	9879	Machine Base for 68224.....
68224	—	Machine Base complete, Nos. 49123, 60884, 68223, three each 6055, 51072E and four each 948E and 57285.....
68231	9913	Edge Folder (upper) Holder.....
68232	9913	" " " " Arm.....
68233	9913	Ruffling Blade Driving Shaft and Edge Folder (upper) Holder Arm Bracket for 68075.....
68261	9909	Tension (upper thread) Releasing Shaft Spring.....
68262	9906	Feed Dog, 15 teeth (16 teeth to the inch) for 68266.....
68263	—	Presser Foot Plate for 68264.....
68264	9906	Presser Foot (hinged) complete, for 1/4 in. to 3/8 in. gauges, Nos. 26276, 68010 and 68263.....
68265	9908	Ruffling Blade for wide edge margin.....
68266	9906	Throat Plate, for 1/4 in. to 3/8 in. gauges, for 68262.....
79611	—	Bench Stand with 5604, 9370, two 41538, three wood screws 1 1/4 in. No. 14, four 60656 and sixteen wood screws 5/8 in. No. 7.....
120341	8941	Tweezers, curved (Accessories).....
120344	8941	Oiler (copper plated) with 120345 (Accessories).....
120345	8941	Oiler Spout, 5 in. long, for 120344.....
120541	9911	Edge Folder (lower, left hand) on Shank.
120542	9911	" " (upper, right hand) on Bracket with 120546 and two 1161w.....
120546	9911	Edge Folder (upper) Separating Blade for 120542.....
120643	9913	Hand Ruffling Blade (Accessories).....
120649	9911	Ruffling Blade for 120655.....
120651	9911	Separating Blade for 120656.....

NO.	PLATE	NAME
120652	9912	Strip Guide on Rod for 120654.....
120653	9912	" " Base with two 791c for 120653
120654	—	Strip Guide complete, to fasten to table, for baby ruffles, Nos. 120652, 120653 and three wood screws 3/4 in. No. 6....
120655	9911	Strip Guide on Shank (quick threading) for 120656.....
120656	9911	Strip Guide complete, to fasten to machine for 120654, Nos. 120651, 120655 and two 665D.....
120771	9911	Edge Folder on Shank for 120774.....
120772	9911	Separating Blade for 120774.....
120773	9911	Strip Guide on Bracket for 120774.....
120774	9911	Edge Folder with Strip Guide complete, for flouncing and attaching baby ruffles in one operation, Nos. 120771 to 120773 and two each 665D and 1443W.....
126247	8952	Bench Stand Flush Bolt for 41538.....
126248	8952	" " " " Plate for 41538.
126249	8980	Treadle for 126252.....
126250	8941	" Spring for 126252.....
126251	8980	" Stand for 126252.....
126252	8980	Treadle complete, Nos. 4882, 126249 to 126251 and two wood screws 1 in. No. 16
128690	9907	Ruffling Blade Rock Shaft Crank (back) with two 50200c.....
200383C	8985	Thread Unwinder Spool Rest Rod Set Screw for 202490.....
201018C	8985	Thread Unwinder Spool Rest Set Screw for 225395.....
201696J	9910	Thread Unwinder Thread Guide Lock Nut for 225398.....
202490	8953	Thread Unwinder Spool Stand with 200383C for 225398.....
225388	8953	Thread Unwinder Spool Rest Rod for 225398.....
225390	8996	Thread Unwinder Thread Cone Holder for inverted cones, for 225398.....
NOTE: Nos. 22739 and 225390 are used with, but not included in 225398		
225391	8953	Thread Unwinder Thread Guide for 225398
225392	8953	" " " " Rod with 208E and 225393, for 225398.....
225393	9910	Thread Unwinder Thread Guide Rod Washer for 225392.....

NUMERICAL LIST OF PARTS

NO.	PLATE	NAME
225395	8953	Thread Unwinder Spool Rest (for two spools) with 201018c, for 225398.
225398	8953	Thread Unwinder complete for four spools, Nos. 2016961, 202490, 225388, 225392, two 225395, four 225391 and three wood screws $\frac{7}{8}$ in. No. 12.

Genuine Singer Needles and their Containers are marked with the Company's Trade Mark "SIMANCO." 1

Needles in Containers marked "For Singer Machines" are not Singer made needles. 2

**ILLUSTRATIONS OF PARTS
FOR
MACHINE No. 147-36**

PLATE 8901—FULL SIZE

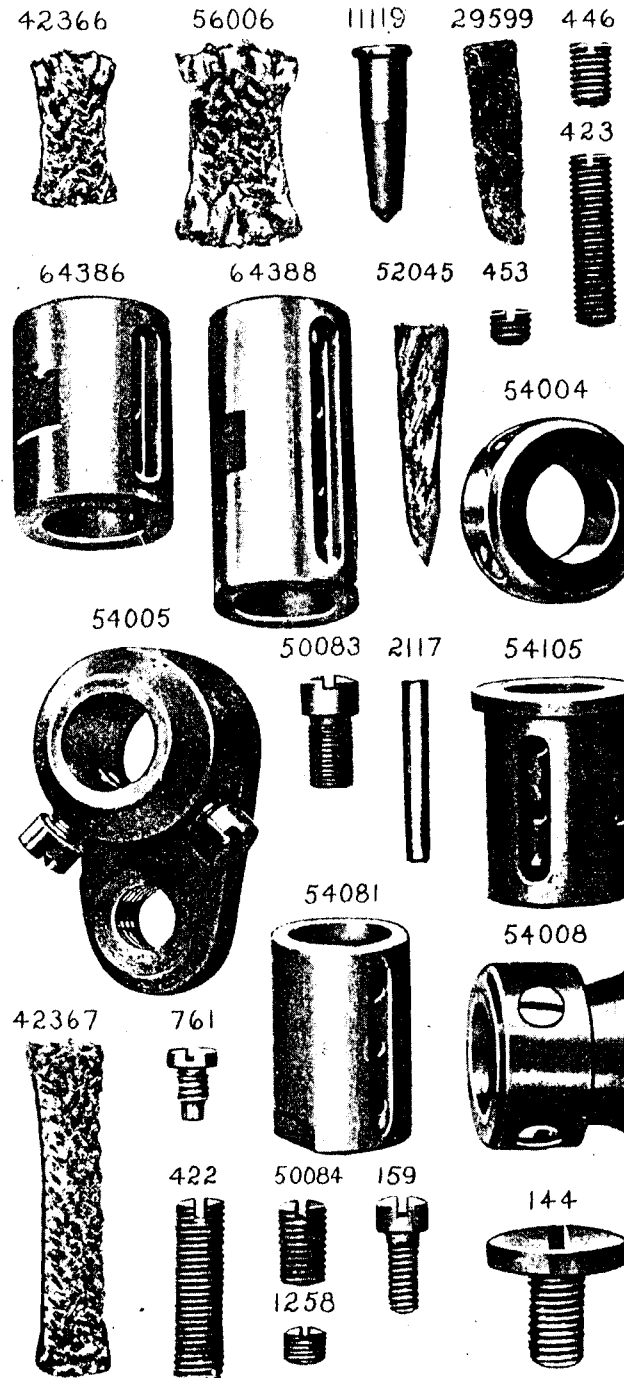
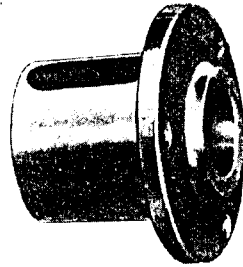
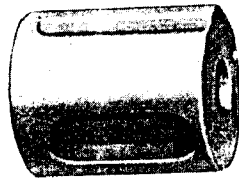

PLATE 8902—ONE-HALF SIZE

54002

54007

54009



54017 64-508 58039

15196

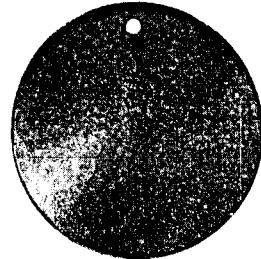
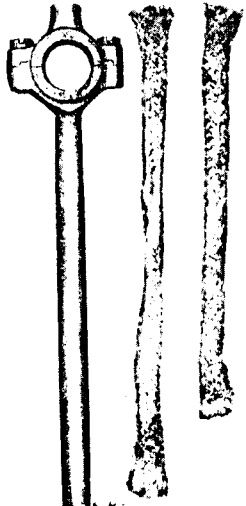

54012

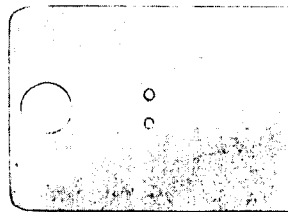

54019

54111

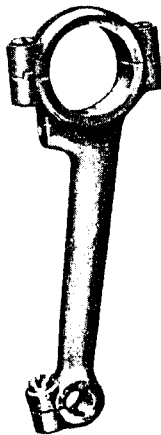

54020

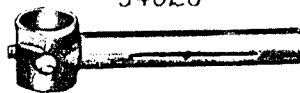

PLATE 8904—FULL SIZE

49013

286

54010

430



50473

1011



38419

725

1235



50069

1516

64268

896

1057



54897

57225

21506

457

54218

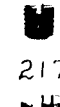

6575

443

7071



50429

61171

1103



157

21332



934



PLATE 8941—ONE-HALF SIZE

19221 8908 120344 26485 38487

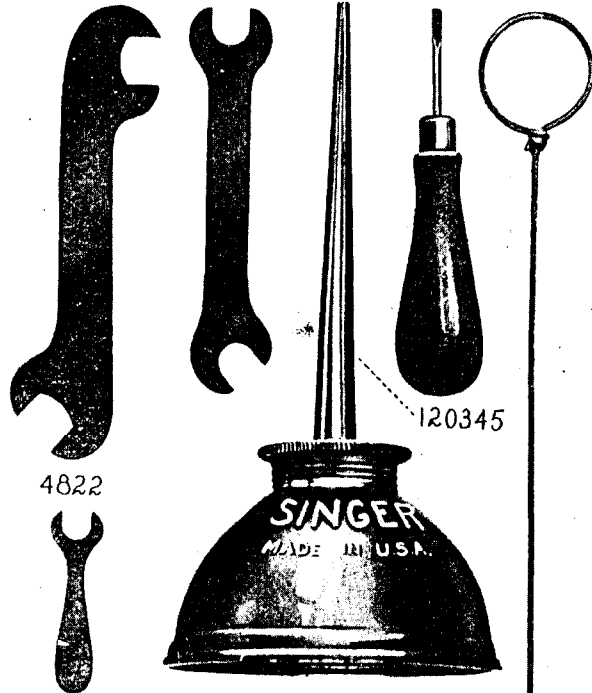

26026 120341 4879 56864

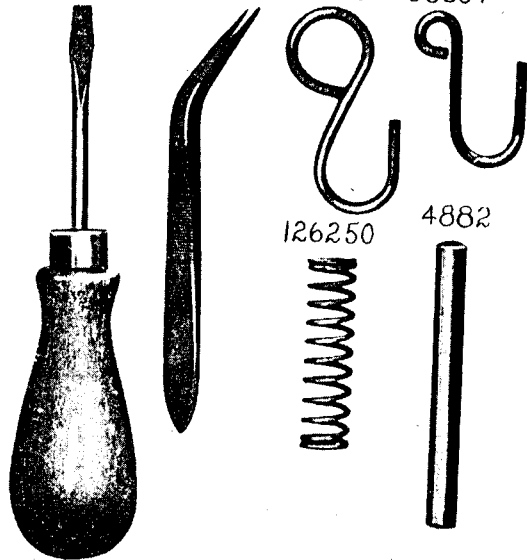
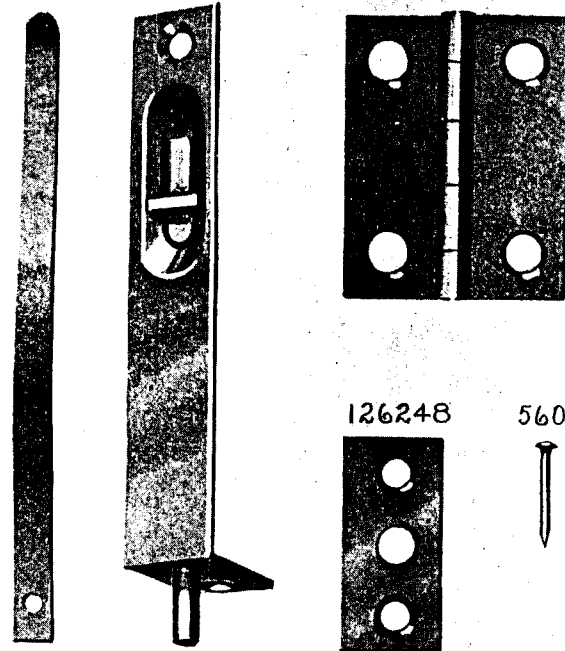
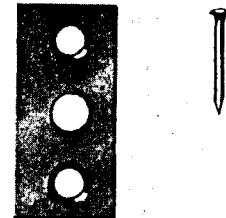

PLATE 8952—FULL SIZE

9370 126247 124500



126248 5604



27998

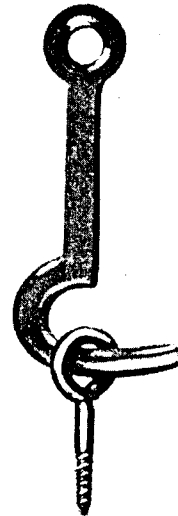

60656

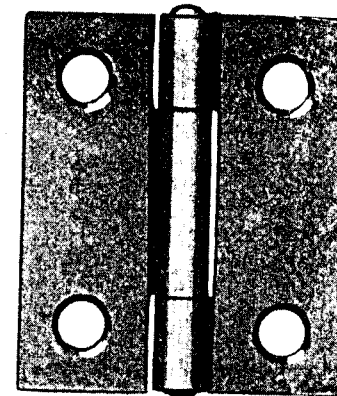

PLATE 8953—ONE-SIXTH SIZE

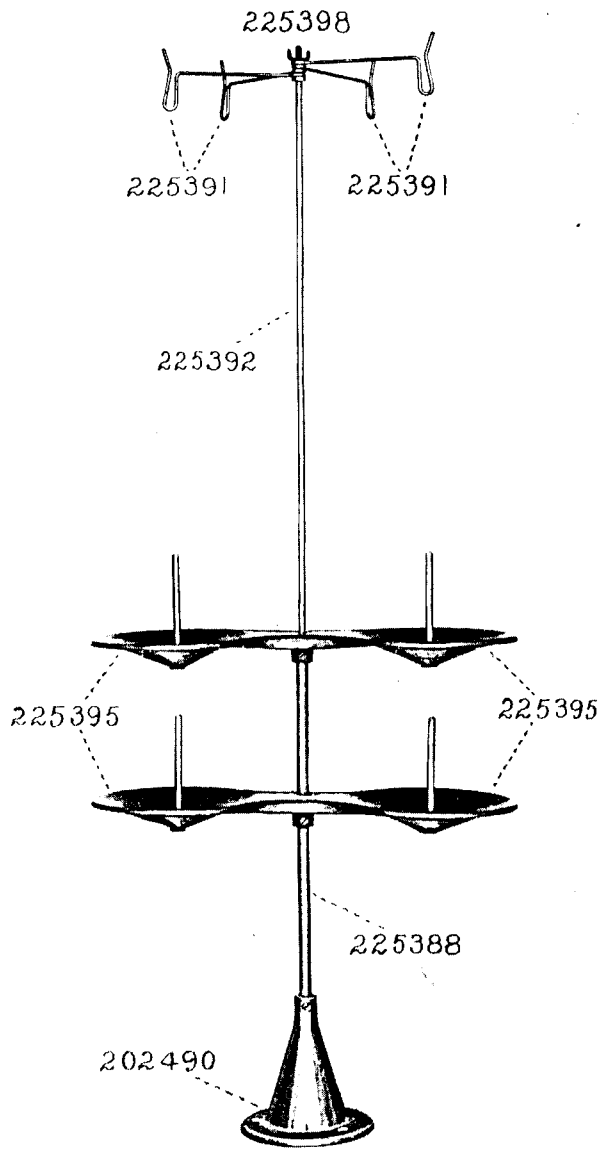

PLATE 8958—FULL SIZE

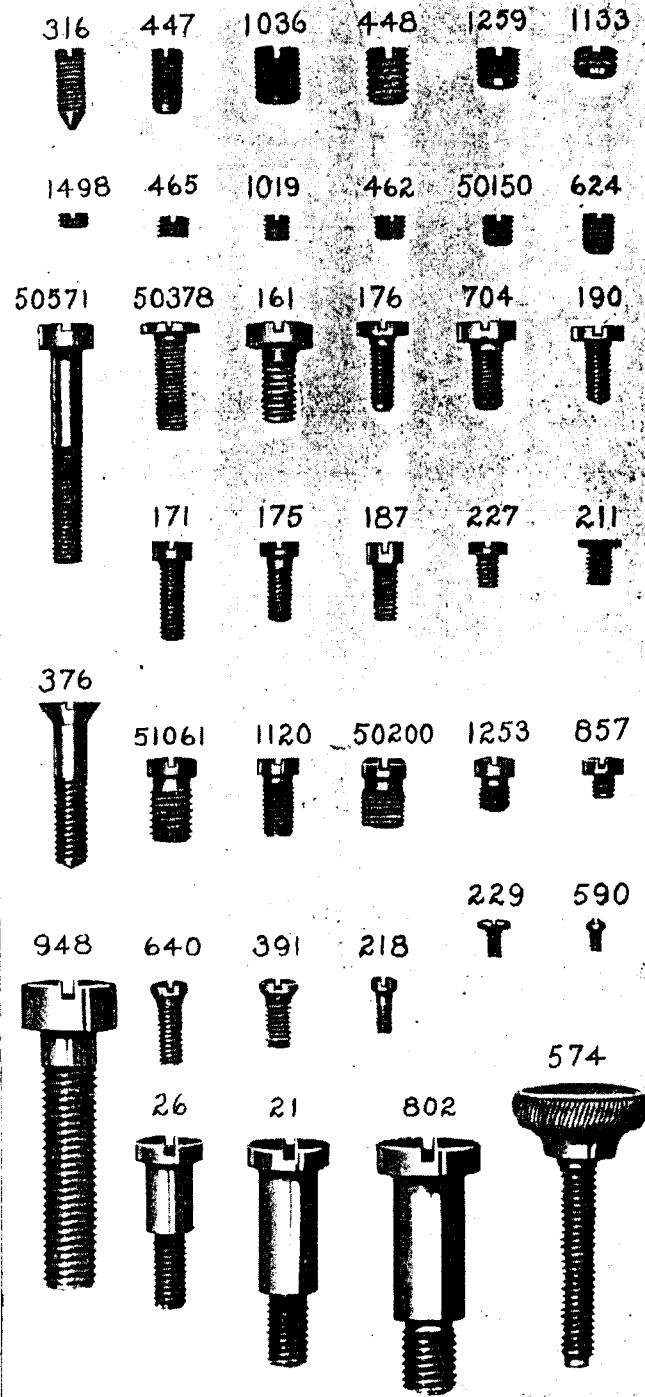

PLATE 8980—ONE-FOURTH SIZE

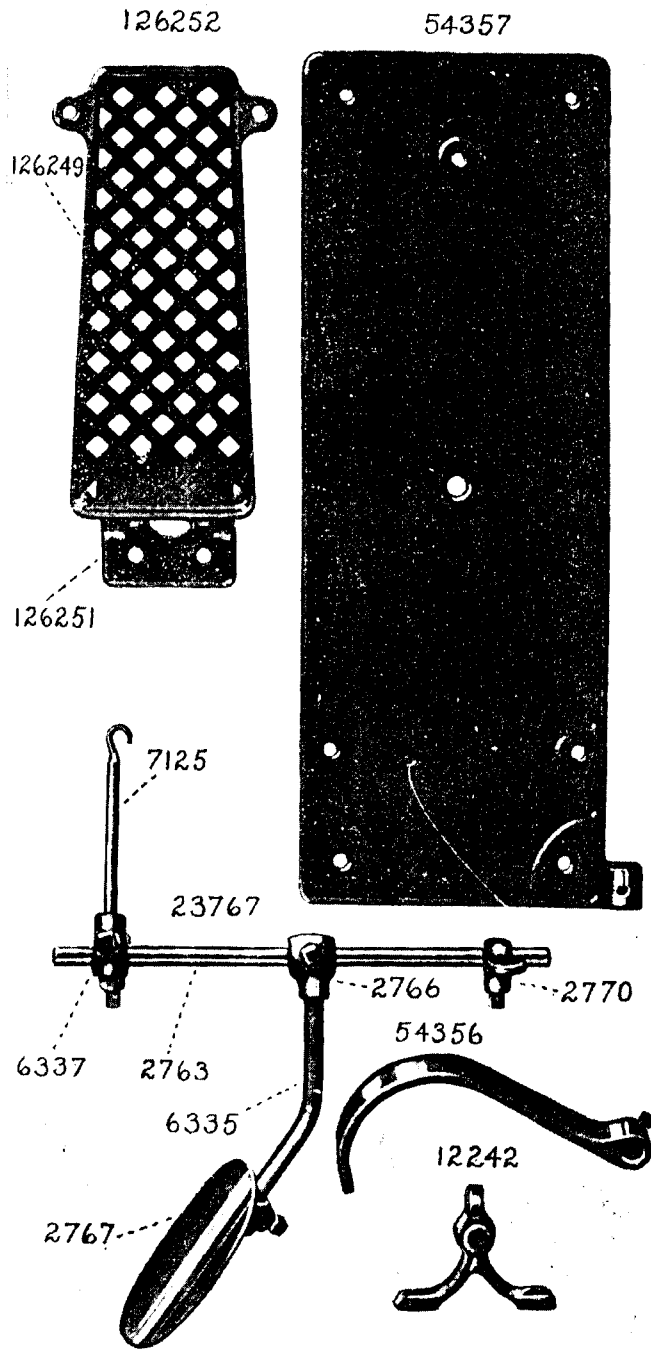

PLATE 8985—FULL SIZE

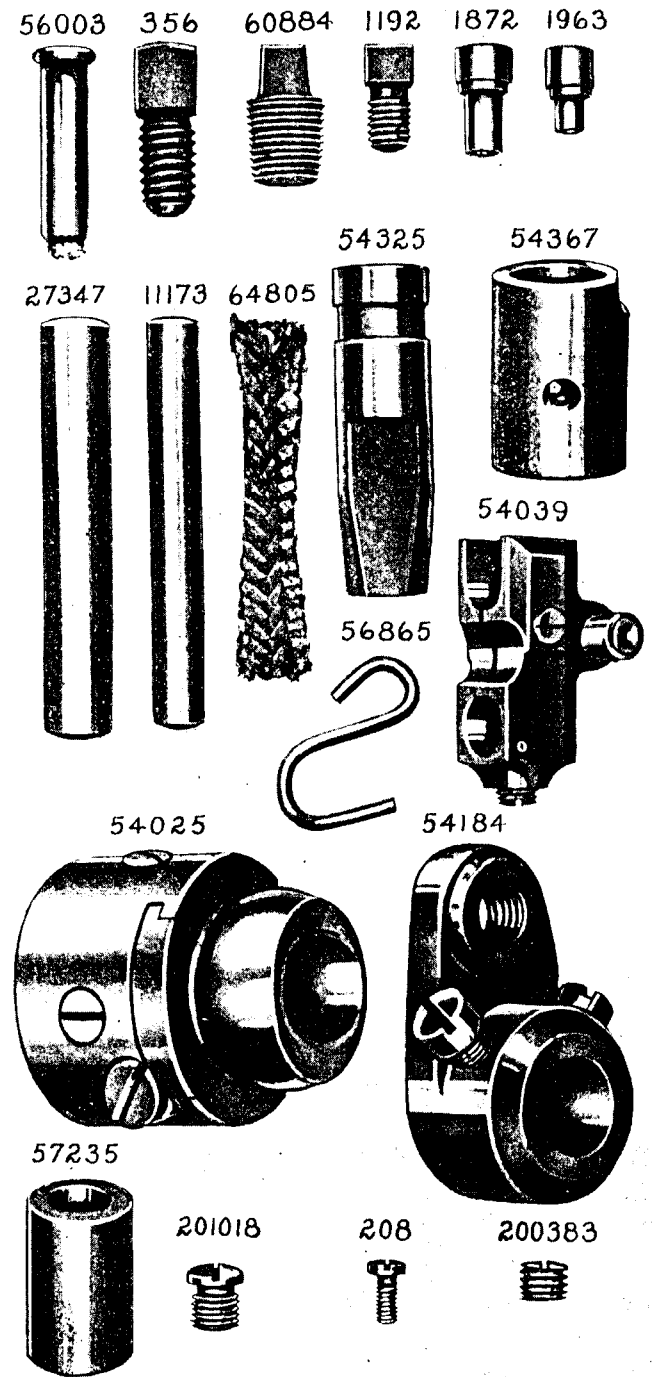

PLATE 8996—ONE-HALF SIZE

64362

54245

54070

49123

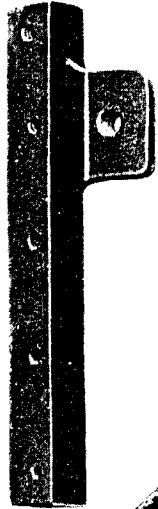

57285

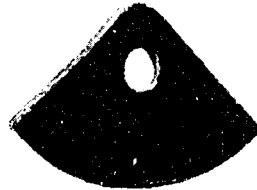

225390

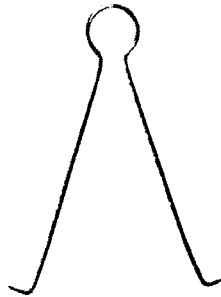

27739

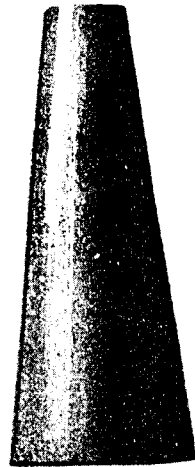

PLATE 9879—ONE-FOURTH SIZE

68222



68223

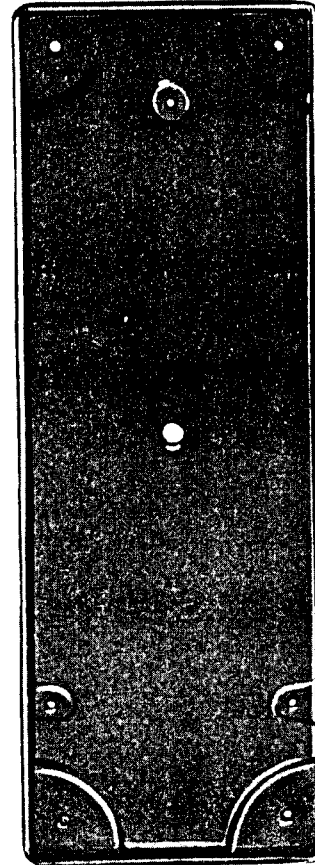

PLATE 9882—FULL SIZE

57234



54023



64331



64320



57258



57257



64255

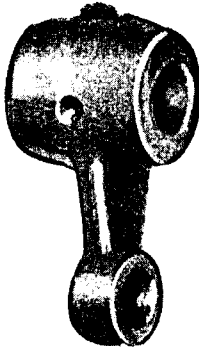

54327



54326

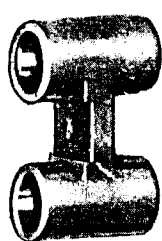

54328

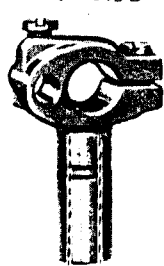

38456

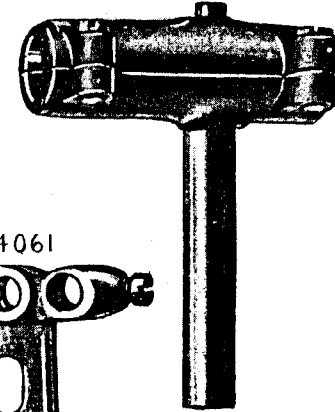

PLATE 9883—FULL SIZE

54228



54230



54061

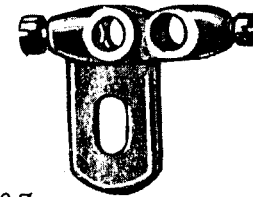

54227

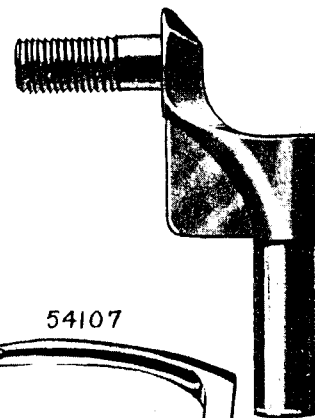

54027

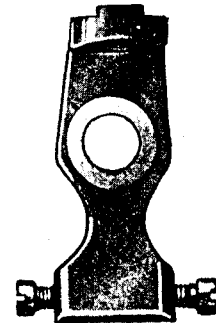

54107

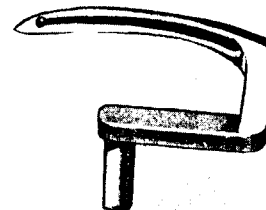

54106

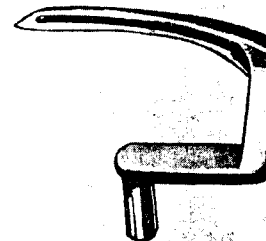

1120



1147



54229



PLATE 9884—FULL SIZE

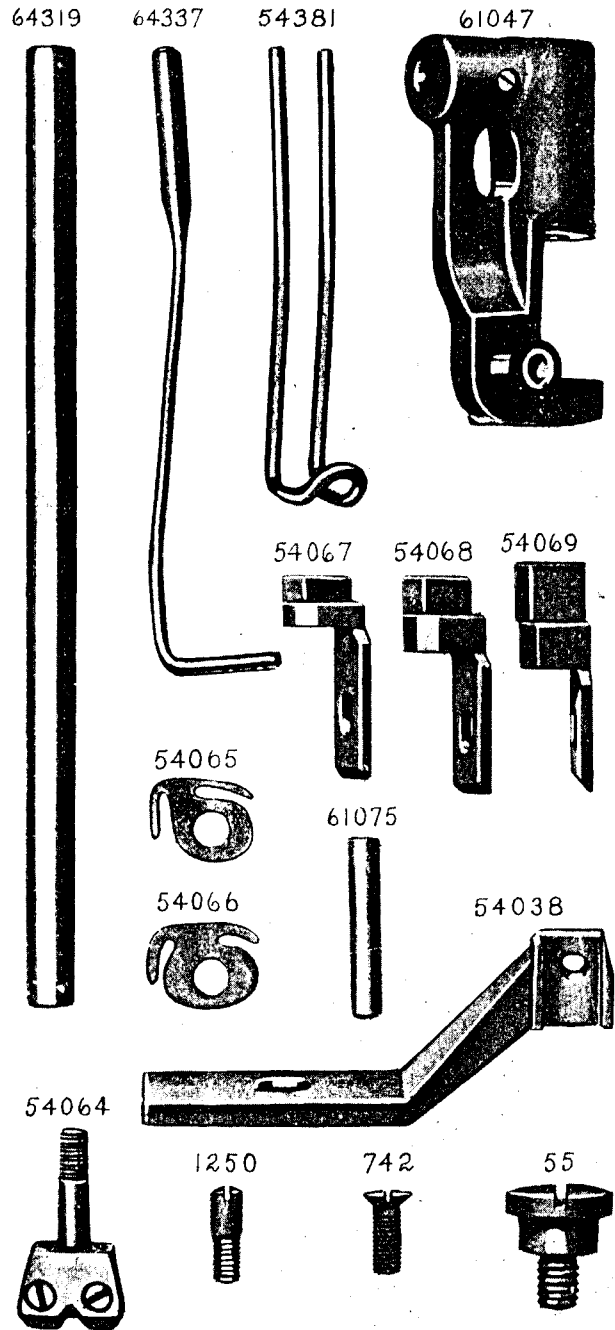

PLATE 9885—FULL SIZE

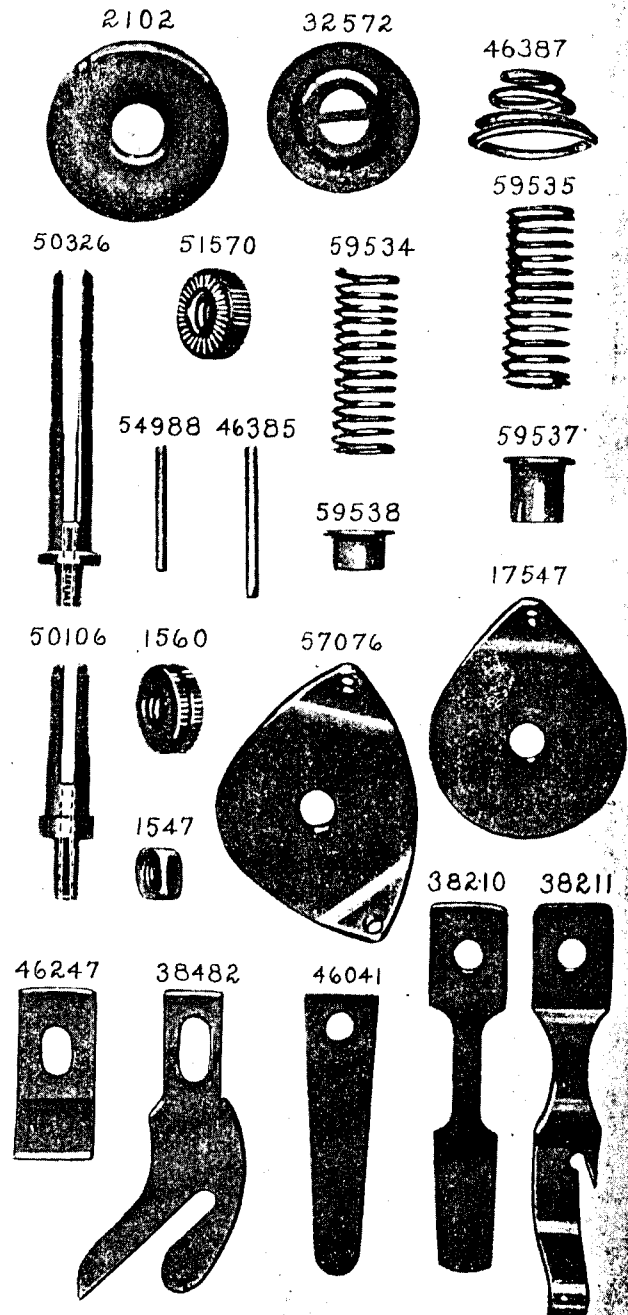
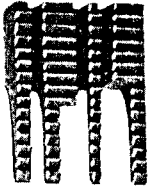

PLATE 9906—FULL SIZE

68262



442



68266

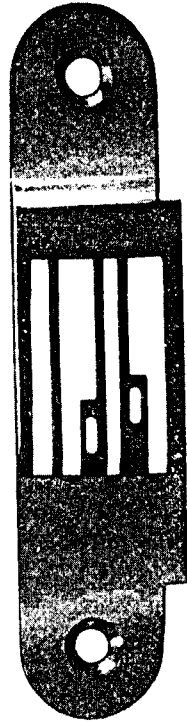

68264

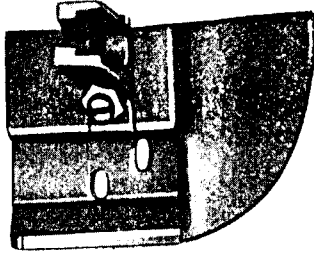

68056

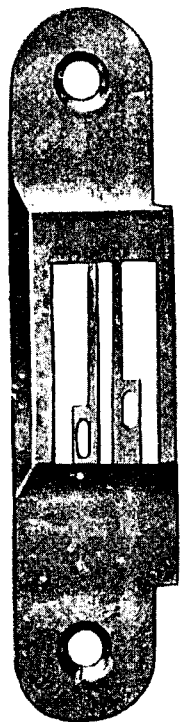

1695



26276



68036

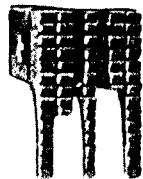

68041

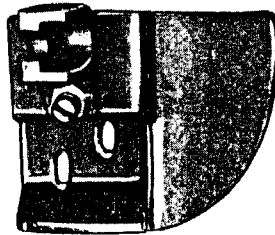
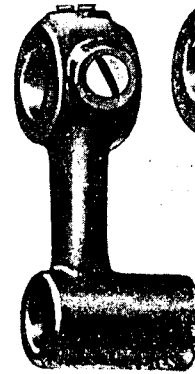

PLATE 9907—FULL SIZE

68055



68052



128690

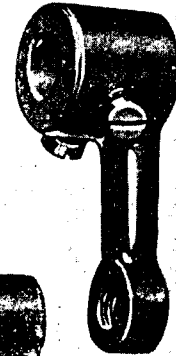

54157

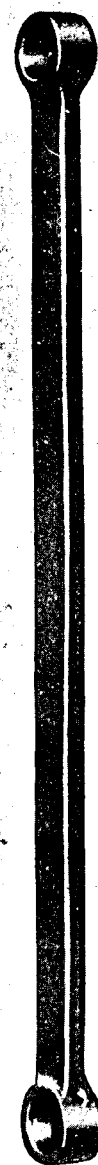

23866



68045

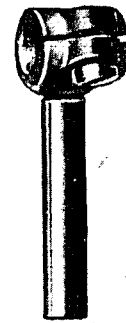

68043



68046



40247



68050

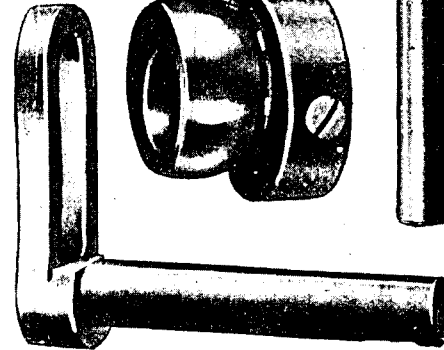

68047

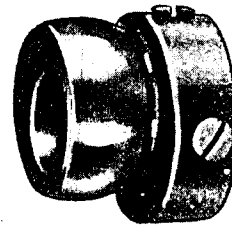

PLATE 9908—FULL SIZE

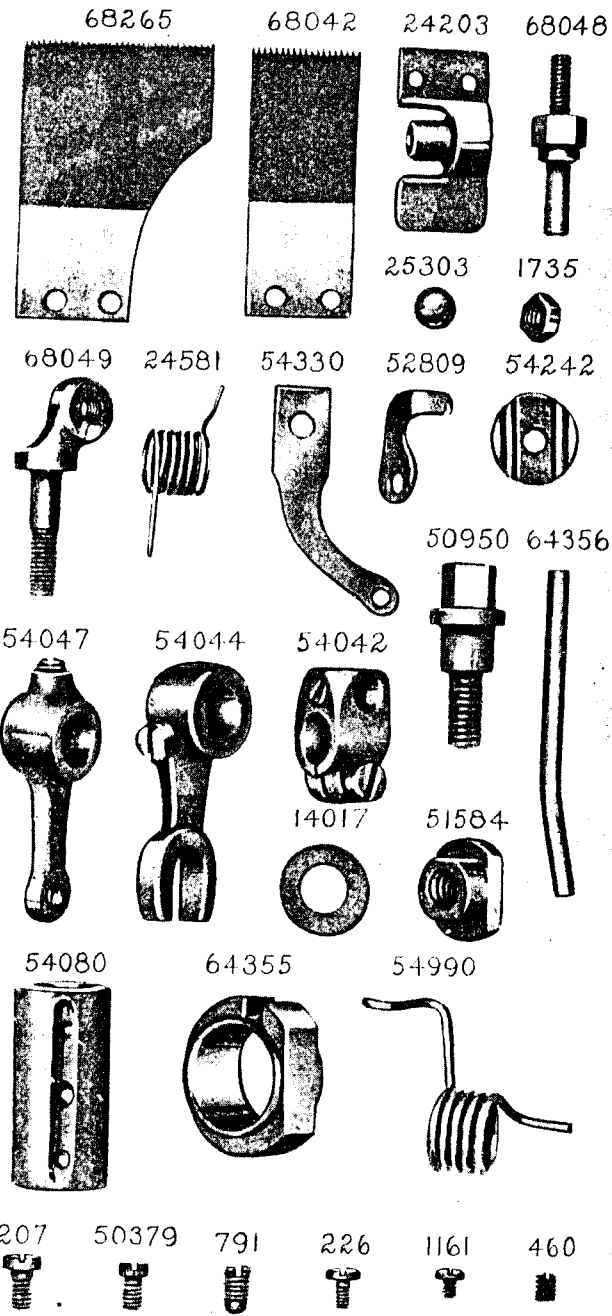

PLATE 9909—FULL SIZE

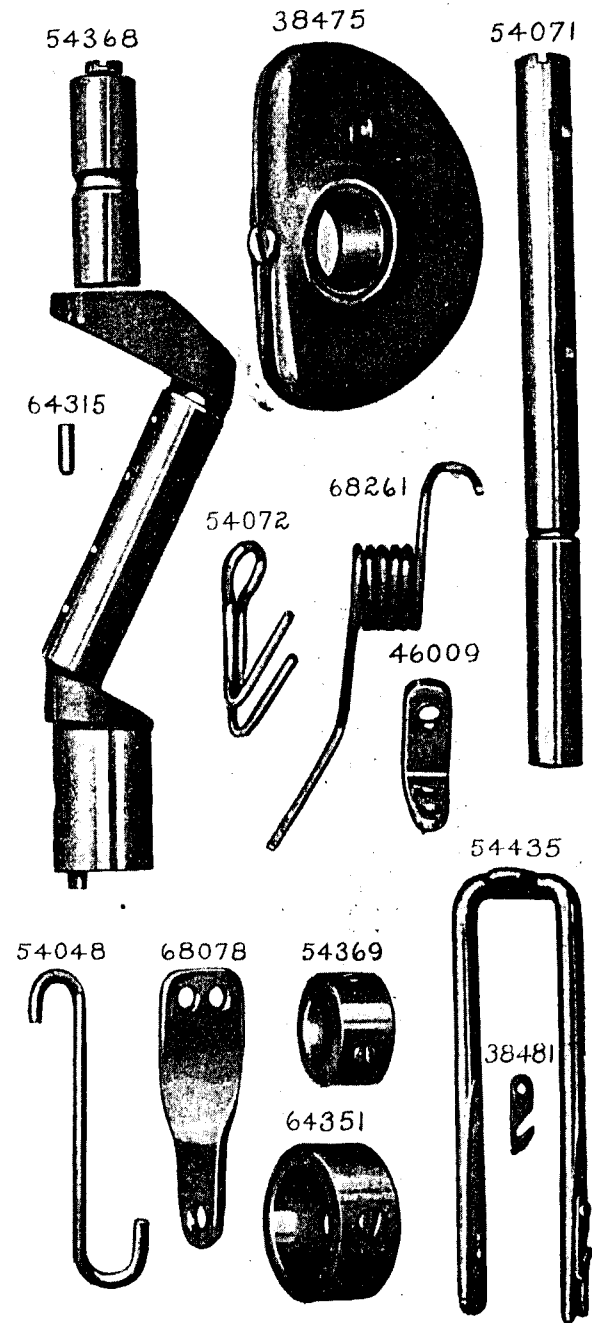

PLATE 9910—FULL SIZE

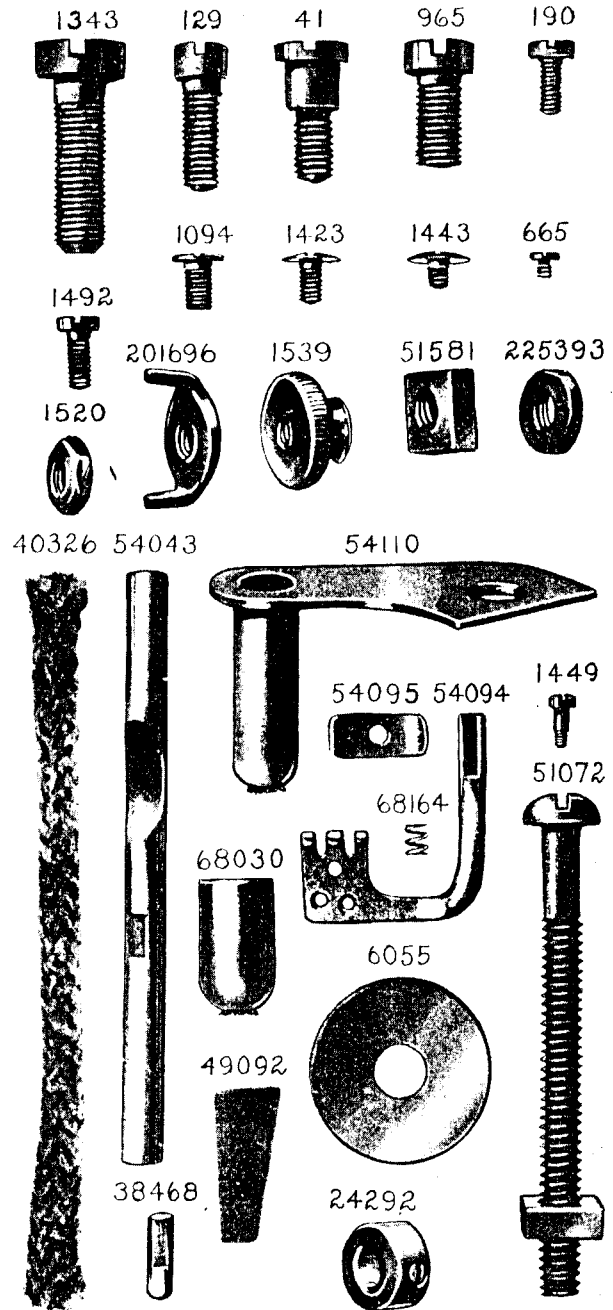

PLATE 9911—ONE-HALF SIZE

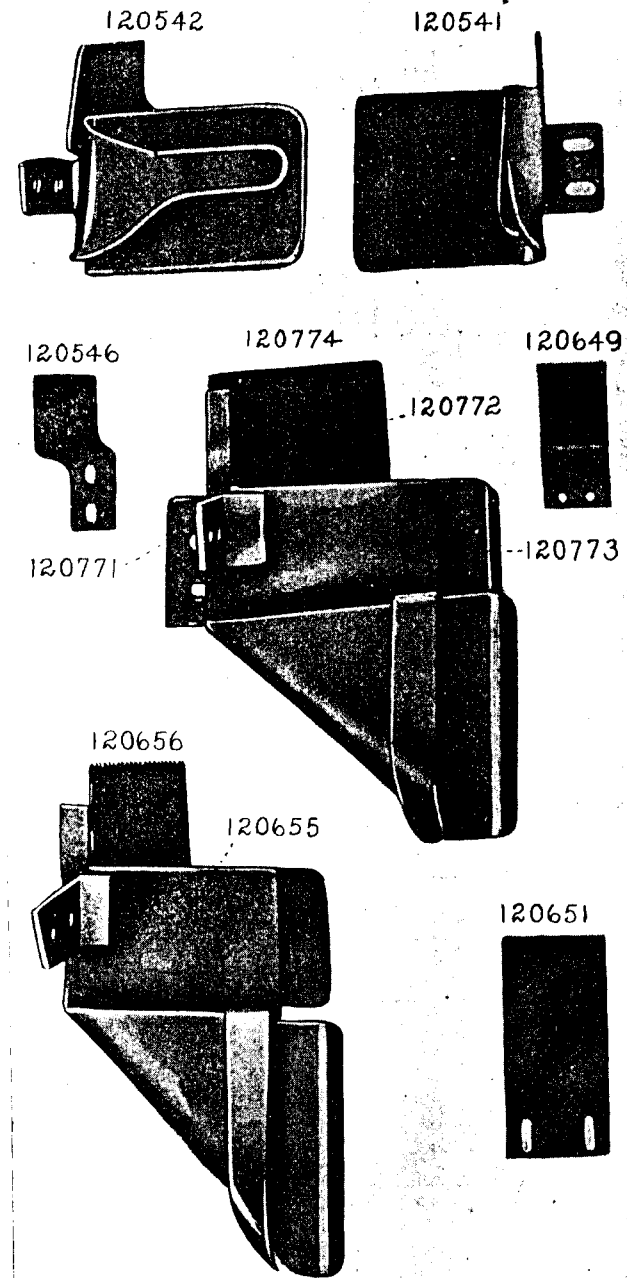
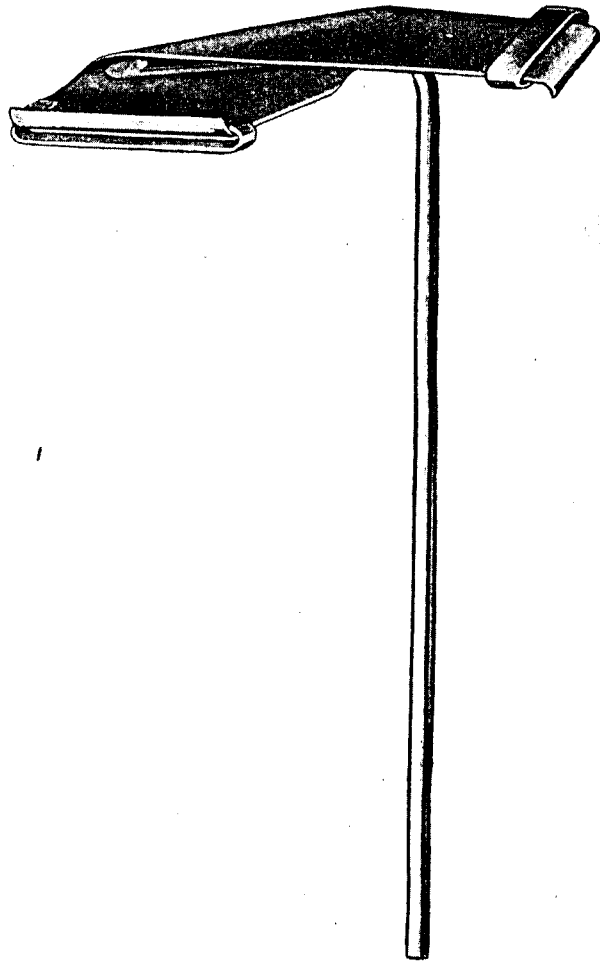

PLATE 9912—ONE-HALF SIZE

120652



120653

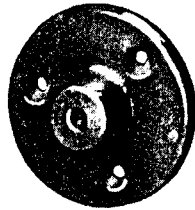
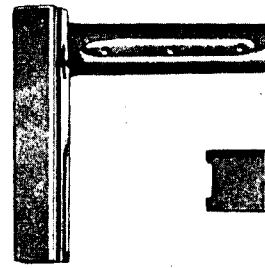

PLATE 9913—ONE-HALF SIZE

68233



68231



68232

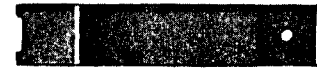

54057

120643 68053

68051

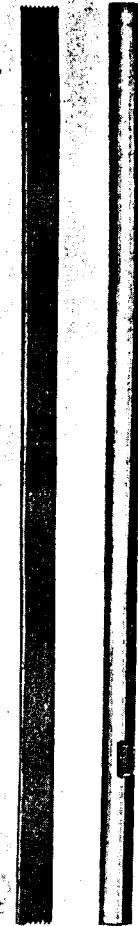
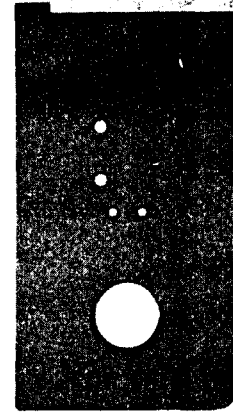
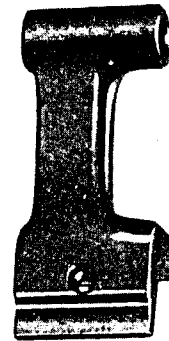

68031

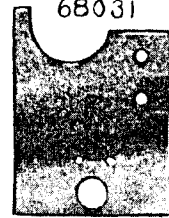

68044

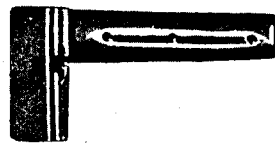

54026

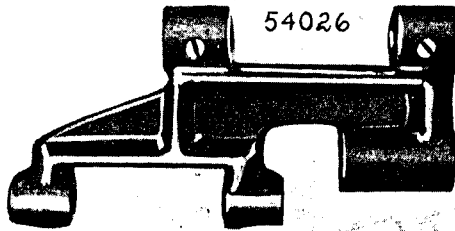

PLATE 9914—ONE-HALF SIZE

68037



54040



68035

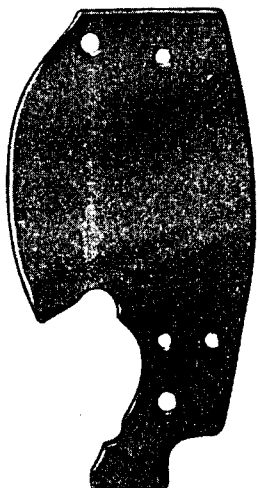

64330



68038



54049

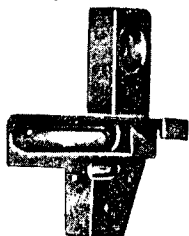

64259

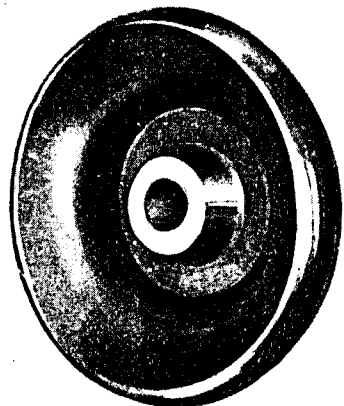
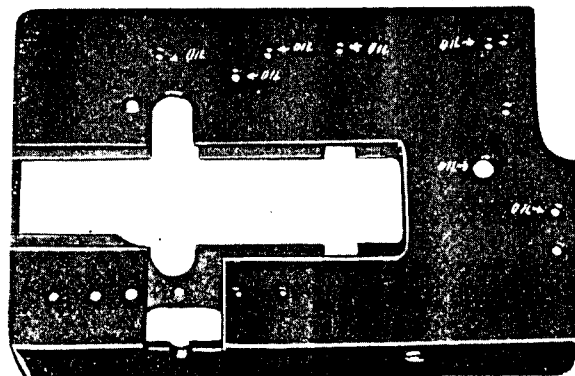

PLATE 9915—ONE-FOURTH SIZE

68029



68034

