

Singer 81-65

Singer 81-72

Singer 81-78

Form 19027  
(23T)  
Printed in U. S. A.

**LIST  
OF  
PARTS**



**MACHINES**  
**Nos. 81-65, 81-72 and 81-78**

---

**THE SINGER MANUFACTURING COMPANY**

## INSTRUCTIONS FOR OILING

BEFORE STARTING THE MACHINE apply Singer Manufacturing Sewing Machine Oil (Cloth and Leather) to the oil cup in the bed of the machine until the reservoir is full. Also fill the oil cup at the top of the machine and thoroughly saturate the wick in the casting near the top of the needle bar. Then oil the needle bar link connection at the front of the machine, also the knife lever and presser lever bearings at the back of the machine.

THEREAFTER, replenish the oil supply in the reservoir about once each day, or often enough to keep it filled. Twice a day apply oil to the remainder of the oiling points.

Copyright, U. S. A., 1932, 1933, 1935, 1936 and 1937,  
by The Singer Manufacturing Co.  
All Rights Reserved for all Countries

## INDEX

	Page
Accessories.....	35
Bench Stands.....	35
Fittings for 81-72 Machine.....	21
Foot Lifter Parts.....	36
Knife Grinder for 81-72 and 81-78 Machines.....	37
Knee Lifter Parts.....	37
Machine Bases.....	38
Machine Base Oil Drain Jar.....	39
Machine No. 81-65.....	5
Machine No. 81-72.....	12
Machine No. 81-78.....	25
Numerical List of Parts.....	43
Parts Required to Change from Three-Thread Chain Stitch to a Two-Thread Chain Stitch.....	20
Thread Unwinders.....	40

## INSTRUCTIONS FOR ORDERING

In ordering from this list, use **ONLY** the part NUMBER in the **FIRST** column.

The number stamped on a Sewing Machine Part is in every case the number of the single part only.

Every combination of parts sent out as such has its specific number, which, although not stamped on the parts, must be used when ordering the combination.

Each number always indicates the **SAME PART** in whatever list it appears, or for whatever machine.

The letters after some of the numbers indicate the style of finish only, as follows:

- A-Hardened, Polished, Nickel Plated and Buffed
- B-Polished, Nickel Plated and Buffed
- C-Hardened Only
- D-Polished Only
- E-Soft, Not Polished
- F-Hardened and Polished
- F.J-Hardened, Polished and Nickel Plated
- G-Bright Rumbled and Nickel Plated
- H-Blued
- J-Nickel Plated Only
- K-Hardened and Nickel Plated
- L-Brass Plated
- M-Oxidized
- N-Japaned, Dull
- P-Japaned, Bright
- R-Merlized
- S-Cadmium Plating
- T-Copper Plated
- T.A-Hardened, Polished, Copper and Nickel Plated and Buffed
- T.B-Copper and Nickel Plated and Polished
- T.J-Copper and Nickel Plated Only
- T.K-Hardened, Copper and Nickel Plated
- T.L-Copper and Brass Plated
- T.M-Copper Plated and Oxidized
- U-Zinc Plated
- V-Silver Plated
- W-Polished and Nickel Plated
- Y-Black Nickel Plated Only
- Z-Chromium Plated
- Z.B-Polished, Nickel Plated, Buffed and Chromium Plated
- Z.J-Nickel and Chromium Plated

These letters **MUST BE USED** when they appear in the list; and **AFTER** the number as in the list.

In this series:

- 1 to 1500, 50001 to 51500 and 140001 to 142000 are Screw Numbers
- 1501 to 1800 and 51501 to 51800 are Nut Numbers
- 1801 to 2000 and 51801 to 52000 are Roller Numbers
- 2001 to 50000 and 52001 to 140000 and 142001 to 190000 are Sewing Machine Parts, 190001 and upward are numbers of Electrical Parts.

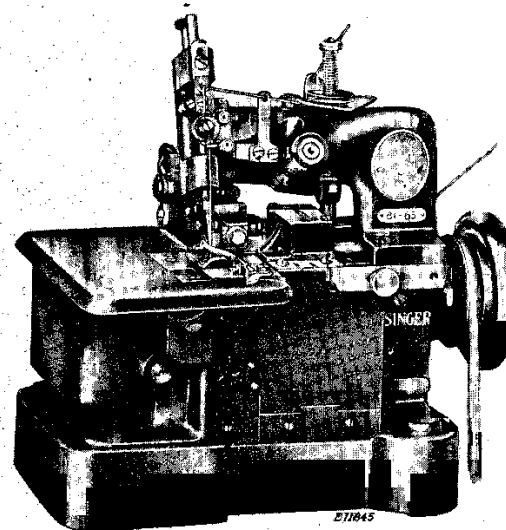
The figures in the second column refer only to the plates, illustrating the parts, and are **NOT TO BE USED** in ordering.

Parts marked with an asterisk (\*) are furnished only when repairs are made at factory.

When ordering parts which differ as to Gauge (the distance between seams) the Gauge, as well as the Number must be given on order.

## LIST OF PARTS COMPLETE

FOR



**MACHINE No. 81-65**

For Serging Pants and Cut Edges of Cloth. No trimmer. Has a guide adjustable for different thicknesses and widths of bight. Two-thread stitch. Foot lifter. Needle bar stroke 7/8 inch. Will stitch material up to 3/16 inch in thickness. Length of stitch up to 1/4 inch. Speed 4500 R. P. M. for long runs.

No.	Plate	Name
* 132522	-----	Arm with 15404, 42253, 132580 and two each 482C, 624C, 15405 and 132589.....
4389	20821	Arm Dowel Pin.....
68350	20821	" Oil Cup.....
948E	20846	" Screw.....
132632	20833	Balance Wheel, 1 7/8 in. pulley, with 448C and 1285C.....
1285C	20807	Balance Wheel Position Screw.....
448C	7409	" " Set Screw.....
132524	20808	Cloth Plate with 132525.....
132601	20808	" " Extension (lower).....
233E	20821	" " " " Screw.....
42108	20821	" " " " (upper).....
233E	20821	" " " " Screw.....
* 132525	-----	" " Hinge Bracket.....
132526	20821	" " " Stud.....

## PARTS FOR MACHINE NO. 81-65

No.	Plate	Name
50150C	20821	Cloth Plate Hinge Stud Set Screw.....
42005	20821	" " Lock Spring.....
236C	20821	" " " Screw.....
132527	-----	Cloth Plate complete, Nos. 42005, 42108, 132524, 132601, two 236C and five 233E.....
42205	20831	Feed Bar with 1253C.....
132642	-----	" " 42205 with 132539.....
132528	20831	" " Hinge Pin.....
1253C	20846	" " " Set Screw.....
132529	7407	" " Connecting Rod with 171C, 1695J and two 1057C.....
132643	-----	Feed Connecting Rod 132529 with 132644.
1057C	7407	" " " Cap Screw.....
51292C	7407	" " " Hinge Screw.....
171C	7407	" " " " Clamping Screw.....
1695J	7407	Feed Connecting Rod Hinge Screw Clamping Screw Nut.....
1520J	5569	Feed Connecting Rod Hinge Screw Nut.....
42267	20840	" Dog, 24 teeth (16 teeth to the inch) for 132884.....
190J	20846	Feed Dog Screw.....
*132531	-----	" Eccentric.....
*132532	-----	" " Body.....
1036C	5569	" " " Set Screw.....
19047	7407	" " Clamping Washer.....
201J	7407	" " " Screw....
132533	7407	" " Oil Tube.....
132644	20831	Feed Eccentric complete, Nos. 201J, 19047, 51145C, 132531 to 132533 and two 1036C.....
132651	7407	Feed Eccentric Cover.....
42102	7409	" " " Holder.....
132634	-----	" " " 42102 with 132651 and two 50253J.....
283W	7409	Feed Eccentric Cover Holder Thumb Screw.
19044	7407	" " " Washer.....
50253J	7407	Feed Eccentric Cover Screw.....
132712	20831	" " Lint Cover (spring).....
132755	20831	" " Lubricator with 132537....
132537	20831	" " Oil Wick (braided cotton).....
132835	20832	Feed Lifting Eccentric with two 462C....
132539	20832	" " " Connection.....
462C	20846	" " " Set Screw.....
51145C	7407	" Regulating Screw.....
132625	20832	" Rock Shaft.....
132626	-----	Feed Rock Shaft complete, Nos. 42021 and 132625.....
42021	20832	Feed Rock Shaft Crank with 157E.....

## PARTS FOR MACHINE NO. 81-65

No.	Plate	Name
157E	5569	Feed Rock Shaft Crank Clamping Screw....
132542	20832	" " " Hinge Pin with 132544....
132543	20832	" " " " " Bushing.....
132816	20823	" " " " " " Oil Wick (wick).....
1036C	5569	Feed Rock Shaft Hinge Pin Bushing Set Screw.....
132544	20832	Feed Rock Shaft Hinge Pin Oil Wick (braided cotton).....
*132545	-----	Frame.....
132546	20808	" Bottom Cover with 132594.....
132547	20808	" " " Gasket.....
190E	20846	" " " Screw.....
132548	20821	" Oil Cup.....
132819	20833	" Rotary Shaft with 132558 and 132559.....
132820	-----	Frame Rotary Shaft 132819 with 132774, 132790, 132802 and 132806.....
132790	20834	Frame Rotary Shaft Ball Sleeve.....
132774	20817	" " " " Guide....
*132862	-----	" " " Bushing (front).....
132863	20817	" " " " 132862 with 132835, 132864 and two 132715..
132864	20823	Frame Rotary Shaft Bushing (front) Oil Pad (braided cotton).....
132715	20817	Frame Rotary Shaft Bushing (front) Oil Pad Retainer.....
132817	20823	Frame Rotary Shaft Bushing (front) Oil Wick (wick).....
51332C	20821	Frame Rotary Shaft Bushing (front) Set Screw.....
132769	20817	Frame Rotary Shaft Crank with 1036C, 1375C and 132773.....
132770	20817	Frame Rotary Shaft Crank Ball Sleeve....
132771	20817	" " " " " Bushing.....
1664E	20817	Frame Rotary Shaft Crank Ball Sleeve Bushing Nut.....
132772	20817	Frame Rotary Shaft Crank Ball Sleeve Bushing Nut Washer.....
132773	20846	Frame Rotary Shaft Crank Ball Sleeve Bushing Position Pin.....
132774	20817	Frame Rotary Shaft Crank Ball Sleeve Guide.....
1375C	20817	Frame Rotary Shaft Crank Position Screw.
1036C	5569	" " " " Set Screw.....
132775	-----	Frame Rotary Shaft Crank complete, Nos. 1664E and 132769 to 132773.....
132835	20817	Frame Rotary Shaft Crank Oil Sling Cover
*132865	20833	" " " Flanged Bushing (back)
132866	-----	" " " " "
		132865 with 132692, 132867, 132868 and two 132603.....

## PARTS FOR MACHINE NO. 81-65

No.	Plate	Name
132867	20823	Frame Rotary Shaft Flanged Bushing (back) Oil Pad, large.....
132868	20823	Frame Rotary Shaft Flanged Bushing (back) Oil Pad, small (braided cotton).....
132803	20834	Frame Rotary Shaft Flanged Bushing (back) Oil Pad Retainer.....
132817	20823	Frame Rotary Shaft Flanged Bushing (back) Oil Wick (wick).....
51332C	20821	Frame Rotary Shaft Flanged Bushing (back) Set Screw.....
132558	20823	Frame Rotary Shaft Oil Pad (braided cotton).....
132559	20823	Frame Rotary Shaft Oil Pad Retainer.....
132692	20834	" " " " Sling Cover.....
132638	20833	" " " " Side Cover (left) with 132701.....
132701	20821	" " " " Handle.....
330W	20821	" " " " Screw.....
42028	20833	" " " " (right) hinged.....
42192	20835	" " " " Lock Spring....
330W	20821	" " " " " Screw
330W	20821	" " " " " Screw.....
132788	20854	" " " " Top Cover.....
132787	-----	" " " " 132786 with 132782 to 132784 and two 197J.....
132782	20821	Frame Top Cover Oil Reservoir Cover....
197J	20846	" " " " " Screw
132783	20821	" " " " Tube.....
132784	20821	" " " " Wick.....
583F	20846	" " " " Screw (large).....
742F	20846	" " " " (small).....
38571	20835	Guide with 230J and 38572.....
38572	20835	" Smoothing Plate.....
230J	20846	" " " " Screw.....
217F	20846	" " " " Screw.....
7071	20821	" " " " Washer.....
42114	20835	Looper (left hand).....
50117C	20846	" " " " Clamping Screw.....
132795	20835	" " " " Lever with 50117C....
132796	20835	" " " " Connecting Link
132797	20835	" " " " " " "
		Hinge Pin.....
51459E	20835	Looper (left hand) Lever Connecting Link Screw.....
1735J	20835	Looper (left hand) Lever Connecting Link Screw Nut.....
132798	20835	Looper (left hand) Lever Hinge Stud with 132552.....
132552	20835	Looper (left hand) Lever Hinge Stud Oil Pad (braided cotton).....
132816	20823	Looper (left hand) Lever Hinge Stud Oil Wick (wick).....

## PARTS FOR MACHINE NO. 81-65

No.	Plate	Name
1036C	5589	Looper (left hand) Lever Hinge Stud Set Screw.....
132799	20836	Looper (right hand) and Spreader Lever with 233E, 241E and 140123C.....
132800	-----	Looper (right hand) and Spreader Lever 132799 with 132699.....
132801	-----	Looper (right hand) and Spreader Lever 132800 with 42242, 132795, 132798 and two each 1735J, 51459E, 132796 and 132797.....
132802	20817	Looper (right hand) and Spreader Lever Ball Stud.....
140123C	20846	Looper (right hand) and Spreader Lever Ball Stud Set Screw.....
132777	20817	Looper (right hand) and Spreader Lever Connection with four 896C.....
132779	-----	Looper (right hand) and Spreader Lever Connection 132777 with 132774, 132775 and 132802.....
896C	20817	Looper (right hand) and Spreader Lever Connection Cap (lower) Screw.....
896C	20817	Looper (right hand) and Spreader Lever Connection Cap (upper) Screw.....
132899	20836	Looper (right hand) and Spreader Lever Hinge Pin with 125056.....
132543	20832	Looper (right hand) and Spreader Lever Hinge Pin Bushing.....
132818	20823	Looper (right hand) and Spreader Lever Hinge Pin Bushing Oil Wick (wick)..
1036C	5589	Looper (right hand) and Spreader Lever Hinge Pin Bushing Set Screw.....
125056	20836	Looper (right hand) and Spreader Lever Hinge Pin Oil Wick (braided cotton)
1036C	5589	Looper (right hand) and Spreader Lever Hinge Pin Set Screw.....
241E	20846	Looper (right hand) and Spreader Lever Oil Plug Screw.....
42054	20837	Needle Bar.....
42253	20837	" " Bushing (lower).....
132580	20837	" " " (upper).....
132581	20837	" " " " Oil Pad (braided cotton).....
462C	20846	Needle Bar Bushing Set Screw.....
132598	20837	" " Connecting Bracket with 187E and 223F.....
187E	20846	Needle Bar Connecting Bracket Clamping Screw.....
132582	20837	Needle Bar Connecting Link.....
132583	20837	" " " " Hinge Pin with 132584.....
132584	20837	Needle Bar Connecting Link Hinge Pin Oil Pad (wick).....







No.	Plate	Name
132818	20823	Feed Rock Shaft Hinge Pin Bushing Oil Wick (wick).....
1036C	5569	Feed Rock Shaft Hinge Pin Bushing Set Screw.....
132544	20832	Feed Rock Shaft Hinge Pin Oil Wick (braided cotton).....
132545	-----	Frame.....
132546	20808	" Bottom Cover with 132594.....
132547	20808	" " " Gasket.....
190E	20846	" " " Screw.....
132548	20821	" Oil Cup.....
132819	20833	" Rotary Shaft with 132558 and 132559.....
132820	-----	Frame Rotary Shaft 132819 with 132774, 132790, 132802 and 132806.....
132790	20834	Frame Rotary Shaft Ball Sleeve.....
132774	20817	" " " " Guide....
132862	-----	" " " " Bushing (front).....
132863	20817	" " " " 132862 with 132835, 132864 and two 132715..
132864	20823	Frame Rotary Shaft Bushing (front) Oil Pad (braided cotton).....
132715	20817	Frame Rotary Shaft Bushing (front) Oil Pad Retainer.....
132817	20823	Frame Rotary Shaft Bushing (front) Oil Wick (wick).....
51332C	20821	Frame Rotary Shaft Bushing (front) Set Screw.....
132769	20817	Frame Rotary Shaft Crank with 1036C, 1375C and 132773.....
132770	20817	Frame Rotary Shaft Crank Ball Sleeve....
132771	20817	" " " " " Bushing.....
1664E	20817	Frame Rotary Shaft Crank Ball Sleeve Bushing Nut.....
132772	20817	Frame Rotary Shaft Crank Ball Sleeve Bushing Nut Washer.....
132773	20846	Frame Rotary Shaft Crank Ball Sleeve Bushing Position Pin.....
132774	20817	Frame Rotary Shaft Crank Ball Sleeve Guide.....
1375C	20817	Frame Rotary Shaft Crank Position Screw.
1036C	5569	" " " " Set Screw.....
132775	-----	Frame Rotary Shaft Crank complete, Nos. 1664E and 132769 to 132772.....
132835	20817	Frame Rotary Shaft Crank Oil Sling Cover
132865	20833	" " " " Flanged Bushing (back)
132866	-----	" " " " " 132865 with 132892, 132867, 132868 and two 132603.....
132867	20823	Frame Rotary Shaft Flanged Bushing (back) Oil Pad, large.....

No.	Plate	Name
132868	20823	Frame Rotary Shaft Flanged Bushing (back) Oil Pad, small (braided cotton).....
132803	20834	Frame Rotary Shaft Flanged Bushing (back) Oil Pad Retainer.....
132817	20823	Frame Rotary Shaft Flanged Bushing (back) Oil Wick (wick).....
51332C	20821	Frame Rotary Shaft Flanged Bushing (back) Set Screw.....
132558	20823	Frame Rotary Shaft Oil Pad (braided cotton).....
132559	20823	Frame Rotary Shaft Oil Pad Retainer....
132892	20834	" " " " Sling Cover.....
132560	20833	" Side Cover (left) with 132701.....
132701	20821	" " " " Handle.....
330W	20821	" " " " Screw.....
42028	20833	" " " " (right) hinged.....
42101	20821	" " " " Lock Spring....
330W	20821	" " " " Screw.....
132780	20808	" Top Cover.....
132781	-----	" " " 132780 with 132782 to 132784 and two 197J.....
132650	7409	Frame Top Cover Extension.....
42102	7409	" " " " Holder.....
132600	-----	" " " " " 42102 with 42101, 132650, 132651 and two each 176J and 50253J.....
283W	7409	Frame Top Cover Extension Holder Thumb Screw.....
19044	7407	Frame Top Cover Extension Holder Thumb Screw Washer.....
176J	20848	Frame Top Cover Extension Screw.....
132782	20821	" " " Oil Reservoir Cover....
197J	20846	" " " " " Screw
132783	20821	" " " " Tube.....
132784	20821	" " " " Wick.....
583F	20846	" " " " Screw (large).....
742F	20846	" " " " (small).....
42305	20818	Knife (movable).....
Note:	Two No. 42305 are sent with this machine.	
42306	20818	Knife (movable) Gib.....
42307	20818	" " " Holder.....
42308	-----	" " " " 42307 with 133F, 42040 and 42306.....
42038	7409	Knife (movable) Holder Guide with 336F..
42039	7409	" " " " " Plate.....
821E	7409	" " " " " Screw
336F	7409	" " " " " Set Screw..
183F	7409	" " " " " Screw.....
42040	7409	" " " " " Extension Pin.....
42041	7409	Knife (movable) Holder Spring.....



## PARTS FOR MACHINE NO. 81-72

No.	Plate	Name
	896C 20817	Needle Bar Connecting Rod Cap (upper) Screw.....
132879	20838	Needle Bar Crank (back) with 132590 and two 1259C.....
132802	20817	Needle Bar Crank (back) Ball Stud.....
1259C	20846	" " " " " Set Screw.....
132589	20838	Needle Bar Crank (back) Bushing.....
624C	20846	" " " " " Set Screw
132590	20838	" " " " " Oil Pad (wick)..
1259C	20846	" " " " " Set Screw.....
132880	20838	" " " " (front) with 620C, 50200C and 140123C.....
132882	-----	Needle Bar Crank (front) 132880 with 132582, 132598 and two 132583.....
140123C	20846	Needle Bar Crank (front) Position Screw.
50200C	20846	" " " " " Set Screw.....
42115	20838	" " " " " Thread Retainer Bracket.....
42483	20838	" " " " " Disc.....
93C	20846	" " " " " Screw.....
10107	20838	" " " " " Spring.....
1728C	20846	" " " " " Clamping Nut.....
42066	20838	" " " " " Guard.....
171F	7407	" " " " " Screw.....
132682	20841	Presser Foot Chaining-off Finger.....
233J	20821	" " " " " Screw..
1326C9	20841	" " " " " Plate.....
132610	20841	" " " " " Collar with 240C.....
132611	20841	Presser Foot Chaining-off Plate Collar Guide Pin.....
735C	20846	Presser Foot Chaining-off Plate Collar Guide Pin Set Screw.....
240C	20846	Presser Foot Chaining-off Plate Collar Set Screw.....
62527	20840	Presser Foot Hinge Pin.....
132822	-----	" " " " " Plate.....
132612	-----	" " " " " Shank with 735C.....
14058	20840	" " " " " Spring.....
132823	20841	Presser Foot (spring hinged) complete, Nos. 233J, 14058, 62527, 132609 to 132612, 132682 and 132822.....
1324C	20824	Presser Foot Screw.....
39541	20824	" " " " " Washer.....
42069	20839	" " " " " Lever.....
42376	-----	" " " " " 42069 with 42045.....
42045	20834	" " " " " Hinge Stud.....
1120C	20846	" " " " " Set Screw.....
42070	20839	" " " " " Lifter.....
85D	20839	" " " " " Hinge Screw.....
1377C	20807	" " " " " Screw Stud (eccentric)....
1547J	7409	" " " " " Nut.....

## PARTS FOR MACHINE NO. 81-72

No.	Plate	Name
42071	20839	Presser Lever Spring.....
1378D	20839	Pressure Regulating Thumb Screw.....
132631	20836	Spreader.....
197J	20846	" " " " " Screw.....
2102	20843	Tension (looper, left hand) Disc.....
51570C	20843	" " " " " Regulating Thumb Nut.....
50326C	20843	Tension (looper, left hand) Screw Stud..
59539	-----	" " " " " " " " 50326C with 51570C.....
59534	20843	Tension (looper, left hand) Spring.....
59537	20843	" " " " " Bushing (large).....
59538	20843	Tension (looper, left hand) Spring Bushing (small).....
132599	20843	Tension (looper, left hand) Thread Guide
2102	20843	" (looper, right hand) Disc.....
51570C	20843	" " " " " Regulating Thumb Nut.....
50148C	20843	Tension (looper, right hand) Screw Stud..
132871	-----	" " " " " " " " 50148C with 51570C.....
59535	20843	Tension (looper, right hand) Spring.....
59537	20843	" " " " " Bushing (large).....
59538	20843	Tension (looper, right hand) Spring Bushing (small).....
57078	20843	Tension (looper, right hand) Thread Guide.....
2102	20843	Tension (needle thread) Disc.....
51570C	20843	" " " " " Regulating Thumb Nut.....
50261C	20843	Tension (needle thread) Screw Stud.....
132360	-----	" " " " " " " " 50261C with 51570C.....
59535	20843	Tension (needle thread) Spring.....
59537	20843	" " " " " Bushing (large).....
59538	20843	Tension (needle thread) Spring Bushing (small).....
42242	20845	Thread (looper, left hand) Eyelet.....
233E	20821	" " " " " Screw..
42122	20844	" " " " " Nipper Spring (lower).....
42123	20844	Thread (looper, left hand) Nipper Spring (upper).....
176J	20846	Thread (looper, left hand) Nipper Spring Screw.....
132591	20844	Thread (looper, left hand) Pull-off....
42344	20844	" " " " " Eyelet.
207J	20846	" " " " " " " " Screw.....

## PARTS FOR MACHINE NO. 81-72

No.	Plate	Name
42084	20845	Thread (looper, left hand) Tube.....
482C	20846	" " " " " Set Screw
132873	20844	" (looper, right hand) Controller..
42126	20844	" " " " " Pull-off....
132864	20844	" " " " " Staple.....
176J	20846	" " " " " Screw
7071	20821	" " " " " Washer.....
132812	20845	Thread (looper, right hand) Take-up....
185J	20845	" " " " " Screw.
132873	20845	" (needle) Eyelet with 52130.....
52130	20845	" " " " " Bushing.....
223J	20846	" " " " " Screw.....
132914	20845	" " " " " Take-up.....
197J	20846	" " " " " Screw.....
132875	20844	" " " " " Staple and Thread Guide with two 52130.....
52130	20845	Thread (needle) Take-up Staple and Thread Guide Bushing.....
132824	20841	Throat Plate for 132851.....
742F	20846	" " " " " Screw.....
*15404	-----	Trade Mark.....
15405	-----	" " " " " Rivet.....

Parts Required to Change from  
Three-Thread Chain Stitch to  
a Two-Thread Chain Stitch

No.	Plate	Name
228J	20846	Needle Bar Thread Retainer Bracket Screw
132631	20836	Spreader, in place of Looper (right hand) 132630.....
42082	20843	Tension (needle thread) Thread Guide, in place of 132875.....
42096	20845	Thread (needle) Eyelet, in place of 132873.....
132883	20845	Thread (needle) Take-up, in place of 132914.....

## FITTINGS

## FITTINGS FOR TRIMMING AND SERGING CLOTH, ETC.

FOR 5/32 IN. TO 7/32 IN. BIGHT

LENGTH OF STITCH UP TO 1/4 IN.

FOR TWO-THREAD STITCH

No.	Plate	Name
132818	20848	Feed Dog, 23 teeth (16 teeth to the inch) for 132825.....
121416	20848	Guide with 230J and 38572.....
38572	20835	" Smoothing Plate.....
230J	20846	" " " " " Screw.....
217F	20846	" " " " " Screw.....
7071	20821	" " " " " Washer.....
42114	20835	Looper (left hand).....
42268	20840	Presser Foot Chaining-off Finger.....
42270	-----	" " " " " Plate.....
132837	20840	Presser Foot (spring hinged) complete, Nos. 233J, 14058, 42268, 42270, 82527 and 132809 to 132812.....
132825	20848	Throat Plate for 132818.....

## FITTINGS FOR TRIMMING AND OVEREDGING BLANKETS

FOR 9/32 IN. BIGHT

No.	Plate	Name
132826	20849	Feed Dog, 18 teeth (10 teeth to the inch) for 132824.....
132827	20849	Presser Foot Chaining-off Finger.....
233J	20821	" " " " " Screw...
132809	20849	" " " " " Plate.....
132810	20841	" " " " " Collar with 240C.....
132811	20841	Presser Foot Chaining-off Plate Collar Guide Pin.....
735C	20846	Presser Foot Chaining-off Plate Collar Guide Pin Set Screw.....
240C	20846	Presser Foot Chaining-off Plate Collar Set Screw.....
42461	20842	Presser Foot Hinge Pin.....
132863	-----	" " " " " Plate.....
132865	-----	" " " " " Shank with 735C.....
14058	20840	" " " " " Spring.....
132828	20849	Presser Foot (spring hinged) complete, Nos. 233J, 14058, 42461, 132809 to 132811, 132863, 132865 and 132827....
132824	20841	Throat Plate for 132826.....

**FITTINGS FOR WORK SHIRTS**  
FOR TRIMMING AND FOLDING THE EDGE ON THE BOTTOM  
FOR 3/32 IN. BIGHT

No.	Plate	Name
132829	20850	Feed Dog, 25 teeth (16 teeth to the inch) for 132832.....
42213	7409	Knife (movable).....
42214	7409	" " Gib.....
42035	7409	" " Holder.....
132827	-----	" " " 42035 with 133F, 42037, 42040, 42214 and two 404D.....
42037	7409	Knife (movable) Holder Cap.....
404D	7409	" " " " Screw.....
132830	20850	Presser Foot Chaining-off Finger.....
233J	20821	" " " " Screw..
132809	20841	" " " " Plate.....
132810	20841	" " " " Collar with 240C.....
132811	20841	Presser Foot Chaining-off Plate Collar Guide Pin.....
735C	20846	Presser Foot Chaining-off Plate Collar Guide Pin Set Screw.....
240C	20846	Presser Foot Chaining-off Plate Collar Set Screw.....
42461	20842	Presser Foot Hinge Pin.....
132883	-----	" " Plate.....
132885	-----	" " Shank with 735C.....
14058	20840	" " Spring.....
132831	20850	Presser Foot (spring hinged) complete, Nos. 233J, 14058, 42461, 132809 to 132811, 132883, 132885 and 132830....
132832	20850	Throat Plate for 132829.....

**FITTINGS FOR WORK SHIRTS**  
FOR TRIMMING AND FOLDING THE EDGE ON THE BOTTOM  
FOR 5/32 IN. BIGHT

No.	Plate	Name
132829	20850	Feed Dog, 25 teeth (16 teeth to the inch) for 132852.....
42213	7409	Knife (movable).....
42214	7409	" " Gib.....
42035	7409	" " Holder.....
132827	-----	" " " 42035 with 133F, 42037, 42040, 42214 and two 404D.....
42037	7409	Knife (movable) Holder Cap.....
404D	7409	" " " " Screw.....

## FITTINGS FOR WORK SHIRTS

No.	Plate	Name
132853	20851	Presser Foot Chaining-off Finger.....
233J	20821	" " " " Screw..
132809	20841	" " " " Plate.....
132810	20841	" " " " Collar with 240C.....
132811	20841	Presser Foot Chaining-off Plate Collar Guide Pin.....
735C	20846	Presser Foot Chaining-off Plate Collar Guide Pin Set Screw.....
240C	20846	Presser Foot Chaining-off Plate Collar Set Screw.....
42461	20842	Presser Foot Hinge Pin.....
132883	-----	" " Plate.....
132885	-----	" " Shank with 735C.....
14058	20840	" " Spring.....
132854	20851	Presser Foot (spring hinged) complete, Nos. 233J, 14058, 42461, 132809 to 132811, 132883, 132885 and 132853....
132852	20851	Throat Plate for 132829.....

**FITTINGS FOR PLAIN WORK**  
FOR 1/8 IN. BIGHT

No.	Plate	Name
42109	20852	Feed Dog, 24 teeth (16 teeth to the inch) for 132833.....
132882	20841	Presser Foot Chaining-off Finger.....
233J	20821	" " " " Screw..
132809	20841	" " " " Plate.....
132810	20841	" " " " Collar with 240C.....
132811	20841	Presser Foot Chaining-off Plate Collar Guide Pin.....
735C	20846	Presser Foot Chaining-off Plate Collar Guide Pin Set Screw.....
240C	20846	Presser Foot Chaining-off Plate Collar Set Screw.....
62527	20840	Presser Foot Hinge Pin.....
132822	-----	" " Plate.....
132812	-----	" " Shank with 735C.....
14058	20840	" " Spring.....
132823	20841	Presser Foot (spring hinged) complete, Nos. 233J, 14058, 62527, 132809 to 132812, 132882 and 132822.....
132833	20852	Throat Plate for 42109.....

## FITTINGS FOR RAYON

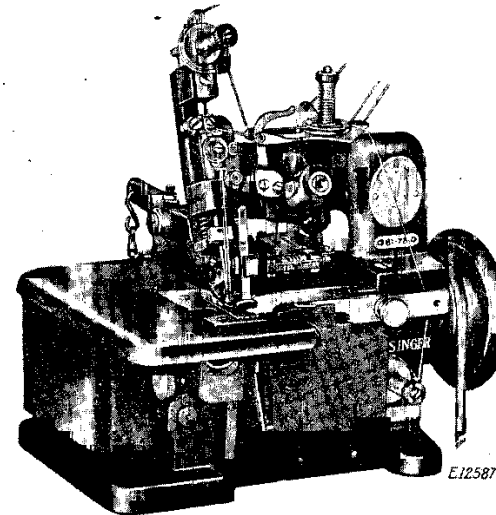
No.	Plate	Name
132859	20853	Feed Dog, 35 teeth (22 teeth to the inch) for 132861.....
132808	20853	Presser Foot Chaining-off Finger.....
233J	20821	" " " " Screw..
132809	20841	" " " " Plate.....
132810	20841	" " " " Collar with 240C.....
132811	20841	Presser Foot Chaining-off Plate Collar Guide Pin.....
735C	20846	Presser Foot Chaining-off Plate Collar Guide Pin Set Screw.....
240C	20846	Presser Foot Chaining-off Plate Collar Guide Set Screw.....
42461	20842	Presser Foot Hinge Pin.....
132883	-----	" " Plate.....
132885	-----	" " Shank with 735C.....
14058	20840	" " Spring.....
132860	20853	Presser Foot (spring hinged) complete, Nos. 233J, 14058, 42461, 132808 to 132811, 132883 and 132885.....
132861	20853	Throat Plate for 132859.....

Genuine Singer Needles should be used in Singer Machines. These Needles and their Containers are marked with the Company's Trade Mark "SIMANCO." 1

Needles in Containers marked "For Singer Machines" are not Singer made needles. 2

## LIST OF PARTS COMPLETE

FOR



MACHINE No. 81-78

For Trimming and Overedging Flannels, Muslin, Denim and other Fabrics, for House-dresses, etc; also for Sewing Pockets in Trousers up to 3/16 inch in thickness. Two needles, two loopers. Gauge 3/32 inch. Improved Thread Control. Four-thread stitch (one reinforcing stitch inside of the overedge seam). Width of seam 7/32 inch. Foot lifter. Needle bar stroke 7/8 inch. Speed 4500 R. P. M. for long runs.

No.	Plate	Name
*132724	-----	Arm with 15404, 132580, 132739 and two each 462C, 624C, 15405 and 132589....
4389	20821	Arm Dowel Pin.....
68350	20821	" Oil Cup.....
949E	20846	" Screw.....
132832	20833	Balance Wheel, 1 7/8 in. pulley, with 446C and 1285C.....
1285C	20807	Balance Wheel Position Screw.....
446C	7409	" " Set Screw.....
132854	20833	Chip Guard.....
132524	20808	Cloth Plate with 132525.....
132801	20808	" " Extension (lower).....
233E	20821	" " " " Screw.....
42108	20821	" " " " (upper).....
233E	20821	" " " " Screw.....

No.	Plate	Name
*132525	-----	Cloth Plate Hinge Bracket.....
132526	20821	" " " Stud.....
50150C	20821	" " " Set Screw.....
42005	20821	" " Lock Spring.....
236C	20821	" " Screw.....
132527	-----	Cloth Plate complete, Nos. 42005, 42108, 132524, 132601, two 236C and five 233E.....
42006	20831	Feed Bar with 1253C.....
132641	-----	" " 42006 with 132539.....
132528	20831	" " Hinge Pin.....
1253C	20846	" " Set Screw.....
132529	7407	" Connecting Rod with 171C, 1695J and two 1057C.....
132619	-----	Feed Connecting Rod 132529 with 132534..
1057C	7407	" " Cap Screw.....
51292C	7407	" " Hinge Screw.....
171C	7407	" " Clamping Screw.....
1695J	7407	Feed Connecting Rod Hinge Screw Clamping Screw Nut.....
1520J	5569	Feed Connecting Rod Hinge Screw Nut....
132905	20842	" Dog, 25 teeth (16 teeth to the inch) for 3/32 in. gauge, for 132917, for pants pockets and dress material...
190J	20846	Feed Dog Screw.....
*132531	-----	" Eccentric.....
*132702	-----	" Body.....
1036C	5569	" " Set Screw.....
19047	7407	" " Clamping Washer.....
801J	7407	" " Screw....
132533	7407	" Oil Tube.....
132534	7407	Feed Eccentric complete, Nos. 201J, 19047, 51145C, 132531, 132533, 132702 and two 1036C.....
132651	7407	Feed Eccentric Cover.....
50253J	7407	" " Screw.....
132712	20831	" " Lint Cover (spring).....
132785	20831	" " Lubricator with 132537...
132537	20831	" " Oil Wick (braided cotton).....
132649	20832	Feed Lifting Eccentric with two 462C....
132539	20832	" " Connection.....
462C	20846	" " Set Screw.....
51145C	7407	" Regulating Screw.....
132625	20832	" Rock Shaft.....
132626	-----	Feed Rock Shaft complete, Nos. 42021 and 132625.....
42021	20832	Feed Rock Shaft Crank with 157E.....
157E	5569	" " Clamping Screw....
132542	20832	" " Hinge Pin with 132544....
132543	20832	" " Bushing.....

No.	Plate	Name
132816	20823	Feed Rock Shaft Hinge Pin Bushing Oil Wick (wick).....
1036C	5569	Feed Rock Shaft Hinge Pin Bushing Set Screw.....
132544	20832	Feed Rock Shaft Hinge Pin Oil Wick (braided cotton).....
*132545	-----	Frame.....
132546	20808	" Bottom Cover with 132594.....
132547	20808	" " Gasket.....
190E	20846	" " Screw.....
132548	20821	" Oil Cup.....
132819	20833	" Rotary Shaft with 132558 and 132559.....
132820	-----	Frame Rotary Shaft 132819 with 132774, 132790, 132802 and 132806.....
132790	20834	Frame Rotary Shaft Ball Sleeve.....
132774	20817	" " Guide....
*132862	-----	" " Bushing (front).....
132863	20817	" " 132862 with 132835, 132864 and two 132715..
132864	20823	Frame Rotary Shaft Bushing (front) Oil Pad (braided cotton).....
132715	20817	Frame Rotary Shaft Bushing (front) Oil Pad Retainer.....
132817	20823	Frame Rotary Shaft Bushing (front) Oil Wick (wick).....
51332C	20821	Frame Rotary Shaft Bushing (front) Set Screw.....
132769	20817	Frame Rotary Shaft Crank with 1036C, 1375C and 132773.....
132770	20817	Frame Rotary Shaft Crank Ball Sleeve....
132771	20817	" " Bush- ing.....
1664E	20817	Frame Rotary Shaft Crank Ball Sleeve Bushing Nut.....
132772	20817	Frame Rotary Shaft Crank Ball Sleeve Bushing Nut Washer.....
132773	20846	Frame Rotary Shaft Crank Ball Sleeve Bushing Position Pin.....
132774	20817	Frame Rotary Shaft Crank Ball Sleeve Guide.....
132775	-----	Frame Rotary Shaft Crank complete, Nos. 1664E and 132769 to 132772.....
132835	20817	Frame Rotary Shaft Crank Oil Sling Cover
1375C	20817	" " Position Screw.
1036C	5569	" " Set Screw.....
*132865	20833	" " Flanged Bushing (back)
132866	-----	" " 132865 with 132892, 132867, 132868 and two 132603.....
132867	20823	Frame Rotary Shaft Flanged Bushing (back) Oil Pad, large.....

No.	Plate	Name
132868	20823	Frame Rotary Shaft Flanged Bushing (back) Oil Pad, small (braided cotton).....
132603	20834	Frame Rotary Shaft Flanged Bushing (back) Oil Pad Retainer.....
132817	20823	Frame Rotary Shaft Flanged Bushing (back) Oil Wick (wick).....
51332C	20821	Frame Rotary Shaft Flanged Bushing (back) Set Screw.....
132558	20823	Frame Rotary Shaft Oil Pad (braided cotton).....
132559	20823	Frame Rotary Shaft Oil Pad Retainer.....
132692	20834	" " " Sling Cover.....
132906	20833	" Side Cover (left) with 132701.....
132701	20821	" " " Handle.....
330W	20821	" " " Screw.....
42028	20833	" " " (right) hinged.....
42101	20821	" " " Lock Spring....
330W	20821	" " " Screw.....
132780	20808	" Top Cover.....
132781	-----	" " 132780 with 132782 to 132784 and two 197J.....
132650	7409	Frame Top Cover Extension.....
42102	7409	" " " Holder.....
132600	-----	" " " 42102 with 42101, 132650, 132651 and two each 176J and 50253J.....
283W	7409	Frame Top Cover Extension Holder Thumb Screw.....
19044	7407	Frame Top Cover Extension Holder Thumb Screw Washer.....
176J	20846	Frame Top Cover Extension Screw.....
132782	20821	" " " Oil Reservoir Cover....
197J	20846	" " " " Screw
132783	20821	" " " Tube.....
132784	20821	" " " Wick.....
583F	20846	" " " Screw (large).....
742F	20846	" " " (small).....
42305	20818	Knife (movable).....
Note: Two No. 42305 are sent with this machine.		
42306	20818	Knife (movable) Gib.....
42307	20818	" " Holder.....
42308	-----	" " 42307 with 133F, 42040 and 42306.....
42038	7409	Knife (movable) Holder Guide with 336F..
42039	7409	" " " Plate.....
621E	7409	" " " Screw.....
336F	7409	" " " Set Screw..
133F	7409	" " " Screw.....
42040	7409	" " " Extension Pin.....
42041	7409	Knife (movable) Holder Spring.....

No.	Plate	Name
132821	20834	Knife (movable) Lever with 175E.....
132563	20834	" " " Connection with two 1057C.....
132620	-----	Knife (movable) Lever Connection 132563 with 132649.....
1057C	7407	Knife (movable) Lever Connection Cap Screw.....
132565	20834	Knife (movable) Lever Connection Hinge Stud.....
175E	20846	Knife (movable) Lever Connection Hinge Stud Set Screw.....
42045	20834	Knife (movable) Lever Hinge Stud.....
1229C	20846	" " " Set Screw
42309	20818	" (stationary) with 42049.....
Note: Two No. 42309 are sent with this machine.		
42310	20818	Knife (stationary) Clamping Stud.....
1534D	20818	" " " Thumb Nut.....
132787	20818	Knife (stationary) Holder.....
1376C	20818	" " " Regulating Thumb Screw.....
1101C	20807	Knife (stationary) Holder Screw.....
440C	7409	" " " Stop Screw....
1547J	7409	" " " Nut
42049	20818	" " " Stud.....
42050	20835	Looper (left hand).....
50117C	20846	" " " Clamping Screw.....
132795	20835	" " " Lever with 50117C....
132796	20835	" " " Connecting Link
132797	20835	" " " Hinge Pin.....
51459E	20835	Looper (left hand) Lever Connecting Link Screw.....
1735J	20835	Looper (left hand) Lever Connecting Link Screw Nut.....
132798	20835	Looper (left hand) Lever Hinge Stud with 132552.....
132552	20835	Looper (left hand) Lever Hinge Stud Oil Pad (braided cotton).....
132818	20823	Looper (left hand) Lever Hinge Stud Oil Wick (wick).....
1036C	5569	Looper (left hand) Lever Hinge Stud Set Screw.....
132907	20836	Looper (right hand).....
132799	20836	" " " and Spreader Lever with 233E, 241E and 140123C.....
132800	-----	Looper (right hand) and Spreader Lever 132799 with 132699.....
132801	-----	Looper (right hand) and Spreader Lever 132800 with 42243, 132795, 132798 and two each 1735J, 51459E, 132796 and 132797.....



## PARTS FOR MACHINE NO. 81-78

No.	Plate	Name
132802	20817	Looper (right hand) and Spreader Lever Ball Stud.....
140123C	20846	Looper (right hand) and Spreader Lever Ball Stud Set Screw.....
132777	20817	Looper (right hand) and Spreader Lever Connection with four 896C.....
132779	-----	Looper (right hand) and Spreader Lever Connection 132777 with 132774, 132775 and 132802.....
896C	20817	Looper (right hand) and Spreader Lever Connection Cap (lower) Screw.....
896C	20817	Looper (right hand) and Spreader Lever Connection Cap (upper) Screw.....
132699	20836	Looper (right hand) and Spreader Lever Hinge Pin with 125056.....
132543	20832	Looper (right hand) and Spreader Lever Hinge Pin Bushing.....
132816	20823	Looper (right hand) and Spreader Lever Hinge Pin Bushing Oil Wick (wick)..
1036C	5569	Looper (right hand) and Spreader Lever Hinge Pin Bushing Set Screw.....
125056	20836	Looper (right hand) and Spreader Lever Hinge Pin Oil Wick (braided cotton)
1036C	5569	Looper (right hand) and Spreader Lever Hinge Pin Set Screw.....
241E	20846	Looper (right hand) and Spreader Lever Oil Plug Screw.....
197J	20846	Looper (right hand) Screw.....
132908	20837	Needle Bar (hollow).....
132909	-----	Needle Bar complete, for 3/32 in. gauge, Nos. 132908 and 132910.....
132739	20837	Needle Bar Bushing (lower).....
132580	20837	" " " (upper).....
132581	20837	" " " Oil Pad (braided cotton).....
462C	20846	Needle Bar Bushing Set Screw.....
132740	20837	" " Connecting Bracket with 223F and 1057C.....
1057C	7407	Needle Bar Connecting Bracket Clamping Screw.....
132582	20837	Needle Bar Connecting Link.....
132583	20837	" " " Hinge Pin with 132584.....
132584	20837	Needle Bar Connecting Link Hinge Pin Oil Pad (wick).....
223F	20846	Needle Bar Connecting Link Hinge Pin Set Screw for 132740.....
620C	20846	Needle Bar Connecting Link Hinge Pin Set Screw for 132880.....
132808	20838	Needle Bar Connecting Rod with four 896C
896C	20817	" " " Cap (lower) Screw.....

## PARTS FOR MACHINE NO. 81-78

No.	Plate	Name
896C	20817	Needle Bar Connecting Rod Cap (upper) Screw.....
132879	20838	Needle Bar Crank (back) with 132590 and two 1259C.....
132802	20817	Needle Bar Crank (back) Ball Stud.....
1259C	20846	" " " " " Set Screw.....
132589	20838	Needle Bar Crank (back) Bushing.....
624C	20846	" " " " " Set Screw.
132590	20838	" " " " Oil Pad (wick)..
1259C	20846	" " " " Set Screw.....
132880	20838	" " " (front) with 620C, 50200C and 140123C.....
132881	-----	Needle Bar Crank (front) 132880 with 132582, 132740 and two 132583.....
140123C	20846	Needle Bar Crank (front) Position Screw.
50200C	20846	" " " " Set Screw.....
42115	20838	" " Thread Retainer Bracket.....
42483	20838	" " " " Disc.....
93C	20846	" " " " Screw.....
10107	20838	" " " " Spring.....
132910	20837	" Clamp with two 50014F, for 3/32 in. gauge.....
42066	20838	Needle Guard.....
171F	7407	" Screw.....
50014F	20846	" Set Screw.....
42172	20842	Presser Foot Chaining-off Finger.....
233J	20821	" " " " Screw..
132609	20841	" " " " Plate.....
132610	20841	" " " " Collar with 240C.....
132611	20841	Presser Foot Chaining-off Plate Collar Guide Pin.....
735C	20846	Presser Foot Chaining-off Plate Collar Guide Pin Set Screw.....
240C	20846	Presser Foot Chaining-off Plate Collar Set Screw.....
62527	20840	Presser Foot Hinge Pin.....
132822	-----	" " Plate.....
132612	-----	" " Shank with 735C.....
14058	20840	" " Spring.....
132911	20842	Presser Foot (hinged) complete, for pants pockets, Nos. 233J, 14058, 42172, 62527, 132609 to 132612 and 132822.....
42404	20842	Presser Foot Chaining-off Finger.....
233J	20821	" " " " Screw..
132609	20841	" " " " Plate.....
132610	20841	" " " " Collar with 240C.....
132611	20841	Presser Foot Chaining-off Plate Collar Guide Pin.....
735C	20846	Presser Foot Chaining-off Plate Collar Guide Pin Set Screw.....



No.	Plate	Name
50093E	20842	Throat Plate Chaining-off Finger Screw..
132917	-----	Throat Plate complete, for 3/32 in. gauge, for 132905, for pants pockets and dress materials, Nos. 50093E, 132915 and 132916.....
742F	20846	Throat Plate Screw.....
*15404	-----	Trade Mark.....
15405	-----	" " Rivet.....

Genuine Singer Needles should be used  
in Singer Machines.  
These Needles and their Containers  
are marked with the  
Company's Trade Mark "SIMANCO." 1

Needles in Containers marked  
"For Singer Machines"  
are not Singer made needles. 2

## ACCESSORIES

No.	Plate	Name
1408J	20826	Machine Base Thumb Screw, for 1 5/8 in. tables and Individual Stands, for use when machine is mounted on top of table.....
474J	20826	Machine Base Thumb Screw, for use when machine is mounted 1 1/2 in. lower than standard.....
14063	20807	Machine Base Thumb Screw Spring, for Thumb Screw No. 1408, when machine is mounted on Individual Stand.....
27498	20826	Machine Base Thumb Screw Spring, for Thumb Screw No. 1408 on 1 5/8 in. Tables and Thumb Screw No. 474, when machine is mounted 1 1/2 in. lower than standard.....
9842	7419	Machine Base Thumb Screw Spring Washer..
132602	20807	" " " Washer.....
120344	5566	Oiler (copper plated) with 120345.....
120345	5566	" Spout, 4 1/2 in. long.....
120440	5566	Screw Driver.....
121108	20845	" " for 81-78 Machine.....
42090	5566	Threading Wire.....
120341	5566	Tweezers (curved).....
42089	5566	Wrench for 1324.....
8908	5566	" " 1520.....
4822	5566	" " 1547.....

## BENCH STANDS

## BENCH STAND

FOR MACHINE BASE NO. 132592

WHEN MACHINE IS MOUNTED ON TOP OF TABLE

No.	Plate	Name
79788	-----	Bench Stand with 27998, two each 28291, 46548 and wood screws 1 1/2 in. No. 14 F.H.....
28291	20807	Cover Hinge with two each wood screws 1/2 in. No. 5 F.H. and 5/8 in. No.5 F.H.....
27998	20807	Cover Hook and Eye (brass) with wood screw 1/2 in. No. 5 F.H.....
46548	20807	Cover Rest (felt).....

## BENCH STAND

FOR MACHINE BASE NO. 132656

WHEN MACHINE IS MOUNTED 1 1/2 IN. LOWER THAN STANDARD

No.	Plate	Name
79790	-----	Bench Stand with 27998, 60820, two each 28291, 46548, 150244 and three each wood screws 1 1/4 in. No. 12 F.H. and 1 1/2 in. No. 14 F.H.....
60820	-----	Cover Chain, 9 1/4 in. long with two 56865.....
56865	20807	Cover Chain Hook.....
150244	20826	" " Screw Eye.....
28291	20807	" Hinge with two each wood screws 1/2 in. No. 5 F.H. and 5/8 in. No. 3 F.H.....
27998	20807	Cover Hook and Eye (brass) with wood screw 1/2 in. No. 5 F.H.....
46548	20807	Cover Rest (felt).....

## FOOT LIFTER PARTS

No.	Plate	Name
6439	-----	Chain, 36 in. to 45 in., with 56864 and 56865.....
Note: When ordering No. 6439, state length required.		
4879	5566	Chain Connecting Link.....
56864	5566	" Hook (large).....
56865	20807	" " (small).....
42130	20824	Lifting Lever.....
42131	20824	" " Bracket.....
1229C	20846	" " " Screw.....
1301D	20824	" " Hinge Screw.....
42132	20824	" " Spring.....
1148F	20824	" " Stop Screw.....
1547J	7409	" " " Nut.....
4881	20808	Treadle.....
4882	5566	" Shaft.....
4883	5566	" Spring.....
4884	20808	" Stand.....
4885	20808	Treadle complete, Nos. 4879, 4881 to 4884 and two wood screws 1 in. No. 18...
42133	-----	Foot Lifter complete, Nos. 1301D, 4885, 6439 42130 to 42132 and two each 1148F, 1229C and 1547J.....

## KNEE LIFTER PARTS

No.	Plate	Name
42130	20824	Lifting Lever.....
42131	20824	" " Bracket.....
1229C	20846	" " " Screw.....
42142	20808	" " Connecting Rod.....
1301D	20824	" " Hinge Screw.....
42132	20824	" " Spring.....
1148F	20824	" " Stop Screw.....
1547J	7409	" " " Nut.....
2783	20808	Rock Shaft.....
12242	20808	" " Hanger with two wood screws 1 in. No. 10.....
2765	20808	Rock Shaft Knee Arm.....
2766	20808	" " " " Hub with 356C.....
356C	20807	" " " " Set Screw.....
2768	-----	Rock Shaft Knee Arm complete, Nos. 2765 to 2767.....
2767	20808	Rock Shaft Knee Plate with 356C.....
356C	20807	" " " " Set Screw.....
6337	20808	" " Lifting Bracket with two 356C.....
7125	20808	" " " " Hook.....
356C	20807	" " " " Set Screw.....
356C	20807	" " " " Set Screw.....
2770	20808	" " Stop Dog with 356C.....
356C	20807	" " " " Set Screw.....
42143	20808	Rock Shaft complete, Nos. 2763, 2768, 6337, 7125 and two each 2770 and 12242...
42144	-----	Knee Lifter complete, Nos. 1301D, 42130 to 42132, 42142, 42143 and two each 1148F, 1229C and 1547J.....

## KNIFE GRINDER

FOR 81-72 AND 81-78 MACHINES

No.	Plate	Name
41326	20847	Emery Wheel.....
1508C	5569	" " Clamping Nut.....
41327	20847	" " Shaft.....
41328	20847	" " " Pulley with 1036C.....
1036C	5569	" " " Set Screw.....
41513	5569	" " Washer.....
41329	20830	Frame with 1036C.....
878D	5569	" Oil Hole Stop Screw.....
41818	20847	Knife Holder with two 14222.....
150210	-----	" " 41818 with 970D, 41331, 41332 and two each 313C, 771D, 1519J, 41333 and 41334.....

## KNIFE GRINDER

No.	Plate	Name
41331	20847	Knife Holder Bracket with 157E.....
157E	5569	" " " Clamping Screw.....
42065	5569	" " " Hinge Stud.....
1036C	5569	" " " " " Set Screw
717C	5569	" " " Stop Screw.....
1520J	5569	" " " " " Nut.....
41333	5569	" " " Clamp.....
41334	5569	" " " Spring.....
14222	5569	" " " Steady Pin.....
771D	5569	" " " Thumb Screw.....
970D	5569	" " " Regulating Thumb Screw.....
313C	5569	" " " Screw Center.....
1519J	5569	" " " " " Nut.....
41332	5569	" " " Spring.....
41819	-----	Knife Grinder complete, Nos. 717C, 1508C, 1520J, 41328 to 41329, 42065, 150210, two each 878D, 41513 and three wood screws 1 1/4 in. No. 12.....

## MACHINE BASES

## MACHINE BASE No. 132592

WHEN MACHINE IS MOUNTED ON TOP OF TABLE  
FOR USE WITH BENCH STAND NO. 79768

No.	Plate	Name
132647	20808	Machine Base.....
132595	7419	" " " Cushion (large) felt.....
42088	7419	" " " " (small) felt.....
132618	7419	" " " " " " for 474 or 1408.....
935E	7419	Machine Base Cushion (small) Screw.....
132596	7419	" " " " (leather).....
132593	7419	" " " Oil Drain Strainer.....
54477	7419	" " " Screw Stud.....
51576E	7419	" " " " " Nut.....
9842	7419	" " " " " Washer.....
132594	7419	" " " Thumb Screw Bushing.....
132592	-----	Machine Base complete, Nos. 132593, 132596, 132618, 132647, three each 9842, 51576E, 54477 and four each 935E, 42088 and 132595.....
132704	-----	Machine Base and Oil Drain Jar complete, Nos. 131268 and 132592.....

## MACHINE BASE No. 132656

WHEN MACHINE IS MOUNTED 1 1/2 IN. LOWER THAN STANDARD  
FOR USE WITH BENCH STAND NO. 79790

No.	Plate	Name
132655	20830	Machine Base.....
132595	7419	" " " Cushion (large) felt.....
42088	7419	" " " " (small) felt.....
132618	7419	" " " " " " for 474 or 1408.....
935E	7419	Machine Base Cushion (small) Screw.....
132596	7419	" " " " (leather).....
132593	7419	" " " Oil Drain Strainer.....
1204E	20824	" " " Position Stud.....
131022	20824	" " " " " Bushing (rub- ber).....
132594	7419	Machine Base Thumb Screw Bushing.....
132656	-----	Machine Base complete, Nos. 132593, 132596, 132618, 132655, three each 1204E, 131022 and four each 935E, 42088 and 132595.....
132705	-----	Machine Base and Oil Drain Jar complete, Nos. 132656 and 132697.....

## MACHINE BASE OIL DRAIN JARS

## MACHINE BASE OIL DRAIN JAR

(SWINGING TYPE)

OIL DRAIN JAR NO. 131268

FOR MACHINE BASE NO. 132592

FOR BENCH STAND NO. 79768

No.	Plate	Name
131185	20828	Jar (glass).....
131191	20828	" Cap.....
131188	20828	" Clamp.....
131217	-----	" " 131188 with 131189.....
131189	20828	" " Lever.....
1247C	20824	" " " Hinge Screw.....
131265	20828	Nipple (long).....
131266	20828	" (short).....
131267	20828	" Elbow.....
131268	-----	Machine Base Oil Drain Jar (swinging type) complete, Nos. 131185, 131191, 131217, 131266 and two each 1247C, 131265 and 131267.....

## MACHINE BASE OIL DRAIN JAR

(SWINGING TYPE)

OIL DRAIN JAR NO. 132697

FOR MACHINE BASE NO. 132656

FOR BENCH STAND NO. 79790

No.	Plate	Name
131185	20828	Jar (glass).....
131191	20828	" Cap.....
131188	20828	" Clamp.....
131217	-----	" " 131188 with 131189.....
131189	20828	" " Lever.....
1247C	20824	" " Hinge Screw.....
131285	20828	Nipple (long).....
131286	20828	" (short).....
131287	20828	" Elbow.....
132697	-----	Machine Base Oil Drain Jar (swinging type) complete, Nos. 131185, 131191, 131217, 131285 and two each 1247C, 131286 and 131287.....

## THREAD UNWINDERS

## THREAD UNWINDER

FOR TWO SPOOLS

FOR 81-65 MACHINE

No.	Plate	Name
225257	20787	Spool Rest (for two spools) with 201018C
150203	20778	" " Cushion (felt).....
225388	20787	" " Rod.....
200383C	20807	" " Set Screw.....
201018C	20807	" " Set Screw.....
202490	20787	" Stand with 200383C.....
225391	20787	Thread Guide.....
201696J	20807	" " Lock Nut.....
225326	20807	" " Position Cup.....
225324	20787	" " Rod with 208E and 225322...
208E	7409	" " Screw.....
225322	20807	" " Washer.....
*150085	-----	" Separator.....
150086	20787	" " 150085 with 150059.....
*150059	-----	" Bracket.....
150060	20787	" " Arm with 164J and 9525.....
164J	20807	Thread Separator Bracket Arm Clamping Screw.....

## THREAD UNWINDER

41

No.	Plate	Name
9525	20807	Thread Separator Bracket Arm Clamping Screw Washer.....
164J	20807	Thread Separator Bracket Screw.....
9525	20807	" " " Washer...
150087	-----	Thread Separator complete, Nos. 164J, 9525, 150060 and 150086.....
150088	20787	Thread Unwinder complete, Nos. 150087, 201696J, 202490, 225257, 225324, 225326 225388, two each 150203, 225391 and three wood screws 7/8 in. No. 12...
27739	20778	Thread Cone (wood) for large cones.....
225390	20778	" " Holder, for inverted cones..

Note: Nos. 27739 and 225390 are used with, but not included in 150088.

## THREAD UNWINDER

FOR THREE SPOOLS

FOR 81-72 MACHINE

No.	Plate	Name
225259	20778	Spool Rest (for one spool) with 201018C.
225257	20787	" " (for two spools) with 201018C
150203	20778	" " Cushion (felt).....
225388	20787	" " Rod.....
200383C	20807	" " Set Screw.....
201018C	20807	" " Set Screw.....
202490	20787	" Stand with 200383C.....
225391	20787	Thread Guide.....
201696J	20807	" " Lock Nut.....
225326	20807	" " Position Cup.....
225324	20787	" " Rod with 208E and 225322...
208E	7409	" " Screw.....
225322	20807	" " Washer.....
*150057	-----	" Separator.....
150058	20778	" " 150057 with 150059.....
*150059	-----	" Bracket.....
150060	20787	" " Arm with 164J and 9525.....
164J	20807	Thread Separator Bracket Arm Clamping Screw.....
9525	20807	Thread Separator Bracket Arm Clamping Screw Washer.....
164J	20807	Thread Separator Bracket Screw.....
9525	20807	" " " Washer...
150061	-----	Thread Separator complete, Nos. 164J, 9525, 150058 and 150060.....

## THREAD UNWINDER

No.	Plate	Name
150178	20778	Thread Unwinder complete, Nos. 150061, 201696J, 202490, 225257, 225259, 225324, 225326, 225388 and three each 150203, 225391 and wood screws 7/8 in. No. 12
27739	20778	Thread Cone (wood) for large cones.....
225390	20778	" " Holder, for inverted cones..

Note: Nos. 27739 and 225390 are used with, but not included in 150178.

## THREAD UNWINDER

FOR FOUR SPOOLS  
FOR 81-78 MACHINE

No.	Plate	Name
225257	20787	Spool Rest (for two spools) with 201018C
150203	20778	" " Cushion (felt).....
225388	20787	" " Rod.....
200383C	20807	" " " Set Screw.....
201018C	20807	" " Set Screw.....
202490	20787	" Stand with 200383C.....
225391	20787	Thread Guide.....
201696J	20807	" " Lock Nut.....
225326	20807	" " Position Cup.....
225324	20787	" " Rod with 208E and 225322...
208E	7409	" " Screw.....
225322	20807	" " Washer.....
*150057	-----	" Separator.....
150058	20778	" " 150057 with 150059.....
*150059	-----	" " Bracket.....
150060	20787	" " " Arm with 164J and 9525.....
164J	20807	Thread Separator Bracket Arm Clamping Screw.....
9525	20807	Thread Separator Bracket Arm Clamping Screw Washer.....
164J	20807	Thread Separator Bracket Screw.....
9525	20807	" " " Washer...
150061	-----	Thread Separator complete, Nos. 164J, 9525, 150058 and 150060.....
150062	9505	Thread Unwinder complete, Nos. 150061, 201696J, 202490, 225324, 225326, 225388 two 225257, three wood screws 7/8 in. No. 12 and four each 150203 and 225391.....
27739	20778	Thread Cone (wood) for large cones.....
225390	20778	" " Holder, for inverted cones..

Note: Nos. 27739 and 225390 are used with, but not included in 150062.

## NUMERICAL LIST OF PARTS

No.	Plate	Name
85D	20839	Presser Lever Lifter Hinge Screw.....
93C	20846	Needle Bar Thread Retainer Screw.....
133F	7409	Knife (movable) Holder Screw, for 42308 and 132627.....
157E	5569	Feed Rock Shaft Crank Clamping Screw, for 42021.....
157E	5569	Knife Grinder Knife Holder Bracket Clamping Screw, for 41331.....
164J	20807	Thread Unwinder Thread Separator Bracket Arm Clamping Screw, for 150060.....
164J	20807	Thread Unwinder Thread Separator Bracket Screw, for 150061 and 150087.....
171C	7407	Feed Connecting Rod Hinge Screw Clamping Screw, for 132529.....
171F	7407	Needle Guard Screw.....
175E	20846	Knife (movable) Lever Connection Hinge Stud Set Screw, for 132821.....
176J	20846	Frame Top Cover Extension Screw, for 132800.....
176J	20846	Thread (looper, left hand) Nipper Spring Screw, for 81-72 and 81-78 Machines.
176J	20846	Thread (looper, right hand) Staple Screw, for 81-72 and 81-78 Machines.....
185J	20845	Thread (looper, right hand) Take-up Screw for 81-72 and 81-78 Machines.....
187E	20846	Needle Bar Connecting Bracket Clamping Screw, for 132598.....
190J	20846	Feed Dog Screw.....
190E	20846	Frame Bottom Cover Screw.....
193J	20843	Tension (needle, left hand) Bracket and Thread Eyelet Screw, for 81-78 Machine.....
197J	20846	Frame Top Cover Oil Reservoir Cover Screw, for 132781 and 132787.....
197J	20846	Looper (right hand) Screw, for 81-72 and 81-78 Machines.....
197J	20846	Spreader Screw, for 81-65 and 81-72 Machine.....
197J	20846	Thread (needle) Take-up Screw.....
201J	7407	Feed Eccentric Clamping Washer Screw, for 132534 and 132644.....
207J	20846	Thread (looper, left hand) Pull-off Eyelet Screw, for 81-72 and 81-78 Machines.....
208E	7409	Thread Unwinder Thread Guide Rod Screw, for 225324.....
217F	20846	Guide Screw, for 81-65 and 81-72 Machines
217J	20846	Needle Bar Bushing (upper) Oil Rod Cover Screw, for 81-72 Machine.....

## NUMERICAL LIST OF PARTS

No.	Plate	Name
223F	20846	Needle Bar Connecting Link Hinge Pin Set Screw, for 132598 and 132740.....
223J	20846	Thread (needle) Eyelet Screw.....
228J	20846	Needle Bar Thread Retainer Bracket Screw for 81-65 and 81-72 Machines.....
230J	20846	Guide Smoothing Plate Screw, for 38571 and 121416.....
233E	20821	Cloth Plate Extension (lower) Screw, for 132527.....
233E	20821	Cloth Plate Extension (upper) Screw, for 132527.....
233J	20821	Presser Foot Chaining-off Finger Screw, for 132637, 132823, 132828, 132831, 132854, 132860, 132911 and 132912....
233E	20821	Thread (looper, left hand) Eyelet Screw, for 132799.....
236C	20821	Cloth Plate Lock Spring Screw, for 132527
240C	20846	Presser Foot Chaining-off Plate Collar Set Screw, for 132610.....
241E	20846	Looper (right hand) and Spreader Lever Oil Plug Screw, for 132799.....
283W	7409	Feed Eccentric Cover Holder Thumb Screw, for 81-65 Machine.....
283W	7409	Frame Top Cover Extension Holder Thumb Screw, for 81-72 and 81-78 Machines
313C	5569	Knife Grinder Knife Holder Screw Center, for 150210.....
330W	20821	Frame Side Cover (left) Screw.....
330W	20821	" " (right) Lock Spring Screw, for 81-65 Machine.....
330W	20821	Frame Side Cover (right) Screw.....
336F	7409	Knife (movable) Holder Guide Set Screw, for 42038.....
356C	20807	Rock Shaft Knee Arm Hub Set Screw, for 2766.....
356C	20807	Rock Shaft Knee Plate Set Screw, for 2767
356C	20807	" " Lifting Bracket Hook Set Screw, for 6337.....
356C	20807	Rock Shaft Lifting Bracket Set Screw, for 6337.....
356C	20807	Rock Shaft Stop Dog Set Screw, for 2770..
404D	7409	Knife (movable) Holder Cap Screw, for 132627.....
440C	7409	Knife (stationary) Holder Stop Screw, for 81-72 and 81-78 Machines.....
446C	7409	Balance Wheel Set Screw, for 132632.....
462C	20846	Feed Lifting Eccentric Set Screw, for 132635 and 132649.....
462C	20846	Needle Bar Bushing Set Screw, for 132522 and 132724.....
462C	20846	Thread (looper, left hand) Tube Set Screw

## NUMERICAL LIST OF PARTS

No.	Plate	Name
474J	20828	Machine Base Thumb Screw, for use when machine is mounted 1 1/2 inch lower than standard (Accessories).....
583F	20846	Frame Top Cover Screw (large).....
620C	20846	Needle Bar Connecting Link Hinge Pin Set Screw, for 132880.....
621E	7409	Knife (movable) Holder Guide Plate Screw for 81-72 and 81-78 Machines.....
624C	20846	Needle Bar Crank (back) Bushing Set Screw, for 132522 and 132724.....
717C	5569	Knife Grinder Knife Holder Bracket Stop Screw, for 41819.....
735C	20846	Presser Foot Chaining-off Plate Collar Guide Pin Set Screw, for 132612 and 132685.....
742F	20846	Frame Top Cover Screw (small).....
742F	20846	Throat Plate Screw.....
771D	5569	Knife Grinder Knife Holder Clamp Thumb Screw, for 150210.....
878D	5569	Knife Grinder Frame Oil Hole Stop Screw, for 41819.....
896C	20817	Looper (right hand) and Spreader Lever Connection Cap (lower) Screw, for 132777.....
896C	20817	Looper (right hand) and Spreader Lever Connection Cap (upper) Screw, for 132777.....
896C	20817	Needle Bar Connecting Rod Cap (lower) Screw, for 132806.....
896C	20817	Needle Bar Connecting Rod Cap (upper) Screw, for 132806.....
935E	7419	Machine Base Cushion (small) Screw, for 132592 and 132656.....
949E	20846	Arm Screw.....
970D	5569	Knife Grinder Knife Holder Regulating Thumb Screw, for 150210.....
1036C	5569	Feed Eccentric Body Set Screw, for 132534 and 132644.....
1036C	5569	Feed Rock Shaft Hinge Pin Bushing Set Screw.....
1036C	5569	Frame Rotary Shaft Crank Set Screw, for 132769.....
1036C	5569	Knife Grinder Emery Wheel Shaft Pulley Set Screw, for 41328.....
1036C	5569	Knife Grinder Knife Holder Bracket Hinge Stud Set Screw, for 41329.....
1036C	5569	Looper (left hand) Lever Hinge Stud Set Screw.....
1036C	5569	Looper (right hand) and Spreader Lever Hinge Pin Bushing Set Screw.....
1036C	5569	Looper (right hand) and Spreader Lever Hinge Pin Set Screw.....



## NUMERICAL LIST OF PARTS

No.	Plate	Name
1057C	7407	Feed Connecting Rod Cap Screw, for 132529
1057C	7407	Knife (movable) Lever Connection Cap Screw, for 132583.....
1057C	7407	Needle Bar Connecting Bracket Clamping Screw, for 132740.....
1101C	20807	Knife (stationary) Holder Screw, for 81-72 and 81-78 Machines.....
1101C	20807	Needle Guard Holder Screw, for 81-65 Machine.....
1120C	20846	Presser Lever Hinge Stud Set Screw.....
1148F	20824	Lifting Lever Stop Screw, for 42133 and 42144.....
1204E	20824	Machine Base Position Stud, for 132656..
1229C	20846	Knife (movable) Lever Hinge Stud Set Screw, for 81-72 and 81-78 Machines
1229C	20846	Lifting Lever Bracket Screw, for 42133 and 42144.....
1247C	20824	Machine Base Oil Drain Jar Clamp Lever Hinge Screw, for 131268 and 132697.
1253C	20846	Feed Bar Hinge Pin Set Screw, for 42006 and 42205.....
1259C	20846	Needle Bar Crank (back) Ball Stud Set Screw, for 132879.....
1259C	20846	Needle Bar Crank (back) Set Screw.....
1285C	20807	Balance Wheel Position Screw, for 132632
1301D	20824	Lifting Lever Hinge Screw, for 42133 and 42144.....
1324C	20824	Presser Foot Screw.....
1375C	20817	Frame Rotary Shaft Crank Position Screw, for 132769.....
1376C	20818	Knife (stationary) Holder Regulating Thumb Screw, for 81-72 and 81-78 Machines.....
1377C	20807	Presser Lever Screw Stud (eccentric)....
1378D	20839	Pressure Regulating Thumb Screw.....
1408J	20826	Machine Base Thumb Screw, for 1 5/8 inch table and individual stands, for use when machine is mounted on top of table (Accessories).....
1508C	5569	Knife Grinder Emery Wheel Clamping Nut, for 41819.....
1519J	5569	Knife Grinder Knife Holder Screw Center Nut, for 150210.....
1520J	5569	Feed Connecting Rod Hinge Screw Nut.....
1520J	5569	Knife Grinder Knife Holder Bracket Stop Screw Nut, for 41819.....
1534D	20818	Knife (stationary) Clamping Stud Thumb Nut, for 81-72 and 81-78 Machines..
1547J	7409	Knife (stationary) Holder Stop Screw Nut for 81-72 and 81-78 Machines.....
1547J	7409	Lifting Lever Stop Screw Nut, for 42133 and 42144.....

## NUMERICAL LIST OF PARTS

No.	Plate	Name
1547J	7409	Presser Lever Screw Stud Nut.....
1664E	20817	Frame Rotary Shaft Crank Ball Sleeve Bushing Nut, for 132775.....
1695J	7407	Feed Connecting Rod Hinge Screw Clamping Screw Nut, for 132529.....
1728C	20846	Needle Clamping Nut, for 81-65 and 81-72 Machines.....
1735J	20835	Looper (left hand) Lever Connecting Link Screw Nut, for 132801.....
2102	20843	Tension (looper, left hand) Disc.....
2102	20843	" (looper, right hand) Disc, for 81-72 and 81-78 Machines.....
2102	20843	Tension (needle thread) Disc, for 81-65 and 81-72 Machines.....
2102	20843	Tension (needle, left hand) Disc, for 81-78 Machine.....
2102	20843	Tension (needle, right hand) Disc, for 81-78 Machine.....
2763	20808	Rock Shaft, for 42143.....
2765	20808	" " Knee Arm, for 2768.....
2766	20808	" " " " Hub with 356C, for 2768.....
2767	20808	Rock Shaft Knee Plate with 356C, for 2768
2768	-----	Rock Shaft Knee Arm complete, for 42143, Nos. 2765 to 2767.....
2770	20808	Rock Shaft Stop Dog with 356C, for 42143.
4389	20821	Arm Dowel Pin.....
4822	5566	Wrench for 1547 (Accessories).....
4879	5566	Chain Connecting Link, for 4885.....
4881	20808	Treadle, for 4885.....
4882	5566	" Shaft, for 4885.....
4883	5566	" Spring, for 4885.....
4884	20808	" Stand, for 4885.....
4885	20808	Treadle complete, for 42133, Nos. 4879, 4881 to 4884 and two wood screws 1 in. No. 16.....
6337	20808	Rock Shaft Lifting Bracket with two 356C for 42143.....
6439	-----	Chain, 36 in. to 45 in. with 56864 and 56865, for 42133.....
7071	20821	Guide Screw Washer, for 81-65 and 81-72 Machines.....
7071	20821	Thread (looper, right hand) Staple Screw Washer, for 81-72 and 81-78 Machines
7125	20808	Rock Shaft Lifting Bracket Hook, for 42143.....
8908	5566	Wrench for 1520 (Accessories).....
9525	20807	Thread Unwinder Thread Separator Bracket Arm Clamping Screw Washer, for 150060.....
9525	20807	Thread Unwinder Thread Separator Bracket Screw Washer, for 150061 and 150087.

## NUMERICAL LIST OF PARTS

No.	Plate	Name
9842	7419	Machine Base Thumb Screw Spring Washer (Accessories).....
9842	7419	Machine Base Screw Stud Nut Washer, for 132592.....
10107	20838	Needle Bar Thread Retainer Spring.....
12242	20808	Rock Shaft Hanger with two wood screws 1 in. No. 10, for 42143.....
14058	20840	Presser Foot Spring for 132837, 132823, 132828, 132831, 132854, 132860, 132911 and 132912.....
14083	20807	Machine Base Thumb Screw Spring, for Thumb Screw No. 1408, when machine is mounted on individual stand (Accessories).....
14222	5569	Knife Grinder Knife Holder Clamp Steady Pin, for 41818.....
15404	-----	Trade Mark, for 132522 and 132724.....
15405	-----	" " Rivet, for 132522 and 132724.....
17547	20843	Tension (needle, left hand) Thread Guide for 81-78 Machine.....
19044	7407	Feed Eccentric Cover Holder Thumb Screw Washer, for 81-65 Machine.....
19044	7407	Frame Top Cover Extension Holder Thumb Screw Washer, for 81-72 and 81-78 Machines.....
19047	7407	Feed Eccentric Clamping Washer, for 132534 and 132644.....
27498	20826	Machine Base Thumb Screw Spring, for Thumb Screw No. 1408 on 1 5/8 inch tables and for Thumb Screw No. 474, when machine is mounted 1 1/2 inch lower than standard (Accessories)..
27739	20778	Thread Unwinder Thread Cone (wood) for large cones.....
27998	20807	Bench Stand Cover Hook and Eye (brass) with wood screw 1/2 in. No. 5 F.H., for 79768 and 79790.....
28291	20807	Bench Stand Cover Hinge with two each wood screws 1/2 inch No. 5 F.H. and 5/8 inch No. 5 F.H., for 79768 and 79790.....
38571	20835	Guide with 230J and 38572, for 81-65 Machine.....
38572	20835	Guide Smoothing Plate, for 38571 and 121416.....
39541	20824	Presser Foot Screw Washer.....
41326	20847	Knife Grinder Emery Wheel, for 41819....
41327	20847	" " " Shaft, for 41819.....
41328	20847	Knife Grinder Emery Wheel Shaft Pulley with 1036C, for 41819.....
41329	20830	Knife Grinder Frame with 1036C, for 41819

## NUMERICAL LIST OF PARTS

No.	Plate	Name
41331	20847	Knife Grinder Knife Holder Bracket with 157E, for 150210.....
41332	5569	Knife Grinder Knife Holder Spring, for 150210.....
41333	5569	Knife Grinder Knife Holder Clamp, for 150210.....
41334	5569	Knife Grinder Knife Holder Clamp Spring, for 150210.....
41513	5569	Knife Grinder Emery Wheel Washer, for 41819.....
41818	20847	Knife Grinder Knife Holder with two 14222, for 150210.....
41819	-----	Knife Grinder complete, for 81-72 and 81-78 Machines, Nos. 717C, 1508C, 1520J 41326 to 41329, 42065, 150210, two each 878D, 41513 and three wood screws 1 1/4 inch No. 12.....
42005	20821	Cloth Plate Lock Spring, for 132527....
42006	20831	Feed Bar with 1253C, for 132641.....
42021	20832	" Rock Shaft Crank with 157E, for 132626.....
42028	20833	Frame Side Cover (right) hinged.....
42035	7409	Knife (movable) Holder, for 132627.....
42037	7409	" " " Cap, for 132627..
42038	7409	" " " Guide with 336F, for 81-72 and 81-78 Machines.....
42039	7409	Knife (movable) Holder Guide Plate, for 81-72 and 81-78 Machines.....
42040	7409	Knife (movable) Holder Screw Extension Pin, for 42308 and 132627.....
42041	7409	Knife (movable) Holder Spring, for 81-72 and 81-78 Machines.....
42045	20834	Knife (movable) Lever Hinge Stud, for 81-72 and 81-78 Machines.....
42045	20834	Presser Lever Hinge Stud, for 42376....
42049	20818	Knife (stationary) Stud, for 42309.....
42050	20835	Looper (left hand) for 81-72 and 81-78 Machines.....
42054	20837	Needle Bar, for 81-65 and 81-72 Machines
42065	5569	Knife Grinder Knife Holder Bracket Hinge Stud, for 41819.....
42066	20838	Needle Guard.....
42069	20839	Presser Lever, for 42376.....
42070	20839	" " Lifter.....
42071	20839	" " Spring.....
42082	20843	Tension (needle thread) Thread Guide, for 81-65 and 81-72 Machines.....
42084	20845	Thread (looper, left hand) Tube.....
42088	7419	Machine Base Cushion (small) felt, for 132592 and 132656.....
42089	5566	Wrench for 1324 (Accessories).....
42090	5566	Threading Wire (Accessories).....

## NUMERICAL LIST OF PARTS

No.	Plate	Name
42096	20845	Thread (needle) Eyelet, for 81-65 and 81-72 Machines.....
42101	20821	Frame Side Cover (right) Lock Spring, for 132600.....
42102	7409	Feed Eccentric Cover Holder, for 132634.
42102	7409	Frame Top Cover Extension Holder, for 132600.....
42108	20821	Cloth Plate Extension (upper) for 132527
42109	20852	Feed Dog, 24 teeth (16 teeth to the inch) for 132833, for plain work, for 1/8 inch bight, for 81-72 Machine.....
42114	20835	Looper (left hand) for 81-65 and 81-72 Machines.....
42115	20838	Needle Bar Thread Retainer Bracket.....
42122	20844	Thread (looper, left hand) Nipper Spring (lower) for 81-72 and 81-78 Machines.....
42123	20844	Thread (looper, left hand) Nipper Spring (upper) for 81-72 and 81-78 Machines.....
42126	20844	Thread (looper, right hand) Pull-off, for 81-72 and 81-78 Machines.....
42130	20824	Lifting Lever, for 42133 and 42144.....
42131	20824	" " Bracket, for 42133 and 42144
42132	20824	" " Spring, for 42133 and 42144
42133	-----	Foot Lifter complete, Nos. 1301D, 4885, 6439 42130 to 42132 and two each 1148F, 1229C and 1547J.....
42142	20808	Lifting Lever Connecting Rod, for 42144..
42143	20808	Rock Shaft complete, for 42144, Nos. 2763, 2768, 6337, 7125 and two each 2770 and 12242.....
42144	-----	Knee Lifter complete, Nos. 1301D, 42130 to 42132, 42142, 42143 and two each 1148F, 1229C and 1547J.....
42172	20842	Presser Foot Chaining-off Finger, for 132911.....
42192	20835	Frame Side Cover (right) Lock Spring, for 81-65 Machine.....
42205	20831	Feed Bar with 1253C, for 132842.....
42213	7409	Knife (movable) for trimming and folding the edge on the bottom of work shirts, for 3/32 in. bight, for 81-72 Machine.....
42214	7409	Knife (movable) Gib, for 132827.....
42242	20845	Thread (looper, left hand) Eyelet, for 132801.....
42244	20844	Thread (looper, left hand) Pull-off Eyelet, for 81-72 and 81-78 Machines..
42253	20837	Needle Bar Bushing (lower) for 132522...
42267	20840	Feed Dog, 24 teeth (16 teeth to the inch) for 132854, for 81-65 Machine.....

## NUMERICAL LIST OF PARTS

No.	Plate	Name
42268	20840	Presser Foot Chaining-off Finger, for 132837.....
42270	-----	Presser Foot Plate, for 132837.....
42305	20818	Knife (movable) for 81-72 and 81-78 Machines.....
42306	20818	Knife (movable) Gib, for 42308.....
42307	20818	" " Holder, for 42308.....
42308	-----	" " " 42307 with 133F, 42040 and 42306, for 81-72 and 81-78 Machines.....
42309	20818	Knife (stationary) with 42049, for 81-72 and 81-78 Machines.....
42310	20818	Knife (stationary) Clamping Stud, for 81-72 and 81-78 Machines.....
42376	-----	Presser Lever 42069 with 42045.....
42404	20842	" Foot Chaining-off Finger, for 132912.....
42461	20842	Presser Foot Hinge Pin, for 132828, 132831 132854, 132860 and 132912.....
42483	20838	Needle Bar Thread Retainer Disc.....
46548	20807	Bench Stand Cover Rest (felt) for 79768 and 79790.....
50014F	20846	Needle Set Screw, for 132910.....
50093E	20842	Throat Plate Chaining-off Finger Screw, for 132917.....
50117C	20846	Looper (left hand) Clamping Screw, for 132795.....
50149C	20843	Tension (looper, right hand) Screw Stud, for 132871.....
50150C	20821	Cloth Plate Hinge Stud Set Screw.....
50200C	20846	Needle Bar Crank (front) Set Screw, for 132880.....
50253J	7407	Feed Eccentric Cover Screw, for 132600 and 132834.....
50261C	20843	Tension (needle, left hand) Screw Stud, for 132360.....
50261C	20843	Tension (needle, right hand) Screw Stud, for 132360.....
50261C	20843	Tension (needle thread) Screw Stud, for 132360.....
50262C	20843	Tension (looper, left hand) Screw Stud, for 59539.....
51145C	7407	Feed Regulating Screw, for 132534 and 132844.....
51292C	7407	Feed Connecting Rod Hinge Screw.....
51332C	20821	Frame Rotary Shaft Bushing (front) Set Screw.....
51332C	20821	Frame Rotary Shaft Flanged Bushing (back) Set Screw.....
51459E	20835	Looper (left hand) Lever Connecting Link Screw, for 132801.....
51570C	20843	Tension (looper, left hand) Regulating Thumb Nut, for 59539.....

## NUMERICAL LIST OF PARTS

No.	Plate	Name
51570C	20843	Tension (looper, right hand) Regulating Thumb Nut, for 132871.....
51570C	20843	Tension (needle, left hand) Regulating Thumb Nut, for 132360.....
51570C	20843	Tension (needle, right hand) Regulating Thumb Nut, for 132360.....
51570C	20843	Tension (needle thread) Regulating Thumb Nut, for 132360.....
51576E	7419	Machine Base Screw Stud Nut, for 132592.
52130	20845	Thread (needle) Eyelet Bushing, for 132873.....
52130	20845	Thread (needle) Take-up Staple and Thread Guide Bushing, for 132875....
54477	7419	Machine Base Screw Stud, for 132592.....
56864	5566	Chain Hook (large) for 6439.....
56865	20807	Bench Stand Cover Chain Hook, for 60820.
56865	20807	Chain Hook (small) for 6439.....
57076	20843	Tension (looper, right hand) Thread Guide, for 81-72 and 81-78 Machines
59534	20843	Tension (looper, left hand) Spring.....
59535	20843	" (looper, right hand) Spring, for 81-72 and 81-78 Machines.....
59535	20843	Tension (needle thread) Spring, for 81-65 and 81-72 Machines.....
59535	20843	Tension (needle, left hand) Spring, for 81-78 Machine.....
59535	20843	Tension (needle, right hand) Spring, for 81-78 Machine.....
59537	20843	Tension (looper, left hand) Spring Bushing (large).....
59537	20843	Tension (looper, right hand) Spring Bushing (large) for 81-72 and 81-78 Machines.....
59537	20843	Tension (needle thread) Spring Bushing (large) for 81-65 and 81-72 Machines.....
59537	20843	Tension (needle, left hand) Spring Bushing (large) for 81-78 Machine.....
59537	20843	Tension (needle, right hand) Spring Bushing (large) for 81-78 Machine..
59538	20843	Tension (looper, left hand) Spring Bushing (small).....
59538	20843	Tension (looper, right hand) Spring Bushing (small) for 81-72 and 81-78 Machines.....
59538	20843	Tension (needle thread) Spring Bushing (small) for 81-65 and 81-72 Machines.....
59538	20843	Tension (needle, left hand) Spring Bushing (small) for 81-78 Machine.....
59538	20843	Tension (needle, right hand) Spring Bushing (small) for 81-78 Machine..

## NUMERICAL LIST OF PARTS

No.	Plate	Name
59539	-----	Tension (looper, left hand) Screw Stud - 50326C with 51570C.....
60820	-----	Bench Stand Cover Chain, 9 1/4 inch long, with two 56865, for 79790.....
62527	20840	Presser Foot Hinge Pin, for 132837, 132823 and 132911.....
68350	20821	Arm Oil Cup.....
79768	-----	Bench Stand with 27998, two each 28291, 46548 and wood screws 1 1/2 inch No. 14 F.H., for Machine Base 132592, for use when machine is mounted on top of table.....
79790	-----	Bench Stand with 27998, 60820, two each 28291, 46548, 150244 and three each wood screws 1 1/4 in. No. 12 F.H. and 1 1/2 in. No. 14 F.H., for Machine Base No. 132656, for use when machine is mounted 1 1/2 inch lower than standard.....
120341	5566	Tweezers (curved) Accessories.....
120344	5566	Oiler (copper plated) with 120345 (Accessories).....
120345	5566	Oiler Spout, 4 1/2 inches long, for 120344 (Accessories).....
120440	5566	Screw Driver (machine) Accessories.....
121106	20845	" " for 81-78 Machine (Accessories).....
121416	20848	Guide with 230J and 38572, for trimming and serging cloth, for 5/32 inch to 7/32 inch bight, for two-thread stitch, for 81-72 Machine.....
125056	20836	Looper (right hand) and Spreader Lever Hinge Pin Oil Wick (braided cotton) for 132699.....
131022	20824	Machine Base Position Stud Bushing (rubber) for 132656.....
131185	20828	Machine Base Oil Drain Jar (glass) for 131268 and 132697.....
131188	20828	Machine Base Oil Drain Jar Clamp, for 131217.....
131189	20828	Machine Base Oil Drain Jar Clamp Lever, for 131217.....
131191	20828	Machine Base Oil Drain Jar Cap, for 131268 and 132697.....
131217	-----	Machine Base Oil Drain Jar Clamp 131188 with 131189, for 131268 and 132697..
131265	20828	Machine Base Oil Drain Jar Nipple (long) for 131268 and 132697.....
131266	20828	Machine Base Oil Drain Jar Nipple (short) for 131268 and 132697.....
131267	20828	Machine Base Oil Drain Jar Nipple Elbow, for 131268 and 132697.....

## NUMERICAL LIST OF PARTS

No.	Plate	Name
131268	-----	Machine Base Oil Drain Jar (swinging type) complete for 132704, Nos. 131185, 131191, 131217, 131266 and two each 1247C, 131265 and 131267.....
132360	-----	Tension (needle, left hand) Screw Stud 50281C with 51570C, for 81-78 Machine.....
132360	-----	Tension (needle, right hand) Screw Stud 50281C with 51570C, for 81-78 Machine.....
132360	-----	Tension (needle thread) Screw Stud 50281C with 51570C, for 81-65 and 81-72 Machines.....
*132522	-----	Arm with 15404, 42253, 132590 and two each 482C, 624C, 15405 and 132589, for 81-65 and 81-72 Machines.....
132524	20808	Cloth Plate with 132525, for 132527.....
*132525	-----	" " Hinge Bracket, for 132524...
132526	20821	" " Stud.....
132527	-----	Cloth Plate complete, Nos. 42005, 42108, 132524, 132601, two 236C and five 233E.....
132528	20831	Feed Bar Hinge Pin.....
132529	7407	" Connecting Rod with 171C, 1695J and two 1057C, for 132619 and 132643....
*132531	-----	Feed Eccentric, for 132534 and 132644...
*132532	-----	" " Body, for 132644.....
132533	7407	" " Oil Tube, for 132534 and 132644.....
132534	7407	Feed Eccentric complete, Nos. 201J, 19047, 51145C, 132531, 132533, 132702 and two 1038C, for 132619.....
132537	20831	Feed Eccentric Lubricator Oil Wick (braided cotton) for 132785.....
132539	20832	Feed Lifting Eccentric Connection, for 132641 and 132642.....
132542	20832	Feed Rock Shaft Hinge Pin with 132544...
132543	20832	" " " " Bushing.....
132543	20832	Looper (right hand) and Spreader Lever Hinge Pin Bushing.....
132544	20832	Feed Rock Shaft Hinge Pin Oil Wick (braided cotton) for 132542.....
*132545	-----	Frame.....
132546	20808	" Bottom Cover with 132594.....
132547	20808	" " " Gasket.....
132548	20821	" Oil Cup.....
132552	20835	Looper (left hand) Lever Hinge Stud Oil Pad (braided cotton) for 132798....
132558	20823	Frame Rotary Shaft Oil Pad (braided cotton) for 132819.....
132559	20823	Frame Rotary Shaft Oil Pad Retainer, for 132819.....

## NUMERICAL LIST OF PARTS

No.	Plate	Name
132560	20833	Frame Side Cover (left) with 132701, for 81-72 Machine.....
132563	20834	Knife (movable) Lever Connection with two 1057C, for 132620.....
132565	20834	Knife (movable) Lever Connection Hinge Stud, for 81-72 and 81-78 Machines.
132580	20837	Needle Bar Bushing (upper) for 132522 and 132724.....
132581	20837	Needle Bar Bushing (upper) Oil Pad (braided cotton).....
132582	20837	Needle Bar Connecting Link, for 132881 and 132882.....
132583	20837	Needle Bar Connecting Link Hinge Pin with 132584, for 132881 and 132882.
132584	20837	Needle Bar Connecting Link Hinge Pin Oil Pad (wick) for 132583.....
132589	20838	Needle Bar Crank (back) Bushing, for 132522 and 132724.....
132590	20838	Needle Bar Crank (back) Oil Pad (wick) for 132879.....
132591	20844	Thread (looper, left hand) Pull-off, for 81-72 and 81-78 Machines.....
132592	-----	Machine Base complete, for 132704, Nos. 132593, 132596, 132618, 132647, three each 9842, 51576E, 54477 and four each 935E, 42088 and 132595.....
132593	7419	Machine Base Oil Drain Strainer, for 132592 and 132656.....
132594	7419	Machine Base Thumb Screw Bushing, for 132546.....
132595	7419	Machine Base Cushion (large) felt, for 132592 and 132656.....
132596	7419	Machine Base Cushion (leather) for 132592 and 132656.....
132598	20837	Needle Bar Connecting Bracket with 187E and 223F, for 132882.....
132599	20843	Tension (looper, left hand) Thread Guide
132600	-----	Frame Top Cover Extension Holder 42102 with 42101, 132650, 132651 and two each 176J and 50253J, for 81-72 and 81-78 Machines.....
132601	20808	Cloth Plate Extension (lower) for 132527
132602	20807	Machine Base Thumb Screw Washer (Accessories).....
132603	20834	Frame Rotary Shaft Flanged Bushing (back) Oil Pad Retainer, for 132886
132608	20853	Presser Foot Chaining-off Finger, for 132860.....
132609	20841	Presser Foot Chaining-off Plate, for 132637, 132823, 132828, 132831, 132854, 132860, 132911 and 132912.....

## NUMERICAL LIST OF PARTS

No.	Plate	Name
132610	20841	Presser Foot Chaining-off Plate Collar with 240C, for 132637, 132823, 132828, 132831, 132854, 132860, 132911 and 132912.....
132611	20841	Presser Foot Chaining-off Plate Collar Guide Pin, for 132637, 132823, 132828, 132831, 132854, 132860, 132911 and 132912.....
132612	-----	Presser Foot Shank with 735C, for 132637, 132823 and 132911.....
132618	7419	Machine Base Cushion (small) felt, for 474 or 1408, for 132592 and 132656.
132619	-----	Feed Connecting Rod 132529 with 132534, for 81-78 Machine.....
132620	-----	Knife (movable) Lever Connection 132563 with 132649, for 81-72 and 81-78 Machines.....
132621	20837	Needle Bar Bushing (upper) Oil Pad Cover for 81-72 Machine.....
132625	20832	Feed Rock Shaft, for 132826.....
132626	-----	Feed Rock Shaft complete, Nos. 42021 and 132625.....
132627	-----	Knife (movable) Holder 42035 with 133F, 42037, 42040, 42214 and two 404D, for trimming and folding the edge on bottom of work shirts, for 3/32 and 5/32 inch bight, for 81-72 Machine.
132630	20836	Looper (right hand) for 81-72 Machine..
132631	20836	Spreader, for 81-65 and 81-72 Machines..
132632	20833	Balance Wheel, 1 7/8 inch pulley, with 446C and 1285C.....
132634	-----	Feed Eccentric Cover Holder 42102 with 132651 and two 50253J, for 81-65 Machine.....
132635	20832	Feed Lifting Eccentric with two 462C, for 81-65 Machine.....
132637	20840	Presser Foot (spring hinged) complete, for two-thread stitch, for 81-65 and 81-72 Machines, Nos. 233J, 14058, 42268, 42270, 62527 and 132609 to 132612.....
132638	20833	Frame Side Cover (left) with 132701, for 81-65 Machine.....
132641	-----	Feed Bar 42006 with 132539, for 81-78 Machine.....
132642	-----	Feed Bar 42205 with 132539, for 81-65 and 81-72 Machines.....
132643	-----	Feed Connecting Rod 132529 with 132644, for 81-65 and 81-72 Machines.....

## NUMERICAL LIST OF PARTS

No.	Plate	Name
132644	20831	Feed Eccentric complete, for 132643, Nos. 201J, 19047, 51145C, 132531 to 132533 and two 1036C.....
132647	20808	Machine Base, for 132592.....
132649	20832	Feed Lifting Eccentric with two 462C, for 132820.....
132650	7409	Frame Top Cover Extension, for 132600...
132651	7407	Feed Eccentric Cover, for 132600 and 132634.....
132654	20833	Chip Guard, for 81-72 and 81-78 Machines
132655	20830	Machine Base, for 132656.....
132656	-----	Machine Base complete for 132705, Nos. 132593, 132596, 132618, 132655, three each 1204E, 131022 and four each 935E, 42088 and 132595.....
132664	20844	Thread (looper, right hand) Staple, for 81-72 and 81-78 Machines.....
132662	20841	Presser Foot Chaining-off Finger, for 132823.....
132663	-----	Presser Foot Plate, for 132828, 132831, 132854, 132860 and 132912.....
132665	-----	Presser Foot Shank with 735C, for 132828, 132831, 132854, 132860 and 132912....
*132692	20834	Frame Rotary Shaft Oil Sling Cover, for 132866.....
132697	-----	Machine Base Oil Drain Jar (swinging type) complete for 132705, Nos. 131185, 131191, 131217, 131265 and two each 1247C, 131266 and 131267.....
132699	* 20836	Looper (right hand) and Spreader Lever Hinge Pin with 125056, for 132800..
132701	20821	Frame Side Cover (left) Handle for 132560, 132638 and 132906.....
*132702	-----	Feed Eccentric Body, for 132534.....
132704	-----	Machine Base and Oil Drain Jar complete, for Machine Base No. 132592, when machine is mounted on top of table, for use with Bench Stand No. 79768, Nos. 131268 and 132592.....
132705	-----	Machine Base and Oil Drain Jar complete, for Machine Base No. 132656, when machine is mounted 1 1/2 inches lower than standard, for use with Bench Stand No. 79790, Nos. 132656 and 132697.....
132712	20831	Feed Eccentric Lint Cover (spring).....
132715	20817	Frame Rotary Shaft Bushing (front) Oil Pad Retainer, for 132863.....
*132724	-----	Arm with 15404, 132580, 132739 and two each 462C, 624C, 15405 and 132589, for 81-78 Machine.....
132739	20837	Needle Bar Bushing (lower) for 132724...

No.	Plate	Name
132740	20837	Needle Bar Connecting Bracket with 223F and 1057C, for 132881.....
132759	20838	Needle Guard Holder, for 81-65 Machine..
132767	20818	Knife (stationary) Holder, for 81-72 and 81-78 Machines.....
132769	20817	Frame Rotary Shaft Crank with 1036C, 1375C and 132773, for 132775.....
132770	20817	Frame Rotary Shaft Crank Ball Sleeve, for 132775.....
132771	20817	Frame Rotary Shaft Crank Ball Sleeve Bushing, for 132775.....
132772	20817	Frame Rotary Shaft Crank Ball Sleeve Bushing Nut Washer, for 132775.....
132773	20846	Frame Rotary Shaft Crank Ball Sleeve Bushing Position Pin, for 132769...
132774	20817	Frame Rotary Shaft Ball Sleeve Guide, for 132820.....
132774	20817	Frame Rotary Shaft Crank Ball Sleeve Guide, for 132779.....
132775	-----	Frame Rotary Shaft Crank complete for 132779, Nos. 1664E and 132769 to 132772.....
132777	20817	Looper (right hand) and Spreader Lever Connection with four 896C, for 132779.....
132779	-----	Looper (right hand) and Spreader Lever Connection 132777 with 132774, 132775 and 132802.....
132780	20808	Frame Top Cover, for 132781.....
132781	-----	" " " 132780 with 132782 to 132784 and two 197J, for 81-72 and 81-78 Machines.....
132782	20821	Frame Top Cover Oil Reservoir Cover, for 132781 and 132787.....
132783	20821	Frame Top Cover Oil Tube, for 132781 and 132787.....
132784	20821	Frame Top Cover Oil Wick, for 132781 and 132787.....
132785	20831	Feed Eccentric Lubricator with 132537...
132786	20854	Frame Top Cover, for 132787.....
132787	-----	Frame Top Cover 132786 with 132782 to 132784 and two 197J, for 81-65 Machine.....
132790	20834	Frame Rotary Shaft Ball Sleeve, for 132820.....
132795	20835	Looper (left hand) Lever with 50117C, for 132801.....
132796	20835	Looper (left hand) Lever Connecting Link for 132801.....
132797	20835	Looper (left hand) Lever Connecting Link Hinge Pin, for 132801.....

No.	Plate	Name
132798	20835	Looper (left hand) Lever Hinge Stud with 132552, for 132801.....
132799	20836	Looper (right hand) and Spreader Lever with 233E, 241E and 140123C, for 132800.....
132800	-----	Looper (right hand) and Spreader Lever 132799 with 132699, for 132801.....
132801	-----	Looper (right hand) and Spreader Lever 132800 with 42242, 132795, 132798 and two each 1735J, 51459E, 132796 and 132797.....
132802	20817	Looper (right hand) and Spreader Lever Ball Stud, for 132779.....
132802	20817	Needle Bar Crank (back) Ball Stud, for 132820.....
132806	20838	Needle Bar Connecting Rod with four 896C for 132820.....
132812	20845	Thread (looper, right hand) Take-up, for 81-72 and 81-78 Machines.....
132816	20823	Feed Rock Shaft Hinge Pin Bushing Oil Wick (wick).....
132816	20823	Looper (left hand) Lever Hinge Stud Oil Wick (wick).....
132816	20823	Looper (right hand) and Spreader Lever Hinge Pin Bushing Oil Wick (wick)..
132817	20823	Frame Rotary Shaft Bushing (front) Oil Wick (wick).....
132817	20823	Frame Rotary Shaft Flanged Bushing (back) Oil Wick (wick).....
132818	20848	Feed Dog, 23 teeth (16 teeth to the inch) for 132825, for trimming and serging cloth, for 5/32 inch to 7/32 inch bight, for three-thread stitch, for 81-72 Machine.....
132819	20833	Frame Rotary Shaft with 132558 and 132559, for 132820.....
132820	-----	Frame Rotary Shaft 132819 with 132774, 132790, 132802 and 132806.....
132821	20834	Knife (movable) Lever with 175E, for 81-72 and 81-78 Machines.....
132822	-----	Presser Foot Plate, for 132823 and 132911
132823	20841	Presser Foot (spring hinged) complete, for plain work, for 1/8 inch bight, for 81-72 Machine, Nos. 233J, 14058, 62527, 132609 to 132612, 132682 and 132822.....
132824	20841	Throat Plate, for 132826 and 132851, for trimming and overedging blankets, for 9/32 inch bight, for 81-72 Machine.....

## NUMERICAL LIST OF PARTS

No.	Plate	Name
132825	20848	Throat Plate, for 132818, for trimming and serging cloth, for 5/32 inch to 7/32 inch bight, for two-thread stitch, for 81-72 Machine.....
132826	20849	Feed Dog, 16 teeth (10 teeth to the inch) for 132824, for trimming and over-eding blankets, for 9/32 inch bight for 81-72 Machine.....
132827	20849	Presser Foot Chaining-off Finger, for 132828.....
132828	20849	Presser Foot (spring hinged) complete, for trimming overeding blankets, for 9/32 inch bight, for 81-72 Machine, Nos. 233J, 14058, 42461, 132609 to 132611, 132683, 132685 and 132827.....
132829	20850	Feed Dog, 25 teeth (16 teeth to the inch) for 132832 and 132852, for trimming and folding the edge on the bottom of work shirts, for 3/32 inch and 5/32 inch bight, for 81-72 Machine..
132830	20850	Presser Foot Chaining-off Finger, for 132831.....
132831	20850	Presser Foot (spring hinged) complete, for trimming and folding the edge on the bottom of work shirts, for 3/32 inch bight, for 81-72 Machine, Nos. 233J, 14058, 42461, 132609 to 132611, 132683, 132685 and 132830....
132832	20850	Throat Plate, for 132829, for trimming and folding the edge on the bottom of work shirts, for 3/32 inch bight, for 81-72 Machine.....
132833	20852	Throat Plate, for 42109, for plain work, for 1/8 inch bight, for 81-72 Machine.....
132835	20817	Frame Rotary Shaft Crank Oil Sling Cover for 132863.....
132851	20841	Feed Dog, 25 teeth (16 teeth to the inch) for 132824, for stitching pockets into trousers, for 81-72 Machine....
132852	20851	Throat Plate, for 132829, for trimming and folding the edge on the bottom of work shirts, for 5/32 inch bight, for 81-72 Machine.....
132853	20851	Presser Foot Chaining-off Finger, for 132854.....
132854	20851	Presser Foot (spring hinged) complete, for trimming and folding the edge on the bottom of work shirts, for 5/32 inch bight, for 81-72 Machine, Nos. 233J, 14058, 42461, 132609 to 132611, 132683, 132685 and 132853....

## NUMERICAL LIST OF PARTS

No.	Plate	Name
132859	20853	Feed Dog, 35 teeth (22 teeth to the inch) for 132881, for rayon, for 81-72 Machine.....
132860	20853	Presser Foot (spring hinged) complete, for rayon, for 81-72 Machine, Nos. 233J, 14058, 42461, 132608 to 132611, 132683 and 132685.....
132861	20853	Throat Plate, for 132859, for 81-72 Machine.....
*132862	-----	Frame Rotary Shaft Bushing (front) for 132863.....
132863	20817	Frame Rotary Shaft Bushing (front) 132862 with 132835, 132864 and two 132715.....
132864	20823	Frame Rotary Shaft Bushing (front) Oil Pad (braided cotton) for 132863....
*132865	20833	Frame Rotary Shaft Flanged Bushing (back) for 132866.....
132866	-----	Frame Rotary Shaft Flanged Bushing (back) 132865 with 132892, 132867, 132868 and two 132803.....
132867	20823	Frame Rotary Shaft Flanged Bushing (back) Oil Pad (large) for 132866..
132868	20823	Frame Rotary Shaft Flanged Bushing (back) Oil Pad (small) braided cotton, for 132866.....
132871	-----	Tension (looper, right hand) Screw Stud 50149C with 51570C, for 81-72 and 81-78 Machines.....
132872	20844	Thread (looper, right hand) Controller, for 81-72 Machine.....
132873	20845	Thread (needle) Eyelet with 52130, for 81-72 and 81-78 Machines.....
132875	20844	Thread (needle) Take-up Staple and Thread Guide with two 52130, for 81-72 and 81-78 Machines.....
132879	20838	Needle Bar Crank (back) with 132590 and two 1259C.....
132880	20838	Needle Bar Crank (front) with 620C, 50200C and 140123C, for 132881 and 132882.....
132881	-----	Needle Bar Crank (front) 132880 with 132582, 132740 and two 132583, for 81-78 Machine.....
132882	-----	Needle Bar Crank (front) 132880 with 132582, 132598 and two 132583, for 81-65 and 81-72 Machines.....
132883	20845	Thread (needle) Take-up, for 81-65 and 81-72 Machines.....
132884	20840	Throat Plate, for 42267, for 81-65 Machine



## NUMERICAL LIST OF PARTS

No.	Plate	Name
132905	20842	Feed Dog, 25 teeth (16 teeth to the inch) for 3/32 inch gauge, for 132917, for pants pockets and dress material, for 81-78 Machine.....
132906	20833	Frame Side Cover (left) with 132701, for 81-78 Machine.....
132907	20836	Looper (right hand) for 81-78 Machine...
132908	20837	Needle Bar (hollow) for 132909.....
132909	-----	Needle Bar complete, for 3/32 inch gauge, for 81-78 Machine, Nos. 132908 and 132910.....
132910	20837	Needle Clamp with two 50014F, for 3/32 inch gauge, for 132909.....
132911	20842	Presser Foot (hinged) complete, for pants pockets, for 81-78 Machine, Nos. 233J, 14058, 42172, 62527, 132809 to 132812 and 132822.....
132912	20842	Presser Foot (hinged) complete, for dress material, for 81-78 Machine, Nos. 233J, 14058, 42404, 42461, 132809 to 132811, 132883 and 132885.....
132913	20843	Tension (needle, left hand) Bracket and Thread Eyelet, for 81-78 Machine...
132914	20845	Thread (needle) Take-up, for 81-72 and 81-78 Machines.....
132915	20842	Throat Plate Body, for 132917.....
132916	20842	" " Chaining-off Finger, for 132917.....
132917	-----	Throat Plate complete, for 132905, for 3/32 inch gauge, for pants pockets and dress materials, for 81-78 Machine, Nos. 50093E, 132915 and 132916.
140123C	20846	Looper (right hand) and Spreader Lever Ball Stud Set Screw, for 132799....
140123C	20846	Needle Bar Crank (front) Position Screw, for 132880.....
*150057	-----	Thread Unwinder Thread Separator, for 150058.....
150058	20778	Thread Unwinder Thread Separator 150057 with 150059, for 150061.....
*150059	-----	Thread Unwinder Thread Separator Bracket for 150058 and 150088.....
150060	20787	Thread Unwinder Thread Separator Bracket Arm with 164J and 9525, for 150061 and 150087.....
150061	-----	Thread Unwinder Thread Separator complete, for 150062 and 150178, Nos. 164J, 9525, 150058 and 150060.....
150062	9505	Thread Unwinder complete, for four spools for 81-78 Machine, Nos. 150061, 201696J, 202490, 225324, 225326, 225388 two 225257, three wood screws 7/8 inch No. 12 and four each 150203 and 225391.....

## NUMERICAL LIST OF PARTS

No.	Plate	Name
*150085	-----	Thread Unwinder Thread Separator, for 150088.....
150086	20787	Thread Unwinder Thread Separator 150085 with 150059, for 150087.....
150087	-----	Thread Unwinder Thread Separator complete, for 150088, Nos. 164J, 9525, 150060 and 150088.....
150088	20787	Thread Unwinder complete, for two spools, for 81-65 Machine, Nos. 150087, 201696J, 202490, 225257, 225324, 225326 225388, two each 150203, 225391 and three wood screws 7/8 inch No. 12..
150178	20778	Thread Unwinder complete, for three spools, for 81-72 Machine, Nos. 150061 201696J, 202490, 225257, 225259, 225324 225326, 225388 and three each 150203 225391 and wood screws 7/8 inch No. 12.....
150203	20778	Thread Unwinder Spool Rest Cushion (felt) for 150062, 150088 and 150178
150210	-----	Knife Grinder Knife Holder 41818 with 970D, 41331, 41332 and two each 313C, 771D, 1519J, 41333 and 41334, for 41819.....
150244	20826	Bench Stand Cover Chain Hook Screw Eye, for 79790.....
200383C	20807	Thread Unwinder Spool Rest Rod Set Screw for 202490.....
201018C	20807	Thread Unwinder Spool Rest Set Screw, for 225257 and 225259.....
201696J	20807	Thread Unwinder Thread Guide Lock Nut, for 150062, 150088 and 150178.....
202490	20787	Thread Unwinder Spool Stand with 200383C for 150062, 150088 and 150178.....
225257	20787	Thread Unwinder Spool Rest (for two spools) with 201018C, for 150062, 150088 and 150178.....
225259	20778	Thread Unwinder Spool Rest (for one spool) with 201018C, for 150178.....
225322	20807	Thread Unwinder Thread Guide Rod-Washer, for 225324.....
225324	20787	Thread Unwinder Thread Guide Rod with 208E and 225322, for 150062, 150088 and 150178.....
225326	20807	Thread Unwinder Thread Guide Position Cup, for 150062, 150088 and 150178..
225388	20787	Thread Unwinder Spool Rest Rod, for 150062, 150088 and 150178.....
225390	20778	Thread Unwinder Thread Cone Holder, for inverted cones.....
225391	20787	Thread Unwinder Thread Guide, for 150062, 150088 and 150178.....

Genuine Singer Needles should be used  
in Singer Machines.  
These Needles and their Containers  
are marked with the  
Company's Trade Mark "SIMANCO." 1

Needles in Containers marked  
"For Singer Machines"  
are not Singer made needles. 2

1407-5-4

PLATE 5566—ONE-HALF SIZE

120341



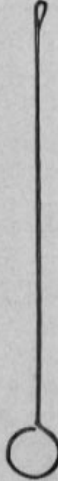
120344



120345



120440 42090



8908



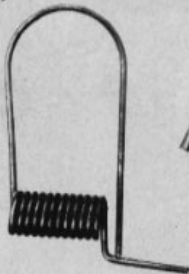
42089



4822



4883



4882



4879



56864



PLATE 5569—FULL SIZE

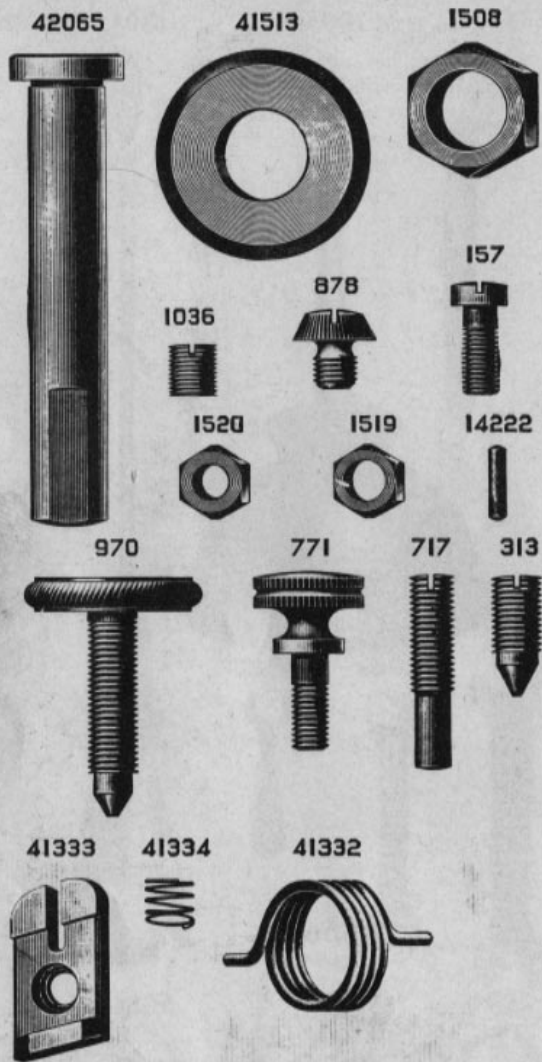
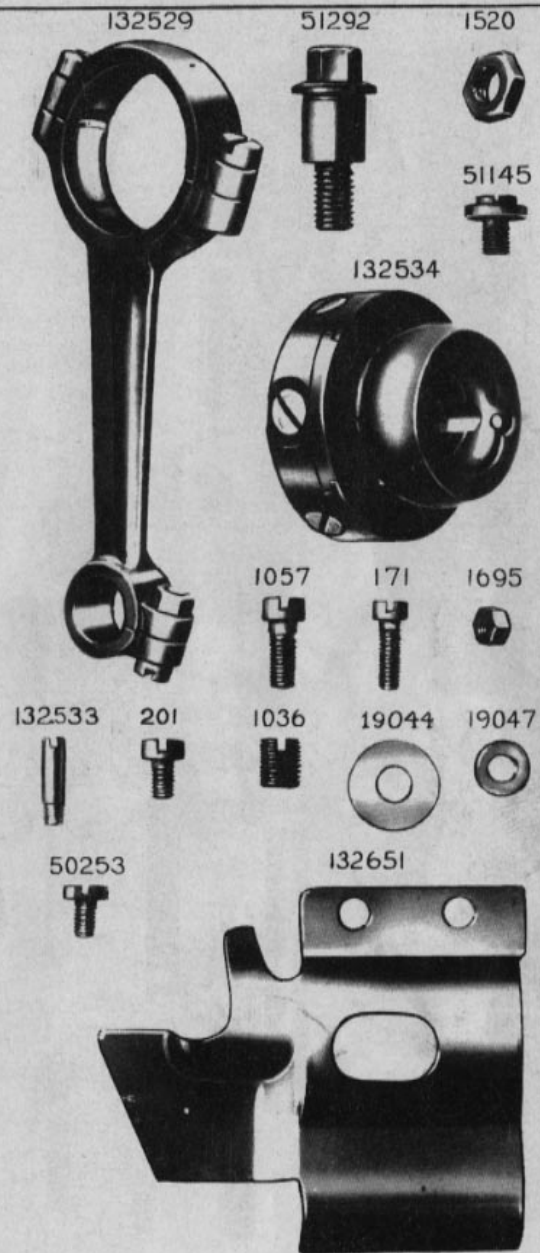
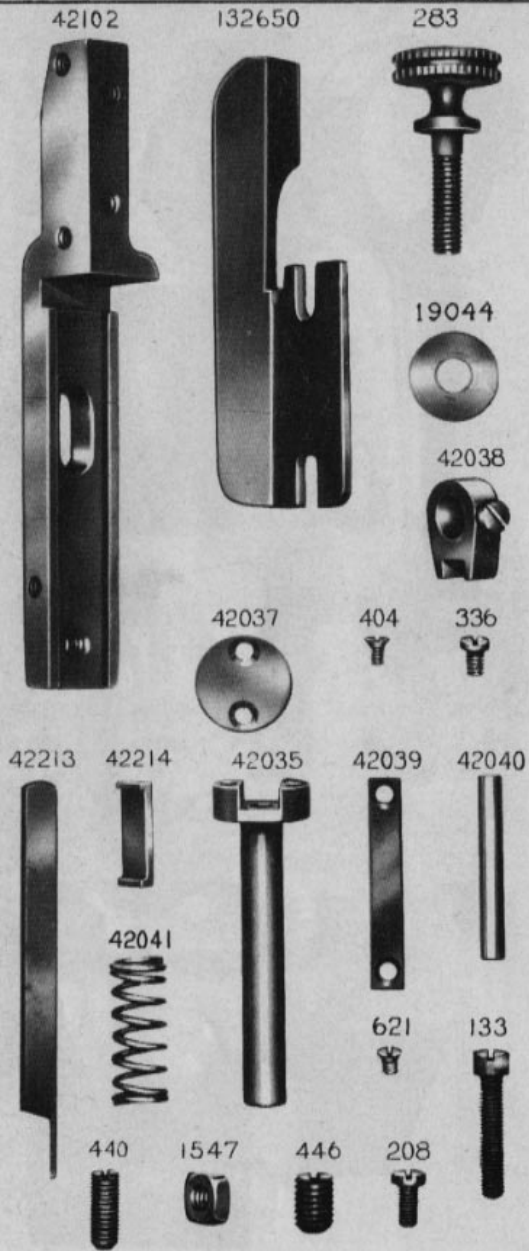


PLATE 7407—FULL SIZE



**PLATE 7409—FULL SIZE**



**PLATE 7419—FULL SIZE**

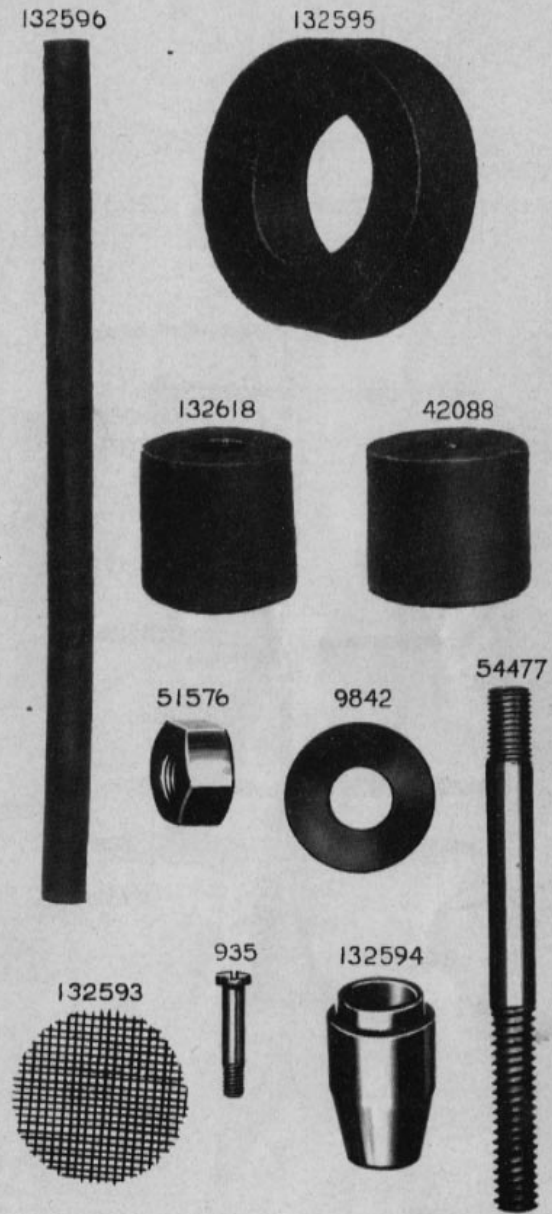


PLATE 9505—ONE-SIXTH SIZE

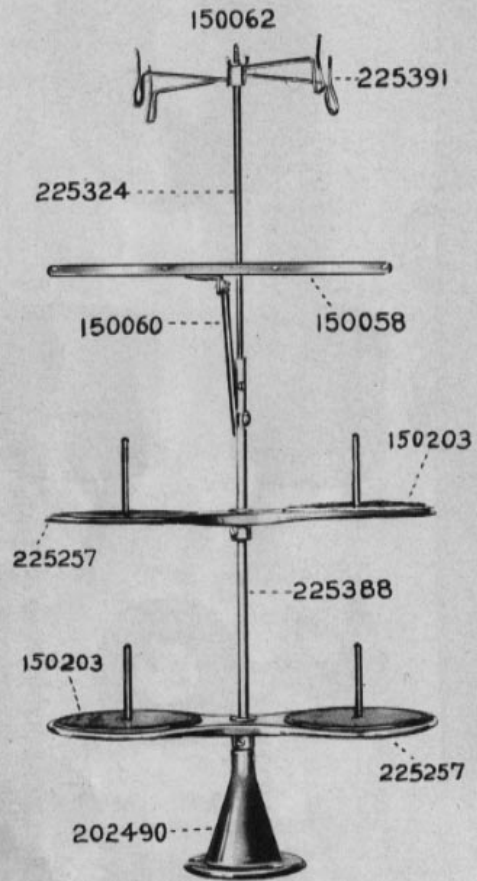


PLATE 20778—ONE-SIXTH SIZE

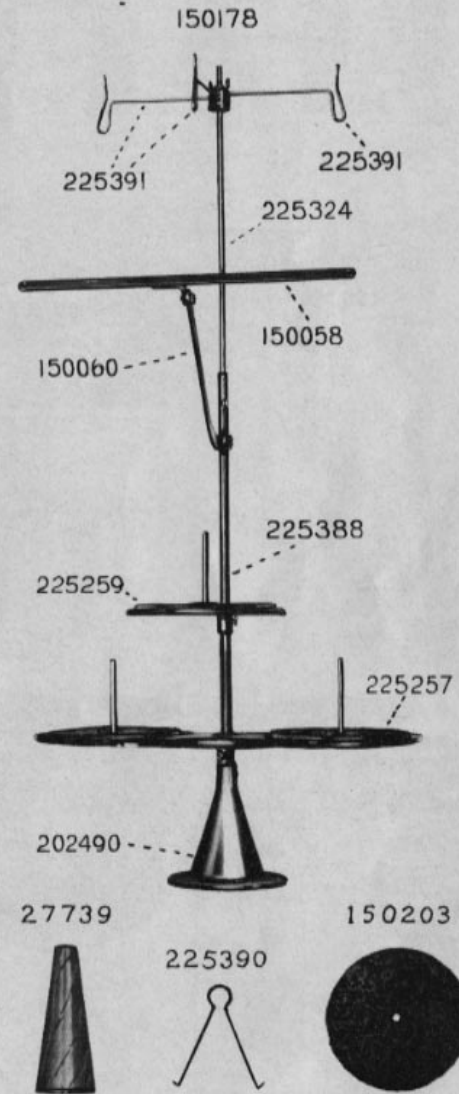


PLATE 20787—ONE-SIXTH SIZE

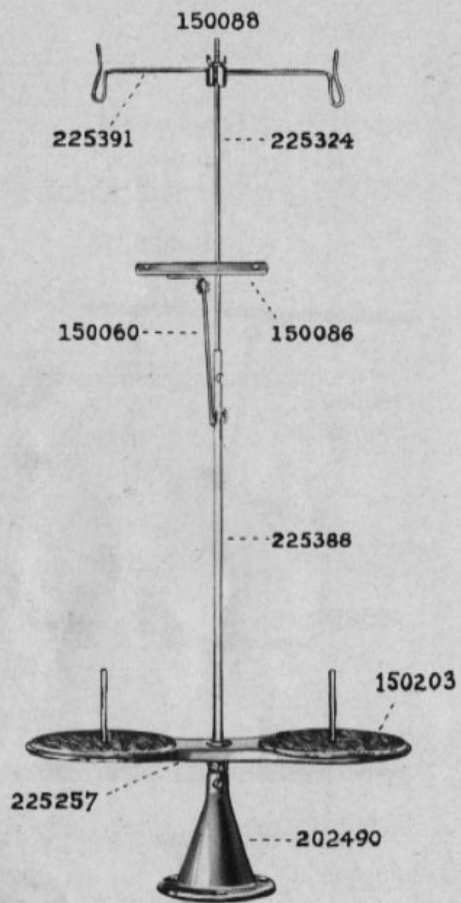


PLATE 20807—FULL SIZE

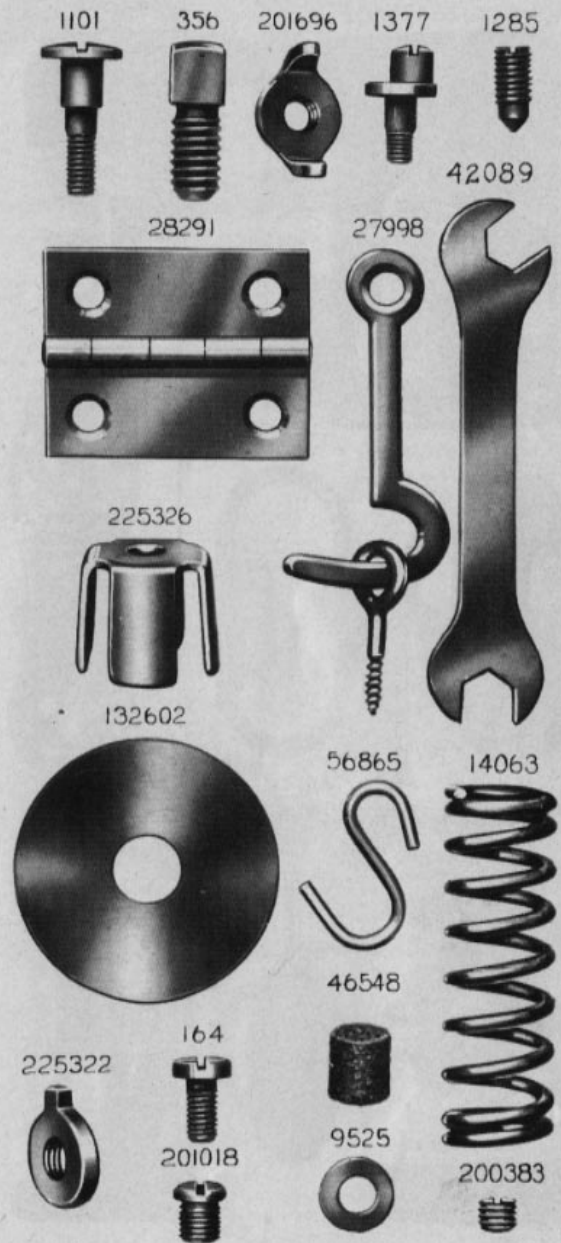


PLATE 20808-ONE-FOURTH SIZE

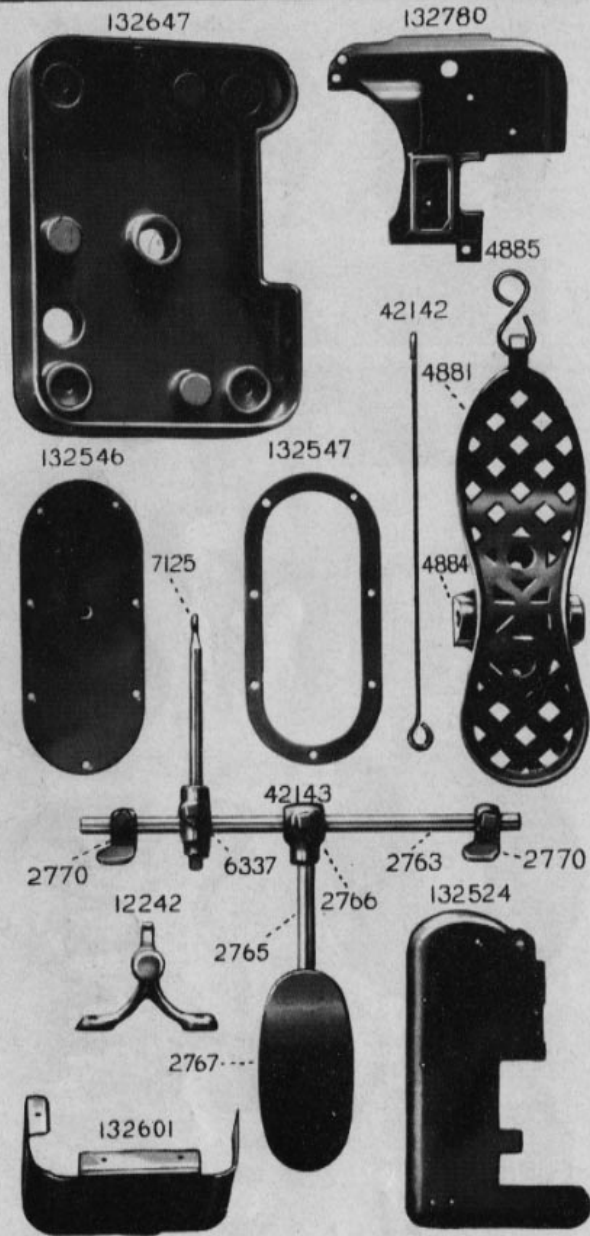


PLATE 20817-FULL SIZE

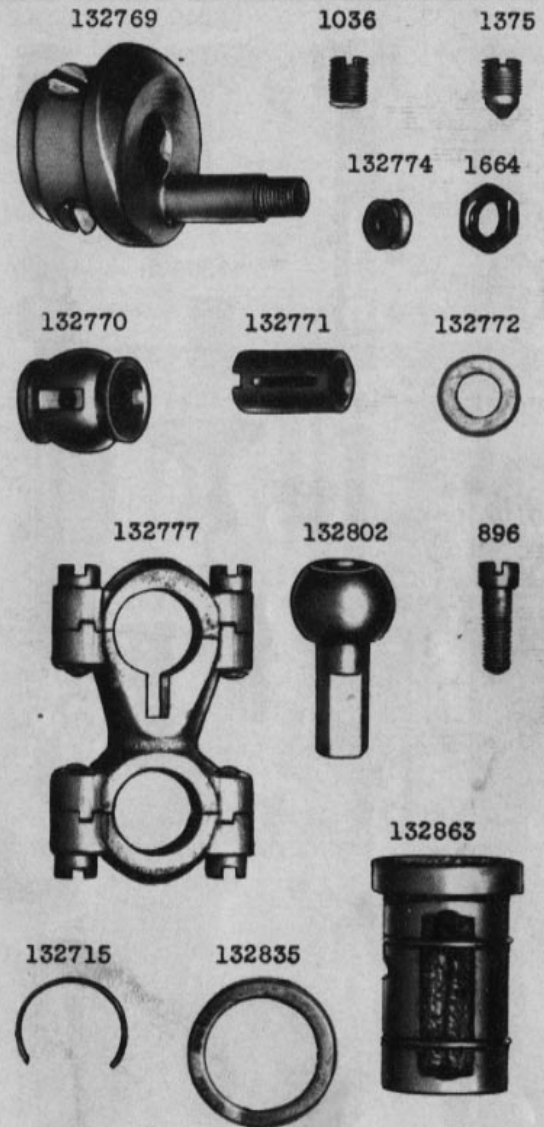




PLATE 20818-FULL SIZE

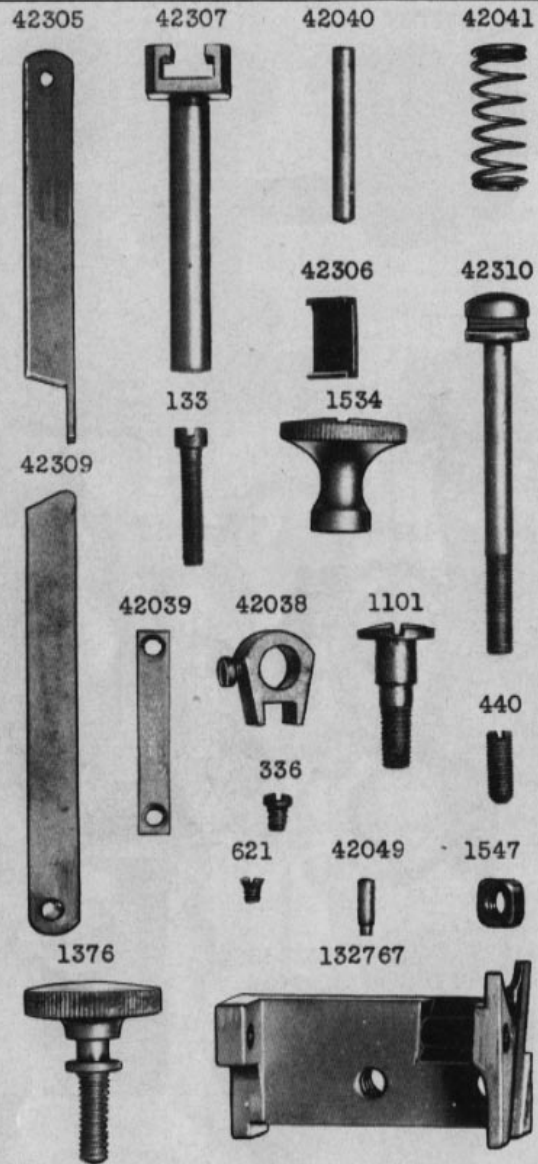


PLATE 20821-FULL SIZE

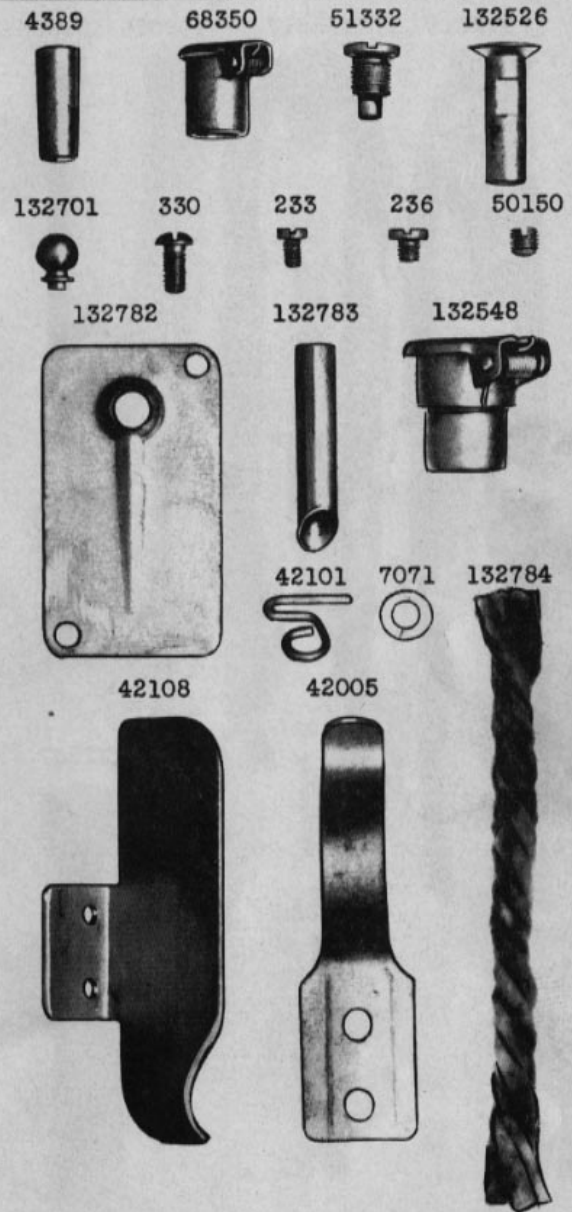
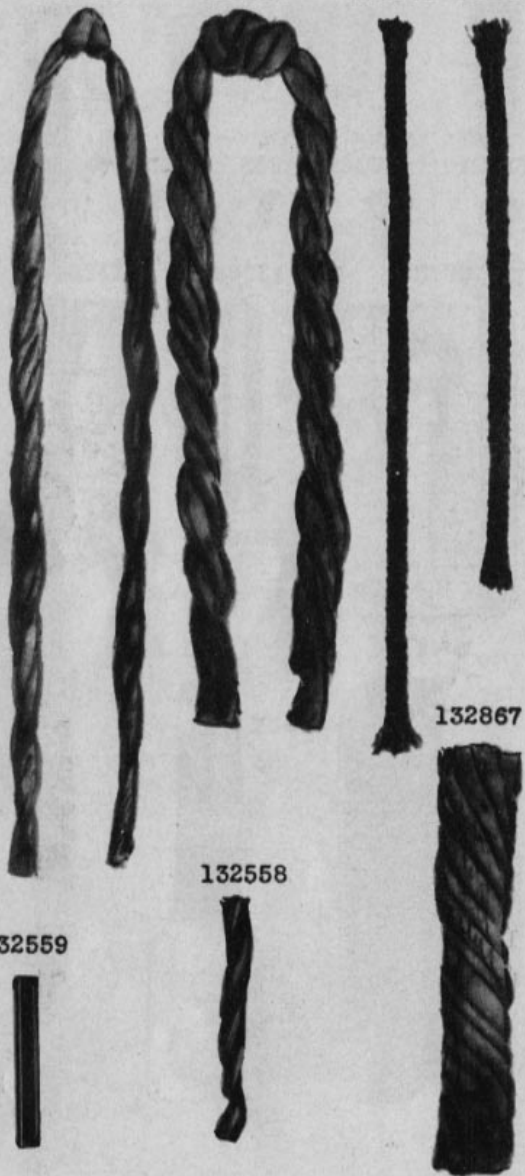


PLATE 20823-FULL SIZE

132816 132817 132864 132868



132867

132558

132559

PLATE 20824-FULL SIZE

42130 42132 42131

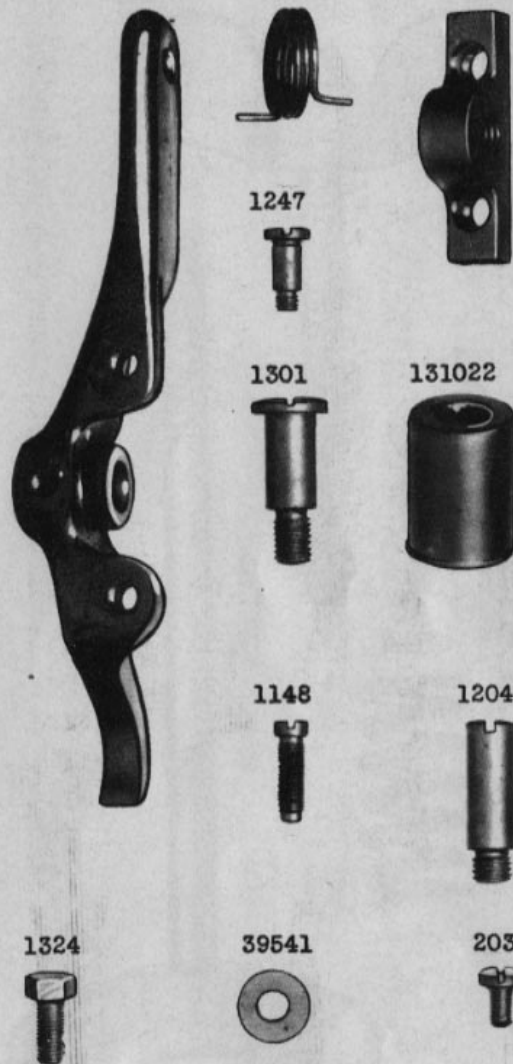


PLATE 20826-FULL SIZE

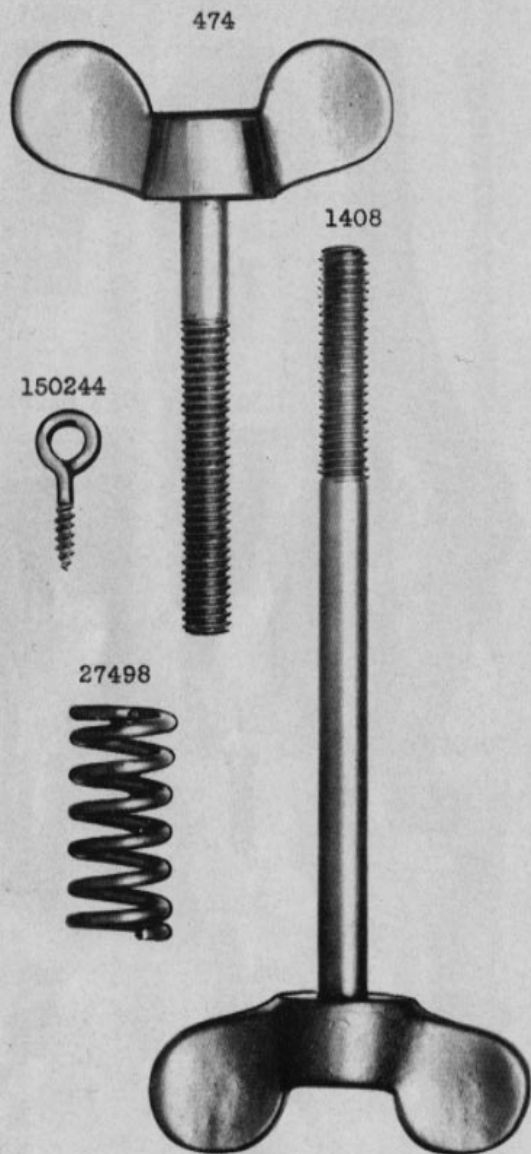
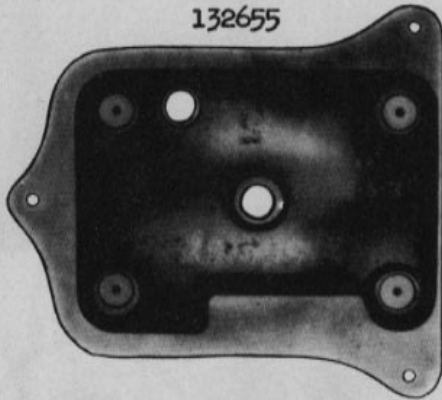


PLATE 20828-ONE-HALF SIZE



PLATE 20830-ONE-FOURTH SIZE

132655



41329

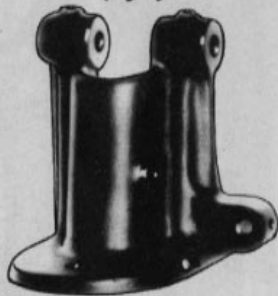
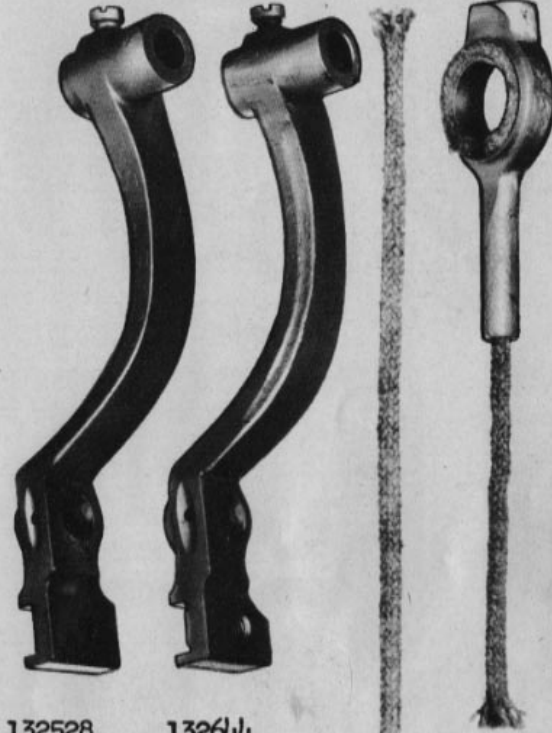


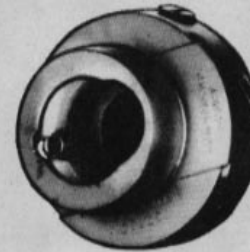
PLATE 20831 - FULL SIZE

42006 . 42205 132537 132785



132528

132644



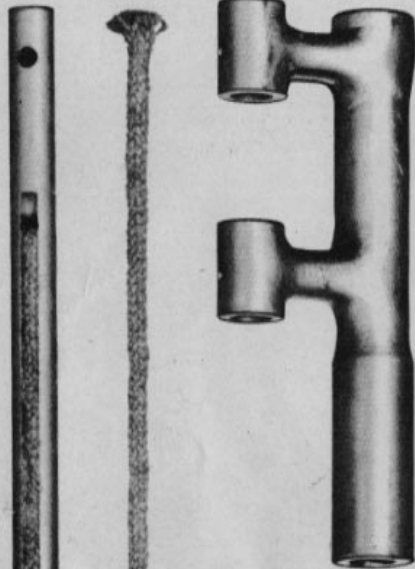
132712



PLATE 20832 - FULL SIZE

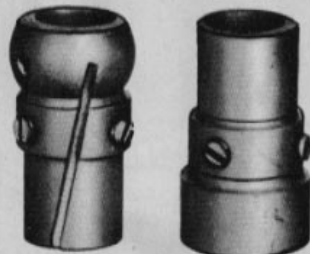
132542 132544

132625



132649

132635



132543

132539

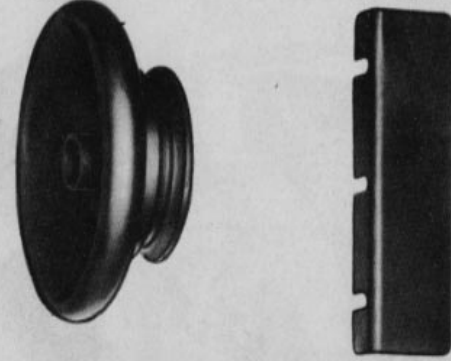
42021



PLATE 20833 - ONE-HALF SIZE

132632

132654

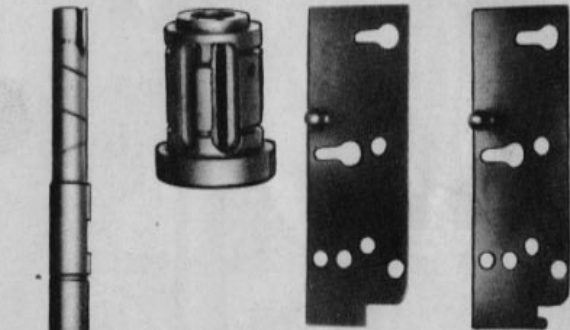


132819

132865

132638

132560



42028

132906

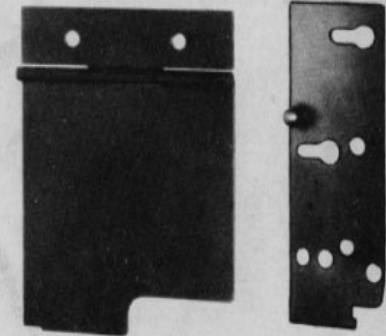


PLATE 20834 - FULL SIZE

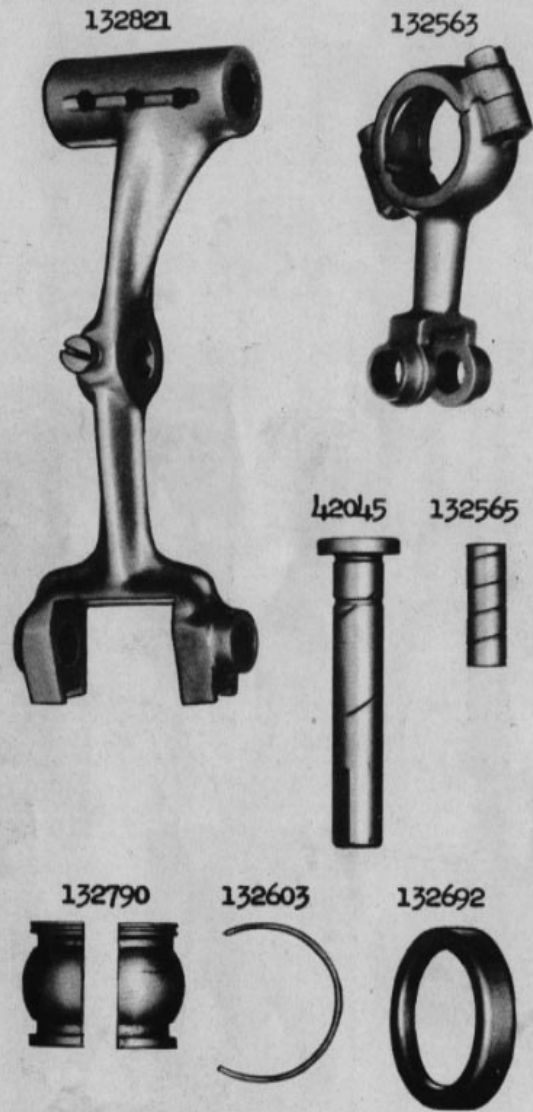


PLATE 20835 - FULL SIZE

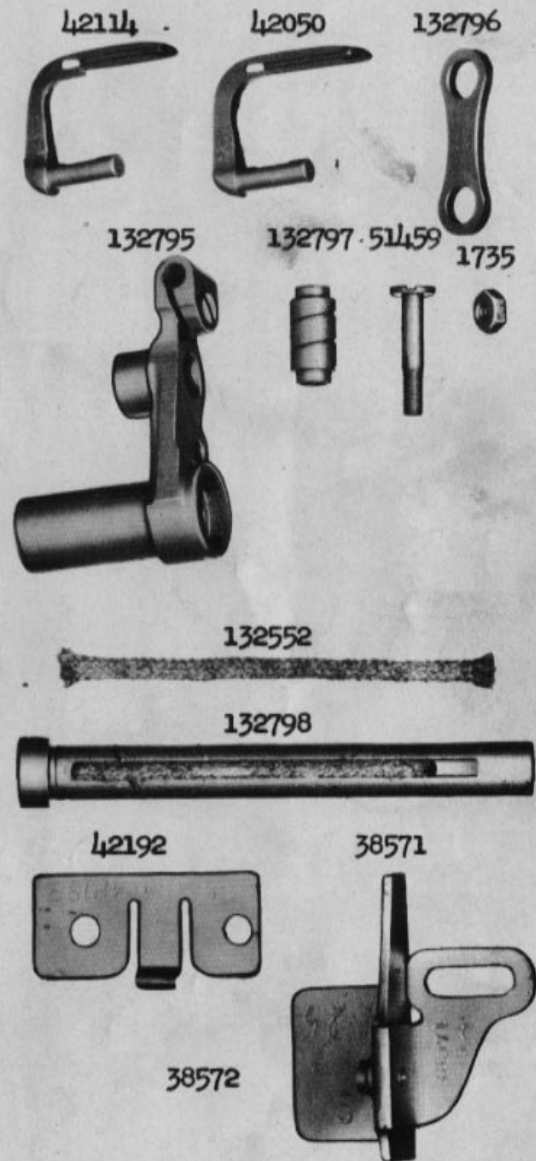
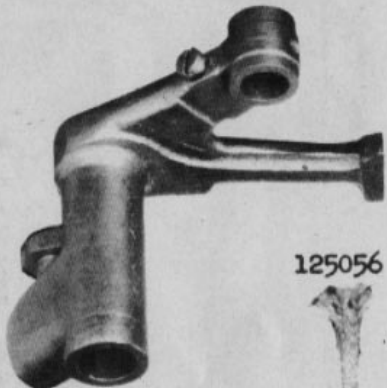


PLATE 20836 - FULL SIZE

132699



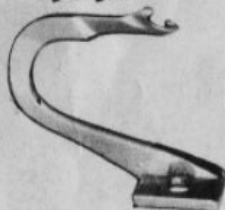
132799



125056



132631



132907



132630



PLATE 20837 - FULL SIZE

42054 132908 42253 132739 132580



132581



132621



132598



132740



132582



132583



132584



132910



PLATE 20838 - FULL SIZE

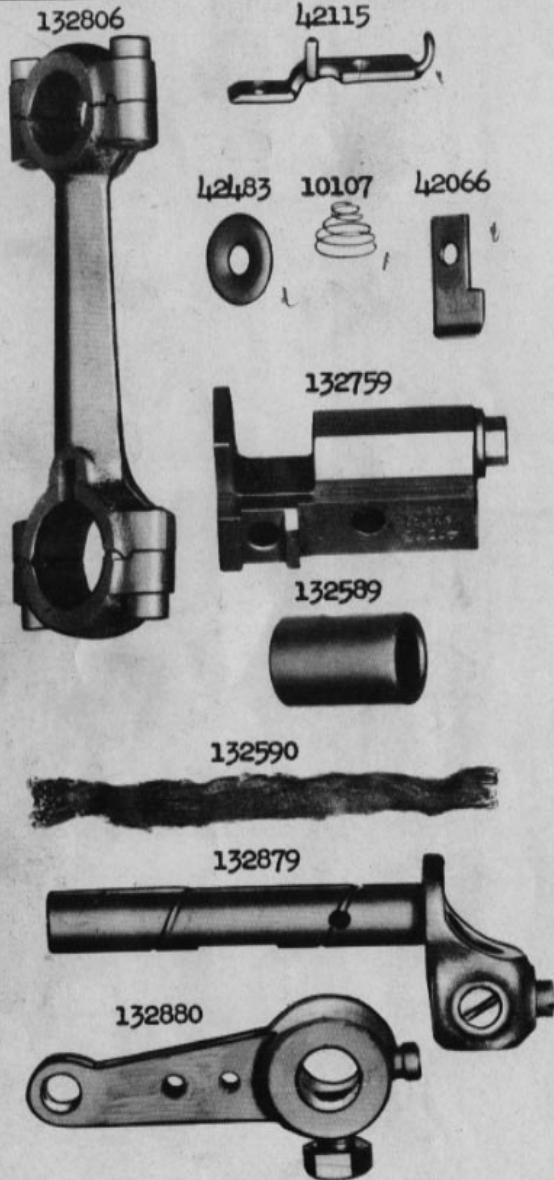


PLATE 20839 - FULL SIZE

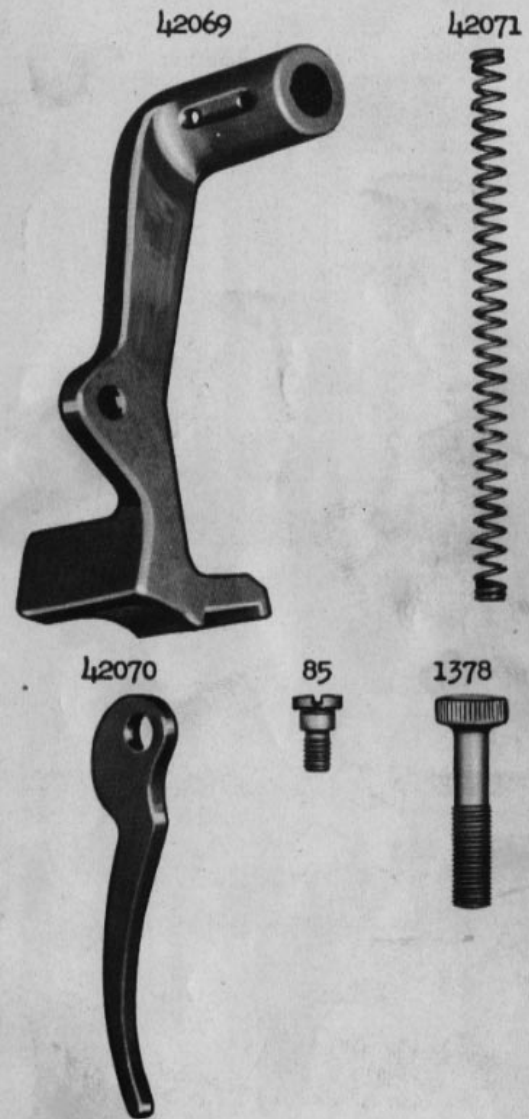


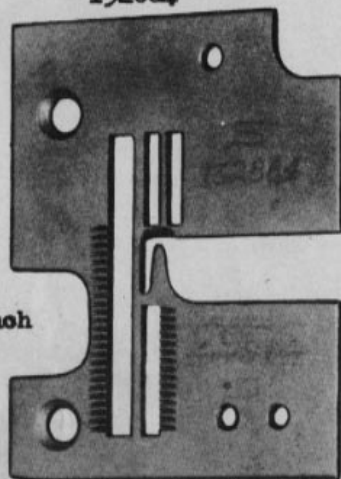


PLATE 20840 - FULL SIZE

42267

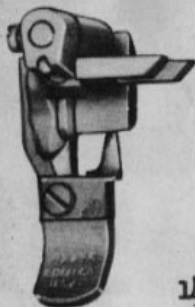


132884



16 teeth = 1 inch

132637



42268



14058

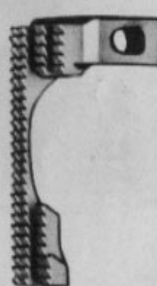


62527

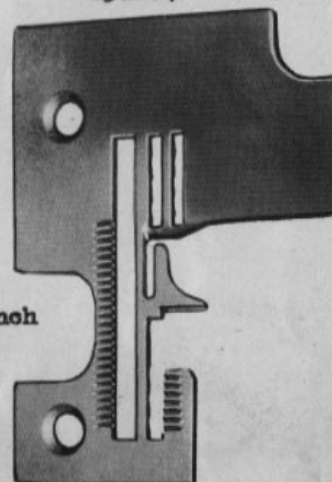


PLATE 20841 - FULL SIZE

132851



132824



16 teeth = 1 inch

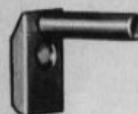
132823



132682



132609



132610



132611



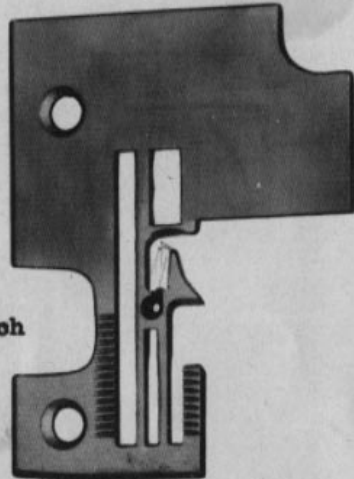
PLATE 20842 - FULL SIZE

132905



16 teeth = 1 inch

132915



42461



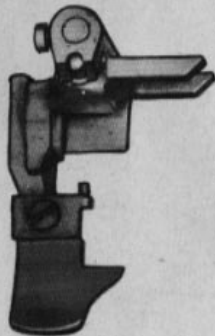
50093



132916



132911



42172



42404



132912

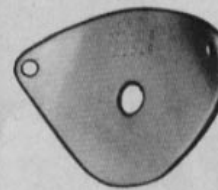


PLATE 20843 - FULL SIZE

17547



57076



132913



51570



193



50326



50148



50261



59534



59535



59537



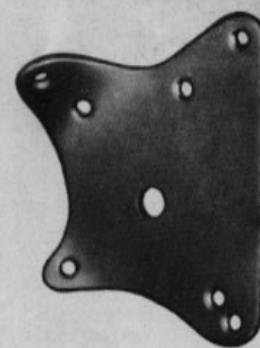
59538



2102



42082



132599



PLATE 20844 - FULL SIZE

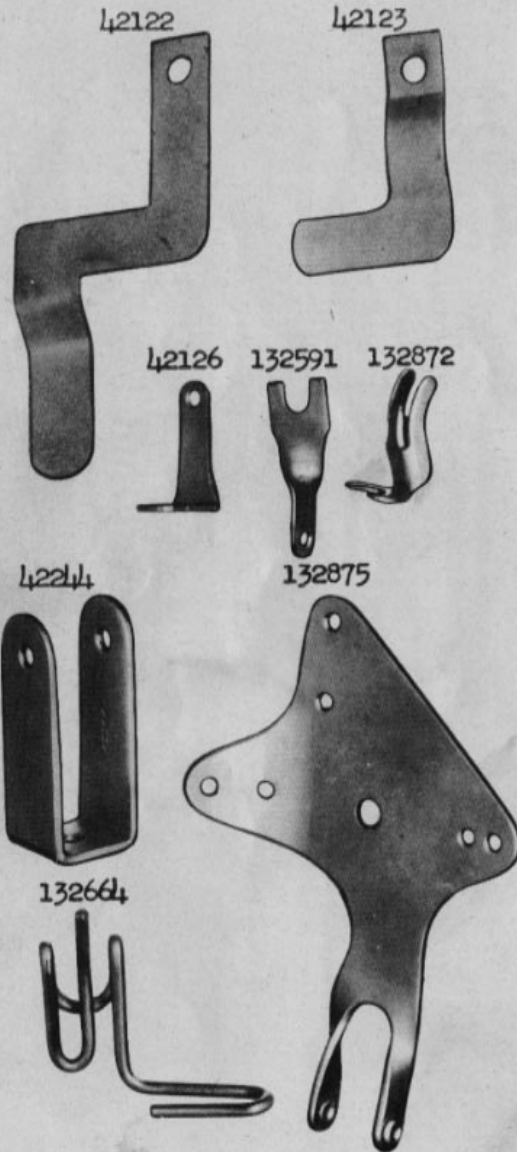


PLATE 20845 - FULL SIZE

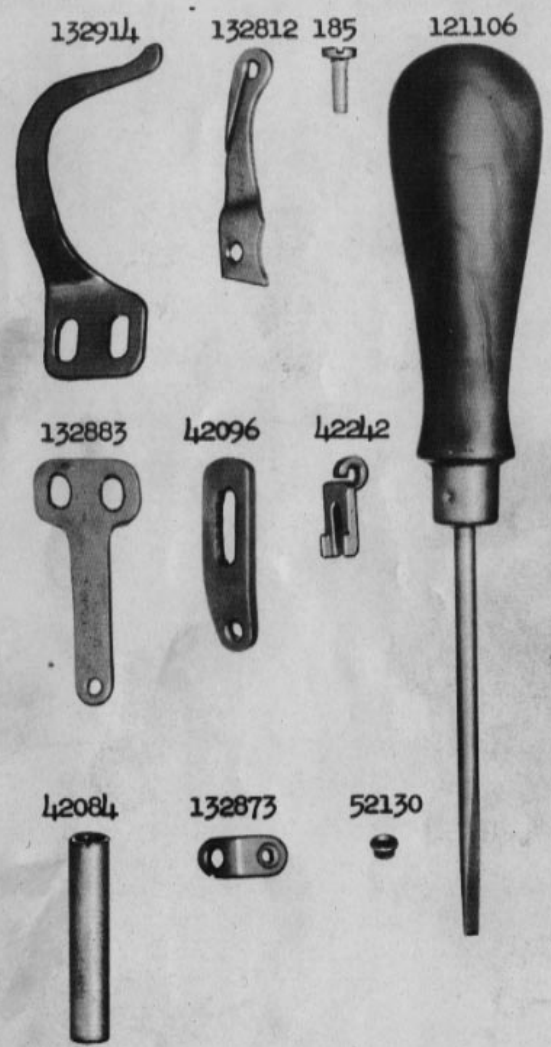


PLATE 20846 - FULL SIZE

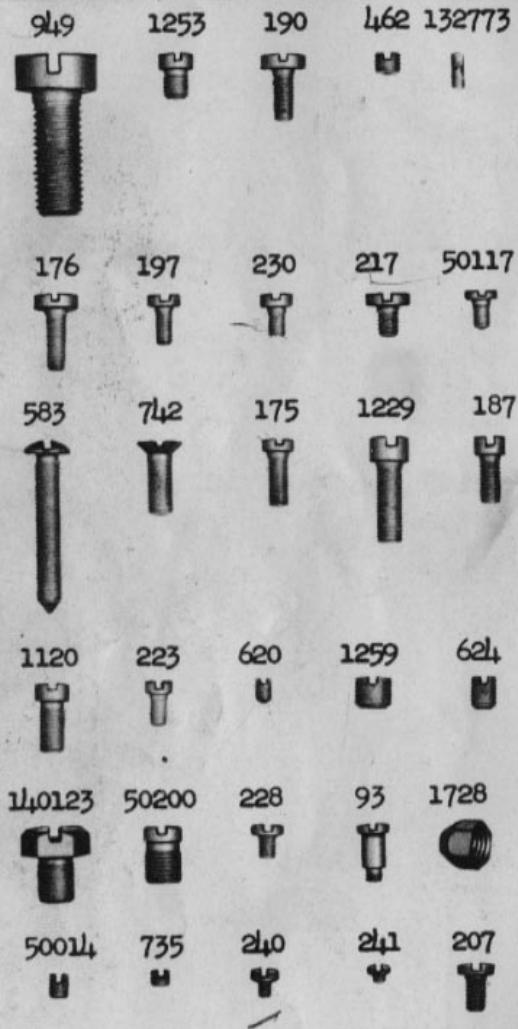


PLATE 20847 - ONE-HALF SIZE

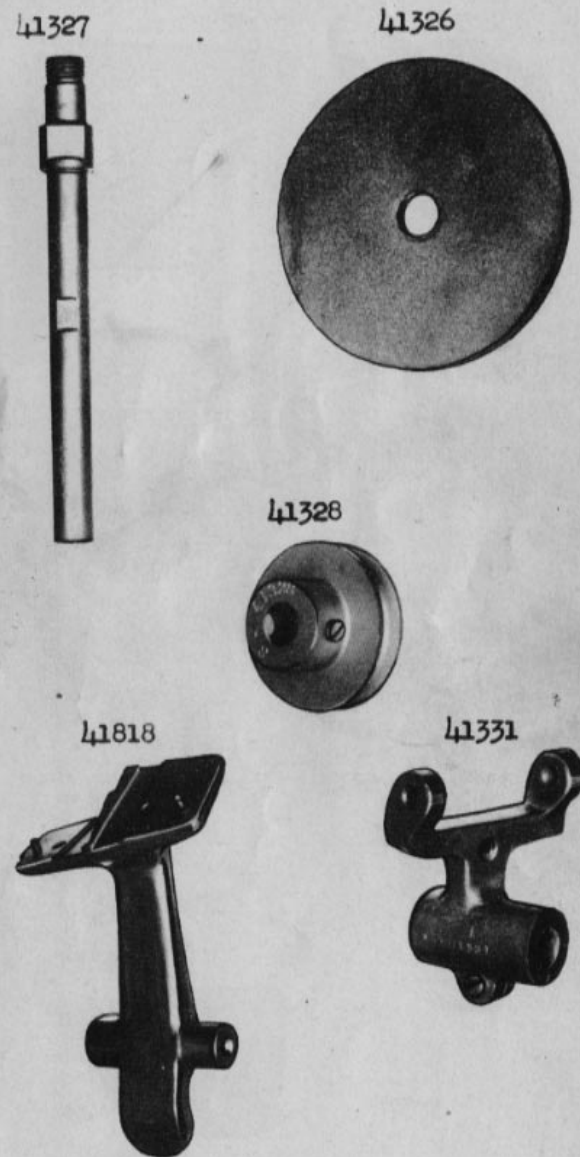
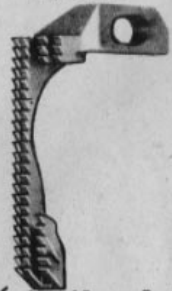


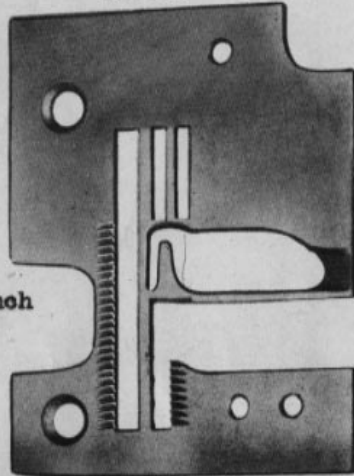
PLATE 20848 - FULL SIZE

132818

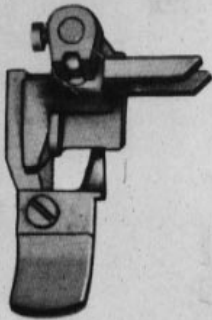


16 teeth = 1 inch

132825



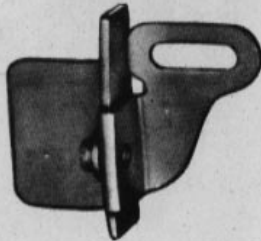
132637



42268



121416



38572

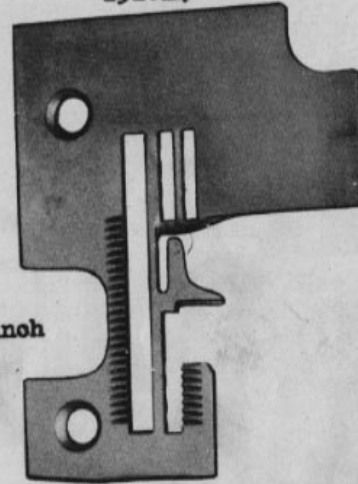
PLATE 20849 - FULL SIZE

132826



10 teeth = 1 inch

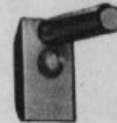
132824



132828



132609

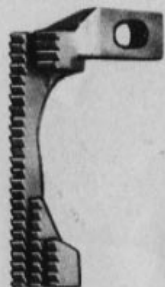


132827



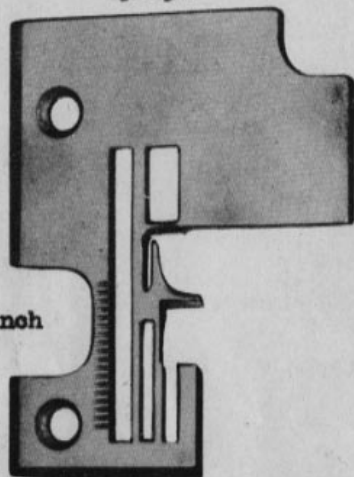
PLATE 20850 - FULL SIZE

132829

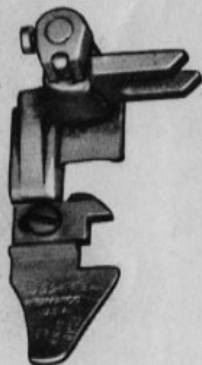


16 teeth = 1 inch

132832



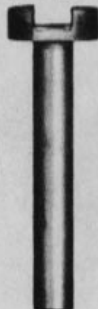
132831



42213



42035



132830



42214



42037



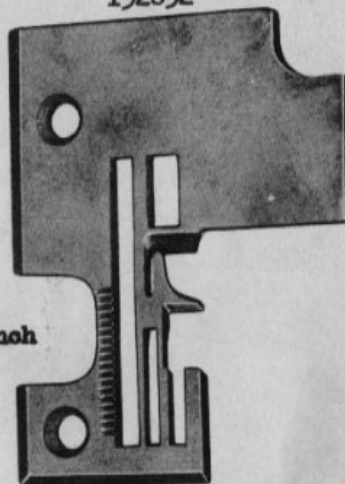
PLATE 20851 - FULL SIZE

132829



16 teeth = 1 inch

132852



132854



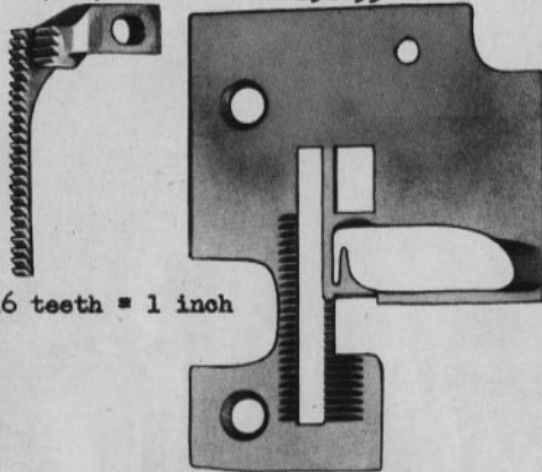
132853



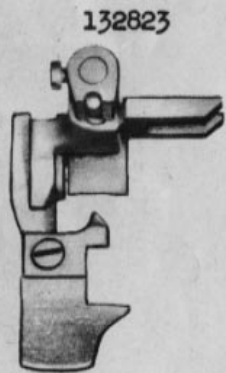
PLATE 20852 - FULL SIZE

42109

132833



16 teeth = 1 inch



132823

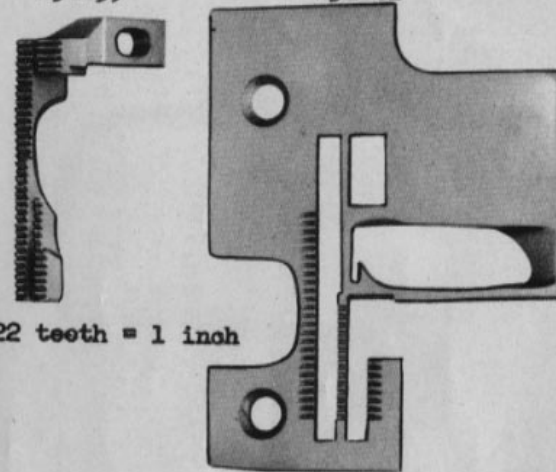


132682

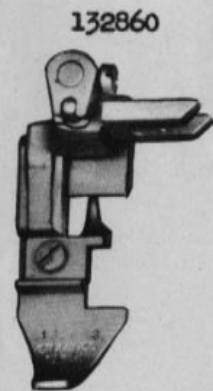
PLATE 20853 - FULL SIZE

132859

132861



22 teeth = 1 inch



132860

132608



PLATE 20854 - ONE-HALF SIZE

132786

