

Form 8317
June, 1916

PRICE LIST

OF

PARTS



MACHINE No. 86-13

THE SINGER MANUFACTURING COMPANY

COPYRIGHT, U. S. A., 1916, BY THE SINGER MANUFACTURING CO.

INDEX

	PAGE
ACCESSORIES.....	17
FOOT LIFTER PARTS.....	17
IRON BASE.....	17
LAP SEAM FELLER.....	18
MACHINE NO. 86-13.....	7
NUMERICAL LIST OF PARTS.....	21
OBSOLETE PARTS.....	19
THREAD UNWINDER.....	18

INSTRUCTIONS FOR ORDERING

In ordering from this list, use ONLY the part NUMBER in the FIRST column.

The number stamped on a Sewing Machine part is in every case the number of the single part only.

Every combination of parts sent out as such has its specific number, which, although not stamped on the parts, must be used when ordering the combination.

Each number always indicates the SAME PART in whatever list it appears, or for whatever machine.

The letters after some of the numbers indicate the style of finish only, as follows:

- A. Hardened, Polished and Plated.
- B. Polished and Plated.
- C. Hardened only.
- D. Polished only.
- E. Soft, not Polished.
- F. Hardened and Polished.
- G.
- H. Blued.
- J. Plated only.
- K. Hardened and Plated.
- L. Brass or Gilt.
- M. Oxidized.
- P. Japanned.

These letters MUST BE USED when they appear in the list, and AFTER the number as in the list.

In this series

- 1 to 1500 and 50001 to 51500 are Screw Numbers.
- 1501 to 1800 are Nut Numbers.
- 1801 to 2000 are Roller Numbers.
- 2001 to 50000 and 52001 and upward are numbers of Machine Parts.

The figures in the second column refer only to the plates, illustrating the parts, and are NOT TO BE USED in ordering.

Parts marked with an asterisk (*) are furnished only when repairs are made at factory.

When ordering parts which differ as to GAUGE (the distance between seams) the GAUGE as well as the NUMBER MUST BE GIVEN on order.

LIST OF PARTS COMPLETE

FOR

MACHINE NO. 86-13

FOR TWO-LINE STITCHING ON SHIRTS, PAJAMAS, MEDIUM AND LIGHT WEIGHT MATERIAL, TWO NEEDLES, TWO LOOPERS, DOUBLE CHAIN STITCH, GAUGES $\frac{1}{8}$, $\frac{5}{32}$, $\frac{3}{16}$, $\frac{7}{32}$ AND $\frac{1}{4}$ INCH, OUTSIDE STITCH REGULATING DEVICE, DROP FEED, FOOT LIFTER. SUPERSEDES NO. 86-10 MACHINE

NO.	PLATE	NAME	EACH
*54912	—	Arm.....	\$20 00
54913	6367	" Back Cover.....	60
54914	—	Arm Back Cover complete, Nos. 1538H, 50223D, 54913, 54915, 54916 and two 1443H.....	1 20
54915	6369	Arm Back Cover Latch with 911D.....	30
50223D	6385	" " " " Hinge Screw.....	06
	911D	6369 " " " " Screw Stud.....	03
	1538H	6369 " " " " " " Thumb Nut.....	06
54916	6369	Arm Back Cover Spring.....	10
	1443H	6385 " " " " Screw.....	04
54897	6384	" Oil Cup.....	10
54917	6384	" " Tube for oiling 54941.....	03
54918	6368	" Rock Shaft.....	1 00
54919	6369	" " " Bushing (back).....	25
50224C	6385	" " " " " Set Screw.....	10
54920	6369	" " " " (front).....	25
	888C	6385 " " " " " Set Screw.....	05
54921	6371	" " " Collar with two 456C.....	30
	456C	6385 " " " " Set Screw.....	02
54603	6371	" " " Crank (back) with two 50135C.....	1 00
50135C	6371	Arm Rock Shaft Crank (back) Set Screw.....	06
54776	6371	" " " " (front) with two 50135C.....	1 00
50135C	6371	Arm Rock Shaft Crank (front) Set Screw.....	06
54922	6368	" Side Cover.....	10
	286D	6385 " " " Thumb Screw.....	10
54923	6367	Belt Cover.....	60
	134D	6385 " " Screw.....	05
54885	6367	Cloth Plate (left) with 54889 and two 4621.....	1 60
54886	6367	" " (right).....	1 50

NO.	PLATE	NAME	EACH
54887	6367	Cloth Plate Bracket with 345c.....\$	40
345c	6369	" " " Screw.....	10
50217D	6369	" " Screw.....	08
54888	6369	" " Spring.....	25
237D	6369	" " " Guide Screw.....	02
50218c	6369	" " " Lock Screw.....	05
54889	6369	" " " Packing.....	25
4621	6369	" " " " Rivet, per 100	25
219D	6385	" " " Screw.....	02
54890	—	Cloth Plate complete, Nos. 219D, 237D, 50218c, 54885, 54886 and 54888.....	3 45
54891	—	Cloth Plate with Bracket complete, Nos. 54887, 54890 and two 50217D.....	4 00
54924	6368	Crank Connecting Rod complete, Nos. 1722E, 1723E, 54616, 54617, 54925 and 54926.....	3 75
*54925	—	Crank Connecting Rod (rod only).....	50
50127c	6371	" " " Ball Screw Stud	20
1520E	6371	" " " " " " "	—
		Nut.....	03
*54612	—	Crank Connecting Rod Cap (lower).....	—
896E	6385	" " " " " " Screw	04
*54613	—	" " " " " (upper).....	—
175E	6385	" " " " " " Screw	02
*54614	—	" " " " End Bearing	—
		(lower).....	—
*54615	—	Crank Connecting Rod End Bearing	—
		(upper).....	—
*54616	—	Crank Connecting Rod Head (lower) Nos. 54612, 54614 and two 896E.....	1 50
*54617	—	Crank Connecting Rod Head (upper) Nos. 50127c, 54613, 54615 and two 175E.....	1 50
1722E	6372	Crank Connecting Rod Nut (lower).....	03
1723E	6372	" " " " (upper).....	03
54926	6371	" " " Position Pin and Bracket (solid).....	15
*54927	—	Cylinder with 460c, 54643, 54664, 54943, 54944 and two 391D.....	12 00
54620	6384	Cylinder Dowel Pin.....	05
54859	—	" End Cover.....	1 00
55021	6383	Cylinder End Cover complete, Nos. 54859, 55022, 55023 and two each 220E, 994c and 54628.....	2 15
54623	6369	Cylinder End Cover Lock Spring.....	05
54624	6369	" " " " " " C a p	25
189D	6385	" " " " " " "	—
		Screw.....	02

NO.	PLATE	NAME	EACH
55022	—	Cylinder End Cover Slide.....\$	60
55023	6383	" " " " " Gib.....	40
994c	6369	" " " " " Adjusting Screw.....	04
220E	6369	Cylinder End Cover Slide Gib Screw.....	02
54628	6384	" " " " " Rivet.....	01
54643	6384	" Oil Tube.....	03
54928	6368	" Rock Shaft (lower) with 54704.....	1 50
54929	6369	" " " " " Bushing.....	75
447c	6385	" " " " " " Set Screw.....	03
54930	6372	Cylinder Rock Shaft (lower) Eccentric	1 50
50225D	6385	" " " " " " " Adjusting Screw.....	03
54931	6372	Cylinder Rock Shaft (lower) Eccentric Connecting Rod with 54932 and two 171E.....	1 00
*54932	—	Cylinder Rock Shaft (lower) Eccentric Connecting Rod Cap.....	—
171E	6385	Cylinder Rock Shaft (lower) Eccentric Connecting Rod Cap Screw.....	03
54933	6372	Cylinder Rock Shaft (lower) Eccentric Connecting Rod Stud with 207E.....	50
207E	6371	Cylinder Rock Shaft (lower) Eccentric Connecting Rod Stud Clamping Screw.....	02
103D	6385	Cylinder Rock Shaft (lower) Eccentric Hinge Screw.....	04
54704	6372	Cylinder Rock Shaft (lower) Key.....	20
54781	6368	" " " " (upper).....	1 00
54934	6372	" " " " " Collar with two 465c.....	25
465c	6385	Cylinder Rock Shaft (upper) Collar Set Screw.....	02
54632	6372	Cylinder Rock Shaft (upper) Crank with two 457c.....	75
54935	6372	Cylinder Rock Shaft (upper) Crank Con- necting Link.....	75
457c	6372	Cylinder Rock Shaft (upper) Crank Set Screw.....	02
54936	6372	Cylinder Rock Shaft (upper) Eccentric with 457c and 624c.....	1 00
54937	6373	Cylinder Rock Shaft (upper) Eccentric Connecting Rod with 54939, 54940 and two each 171E and 896E.....	1 50
54938	6372	Cylinder Rock Shaft (upper) Eccentric Connecting Rod Ball Stud.....	35

NO.	PLATE	NAME	EACH
624c	6372	Cylinder Rock Shaft (upper) Eccentric Connecting Rod Ball Stud Set Screw. \$	03
*54939	—	Cylinder Rock Shaft (upper) Eccentric Connecting Rod Cap (lower).....	—
171E	6385	Cylinder Rock Shaft (upper) Eccentric Connecting Rod Cap (lower) Screw....	03
*54940	—	Cylinder Rock Shaft (upper) Eccentric Connecting Rod Cap (upper).....	—
896E	6385	Cylinder Rock Shaft (upper) Eccentric Connecting Rod Cap (upper) Screw....	04
54941	6372	Cylinder Rock Shaft (upper) Eccentric Connecting Rod Lever with 624c.....	2 00
54942	6374	Cylinder Rock Shaft (upper) Eccentric Connecting Rod Lever Hinge Stud....	50
446c	6385	Cylinder Rock Shaft (upper) Eccentric Connecting Rod Lever Hinge Stud Set Screw.....	03
54671	6374	Cylinder Rock Shaft (upper) Eccentric Connecting Rod Position Pin and Bracket (solid).....	15
1100D	6385	Cylinder Rock Shaft (upper) Eccentric Connecting Rod Position Pin and Bracket Screw.....	02
624c	6372	Cylinder Rock Shaft (upper) Eccentric Position Screw.....	03
457c	6372	Cylinder Rock Shaft (upper) Eccentric Set Screw.....	02
134D	6385	Cylinder Screw.....	05
54662	6374	" " Thread Cover.....	25
767D	6385	" " " " Screw.....	02
*54943	—	" " Top Cover (back).....	75
54664	6384	" " " " Hinge Pin....	05
460c	6385	" " " " " " Set Screw.....	02
*54944	—	Cylinder Top Cover (front) with 665D and 54666.....	75
391D	6385	Cylinder Top Cover (front) Screw.....	02
54666	6374	" " " " Spring.....	05
665D	6374	" " " " " " Screw.....	02
54945	6368	Face Plate with two 2827.....	60
46111	6384	" " Pin.....	02
2827	6382	" " Thread Guard with 8505.....	02
8505	6382	" " " " Rivet...per 100	10
286D	6385	" " Thumb Screw.....	10
55010	6386	Feed Dog, for $\frac{1}{8}$ in. to $\frac{3}{16}$ in. gauge.....	1 75
55018	6386	" " " $\frac{1}{2}$ in. to $\frac{1}{4}$ in. gauge.....	1 75
55011	6386	" " Adjusting Wedge.....	25

NO.	PLATE	NAME	EACH
54948	6370	Feed Dog Carrier with two 462c.....	\$ 1 50
462c	6385	" " " Set Screw.....	02
54949	6374	" " " Slide Block.....	50
50226c	6374	" " " " " " Screw.....	10
50128c	6386	" " Screw.....	04
54863	6370	" Eccentric.....	1 35
103D	6385	" " Adjusting Screw.....	04
54865	6374	" " " " Friction Washer.....	01
54950	6370	Feed Eccentric Flange with two 440E....	1 00
440F	6385	" " " Adjusting Screw..	03
440F	6385	" " " Set Screw.....	03
103D	6385	" " Hinge Screw.....	04
54865	6374	" " " " Friction Washer.....	01
54951	6374	Feed Lifting Eccentric with 457c and 624c.....	1 00
624c	6372	Feed Lifting Eccentric Position Screw....	03
457c	6372	" " " Set Screw.....	02
54952	6373	" " Lever.....	1 00
54953	6373	" " " Connecting Rod with 54940 and two 896E.....	1 00
*54940	—	Feed Lifting Lever Connecting Rod Cap " " " " " " " "	—
896E	6385	Screw.....	04
50227c	6385	Feed Lifting Lever Connecting Rod Hinge Screw.....	12
1620E	6385	Feed Lifting Lever Connecting Rod Hinge Screw Nut.....	03
324c	6385	Feed Lifting Lever Screw Centre.....	06
54954	6374	" Regulating Lever.....	50
54955	6374	" " " Bracket.....	75
127E	6374	" " " " " " Screw....	04
974c	6374	" " " Hinge Screw.....	06
54956	6374	" " " Spring.....	02
2269	6374	" " " Stop Pin.....	01
54957	6370	" Regulator.....	2 00
54958	6370	" " Friction Spring.....	10
54959	6373	Feed Rod complete, Nos. 1722E, 54948, 54960 and 54963.....	4 00
54960	6373	Feed Rod (rod only).....	1 00
*54961	—	" " Cap.....	—
896E	6385	" " " Screw.....	04
*54962	—	" " End Bearing.....	—
54963	—	" " Head, Nos. 54961, 54962 and two 896E.....	1 50
1722E	6372	Feed Rod Nut.....	03

NO.	PLATE	NAME	EACH
54964	6367	Hand Wheel and Pulley with 430c and 1299c	\$ 1 50
430c	6385	Hand Wheel and Pulley Set Screw (long)	04
1299c	6385	" " " " " " (short)	03
54965	6373	" " " " Shaft	3 50
54966	6373	" " " " Bushing (left)	35
54967	6384	Hand Wheel and Pulley Shaft Bushing (left) Oil Pad (braided cotton)	01
888c	6385	Hand Wheel and Pulley Shaft Bushing (left) Set Screw	05
54968	6373	Hand Wheel and Pulley Shaft Bushing (right)	1 00
54969	6384	Hand Wheel and Pulley Shaft Bushing (right) Oil Pad (braided cotton)	01
895c	6385	Hand Wheel and Pulley Shaft Bushing (right) Set Screw	05
54970	6384	Hand Wheel and Pulley Shaft Washer	05
54785	6371	Looper (back)	2 25
465c	6385	" " Set Screw	02
54786	6371	" (front) with 54707	2 25
55005	6371	" " Needle Guard	40
665d	6374	" " " " Screw	02
54707	6371	" " " " Steady Pin, per 100	25
465c	6385	Looper (front) Set Screw	02
54788	6371	" Carrier with two each 185h and 465c	5 00
185h	6371	Looper Carrier Adjusting Screw	02
54692	6371	" " Hinge Pin	20
620c	6385	" " " " Set Screw	02
55013	6371	" " Holder with 211f and 620c	1 50
211f	6371	Looper Carrier Holder Clamping Screw	02
54694	6371	" " Slide Block (two pieces) with 54695 and two 54705	2 00
*54695	—	Looper Carrier Slide Block Ball Stud	40
208d	6371	" " " " " " Clamping Screw	02
54973	6371	Looper Carrier Slide Block Holder with 202d and 208d	75
202d	6377	Looper Carrier Slide Block Holder Clamping Screw	02
54705	6371	Looper Carrier Slide Block Pin	25
54708	6368	Needle Bar (hollow)	1 00
54846	—	Needle Bar complete, Nos. 54708 and 54847	1 60

NO.	PLATE	NAME	EACH
54710	6370	Needle Bar Bushing (lower)	\$ 25
563c	6385	" " " " Set Screw	04
54974	6370	" " " " (upper)	40
563c	6385	" " " " Set Screw	04
54711	6370	" " Connecting Link	75
54712	6370	" " " " Hinge Stud	15
1520e	6371	" " " " " " Nut	03
54713	6371	Needle Bar Connecting Stud with 207e	50
207e	6371	" " " " Clamping Screw	02
54847	6371	Needle Clamp with 46478 and two 1498e	60
46478	6371	" " Thread Guide	02
54975	6370	" Guard (back)	40
233d	6385	" " " Screw	02
54976	6370	" " (front)	40
233d	6385	" " " Screw	02
54977	6370	" " Holder	75
185h	6371	" " " Screw	02
1498f	6385	" Set Screw	02
55008	6378	Presser Bar	25
54978	6378	" " Bushing	50
563c	6385	" " " Set Screw	04
54718	6378	" " Guide Bracket with 207d	50
207d	6371	" " " Clamping Screw	02
54719	6378	Presser Bar Lifter	35
50228c	6378	" " " Hinge Screw	12
54979	6378	" " Lifting Bracket with 1492d	75
1492d	6378	" " " " Clamping Screw	03
54980	6388	Presser Bar Spring (flat)	50
54722	6384	" " " Stud	01
26276	6384	" Foot Hinge Pin	01
55014	—	" " Plate	1 50
54819	—	" " Shank	75
55015	6386	Presser Foot (hinged) complete for 55010, Nos. 26276, 54819 and 55014	2 25
26276	6384	Presser Foot Hinge Pin	01
54838	—	" " Plate	1 50
54819	—	" " Shank	75
54839	6386	Presser Foot (hinged) complete for 55018, Nos. 26276, 54819 and 54838	2 25
26276	6384	Presser Foot Hinge Pin	01
55014	—	" " Plate	1 50
55024	—	" " Shank	75

NO.	PLATE	NAME	EACH
18054	6387	Presser Foot Spring.....	\$ 02
55025	6387	" " (spring hinged) complete for 55010 and 55018, Nos. 18054, 26276, 55014 and 55024.....	2 25
190D	6385	Presser Foot Screw.....	03
50132D	6385	Pressure Regulating Thumb Screw.....	10
1543D	6385	" " " " Lock Nut.....	05
54984	6378	Slack Thread Regulator with 662D and 54986.....	1 50
203C	6385	Slack Thread Regulator Screw.....	03
55012	6386	" " " Spring.....	05
54732	6378	" " " " Bracket.....	40
203C	6385	" " " " " Screw.....	03
1425D	6378	Slack Thread Regulator Spring Screw....	06
54986	6378	" " " " Stop.....	05
662D	6378	" " " " " Screw.....	02
2102	6380	Tension (under thread) Disc.....	05
1560C	6380	" " " R e g u l a t i n g Thumb Nut.....	04
828C	6380	Tension (under thread) Screw Stud (lower).....	08
916C	6380	Tension (under thread) Screw Stud (upper).....	08
1547D	6380	Tension (under thread) Screw Stud (upper) Nut.....	03
10148	6380	Tension (under thread) Spring.....	03
38145	6378	" " " Thread Guide....	50
54987	6380	" (upper thread) Bracket.....	75
376D	6380	" " " " Screw....	05
2102	6380	" " " Disc.....	05
1560C	6380	" " " R e g u l a t i n g Thumb Nut.....	04
32572	6380	Tension (upper thread) Releasing Disc....	05
54988	6380	" " " " Pin....	01
54989	6380	" " " " Shaft.....	50
54872	6381	" " " " " Crank with 624c.....	1 00
54873	6381	Tension (upper thread) Releasing Shaft Crank Link.....	50
110D	6385	Tension (upper thread) Releasing Shaft Crank Link Hinge Screw.....	04
624C	6372	Tension (upper thread) Releasing Shaft Crank Set Screw.....	03
54990	6380	Tension (upper thread) Releasing Shaft Spring.....	05

NO.	PLATE	NAME	EACH
316F	6380	Tension (upper thread) Releasing Shaft Stop Screw.....	\$ 03
1547D	6380	Tension (upper thread) Releasing Shaft Stop Screw Nut.....	03
50133C	6380	Tension (upper thread) Screw Stud.....	12
54738	6380	" " " Spring.....	05
17547	6380	" " " Thread Guide....	25
54991	6381	Thread (under) Nipper Bracket.....	1 25
190D	6385	" " " " Screw....	03
54992	6381	" " " Connecting Rod with 54993 and two 171E.....	1 00
*54993	—	Thread (under) Nipper Connecting Rod Cap.....	—
171E	6385	Thread (under) Nipper Connecting Rod Cap Screw.....	03
999D	6385	Thread (under) Nipper Connecting Rod Hinge Screw.....	05
54874	6381	Thread (under) Nipper Eccentric with 465c.....	30
465C	6385	Thread (under) Nipper Eccentric Set Screw.....	02
54740	6381	Thread (under) Nipper Spring.....	10
233D	6385	" " " " Screw.....	02
54875	6381	" " Pull-off with 465c.....	70
465C	6385	" " " Set Screw.....	02
54898	6381	" " " Thread Guard with 459F.....	1 00
1145D	6381	Thread (under) Pull-off Thread Guard Hinge Screw.....	03
459F	6381	Thread (under) Pull-off Thread Guard Stop Screw.....	04
54827	6381	Thread (under) Pull-off Thread Guard and Thread (under) Take-up Thread Guard Spring.....	05
54828	6381	Thread (under) Pull-off Thread Guard and Thread (under) Take-up Thread Guard Spring Stop Pin.....	01
54801	6384	Thread (under) Separating Pin for 54807.	02
54994	6381	" " Separator.....	10
337D	6381	" " " Screw.....	02
54876	6382	" " Take-up with 465c.....	1 25
54995	6382	" " " Eccentric with 417c.....	1 00
447C	6385	Thread (under) Take-up Eccentric Set Screw.....	03
465C	6385	Thread (under) Take-up Set Screw.....	02
54996	6382	" " " Shaft.....	1 25

NO.	PLATE	NAME	EACH
50229c	6385	Thread (under) Take-up Shaft Screw Centre.....	\$ 06
462c	6385	Thread (under) Take-up Shaft Screw Centre Set Screw.....	02
54899	6382	Thread (under) Take-up Thread Guard with 459F.....	75
1145D	6381	Thread (under) Take-up Thread Guard Hinge Screw.....	03
459F	6381	Thread (under) Take-up Thread Guard Stop Screw.....	04
54997	6382	Thread (upper) Controller.....	25
54806	6382	" " " Lever.....	40
54879	6382	" " " " C o n - nection.....	50
999F	6385	Thread (upper) Controller Lever Connection Hinge Screw.....	05
974D	6374	Thread (upper) Controller Lever Hinge Screw.....	06
54758	6382	Thread (upper) Controller Post.....	50
743c	6382	" " " " Set Screw.....	05
219F	6385	" " " Screw.....	02
55016	6382	" " Take-up.....	10
217F	6382	" " " Screw.....	03
54807	6383	" Tube with 54801.....	75
54808	—	" " 54807 with 54772.....	1 00
54772	6382	" " Bracket.....	25
1484F	6382	" " " Screw.....	03
54761	6384	" " for 54927.....	10
54905	6386	Throat Plate for 55010.....	3 00
55019	6386	" " " 55018.....	3 00
1319F	6386	" " " Screw.....	04

IRON BASE

NO.	PLATE	NAME	EACH
54998	6367	Machine Base with three wood screws 1½ in. No. 12 and four each 935D and 42088.....	\$ 2 00
42088	6384	Machine Cushion (felt).....	02
935D	6384	" " Screw.....	04

ACCESSORIES

NO.	PLATE	NAME	EACH
1407J	5563	Machine Thumb Screw for 3 in. table.....	\$ 30
1408J	5563	" " " " 2 in. table.....	25
14063	6384	" " " Spring.....	10
9842	6384	" " " Washer.....	02
36563	6375	Oiler (copper plated) with 36564.....	12
36564	6375	" Spout, 5 in. long.....	06
26026	6375	Screw Driver (large).....	10
26485	6375	" " (small).....	05
35095	6375	Tweezers, 6 in.....	40
4822	6375	Wrench for 1547.....	05
8908	6375	" " 1520, 1620, 1722 and 1723.....	08
37051	6375	" " 50127.....	10

FOOT LIFTER PARTS

NO.	PLATE	NAME	EACH
6439	—	Chain, 36 in. to 45 in.....	\$ 20
NOTE: When ordering No. 6439 give length required.			
4879	6383	Chain Connecting Link.....	03
54999	6383	Lifting Lever.....	50
54767	6383	" " Extension.....	50
161D	6385	" " " Screw.....	04
54768	6384	" " " Spring.....	10
866D	6385	" " Hinge Screw.....	15
4881	6367	Treadle.....	30
4882	6383	" Shaft.....	05
4883	6383	" Spring.....	10
4884	6367	" Stand.....	25
4885	6367	Treadle complete, Nos. 4879, 4881 to 4884 and two wood screws 1 in. No. 16.....	75
55000	—	Foot Lifter complete, Nos. 866D, 4885, 6439, 54767, 54768, 54999 and two 161D.....	2 30

LAP SEAM FELLER

NO.	PLATE	NAME	EACH
36597	6387	Lap Seam Feller on Slide.....	\$ 3 50
26277	6377	Holder.....	75
36586	6377	" Plate.....	75
	624c	" " Adjusting Screw.....	03
36598	6377	" " Bracket with 624c.....	50
	1174d	" " " Screw.....	04
	202d	" " Screw.....	02
	922d	" Thumb Screw.....	10
19294	6377	Spring.....	05
	405d	" Screw.....	02

THREAD UNWINDER

FOR FOUR LARGE SPOOLS OR FOUR LARGE CONES OF THREAD

NO.	PLATE	NAME	EACH
27623	2838	Spool Pin.....	\$ 08
	155c	" " Set Screw.....	03
41534	2838	" Rest.....	50
41535	—	" " 41534 with 1149c and four each 155c and 27623.....	1 00
	1149c	Spool Rest Set Screw.....	04
27940	2838	" Stand with 453c.....	20
41514	2838	" Weight, 4 in. diam., with 41515....	15
41515	6384	" " Centre Pin.....	05
27739	2838	Thread Cone (wood).....	05
41633	2838	" Guard with 208E and four 41569....	45
41569	6384	" " Eyelet.....	02
41637	2838	" " Rod (lower).....	10
41638	2838	" " " (upper).....	15
41639	2838	" " " Coupling with two 456c.....	20
	456c	Thread Guard Rod Coupling Set Screw...	02
41640	—	Thread Guard Rod complete, 30 in. long. Nos. 41637 to 41639.....	45
	453c	Thread Guard Rod Set Screw.....	02
	208E	" " Screw.....	02
41537	2838	Thread Unwinder complete, Nos. 27940, 41535, 41633, 41640, three wood screws 1 in. No. 12 and four each 27739 and 41514.....	2 80

OBSOLETE PARTS

NO.	PLATE	NAME	EACH
54860	6368	Cylinder End Cover complete, Nos. 54780, 54859 and two 54628.....	\$ 1 50
54780	—	Cylinder End Cover Slide.....	50

NUMERICAL LIST OF PARTS

FOR

MACHINE No. 86-13

NUMERICAL LIST OF PARTS

NO.	PLATE	NAME	EACH
103d	6385	Cylinder Rock Shaft (lower) Eccentric Hinge Screw.....	\$ 04
103d	6385	Feed Eccentric Adjusting Screw.....	04
103d	6385	" " Hinge Screw.....	04
110d	6385	Tension (upper thread) Releasing Shaft Crank Link Hinge Screw.....	04
127E	6374	Feed Regulating Lever Bracket Screw...	04
134d	6385	Belt Cover Screw.....	05
134d	6385	Cylinder Screw.....	05
155c	6385	Thread Unwinder Spool Pin Set Screw for 41535.....	03
161d	6385	Lifting Lever Extension Screw for 55000.....	04
171E	6385	Cylinder Rock Shaft (lower) Eccentric Connecting Rod Cap Screw for 54931...	03
171E	6385	Cylinder Rock Shaft (upper) Eccentric Connecting Rod Cap (lower) Screw for 54937.....	03
171E	6385	Thread (under) Nipper Connecting Rod Cap Screw for 54992.....	03
175E	6385	Crank Connecting Rod Cap (upper) Screw for 54617.....	02
185u	6371	Looper Carrier Adjusting Screw for 54788.....	02
185u	6371	Needle Guard Holder Screw.....	02
189d	6385	Cylinder End Cover Lock Spring Cap Screw.....	02
190d	6385	Presser Foot Screw.....	03
190d	6385	Thread (under) Nipper Bracket Screw...	03
202d	6377	Looper Carrier Slide Block Holder Clamping Screw for 54973.....	02
202d	6377	Lap Seam Feller Holder Plate Screw.....	02
203c	6385	Slack Thread Regulator Screw.....	03
203c	6385	" " " Spring Bracket Screw.....	03
207E	6371	Cylinder Rock Shaft (lower) Eccentric Connecting Rod Stud Clamping Screw for 54933.....	02
207E	6371	Needle Bar Connecting Stud Clamping Screw for 54713.....	02
207d	6371	Presser Bar Guide Bracket Clamping Screw for 54718.....	02
208d	6371	Looper Carrier Slide Block Ball Stud Clamping Screw for 54973.....	02

NO.	PLATE	NAME	EACH
208E	6371	Thread Unwinder Thread Guard Screw for 41633.....	\$ 02
211F	6371	Looper Carrier Holder Clamping Screw for 55013.....	02
217F	6382	Thread (upper) Take-up Screw.....	03
219D	6385	Cloth Plate Spring Screw for 54890.....	02
219F	6385	Thread (upper) Controller Screw.....	02
220E	6369	Cylinder End Cover Slide Gib Screw for 55021.....	02
233D	6385	Needle Guard (back) Screw.....	02
233D	6385	" " (front) Screw.....	02
233D	6385	Thread (under) Nipper Spring Screw.....	02
237D	6369	Cloth Plate Spring Guide Screw for 54890.....	02
286D	6385	Arm Side Cover Thumb Screw.....	10
286D	6385	Face Plate Thumb Screw.....	10
316F	6380	Tension (upper thread) Releasing Shaft Stop Screw.....	03
324C	6385	Feed Lifting Lever Screw Centre.....	06
337D	6381	Thread (under) Separator Screw.....	02
345C	6369	Cloth Plate Bracket Screw for 54887.....	10
376D	6380	Tension (upper thread) Bracket Screw.....	05
391D	6385	Cylinder Top Cover (front) Screw for 54927.....	02
405D	6377	Lap Seam Feller Spring Screw.....	02
430C	6385	Hand Wheel and Pulley Set Screw (long) for 54964.....	04
440F	6385	Feed Eccentric Flange Adjusting Screw for 54950.....	03
440F	6385	Feed Eccentric Flange Set Screw for 54950.....	03
446C	6385	Cylinder Rock Shaft (upper) Eccentric Connecting Rod Lever Hinge Stud Set Screw.....	03
447C	6385	Cylinder Rock Shaft (lower) Bushing Set Screw.....	03
447C	6385	Thread (under) Take-up Eccentric Set Screw for 54995.....	03
453C	6385	Thread Unwinder Thread Guard Rod Set Screw for 27940.....	02
456C	6385	Arm Rock Shaft Collar Set Screw for 54921.....	02
456C	6385	Thread Unwinder Thread Guard Rod Coupling Set Screw for 41639.....	02
457C	6372	Cylinder Rock Shaft (upper) Crank Set Screw for 54632.....	02
457C	6372	Cylinder Rock Shaft (upper) Eccentric Set Screw for 54936.....	02
457C	6372	Feed Lifting Eccentric Set Screw for 54951.....	02

NO.	PLATE	NAME	EACH
459F	6381	Thread (under) Pull-off Thread Guard Stop Screw for 54898.....	\$ 04
459F	6381	Thread (under) Take-up Thread Guard Stop Screw for 54899.....	04
460C	6385	Cylinder Top Cover (back) Hinge Pin Set Screw for 54927.....	02
462C	6385	Feed Dog Carrier Set Screw for 54948.....	02
462C	6385	Thread (under) Take-up Shaft Screw Centre Set Screw.....	02
465C	6385	Cylinder Rock Shaft (upper) Collar Set Screw for 54934.....	02
465C	6385	Looper (back) Set Screw for 54788.....	02
465C	6385	" (front) Set Screw for 54788.....	02
465C	6385	Thread (under) Nipper Eccentric Set Screw for 54874.....	02
465C	6385	Thread (under) Pull-off Set Screw for 54875.....	02
465C	6385	Thread (under) Take-up Set Screw for 54876.....	02
563C	6385	Needle Bar Bushing (lower) Set Screw...	04
563C	6385	" " " (upper) Set Screw...	04
563C	6385	Presser Bar Bushing Set Screw.....	04
620C	6385	Looper Carrier Hinge Pin Set Screw for 55013.....	02
624C	6372	Cylinder Rock Shaft (upper) Eccentric Connecting Rod Ball Stud Set Screw for 54941.....	03
624C	6372	Cylinder Rock Shaft (upper) Eccentric Position Screw for 54936.....	03
624C	6372	Feed Lifting Eccentric Position Screw for 54951.....	03
624C	6377	Lap Seam Feller Holder Plate Adjusting Screw for 36598.....	03
624C	6372	Tension (upper thread) Releasing Shaft Crank Set Screw for 54872.....	03
662D	6378	Slack Thread Regulator Spring Stop Screw for 54984.....	02
665D	6374	Cylinder Top Cover (front) Spring Screw for 54944.....	02
665D	6374	Looper (front) Needle Guard Screw.....	02
743C	6382	Thread (upper) Controller Post Set Screw	05
767D	6385	Cylinder Thread Cover Screw.....	02
828C	6380	Tension (under thread) Screw Stud (lower)	08
866D	6385	Lifting Lever Hinge Screw for 55000.....	15
888C	6385	Arm Rock Shaft Bushing (front) Set Screw	05
888C	6385	Hand Wheel and Pulley Shaft Bushing (left) Set Screw.....	05

NUMERICAL LIST OF PARTS

NO.	PLATE	NAME	EACH
895C	6385	Hand Wheel and Pulley Shaft Bushing (right) Set Screw.....\$	05
896E	6385	Crank Connecting Rod Cap (lower) Screw for 54616.....	04
896E	6385	Cylinder Rock Shaft (upper) Eccentric Connecting Rod Cap (upper) Screw for 54937.....	04
896E	6385	Feed Lifting Lever Connecting Rod Cap Screw for 54953.....	04
896E	6385	Feed Rod Cap Screw for 54963.....	04
911D	6369	Arm Back Cover Latch Screw Stud for 54915.....	03
916C	6380	Tension (under thread) Screw Stud (upper).....	08
922D	6377	Lap Seam Feller Holder Thumb Screw....	10
935D	6384	Machine Cushion Screw for 54998.....	04
974C	6374	Feed Regulating Lever Hinge Screw.....	06
974D	6374	Thread (upper) Controller Lever Hinge Screw.....	06
994C	6369	Cylinder End Cover Slide Gib Adjusting Screw for 55021.....	04
999D	6385	Thread (under) Nipper Connecting Rod Hinge Screw.....	05
999F	6385	Thread (upper) Controller Lever Connection Hinge Screw.....	05
1100D	6385	Cylinder Rock Shaft (upper) Eccentric Connecting Rod Position Pin and Bracket Screw.....	02
1145D	6381	Thread (under) Pull-off Thread Guard Hinge Screw.....	03
1145D	6381	Thread (under) Take-up Thread Guard Hinge Screw.....	03
1149C	6385	Thread Unwinder Spool Rest Set Screw for 41535.....	04
1174D	6377	Lap Seam Feller Holder Plate Bracket Screw.....	04
1299C	6385	Hand Wheel and Pulley Set Screw (short) for 54964.....	03
1319F	6386	Throat Plate Screw.....	04
1407J	5563	Machine Thumb Screw for 3 in. table (Accessories).....	30
1408J	5563	Machine Thumb Screw for 2 in. table (Accessories).....	25
1425D	6378	Slack Thread Regulator Spring Screw....	06
1443H	6385	Arm Back Cover Spring Screw for 54914....	04
1484F	6382	Thread Tube Bracket Screw.....	03

NUMERICAL LIST OF PARTS

NO.	PLATE	NAME	EACH
1492D	6378	Presser Bar Lifting Bracket Clamping Screw for 54979.....\$	03
1498F	6385	Needle Set Screw for 54847.....	02
1520E	6371	Crank Connecting Rod Ball Screw Stud Nut.....	03
1520E	6371	Needle Bar Connecting Link Hinge Stud Nut.....	03
1538H	6369	Arm Back Cover Latch Screw Stud Thumb Nut for 54914.....	06
1543D	6385	Pressure Regulating Thumb Screw Lock Nut.....	05
1547D	6380	Tension (under thread)Screw Stud (upper) Nut.....	03
1547D	6380	Tension (upper thread) Releasing Shaft Stop Screw Nut.....	03
1560C	6380	Tension (under thread) Regulating Thumb Nut.....	04
1560C	6380	Tension (upper thread) Regulating Thumb Nut.....	04
1620E	6385	Feed Lifting Lever Connecting Rod Hinge Screw Nut.....	03
1722E	6372	Crank Connecting Rod Nut (lower) for 54924.....	03
1722E	6372	Feed Rod Nut for 54959.....	03
1723E	6372	Crank Connecting Rod Nut (upper) for 54924.....	03
2102	6380	Tension (under thread) Disc.....	05
2102	6380	" (upper thread) Disc.....	05
2269	6374	Feed Regulating Lever Stop Pin.....	01
2827	6382	Face Plate Thread Guard with 8505, for 54945.....	02
4621	6369	Cloth Plate Spring Packing Rivet for 54885.....per 100	25
4822	6375	Wrench for 1547 (Accessories).....	05
4879	6383	Chain Connecting Link for 4885.....	03
		Nos. 4881 to 4884 for 4885.	
4881	6367	Treadle.....	30
4882	6383	" Shaft.....	05
4883	6383	" Spring.....	10
4884	6367	" Stand.....	25
4885	6367	Treadle complete for 55000, Nos. 4879, 4881 to 4884 and two wood screws 1 in. No. 16.....	75
6439	—	Chain, 36 in. to 45 in., for 55000.....	20
8505	6382	Face Plate Thread Guard Rivet for 2827, per 100.....	10

NO.	PLATE	NAME	EACH
8908	6375	Wrench for 1520, 1620, 1722 and 1723 (Accessories).....	\$ 08
9842	6384	Machine Thumb Screw Spring Washer (Accessories).....	02
10148	6380	Tension (under thread) Spring.....	03
14063	6384	Machine Thumb Screw Spring (Accessories).....	10
17547	6380	Tension (upper thread) Thread Guide....	25
18054	6387	Presser Foot Spring for 55025.....	02
19294	6377	Lap Seam Feller Spring.....	05
26026	6375	Screw Driver, large (Accessories).....	10
26276	6384	Presser Foot Hinge Pin for 54839, 55015 and 55025.....	01
26277	6377	Lap Seam Feller Holder.....	75
26485	6375	Screw Driver, small (Accessories).....	05
27623	2838	Thread Unwinder Spool Pin for 41535....	08
27739	2838	“ “ Thread Cone (wood) for 41537.....	05
27940	2838	Thread Unwinder Spool Stand with 453c, for 41537.....	20
32572	6380	Tension (upper thread) Releasing Disc....	05
35095	6375	Tweezers, 6 in. (Accessories).....	40
36563	6375	Oiler (copper plated) with 36564 (Accessories).....	12
36564	6375	Oiler Spout, 5 in. long, for 36563.....	06
36586	6377	Lap Seam Feller Holder Plate.....	75
36597	6387	“ “ “ on Slide.....	3 50
36598	6377	“ “ “ Holder Plate Bracket with 624c.....	50
37051	6375	Wrench for 50127 (Accessories).....	10
38145	6378	Tension (under thread) Thread Guide....	50
41514	2838	Thread Unwinder Spool Weight, 4 in. diam., with 41515, for 41537.....	15
41515	6384	Thread Unwinder Spool Weight Centre Pin for 41514.....	05
41534	2838	Thread Unwinder Spool Rest for 41535....	50
41535	—	“ “ “ “ 41534 with 1149c and four each 155c and 27623, for 41537.....	1 00
41537	2838	Thread Unwinder complete, for four large spools or four large cones of thread, Nos. 27940, 41535, 41633, 41640, three wood screws 1 in. No. 12 and four each 27739 and 41514.....	2 80
41569	6384	Thread Unwinder Thread Guard Eyelet for 41633.....	02

NO.	PLATE	NAME	EACH
41633	2838	Thread Unwinder Thread Guard with 208E and four 41569, for 41537.....	\$ 45
Nos. 41637 to 41639 FOR 41640.			
41637	2838	Thread Unwinder Thread Guard Rod (lower).....	10
41638	2838	Thread Unwinder Thread Guard Rod (upper).....	15
41639	2838	Thread Unwinder Thread Guard Rod Coupling with two 456c.....	20
41640	—	Thread Unwinder Thread Guard Rod complete, 30 in. long, for 41537, Nos. 41637 to 41639.....	45
42088	6384	Machine Cushion (felt) for 54998.....	02
46111	6384	Face Plate Pin.....	02
46478	6371	Needle Clamp Thread Guide for 54847....	02
50127c	6371	Crank Connecting Rod Ball Screw Stud for 54617.....	20
50128c	6386	Feed Dog Screw.....	04
50132b	6385	Pressure Regulating Thumb Screw.....	10
50133c	6380	Tension (upper thread) Screw Stud.....	12
50135c	6371	Arm Rock Shaft Crank (back) Set Screw for 54603.....	06
50135c	6371	Arm Rock Shaft Crank (front) Set Screw for 54776.....	06
50217b	6369	Cloth Plate Screw for 54891.....	08
50218c	6369	“ “ Spring Lock Screw for 54890.....	05
50223b	6385	Arm Back Cover Latch Hinge Screw for 54914.....	06
50224c	6385	Arm Rock Shaft Bushing (back) Set Screw.....	10
50225b	6385	Cylinder Rock Shaft (lower) Eccentric Adjusting Screw.....	03
50226c	6374	Feed Dog Carrier Slide Block Screw....	10
50227c	6385	“ Lifting Lever Connecting Rod Hinge Screw.....	12
50228c	6378	Presser Bar Lifter Hinge Screw.....	12
50229c	6385	Thread (under) Take-up Shaft Screw Centre.....	06
54603	6371	Arm Rock Shaft Crank (back) with two 50135c.....	1 00
*54612	—	Crank Connecting Rod Cap (lower) for 54616.....	—
*54613	—	Crank Connecting Rod Cap (upper) for 54617.....	—
*54614	—	Crank Connecting Rod End Bearing (lower) for 54616.....	—

NO.	PLATE	NAME	EACH
*54615	—	Crank Connecting Rod End Bearing (upper) for 54617.....	\$ —
*54616	—	Crank Connecting Rod Head (lower) Nos. 54612, 54614 and two 896E, for 54924..	1 50
*54617	—	Crank Connecting Rod Head (upper) Nos. 50127c, 54613, 54615 and two 175E, for 54924.....	1 50
54620	6384	Cylinder Dowel Pin.....	05
54623	6369	" End Cover Lock Spring.....	05
54624	6369	" " " " " Cap....	25
54628	6384	" " " Slide Rivet for 54860 and 55021.....	01
54632	6372	Cylinder Rock Shaft (upper) Crank with two 457c.....	75
54643	6384	Cylinder Oil Tube for 54927.....	03
54662	6374	" Thread Cover.....	25
54664	6384	" Top Cover (back) Hinge Pin for 54927.....	05
54666	6374	Cylinder Top Cover (front) Spring for 54944.....	05
54671	6374	Cylinder Rock Shaft (upper) Eccentric Connecting Rod Position Pin and Bracket (solid).....	15
54692	6371	Looper Carrier Hinge Pin.....	20
54694	6371	" " Slide Block (two pieces) with 54695 and two 54705.....	2 00
*54695	—	Looper Carrier Slide Block Ball Stud for 54694.....	40
54704	6372	Cylinder Rock Shaft (lower) Key for 54928.....	20
54705	6371	Looper Carrier Slide Block Pin for 54694.....	25
54707	6371	" (front) Needle Guard Steady Pin for 54786.....per 100	25
54708	6368	Needle Bar (hollow) for 54846.....	1 00
54710	6370	" " Bushing (lower).....	25
54711	6370	" " Connecting Link.....	75
54712	6370	" " " Hinge Stud.....	15
54713	6371	" " " Stud with 207E..	50
54718	6378	Presser Bar Guide Bracket with 207D....	50
54719	6378	" " Lifter.....	35
54722	6384	" " Spring Stud.....	01
54732	6378	Slack Thread Regulator Spring Bracket..	40
54738	6380	Tension (upper thread) Spring.....	05
54740	6381	Thread (under) Nipper Spring.....	10
54758	6382	" (upper) Controller Post.....	50
54761	6384	" Tube for 54927.....	10

NO.	PLATE	NAME	EACH
54767	6383	Lifting Lever Extension for 55000.....	\$ 50
54768	6384	" " " Spring for 55000.....	10
54772	6382	Thread Tube Bracket for 54808.....	25
54776	6371	Arm Rock Shaft Crank (front) with two 50135c.....	1 00
54780	—	Cylinder End Cover Slide for 54860, obsolete.....	50
54781	6368	Cylinder Rock Shaft (upper).....	1 00
54785	6371	Looper (back).....	2 25
54786	6371	" (front) with 54707.....	2 25
54788	6371	" Carrier with two each 185u and 465c.....	5 00
54801	6384	Thread (under) Separating Pin for 54807.....	02
54806	6382	" (upper) Controller Lever.....	40
54807	6383	" Tube with 54801, for 54808.....	75
54808	—	" " 54807 with 54772.....	1 00
54819	—	Presser Foot Shank for 54839 and 55015.....	75
54827	6381	Thread (under) Pull-off Thread Guard and Thread (under) Take-up Thread Guard Spring.....	05
54828	6381	Thread (under) Pull-off Thread Guard and Thread (under) Take-up Thread Guard Spring Stop Pin.....	01
54838	—	Presser Foot Plate for 54839.....	1 50
54839	6386	Presser Foot (hinged) complete for 55018, Nos. 26276, 54819 and 54838.....	2 25
54846	—	Needle Bar complete, Nos. 54708 and 54847.....	1 60
54847	6371	Needle Clamp with 46478 and two 1498E, for 54846.....	60
54859	—	Cylinder End Cover for 54860 and 55021.....	1 00
54860	6368	Cylinder End Cover complete, Nos. 54780, 54859 and two 54628, obsolete.....	1 50
54863	6370	Feed Eccentric.....	1 35
54865	6374	" " Adjusting Screw Friction Washer.....	01
54865	6374	Feed Eccentric Hinge Screw Friction Washer.....	01
54872	6381	Tension (upper thread) Releasing Shaft Crank with 624c.....	1 00
54873	6381	Tension (upper thread) Releasing Shaft Crank Link.....	50
54874	6381	Thread (under) Nipper Eccentric with 465c.....	30
54875	6381	Thread (under) Pull-off with 465c.....	70
54876	6382	" " Take-up with 465c.....	1 25

NO.	PLATE	NAME	EACH
54879	6382	Thread (upper) Controller Lever Connection.....	\$ 50
54885	6367	Cloth Plate (left) with 54889 and two 4621, for 54890.....	1 60
54886	6367	Cloth Plate (right) for 54890.....	1 50
54887	6367	" " Bracket with 345c, for 54891.....	40
54888	6369	" " Spring for 54890.....	25
54889	6369	" " " Packing for 54885.....	25
54890	—	Cloth Plate complete for 54891, Nos. 219D, 237D, 50218c, 54885, 54886 and 54888.....	3 45
54891	—	Cloth Plate with Bracket complete, Nos. 54887, 54890 and two 50217D.....	4 00
54897	6384	Arm Oil Cup.....	10
54898	6381	Thread (under) Pull-off Thread Guard with 459F.....	1 00
54899	6382	Thread (under) Take-up Thread Guard with 459F.....	75
54905	6386	Throat Plate for 55010.....	3 00
*54912	—	Arm.....	20 00
54913	6367	" Back Cover for 54914.....	60
54914	—	Arm Back Cover complete, Nos. 1538H, 50223D, 54913, 54915, 54916 and two 1443H.....	1 20
54915	6369	Arm Back Cover Latch with 911D, for 54914.....	30
54916	6369	Arm Back Cover Spring for 54914.....	10
54917	6384	" Oil Tube for oiling 54941.....	03
54918	6368	" Rock Shaft.....	1 00
54919	6369	" " " Bushing (back).....	25
54920	6369	" " " " (front).....	25
54921	6371	" " " Collar with two 456c.....	30
54922	6368	" Side Cover.....	10
54923	6367	Belt Cover.....	60
54924	6368	Crank Connecting Rod complete, Nos. 1722E, 1723E, 54616, 54617, 54925 and 54926.....	3 75
*54925	—	Crank Connecting Rod (rod only) for 54924.....	50
54926	6371	Crank Connecting Rod Position Pin and Bracket (solid) for 54924.....	15
*54927	—	Cylinder with 460c, 54643, 54664, 54943, 54944 and two 391D.....	12 00
54928	6368	Cylinder Rock Shaft (lower) with 54704.....	1 50
54929	6369	" " " " Bushing.....	75
54930	6372	" " " " Eccentric.....	1 50

NO.	PLATE	NAME	EACH
54931	6372	Cylinder Rock Shaft (lower) Eccentric Connecting Rod with 54932 and two 171E.....	\$ 1 00
*54932	—	Cylinder Rock Shaft (lower) Eccentric Connecting Rod Cap for 54931.....	—
54933	6372	Cylinder Rock Shaft (lower) Eccentric Connecting Rod Stud with 207E.....	50
54934	6372	Cylinder Rock Shaft (upper) Collar with two 465c.....	25
54935	6372	Cylinder Rock Shaft (upper) Crank Connecting Link.....	75
54936	6372	Cylinder Rock Shaft (upper) Eccentric with 457c and 624c.....	1 00
54937	6373	Cylinder Rock Shaft (upper) Eccentric Connecting Rod with 54939, 54940 and two each 171E and 896E.....	1 50
54938	6372	Cylinder Rock Shaft (upper) Eccentric Connecting Rod Ball Stud.....	35
*54939	—	Cylinder Rock Shaft (upper) Eccentric Connecting Rod Cap (lower) for 54937.....	—
*54940	—	Cylinder Rock Shaft (upper) Eccentric Connecting Rod Cap (upper) for 54937.....	—
*54940	—	Feed Lifting Lever Connecting Rod Cap for 54953.....	—
54941	6372	Cylinder Rock Shaft (upper) Eccentric Connecting Rod Lever with 624c.....	2 00
54942	6374	Cylinder Rock Shaft (upper) Eccentric Connecting Rod Lever Hinge Stud.....	50
*54943	—	Cylinder Top Cover (back) for 54927.....	75
*54944	—	" " " (front) with 665D and 54666, for 54927.....	75
54945	6368	Face Plate with two 2827.....	60
54948	6370	Feed Dog Carrier with two 462c, for 54959.....	1 50
54949	6374	Feed Dog Carrier Slide Block.....	50
54950	6370	" Eccentric Flange with two 440F.....	1 00
54951	6374	" Lifting Eccentric with 457c and 624c.....	1 00
54952	6373	" " Lever.....	1 00
54953	6373	" " " Connecting Rod with 54940 and two 896E.....	1 00
54954	6374	Feed Regulating Lever.....	50
54955	6374	" " " Bracket.....	75
54956	6374	" " " Spring.....	02
54957	6370	" Regulator.....	2 00
54958	6370	" " Friction Spring.....	10
54959	6373	Feed Rod complete, Nos. 1722E, 54948, 54960 and 54963.....	4 00

NO.	PLATE	NAME	EACH
54960	6373	Feed Rod (rod only) for 54959.....	\$ 1 00
*54961	—	“ “ Cap for 54963.....	—
*54962	—	“ “ End Bearing for 54963.....	—
54963	—	“ “ Head, Nos. 54961, 54962 and two 896e, for 54959.....	1 50
54964	6367	Hand Wheel and Pulley with 430c and 1299c.....	1 50
54965	6373	Hand Wheel and Pulley Shaft.....	3 50
54966	6373	“ “ “ “ “ Bushing (left).....	35
54967	6384	Hand Wheel and Pulley Shaft Bushing (left) Oil Pad (braided cotton).....	01
54968	6373	Hand Wheel and Pulley Shaft Bushing (right).....	1 00
54969	6384	Hand Wheel and Pulley Shaft Bushing (right) Oil Pad (braided cotton).....	01
54970	6384	Hand Wheel and Pulley Shaft Washer.....	05
54973	6371	Looper Carrier Slide Block Holder with 202b and 208b.....	75
54974	6370	Needle Bar Bushing (upper).....	40
54975	6370	“ Guard (back).....	40
54976	6370	“ “ (front).....	40
54977	6370	“ “ Holder.....	75
54978	6378	Presser Bar Bushing.....	50
54979	6378	“ “ Lifting Bracket with 1492b... ..	75
54980	6388	“ “ Spring (flat).....	50
54984	6378	Slack Thread Regulator with 662b and 54986.....	1 50
54986	6378	Slack Thread Regulator Spring Stop for 54984.....	05
54987	6380	Tension (upper thread) Bracket.....	75
54988	6380	“ “ “ Releasing Pin.....	01
54989	6380	“ “ “ “ Shaft.....	50
54990	6380	“ “ “ “ “ Spring.....	05
54991	6381	Thread (under) Nipper Bracket.....	1 25
54992	6381	“ “ “ Connecting R o d with 54993 and two 171e.....	1 00
*54993	—	Thread (under) Nipper Connecting Rod Cap for 54992.....	—
54994	6381	Thread (under) Separator.....	10
54995	6382	“ “ Take-up Eccentric with 447c.....	1 00
54996	6382	Thread (under) Take-up Shaft.....	1 25
54997	6382	“ (upper) Controller.....	25

NO.	PLATE	NAME	EACH
54998	6367	Machine Base with three wood screws 1½ in. No. 12 and four each 935b and 42088.....	\$ 2 00
54999	6383	Lifting Lever for 55000.....	50
55000	—	Foot Lifter complete, Nos. 866b, 4885, 6439, 54767, 54768, 54999 and two 161b	2 30
55005	6371	Looper (front) Needle Guard.....	40
55008	6378	Presser Bar.....	25
55010	6386	Feed Dog, for ⅜ in. to ⅜ in. gauge.....	1 75
55011	6386	“ “ Adjusting Wedge.....	25
55012	6386	Slack Thread Regulator Spring.....	05
55013	6371	Looper Carrier Holder with 211e and 620c	1 50
55014	—	Presser Foot Plate for 55015 and 55025..	1 50
55015	6386	Presser Foot (hinged) complete for 55010, Nos. 26276, 54819 and 55014.....	2 25
55016	6382	Thread (upper) Take-up.....	10
55018	6386	Feed Dog, for ⅜ in. to ¼ in. gauge.....	1 75
55019	6386	Throat Plate for 55018.....	3 00
55021	6383	Cylinder End Cover complete, Nos. 54859, 55022, 55023 and two each 220e, 994c and 54628.....	2 15
55022	—	Cylinder End Cover Slide for 55021.....	60
55023	6383	“ “ “ “ Gib for 55021..	40
55024	—	Presser Foot Shank for 55025.....	75
55025	6387	Presser Foot (spring hinged) complete for 55010 and 55018, Nos. 18054, 26276, 55014 and 55024.....	2 25

ILLUSTRATIONS OF PARTS

FOR

MACHINE No. 86-13

PLATE 2838—ONE-FOURTH SIZE

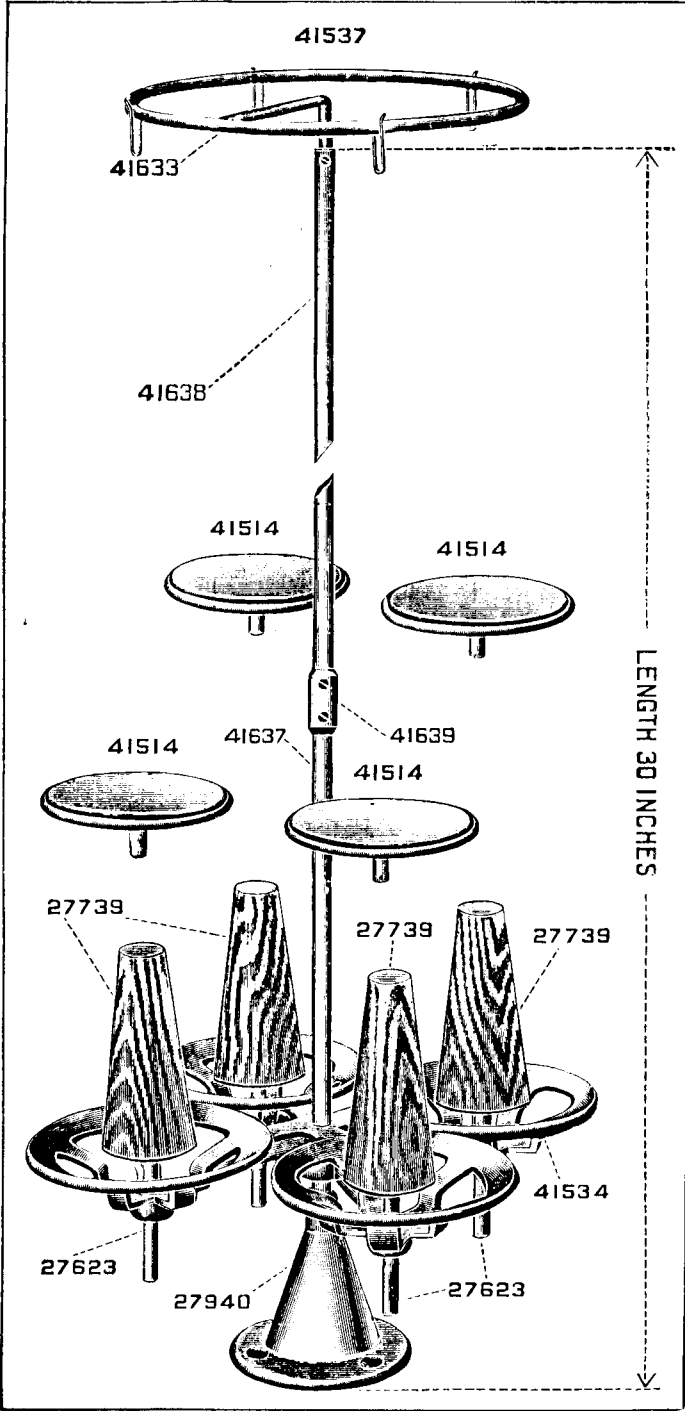

PLATE 5563—FULL SIZE

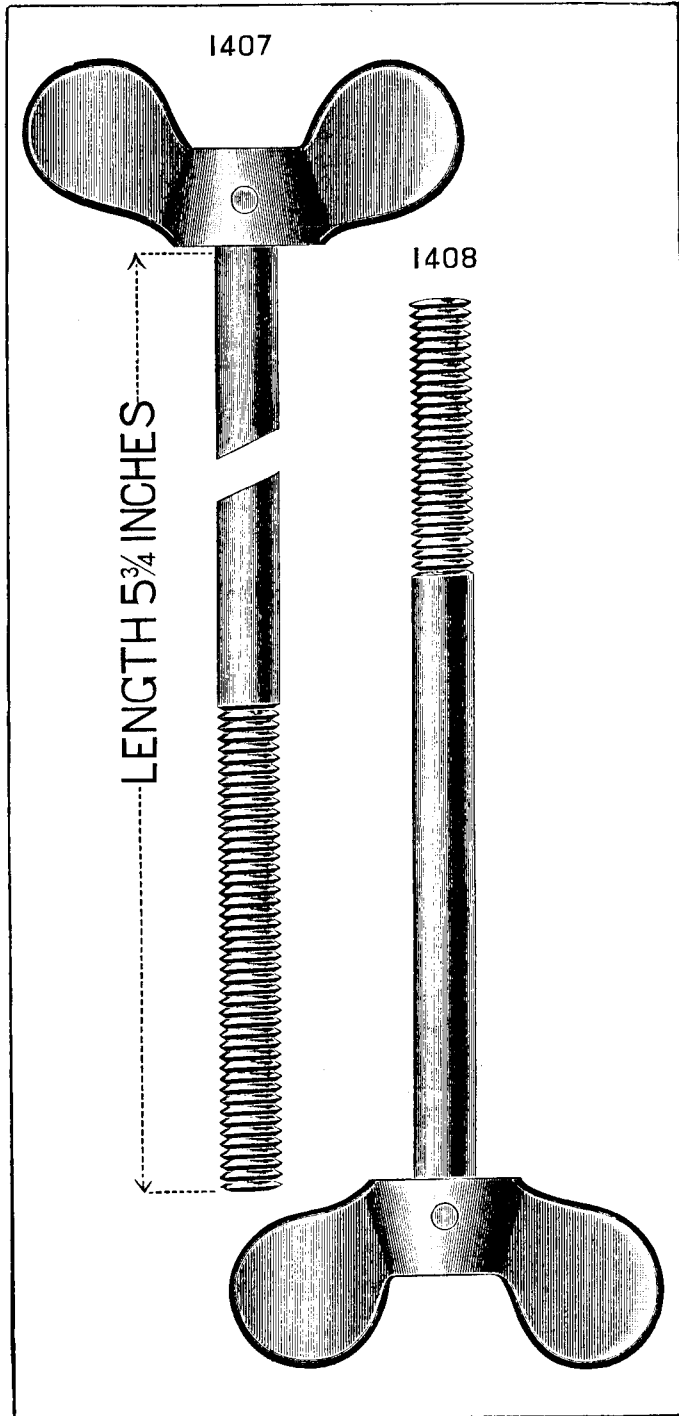

PLATE 6367—ONE-FOURTH SIZE

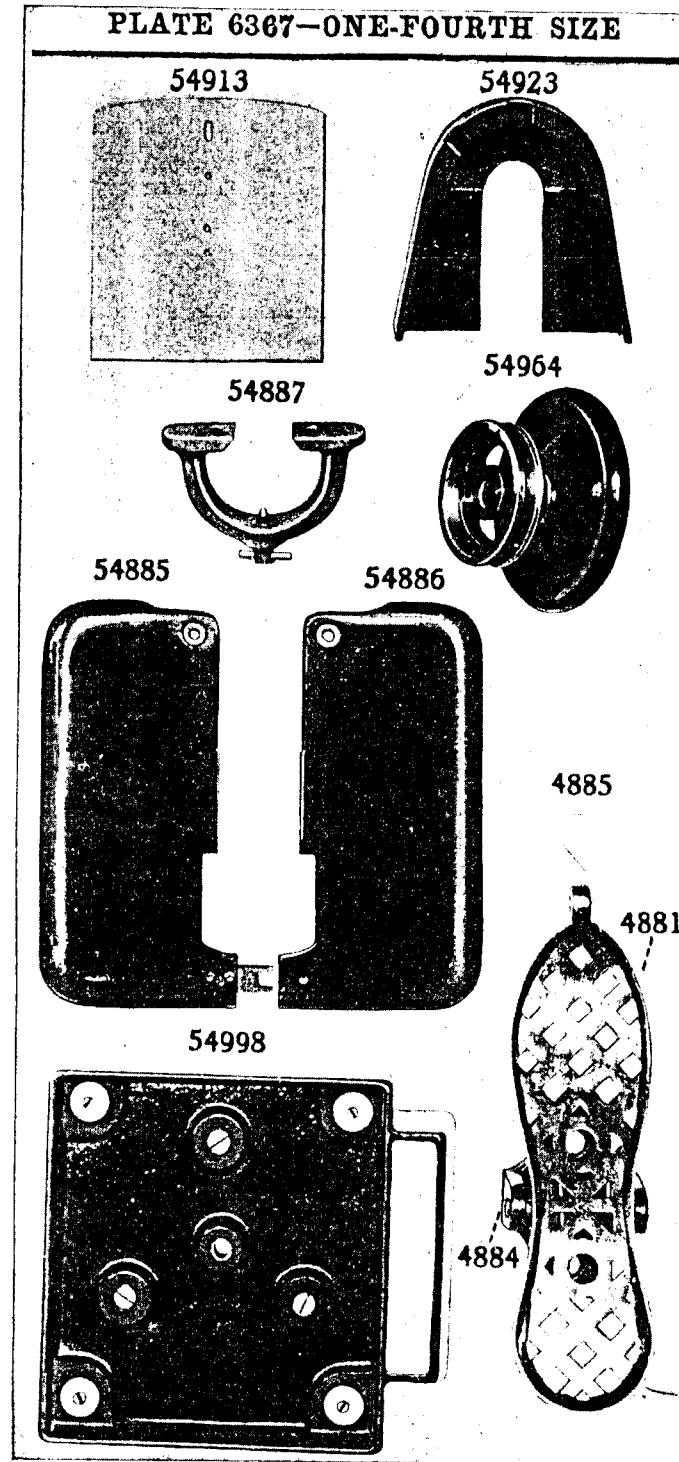

PLATE 6368—ONE-HALF SIZE

54918 54781 54928 54708 54945

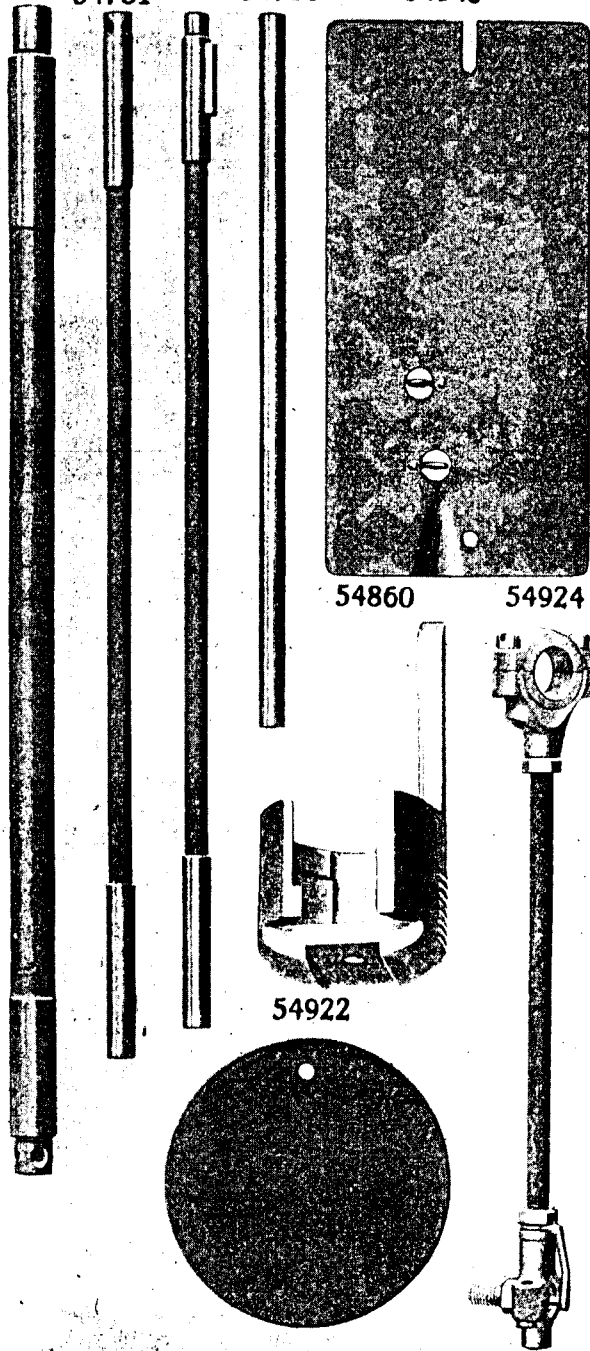

PLATE 6369—FULL SIZE

54915 911 54916 54623

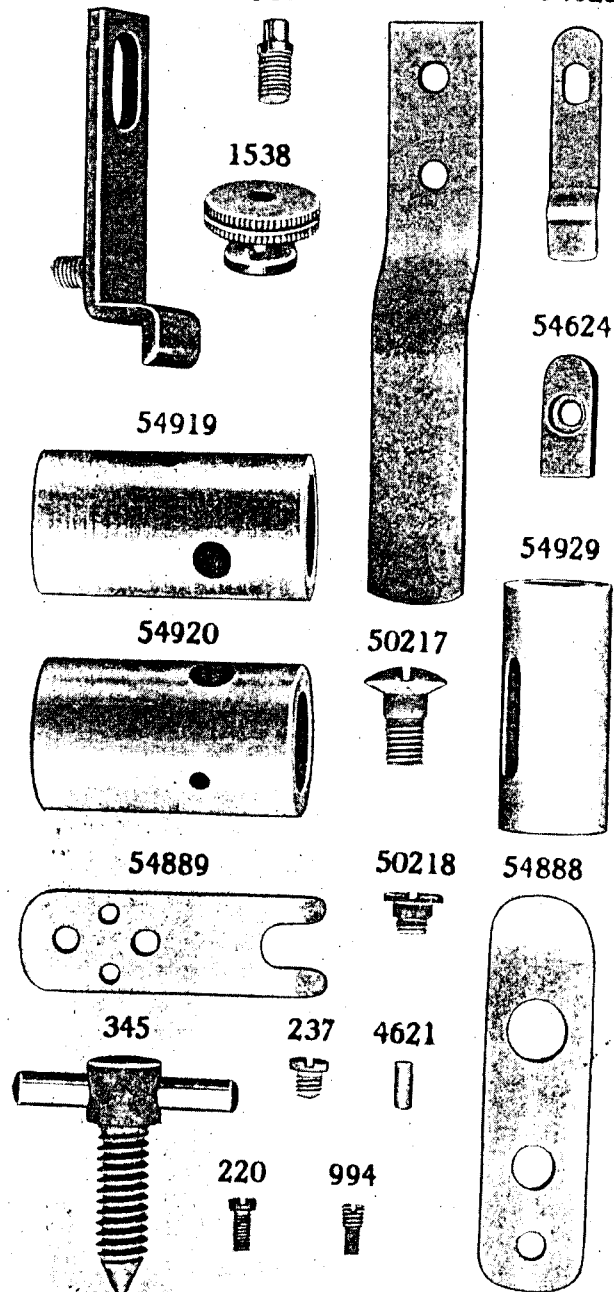
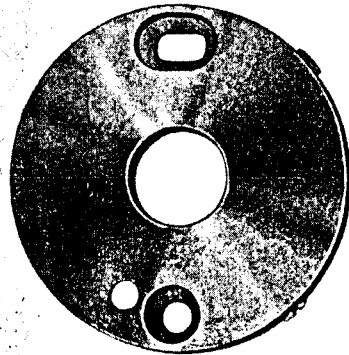

PLATE 6370—FULL SIZE

54948



54950



54957

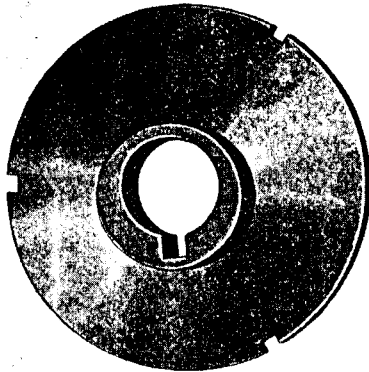

54974



54710



54711



54863

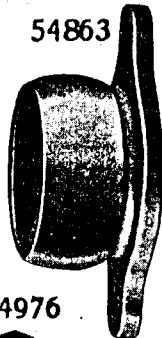

54958



54712



54975



54976



54977



PLATE 6371—FULL SIZE

54603

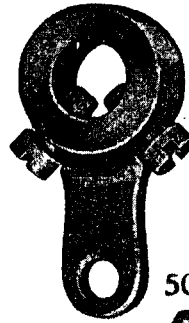

54776



50135



54921



50127



1520



54926

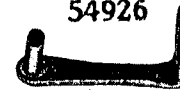

55005



54785



54786

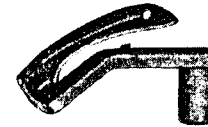

54707

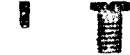

211

54788

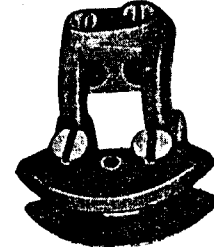

185



54692



55013

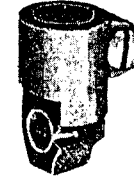

54973



54847

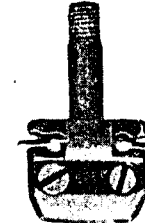

54713

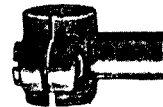

207



54694



54705



208



46478



PLATE 6372—FULL SIZE

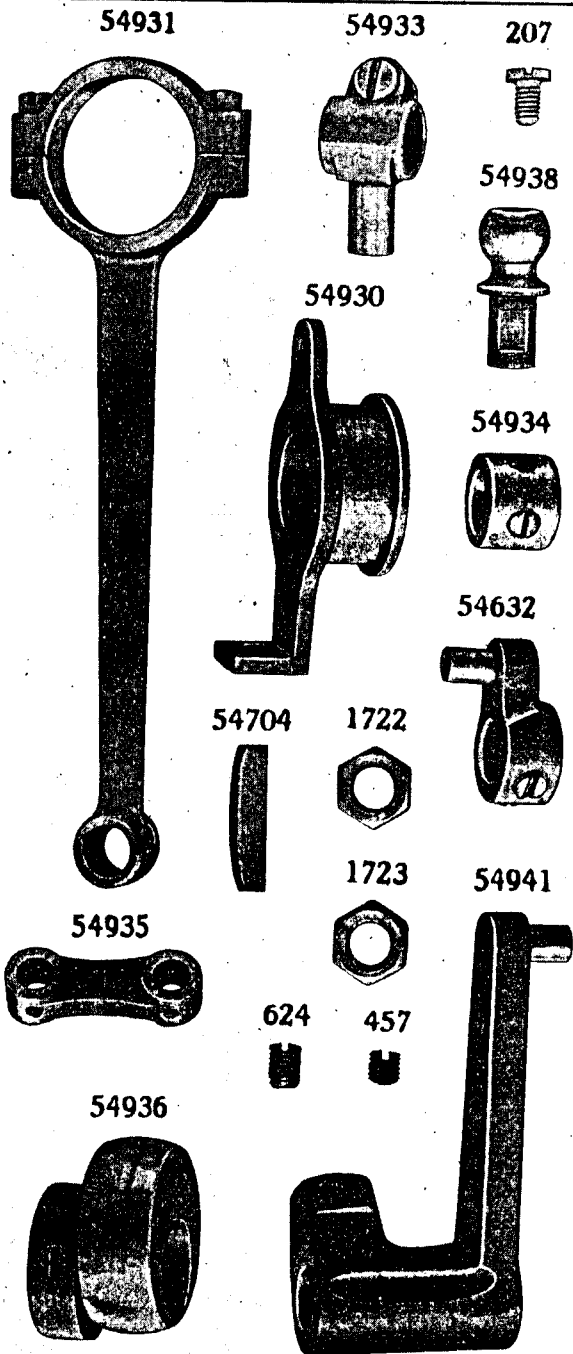

PLATE 6373—ONE-HALF SIZE

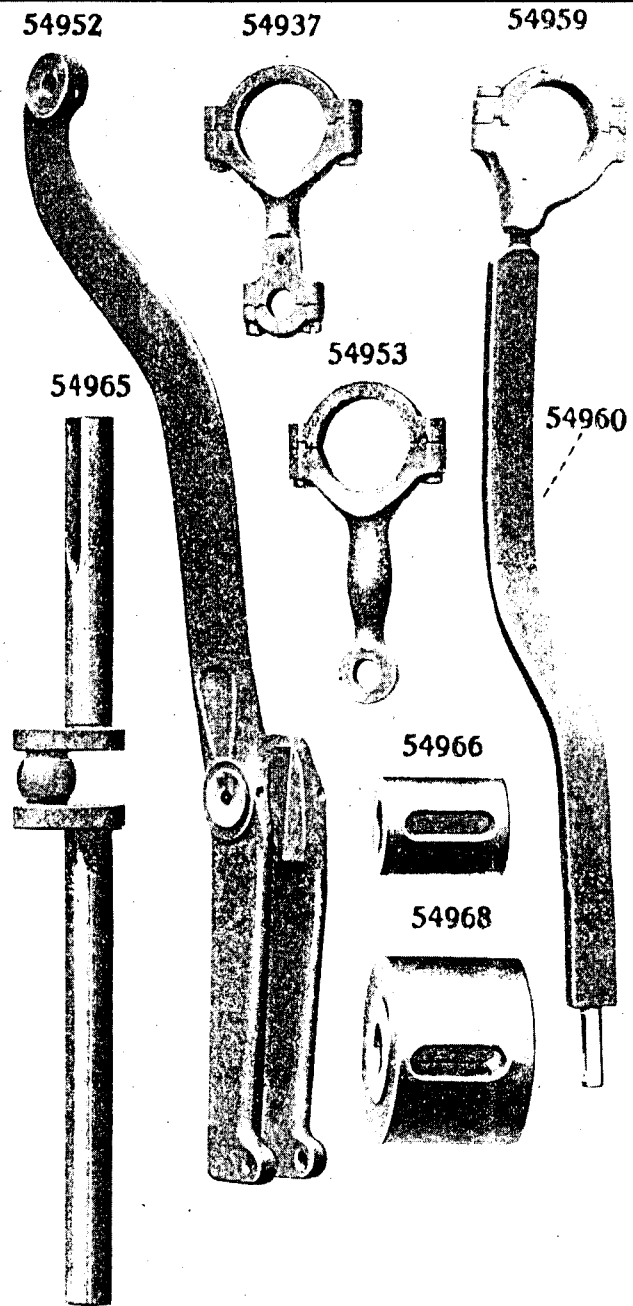

PLATE 6374—FULL SIZE

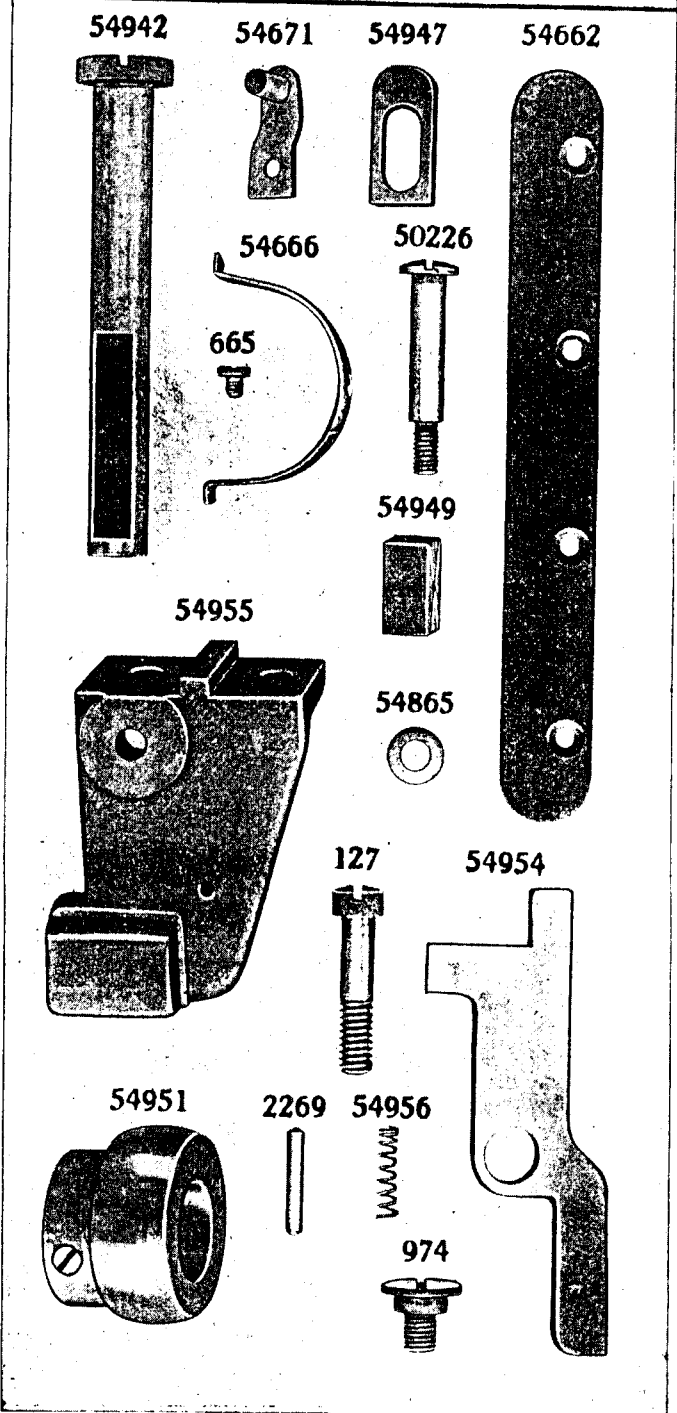

PLATE 6375—ONE-HALF SIZE

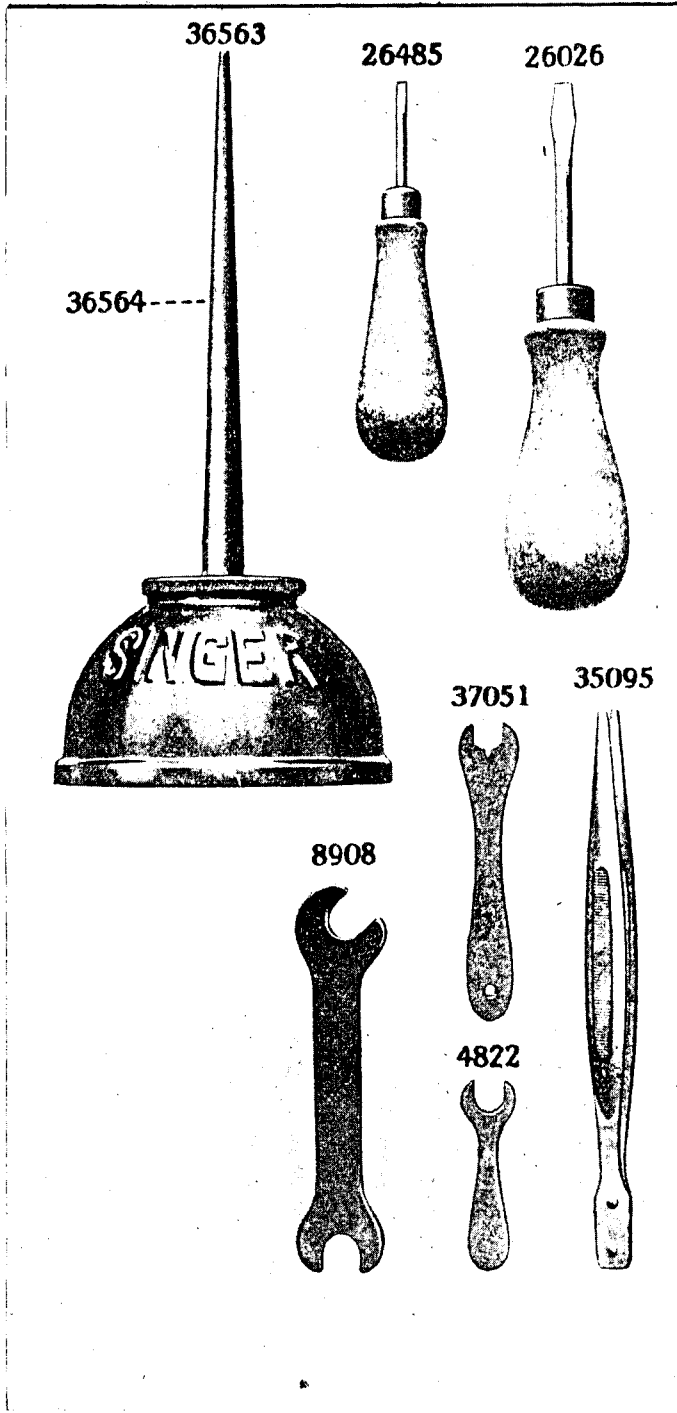
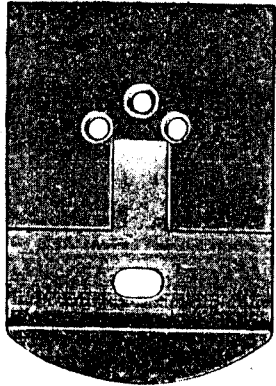
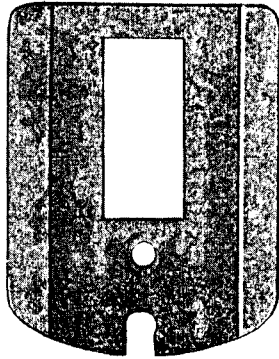

PLATE 6377—FULL SIZE

36586



26277



19294



405



624



202



1174



922



36598

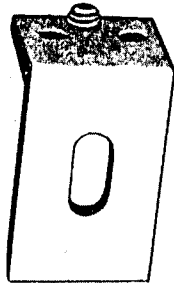

PLATE 6378—FULL SIZE

55008



54978



54719



50228



54718

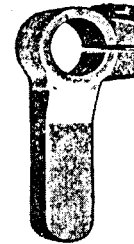

54979

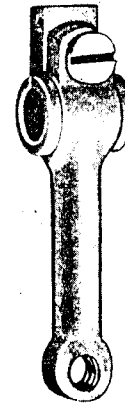

1492



54986



54732



54984

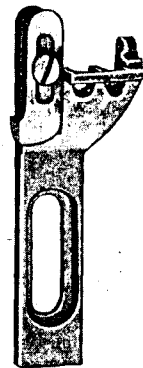

662



1425



38145

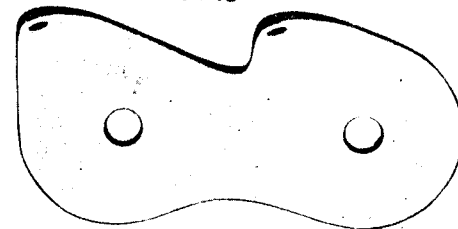

PLATE 6380—FULL SIZE

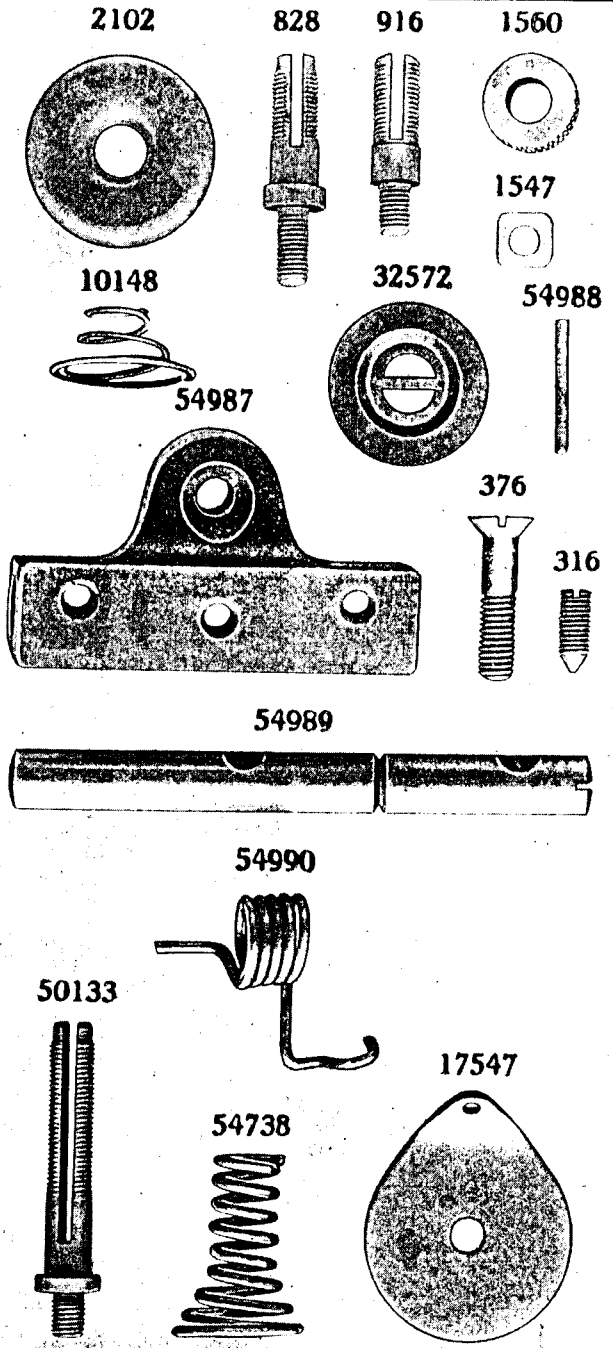

PLATE 6381—FULL SIZE

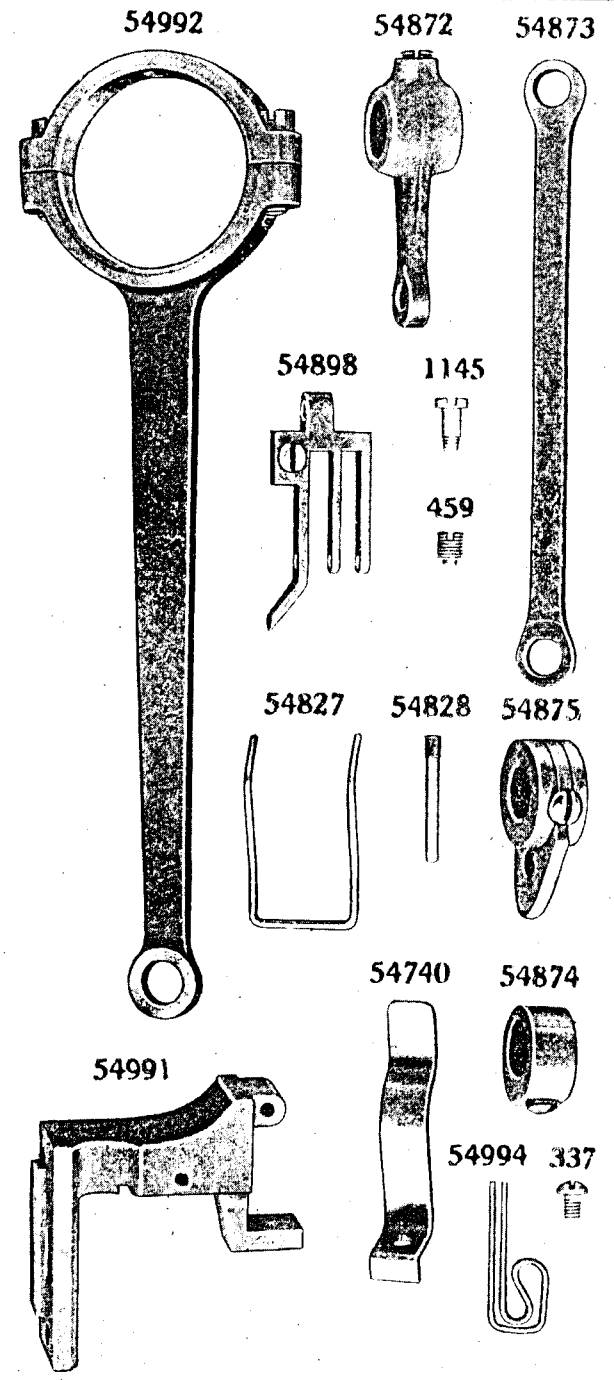
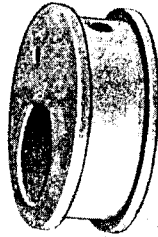

PLATE 6382—FULL SIZE

54876



54995



54879



54899



54997



54996

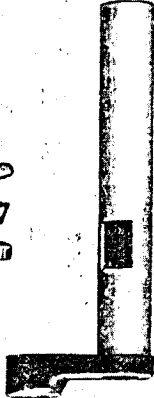

217



55016



54758

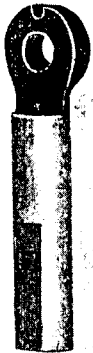

54806



743



1484



54772



2827



8505



PLATE 6383—ONE-HALF SIZE

54767



54807



4883

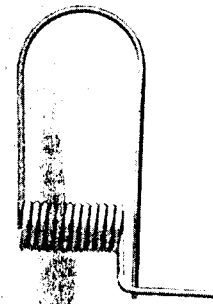

54999



4882



4879



55021

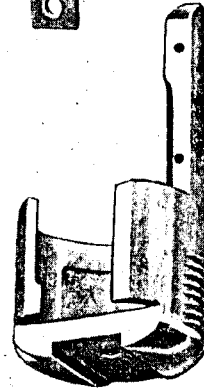

55023



PLATE 6384-FULL SIZE

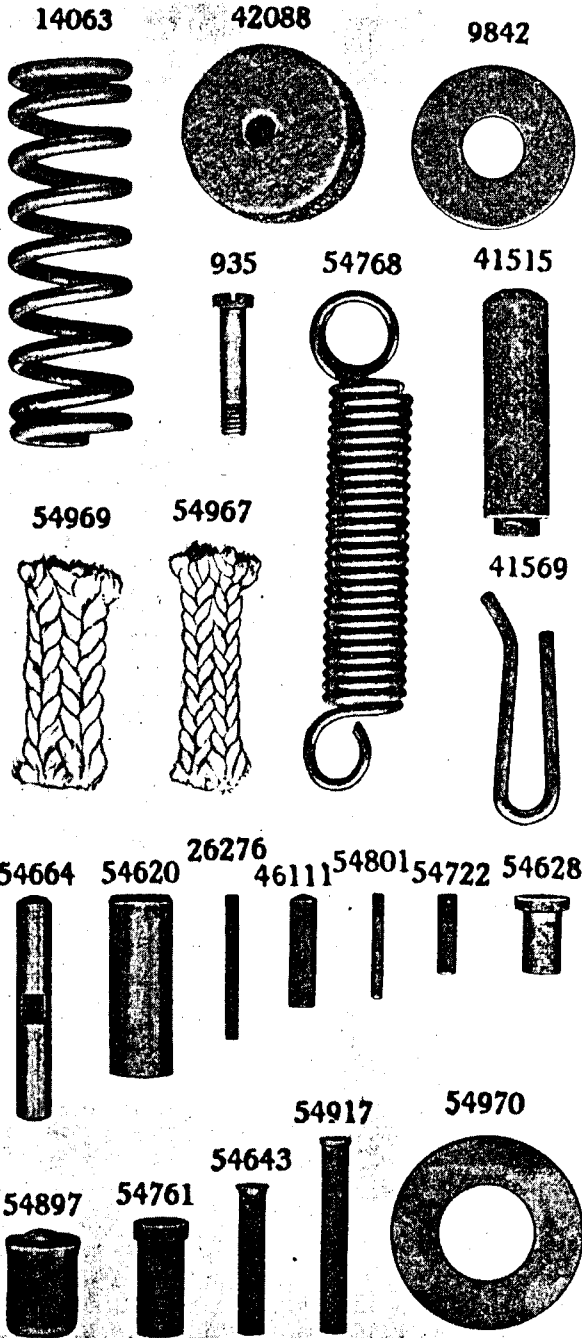

PLATE 6385-FULL SIZE

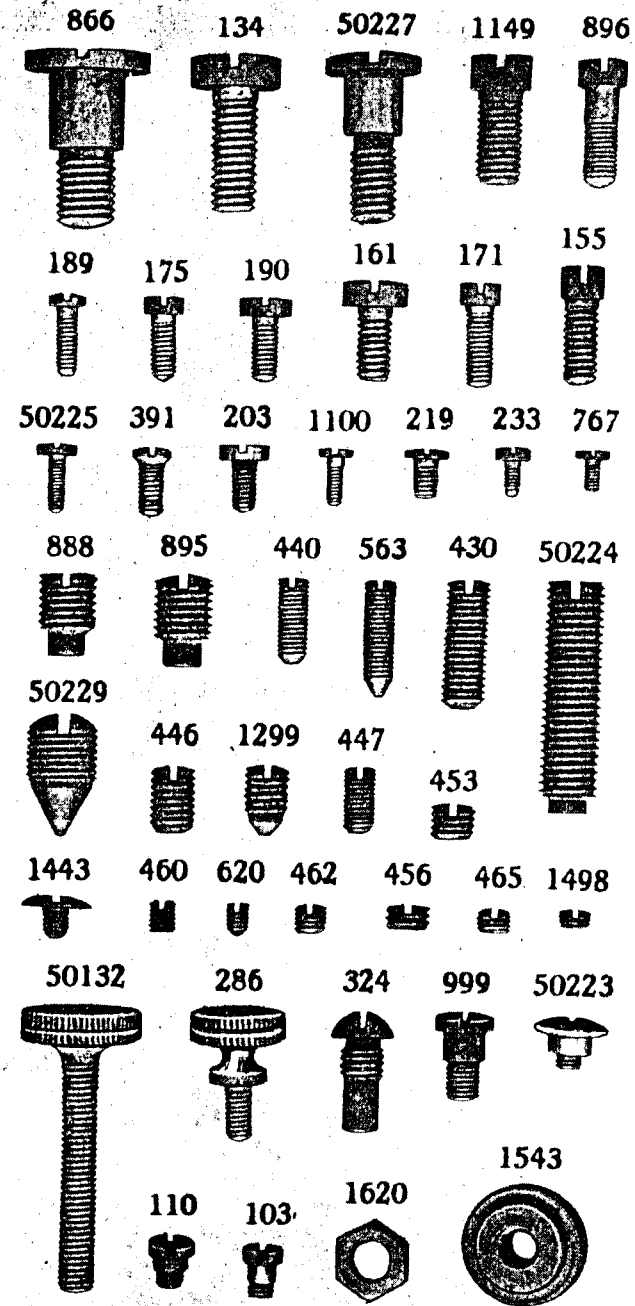
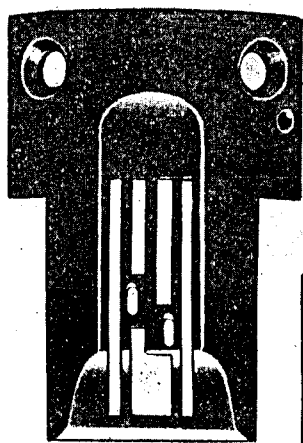

PLATE 6386—FULL SIZE

54905



1319



50128



55011



55019

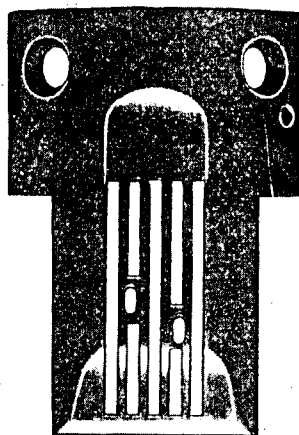

55010



55018



55015



54839



55012

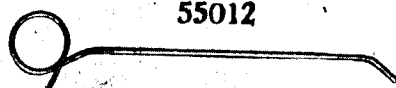
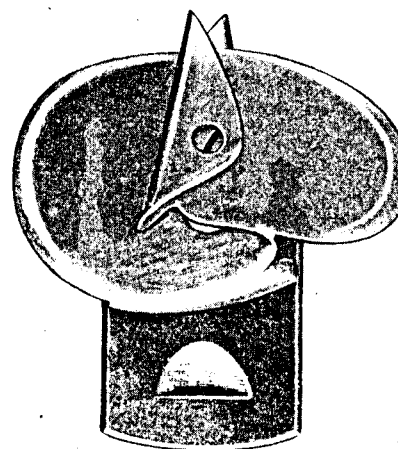
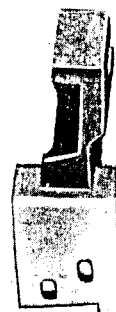

PLATE 6387—FULL SIZE

36597



55025



18054



PLATE 6388—ONE-HALF SIZE

54980

