

Form U 3007
Form U 3007
(Rev. 583)
Printed in Japan

MACHINE PARTS CHART **for** **SINGER***

17U230
17U241
17U242

★ A Trademark of THE SINGER COMPANY
Copyright © 1976 THE SINGER COMPANY
All Rights Reserved Throughout the World

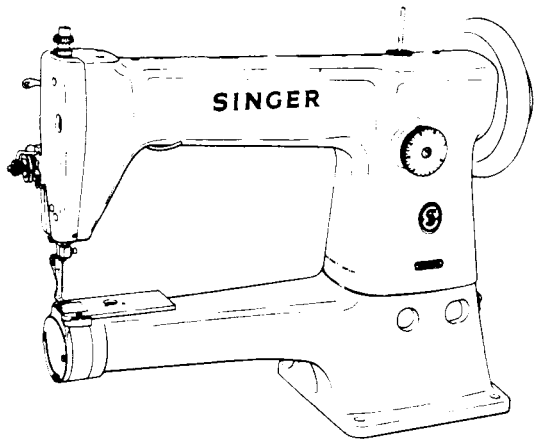

SINGER*

17U241

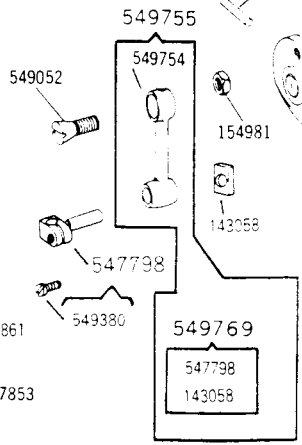
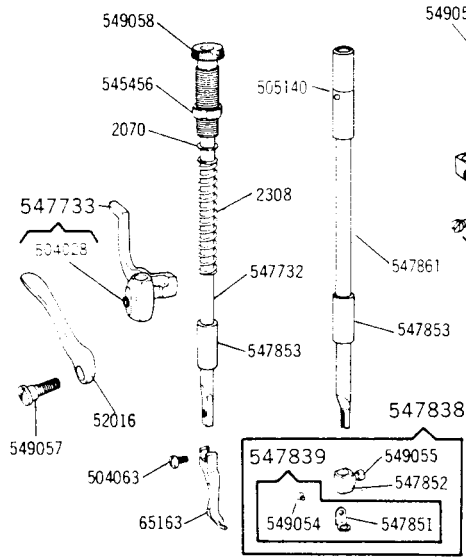
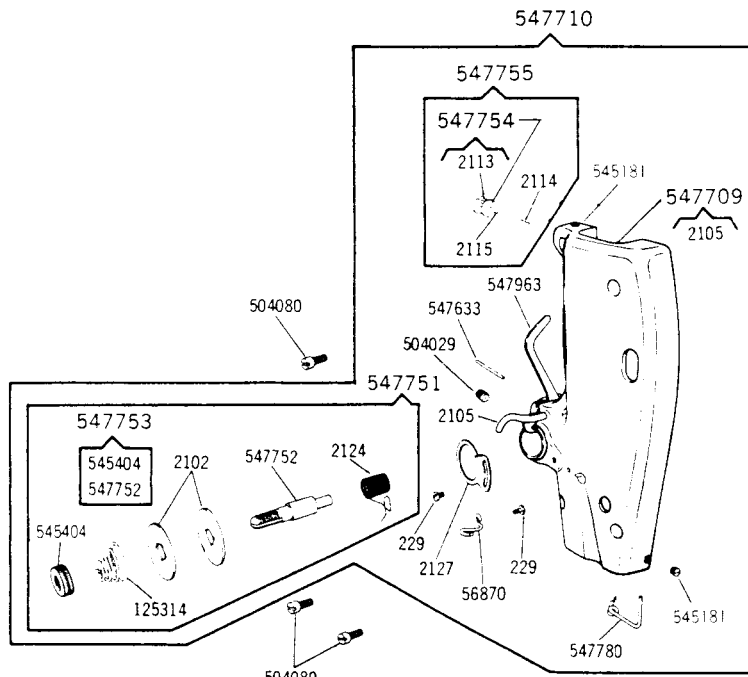
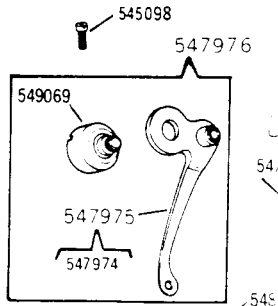

**PARTS ONLY FOR MACHINE
17U230/U241**

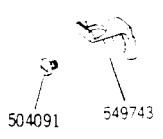
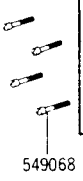
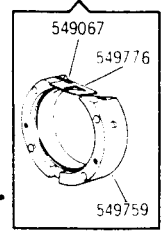
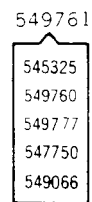
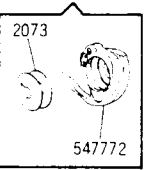
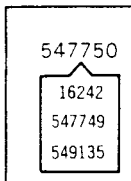
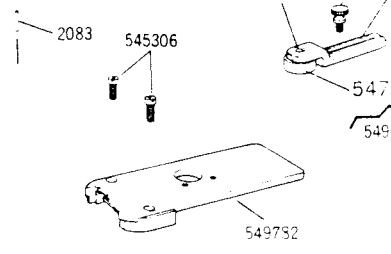
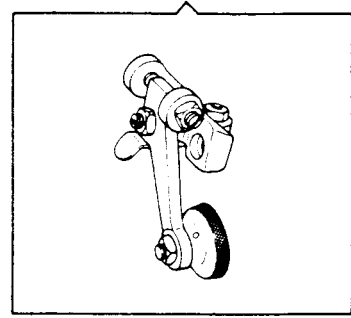
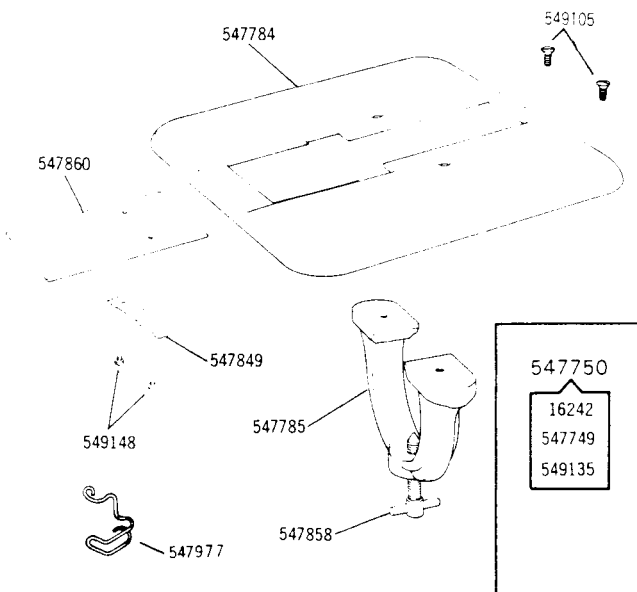

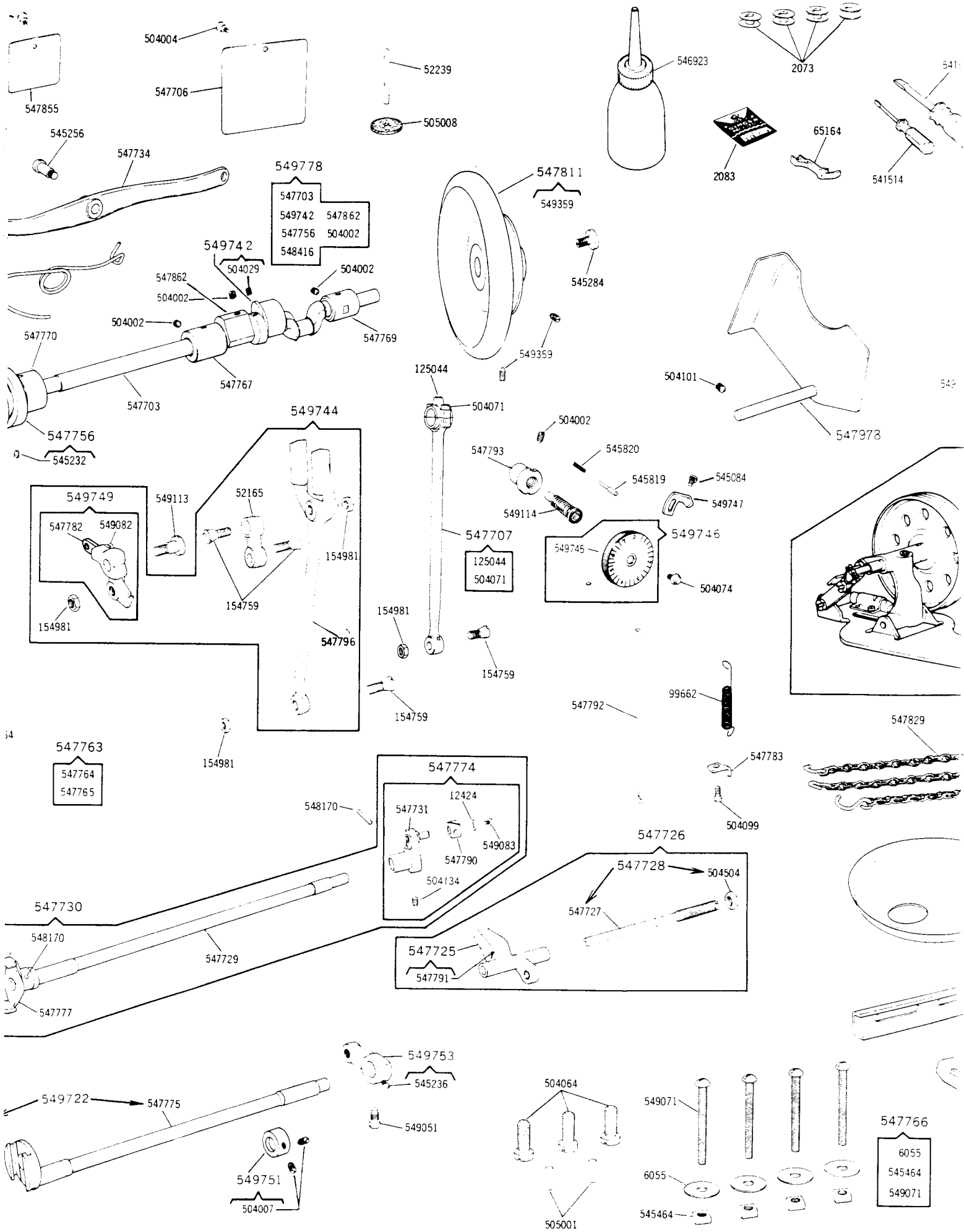

505633

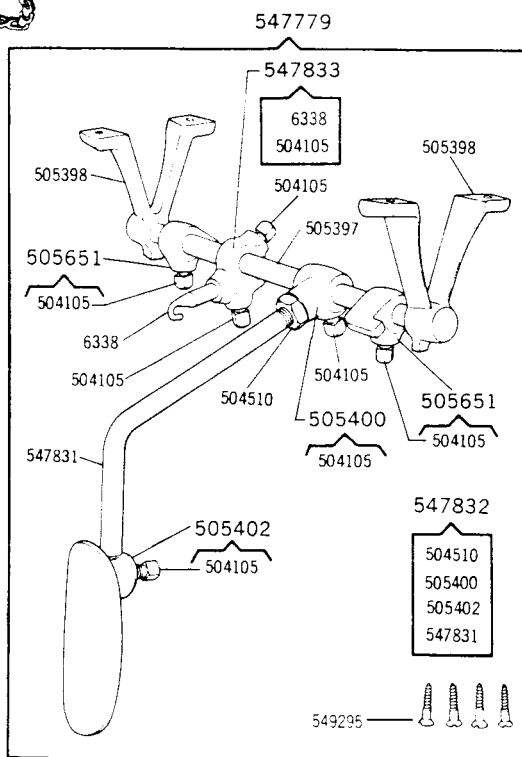
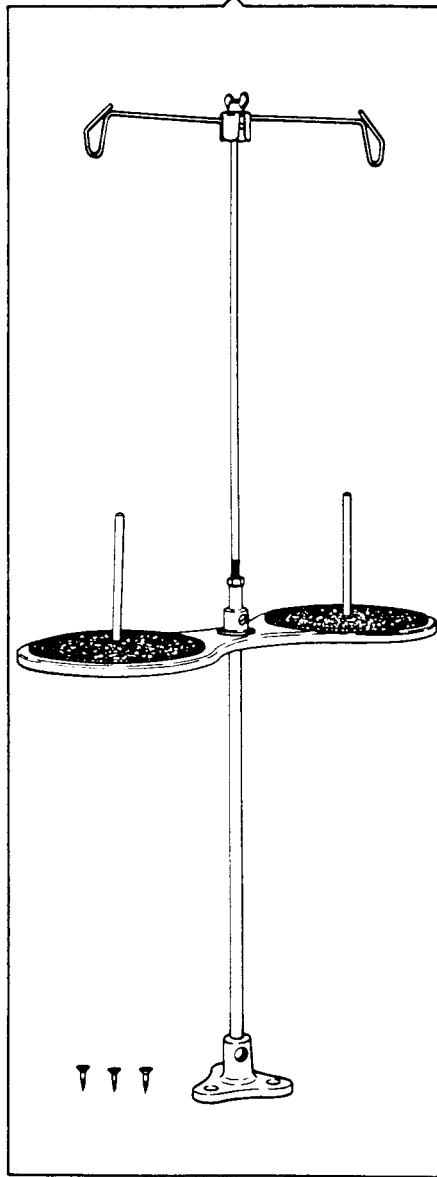
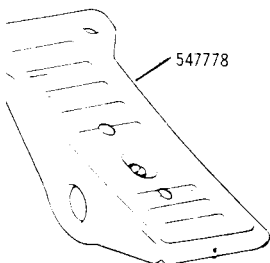
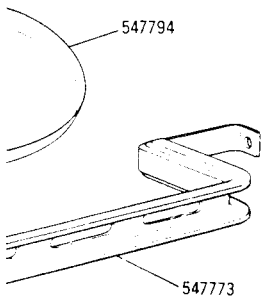
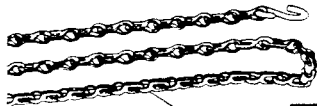
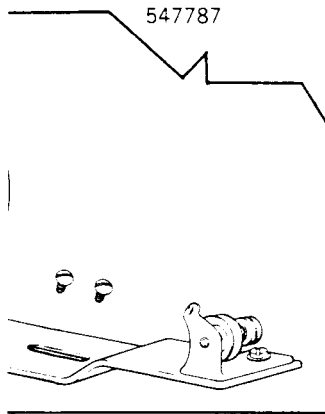
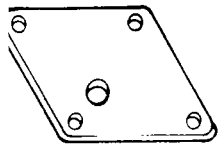
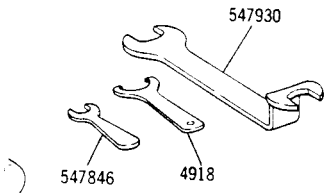

PARTS ONLY FOR MACHINE

17U230

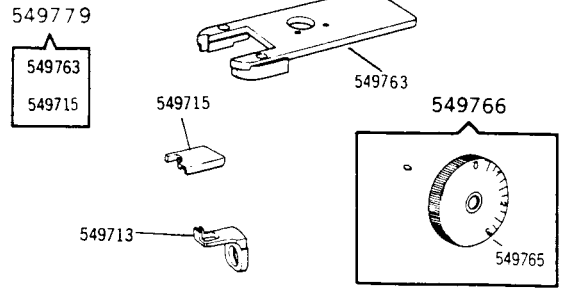

PARTS ONLY FOR MACHINE

17U242

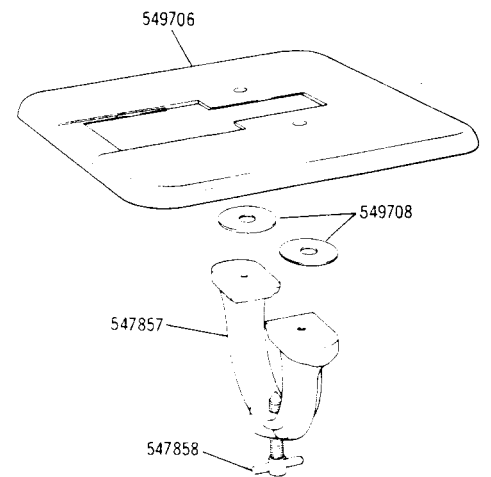
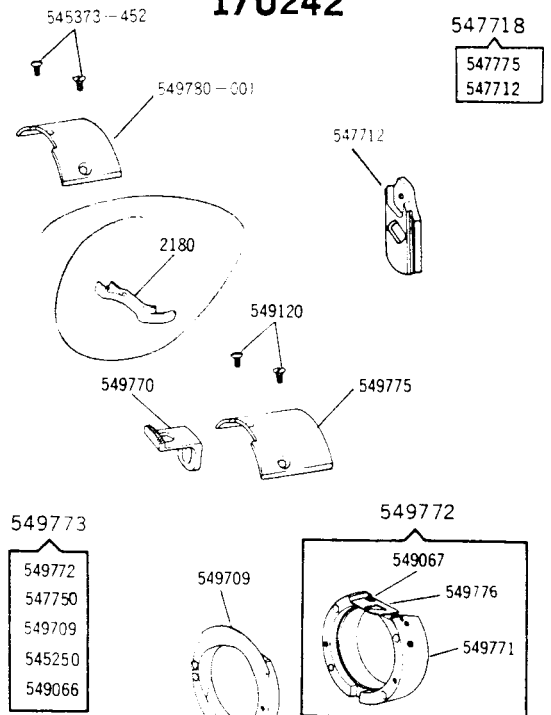

NUMERICAL LIST OF PARTS FOR 17U241, 17U242 AND 17U242 M/C

| Part No. | 17U | | | Description | Part No. | 17U | | | Description |
|------------|-----|-----|-----|---|----------|-----|-----|-----|--|
| | 230 | 241 | 242 | | | 230 | 241 | 242 | |
| 229 | * | * | * | Face Plate Thread Guard (upper) Screw (809) | 545236 | * | * | * | Feed Rock Shaft Crank Set Screw (803) |
| | | | | | 545250 | * | * | * | Shuttle Race Ring Screw (2) (803) |
| 229 | * | * | * | Thread Take-up Spring Regulator Plate Adjusting Screw (809) | 545256 | * | * | * | Presser Bar Lifter Lever Hinge Screw (850) |
| 2070 | * | * | * | Presser Bar Spring Washer | 545284 | * | * | * | Arm Shaft Screw (802) |
| 2073 | * | * | * | Shuttle Bobbin | 545306 | * | * | * | Throat Plate Holder Screw (2) (805) |
| 2102 | * | * | * | Tension Disc (2) | 545325 | * | * | * | Shuttle Race Ring Screw (2) (809) |
| 2105 | * | * | * | Tension Thread Guard | 545404 | * | * | * | Tension Regulating Thumb Nut (852) |
| 2113 | * | * | * | Thread Retaining Disc Steady Pin | 545456 | * | * | * | Pressure Regulating Thumb Screw Lock Nut (851) |
| 2114 | * | * | * | Thread Retaining Spring | | | | | |
| 2115 | * | * | * | Thread Retaining Stud | 545819 | * | * | * | Feed Regulating Stud Lock Pin |
| 2124 | * | * | * | Thread Take-up Spring | 545820 | * | * | * | Feed Regulating Stud Lock Pin Spring |
| 2127 | * | * | * | Thread Take-up Spring Regulator Plate | 547633 | * | * | * | Tension Releaser Hinge Pin |
| 2308 | * | * | * | Presser Bar Spring | 547703 | * | * | * | Arm Shaft |
| 12424 | * | * | * | Oscillating Shaft Crank Slide Block Cap Screw Washer | 547706 | * | * | * | Arm Side Cover |
| | | | | | 547707 | * | * | * | Crank Connecting Rod with 125044 and two 504071 (833) |
| 16242 | * | * | * | Shuttle Race Ring Cover Latch | | | | | |
| 52016 | * | * | * | Presser Bar Lifter | 547709 | * | * | * | Face Plate (body) with 2105 |
| 52165 | * | * | * | Feed Connecting Link | 547710 | * | * | * | Face Plate complete, Nos. 504029 (833), 56870, 547780, 547755, 2127, 547633, 547963, 547751, 547709 with two each 229 and 545181 (803) |
| 56870 | * | * | * | Face Plate Thread Guard (upper) | | | | | |
| 65163 | * | * | * | Presser Foot (narrow toe) | | | | | |
| 99662 | * | * | * | Feed Reverse Lever Return Spring | 547712 | * | * | * | Feed Dog Carrier |
| 125044 | * | * | * | Crank Connecting Rod Oil Pad (felt) | 547718 | * | * | * | Feed Rock Shaft 547775 with 547712 |
| 125314 | * | * | * | Tension Spring | 547725 | * | * | * | Oscillating Rock Shaft (body) with 547791 |
| 143058 | * | * | * | Needle Bar Connecting Stud Slide Block | | | | | |
| 154759 | * | * | * | Crank Connecting Rod Hinge Screw (850) | 547726 | * | * | * | Oscillating Rock Shaft complete, Nos. 547725 and 547728 |
| 154759 | * | * | * | Feed Connecting Link Hinge Screw (2) (850) | 547727 | * | * | * | Oscillating Rock Shaft Hinge Pin |
| | | | | | 547728 | * | * | * | Oscillating Rock Shaft Hinge Pin 547727 and 504504 (819) |
| 154759 | * | * | * | Feed Forked Connection Hinge Screw (850) | 547729 | * | * | * | Oscillating Shaft |
| 154961 | * | * | * | Crank Connecting Rod Hinge Screw Nut (819) | 547730 | * | * | * | Oscillating Shaft 547729 with 547724, 547777 and 548170 |
| 154981 | * | * | * | Feed Connecting Link Hinge Screw Nut (2) (819) | 547731 | * | * | * | Oscillating Shaft Crank (body) with Screw Stud |
| 154981 | * | * | * | Feed Forked Connection Hinge Screw Nut (819) | 547732 | * | * | * | Presser Bar |
| | | | | | 547733 | * | * | * | Presser Bar Lifter Bracket with 504028 (850) |
| 154981 | * | * | * | Needle Bar Connection Link Hinge Screw Nut (819) | 547734 | * | * | * | Presser Bar Lifter Lever |
| 504002 | * | * | * | Arm Shaft Bushing (intermediate) Set Screw (850) | 547744 | * | * | * | Shuttle Bobbin 2073 with 547772 |
| 504002 | * | * | * | Arm Shaft Bushing (back) Set Screw (850) | 547749 | * | * | * | Shuttle Race Ring Cover |
| 504002 | * | * | * | Arm Shaft Counterbalance Set Screw (850) | 547752 | * | * | * | Shuttle Race Ring Cover 547749 with 16242 and two 549135 (810) |
| 504002 | * | * | * | Feed Regulating Stud Bushing Set Screw (850) | 547752 | * | * | * | Tension complete, Nos. 125314, 2124, 547775 and two 2115 |
| 504004 | * | * | * | Arm Side Cover Thumb Screw (852) | 547754 | * | * | * | Tension Screw Stud |
| 504004 | * | * | * | Cylinder Side Cover Thumb Screw (852) | 547755 | * | * | * | Tension Screw Stud 547752 with 545404 |
| 504007 | * | * | * | Feed Rock Shaft Collar Set Screw (2) (850) | 547756 | * | * | * | Thread Retaining Disc with 2113 |
| 504028 | * | * | * | Presser Bar Lifter Bracket Set Screw (850) | 547767 | * | * | * | Thread Retainer Guide complete, Nos. 547754, 2114 and 2115 |
| 504029 | * | * | * | Feed Cam Set Screw (850) | 547769 | * | * | * | Thread Take-up Cam with 545232 (833) |
| 504029 | * | * | * | Tension Screw Stud Set Screw (833) | 547770 | * | * | * | Arm Shaft Bushing (intermediate) |
| 504063 | * | * | * | Presser Foot Screw | 547771 | * | * | * | Arm Shaft Bushing (back) |
| 504063 | * | * | * | Roller Presser Screw | 547774 | * | * | * | Arm Shaft Bushing (front) |
| 504064 | * | * | * | Arm Screw (2) | | | | | Shuttle Body with Cover |
| 504071 | * | * | * | Crank Connecting Rod Cap Screw (2) (833) | 547775 | * | * | * | Oscillating Shaft Crank complete, Nos. 547731, 547790, 549083 (800), 12424 and 504134 (850) |
| 504074 | * | * | * | Feed Regulating Stud Head Cap Screw (850) | 547776 | * | * | * | Feed Rock Shaft |
| 504080 | * | * | * | Face Plate Screw (3) (851) | 547777 | * | * | * | Presser Bar Lifter Lever Spring |
| 504091 | * | * | * | Feed Dog Screw (803) | 547778 | * | * | * | Shuttle Driver and Feed Lifting Cam |
| 504099 | * | * | * | Feed Reverse Lever Return Spring Bracket Screw (1050) | 547780 | * | * | * | Face Plate Thread Guard (lower) |
| 504101 | * | * | * | Belt Safety Guard Shaft Set Screw (830) | 547782 | * | * | * | Feed Reverse Lever |
| 504134 | * | * | * | Oscillating Shaft Crank Set Screw (850) | 547783 | * | * | * | Feed Reverse Lever Return Spring Bracket |
| 504504 | * | * | * | Oscillating Rock Shaft Hinge Pin Lock Nut (819) | 547790 | * | * | * | Oscillating Shaft Crank Slide Block |
| 505001 | * | * | * | Arm Dowel Pin (2) | 547791 | * | * | * | Oscillating Rock Shaft Oil Pad (felt) |
| 505008 | * | * | * | Arm Spool Pin Washer (felt) | 547792 | * | * | * | Feed Reverse Lever Pitman |
| 505140 | * | * | * | Needle Bar Bushing (upper) | 547793 | * | * | * | Feed Regulating Stud Bushing |
| 543023-001 | * | * | * | Roller Presser Complete, (1-1/4 in. fine roller) | 547796 | * | * | * | Feed Forked Connection |
| 545084 | * | * | * | Feed Regulating Stud Head Stopper Screw (853) | 547798 | * | * | * | Needle Bar Connecting Stud with 543380 (813) |
| 545098 | * | * | * | Thread Take-up Lever Hinge Screw Set Screw (850) | 547811 | * | * | * | Machine Pulley with two 549359 (850) |
| 545181 | * | * | * | Face Plate Thread Guard (lower) Screw (803) | 547838 | * | * | * | Needle Clamp (body) 547852 with 549055 and 547830 |
| 545181 | * | * | * | Thread Retaining Stud Set Screw (803) | 547853 | * | * | * | Needle Clamp Thread Guide 547851 with 549054 (851) |
| 545232 | * | * | * | Thread Take-up Cam Set Screw (833) | 547855 | * | * | * | Needle Clamp (body) |
| | | | | | 547861 | * | * | * | Needle Bar Bushing (lower) |
| | | | | | 547862 | * | * | * | Presser Bar Bushing |
| | | | | | | | | | Cylinder Side Cover |
| | | | | | | | | | Needle Bar (narrow) |
| | | | | | | | | | Arm Shaft Counterbalance |

NUMERICAL LIST OF PARTS FOR 17U241, 17U230 AND 17U242 M/C

| Part No. | 17U | | | Description | Part No. | 17U | | | Description |
|-----------|-----|-----|-----|---|---|-----|-----|-----|--|
| | 230 | 241 | 242 | | | 230 | 241 | 242 | |
| 547963 | * | * | * | Tension Releaser | <u>ACCESSORIES FOR MACHINES 17U230, 17U241, 17U242</u> | | | | |
| 547974 | * | * | * | Thread Take-up Lever Roller Stud complete | (Supplied with Machine) | | | | |
| 547975 | * | * | * | Thread Take-up Lever with 547974 | CAT. 2083 | * | * | * | Needle (size #19) (6) |
| 547976 | * | * | * | Thread Take-up Lever 547975 with 549069 (851) | 2073 | * | * | * | Shuttle Bobbin (4) |
| 547978 | * | * | * | Belt Safety Guard with Shaft | 2180 | * | * | * | Presser Foot |
| 548170 | * | * | * | Oscillating Shaft Crank Pin | 4918 | * | * | * | Wrench (for 545456) |
| 548170 | * | * | * | Shuttle Driver Pin | 6055 | * | * | * | Machine Bolt Washer (4) |
| 548416 | * | * | * | Thread Take-up Cam Pin | 65164 | * | * | * | Presser Foot (wide toe) |
| 549051 | * | * | * | Feed Rock Shaft Crank Position Screw (803) | 504004 | * | * | * | Guide Thumb Screw (809) |
| 549052 | * | * | * | Needle Bar Connecting Link Hinge Screw (803) | 505656 | * | * | * | Thread Unwinder (for two spools) complete (include three wood screws) (purchased assembly) |
| 549054 | * | * | * | Needle Clamp Thread Guide Screw (851) | 541513 | * | * | * | Screw Driver (large) |
| 549055 | * | * | * | Needle Clamp Screw | 541514 | * | * | * | Screw Driver (small) |
| 549057 | * | * | * | Presser Bar Lifter Screw (810) | 543028-001 | * | * | * | Roller Presser complete, (1-1/4 in. fine roller) |
| 549058 | * | * | * | Pressure Regulating Thumb Screw | 545464 | * | * | * | Machine Bolt Nut (4) (809) |
| 549066 | * | * | * | Shuttle Race Ring Cover Screw (2) (810) | 546923 | * | * | * | Oiler (filled with Singer Type "B" Oil) |
| 549067 | * | * | * | Shuttle Race Thread Protector Screw (809) | 547763 | * | * | * | Guide (roller) complete, Nos. 547765 and 547764 |
| 549068 | * | * | * | Shuttle Race Screw (4) (810) | 547764 | * | * | * | Guide Bracket |
| 549069 | * | * | * | Thread Take-up Lever Hinge Screw (851) | 547765 | * | * | * | Guide Roller with 549070 |
| 549082 | * | * | * | Feed Reverse Lever Set Screw (850) | 547766 | * | * | * | Machine Bolt 549071 with 545464 and 6055 (4) |
| 549083 | * | * | * | Oscillating Shaft Crank Slide Block Cap Screw (809) | 547773 | * | * | * | Motor Treadle Lever |
| 549113 | * | * | * | Feed Regulator Hinge Screw (803) | 547778 | * | * | * | Feed Reversing Treadle complete |
| 549114 | * | * | * | Feed Regulating Stud | 547781 | * | * | * | Feed Reverse Lever Chain |
| 549120 | * | * | * | Throat Plate Screw (2) (806) | 547787 | * | * | * | Universal Bobbin Winder complete, (include two wood screws) (purchased assembly) |
| 549135 | * | * | * | Shuttle Race Ring Cover Latch Screw (2) (810) | 547791 | * | * | * | Crip Pan |
| 549350 | * | * | * | Machine Pulley Set Screw (2) (850) | 547846 | * | * | * | Wrench (for 545454 and 545455) |
| 549380 | * | * | * | Needle Bar Connecting Stud Set Screw (803) | 547930 | * | * | * | Wrench (for 154981) |
| 549709 | * | * | * | Shuttle Race Ring | 549070 | * | * | * | Guide Roller Screw Stud |
| 549710 | * | * | * | Feed Dog | 549071 | * | * | * | Machine Bolt (4) (809) |
| 549714 | * | * | * | Feed Dog Carrier | 549768 | * | * | * | Machine Bed Cushion |
| 549715 | * | * | * | Throat Plate | | | | | |
| 549722 | * | * | * | Feed Rock Shaft 547775 with 549714 | | | | | |
| 549742 | * | * | * | Feed Cam with 504029 (850) | | | | | |
| 549743 | * | * | * | Feed Dog | <u>KNEE LIFTER PARTS FOR 17U230, 17U241, 17U242</u> | | | | |
| 549744 | * | * | * | Feed Forked Connection complete, Nos. 547796, 52165, 549749 with two each 154759 and 154981 | (Fitted to Machine) | | | | |
| 549746 | * | * | * | Feed Regulating Stud Head | 6338 | * | * | * | Rock Shaft Lifting Bracket Hook |
| 549747 | * | * | * | Feed Regulating Stud Head 549745 with Stop Plate | 504105 | * | * | * | Rock Shaft Knee Arm Hub Set Screw (809) |
| 549747 | * | * | * | Feed Regulating Stud Head Stopper | 504105 | * | * | * | Rock Shaft Knee Plate Set Screw (809) |
| 549749 | * | * | * | Feed Regulator with 547782 and 549082 (850) | 504105 | * | * | * | Rock Shaft Lifting Bracket Hook Set Screw (809) |
| 549751 | * | * | * | Feed Rock Shaft Collar with two 504007 (850) | 504105 | * | * | * | Rock Shaft Lifting Bracket Set Screw (809) |
| 549753 | * | * | * | Feed Rock Shaft Crank with 549076 (803) | 504105 | * | * | * | Rock Shaft Stop Dog Set Screw (2) (809) |
| 549754 | * | * | * | Needle Bar Connecting Link | 504311 | * | * | * | Rock Shaft Knee Arm Clamping Nut (809) |
| 549755 | * | * | * | Needle Bar Connecting Link 549754 with 549769 | 505397 | * | * | * | Rock Shaft |
| 549759 | * | * | * | Shuttle Race (body) | 505398 | * | * | * | Rock Shaft Hanger (2) |
| 549760 | * | * | * | Shuttle Race (body) 549759 with 549776 and 549067 (809) | 505400 | * | * | * | Rock Shaft Knee Arm Hub with 504105 (809) |
| 549761 | * | * | * | Shuttle Race complete, Nos. 547750, 549765, 549777 with two each 545325 and 549066 | 505402 | * | * | * | Rock Shaft Knee Plate with 504105 (809) |
| 549763 | * | * | * | Throat Plate Holder | 505651 | * | * | * | Rock Shaft Stop Dog with 504105 (809) (2) |
| 549765 | * | * | * | Feed Regulating Stud Head | 547779 | * | * | * | Rock Shaft complete Nos. 505397, 547832, 547833, 505651 (2), and 505398 (2) with four Wood Screw (1 in., No. 10) |
| 549766 | * | * | * | Feed Regulating Stud Head 549765 with Stop Plate | 547829 | * | * | * | Presser Bar Lifter Lever Chain |
| 549769 | * | * | * | Needle Bar Connecting Stud 547798 with 143053 | 547831 | * | * | * | Rock Shaft Knee Arm |
| 549770 | * | * | * | Feed Dog | 547832 | * | * | * | Rock Shaft Knee Arm complete, Nos. 504310 (809), 547831, 505400 and 505412 |
| 549771 | * | * | * | Shuttle Race (body) | 547833 | * | * | * | Rock Shaft Lifting Bracket with 6338 and two 504105 (809) |
| 549772 | * | * | * | Shuttle Race (body) 549771 with 549067 (809) and 549776 | 549295 | * | * | * | Wood Screw (1 in. No. 10) (4) |
| 549773 | * | * | * | Shuttle Race complete, Nos. 549772, 547750, 549709 with two each 549250 and 549066 | | | | | |
| 549775 | * | * | * | Throat Plate | <u>CLOTH PLATE FOR MACHINES 17U230, 17U241 AND 17U242</u> | | | | |
| 549776 | * | * | * | Shuttle Race Thread Protector | (Optional Parts) | | | | |
| 549777 | * | * | * | Shuttle Race Ring | 547784 | * | * | * | Cloth Plate |
| 549778 | * | * | * | Arm Shaft 547703 with 549742, 547756, 548416, 547862 and 504002 (850) | 547785 | * | * | * | Cloth Plate Bracket |
| 549779 | * | * | * | Throat Plate Holder 549763 and 549715 | 547849 | * | * | * | Cloth Plate Slide Spring |
| 549782 | * | * | * | Throat Plate | 547857 | * | * | * | Cloth Plate Bracket |
| CAT. 2083 | * | * | * | Needle (size #19) | 547858 | * | * | * | Cloth Plate Bracket Set Screw with Handle |

NUMERICAL LIST OF PARTS FOR 17U241, 17U242 AND 17U242 M/C

| <u>Part No.</u> | <u>17U 17U 17U</u> | | | <u>Description</u> |
|-----------------|--------------------|------------|------------|---|
| | <u>230</u> | <u>241</u> | <u>242</u> | |
| 547860 | * | * | * | Cloth Plate Slide |
| 549105 | * | * | * | Cloth Plate Screw (2) (850) |
| 549148 | * | * | * | Cloth Plate Slide Spring Screw (2) (832) |
| 549706 | | | * | Cloth Plate |
| 549708 | | | * | Cloth Plate Washer |
| 545373-452 | | | * | Throat Plate Screw (2) |
| 547977 | * | * | | Finger Guard |
| 549780-001 | | | * | Throat Plate |