

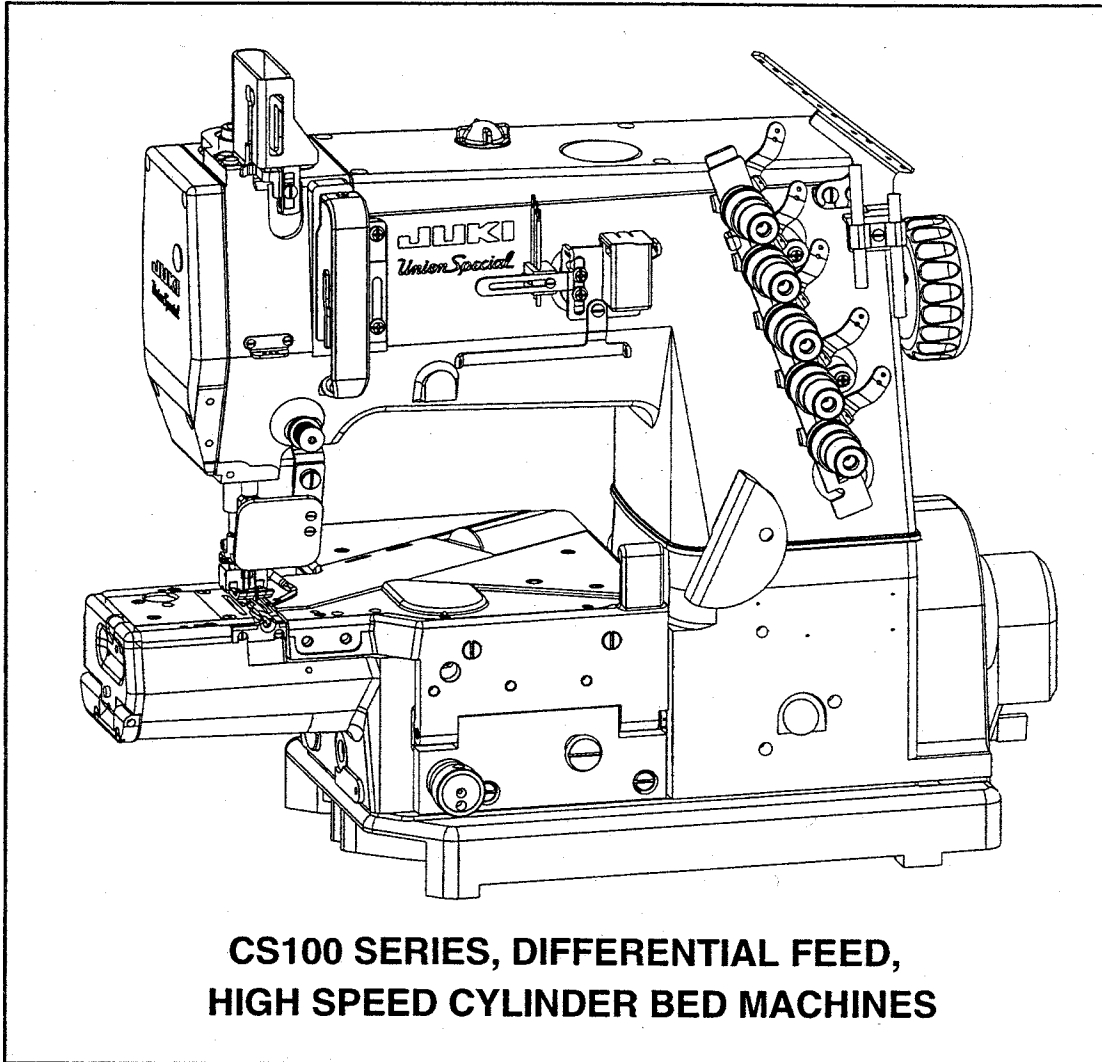

JUKI
Union Special

ADJUSTING INSTRUCTION



**CS100 SERIES, DIFFERENTIAL FEED,
HIGH SPEED CYLINDER BED MACHINES**

**MANUAL NO.EN9803
FOR SEWING KIT**

29480BAE

SEWING KIT 29480BAE

PREFACE

This Engineer's Manual has been designed to assist you in the disassembly, reassembly and adjusting of sewing kit 29480BAE for the Union Special CS100 class machines.

It is the desire of Union Special Corporation that each machine run at its optimum performance. Procedures in this manual are designed specifically for the class CS100 machines and are written to assure long lasting service.

This manual has been comprised on the basis of available information at the time of printing. Changes in design and/or improvements may incorporate a slight modification or configuration in illustrations or adjustments.

New sewing parts included in kit 29480 BAE

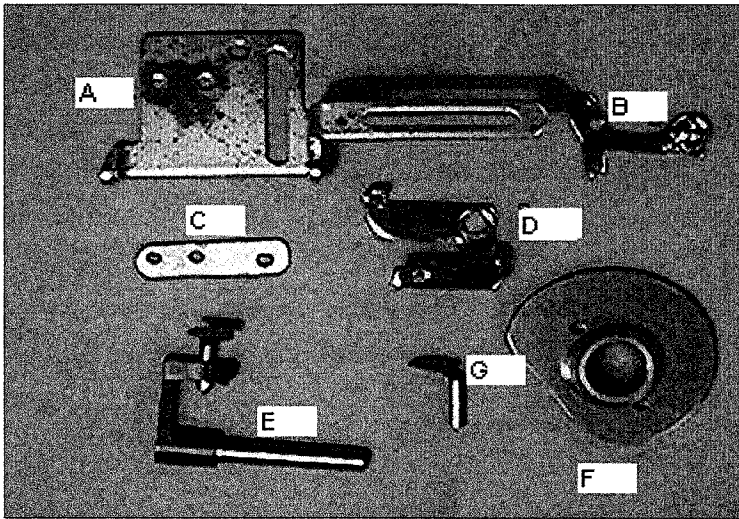

A) NEEDLE THREAD GUIDE PLATE

B) LOOPER THREAD NIPPER

C) LOOPER THREAD GUIDE

D) NEEDLE THREAD GUIDE (nipper assembly)

E) REAR NEEDLE GUARD WITH HOLDER

F) LOOPER THREAD TAKE UP CAM

G) FRONT NEEDLE GUARD

H) CLOTH PLATE

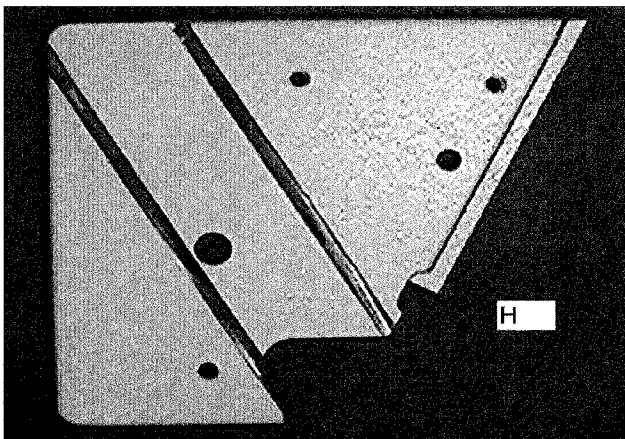

DISASSEMBLY PROCEDURE

TAKE UP CAM REPLACEMENT

Refer to parts manual for disassembly and reassembly

Refer to engineers manual for final adjustments not covered in this procedure

FIG 1

a. Remove cloth plate assembly (50301BG) with its three screws.

b. Remove cylinder cover (50382FV) with its two screws and gasket.

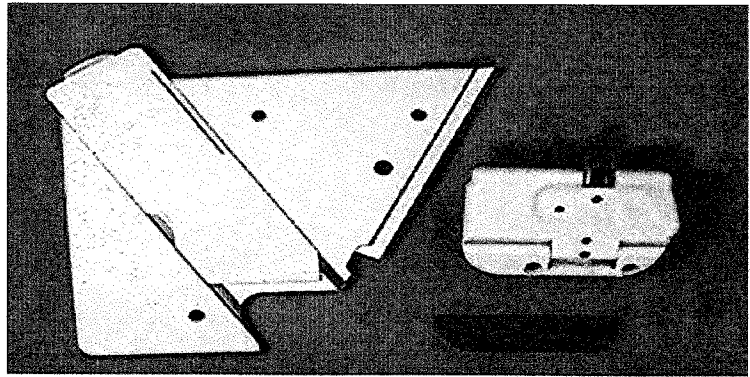

1

FIG 2

Remove sewing parts:

- 1) presser foot
- 2) presser foot stop collar
- 3) main feed dog
- 4) diff. feed dog
- 5) looper
- 6) needles
- 7) throat plate with support

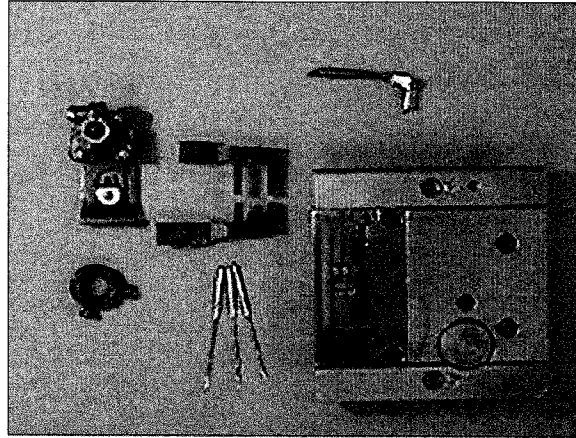

2

FIG 3

a. Remove looper thread guide (50392AG) with its two screws.

b. Remove oil reservoir cover (34382J) with its 11 screws and gasket.

If KLIPP-IT® machine also :

Disconnect carrier bolt (34794A) from lever (34763P) by removing E-ring. Remove carrier bolt with drive link attached. NOTE: if care is taken not to turn the carrier bolt when removing the knife's home position should not need to be reset. Remove lever (34763P) with its screw. Remove oil reservoir cover with its 11 screws.

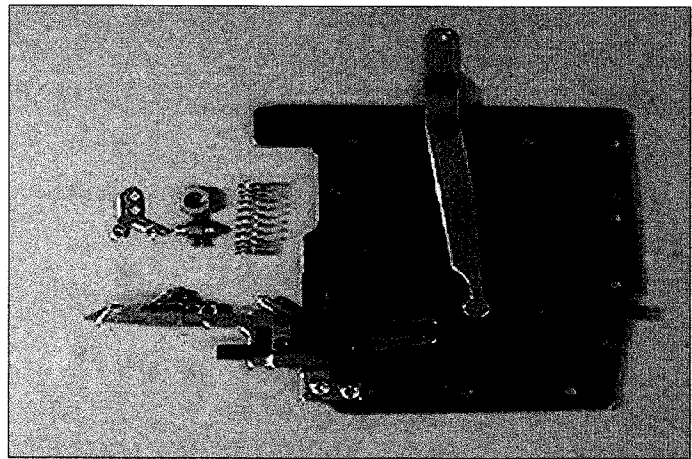

3

FIG 4

a. Remove eccentric assembly (GA29477AP).
NOTE: The first screw in operating direction on eccentric assembly is located on a flat.
It is recommended to completely remove this screw when disassembling.

b. Remove feed bar guide (343335G) with its two screws and gasket.

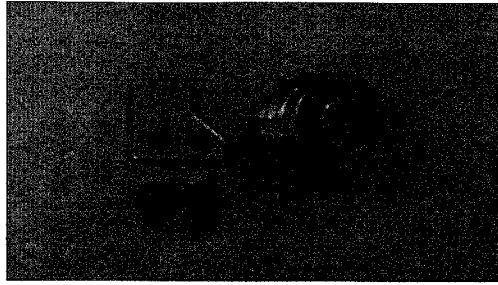

4

FIG 5

Loosen set screw holding guide stud (34335D).

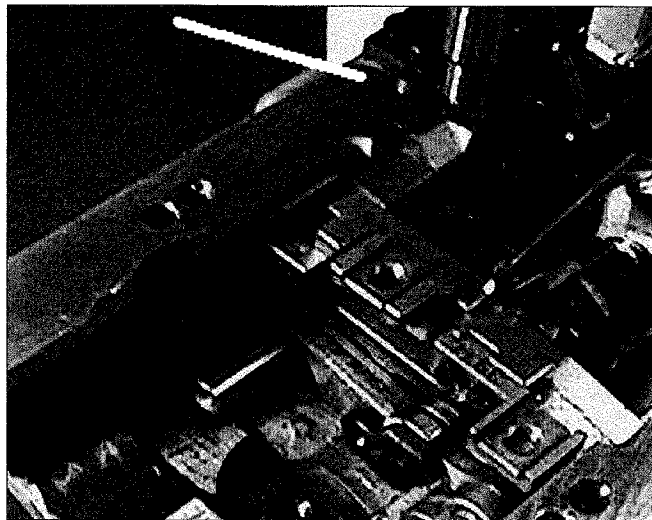

5

FIG 6

Remove guide stud (34335D).

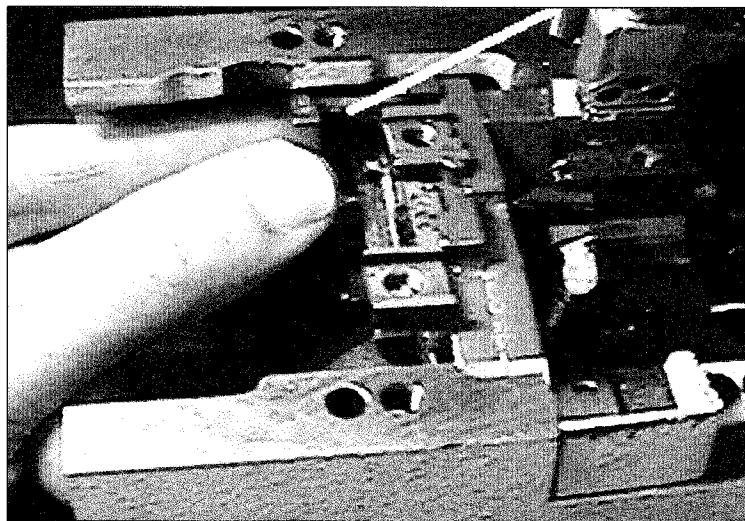

6

FIG 7
Remove eccentric bushing (34337F)
with its screw.

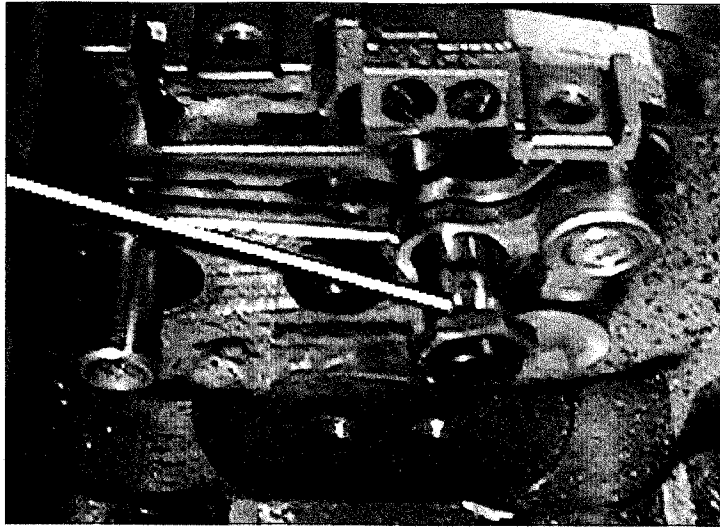

7

FIG 8
a. Loosen the screw in the thrust
collar (34335J) which is located on the
feed drive shaft. Noted by arrow (A)

b. Loosen screw in differential feed
drive lever. Location noted below.
Arrow (B)

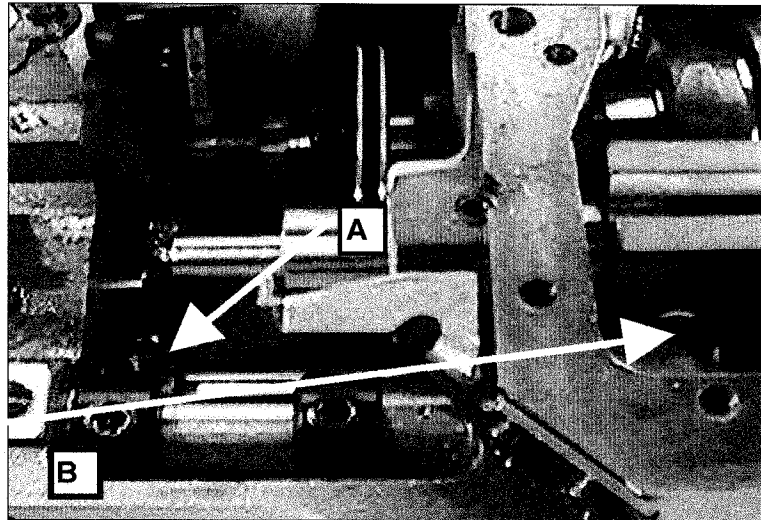

8

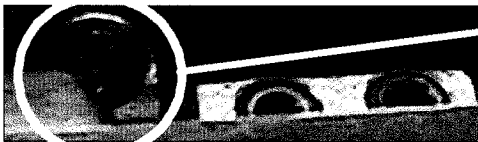
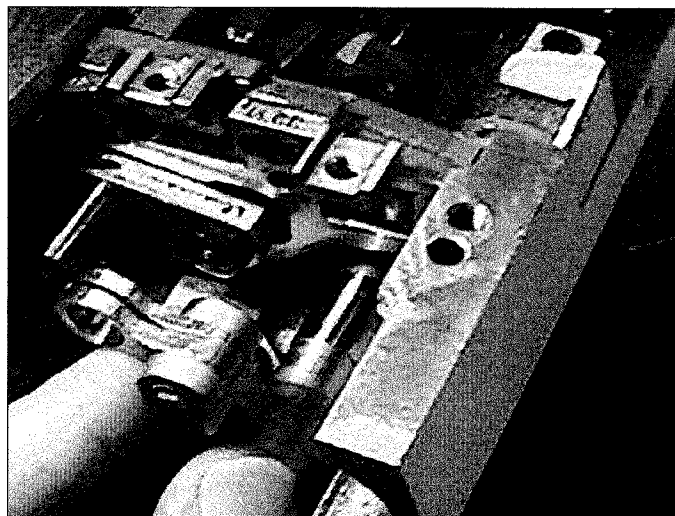

FIG 9
Remove the feed drive shaft (34334A)
along with the thrust collar.



9

FIG 10

Remove feed bar assembly (G29476BV) with its two slide blocks.

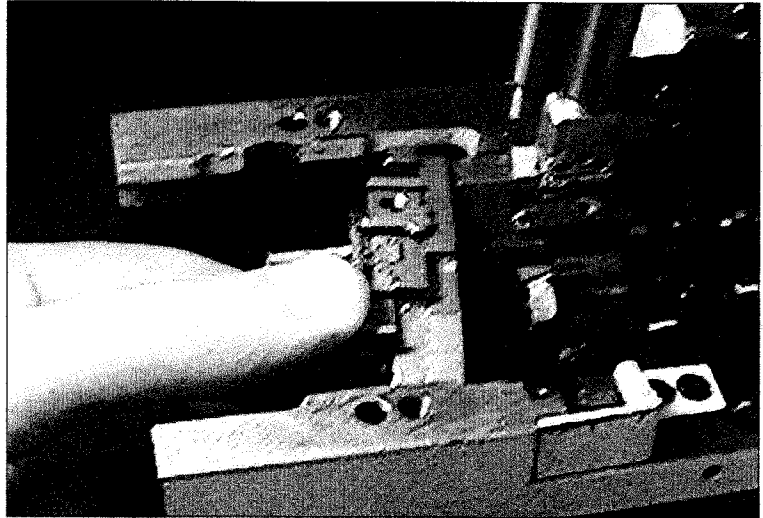

FIG 11

Loosen screw in the rear needle guard drive fork (34368).

FIG 12

a. Remove rear needle guard holder with guard attached.

b. Remove drive fork.

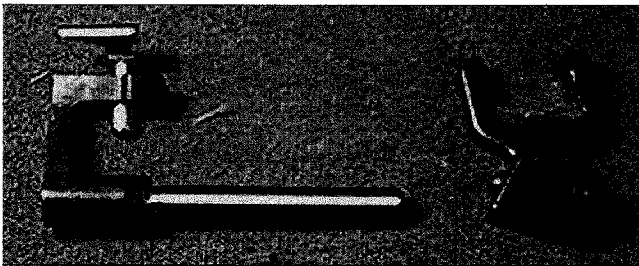

12

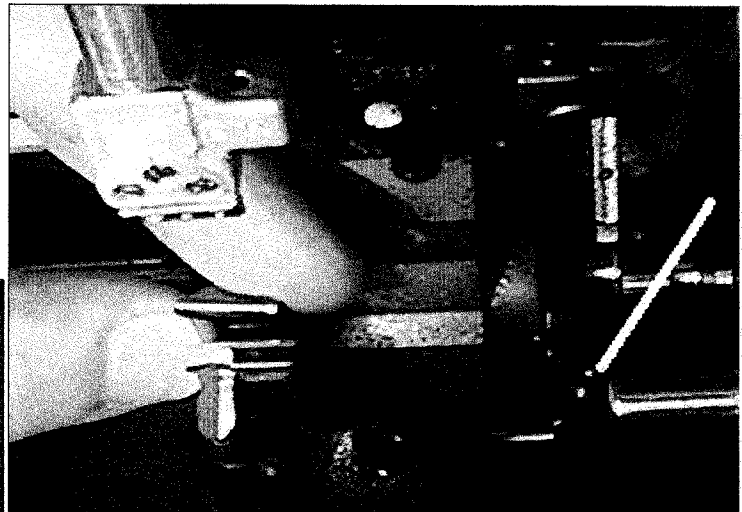

11

FIG 13

a. Loosen screw in take up cam set collar (34366).

b. Loosen two screws in take up cam (34323).

c. Loosen screw in looper cam (34323C)
NOTE: looper cam may not be in certain styles of machines.

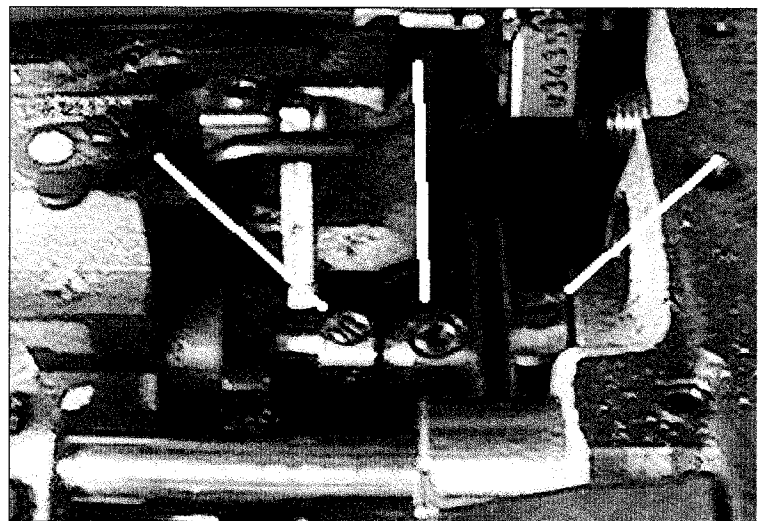

13

FIG 14

Loosen two screws in the feed drive assembly (G29476BS)

NOTE: the first screw in operating direction is on a flat and is recommended to be completely removed for disassembly.

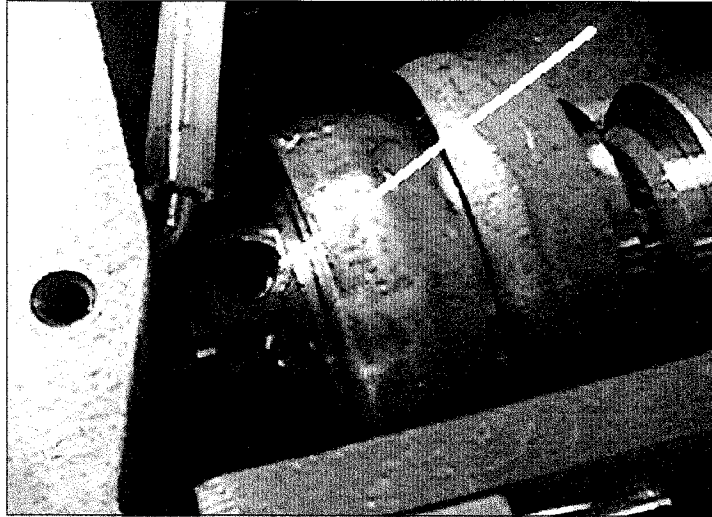

14

FIG 15

Loosen screw in looper avoid eccentric assembly (VG29105F).

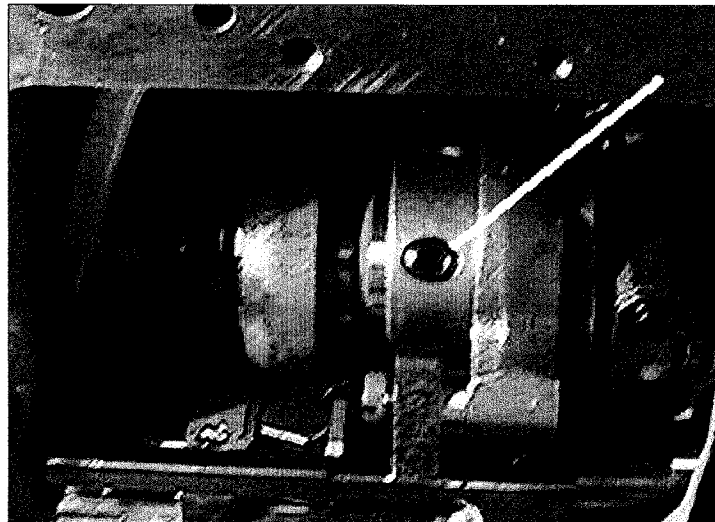

15

FIG 16

a. Turn looper avoid eccentric until the holes in the eccentric line up over the screws in the drive lever crank (G29105F).

b. Loosen the two screws in the drive lever crank.

NOTE: the first screw in operating direction is on a flat and should be removed completely for disassembly.

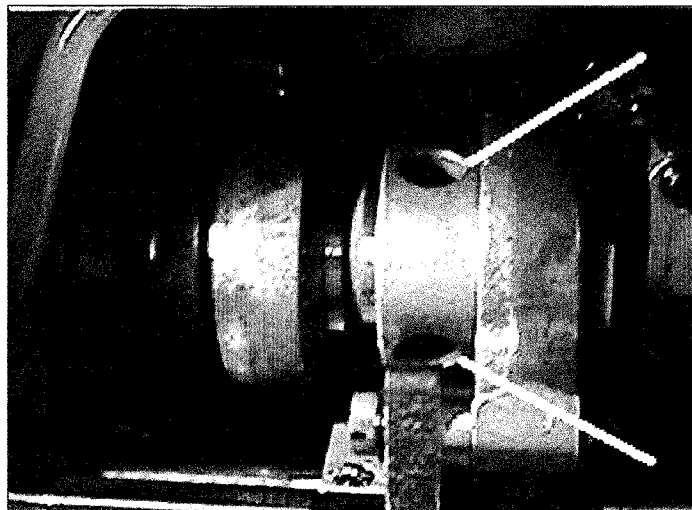

16

FIG 17

Remove the left main shaft (34722A).

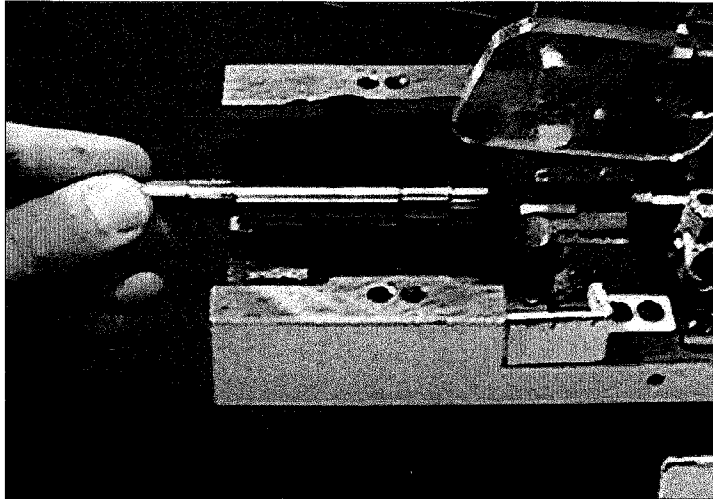

17

FIG 18

Along with the left main shaft remove :

- a) set collar (34366)
- b) take up cam (34323)
- c) looper cam (34323C)

NOTE: The looper cam (34323C) can be discarded at this time. It is not currently part of the machine assembly.

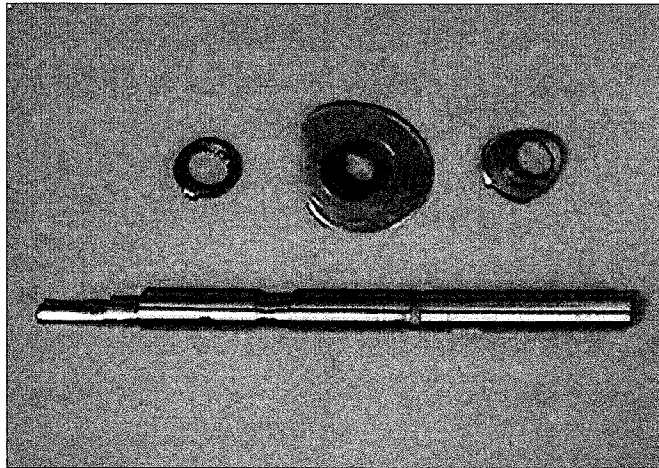

18

REASSEMBLY PROCEDURE

TAKE UP CAM REPLACEMENT

Note: when reassembling the Klipp-It cover refer to manual # PT 9802, seal the 11 screws which fasten the klippit down with Three Bond TB1104 or equivalent (CE62).

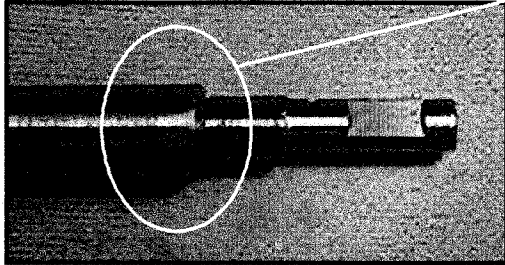
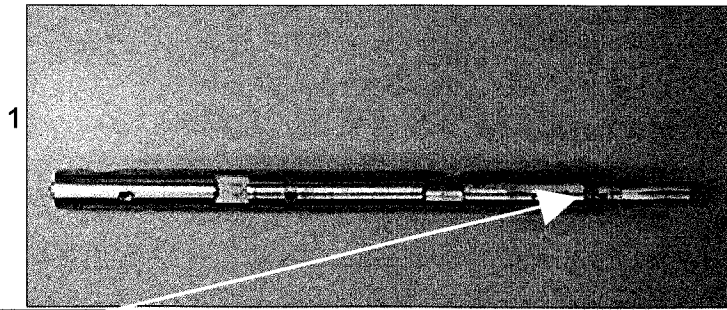

FIG 1. During reassembly the step noted above will be used as a reference point for positioning the shaft left to right.

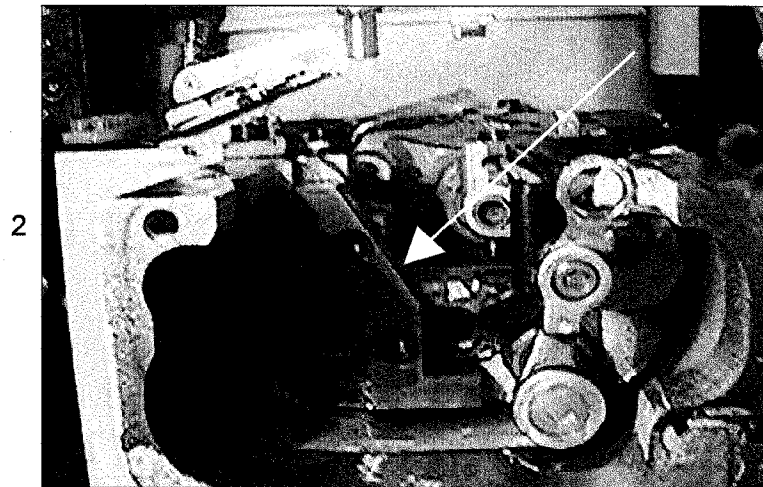

FIG 2. The feed bar guide will be used along with the step on the main shaft for positioning.

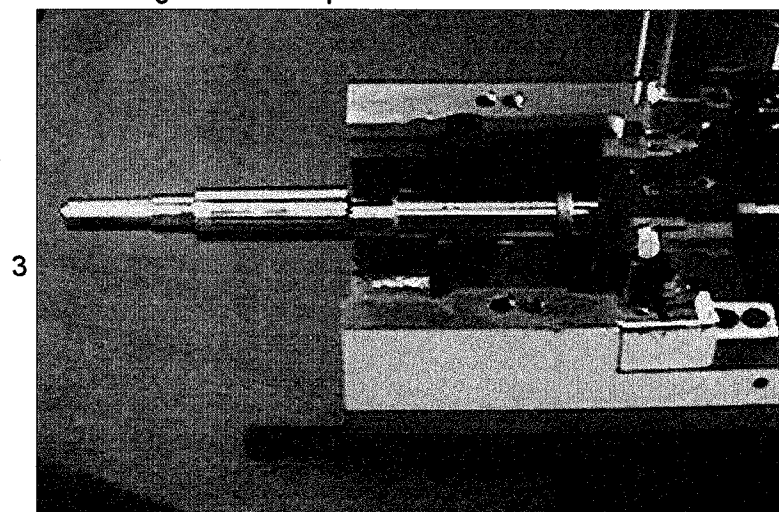

FIG 3. Start the lower left main shaft (34722A) into its bushing in the casting.

4

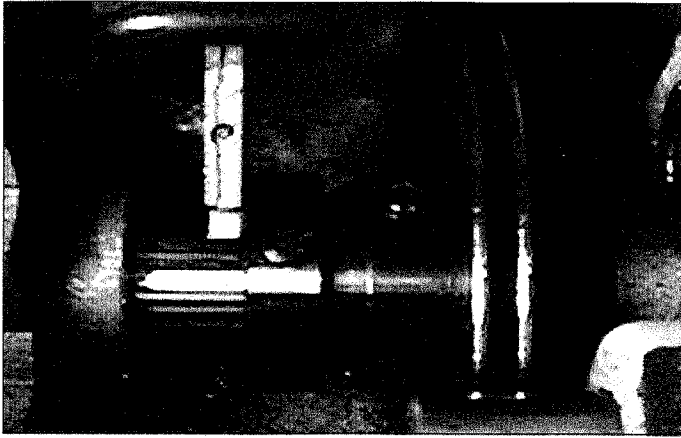

FIG 4. Start onto the shaft the take up cam stop collar (34366) and the new take up cam with the hub of the take up to the left.

5

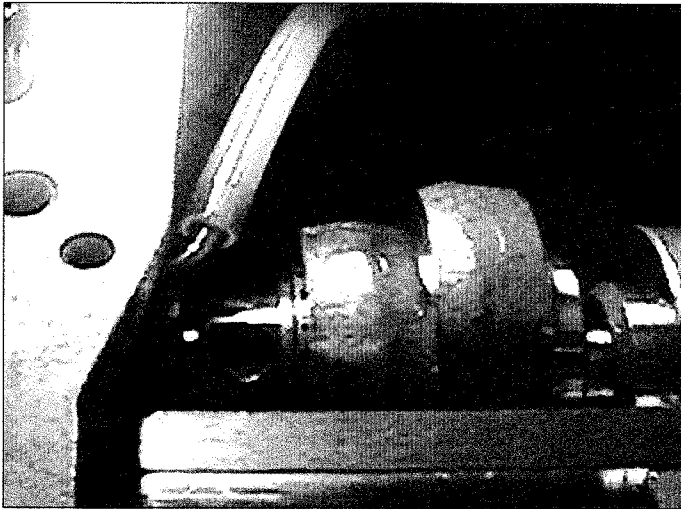

FIG 5. Continue to push the shaft to the right and through the feed drive assembly (G29476BS).

6

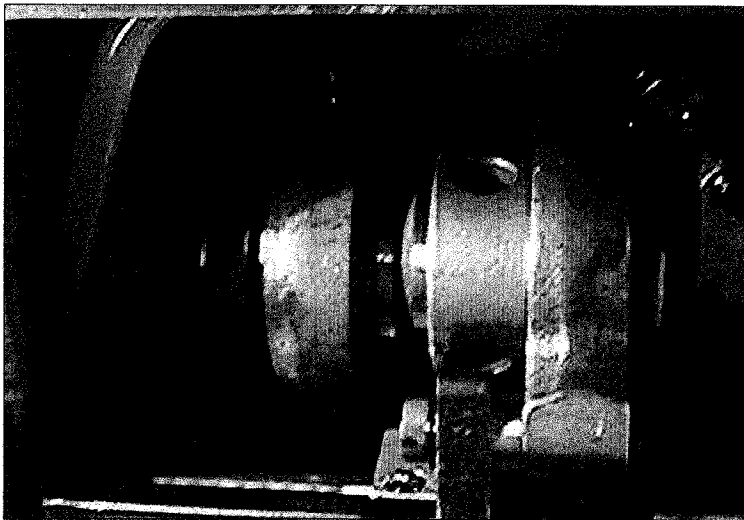

FIG 6. Push the mainshaft into the looper eccentric assembly (VG29105F).

7

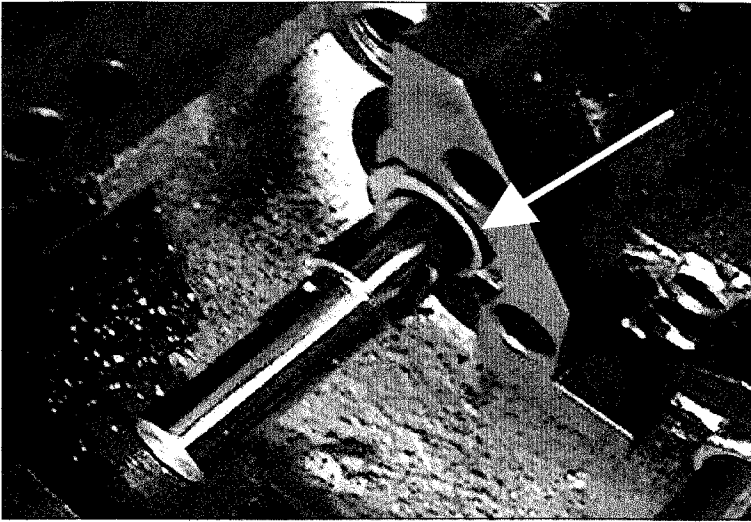
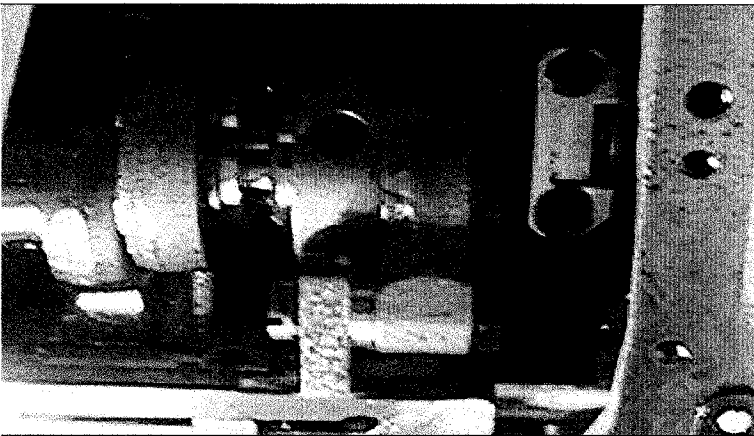
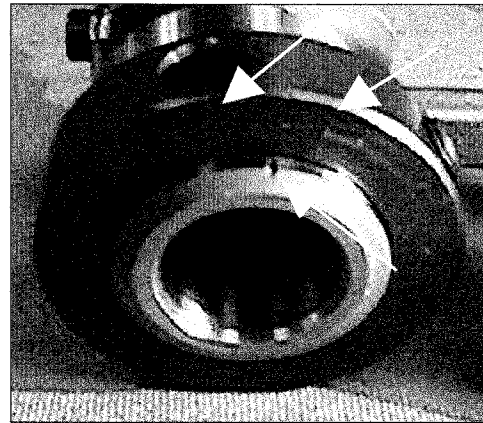

FIG 7. To position the shaft left and right, push it in until the step in the shaft (NOTED BACK IN STEP 1) seats .003" to .005" inside the feed bar guide. If the shaft is too far to the right the flats on the shaft may not align properly with their correct screw holes. If the shaft is too far to the left the feed bar will not seat against the feed bar guide causing the feed bar to be at an improper angle.



8a



8b

FIG 8a. Secure the first screw in operating direction (COUNTER CLOCKWISE) in the drive lever crank (G29105F) to the flat on the mainshaft. Then secure the second screw.

FIG 8b. Located on the looper avoid eccentric are two lines .
Located on the drive lever crank is one line. (AS NOTED ABOVE)
Turn the avoid eccentric until the line on the drive lever crank is approximately 3 mm before the right line on the avoid eccentric. Secure the screw.
NOTE: this is a good starting point for the looper avoid motion final adjustment will be made later.

9

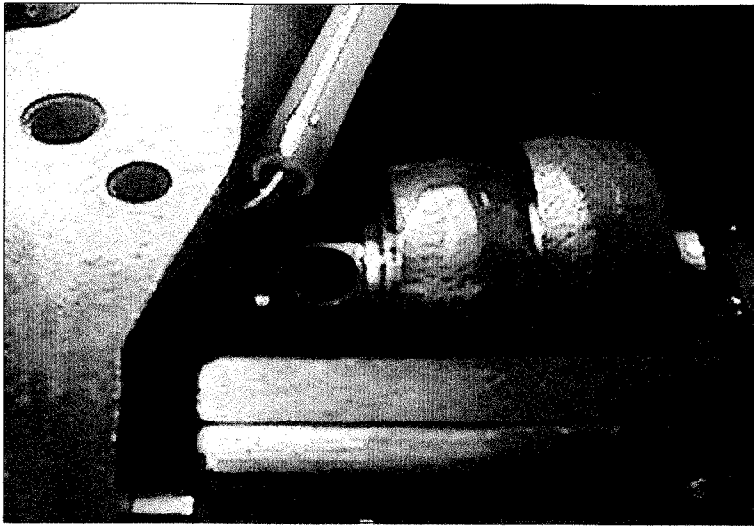

FIG 9. Turn the feed drive eccentric until the first screw in operating direction lines up with the flat on the shaft and secure the screw. Then secure the second screw.

10

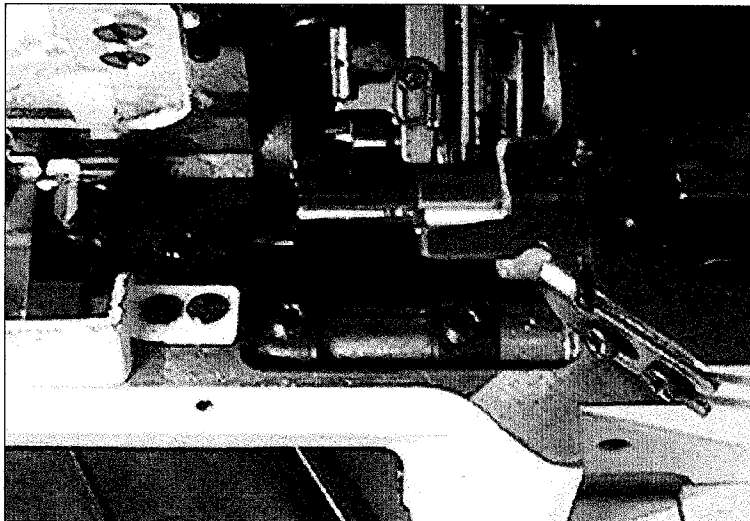

FIG 10. Center the take up cam (34323) within the cast off plate and secure its two screws.

11



FIG 11. Push the stop collar (34366) to the right against the take up cam and secure its screw.

12

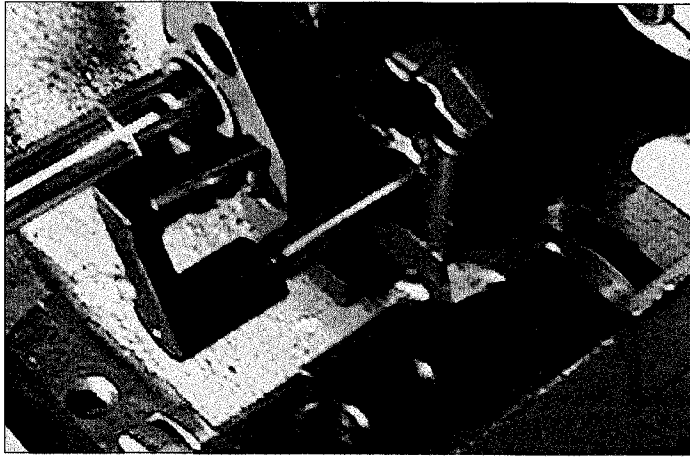

FIG 12. Start the new rear needle guard holder (50325 AA) through its bushing in the casting.

13

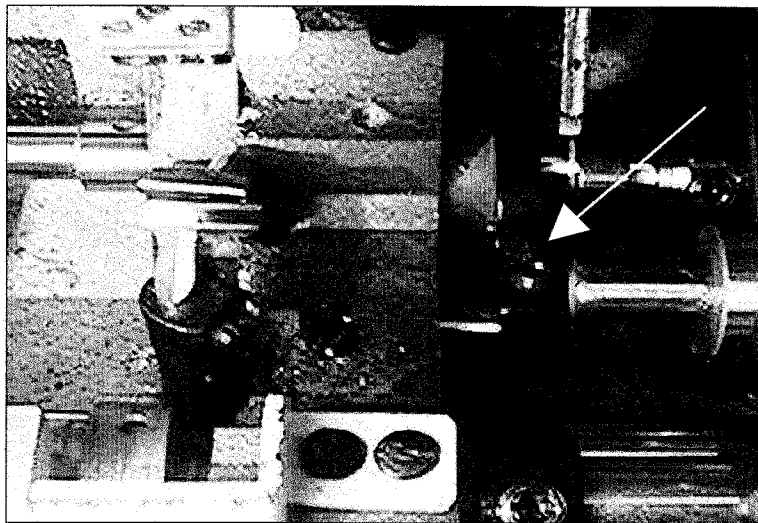

FIG 13. Start the rear needle guard into the fork (34368) insuring the fork positioned on the lower left mainshaft. Push the needle guard holder to the right and the fork to the left so that there is no left and right play in the needle guard holder. Secure the screw in the fork.

Rotate the handwheel to insure the holder doesn't hit the front guard holder within its travel.

14

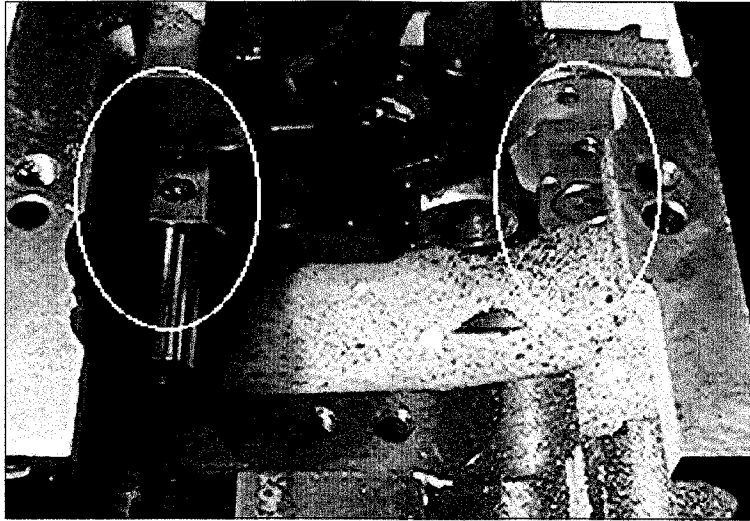

FIG 14. Install the slide block onto the lower left mainshaft making sure the oil hole is up.

Install the feed lift slide block on the end of the feed lift shaft making sure the oil hole is up.

15

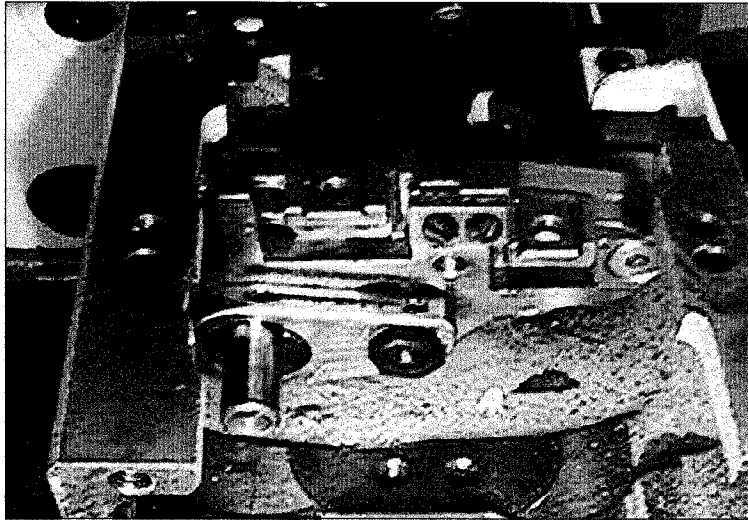

FIG 15. Install the feed bar assembly (G29476BV) onto the slide blocks making sure the slide blocks oil holes are still facing up. When installing the feed bar assembly also make sure the drive connection (34336N) encircles the main shaft.

NOTE: care should be taken during this installation not to burr or scratch the slide blocks.

16

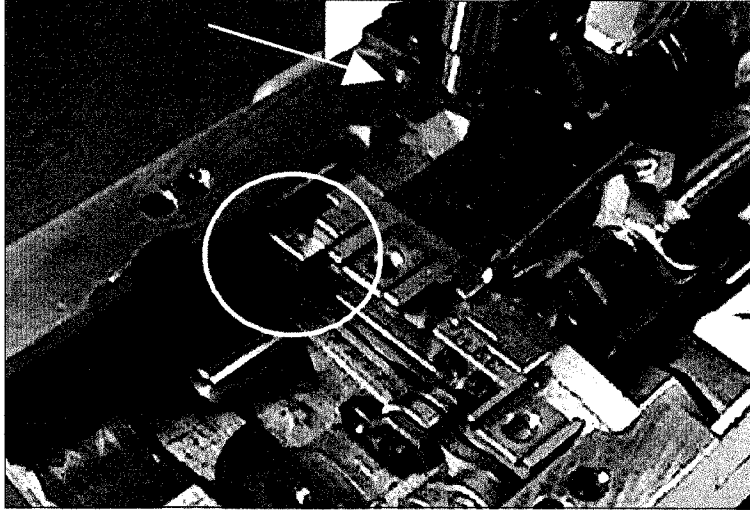

FIG 16. Install the guide stud (34335D) into its hole in the casting. Push the guide stud in until the feed bar is held securely against the feed bar guide (34335H). Secure the screw in the casting.

17

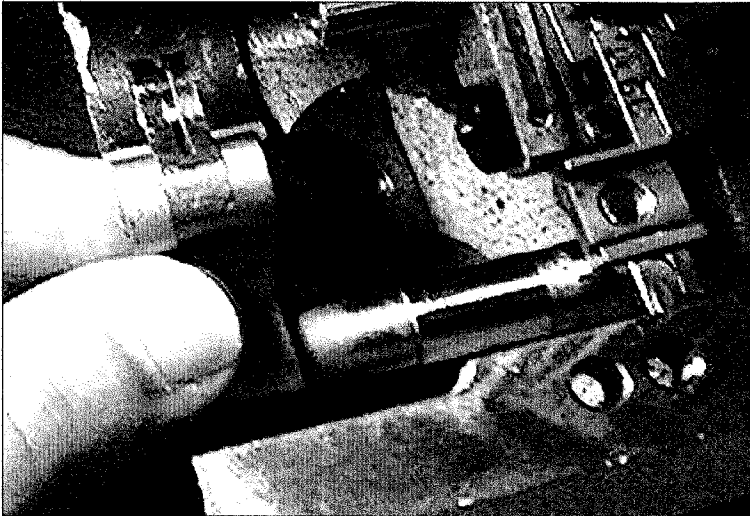

FIG 17. Start the feed drive shaft (34334A) with the feed drive link attached into its bushing.

18

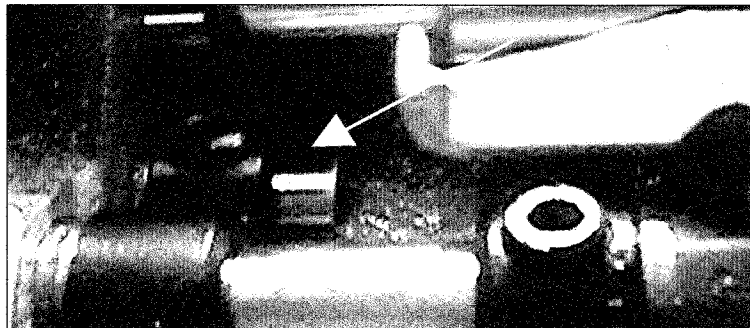

FIG 18. Continue to push the feed drive shaft through its bushing and assemble onto the shaft its thrust collar (34335J). Making sure the faced surface of the collar faces to the left.

19

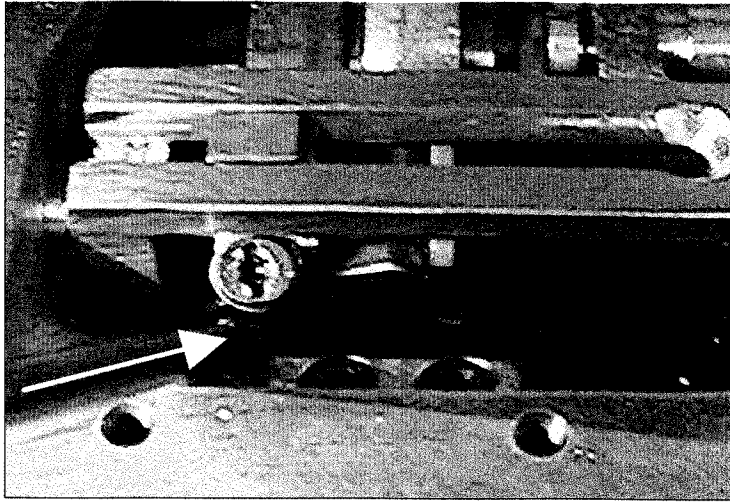

FIG 19. Continue pushing the thrust collar through its next bushing and into the differential feed lever.

20

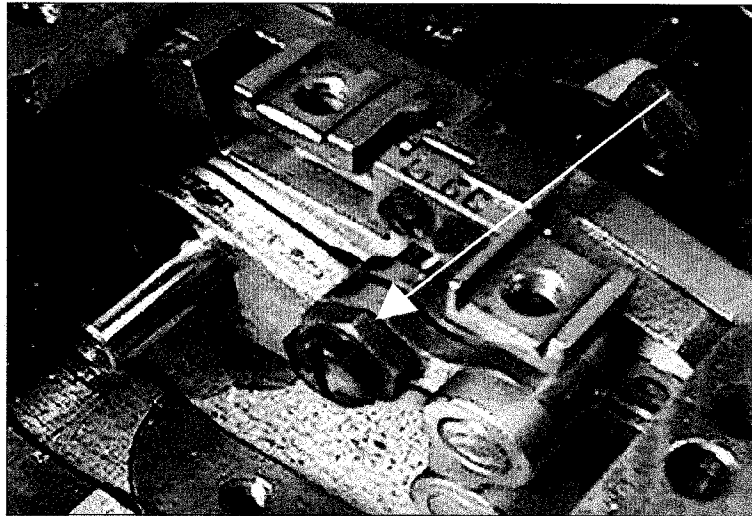

FIG 20. Install the eccentric bushing (34337F) with its screw through the drive link (34336A) and secure the screw to its hole in the feed bar assembly.

NOTE: If the feed drive shaft is not in all the way, the feed bar will not be square.

21

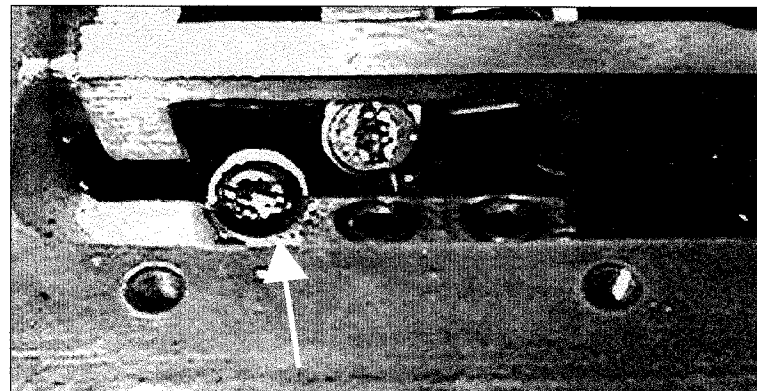

FIG 21. Secure the screw in the feed drive lever stud.

22

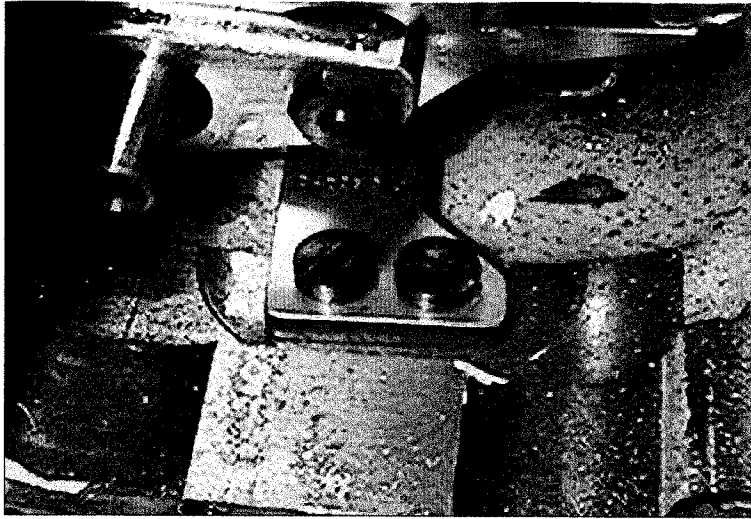

FIG 22. Assemble to the casting the lower feed bar guide (34335G) with its gasket and two screws. Gently thrust the guide up to the feed bar and snug the screws. Now rotate the hand wheel several revolutions to insure no binds in the feed bar and secure the screws. Use Three Bond TB1212 or equivalent on the two screws (CE65).

23

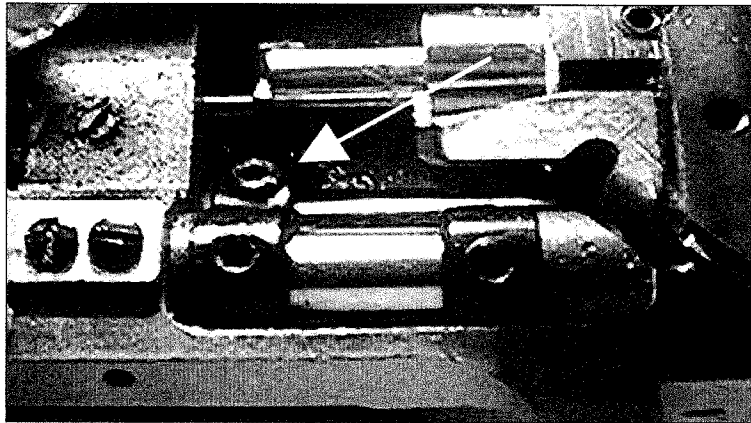

FIG 23. Thrust the stop collar (34335J) to the left, against the bushing. Secure the screw.

24

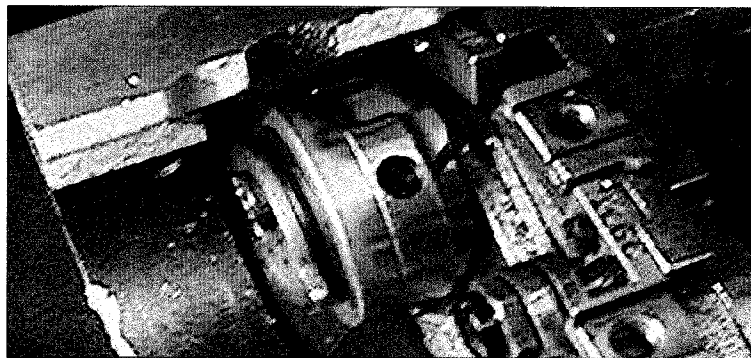
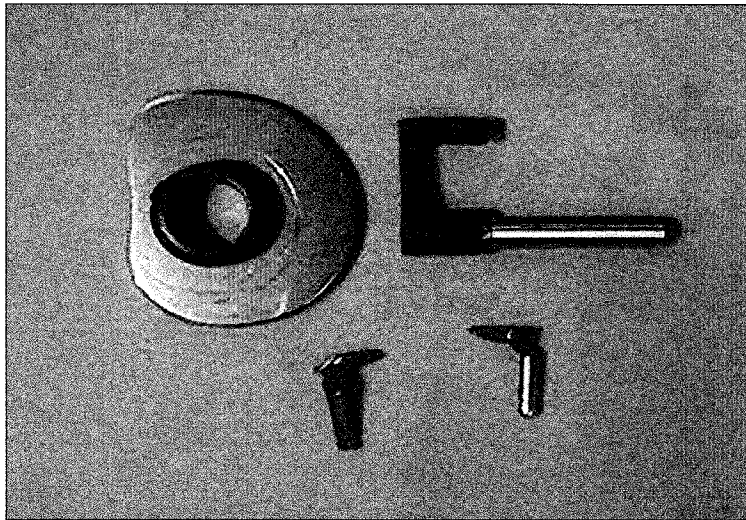

FIG 24. Assemble to the lower main shaft the feed eccentric assembly (GA29477AP) making sure the hub on the assembly goes through the drive connection (34336N). Push the eccentric all the way to the right and secure the first screw in operating direction to the flat on the shaft, then secure the second screw. When reassembling 50382FV, apply TB1104 or equivalent (CE62) to the gasket.

Adjustments And New Parts FOR UPGRADE



1

1. Remove (34323C) looper cam, (50325AA) rear needle guard holder, (50325AC) rear needle guard, and (50325Z) front needle guard.

Replace with new (50323S) looper cam, (50325AM) rear needle guard holder, (50325AN) rear needle guard, and (50325AL) front needle guard.

NOTE: Adjusting steps 4, 8, &10 are to be used only when sewing with difficult or poor quality thread. Refer to engineer's manual # EN9424 for standard adjustments.

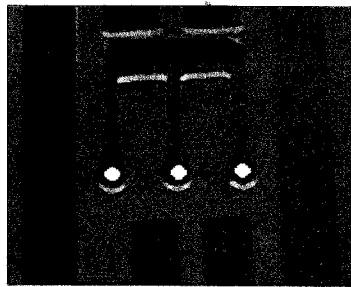

2

2. Align the needle head so it is square to the line of feed. All needles should clear the front of the throat plate needle holes equally.

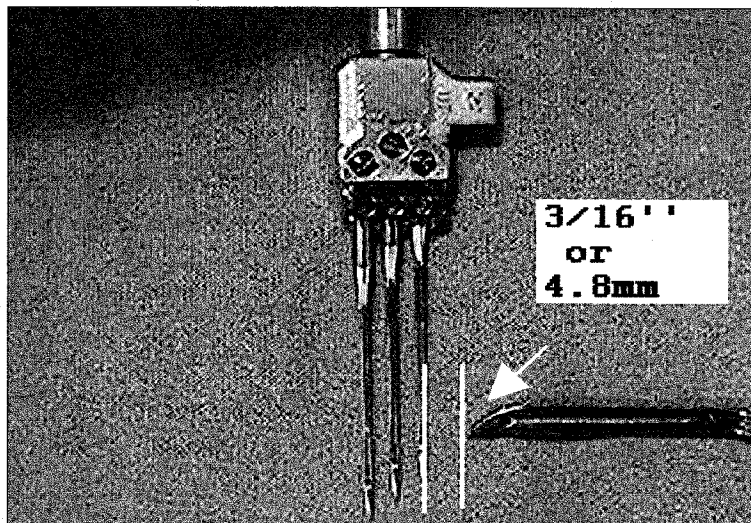

3

3. With the looper at its far right position, set the looper guage to be 3/16" (4.8mm).

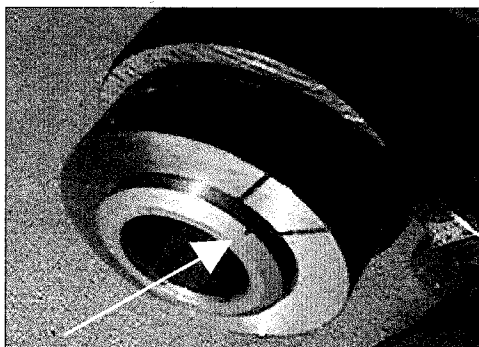

4

4. Adjust the looper motion eccentric so the eccentric line is centered between the two adjusting lines.

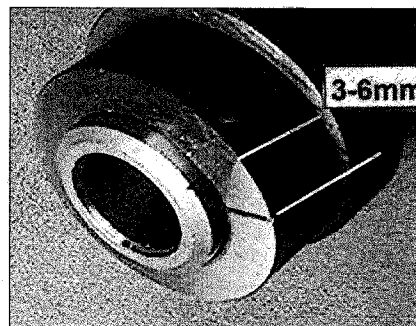

4A

4A. If the eccentric in your machine only has one adjusting line on the eccentric set the eccentric line (3-6mm.) to the rear of the adjusting line.

Note: the 3-6mm. measurement must be taken from the top of the eccentric.

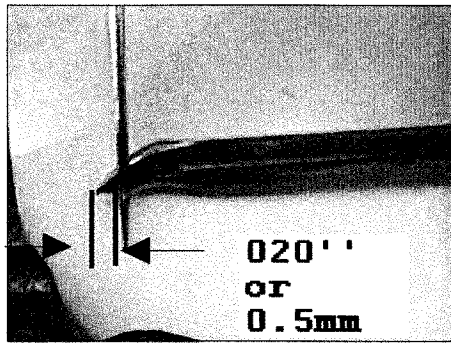

5

5. The needle bar height should be set so the looper point is .020" past the left needle when the bottom of the looper is even with the top of the needle eye.

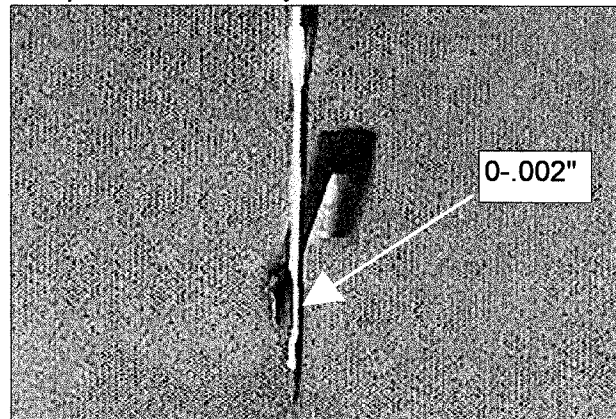

6

6. Remove all needles except the left. Adjust the looper holder so the tip of the looper is 0 -.002" away from the scarf of the left needle.

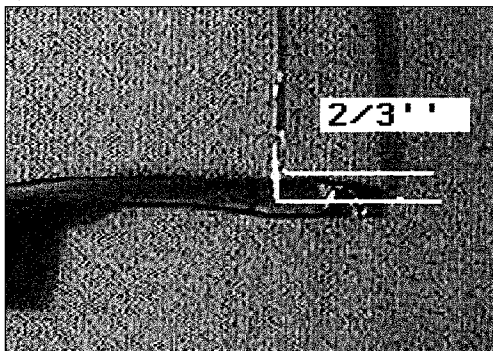

7

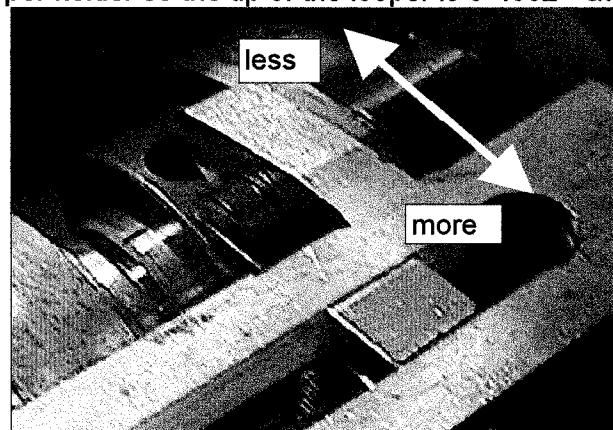

7a

7. set the avoid motion so the left needle touches the back of the looper 2/3" of the way down on the down stroke.

7a. to adjust the avoid motion loosen the screw and nut in the looper cam guide, then move the screw back for less avoid and forward for more avoid.

NOTE: everytime the screw is moved looper front to back must be reset (step 6).

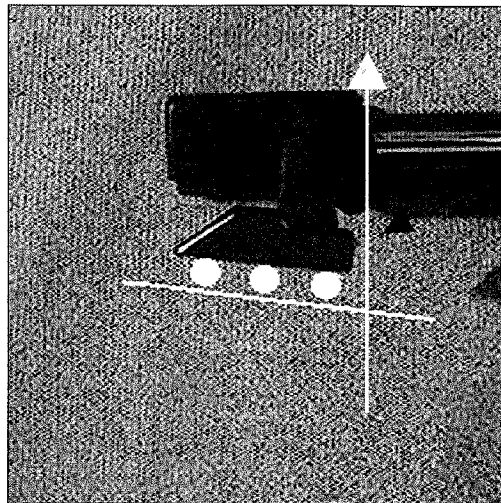

Line of feed

8

8. Adjust the rear guard so when the looper reaches the right needle, there is 0-.002" between the needle and the looper point. Use the rear guard to push the right and middle needle forward slightly. The rear guard should touch but not deflect the left needle.

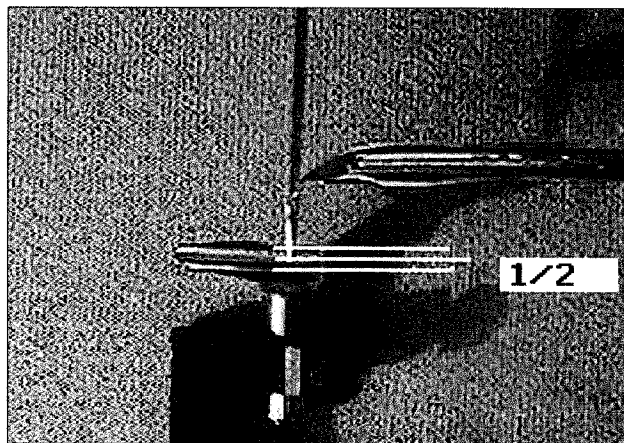

9

9. The right needle point should be halfway up the guarding surface when the looper point is even with the right side of the right needle.

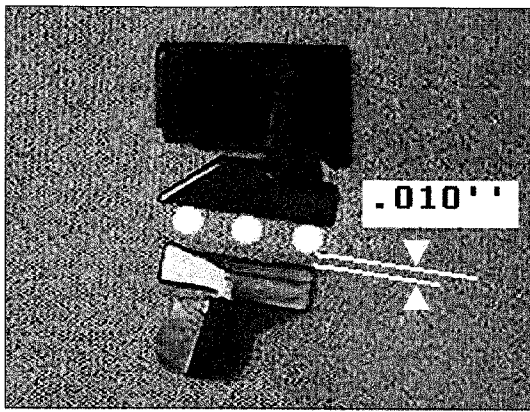

10

10. Set the front needle guard to be parallel to the needles. The guard should have .010" or .25mm clearance to all needles.

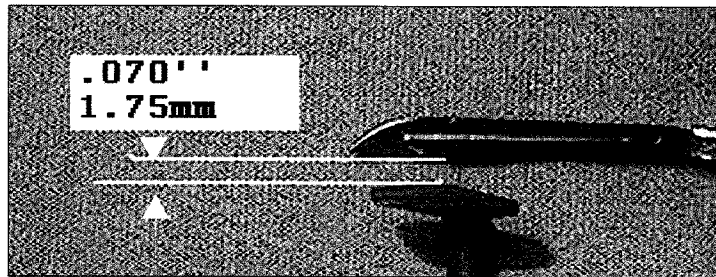

11

11. There should be a clearance of .070" or 1.75mm between the top of the front needle guard and the bottom of the looper blade.

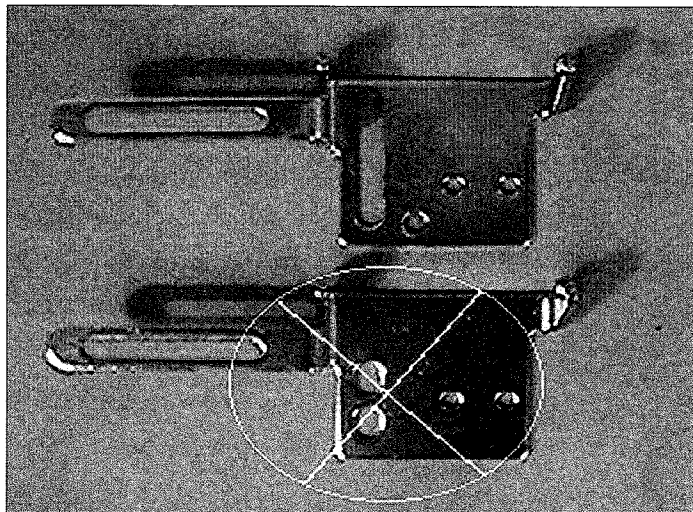

12

12. Remove all the parts from (50392V) bracket and attach to the (50366J) bracket and remount.

Note: Apply Three Bond TB1104 (CE62), to the three screws which secure the cloth plate.

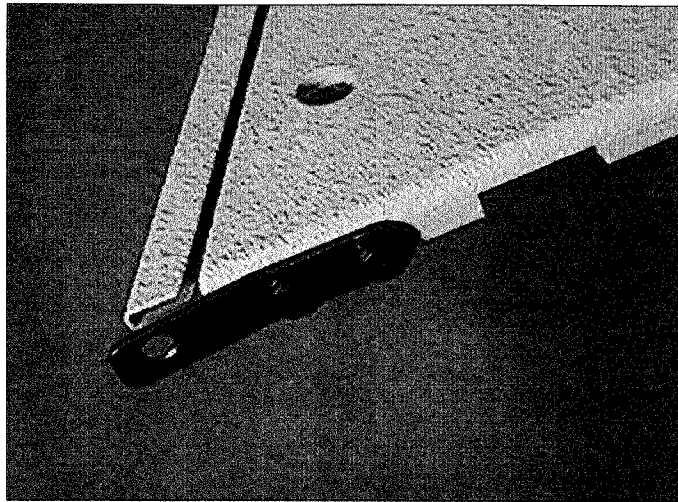

13

13. Attach the new (34358F) looper eyelet to the new (50301CP) cloth plate and install.

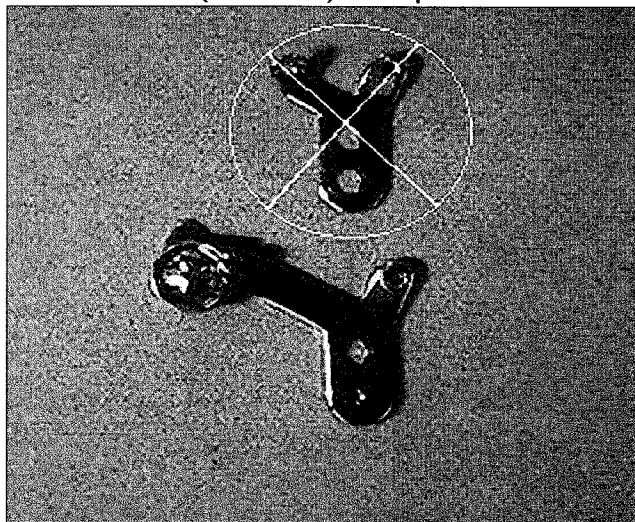

14

14. Remove (50392AG) looper eyelet from oil reservoir cover and replace with (29480AYJ) looper thread nipper assembly.

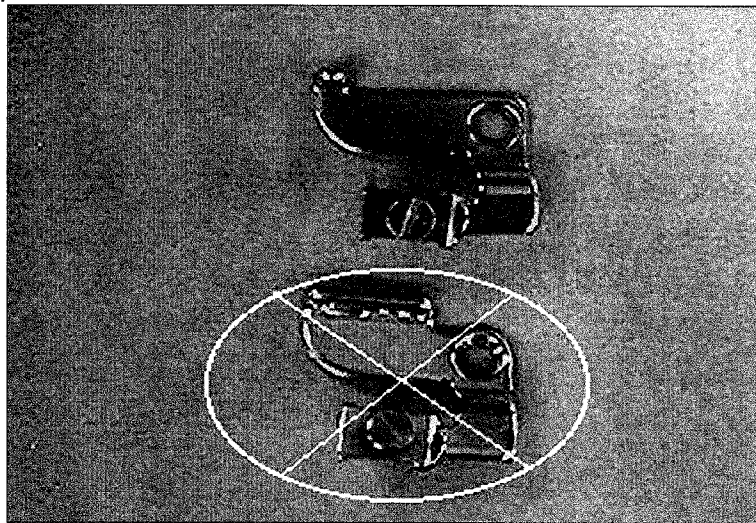

15

15. Remove the (50357AD) nipper plate assembly and replace with (50357AR) needle thread nipper plate assembly.

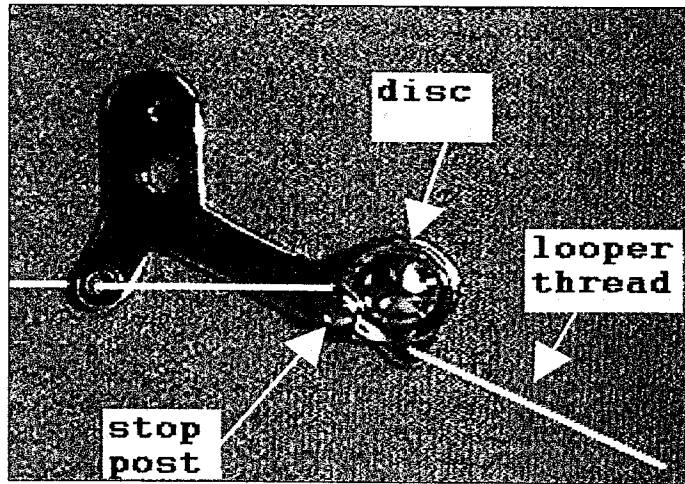

16

16. Thread looper nipper between discs and behind the disc stop post.

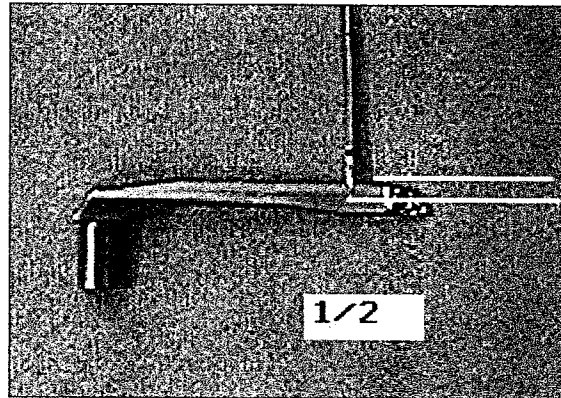

17

17. Set the looper cam to cast-off the looper thread when the left needle tip is halfway down the BACK of the looper.



18

18. Set the adjustable thread guide assembly all the way up in its slot. Then set all three adjustable eyelets all the way down, This will give you the 15mm setting. Set the block all the way to the right.

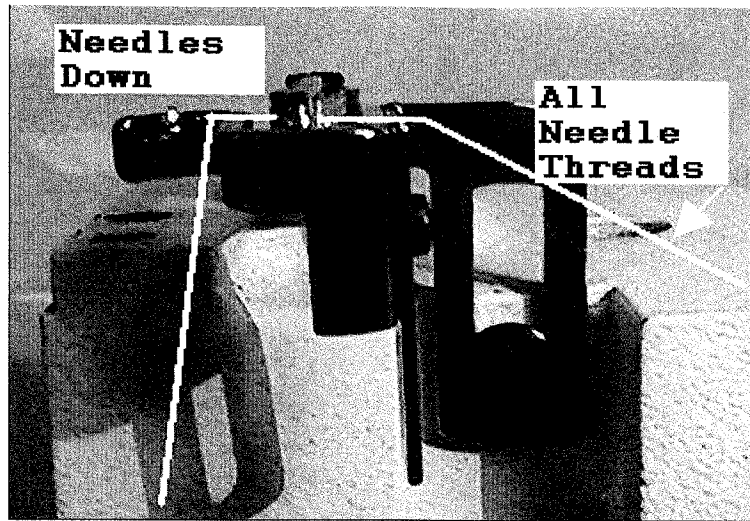

19

19. Set needle thread strike-off wire level with eyelet at bottom of stroke. thread must go over both legs of strike-off wire.



20

**RIGHT NEEDLE
ONLY !**

* No nipper used with
cotton thread.

20. Put the right needle thread in the nipper only. DO NOT use the nipper on any threads when using cotton thread.

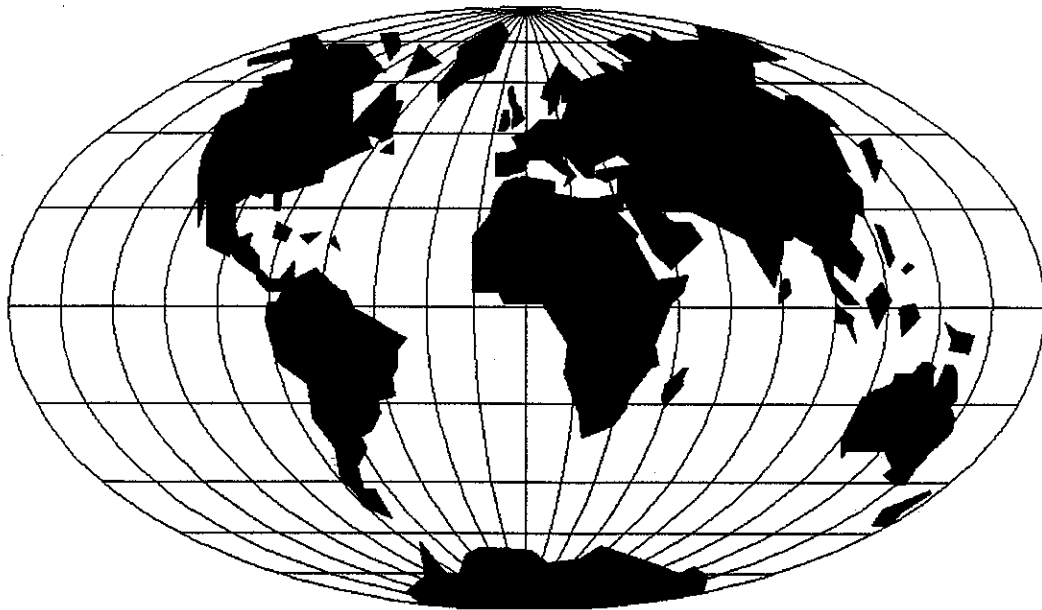

WORLDWIDE SALES AND SERVICE

Union Special Corporation maintains sales and service facilities throughout the world. These offices will aid you in the selection of the right sewing equipment for your particular operation. Union Special Corporation representatives and service technicians are factory trained and are able to serve your needs promptly and efficiently. Whatever your location, there is a qualified representative to serve you.

Brussels, Belgium
Charlotte, N.C.
El Paso, TX
Hong Kong, China
Huntley, IL
Leicester, England
Lille, France
Miami, FL
Milan, Italy
Möglingen, Germany
Montreal, Quebec
Osaka, Japan
Santa Fe Springs, CA

Other Representatives throughout
all parts of the world.



Union Special
INDUSTRIAL SEWING EQUIPMENT