

Form 8788, Revised
December, 1926
PRINTED IN U. S. A.

LIST OF PARTS



MACHINES

Nos. 55-1 to 55-6, 55-11,
55-12, 55-21 and 55-22

THE SINGER MANUFACTURING COMPANY

COPYRIGHT, U. S. A.,
 1914, 1917, 1920, 1921, 1922, 1923 AND 1926,
 BY THE SINGER MANUFACTURING COMPANY
 ALL RIGHTS RESERVED FOR ALL COUNTRIES

INDEX

	PAGE
ACCESSORIES.....	70
BINDER.....	70
EDGE FOLDERS.....	70
“ GUIDE.....	71
FINGER GUARD.....	71
FOOT LIFTER.....	77
GUIDE.....	72
HEMMERS.....	71
IRON BASE.....	69
KNEE LIFTER PARTS.....	78
LAP SEAM FELLER PARTS.....	72
MACHINE NO. 55-1.....	7
“ “ 55-2.....	13
“ “ 55-3.....	20
“ “ 55-4.....	27
“ “ 55-5.....	34
“ “ 55-6.....	40
“ “ 55-11.....	47
“ “ 55-12.....	52
“ “ 55-21.....	59
“ “ 55-22.....	64
NUMERICAL LIST OF PARTS.....	91
OBSOLETE PARTS.....	87
PRESSER FOOT.....	73
STAND NO. 25255.....	79
“ “ 25265.....	80
“ “ 25279.....	81
“ “ 25284.....	82
STAY GUIDE.....	74
STRIP FOLDER.....	74
TAPE GUIDE.....	75
“ HOLDER NO. 26065.....	76
“ “ “ 26074.....	76
THREAD UNWINDER NO. 225394.....	84
“ “ “ 225396.....	84
“ “ “ 225398.....	85
UNDER DRIVER.....	85

INSTRUCTIONS FOR ORDERING

In ordering from this list, use ONLY the part NUMBER in the FIRST column.

The number stamped on a Sewing Machine part is in every case the number of the single part only.

Every combination of parts sent out as such has its specific number, which, although not stamped on the parts, must be used when ordering the combination.

Each number always indicates the SAME PART in whatever list it appears, or for whatever machine.

The letters after some of the numbers indicate the style of finish only, as follows:

- A. Hardened, Polished and Plated.
- B. Polished and Plated.
- C. Hardened only.
- D. Polished only.
- E. Soft, not Polished.
- F. Hardened and Polished.
- G.
- H. Blued.
- J. Plated only.
- K. Hardened and Plated.
- L. Brass or Gilt.
- M. Oxidized.
- P. Japanned.
- R. Merlized
- T. Copper-plated.

These letters MUST BE USED when they appear in the list, and AFTER the number as in the list.

In this series:

- 1 to 1500 and 50001 to 51500 are Screw Numbers.
- 1501 to 1800 are Nut Numbers.
- 1801 to 2000 are Roller Numbers.
- 2001 to 50000 and 52001 and upward are numbers of Machine Parts.

The figures in the second column refer only to the plates, illustrating the parts, and are NOT TO BE USED in ordering.

Parts marked with an asterisk (*) are furnished only when repairs are made at factory.

LIST OF PARTS COMPLETE

FOR

MACHINE No. 55-1

FOR LIGHT FABRICS, ONE NEEDLE, ONE LOOPER.
DROP FEED

NO.	PLATE	NAME
*18001	---	Arm with 11104.....
8582	5161	" Dowel Pin.....
12453	5161	" Oil Tube, for intermediate bearing...
12454	5161	" " " with 29599, for oiling 5570
29599	5161	" " " Packing (felt).....
748E	5163	" Screw (back).....
854E	5163	" " (front).....
18002	5151	" Shaft.....
*11104	---	" " Bushing (front).....
12357	5154	" " Flanged Bushing (back).....
448C	5163	" " " " Set Screw...
144D	5163	" " Screw.....
12480	5153	" Side Cap.....
219D	5163	" " " Screw.....
12193	5153	" " Cover.....
286D	5163	" " " Thumb Screw.....
12358	5150	Balance Wheel (power) light rim, 2 3/8 in. pulley, with two 448c.....
4370	5150	Balance Wheel (stand) heavy rim, 2 3/4 in. pulley, with two 448c.....
2135	5150	Balance Wheel (stand) heavy rim, 2 1/2 in. pulley, for 3022.....
2862	5150	Balance Wheel (stand) heavy rim, 3 in. pulley, for 3022.....
448c	5163	Balance Wheel Set Screw.....
*18003	---	Bed.....
18042	---	" Slide (left).....
4307	5153	" " " Spring.....
240D	5157	" " " " Screw.....
18043	5153	Bed Slide (left) complete, Nos. 4307, 18042 and two 240D.....
18110	5154	Bed Slide (right) with 7393.....
18041	5160	" " " Spring.....
23227	5160	" " " " Rivet.....
7393	5160	" " " Stop Pin.....
256J	5154	Clamp Stop Motion Clamp Screw.....
248A	5163	" " " " Stop Screw.....

PARTS FOR MACHINE No. 55-1

NO.	PLATE	NAME
2020	5154	Clamp Stop Motion Clamp Washer.....
*3023	—	“ “ “ Flanged Bushing.....
4933	5154	“ “ “ “ “ 3023 with two 462c.....
2022	5161	Clamp Stop Motion Flanged Bushing Pin
462c	5155	“ “ “ “ “ Set Screw.....
3022	—	Clamp Stop Motion complete, Nos. 248A, 256J, 2020 and 4933.....
20197	5152	Crank Connecting Rod with 20198 and two 896E.....
*20198	—	Crank Connecting Rod Cap.....
896E	5163	“ “ “ “ Screw.....
908c	5163	“ “ “ Hinge Screw.....
1619E	5164	“ “ “ “ Nut
18051	—	Face Plate.....
18004	5153	Face Plate complete, Nos. 18027, 18051, 18056 and two 578E.....
190D	5171	Face Plate Screw.....
18027	5161	“ “ Thread Guard (lower) with 12152.....
12152	5161	Face Plate Thread Guard (lower) Rivet...
18056	5161	“ “ “ “ (upper, adjust- able).....
578E	5161	Face Plate Thread Guard (upper) Screw...
286D	5163	“ “ Thumb Screw.....
18005	5152	Feed Bar.....
313c	5163	“ “ Screw Centre.....
1519E	5164	“ “ “ “ Nut.....
3033	5155	“ Connecting Link.....
375c	5155	“ “ “ Hinge Screw.....
1518E	5155	“ “ “ “ “ Nut...
18112	5183	“ Dog, for shirt work.....
18253	5183	“ “ “ general work.....
18260	5185	“ “ “ silk mitt work.....
172c	5163	“ “ Screw.....
5570	5152	“ Eccentric with 446c.....
446c	5163	“ “ Set Screw.....
12429	5152	“ Forked Connection.....
375c	5155	“ “ “ Hinge Screw...
1518E	5155	“ “ “ “ “ Nut
18007	5155	“ Lifting Eccentric with two 624c.....
18008	—	“ “ “ 18007 with 457c and 18037.....
624c	5155	Feed Lifting Eccentric Set Screw.....
3039	5155	“ Regulator.....
58E	5155	“ “ Hinge Screw.....

PARTS FOR MACHINE No. 55-1

NO.	PLATE	NAME
818D	5155	Feed Regulator Thumb Screw.....
18009	5151	“ Rock Shaft.....
3043	5155	“ “ “ Crank with 462c.....
2049	5155	“ “ “ “ Pin.....
462c	5155	“ “ “ “ Set Screw.....
307c	5163	“ “ “ Screw Centre.....
1513J	5164	“ “ “ “ Nut.....
18010	—	Feed Rock Shaft complete, Nos. 3043 and 18009.....
18096	5153	Folder Holder Seat Cover.....
207F	5157	“ “ “ “ Screw.....
18066	5158	Looper with 1076c.....
1076c	5158	“ Set Screw.....
18067	5151	“ Shaft.....
19496	—	“ “ Crank.....
19447	5155	Looper Shaft Crank complete, Nos. 457c, 1518E, 19449 and 19496.....
2049	5155	Looper Shaft Crank Pin.....
457c	5164	“ “ “ Set Screw.....
19448	5155	“ “ “ Slide Block.....
226D	5211	“ “ “ “ Cap Screw
12424	5155	“ “ “ “ “ “ “ Washer.....
988c	5155	Looper Shaft Crank Slide Block Screw Stud.....
1518E	5155	Looper Shaft Crank Slide Block Screw Stud Nut.....
19449	—	Looper Shaft Crank Slide Block complete, Nos. 226D, 988c, 12424 and 19448.....
18098	5152	Needle Bar (hollow).....
18060	5156	“ “ Connecting Link.....
372c	5156	“ “ “ “ Hinge Screw
1518E	5155	“ “ “ “ “ “ “ Nut.....
*12383	—	Needle Bar Connecting Stud.....
12384	5156	Needle Bar Connecting Stud complete, Nos. 453c, 1904 and 12383.....
1904	5156	Needle Bar Connecting Stud Roller (roller only).....
453c	5156	Needle Bar Connecting Stud Set Screw...
18226	5152	“ “ Crank with 453c and 1065c...
1065c	5163	“ “ “ Position Screw.....
453c	5156	“ “ “ Set Screw.....
936D	5163	“ “ Screw Bushing.....
18099	—	“ Clamp Body with 209E.....
2273	5156	“ “ Pin.....
18069	5156	“ “ Thread Nipper.....

NO.	PLATE	NAME
18113	5183	Throat Plate for 18112.....
18254	5183	" " " 18253.....
18261	5185	" " small needle hole, for 18260
691F	5163	" " Screw.....
44212	7711	Drip Pan with four 1 in. wire nails.....

LIST OF PARTS COMPLETE

FOR

MACHINE No. 55-2

DROP FEED, TWO NEEDLES, TWO LOOPERS. FOR LIGHT FABRICS. GAUGE NOT NARROWER THAN $\frac{3}{32}$ INCH

NO.	PLATE	NAME
*18001	---	Arm with 11104.....
8582	5161	" Dowel Pin.....
12453	5161	" Oil Tube, for intermediate bearing...
12454	5161	" " " with 29599, for oiling 5570
29599	5161	" " " Packing (felt).....
748E	5163	" Screw (back).....
854E	5163	" " (front).....
18002	5151	" Shaft.....
*11104	---	" " Bushing (front).....
12357	5154	" " Flanged Bushing (back).....
448c	5163	" " " " Set Screw...
144d	5163	" " Screw.....
12480	5153	" Side Cap.....
219d	5163	" " " Screw.....
12193	5153	" " Cover.....
286d	5163	" " " Thumb Screw.....
12358	5150	Balance Wheel (power) light rim, $2\frac{3}{16}$ in. pulley, with two 448c.....
4370	5150	Balance Wheel (stand) heavy rim, $2\frac{3}{4}$ in. pulley, with two 448c.....
2135	5150	Balance Wheel (stand) heavy rim, $2\frac{1}{2}$ in. pulley, for 3022.....
2862	5150	Balance Wheel (stand) heavy rim, 3 in. pulley, for 3022.....
448c	5163	Balance Wheel Set Screw.....
*18003	---	Bed.....
18042	---	" Slide (left) for 18043.....
18236	---	" " " " 18237.....
4307	5153	" " " Spring.....
240d	5157	" " " " Screw.....
18043	5153	Bed Slide (left) complete, Nos. 4307, 18042 and two 240d.....
18237	5154	Bed Slide (left) $\frac{15}{16}$ in. long, for $\frac{9}{16}$ in. to $1\frac{1}{4}$ in. gauges, complete, Nos. 4307, 18236 and two 240d.....
18110	5154	Bed Slide (right) with 7393.....
18041	5160	" " " Spring.....

NO.	PLATE	NAME
23227	5160	Bed Slide (right) Spring Rivet.....
7393	5160	" " " Stop Pin.....
256J	5154	Clamp Stop Motion Clamp Screw.....
248A	5163	" " " " Stop Screw..
2020	5154	" " " " Washer.....
*3023	—	" " " Flanged Bushing.....
4933	5154	" " " " " 3023 with two 462c.....
2022	5161	Clamp Stop Motion Flanged Bushing Pin
462c	5155	" " " " " Set Screw.....
3022	—	Clamp Stop Motion complete, Nos. 248A, 256J, 2020 and 4933.....
20197	5152	Crank Connecting Rod with 20198 and two 896E.....
*20198	—	Crank Connecting Rod Cap.....
896E	5163	" " " " Screw.....
908c	5163	" " " Hinge Screw.....
1619E	5164	" " " " " Nut..
18051	—	Face Plate for 18004.....
18238	—	" " " 18239.....
18004	5153	Face Plate complete, Nos. 18027, 18051, 18056 and two 578E.....
18239	5153	Face Plate complete for 35658, Nos. 18027, 18056, 18238 and two 578E.....
190D	5171	Face Plate Screw.....
18027	5161	" " Thread Guard (lower) with 12152.....
12152	5161	Face Plate Thread Guard (lower) Rivet..
18056	5161	" " " " (upper, adjust- able).....
578E	5161	Face Plate Thread Guard (upper) Screw..
286D	5163	" " Thumb Screw.....
18005	5152	Feed Bar.....
313c	5163	" " Screw Centre.....
1519E	5164	" " " " Nut.....
3033	5155	" Connecting Link.....
375c	5155	" " " Hinge Screw.....
1518E	5155	" " " " " Nut..
18078	5191	" Dog, for $\frac{5}{32}$ in. to $\frac{1}{2}$ in. gauges, for banding trousers.....
18205	5197	Feed Dog, for $\frac{1}{4}$ in. to $\frac{1}{2}$ in. gauges.....
18198	5198	" " " $\frac{1}{2}$ in. to $\frac{3}{4}$ in. gauges, for general work.....
18248	5197	Feed Dog (spiked teeth) for $\frac{1}{4}$ in. to $\frac{1}{2}$ in. gauges.....
18243	5199	Feed Dog, for $\frac{1}{8}$ in. to $1\frac{1}{4}$ in. gauges.....

NO.	PLATE	NAME
18295	5239	Feed Dog, for $\frac{3}{32}$ in. to $1\frac{3}{8}$ in. gauges, for general work.....
18271	5199	Feed Dog (spiked teeth) for $\frac{1}{8}$ in. to $1\frac{1}{4}$ in. gauges.....
18258	5202	Feed Dog, for $\frac{1}{4}$ in. to $1\frac{1}{4}$ in. gauges, for banding knit underwear, for 35620.....
18246	5201	Feed Dog, for $1\frac{1}{4}$ in. to $1\frac{1}{2}$ in. gauges....
172c	5163	" " Screw.....
5570	5152	" Eccentric with 446c.....
446c	5163	" " Set Screw.....
12429	5152	" Forked Connection.....
375c	5155	" " " Hinge Screw....
1518E	5155	" " " " " Nut
18007	5155	" Lifting Eccentric with two 624c.....
18008	—	" " " 18007 with 457c and 18037.....
624c	5155	Feed Lifting Eccentric Set Screw.....
3039	5155	" Regulator.....
58E	5155	" " Hinge Screw.....
818D	5155	" " Thumb Screw.....
18009	5151	" Rock Shaft.....
3043	5155	" " " Crank with 462c.....
2049	5155	" " " " Pin.....
462c	5155	" " " " Set Screw.....
307c	5163	" " " Screw Centre.....
1513J	5164	" " " " " Nut.....
18010	—	Feed Rock Shaft complete, Nos. 3043 and 18009.....
18096	5153	Folder Holder Seat Cover.....
207F	5157	" " " " Screw.....
18202	5159	Looper (inside) with 1076c, for $\frac{5}{32}$ in. to $\frac{3}{16}$ in. gauges, for 18204.....
18203	5159	Looper (outside) with 1076c, for $\frac{5}{32}$ in. to $\frac{3}{16}$ in. gauges, for 18204.....
18204	—	Loopers, for $\frac{5}{32}$ in. to $\frac{3}{16}$ in. gauges, Nos. 198D, 18202 and 18203.....
NOTE: When ordering Nos. 18202, 18203 or 18204, state gauge required.		
18011	5159	Looper (inside) with 1076c, for $\frac{1}{4}$ in. gauge and above.....
18119	5159	Looper (inside) with 1076c, for No. 23 needle, for $\frac{1}{4}$ in. gauge and above.....
18012	5159	Looper (outside) with 1076c, for $\frac{1}{4}$ in. gauge and above.....
18120	5159	Looper (outside) with 1076c, for No. 23 needle, for $\frac{1}{4}$ in. gauge and above.....

NO.	PLATE	NAME
198D	5163	Looper Screw.....
1076C	5158	" Set Screw.....
18235	5151	" Shaft.....
19496	—	" " Crank.....
19447	5155	Looper Shaft Crank complete, Nos. 457C, 1518E, 19449 and 19496.....
2049	5155	Looper Shaft Crank Pin.....
457C	5164	" " " Set Screw.....
19448	5155	" " " Slide Block.....
226D	5211	" " " " " Cap Screw.....
12424	5155	" " " " " " " Washer.....
988C	5155	Looper Shaft Crank Slide Block Screw Stud.....
1518E	5155	" " " " " " " Nut.....
19449	—	Looper Shaft Crank Slide Block complete, Nos. 226D, 988C, 12424 and 19448.....
18098	5152	Needle Bar (hollow).....
18060	5156	" " Connecting Link.....
372C	5156	" " " " " Hinge Screw.....
1518E	5155	" " " " " " " Nut.....
*12383	—	Needle Bar Connecting Stud.....
12384	5156	Needle Bar Connecting Stud complete, Nos. 453C, 1904 and 12383.....
1904	5156	Needle Bar Connecting Stud Roller (roller only).....
453C	5156	Needle Bar Connecting Stud Set Screw.....
18226	5152	" " Crank with 453C and 1065C.....
1065C	5163	" " " Position Screw.....
453C	5156	" " " Set Screw.....
936D	5163	" " Screw Bushing.....
18052	5172	" Clamp Body with two 209F.....

NOTE: When ordering No. 18052, state
gauge required.

2273	5156	Needle Clamp Pin.....
18053	5156	" " Thread Nipper.....

NOTE: When ordering No. 18053, state
gauge required.

924F	5156	Needle Clamp Thread Nipper Screw.....
18054	5156	" " " " Spring.....
18018	5156	Needle Clamp complete, Nos. 924F and 18052 to 18054.....

NOTE: When ordering No. 18018, state
gauge required.

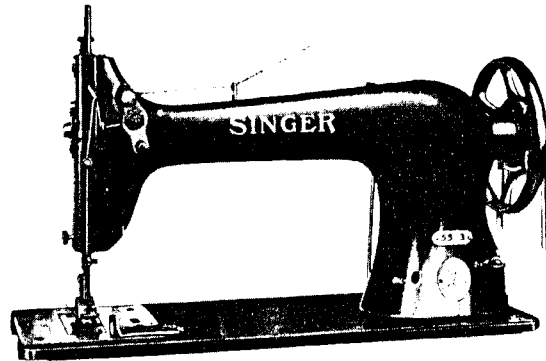
NO.	PLATE	NAME
209F	5156	Needle Set Screw.....
*18162	5152	Oscillating Rock Shaft.....
18163	—	Oscillating Rock Shaft complete, Nos. 4784, 12388 and 18162.....
12388	5152	Oscillating Rock Shaft Hinge Pin.....
878J	5163	" " " " " Oil Hole Stop Screw.....
12459	5161	Oscillating Rock Shaft Hinge Pin Oil Hole Stop Screw Washer (leather).....
448C	5163	Oscillating Rock Shaft Hinge Pin Set Screw.....
4784	5161	Oscillating Rock Shaft Oil Pad.....
12391	5152	Presser Bar (hollow).....
2062	5156	" " Lifter.....
689C	5156	" " " Screw.....
1520E	5156	" " " " Nut.....
20023	5152	" " Spring (heavy).....
11167	5152	" " " (light).....
12139	5152	" " " (medium).....
11168	5156	" " " Bracket with 453C.....
453C	5156	" " " " Set Screw.....
11170	5156	" " " Washer.....
18055	5161	" Foot Hinge Pin.....
18019	—	" " Plate.....
18020	—	" " Shank.....
18021	5213	Presser Foot (hinged) complete, Nos. 18019, 18020 and 18055.....
18055	5161	Presser Foot Hinge Pin.....
18084	—	" " Plate.....
18085	—	" " Shank.....
18086	5213	Presser Foot (tube) hinged, complete, with centre guide, for covering seams with tape, Nos. 18055, 18084 and 18085.....
18079	—	Presser Foot Band Guide.....
18055	5161	" " Hinge Pin.....
18080	—	" " Plate with 18079.....
18081	—	" " Shank.....
14058	5156	" " Spring.....
18082	5213	Presser Foot (spring hinged) complete, Nos. 14058, 18055, 18080 and 18081.....
18055	5161	Presser Foot Hinge Pin.....
18195	—	" " Plate.....
18196	—	" " Shank.....
18197	5214	Presser Foot (tube) hinged, complete, Nos. 18055, 18195 and 18196.....
26276	5160	Presser Foot Hinge Pin.....
18250	—	" " Plate.....

NO.	PLATE	NAME
18251	—	Presser Foot Shank.....
18252	5214	Presser Foot (hinged) complete, for outside stays and strips, Nos. 18250, 18251 and 26276.....
190D	5171	Presser Foot Screw.....
688J	5163	Pressure Regulating Thumb Screw.....
18022	5154	Tension Bracket.....
894F	5161	" " Screw.....
18023	5161	" " " Collar.....
2102	5161	" Disc.....
1560C	5161	" Regulating Thumb Nut.....
637C	5161	" Screw Stud.....
1547D	5161	" " Nut.....
8238	5161	" Spring (looper thread).....
2103	5161	" " (needle thread).....
18024	5154	Thread (arm) Cover.....
405E	5163	" " " Screw (lower).....
207F	5157	" " " " (upper).....
18025	5154	" (bed) Cover.....
14026	5161	" " " Pin.....
691F	5163	" " " Screw.....
18026	—	Thread Cover complete, Nos. 14026, 18024, 18025, 18041 and two each 405E and 23227.....
18028	—	Thread Eyelet (triangular, top of arm)....
18047	5162	" " Stud.....
18046	5154	" " 18028 with 18047.....
18032	5157	" (under) Take-up.....
18035	5157	" " " Crank with 1820, •18036 and two 178c.....
*18036	—	Thread (under) Take-up Crank Cap.....
178c	5157	" " " " " Screw.....
1820	5157	" " " " " Roller and Stud.....
18033	5157	Thread (under) Take-up Lever (forked)...
18057	—	Thread (under) Take-up Lever complete, Nos. 18032, 18033 and two 404D.....
18034	5157	Thread (under) Take-up Lever Hinge Pin.....
624c	5155	" " " " " " " Set Screw.....
404D	5157	Thread (under) Take-up Screw.....
18037	5155	" " " " Thread Guard...
457c	5164	" " " " " " Set Screw.....
18048	5157	Thread (upper) Controller Bracket.....
207F	5157	" " " " " Screw.....
18030	5157	" " " " " Stud..

NO.	PLATE	NAME
175F	5157	Thread (upper) Controller Bracket Stud Set Screw.....
18062	5157	Thread (upper) Controller Spring (inside)
18064	5157	" " " " (outside)
240D	5157	" " " " Screw
18063	—	Thread (upper) Controller complete, Nos. 240D, 18048, 18062 and 18064.....
18038	5157	Thread (upper) Take-up with 453c.....
453c	5156	" " " Set Screw.....
18083	5191	Throat Plate for 18078.....
18245	5199	" " " 18243 and 18271.....
18247	5201	" " " 18246.....
18249	5197	" " " 18205 and 18248.....
18259	5202	" " " 18258.....
18297	5239	" " " 18296.....
691F	5163	" " Screw.....
44212	7711	Drip Pan with four 1 in. wire nails.....

LIST OF PARTS COMPLETE

FOR



MACHINE No. 55-3

FOR STITCHING BAGS WITH TWINE OR VERY COARSE THREAD.
 MAKES STITCH $\frac{5}{32}$ INCH TO $\frac{3}{8}$ INCH LONG. ONE NEEDLE,
 ONE LOOPER. HAS LOOPERS AND THROAT PLATES FOR
 SINGLE AND DOUBLE CHAIN STITCH. DROP FEED.

NO.	PLATE	NAME
*18129	—	Arm with 11104.....
8582	5161	" Dowel Pin.....
12453	5161	" Oil Tube, for intermediate bearing....
12454	5161	" " " with 29599, for oiling 18189
11119	5170	" " " " " " " 18190 and 18231.....
29599	5161	Arm Oil Tube Packing (felt).....
748E	5163	" Screw (back).....
854E	5163	" " (front).....
18131	5151	" Shaft.....
*11104	—	" " Bushing (front).....
12357	5154	" " Flanged Bushing (back).....
448C	5163	" " " " Set Screw....
144D	5163	" " Screw.....
12480	5153	" Side Cap.....
219D	5163	" " " Screw.....

PARTS FOR MACHINE No. 55-3

NO.	PLATE	NAME
12193	5153	Arm Side Cover.....
286D	5163	" " " Thumb Screw.....
4388	5150	Balance Wheel (power) light rim, $2\frac{3}{4}$ in. pulley, with two 448c.....
4370	5150	Balance Wheel (stand) heavy rim, $2\frac{3}{4}$ in. pulley, with two 448c.....
2135	5150	Balance Wheel (stand) heavy rim, $2\frac{1}{2}$ in. pulley, for 3022.....
2862	5150	Balance Wheel (stand) heavy rim, 3 in. pulley, for 3022.....
448C	5163	Balance Wheel Set Screw.....
*20912	—	Bed.....
18133	5172	" Oil Hole Cover.....
1044E	5172	" " " " Hinge Screw.....
256J	5154	Clamp Stop Motion Clamp Screw.....
248A	5163	" " " " Stop Screw....
2020	5154	" " " " Washer.....
*3023	—	" " " " Flanged Bushing....
4933	5154	" " " " " " 3023 with two 462c.....
2022	5161	Clamp Stop Motion Flanged Bushing Pin
462c	5155	" " " " " " Set Screw.....
3022	—	Clamp Stop Motion complete, Nos. 248A, 256J, 2020 and 4933.....
18134	5168	Cloth Plate.....
691F	5163	" " Screw.....
20197	5152	Crank Connecting Rod with 20198 and two 896E.....
*20198	—	Crank Connecting Rod Cap.....
896E	5163	" " " " Screw.....
908C	5163	" " " " Hinge Screw.....
1619E	5164	" " " " " " Nut.
18135	—	Face Plate.....
18136	5167	Face Plate complete, Nos. 66F, 1521E, 18135, 18169, 18170 and two 219F....
190D	5171	Face Plate Screw.....
286D	5163	" " Thumb Screw.....
20913	5240	Feed Bar with 176D.....
176D	5211	" " Adjusting Screw.....
1045C	5169	" " Hinge Screw.....
1518E	5169	" " " " Nut.....
313C	5163	Feed Bar Screw Centre.....
1519E	5164	" " " " Nut.....
18140	5175	" Dog, 17 teeth (12 teeth to the inch)...
18326	5175	" " 23 teeth (16 teeth to the inch)...
18208	5175	" " 12 teeth (8 teeth to the inch)...

NO.	PLATE	NAME
18211	5176	Feed Dog.....
18216	5176	" ".....
18218	5177	" ".....
172c	5163	" " Screw.....
5570	5152	" Eccentric with 446c.....
18141	5167	" " Connecting Rod with 896E, 11136 and two 145E.....
896E	5163	Feed Eccentric Connecting Rod Adjusting Screw.....
*11136	—	Feed Eccentric Connecting Rod Cap.....
145E	5169	" " " " " Screw.....
697c	5169	" " " " Stud.....
389F	5169	" " " " Cap Screw.....
11137	5169	Feed Eccentric Connecting Rod Stud Cap Screw Washer.....
1518E	5169	Feed Eccentric Connecting Rod Stud Nut
2018	5169	" " " " " " " Washer.....
446c	5163	Feed Eccentric Set Screw.....
18142	5169	" Lifting Eccentric with 446c.....
18143	5169	" " " Connection.....
18144	5169	" " " Oil Pad.....
446c	5169	" " " Set Screw.....
18145	5151	" Rock Shaft.....
18146	5169	" " " Regulator Crank with 790c and two 1147c.....
790c	5169	Feed Rock Shaft Regulator Crank Position Screw.....
1147c	5169	Feed Rock Shaft Regulator Crank Set Screw.....
307c	5163	Feed Rock Shaft Screw Centre.....
1513J	5164	" " " " " Nut.....
18147	5169	" " " " " Oil Tube (crank end).....
18148	5169	Feed Rock Shaft Screw Centre Oil Tube (feed bar end).....
26463	956	Guide (1 1/2 in. face).....
26693	956	" (4 in. face).....
190D	5171	" Screw.....
18149	5176	Loop Retainer, for single thread.....
335D	5176	" " Screw.....
18299	5173	Looper with 1120F and 1389F, for double thread.....
18300	5173	Looper with 1120F and 1389F, for single thread.....
1389F	5173	Looper Position Screw.....

NO.	PLATE	NAME
1120F	5173	Looper Set Screw.....
18152	5151	" Shaft.....
19496	—	" " Crank.....
19447	5155	Looper Shaft Crank complete, Nos. 457c, 1518E, 19449 and 19496.....
2049	5155	Looper Shaft Crank Pin.....
457c	5164	" " " Set Screw.....
19448	5155	" " " Slide Block.....
226D	5211	" " " " " Cap Screw
12424	5155	" " " " " " " Washer.....
988c	5155	Looper Shaft Crank Slide Block Screw Stud.....
1518E	5155	Looper Shaft Crank Slide Block Screw Stud Nut.....
19449	—	Looper Shaft Crank Slide Block complete, Nos. 226D, 988c, 12424 and 19448.....
18153	5169	Looper Shaft Oil Cup.....
18154	5169	" " " " Packing.....
18098	5152	Needle Bar (hollow).....
*18155	5170	" " Connecting Link with 794E...
18301	—	" " " " 18155 with 12384.....
794E	5170	Needle Bar Connecting Link Adjusting Screw.....
*12383	—	Needle Bar Connecting Stud.....
12384	5156	Needle Bar Connecting Stud complete, Nos. 453c, 1904 and 12383.....
1904	5156	Needle Bar Connecting Stud Roller (roller only).....
453c	5156	Needle Bar Connecting Stud Set Screw....
18231	5167	" " Crank and Thread Nipper Eccentric with 448c and 1065c.....
1065c	5163	Needle Bar Crank and Thread Nipper Eccentric Position Screw.....
448c	5163	Needle Bar Crank and Thread Nipper Eccentric Set Screw.....
936D	5163	Needle Bar Screw Bushing.....
18157	5170	" " Thread Retainer Bracket.....
18343	—	Needle Bar Thread Retainer Bracket com- plete, Nos. 453c, 462c, 12400, 18157, 18159, 18344 and 20910.....
453c	5170	Needle Bar Thread Retainer Bracket Set Screw.....
12400	5170	Needle Bar Thread Retainer Sleeve.....
18159	5170	" " " " Spring.....
20910	5241	" " " Retaining Collar.....

NO.	PLATE	NAME
18344	5241	Needle Bar Thread Retaining Stud.....
462c	5170	“ “ “ “ “ Set Screw
18161	5170	“ Clamp with 209F.....
2273	5156	“ “ Pin.....
209F	5156	“ Set Screw.....
*18162	5152	Oscillating Rock Shaft.....
18163	—	Oscillating Rock Shaft complete, Nos. 4784, 12388 and 18162.....
12388	5152	Oscillating Rock Shaft Hinge Pin.....
878J	5163	“ “ “ “ Oil Hole Stop Screw.....
12459	5161	Oscillating Rock Shaft Hinge Pin Oil Hole Stop Screw Washer (leather).....
448c	5163	Oscillating Rock Shaft Hinge Pin Set Screw.....
4784	5161	Oscillating Rock Shaft Oil Pad.....
18164	5167	Presser Bar.....
2062	5156	“ “ Lifter.....
689c	5156	“ “ “ Screw.....
1520E	5156	“ “ “ “ Nut.....
20023	5152	“ “ Spring (heavy).....
11167	5152	“ “ “ (light).....
12139	5152	“ “ “ (medium).....
11168	5156	“ “ “ Bracket with 453c.....
453c	5156	“ “ “ “ Set Screw.....
11170	5156	“ “ “ Washer.....
18165	—	“ Foot Body.....
18325	5241	“ “ Hinge Pin.....
18166	—	“ “ Plate.....
18200	5180	“ “ Spring, for heavy work.....
18201	5180	“ “ “ light work.....
889c	5180	“ “ “ Adjusting Screw.....
18167	5180	“ “ “ Stud.....
18168	5180	Presser Foot (spring hinged) complete, Nos. 889c, 18165 to 18167, 18200, 18201 and 18325.....
18215	—	Presser Foot Body.....
18325	5241	“ “ Hinge Pin.....
18212	—	“ “ Plate.....
18200	5180	“ “ Spring, for heavy work.....
18201	5180	“ “ “ light work.....
889c	5180	“ “ “ Adjusting Screw.....
18167	5180	“ “ “ Stud.....
18213	5180	Presser Foot (spring hinged) complete for 18211, Nos. 889c, 18167, 18200, 18201, 18212, 18215 and 18325.....
190D	5171	Presser Foot Screw.....

NO.	PLATE	NAME
688J	5163	Pressure Regulating Thumb Screw.....
18169	5172	Slack Thread Regulator.....
18170	5172	“ “ “ Adjusting Bracket
219F	5172	“ “ “ “ “ Screw.....
66F	5172	Slack Thread Regulator Hinge Screw.....
1521E	5172	“ “ “ “ “ Nut
18111	5172	“ “ “ Link with 1919...
766D	5172	“ “ “ Hinge Screw
1919	5172	“ “ “ “ Roller and Stud.....
2102	5161	Tension (under thread) Disc.....
1560c	5161	“ “ “ Regulating Thumb Nut.....
686E	5171	Tension (under thread) Screw Stud.....
10148	5171	“ “ “ Spring.....
2921	5171	“ (upper thread) Disc.....
13589	5171	“ “ “ “ Steady Pin...
1560c	5161	“ “ “ Regulating Thumb Nut.....
1046c	5171	Tension (upper thread) Screw Stud.....
8238	5161	“ “ “ Spring.....
18172	5171	Thread Eyelet (top of arm).....
18171	5171	“ (under) Eyelet.....
191c	5171	“ “ “ Screw.....
9525	5171	“ “ “ “ Washer.....
18184	5171	“ “ Take-up Arm.....
18185	5171	“ “ “ Body with 453c
453c	5171	“ “ “ “ Set Screw
18183	—	Thread (under) Take-up complete, Nos. 18184 and 18185.....
18186	5171	Thread (under) Take-up Eyelet.....
190D	5171	“ “ “ “ Screw....
*18174	—	“ (upper) Nipper Connection Cap
145E	5169	“ “ “ “ “ Screw.....
18175	—	Thread (upper) Nipper Connection Rod
2532	5171	“ “ “ “ “ Dowel Pin.....
*18176	—	Thread (upper) Nipper Connection Rod End Bearing.....
18173	5171	Thread (upper) Nipper Connection com- plete, Nos. 2532, 18174 to 18176 and two 145E.....
18177	5171	Thread (upper) Nipper Connection Sleeve
18180	5171	“ “ “ Plate with 13589 .

NO.	PLATE	NAME
*3023	—	Clamp Stop Motion Flanged Bushing.....
4933	5154	“ “ “ “ “ “ 3023 with two 462c.....
2022	5161	Clamp Stop Motion Flanged Bushing Pin
462c	5155	“ “ “ “ “ “ Set Screw.....
3022	—	Clamp Stop Motion complete, Nos. 248A, 256J, 2020 and 4933.....
18134	5168	Cloth Plate for 18286 and 18287.....
18294	5237	“ “ “ 18289 and 18290.....
18295	5237	“ “ “ 18292 and 18293.....
691F	5163	“ “ “ “ “ “ Screw.....
20197	5152	Crank Connecting Rod with 20198 and two 896E.....
*20198	—	Crank Connecting Rod Cap.....
896E	5163	“ “ “ “ “ “ Screw.....
908c	5163	“ “ “ “ “ “ Hinge Screw.....
1619E	5164	“ “ “ “ “ “ Nut.....
18273	—	Face Plate.....
18274	5236	Face Plate complete, Nos. 66F, 1521E, 18169, 18170, 18273 and two 219F.....
190D	5171	Face Plate Screw.....
286D	5163	“ “ “ “ “ “ Thumb Screw.....
20913	5240	Feed Bar with 176D.....
176D	5211	“ “ “ “ “ “ Adjusting Screw.....
1045c	5169	“ “ “ “ “ “ Hinge Screw.....
1518E	5169	“ “ “ “ “ “ Nut.....
313c	5163	“ “ “ “ “ “ Screw Centre.....
1519E	5164	“ “ “ “ “ “ Nut.....
18275	5203	“ “ “ “ “ “ Dog, for $\frac{7}{16}$ in. to $\frac{5}{8}$ in. gauges.....
18288	5204	“ “ “ “ “ “ “ $\frac{1}{16}$ in. to $1\frac{1}{2}$ in. gauges.....
18291	5206	“ “ “ “ “ “ “ $1\frac{3}{16}$ in. and $1\frac{1}{4}$ in. gauges.....
172c	5163	“ “ “ “ “ “ Screw.....
5570	5152	“ “ “ “ “ “ Eccentric with 446c.....
18141	5167	“ “ “ “ “ “ Connecting Rod with 896E, 11136 and two 145E.....
896E	5163	Feed Eccentric Connecting Rod Adjusting Screw.....
*11136	—	Feed Eccentric Connecting Rod Cap.....
145E	5169	“ “ “ “ “ “ “ “ Screw.....
697c	5169	“ “ “ “ “ “ “ “ Stud.....
389F	5169	“ “ “ “ “ “ “ “ Cap Screw.....
11137	5169	Feed Eccentric Connecting Rod Stud Cap Screw Washer.....
1518E	5169	Feed Eccentric Connecting Rod Stud Nut

NO.	PLATE	NAME
2018	5169	Feed Eccentric Connecting Rod Stud Nut Washer.....
446c	5163	Feed Eccentric Set Screw.....
18142	5169	“ “ “ “ “ “ Lifting Eccentric with 446c.....
18143	5169	“ “ “ “ “ “ Connection.....
18144	5169	“ “ “ “ “ “ Oil Pad.....
446c	5169	“ “ “ “ “ “ Set Screw.....
18145	5151	“ “ “ “ “ “ Rock Shaft.....
18146	5169	“ “ “ “ “ “ Regulator Crank with 790c and two 1147c.....
790c	5169	Feed Rock Shaft Regulator Crank Posi- tion Screw.....
1147c	5169	Feed Rock Shaft Regulator Crank Set Screw.....
307c	5163	Feed Rock Shaft Screw Centre.....
1513J	5164	“ “ “ “ “ “ Nut.....
18147	5169	“ “ “ “ “ “ Oil Tube (crank end).....
18148	5169	Feed Rock Shaft Screw Centre Oil Tube (feed bar end).....
26463	956	Guide ($1\frac{1}{2}$ in. face).....
26693	956	“ “ (4 in. face).....
190D	5171	“ “ “ “ “ “ Screw.....
18149	5176	Loop Retainer, for single thread.....
335D	5176	“ “ “ “ “ “ Screw.....
18300	5173	Looper (inside) with 1120F and 1389F, for single thread.....
18119	5159	Looper (inside) with 1076c, for No. 23 needle, for $\frac{3}{16}$ in. gauge and above.....
18120	5159	Looper (outside) with 1076c, for No. 23 needle, for $\frac{3}{16}$ in. gauge and above.....
18299	5173	Looper (inside) with 1120F and 1389E, for double thread.....
18299	5173	Looper (outside) with 1120F and 1389E, for double thread.....
18300	5173	Looper (outside) with 1120F and 1389E, for single thread.....
1389F	5173	Looper Position Screw.....
1120F	5173	“ “ “ “ “ “ Set Screw for 18299 and 18300.....
1076c	5158	“ “ “ “ “ “ “ 18119 and 18120.....
18276	5151	“ “ “ “ “ “ Shaft.....

NOTE: When ordering No. 18276, state
gauge required.

19496 ——— Looper Shaft Crank.....

19447 5155 Looper Shaft Crank complete, Nos. 457c,
1518E, 19449 and 19496.....

NO.	PLATE	NAME
2049	5155	Looper Shaft Crank Pin.....
457c	5164	“ “ “ Set Screw.....
19448	5155	“ “ “ Slide Block.....
226d	5211	“ “ “ “ “ Cap Screw
12424	5155	“ “ “ “ “ “ “
		Washer.....
988c	5155	Looper Shaft Crank Slide Block Screw Stud.....
1518E	5155	Looper Shaft Crank Slide Block Screw Stud Nut.....
19449	—	Looper Shaft Crank Slide Block complete, Nos. 226d, 988c, 12424 and 19448.....
18153	5169	Looper Shaft Oil Cup.....
18154	5169	“ “ “ “ Packing.....
18098	5152	Needle Bar (hollow).....
*18155	5170	“ “ Connecting Link with 794E... ..
18301	—	“ “ “ “ 18155 with 12384.....
794E	5170	Needle Bar Connecting Link Adjusting Screw.....
*12383	—	Needle Bar Connecting Stud.....
12384	5156	Needle Bar Connecting Stud complete, Nos. 453c, 1904 and 12383.....
1904	5156	Needle Bar Connecting Stud Roller (roller only).....
453c	5156	Needle Bar Connecting Stud Set Screw....
18231	5167	“ “ Crank and Thread Nipper Eccentric with 448c and 1065c.....
1065c	5163	Needle Bar Crank and Thread Nipper Eccentric Position Screw.....
448c	5163	Needle Bar Crank and Thread Nipper Eccentric Set Screw.....
936d	5163	Needle Bar Screw Bushing.....
18157	5170	“ “ Thread Retainer Bracket....
18345	—	Needle Bar Thread Retainer Bracket complete, Nos. 453c, 462c, 12400, 18157, 18159, 18346, 20910 and 21020.....
453c	5170	Needle Bar Thread Retainer Bracket Set Screw.....
12400	5170	Needle Bar Thread Retainer Sleeve.....
18159	5170	“ “ “ “ Spring.....
20910	5241	“ “ “ Retaining Collar.....
18346	5241	“ “ “ “ Stud.....
462c	5170	“ “ “ “ “ S e t Screw.....
21020	5172	Needle Bar Thread Retaining Thread Separator.....

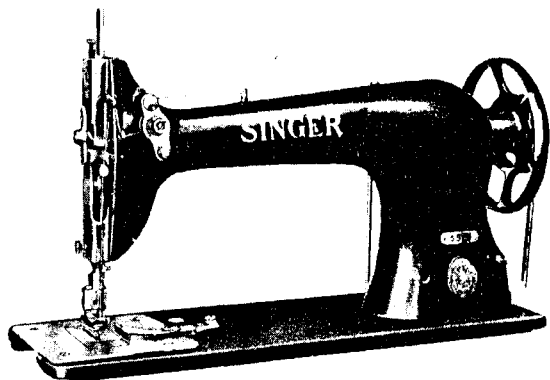
NO.	PLATE	NAME
18052	5172	Needle Clamp with two 209F.....
		NOTE: When ordering No. 18052, state gauge required.
2273	5156	Needle Clamp Pin.....
209F	5156	“ Set Screw.....
*18162	5152	Oscillating Rock Shaft.....
18163	—	Oscillating Rock Shaft complete, Nos. 4784, 12388 and 18162.....
12388	5152	Oscillating Rock Shaft Hinge Pin.....
878J	5163	“ “ “ “ “ Oil Hole Stop Screw.....
12459	5161	Oscillating Rock Shaft Hinge Pin Oil Hole Stop Screw Washer (leather).....
448c	5163	Oscillating Rock Shaft Hinge Pin Set Screw.....
4784	5161	Oscillating Rock Shaft Oil Pad.....
18164	5167	Presser Bar.....
2062	5156	“ “ Lifter.....
689c	5156	“ “ “ Screw.....
1520E	5156	“ “ “ “ Nut.....
20023	5152	“ “ Spring (heavy).....
11167	5152	“ “ “ (light).....
12139	5152	“ “ “ (medium).....
11168	5156	“ “ “ Bracket with 453c.....
453c	5156	“ “ “ “ Set Screw....
11170	5156	“ “ “ Washer.....
18279	—	“ Foot Body.....
18280	5160	“ “ Hinge Pin.....
18281	—	“ “ Plate.....
18200	5180	“ “ Spring, for heavy work.....
18201	5180	“ “ “ “ light work.....
889c	5180	“ “ “ Adjusting Screw.....
18167	5180	“ “ “ Stud.....
18282	5203	Presser Foot (spring hinged) complete for 18275, Nos. 889c, 18167, 18200, 18201 and 18279 to 18281.....
18055	5161	Presser Foot Hinge Pin.....
18195	—	“ “ Plate.....
18196	—	“ “ Shank.....
18197	5214	Presser Foot (tube) hinged, complete, Nos. 18055, 18195 and 18196.....
190D	5171	Presser Foot Screw.....
688J	5163	Pressure Regulating Thumb Screw.....
18169	5172	Slack Thread Regulator.....
18170	5172	“ “ “ Adjusting Bracket

NO.	PLATE	NAME
219F	5172	Slack Thread Regulator Adjusting Bracket Screw
66F	5172	Slack Thread Regulator Hinge Screw
1521E	5172	" " " " " Nut
18111	5172	" " " Link with 1919
766D	5172	" " " " Hinge Screw
1919	5172	" " " " Roller and Stud
2102	5161	Tension (under thread) Disc
18283	5160	" " " Eyelet (double)
1560C	5161	" " " Regulating Thumb Nut
686E	5171	Tension (under thread) Screw Stud
13550	5160	" " " Separating Disc
10148	5171	" " " Spring
2921	5171	" (upper thread) Disc
13589	5171	" " " " Steady Pin
1560C	5161	" " " Regulating Thumb Nut
1046C	5171	Tension (upper thread) Screw Stud
8238	5161	" " " Spring
23868	5160	Thread Eyelet (top of arm)
18171	5171	" (under) Eyelet for 18134
191C	5171	" " " Screw
9525	5171	" " " " Washer
18184	5171	" " " Take-up Arm
18185	5171	" " " Body with 453C
453C	5171	" " " Set Screw
18183	—	Thread (under) Take-up complete, Nos. 18184 and 18185
18186	5171	Thread (under) Take-up Eyelet
190D	5171	" " " " Screw
*18174	—	" (upper) Nipper Connection Cap
145E	5169	" " " " " " Screw
18175	—	Thread (upper) Nipper Connection Rod
2532	5171	" " " " " " Dowel Pin
*18176	—	Thread (upper) Nipper Connection Rod End Bearing
18173	5171	Thread (upper) Nipper Connection complete, Nos. 2532, 18174 to 18176 and two 145E
18177	5171	Thread (upper) Nipper Connection Sleeve
18180	5171	" " " Plate with 13589
18312	5241	" " " " Stud and Thread Eyelet

NO.	PLATE	NAME
175F	5171	Thread (upper) Nipper Plate Stud and Thread Eyelet Set Screw
18182	5171	Thread (upper) Nipper Plate Washer
1521C	5171	" " " " Regulating Nut
1521C	5171	" " " " " " Lock Nut
13550	5160	Thread (upper) Nipper Separating Disc
18187	5170	" " " Take-up Crank
3094	5170	" " " " Wedge
690E	5170	" " " " " Screw
18284	5172	" " " " Lever
18189	5170	" " " " Arm
11204	5170	" " " " Hinge Pin
430C	5170	" " " " " " " " Set Screw
18190	5170	Thread (upper) Take-up Lever Link
775E	5170	" " " " " " Cap Screw
18191	5170	Thread (upper) Take-up Lever Rivet
18285	—	Thread (upper) Take-up Lever complete, Nos. 18189, 18284 and two 18191
18286	5203	Throat Plate, for double thread, for 18275
18287	5203	" " with two each 335D and 18149, for single thread, for 18275
18289	5204	Throat Plate, for double thread, for 18288
18290	5205	" " with two each 335D and 18149, for single thread, for 18288
18292	5206	Throat Plate for 18291, for double thread
18293	5207	" " with two each 335D and 18149, for single thread, for 18291
742F	5171	Throat Plate Screw
44212	7711	Drip Pan with four 1 in. wire nails

LIST OF PARTS COMPLETE

FOR



MACHINE No. 55-5

FOR BASTING CLOTHING, ETC. ONE NEEDLE, ONE LOOPER.
SINGLE THREAD CHAIN STITCH FROM 1/4 TO 1/2 INCH
LONG. DROP FEED.

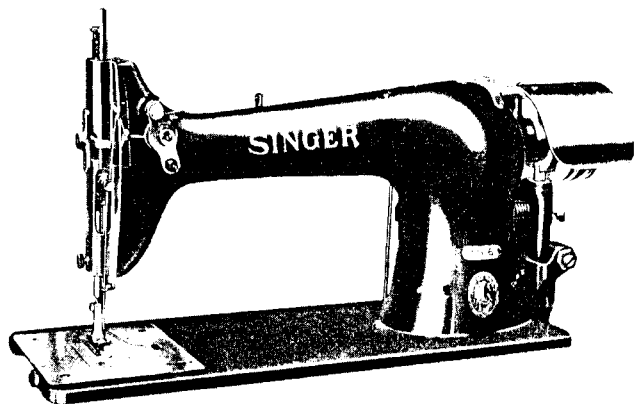
NO.	PLATE	NAME
*18129	---	Arm with 11104.....
8582	5161	" Dowel Pin.....
12453	5161	" Oil Tube, for intermediate bearing...
12454	5161	" " " with 29599, for oiling 18189
11119	5170	" " " " " " 18190 and 18231.....
29599	5161	Arm Oil Tube Packing (felt).....
748E	5163	" Screw (back).....
854E	5163	" " (front).....
18131	5151	" Shaft.....
*11104	---	" " Bushing (front).....
12357	5154	" " Flanged Bushing (back).....
448c	5163	" " " " Set Screw.....
144d	5163	" " Screw.....
12480	5153	" Side Cap.....
219d	5163	" " " Screw.....

NO.	PLATE	NAME
12193	5153	Arm Side Cover.....
286d	5163	" " " Thumb Screw.....
4388	5150	Balance Wheel (power) light rim, 2 3/4 in. pulley, with two 448c.....
448c	5163	Balance Wheel Set Screw.....
*20912	---	Bed.....
18133	5172	" Oil Hole Cover.....
1044E	5172	" " " Hinge Screw.....
18134	5168	Cloth Plate.....
691F	5163	" " Screw.....
20197	5152	Crank Connecting Rod with 20198 and two 896E.....
*20198	---	Crank Connecting Rod Cap.....
896E	5163	" " " " Screw.....
908c	5163	" " " Hinge Screw.....
1619E	5164	" " " " " Nut.....
18135	---	Face Plate.....
18136	5167	Face Plate complete, Nos. 66F, 1521E, 18135, 18169, 18170 and two 219E.....
190d	5171	Face Plate Screw.....
286d	5163	" " Thumb Screw.....
20913	5210	Feed Bar with 176d.....
176d	5211	" " Adjusting Screw.....
1045c	5169	" " Hinge Screw.....
1518E	5169	" " " " Nut.....
313c	5163	" " Screw Centre.....
1519E	5164	" " " " Nut.....
120371	5208	" Dog.....
20916	5208	" ".....
172c	5163	" " Screw.....
18309	5240	" Eccentric with two 448c.....
18310	5240	" " Connecting Rod with 18311 and two 145E.....
*18311	---	Feed Eccentric Connecting Rod Cap.....
145E	5169	" " " " " Screw.....
697c	5169	" " " " Stud.....
389F	5169	" " " " " Cap Screw.....
11137	5169	Feed Eccentric Connecting Rod Stud Cap Screw Washer.....
1518E	5169	Feed Eccentric Connecting Rod Stud Nut
2018	5169	" " " " " " " Washer.....
448c	5163	Feed Eccentric Set Screw.....
18142	5169	" Lifting Eccentric with 446c.....
18143	5169	" " " Connection.....
18144	5169	" " " Oil Pad.....

NO.	PLATE	NAME
878J	5163	Oscillating Rock Shaft Hinge Pin Oil Hole Stop Screw.....
12459	5161	Oscillating Rock Shaft Hinge Pin Oil Hole Stop Screw Washer (leather).....
448c	5163	Oscillating Rock Shaft Hinge Pin Set Screw.....
4784	5161	Oscillating Rock Shaft Oil Pad.....
18164	5167	Presser Bar.....
2062	5156	" " Lifter.....
689c	5156	" " " Screw.....
1520E	5156	" " " " Nut.....
11167	5152	" " Spring.....
11168	5156	" " " Bracket with 453c.....
453c	5156	" " " " Set Screw.....
11170	5156	" " " Washer.....
7309	5242	" Foot Cap.....
220b	5242	" " " Screw.....
7310	5242	" " Hinge Connection.....
106b	5242	" " " " Hinge Screw.....
7311	5242	" " " " Pin.....
62527	5211	" " " Pin.....
20921	—	" " Plate (left).....
20922	—	" " " (right).....
20923	—	" " Shank with 7311.....
20924	—	" " " Bracket.....
20925	5209	Presser Foot (hinged, compensating) Nos. 106b, 220b, 7309, 7310, 20921, 20922, 20924 and two each 20923 and 62527..
190b	5171	Presser Foot Screw.....
688J	5163	Pressure Regulating Thumb Screw.....
18169	5172	Slack Thread Regulator.....
18170	5172	" " " Adjusting Bracket.....
219F	5172	" " " " " " Screw.....
66F	5172	Slack Thread Regulator Hinge Screw.....
1521E	5172	" " " " " Nut.....
18111	5172	" " " Link with 1919... ..
766b	5172	" " " " Hinge Screw.....
1919	5172	" " " " Roller and Stud.....
2921	5171	Tension Disc.....
13589	5171	" " Steady Pin.....
1560c	5161	" Regulating Thumb Nut.....
1046c	5171	" Screw Stud.....
8238	5161	" Spring.....
18172	5171	Thread Eyelet (top of arm).....
*18174	—	" Nipper Connection Cap.....

NO.	PLATE	NAME
145E	5169	Thread Nipper Connection Cap Screw....
18175	—	" " " Rod.....
2532	5171	" " " " Dowel Pin.....
*18176	—	" " " " End Bearing.....
18173	5171	Thread Nipper Connection complete, Nos. 2532, 18174 to 18176 and two 145E....
18177	5171	Thread Nipper Connection Sleeve.....
18180	5171	" " Plate with 13589.....
18181	5171	" " Stud and Thread Eyelet.....
175F	5171	Thread Nipper Plate Stud and Thread Eyelet Set Screw.....
18182	5171	Thread Nipper Plate Washer.....
1521c	5171	" " Regulating Nut.....
1521c	5171	" " " Lock Nut.....
18187	5170	" Take-up Crank.....
3094	5170	" " " Wedge.....
690E	5170	" " " " Screw.....
18188	5170	" " Lever.....
18189	5170	" " " Arm.....
11204	5170	" " " Hinge Pin.....
430c	5170	" " " " Set Screw.....
18190	5170	" " " Link.....
775E	5170	" " " " Cap Screw....
18191	5170	" " " Rivet.....
18192	—	Thread Take-up Lever complete, Nos. 18188, 18189 and two 18191.....
120376	5208	Throat Plate with 335b and 18149, for single thread, for 120371.....
20917	5208	Throat Plate with 335b and 18149, for 20916.....
742F	5171	Throat Plate Screw.....
44212	7711	Drip Pan with four 1 in. wire nails.....

LIST OF PARTS COMPLETE FOR



MACHINE No. 55-6

FOR STITCHING COST MARKS OR OTHER TICKETS UPON CLOTHING. MAKES STITCH $\frac{3}{2}$ TO $\frac{3}{4}$ INCH LONG. ONE NEEDLE, ONE LOOPER, SINGLE THREAD CHAIN STITCH. STOP MOTION. DROP FEED. THE NUMBER OF STITCHES IS CONTROLLED BY THE PRESSURE OF THE OPERATOR'S FOOT ON THE TREADLE, THE MACHINE COMING TO A FULL STOP, WITH THE NEEDLE AT ITS HIGHEST POINT, AS SOON AS THE PRESSURE IS RELEASED.

NO.	PLATE	NAME
*18327	—	Arm with 11104.....
8582	5161	" Dowel Pin.....
12453	5161	" Oil Tube, for intermediate bearing...
12454	5161	" " " with 29599, for oiling 18189
11119	5170	" " " " " " 18190 and 18231.....
29599	5161	Arm Oil Tube Packing (felt).....
748E	5163	" Screw (back).....
854E	5163	" " (front).....
18328	5244	" Shaft.....
*11104	—	" " Bushing (front).....

NO.	PLATE	NAME
18329	5240	Arm Shaft Flanged Bushing (back).....
448C	5163	" " " " " Set Screw.....
1069D	5164	" " Screw.....
12480	5153	" Side Cap.....
219D	5163	" " " Screw.....
12193	5153	" " Cover.....
286D	5163	" " " Thumb Screw.....
*20915	—	Bed.....
18133	5172	" Oil Hole Cover.....
1044E	5172	" " " " Hinge Screw.....
18498	5244	Belt Cover.....
18331	5244	" " Bracket with 871E and 43585...
871E	5164	" " " Screw Stud.....
43585	5241	" " " Stud.....
217D	5164	" " Screw.....
18134	5168	Cloth Plate.....
691F	5163	" " Screw.....
20197	5152	Crank Connecting Rod with 20198 and two 896E.....
*20198	—	Crank Connecting Rod Cap.....
896E	5163	" " " " Screw.....
908C	5163	" " " " Hinge Screw.....
1619E	5164	" " " " " Nut.....
18135	—	Face Plate.....
18136	5167	Face Plate complete, Nos. 66F, 1521E, 18135, 18169, 18170 and two 219F.....
190D	5171	Face Plate Screw.....
286D	5163	" " Thumb Screw.....
20913	5240	Feed Bar with 176D.....
176D	5211	" " Adjusting Screw.....
1045C	5169	" " Hinge Screw.....
1518E	5169	" " " " Nut.....
313C	5163	" " Screw Centre.....
1519E	5164	" " " " Nut.....
18332	5243	" Dog.....
172C	5163	" " Screw.....
5570	5152	" Eccentric with 446C.....
18141	5167	" " Connecting Rod with 896E, 11136 and two 145E.....
896E	5163	Feed Eccentric Connecting Rod Adjusting Screw.....
*11136	—	Feed Eccentric Connecting Rod Cap.....
145E	5169	" " " " " Screw.....
697C	5169	" " " " " Stud.....
389F	5169	" " " " " Cap Screw.....

NO.	PLATE	NAME
11137	5169	Feed Eccentric Connecting Rod Stud Cap Screw Washer.....
1518E	5169	Feed Eccentric Connecting Rod Stud Nut.....
2018	5169	Feed Eccentric Connecting Rod Stud Nut Washer.....
446c	5163	Feed Eccentric Set Screw.....
18142	5169	" Lifting Eccentric with 446c.....
18143	5169	" " " Connection.....
18144	5169	" " " Oil Pad.....
446c	5169	" " " Set Screw.....
18145	5151	" Rock Shaft.....
18146	5169	" " " Regulator Crank with 790c and two 1147c.....
790c	5169	Feed Rock Shaft Regulator Crank Position Screw.....
1147c	5169	Feed Rock Shaft Regulator Crank Set Screw.....
307c	5163	Feed Rock Shaft Screw Centre.....
1513i	5164	" " " " " Nut.....
18147	5169	" " " " " Oil Tube (crank end).....
18148	5169	Feed Rock Shaft Screw Centre Oil Tube (feed bar end).....
18149	5176	Loop Retainer, for single thread.....
335D	5176	" " " Screw.....
18300	5173	Looper with 1120F and 1389F.....
1389F	5173	" Position Screw.....
1120F	5173	" Set Screw.....
18152	5151	" Shaft.....
19496	—	" " Crank.....
19447	5155	Looper Shaft Crank complete, Nos. 457c, 1518E, 19449 and 19496.....
2049	5155	Looper Shaft Crank Pin.....
457c	5164	" " " Set Screw.....
19448	5155	" " " Slide Block.....
226D	5211	" " " " " Cap Screw.....
12424	5155	" " " " " " " Washer.....
988c	5155	Looper Shaft Crank Slide Block Screw Stud.....
1518E	5155	Looper Shaft Crank Slide Block Screw Stud Nut.....
19449	—	Looper Shaft Crank Slide Block complete, Nos. 226D, 988c, 12424 and 19448.....
18153	5169	Looper Shaft Oil Cup.....
18154	5169	" " " " Packing.....

NO.	PLATE	NAME
18098	5152	Needle Bar (hollow).....
*18155	5170	" " Connecting Link with 794E... ..
18301	—	" " " " 18155 with 12384.....
794E	5170	Needle Bar Connecting Link Adjusting Screw.....
*12383	—	Needle Bar Connecting Stud.....
12384	5156	Needle Bar Connecting Stud complete, Nos. 453c, 1904 and 12383.....
1904	5156	Needle Bar Connecting Stud Roller (roller only).....
453c	5156	Needle Bar Connecting Stud Set Screw... ..
18231	5167	" " Crank and Thread Nipper Eccentric with 448c and 1065c.....
1065c	5163	Needle Bar Crank and Thread Nipper Eccentric Position Screw.....
448c	5163	Needle Bar Crank and Thread Nipper Eccentric Set Screw.....
936D	5163	Needle Bar Screw Bushing.....
18157	5170	" " Thread Retainer Bracket.....
18350	—	Needle Bar Thread Retainer Bracket complete, Nos. 453c, 462c, 12400, 18157, 18344, 18349 and 20910.....
453c	5170	Needle Bar Thread Retainer Bracket Set Screw.....
12400	5170	Needle Bar Thread Retainer Sleeve.....
18349	5241	" " " " Spring.....
20910	5241	" " " Retaining Collar.....
18344	5241	" " " " Stud.....
462c	5170	" " " " " Set Screw.....
18161	5170	" Clamp with 209F.....
2273	5156	" " Pin.....
209F	5156	" Set Screw.....
*18162	5152	Oscillating Rock Shaft.....
18333	—	Oscillating Rock Shaft complete, Nos. 4784, 18162 and 18334.....
18334	5240	Oscillating Rock Shaft Hinge Pin.....
878i	5163	" " " " " Oil Hole Stop Screw.....
12459	5161	Oscillating Rock Shaft Hinge Pin Oil Hole Stop Screw Washer (leather).....
448c	5163	Oscillating Rock Shaft Hinge Pin Set Screw.....
4784	5161	Oscillating Rock Shaft Oil Pad.....
18164	5167	Presser Bar.....
2062	5156	" " Lifter.....
689c	5156	" " " Screw.....

NO.	PLATE	NAME
11204	5170	Thread Take-up Lever Hinge Pin.....
430c	5170	" " " " " " Set Screw
18190	5170	" " " " Link.....
775E	5170	" " " " Cap Screw...
18191	5170	" " " " Rivet.....
18192	—	Thread Take-up Lever complete, Nos. 18188, 18189 and two 18191.....
18342	5243	Throat Plate with 335D and 18149, for 18332.....
742F	5171	Throat Plate Screw.....
44212	7711	Drip Pan with four 1 in. wire nails.....

LIST OF PARTS COMPLETE

FOR

MACHINE No. 55-11

DROP FEED, ONE NEEDLE, ONE LOOPER. FOR HEAVY
WORK IN DUCK, CANVAS, ETC.

NO.	PLATE	NAME
*18001	—	Arm with 11104.....
8582	5161	" Dowel Pin.....
12453	5161	" Oil Tube, for intermediate bearing...
12454	5161	" " " with 29599, for oiling 5570
29599	5161	" " " Packing (felt).....
748E	5163	" Screw (back).....
854E	5163	" " (front).....
18002	5151	" Shaft.....
*11104	—	" " Bushing (front).....
12357	5154	" " Flanged Bushing (back).....
448c	5163	" " " " Set Screw.....
144D	5163	" " Screw.....
12480	5153	" Side Cap.....
219D	5163	" " " Screw.....
12193	5153	" " Cover.....
286D	5163	" " " Thumb Screw.....
12358	5150	Balance Wheel (power) light rim, 2 $\frac{3}{8}$ in. pulley, with two 448c.....
4370	5150	Balance Wheel (stand) heavy rim, 2 $\frac{3}{4}$ in. pulley, with two 448c.....
2135	5150	Balance Wheel (stand) heavy rim, 2 $\frac{1}{2}$ in. pulley, for 3022.....
2862	5150	Balance Wheel (stand) heavy rim, 3 in. pulley, for 3022.....
448c	5163	Balance Wheel Set Screw.....
*18003	—	Bed.....
18042	—	" Slide (left).....
4307	5153	" " " Spring.....
240D	5157	" " " " Screw.....
18043	5153	Bed Slide (left) complete, Nos. 4307, 18042 and two 240D.....
18110	5154	Bed Slide (right) with 7393.....
18041	5160	" " " Spring.....
23227	5160	" " " " Rivet.....
7393	5160	" " " " Stop Pin.....
256J	5154	Clamp Stop Motion Clamp Screw.....
248A	5163	" " " " Stop Screw.....

NO.	PLATE	NAME
2020	5154	Clamp Stop Motion Clamp Washer.....
*3023	—	“ “ “ Flanged Bushing.....
4933	5154	“ “ “ “ “ 3023 with two 462c.....
2022	5161	Clamp Stop Motion Flanged Bushing Pin
462c	5155	“ “ “ “ “ Set Screw.....
3022	—	Clamp Stop Motion complete, Nos. 248A, 256j, 2020 and 4933.....
20197	5152	Crank Connecting Rod with 20198 and two 896e.....
*20198	—	Crank Connecting Rod Cap.....
896E	5163	“ “ “ “ “ Screw.....
908c	5163	“ “ “ “ “ Hinge Screw.....
1619E	5164	“ “ “ “ “ Nut..
18051	—	Face Plate.....
18004	5153	Face Plate complete, Nos. 18027, 18051, 18056 and two 578F.....
190d	5171	Face Plate Screw.....
18027	5161	“ “ Thread Guard (lower) with 12152.....
12152	5161	Face Plate Thread Guard (lower) Rivet...
18056	5161	“ “ “ “ (upper, adjust- able).....
578F	5161	Face Plate Thread Guard (upper) Screw..
286d	5163	“ “ Thumb Screw.....
18005	5152	Feed Bar.....
313c	5163	“ “ Screw Centre.....
1519E	5164	“ “ “ “ Nut.....
3033	5155	“ Connecting Link.....
375c	5155	“ “ “ “ Hinge Screw.....
1518E	5155	“ “ “ “ “ Nut..
18112	5183	“ Dog, for shirt work.....
172c	5163	“ “ Screw.....
5570	5152	“ Eccentric with 446c.....
446c	5163	“ “ Set Screw.....
12429	5152	“ Forked Connection.....
375c	5155	“ “ “ “ Hinge Screw.....
1518E	5155	“ “ “ “ “ Nut
18058	5156	“ Lifting Eccentric with two 624c.....
18059	—	“ “ “ 18058 with 457c and 18037.....
624c	5155	Feed Lifting Eccentric Set Screw.....
3039	5155	“ Regulator.....
58E	5155	“ “ Hinge Screw.....
818d	5155	“ “ Thumb Screw.....
18009	5151	“ Rock Shaft.....

NO.	PLATE	NAME
3043	5155	Feed Rock Shaft Crank with 462c.....
2049	5155	“ “ “ “ Pin.....
462c	5155	“ “ “ “ Set Screw.....
307c	5163	“ “ “ “ Screw Centre.....
1513j	5164	“ “ “ “ “ Nut.....
18010	—	Feed Rock Shaft complete, Nos. 3043 and 18009.....
18096	5153	Folder Holder Seat Cover.....
207F	5157	“ “ “ “ Screw.....
18066	5158	Looper with 1076c.....
1076c	5158	“ Set Screw.....
18067	5151	“ Shaft.....
19496	—	“ “ Crank.....
19447	5155	Looper Shaft Crank complete, Nos. 457c, 1518E, 19449 and 19496.....
2049	5155	Looper Shaft Crank Pin.....
457c	5164	“ “ “ Set Screw.....
19448	5155	“ “ “ Slide Block.....
226d	5211	“ “ “ “ “ Cap Screw
12424	5155	“ “ “ “ “ “ “ Washer.....
988c	5155	Looper Shaft Crank Slide Block Screw Stud.....
1518E	5155	Looper Shaft Crank Slide Block Screw Stud Nut.....
19449	—	Looper Shaft Crank Slide Block complete, Nos. 226d, 988c, 12424 and 19448.....
18098	5152	Needle Bar (hollow).....
18060	5156	“ “ Connecting Link.....
372c	5156	“ “ “ “ Hinge Screw
1518E	5155	“ “ “ “ “ “ Nut.....
*12383	—	Needle Bar Connecting Stud.....
12384	5156	Needle Bar Connecting Stud complete, Nos. 453c, 1904 and 12383.....
1904	5156	Needle Bar Connecting Stud Roller (roller only).....
453c	5156	Needle Bar Connecting Stud Set Screw....
18232	5152	“ “ Crank with 453c and 1065c....
1065c	5163	“ “ “ Position Screw.....
453c	5156	“ “ “ Set Screw.....
936d	5163	“ “ Screw Bushing.....
18099	—	“ Clamp Body with 209F.....
2273	5156	“ “ Pin.....
18069	5156	“ “ Thread Nipper.....
924F	5156	“ “ “ “ Screw.....
18054	5156	“ “ “ “ Spring.....

NO.	PLATE	NAME
18100	5156	Needle Clamp complete, Nos. 924F, 18054, 18069 and 18099.....
209F	5156	Needle Set Screw.....
*18162	5152	Oscillating Rock Shaft.....
18163	—	Oscillating Rock Shaft complete, Nos. 4784, 12388 and 18162.....
12388	5152	Oscillating Rock Shaft Hinge Pin.....
878J	5163	“ “ “ “ “ Oil Hole Stop Screw.....
12459	5161	Oscillating Rock Shaft Hinge Pin Oil Hole Stop Screw Washer (leather).....
448c	5163	Oscillating Rock Shaft Hinge Pin Set Screw.....
4784	5161	Oscillating Rock Shaft Oil Pad.....
12391	5152	Presser Bar (hollow).....
2062	5156	“ “ Lifter.....
689c	5156	“ “ “ Screw.....
1520E	5156	“ “ “ “ Nut.....
20023	5152	“ “ Spring (heavy).....
11167	5152	“ “ “ (light).....
12139	5152	“ “ “ (medium).....
11168	5156	“ “ “ Bracket with 453c.....
453c	5156	“ “ “ “ Set Screw.....
11170	5156	“ “ “ Washer.....
18055	5161	“ Foot Hinge Pin.....
18070	—	“ “ Plate.....
18128	—	“ “ Shank.....
18071	5188	Presser Foot (hinged) complete, Nos. 18055, 18070 and 18128.....
190b	5171	Presser Foot Screw.....
688J	5163	Pressure Regulating Thumb Screw.....
18045	5154	Tension Bracket.....
894F	5161	“ “ Screw.....
18023	5161	“ “ “ Collar.....
2102	5161	“ Disc.....
1560c	5161	“ Regulating Thumb Nut.....
637c	5161	“ Screw Stud.....
1547D	5161	“ “ “ Nut.....
8238	5161	“ Spring (looper thread).....
2103	5161	“ “ (needle thread).....
18024	5154	Thread (arm) Cover.....
405E	5163	“ “ “ Screw (lower).....
207F	5157	“ “ “ “ (upper).....
18025	5154	“ (bed) Cover.....
14026	5161	“ “ “ Pin.....
691F	5163	“ “ “ Screw.....

NO.	PLATE	NAME
18026	—	Thread Cover complete, Nos. 14026, 18024, 18025, 18011 and two each 405E and 23227.....
18072	—	Thread Eyelet (triangular, top of arm).....
18047	5162	“ “ Stud.....
18073	5154	“ “ 18072 with 18047.....
18108	5157	“ (under) Take-up.....
18035	5157	“ “ “ Crank with 1820, 18036 and two 178c.....
*18036	—	Thread (under) Take-up Crank Cap.....
178c	5157	“ “ “ “ “ Screw.....
1820	5157	“ “ “ “ “ Roller and Stud.....
18033	5157	Thread (under) Take-up Lever (forked).....
18107	—	Thread (under) Take-up Lever complete, Nos. 18033, 18108 and two 404b.....
18034	5157	Thread (under) Take-up Lever Hinge Pin.....
624c	5155	“ “ “ “ “ “ Set Screw.....
404b	5157	Thread (under) Take-up Screw.....
18037	5155	“ “ “ “ Thread Guard.....
457c	5164	“ “ “ “ “ “ Set Screw.....
18048	5157	Thread (upper) Controller Bracket.....
207F	5157	“ “ “ “ “ Screw.....
18030	5157	“ “ “ “ “ Stud.....
175F	5157	“ “ “ “ “ “ Set Screw.....
18062	5157	Thread (upper) Controller Spring (inside).....
18064	5157	“ “ “ “ “ (outside).....
240b	5157	“ “ “ “ “ Screw.....
18063	—	Thread (upper) Controller complete, Nos. 240b, 18048, 18062 and 18064.....
18075	5156	Thread (upper) Take-up with 453c.....
453c	5156	“ “ “ “ “ Set Screw.....
18113	5183	Throat Plate for 18112.....
691F	5163	“ “ “ Screw.....
44212	7711	Drip Pan with four 1 in. wire nails.....

LIST OF PARTS COMPLETE
FOR
MACHINE No. 55-12

FOR HEAVY WORK IN DUCK, CANVAS, ETC. TWO
NEEDLES, TWO LOOPERS. GAUGES FROM
 $\frac{1}{2}$ TO $1\frac{3}{8}$ INCHES. DROP FEED.

NO.	PLATE	NAME
*18001	—	Arm with 11104.....
8582	5161	" Dowel Pin.....
12453	5161	" Oil Tube, for intermediate bearing...
12454	5161	" " " with 29599, for oiling 5570
29599	5161	" " " Packing (felt).....
748E	5163	" Screw (back).....
854E	5163	" " (front).....
18002	5151	" Shaft.....
*11104	—	" " Bushing (front).....
12357	5154	" " Flanged Bushing (back).....
448C	5163	" " " " Set Screw.....
144D	5163	" " Screw.....
12480	5153	" Side Cap.....
219D	5163	" " " Screw.....
12193	5153	" " Cover.....
286D	5163	" " " Thumb Screw.....
12358	5150	Balance Wheel (power) light rim, $2\frac{3}{8}$ in. pulley, with two 448c.....
4370	5150	Balance Wheel (stand) heavy rim, $2\frac{3}{4}$ in. pulley, with two 448c.....
2135	5150	Balance Wheel (stand) heavy rim, $2\frac{1}{2}$ in. pulley, for 3022.....
2862	5150	Balance Wheel (stand) heavy rim, 3 in. pulley, for 3022.....
448C	5163	Balance Wheel Set Screw.....
*18003	—	Bed.....
18042	—	" Slide (left) for 18043.....
18236	—	" " " " 18237.....
4307	5153	" " " Spring.....
240D	5157	" " " Screw.....
18043	5153	Bed Slide (left) complete, Nos. 4307, 18042 and two 240D.....
18237	5154	Bed Slide (left) $1\frac{1}{8}$ in. long, for $\frac{3}{4}$ in. to $1\frac{1}{4}$ in. gauges, complete, Nos. 4307, 18236 and two 240D.....

NO.	PLATE	NAME
18110	5154	Bed Slide (right) with 7393.....
18041	5160	" " " Spring.....
23227	5160	" " " " Rivet.....
7393	5160	" " " Stop Pin.....
256J	5154	Clamp Stop Motion Clamp Screw.....
248A	5163	" " " " Stop Screw...
2020	5154	" " " " Washer.....
*3023	—	" " " Flanged Bushing....
4933	5154	" " " " " " 3023 with two 462c.....
2022	5161	Clamp Stop Motion Flanged Bushing Pin
462C	5155	" " " " " " Set Screw.....
3022	—	Clamp Stop Motion complete, Nos. 248A, 256J, 2020 and 4933.....
20197	5152	Crank Connecting Rod with 20198 and two 896E.....
*20198	—	Crank Connecting Rod Cap.....
896E	5163	" " " " Screw.....
908C	5163	" " " Hinge Screw.....
1619E	5164	" " " " " Nut
18051	—	Face Plate for 18004.....
18238	—	" " " 18239.....
18004	5153	Face Plate complete, Nos. 18027, 18051, 18056 and two 578E.....
18239	5153	Face Plate complete for 35658, Nos. 18027, 18056, 18238 and two 578E.....
190D	5171	Face Plate Screw.....
18027	5161	" " Thread Guard (lower) with 12152.....
12152	5161	Face Plate Thread Guard (lower) Rivet...
18056	5161	" " " " (upper, adjust- able).....
578E	5161	Face Plate Thread Guard (upper) Screw...
286D	5163	" " Thumb Screw.....
18005	5152	Feed Bar.....
313C	5163	" " Screw Centre.....
1519E	5164	" " " " Nut.....
3033	5155	" Connecting Link.....
375C	5155	" " " Hinge Screw.....
1518E	5155	" " " " " Nut...
18078	5191	" Dog, for $\frac{5}{2}$ in. to $1\frac{1}{2}$ in. gauges, for banding trousers.....
18205	5197	Feed Dog, for $\frac{1}{4}$ in. to $\frac{1}{2}$ in. gauges.....
18248	5197	" " (spiked teeth) for $\frac{1}{4}$ in. to $\frac{1}{2}$ in. gauges.....

NO.	PLATE	NAME
18198	5198	Feed Dog, for $\frac{1}{2}$ in. to $\frac{3}{4}$ in. gauges, for general work.....
18243	5199	Feed Dog, for $\frac{4}{8}$ in. to $1\frac{1}{4}$ in. gauges....
18296	5239	" " " $\frac{2}{2}$ in. to $1\frac{3}{8}$ in. gauges, for general work.....
18271	5199	Feed Dog (spiked teeth) for $\frac{4}{8}$ in. to $1\frac{1}{4}$ in. gauges.....
18246	5201	Feed Dog, for $1\frac{1}{8}$ in. to $1\frac{5}{8}$ in. gauges....
18124	5194	" " " staying.....
	172c	" " Screw.....
	5570	" Eccentric with 446c.....
	446c	" " Set Screw.....
12429	5152	" Forked Connection.....
	375c	" " " Hinge Screw.....
	1518e	" " " " Nut.....
18058	5156	" Lifting Eccentric with two 624c.....
18059	-----	" " " 18058 with 457c and 18037.....
	624c	Feed Lifting Eccentric Set Screw.....
	3039	" Regulator.....
	58e	" " Hinge Screw.....
	818d	" " Thumb Screw.....
18009	5151	" Rock Shaft.....
	3043	" " " Crank with 462c.....
	2049	" " " " Pin.....
	462c	" " " " Set Screw.....
	307c	" " " " Screw Centre.....
	1513i	" " " " Nut.....
18010	-----	Feed Rock Shaft complete, Nos. 3043 and 18009.....
18096	5153	Folder Holder Seat Cover.....
	207f	" " " " Screw.....
18202	5159	Looper (inside) with 1076c, for $\frac{5}{2}$ in. to $\frac{3}{8}$ in. gauges, for 18204.....
18203	5159	Looper (outside) with 1076c, for $\frac{5}{2}$ in. to $\frac{3}{8}$ in. gauges, for 18204.....
18204	-----	Loopers, for $\frac{5}{2}$ in. to $\frac{3}{8}$ in. gauges, Nos. 198d, 18202 and 18203.....
NOTE: When ordering Nos. 18202, 18203 or 18204, state gauge required.		
18011	5159	Looper (inside) with 1076c, for $\frac{1}{4}$ in. gauge and above.....
18119	5159	Looper (inside) with 1076c, for No. 23 needle, for $\frac{1}{4}$ in. gauge and above.....
18012	5159	Looper (outside) with 1076c, for $\frac{1}{4}$ in. gauge and above.....

NO.	PLATE	NAME
18120	5159	Looper (outside) with 1076c, for No. 23 needle, for $\frac{1}{4}$ in. gauge and above.....
	198d	Looper Screw.....
	1076c	" Set Screw.....
18235	5151	" Shaft.....
19496	-----	" " Crank.....
19447	5155	Looper Shaft Crank complete, Nos. 457c, 1518c, 19449 and 19496.....
	2049	Looper Shaft Crank Pin.....
	457c	" " " Set Screw.....
19448	5155	" " " Slide Block.....
	226d	" " " " Cap Screw.....
12424	5155	" " " " " " Washer.....
	988c	Looper Shaft Crank Slide Block Screw Stud.....
	1518e	Looper Shaft Crank Slide Block Screw Stud Nut.....
19449	-----	Looper Shaft Crank Slide Block complete, Nos. 226d, 988c, 12424 and 19448.....
18098	5152	Needle Bar (hollow).....
18060	5156	" " Connecting Link.....
	372c	" " " " Hinge Screw.....
	1518e	" " " " " " Nut.....
*12383	-----	Needle Bar Connecting Stud.....
12384	5156	Needle Bar Connecting Stud complete, Nos. 453c, 1904 and 12383.....
	1904	Needle Bar Connecting Stud Roller (roller only).....
	453c	Needle Bar Connecting Stud Set Screw....
18232	5152	" " Crank with 453c and 1065c....
	1065c	" " " Position Screw.....
	453c	" " " Set Screw.....
	936b	" " Screw Bushing.....
18052	5172	" Clamp Body with two 209f.....
NOTE: When ordering No. 18052, state gauge required.		
	2273	Needle Clamp Pin.....
18053	5156	" " Thread Nipper.....
NOTE: When ordering No. 18053, state gauge required.		
	924f	Needle Clamp Thread Nipper Screw.....
18054	5156	" " " " Spring.....

NO.	PLATE	NAME
18018	5156	Needle Clamp complete, Nos. 924F and 18052 to 18054.....
NOTE: When ordering No. 18018, state gauge required.		
209F	5156	Needle Set Screw.....
*18162	5152	Oscillating Rock Shaft.....
18163	—	Oscillating Rock Shaft complete, Nos. 4784, 12388 and 18162.....
12388	5152	Oscillating Rock Shaft Hinge Pin.....
878J	5163	“ “ “ “ Oil Hole Stop Screw.....
12459	5161	Oscillating Rock Shaft Hinge Pin Oil Hole Stop Screw Washer (leather).....
448c	5163	Oscillating Rock Shaft Hinge Pin Set Screw.....
4784	5161	Oscillating Rock Shaft Oil Pad.....
12391	5152	Presser Bar (hollow).....
2062	5156	“ “ Lifter.....
689c	5156	“ “ “ Screw.....
1520E	5156	“ “ “ Nut.....
20023	5152	“ “ Spring (heavy).....
11167	5152	“ “ (light).....
12139	5152	“ “ (medium).....
11168	5156	“ “ “ Bracket with 453c....
453c	5156	“ “ “ Set Screw....
11170	5156	“ “ “ Washer.....
18055	5161	“ Foot Hinge Pin.....
18019	—	“ “ Plate.....
18020	—	“ “ Shank.....
18021	5213	Presser Foot (hinged) complete, Nos. 18019, 18020 and 18055.....
18079	—	Presser Foot Band Guide.....
18055	5161	“ “ Hinge Pin.....
18080	—	“ “ Plate with 18079.....
18081	—	“ “ Shank.....
14058	5156	“ “ Spring.....
18082	5213	Presser Foot (spring hinged) complete, Nos. 14058, 18055, 18080 and 18081....
18055	5161	Presser Foot Hinge Pin.....
18195	—	“ “ Plate.....
18196	—	“ “ Shank.....
18197	5214	Presser Foot (tube) hinged, complete, Nos. 18055, 18195 and 18196.....
18055	5161	Presser Foot Hinge Pin.....
18084	—	“ “ Plate.....
18085	—	“ “ Shank.....

NO.	PLATE	NAME
18086	5213	Presser Foot (tube) hinged, complete, with centre guide, for covering seams with tape, Nos. 18055, 18084 and 18085.....
26276	5160	Presser Foot Hinge Pin.....
18250	—	“ “ Plate.....
18251	—	“ “ Shank.....
18252	5214	Presser Foot (hinged) complete, for outside stays and strips, Nos. 18250, 18251 and 26276.....
190D	5171	Presser Foot Screw.....
688J	5163	Pressure Regulating Thumb Screw.....
18022	5154	Tension Bracket.....
894F	5161	“ “ Screw.....
18023	5161	“ “ “ Collar.....
2102	5161	“ Disc.....
1560c	5161	“ Regulating Thumb Nut.....
637c	5161	“ Screw Stud.....
1547D	5161	“ “ Nut.....
8238	5161	“ Spring (looper thread).....
2103	5161	“ “ (needle thread).....
18024	5154	Thread (arm) Cover.....
405E	5163	“ “ “ Screw (lower).....
207F	5157	“ “ “ “ (upper).....
18025	5154	“ (bed) Cover.....
14026	5161	“ “ “ Pin.....
691F	5163	“ “ “ Screw.....
18026	—	Thread Cover complete, Nos. 14026, 18024, 18025, 18044 and two each 405E and 23227.....
18028	—	Thread Eyelet (triangular, top of arm)...
18047	5162	“ “ Stud.....
18046	5154	“ “ 18028 with 18047.....
18032	5157	“ (under) Take-up.....
18035	5157	“ “ “ Crank with 1820, 18036 and two 178c.....
*18036	—	Thread (under) Take-up Crank Cap.....
178c	5157	“ “ “ “ “ Screw.....
1820	5157	“ “ “ “ “ Roller and Stud.....
18033	5157	Thread (under) Take-up Lever (forked)...
18057	—	Thread (under) Take-up Lever complete, Nos. 18032, 18033 and two 404D.....
18034	5157	Thread (under) Take-up Lever Hinge Pin.....
624c	5155	“ “ “ “ “ “ Set Screw.....
404D	5157	Thread (under) Take-up Screw.....
18037	5155	“ “ “ “ Thread Guard..

NO. PLATE	NAME
457c 5164	Thread (under) Take-up Thread Guard Set Screw.....
18048 5157	Thread (upper) Controller Bracket.....
207F 5157	" " " " Screw
18030 5157	" " " " Stud
175F 5157	" " " " " Set Screw.....
18062 5157	Thread (upper) Controller Spring (inside)
18064 5157	" " " " (outside)
240b 5157	" " " " Screw ..
18063 ----	Thread (upper) Controller complete, Nos. 240b, 18048, 18062 and 18064.....
18038 5157	Thread (upper) Take-up with 453c.....
453c 5156	" " " " Set Screw.....
18083 5191	Throat Plate for 18078.....
18199 5198	" " " 18198.....
18245 5199	" " " 18243 and 18271.....
18247 5201	" " " 18246.....
18249 5197	" " " 18205 and 18248.....
18297 5239	" " " 18296.....
18207 5194	" " (flush) for 18124.....
691F 5163	" " Screw.....
44212 7711	Drip Pan with four 1 in. wire nails.....

LIST OF PARTS COMPLETE

FOR

MACHINE No. 55-21

DROP FEED, ONE NEEDLE, ONE LOOPER, LEATHER

NO.	PLATE	NAME
*18001	---	Arm with 11104.....
8582	5161	" Dowel Pin.....
12453	5161	" Oil Tube, for intermediate bearing...
12454	5161	" " " with 29599, for oiling 5570...
29599	5161	" " " Packing (felt).....
748E	5163	" Screw (back).....
854E	5163	" " (front).....
18002	5151	" Shaft.....
*11104	---	" " Bushing (front).....
12357	5154	" " Flanged Bushing (back).....
448c	5163	" " " " Set Screw.....
144d	5163	" " Screw.....
12480	5153	" Side Cap.....
219d	5163	" " Screw.....
12193	5153	" " Cover.....
286d	5163	" " " Thumb Screw.....
12358	5150	Balance Wheel (power) light rim, 2 1/8 in. pulley, with two 448c.....
4370	5150	Balance Wheel (stand) heavy rim, 2 3/4 in. pulley, with two 448c.....
2135	5150	Balance Wheel (stand) heavy rim, 2 1/2 in. pulley, for 3022.....
2862	5150	Balance Wheel (stand) heavy rim, 3 in. pulley, for 3022.....
448c	5163	Balance Wheel Set Screw.....
*18222	---	Bed.....
18223	5166	" Cover.....
691F	5163	" " Screw.....
18224	5166	" Slide.....
256J	5154	Clamp Stop Motion Clamp Screw.....
248A	5163	" " " " Stop Screw.....
2020	5154	" " " " Washer.....
*3023	---	" " " Flanged Bushing.....
4933	5154	" " " " " 3023 with two 462c.....
2022	5161	Clamp Stop Motion Flanged Bushing Pin
462c	5155	" " " " " " Set Screw.....

NO.	PLATE	NAME
3022	—	Clamp Stop Motion complete, Nos. 248A, 256J, 2020 and 4933.....
20197	5152	Crank Connecting Rod with 20198 and two 896E.....
*20198	—	Crank Connecting Rod Cap.....
896E	5163	" " " " Screw.....
908C	5163	" " " " Hinge Screw.....
1619E	5164	" " " " " Nut.....
18093	—	Face Plate.....
18094	5166	Face Plate complete, Nos. 940F, 18027, 18093, 18104, 18105 and two 219E.....
190D	5171	Face Plate Screw.....
18027	5161	" " Thread Guard with 12152.....
12152	5161	" " " " Rivet.....
286D	5163	" " Thumb Screw.....
18005	5152	Feed Bar.....
313C	5163	" " Screw Centre.....
1519E	5164	" " " " Nut.....
3033	5155	" Connecting Link.....
375C	5155	" " " " Hinge Screw.....
1518E	5155	" " " " " Nut.....
18095	5184	" Dog.....
18225	5184	" ".....
172C	5163	" " Screw.....
5570	5152	" Eccentric with 446C.....
446C	5163	" " Set Screw.....
12429	5152	" Forked Connection.....
375C	5155	" " " " Hinge Screw.....
1518E	5155	" " " " " Nut.....
18007	5155	" Lifting Eccentric with two 624C.....
18008	—	" " " " 18007 with 457C and 18037.....
624C	5155	Feed Lifting Eccentric Set Screw.....
3039	5155	" Regulator.....
58E	5155	" " Hinge Screw.....
818D	5155	" " Thumb Screw.....
18009	5151	" Rock Shaft.....
3043	5155	" " " " Crank with 462C.....
2049	5155	" " " " Pin.....
462C	5155	" " " " Set Screw.....
307C	5163	" " " " Screw Centre.....
1513J	5164	" " " " " Nut.....
18010	—	Feed Rock Shaft complete, Nos. 3043 and 18009.....
18097	5158	Looper with 1076C.....
1076C	5158	" Set Screw.....
18067	5151	" Shaft.....

NO.	PLATE	NAME
19496	—	Looper Shaft Crank.....
19447	5155	Looper Shaft Crank complete, Nos. 457C, 1518E, 19449 and 19496.....
2049	5155	Looper Shaft Crank Pin.....
457C	5164	" " " " Set Screw.....
19448	5155	" " " " Slide Block.....
226D	5211	" " " " " Cap Screw.....
12424	5155	" " " " " " " " Washer.....
988C	5155	Looper Shaft Crank Slide Block Screw Stud.....
1518E	5155	Looper Shaft Crank Slide Block Screw Stud Nut.....
19449	—	Looper Shaft Crank Slide Block complete, Nos. 226D, 988C, 12424 and 19448.....
18098	5152	Needle Bar (hollow).....
18060	5156	" " Connecting Link.....
372C	5156	" " " " Hinge Screw.....
1518E	5155	" " " " " " " " Nut.....
*12383	—	Needle Bar Connecting Stud.....
12384	5156	Needle Bar Connecting Stud complete, Nos. 453C, 1904 and 12383.....
1904	5156	Needle Bar Connecting Stud Roller (roller only).....
453C	5156	Needle Bar Connecting Stud Set Screw.....
18226	5152	" " Crank with 453C and 1065C.....
1065C	5163	" " " " Position Screw.....
453C	5156	" " " " Set Screw.....
936D	5163	" " Screw Bushing.....
18099	—	" Clamp Body with 209F.....
2273	5156	" " Pin.....
18069	5156	" " Thread Nipper.....
924F	5156	" " " " " Screw.....
18054	5156	" " " " " Spring.....
18100	5156	Needle Clamp complete, Nos. 924F, 18054, 18069 and 18099.....
209F	5156	Needle Set Screw.....
18101	5162	Oil Cup with 18102.....
18102	5162	" " Pad (felt).....
190D	5171	" " Screw.....
*18162	5152	Oscillating Rock Shaft.....
18163	—	Oscillating Rock Shaft complete, Nos. 4784, 12388 and 18162.....
12388	5152	Oscillating Rock Shaft Hinge Pin.....
878J	5163	" " " " " " Oil Hole Stop Screw.....

NO.	PLATE	NAME
12459	5161	Oscillating Rock Shaft Hinge Pin Oil Hole Stop Screw Washer (leather).....
448c	5163	Oscillating Rock Shaft Hinge Pin Set Screw
4784	5161	" " " Oil Pad.....
12391	5152	Presser Bar (hollow).....
2062	5156	" " Lifter.....
689c	5156	" " " Screw.....
1520E	5156	" " " Nut.....
20023	5152	" " Spring (heavy).....
11167	5152	" " " (light).....
12139	5152	" " " (medium).....
11168	5156	" " " Bracket with 453c.....
453c	5156	" " " Set Screw.....
11170	5156	" " " Washer.....
18227	5188	" Foot.....
190d	5171	" " Screw.....
688J	5163	Pressure Regulating Thumb Screw.....
18104	5160	Slack Thread Regulator.....
18105	5160	" " " Adjusting Bracket
219F	5172	" " " " " "
		Screw.....
940F	5160	Slack Thread Regulator Hinge Screw.....
18111	5172	" " " Link with 1919...
766d	5172	" " " " Hinge Screw
1919	5172	" " " " Roller and Stud.....
18045	5154	Tension Bracket.....
894F	5161	" " " Screw.....
18023	5161	" " " Collar.....
2102	5161	" Disc.....
1560c	5161	" Regulating Thumb Nut.....
637c	5161	" Screw Stud.....
1547D	5161	" " " Nut.....
8238	5161	" Spring (looper thread).....
2103	5161	" " (needle thread).....
18024	5154	Thread (arm) Cover.....
405E	5163	" " " Screw (lower).....
207F	5157	" " " " (upper).....
18228	5166	" (bed) Cover.....
14026	5161	" " " Pin.....
691F	5163	" " " Screw.....
18229	----	Thread Cover complete, Nos. 14026, 18024, 18228 and two 405E.....
18072	----	Thread Eyelet (triangular, top of arm)...
18047	5162	" " Stud.....
18073	5154	" " 18072 with 18047.....
18108	5157	" (under) Take-up.....

NO.	PLATE	NAME
18035	5157	Thread (under) Take-up Crank with 1820, 18036 and two 178c.....
*18036	----	Thread (under) Take-up Crank Cap.....
178c	5157	" " " " " Screw
1820	5157	" " " " Roller and Stud.....
18033	5157	Thread (under) Take-up Lever (forked)...
18107	----	Thread (under) Take-up Lever complete, Nos. 18033, 18108 and two 404d.....
18034	5157	Thread (under) Take-up Lever Hinge Pin
624c	5155	" " " " " "
		Set Screw.....
404d	5157	Thread (under) Take-up Screw.....
18037	5155	" " " " Thread Guard
457c	5164	" " " " " "
		Set Screw.....
18048	5157	Thread (upper) Controller Bracket.....
207F	5157	" " " " Screw
18030	5157	" " " " Stud
175F	5157	" " " " " "
		Set Screw.....
18062	5157	Thread (upper) Controller Spring (inside)
18064	5157	" " " " (outside)
240d	5157	" " " " Screw ..
18063	----	Thread (upper) Controller complete, Nos. 240d, 18048, 18062 and 18064.....
18075	5156	Thread (upper) Take-up with 453c.....
453c	5156	" " " " Set Screw.....
18265	5184	Throat Plate for 18095.....
18230	5184	" " " 18225.....
742F	5171	" " Screw.....
44212	7711	Drip Pan with four 1 in. wire nails.....

LIST OF PARTS COMPLETE

FOR

MACHINE No. 55-22

DROP FEED, TWO NEEDLES, TWO LOOPERS, LEATHER,
GAUGES NOT NARROWER THAN $\frac{5}{32}$ INCH.

NO.	PLATE	NAME
*18001	—	Arm with 11104.....
8582	5161	" Dowel Pin.....
12453	5161	" Oil Tube, for intermediate bearing....
12454	5161	" " " with 29599, for oiling 5570.....
29599	5161	" " " Packing (felt).....
748E	5163	" Screw (back).....
854E	5163	" " (front).....
18002	5151	" Shaft.....
*11104	—	" " Bushing (front).....
12357	5154	" " Flanged Bushing (back).....
448c	5163	" " " " Set Screw.....
144D	5163	" " Screw.....
12480	5153	" Side Cap.....
219D	5163	" " " Screw.....
12193	5153	" " Cover.....
286D	5163	" " " Thumb Screw.....
12358	5150	Balance Wheel (power) light rim, $2\frac{3}{16}$ in. pulley, with two 448c.....
4370	5150	Balance Wheel (stand) heavy rim, $2\frac{3}{4}$ in. pulley, with two 448c.....
2135	5150	Balance Wheel (stand) heavy rim, $2\frac{1}{2}$ in. pulley, for 3022.....
2862	5150	Balance Wheel (stand) heavy rim, 3 in. pulley, for 3022.....
448c	5163	Balance Wheel Set Screw.....
*18222	—	Bed.....
18223	5166	" Cover.....
691F	5163	" " Screw.....
18224	5166	" Slide.....
256J	5154	Clamp Stop Motion Clamp Screw.....
248A	5163	" " " " Stop Screw..
2020	5154	" " " " Washer.....
*3023	—	" " " Flanged Bushing....
4933	5154	" " " " " 3023 with two 462c.....
2022	5161	Clamp Stop Motion Flanged Bushing Pin
462c	5155	" " " " " Set Screw.....

NO.	PLATE	NAME
3022	—	Clamp Stop Motion complete, Nos. 248A, 256J, 2020 and 4933.....
20197	5152	Crank Connecting Rod with 20198 and two 896E.....
*20198	—	Crank Connecting Rod Cap.....
896E	5163	" " " " Screw.....
908c	5163	" " " " Hinge Screw.....
1619E	5164	" " " " " Nut..
18093	—	Face Plate.....
18094	5166	Face Plate complete, Nos. 940E, 18027, 18093, 18104, 18105 and two 219E.....
190D	5171	Face Plate Screw.....
18027	5161	" " Thread Guard with 12152.....
12152	5161	" " " " Rivet.....
286D	5163	" " Thumb Screw.....
18005	5152	Feed Bar.....
313c	5163	" " Screw Centre.....
1519E	5164	" " " " Nut.....
3033	5155	" Connecting Link.....
375c	5155	" " " " Hinge Screw.....
1518E	5155	" " " " " Nut..
18233	5195	" Dog, for $\frac{5}{32}$ in. to $\frac{1}{4}$ in. gauges....
18266	5192	" " " $\frac{5}{32}$ in. to $\frac{1}{4}$ in. gauges, for vamping.....
18124	5194	Feed Dog, for staying.....
172c	5163	" " Screw.....
5570	5152	" Eccentric with 446c.....
446c	5163	" " Set Screw.....
12429	5152	" Forked Connection.....
375c	5155	" " " " Hinge Screw.....
1518E	5155	" " " " " Nut..
18007	5155	" Lifting Eccentric with two 624c.....
18008	—	" " " " 18007 with 457c and 18037.....
624c	5155	Feed Lifting Eccentric Set Screw.....
3039	5155	" Regulator.....
58E	5155	" " Hinge Screw.....
818D	5155	" " Thumb Screw.....
18009	5151	" Rock Shaft.....
3043	5155	" " " Crank with 462c.....
2049	5155	" " " " Pin.....
462c	5155	" " " " Set Screw.....
307c	5163	" " " Screw Centre.....
1513J	5164	" " " " " Nut.....
18010	—	Feed Rock Shaft complete, Nos. 3043 and 18009.....

NO.	PLATE	NAME
18202	5159	Looper (inside) with 1076c, for $\frac{5}{32}$ in. to $\frac{3}{16}$ in. gauges, for 18204.....
18203	5159	Looper (outside) with 1076c, for $\frac{5}{32}$ in. to $\frac{3}{16}$ in. gauges, for 18204.....
18204	—	Loopers, for $\frac{5}{32}$ in. to $\frac{3}{16}$ in. gauges, Nos. 198D, 18202 and 18203.....
NOTE: When ordering Nos. 18202, 18203 or 18204, state gauge required.		
18011	5159	Looper (inside) with 1076c, for $\frac{1}{4}$ in. gauge and above.....
18119	5159	Looper (inside) with 1076c, for No. 23 needle, for $\frac{1}{4}$ in. gauge and above.....
18012	5159	Looper (outside) with 1076c, for $\frac{1}{4}$ in. gauge and above.....
18120	5159	Looper (outside) with 1076c, for No. 23 needle, for $\frac{1}{4}$ in. gauge and above.....
198D	5163	Looper Screw.....
1076c	5158	" Set Screw.....
18013	5151	" Shaft.....
19496	—	" " Crank.....
19447	5155	Looper Shaft Crank complete, Nos. 457c, 1518E, 19449 and 19496.....
2049	5155	Looper Shaft Crank Pin.....
457c	5164	" " " Set Screw.....
19448	5155	" " " Slide Block.....
226D	5211	" " " " " Cap Screw.....
12424	5155	" " " " " " " Washer.....
988c	5155	Looper Shaft Crank Slide Block Screw Stud.....
1518E	5155	Looper Shaft Crank Slide Block Screw Stud Nut.....
19449	—	Looper Shaft Crank Slide Block complete, Nos. 226D, 988c, 12424 and 19448.....
18098	5152	Needle Bar (hollow).....
18060	5156	" " Connecting Link.....
372c	5156	" " " " " Hinge Screw.....
1518E	5155	" " " " " " " Nut.....
*12383	—	Needle Bar Connecting Stud.....
12384	5156	Needle Bar Connecting Stud complete, Nos. 453c, 1904 and 12383.....
1904	5156	Needle Bar Connecting Stud Roller (roller only).....
453c	5156	Needle Bar Connecting Stud Set Screw.....
18226	5152	" " Crank with 453c and 1065c.....

NO.	PLATE	NAME
1065c	5163	Needle Bar Crank Position Screw.....
453c	5156	" " " Set Screw.....
936D	5163	" " Screw Bushing.....
18052	5172	" Clamp Body with two 209F.....
NOTE: When ordering No. 18052, state gauge required.		
2273	5156	Needle Clamp Pin.....
18053	5156	" " Thread Nipper.....
NOTE: When ordering No. 18053, state gauge required.		
924F	5156	Needle Clamp Thread Nipper Screw.....
18054	5156	" " " " Spring.....
18018	5156	Needle Clamp complete, Nos. 924F and 18052 to 18054.....
NOTE: When ordering No. 18018, state gauge required.		
209F	5156	Needle Set Screw.....
18101	5162	Oil Cup with 18102.....
18102	5162	" " Pad (felt).....
190D	5171	" " Screw.....
*18162	5152	Oscillating Rock Shaft.....
18163	—	Oscillating Rock Shaft complete, Nos. 4784, 12388 and 18162.....
12388	5152	Oscillating Rock Shaft Hinge Pin.....
878J	5163	" " " " " Oil Hole Stop Screw.....
12459	5161	Oscillating Rock Shaft Hinge Pin Oil Hole Stop Screw Washer (leather).....
448c	5163	Oscillating Rock Shaft Hinge Pin Set Screw.....
4784	5161	Oscillating Rock Shaft Oil Pad.....
12391	5152	Presser Bar (hollow).....
2062	5156	" " Lifter.....
689c	5156	" " " Screw.....
1520E	5156	" " " " Nut.....
20023	5152	" " Spring (heavy).....
11167	5152	" " " (light).....
12139	5152	" " " (medium).....
11168	5156	" " " Bracket with 453c.....
453c	5156	" " " " Set Screw.....
11170	5156	" " " Washer.....
18055	5161	" Foot Hinge Pin.....
18019	—	" " Plate.....
18020	—	" " Shank.....

NO.	PLATE	NAME
18021	5213	Presser Foot (hinged) complete, Nos. 18019, 18020 and 18055.....
18055	5161	Presser Foot Hinge Pin.....
18126	—	“ “ Plate.....
18123	—	“ “ Shank.....
18127	5214	Presser Foot (hinged) complete, for inside stays, Nos. 18055, 18123 and 18126....
18055	5161	Presser Foot Hinge Pin.....
18195	—	“ “ Plate.....
18196	—	“ “ Shank.....
18197	5214	Presser Foot (tube) hinged, complete, Nos. 18055, 18195 and 18196.....
18268	5192	Presser Foot for 18266.....
190D	5171	“ “ Screw.....
688J	5163	Pressure Regulating Thumb Screw.....
18104	5160	Slack Thread Regulator.....
18105	5160	“ “ “ Adjusting Bracket.....
219F	5172	“ “ “ “ “ Screw.....
940F	5160	Slack Thread Regulator Hinge Screw.....
18111	5172	“ “ “ Link with 1919..
766D	5172	“ “ “ “ Hinge Screw.....
1919	5172	“ “ “ “ Roller and Stud.....
18022	5154	Tension Bracket.....
894F	5161	“ “ “ Screw.....
18023	5161	“ “ “ Collar.....
2102	5161	“ Disc.....
1560C	5161	“ *Regulating Thumb Nut.....
637C	5161	“ Screw Stud.....
1547D	5161	“ “ “ Nut.....
8238	5161	“ Spring (looper thread).....
2103	5161	“ “ (needle thread).....
18024	5154	Thread (arm) Cover.....
405E	5163	“ “ “ Screw (lower).....
207F	5157	“ “ “ “ (upper).....
18228	5166	“ (bed) Cover.....
14026	5161	“ “ “ Pin.....
691F	5163	“ “ “ Screw.....
18229	—	Thread Cover complete, Nos. 14026, 18024, 18228 and two 405E.....
18028	—	Thread Eyelet (triangular, top of arm)...
18047	5162	“ “ Stud.....
18046	5154	“ “ 18028 with 18047.....
18032	5157	“ (under) Take-up.....
18035	5157	“ “ “ Crank with 1820, 18036 and two 178c.....

NO.	PLATE	NAME
*18036	—	Thread (under) Take-up Crank Cap.....
178c	5157	“ “ “ “ “ Screw.....
1820	5157	“ “ “ “ Roller and Stud.....
18033	5157	Thread (under) Take-up Lever (forked)...
18057	—	Thread (under) Take-up Lever complete, Nos. 18032, 18033 and two 404D.....
18034	5157	Thread (under) Take-up Lever Hinge Pin.....
624c	5155	“ “ “ “ “ “ Set Screw.....
404D	5157	Thread (under) Take-up Screw.....
18037	5155	“ “ “ “ Thread Guard... ..
457c	5164	“ “ “ “ “ “ Set Screw.....
18048	5157	Thread (upper) Controller Bracket.....
207F	5157	“ “ “ “ “ Screw.....
18030	5157	“ “ “ “ “ Stud.....
175F	5157	“ “ “ “ “ “ Set Screw.....
18062	5157	Thread (upper) Controller Spring (inside)...
18064	5157	“ “ “ “ “ (outside).....
240D	5157	“ “ “ “ “ Screw... ..
18063	—	Thread (upper) Controller complete, Nos. 240D, 18048, 18062 and 18064.....
18038	5157	Thread (upper) Take-up with 453c.....
453c	5156	“ “ “ “ Set Screw.....
18234	5195	Throat Plate for 18233.....
18269	5195	“ “ “ “ for under strip... ..
18267	5192	“ “ “ 18266.....
18207	5194	“ “ (flush) for 18124.....
691F	5163	“ “ “ Screw.....
44212	7711	Drip Pan with four 1 in. wire nails.....

IRON BASE

NO.	PLATE	NAME
19219	1206	Bed Frame Cushion (leather).....
158c	1206	“ “ “ “ Screw.....
19220	1206	“ “ “ “ Spring.....
19226	1206	“ “ “ “ Hinge Connection.....
19397	1206	“ “ “ “ “ Cap.....
211F	1206	“ “ “ “ “ “ Screw.....
19398	—	“ “ “ “ “ 19226 with 211F and 19397.....
16555	1206	Bed Frame Hinge Plate.....
14010	1206	“ “ “ “ “ Rivet.....

IRON BASE

NO.	PLATE	NAME
20067	819	Bed Frame with two each 16555, 19398, four each 19219, 19220, six each 14010, wood screws 1¼ in. No. 12 and eight 158c.....

ACCESSORIES

NO.	PLATE	NAME
18270	5234	Looper Threading Wire.....
12361	5162	Machine Hinge Connection.....
44139	5162	" " Plate.....
44140	—	Machine Hinge complete, Nos. 12361, 44139 and merlized wood screw 1¼ in. No. 14.....
12405	5162	Machine Rest (felt).....
28084	5245	" " Pin.....
120344	5234	Oiler (copper plated) with 120345.....
120345	5234	" Spout, 5 in. long.....
26026	5234	Screw Driver (machine).....
26485	5234	" " (shuttle tension).....
120341	5234	Tweezers (curved).....
8909	5234	Wrench for 1513 and 1518.....
4822	5234	" " 1521 and 1547.....
8908	5234	" " 1519 and 1520.....
19221	5234	" " 936 and 1619.....
21654	5234	" " 1508 and 1638.....

BINDER

FOR 55-1 MACHINE

NO.	PLATE	NAME
35613	5227	Binder on Slide 18114, for binding knit underwear.....
26276	5160	Presser Foot Hinge Pin.....
35614	—	" " Plate.....
35615	—	" " Shank.....
35616	5227	Presser Foot (hinged) complete, Nos. 26276, 35614 and 35615.....

EDGE FOLDERS

NO.	PLATE	NAME
35617	5229	Edge Folder (right hand) with left hand lower guide, on Slide 18114 complete, to sew narrow tape on flannel and lace material, for 55-2 Machine.....

EDGE FOLDERS

NO.	PLATE	NAME
35627	5220	Edge Folder.....
35628	5220	" " Hinge Plate.....
	74D 5164	" " " Screw.....
35629	5220	Edge Folder (double) swinging, complete, for burlap bags, for 55-3 Machine, Nos. 74D, 35627 and 35628.....
35630	5220	Edge Folder (double) on Shank, for closing burlap bags, for 55-3 Machine.....
35713	5238	Edge Folder on Shank for 55-4 Machine.....

EDGE GUIDE

FOR 55-2 AND 55-12 MACHINES

NO.	PLATE	NAME
35649	5227	Edge Guide on Slide 18114, for general work.....

FINGER GUARD

FOR 55-1, 55-3, 55-5, 55-6, 55-11 AND 55-21 MACHINES

NO.	PLATE	NAME
36818	5809	Finger Guard.....
36819	5809	" " Friction Washer.....
50316J	5809	" " Hinge Screw.....
36820	5809	" " Holder with 196J.....
	196J 5809	" " " Clamping Screw....
36821	5809	Finger Guard complete, Nos. 36818 to 36820 and 50316J.....
120496	5211	Finger Guard.....
	236J 5211	" " Screw.....
120497	5211	" " Holder with 50302J.....
50302J	5211	" " " Set Screw.....
120498	5211	Finger Guard complete, Nos. 236J, 120496 and 120497.....

HEMMERS

NO.	PLATE	NAME
35612	5232	Hemmer (foot) ¼ in. hem, for shirts, for 18253, for 55-1 Machine.....
35626	5230	Hemmer on Shank, for heavy toweling, for 55-3 Machine.....

GUIDE

FOR 55-5 MACHINE

NO.	PLATE	NAME
120438	5209	Guide.....
28972	5241	" Holder.....
35610	5241	" " Friction Washer.....
940D	5160	" " Hinge Screw.....
28973	5241	" " Shank.....
286D	5163	" Thumb Screw.....
7071	5241	" " " Washer.....
120439	5209	Guide (adjustable, hinged) complete, for thick material, Nos. 286D, 940D, 7071, 28972, 28973, 35610 and 120438.....

LAP SEAM FELLER PARTS

NO.	PLATE	NAME
*26269	—	Folder for 26272.....
*26396	—	" " 26397.....
18114	5227	" Slide.....
18116	5228	" " Spring.....
8505	5228	" " " Rivet.....
18118	5228	Holder with 8505 and 18116, for 55-2 and 55-12 Machines.....
207F	5228	Holder Screw.....
26397	5225	Lap Seam Feller (left hand) on Slide complete for 55-2 and 55-12 Machines, Nos. 18114 and 26396.....
26272	5225	Lap Seam Feller (right hand) on Slide complete for 55-2 and 55-12 Machines, Nos. 18114 and 26269.....
35631	5226	Lap Seam Feller (right hand) on Slide 18114, for mackintosh material, for 55-12 Machine.....
35632	5230	Lap Seam Feller (right hand) on Shank, to fold top only, for shoe linings, for 55-22 Machine.....
35636	5226	Lap Seam Feller (left hand) on Slide 18114, to fold bottom only, for 55-2 and 55-12 Machines.....
NOTE: When ordering Lap Seam Fellers, give gauge required.		
18233	5195	Feed Dog, for $\frac{5}{32}$ in. to $\frac{1}{4}$ in. gauges, for 55-2 and 55-12 Machines.....

NO.	PLATE	NAME
18205	5197	Feed Dog, for $\frac{1}{4}$ in. to $\frac{1}{2}$ in. gauges, for 55-2 and 55-12 Machines.....
18241	5198	Feed Dog, for $\frac{3}{4}$ in. to $\frac{3}{4}$ in. gauges, for 55-2 and 55-12 Machines.....
18316	5198	Feed Dog (spiked teeth) for $\frac{3}{4}$ in. to $\frac{3}{4}$ in. gauges, for 55-2 and 55-12 Machines.....
18243	5199	Feed Dog, for $\frac{1}{4}$ in. to $\frac{1}{4}$ in. gauges, for 55-2 and 55-12 Machines.....
18271	5199	Feed Dog (spiked teeth) for $\frac{1}{4}$ in. to $\frac{1}{4}$ in. gauges, for 55-2 and 55-12 Machines.....
18240	5196	Throat Plate for 18233.....
18206	5197	" " " 18205.....
18242	5198	" " " 18241 and 18316.....
18244	5200	" " " 18243 and 18271.....
18055	5161	Presser Foot Hinge Pin.....
18121	—	" " Plate.....
18123	—	" " Shank.....
18122	5215	Presser Foot (hinged) complete, for medium or heavy lap seam feller, for 55-2 and 55-12 Machines, Nos. 18055, 18121 and 18123.....
35714	5238	Lap Seam Guide on Shank, for canvas work, for 55-4 Machine.....

PRESSER FEET

FOR 55-2 AND 55-12 MACHINES

NO.	PLATE	NAME
26276	5160	Presser Foot Hinge Pin.....
35637	—	" " Plate.....
35638	—	" " Shank.....
35639	5231	Presser Foot (strip folding) hinged, complete, with guide for opening seams, Nos. 26276, 35637 and 35638.....
26276	5160	Presser Foot Hinge Pin.....
35640	—	" " Plate.....
35641	—	" " Shank.....
35642	5231	Presser Foot (strip folding) hinged, complete, Nos. 26276, 35640 and 35641.....
26276	5160	Presser Foot Hinge Pin.....
35643	—	" " Plate.....
35644	—	" " Shank.....
35645	5231	Presser Foot (strip folding) hinged, complete, with tube for cording, Nos. 26276, 35643 and 35644.....

PRESSER FEET

NO.	PLATE	NAME
26276	5160	Presser Foot Hinge Pin.....
35646	—	“ “ Plate.....
35647	—	“ “ Shank.....
35648	5221	Presser Foot (tube) hinged complete, for taping, Nos. 26276, 35646 and 35647...
26276	5160	Presser Foot Hinge Pin.....
35650	—	“ “ Plate.....
35651	—	“ “ Shank.....
35652	5222	Presser Foot (tube) hinged complete, plain bottom, Nos. 26276, 35650 and 35651...

STAY GUIDE

FOR 55-22 MACHINE

NO.	PLATE	NAME
35633	5229	Stay Guide (lower).....
35634	5229	“ “ (upper).....
35635	—	Stay Guide complete, Nos. 35633 and 35634.....

STRIP FOLDER

FOR 55-2 MACHINE

NO.	PLATE	NAME
*26412	—	Strip Folder.....
18114	5227	“ “ Slide.....
26413	5227	“ “ 26412 with 18114.....
26276	5160	Presser Foot Hinge Pin.....
35618	—	“ “ Plate.....
35619	—	“ “ Shank.....
35620	5221	Presser Foot (hinged) complete, Nos. 26276, 35618 and 35619.....
35621	5220	Strip Folder on Slide 18114, for banding knit underwear.....
26276	5160	Presser Foot Hinge Pin.....
35623	—	“ “ Plate.....
35624	—	“ “ Shank.....
35625	5222	Presser Foot (hinged) complete, Nos. 26276, 35623 and 35624.....
35622	5220	Strip Folder with Guide on Slide 18114, for folding the left hand edge and hem- ming the right hand edge of strip, for harvest gloves.....

TAPE GUIDE

FOR 55-2 AND 55-12 MACHINES

NO.	PLATE	NAME
35664	5224	Edge Guide.....
35665	5224	“ “ Slide.....
35666	—	Edge Guide complete, Nos. 35664, 35665 and two 1443b.....
1443b	5224	Edge Guide Screw.....
18238	—	Face Plate.....
18027	5161	“ “ Thread Guard (lower) with 12152.....
12152	5161	Face Plate Thread Guard (lower) Rivet...
18056	5161	“ “ “ “ (upper, adjust- able).....
578F	5161	Face Plate Thread Guard (upper) Screw...
18239	5153	Face Plate complete, Nos. 18027, 18056, 18238 and two 578F.....
18198	5198	Feed Dog, for $\frac{1}{2}$ in. to $\frac{3}{4}$ in. gauges, for general work.....
26276	5160	Presser Foot Hinge Pin.....
35659	—	“ “ Plate.....
35660	5224	“ “ Roller.....
35661	5224	“ “ “ Pin.....
35662	—	“ “ Shank.....
9610	5224	“ “ Spring.....
35663	5224	Presser Foot (spring hinged) roller, com- plete, Nos. 9610, 26276 and 35659 to 35662.....
18199	5198	Throat Plate for 18198.....
35653	5223	Tape Guide.....
35654	5224	“ “ Bracket.....
35655	5224	“ “ “ Hinge Stud.....
35656	5224	“ “ Position Bracket.....
219F	5224	“ “ “ “ Screw.....
219F	5224	“ “ Screw.....
35657	5224	“ “ Spring.....
990F	5224	“ “ “ Screw.....
35658	—	Tape Guide (hinged) complete, for stitch- ing woolen lace on the edge of knit underwear, Nos. 990F, 35653 to 35657 and four 219F.....

TAPE HOLDER

(8 INCH DISC)

STRAIGHT

NO.	PLATE	NAME
26061	989	Bracket Wire with Disc.....
26062	989	Disc (adjustable) with 286D and 35925...
35925	—	" Hub.....
286D	5163	" Thumb Screw.....
26325	5234	Foot with 736D and three wood screws 1 in. No. 12.....
736D	5163	Foot Screw.....
26063	989	Tape Holder complete, Nos. 26061 and 26062.....
26065	—	Tape Holder with Foot complete, Nos. 26063 and 26325.....

TAPE HOLDER

(10 INCH DISC)

OFFSET

NO.	PLATE	NAME
26066	989	Bracket Wire.....
26067	—	Bracket Wire complete, Nos. 26066, 26068 and 26072.....
26068	989	Disc.....
26069	989	" Hub.....
26070	—	" " Rivet.....
26071	—	Disc complete, Nos. 26068, 26069 and three 26070.....
26064	5234	Foot with 736D and three wood screws 1 in. No. 12.....
736D	5163	Foot Screw.....
26072	989	Tape Guide.....
26073	1206	Tension Adjusting Collar with 286B.....
286B	5163	" " " Thumb Screw....
13211	1206	" " Spring.....
26074	989	Tape Holder complete, Nos. 13211, 26067, 26071 and 26073.....
26343	—	Tape Holder with Foot complete, Nos. 26064 and 26074.....

FOOT LIFTER

NO.	PLATE	NAME
5596	5168	Bell Crank.....
56848	—	" " 5596 with 5599 and 5601.....
5599	5168	" " Bracket.....
178E	5157	" " " Screw.....
5601	5162	" " Hinge Pin.....
5735	5162	" " Spring.....
5598	5168	Bell Crank complete, Nos. 5735 and 56848
5670	—	Chain, length 26 in. to 35 in., with 56864 and 56865.....

NOTE: When ordering No. 5670, state length required.

4879	5168	Chain Connecting Link.....
56864	5211	" Hook (large).....
56865	5211	" " (small).....
12237	5151	Lifting Lever with 448c.....
12415	5168	" " Connecting Rod.....
12416	5162	" " " " Joint.....
76D	5163	" " " " " Hinge Screw.....
1521E	5171	Lifting Lever Connecting Rod Lock Nut..
802D	5163	" " Hinge Screw.....
12241	5162	" " Link.....
766D	5172	" " " Hinge Screw.....
12240	5162	" " Pin.....
448c	5163	" " " Set Screw.....
2763	819	Rock Shaft.....
12242	819	" " Hanger with two wood screws 1 in. No. 10.....
6337	819	Rock Shaft Lifting Bracket with two 356c
12243	819	" " " " Hook.....
7125	819	" " " " " ".....
356c	3817	" " " " " Set Screw.....
356c	3817	" " " " " Set Screw.....
2770	819	" " Stop Dog with 356c.....
356c	5163	" " " " " Set Screw.....
4880	819	Rock Shaft complete, Nos. 2763, 2770, 7125, 12243 and two each 6337 and 12242.....
4881	819	Treadle.....
4882	5168	" Shaft.....
4883	5168	" Spring.....
4884	819	" Stand.....
4885	819	Treadle complete, Nos. 4879, 4881 to 4884 and two wood screws 1 in. No. 16.....

FOOT LIFTER

NO.	PLATE	NAME
20008	—	Foot Lifter complete for 55-1, 55-2, 55-11 and 55-12 Machines, Nos. 76D, 766D, 802D, 1521E, 4880, 4885, 5598, 5670, 12237, 12240, 12241, 12415, 12416 and two 178E.....
18210	—	Foot Lifter complete for 55-3 to 55-5, 55-21 and 55-22 Machines, Nos. 76D, 802D, 1521E, 4880, 4885, 5598, 5670, 12237, 12240, 12415, 12416 and two 178E.....

KNEE LIFTER PARTS

NO.	PLATE	NAME
5596	5168	Bell Crank.....
56848	—	" " 5596 with 5599 and 5601.....
5599	5168	" " Bracket.....
178E	5157	" " " Screw.....
5601	5162	" " Hinge Pin.....
5735	5162	" " Spring.....
5598	5168	Bell Crank complete, Nos. 5735 and 56848
12237	5151	Lifting Lever with 448c.....
12415	5168	" " Connecting Rod.....
12416	5162	" " " " Joint.....
76D	5163	" " " " " Hinge Screw.....
1521E	5171	Lifting Lever Connecting Rod Lock Nut..
802D	5163	" " Hinge Screw.....
12241	5162	" " Link.....
766D	5172	" " " Hinge Screw.....
12240	5162	" " Pin.....
448c	5163	" " " Set Screw.....
2763	7711	Rock Shaft.....
7539	7711	" " Hanger with two wood screws 1 in. No. 10.....
2765	7711	Rock Shaft Knee Arm.....
2766	7711	" " " " Hub with 356c....
356c	5163	" " " " " Set Screw....
2768	—	" " " " 2765 with 2766 and 2767.....
2767	7711	Rock Shaft Knee Plate with 356c.....
356c	5163	" " " " Set Screw.....
6337	7711	" " Lifting Bracket with two 356c
2778	7711	" " " " Hook.....
356c	5163	" " " " " Set Screw
356c	5163	" " " " " Set Screw....

KNEE LIFTER PARTS

NO.	PLATE	NAME
2770	7711	Rock Shaft Stop Dog with 356c.....
356c	5163	" " " " Set Screw.....
12250	7711	Rock Shaft complete, Nos. 2763, 2768, 2778, 6337 and two each 2770 and 7539
12445	—	Knee Lifter complete (power table) for 55-1, 55-2, 55-11 and 55-12 Machines, Nos. 76D, 766D, 802D, 1521E, 5598, 12237, 12240, 12241, 12250, 12415, 12416 and two 178E.....
18209	—	Knee Lifter complete (power table) for 55-3 to 55-6, 55-21 and 55-22 Machines, Nos. 76D, 802D, 1521E, 5598, 12237, 12240, 12250, 12415, 12416 and two 178E

STAND

(HIGH SPEED)

NO.	PLATE	NAME
25329	3813	Band Wheel, 16 in. diam., with 1312c....
1312c	3817	" " Set Screw.....
25421	3814	" " Shaft.....
25422	3815	" " " Driver (left).....
25423	3815	" " " " " Clutch (left).....
25424	3815	Band Wheel Shaft Driver (left) Clutch (right) with 5564.....
25425	3817	Band Wheel Shaft Driver (left) Clutch Spring.....
5564	3817	Band Wheel Shaft Driver (left) Clutch Spring Hook.....
25426	3815	Band Wheel Shaft Driver (right).....
25427	3815	" " " " " Clutch (left).....
25428	3815	Band Wheel Shaft Driver (right) Clutch (right) with 5564.....
25425	3817	Band Wheel Shaft Driver (right) Clutch Spring.....
5564	3817	Band Wheel Shaft Driver (right) Clutch Spring Hook.....
25429	3815	Band Wheel Shaft Driving Flange with 356c.....
*46604	—	Band Wheel Shaft Driving Flange (left) complete, Nos. 25422 to 25425, 25429 and 25434.....

THREAD UNWINDER

FOR ONE SPOOL

NO.	PLATE	NAME
225389	3398	Spool Rest with 201018c.....
225388	3398	" " Rod.....
200383c	5211	" " " Set Screw.....
201018c	5211	" " Set Screw.....
202490	3398	" Stand with 200383c.....
225391	3398	Thread Guide.....
201696j	5211	" " Lock Nut.....
225392	3398	" " Rod with 208E and 225393
208E	5164	" " " Screw.....
225393	5211	" " " Washer.....
225394	3398	Thread Unwinder complete, Nos. 201696j, 202490, 225388, 225391, 225392, and three wood screws $\frac{7}{8}$ in. No. 13....
27739	7234	Thread Cone (wood) for large cones.....
225390	7234	" " Holder, for inverted cones..

NOTE: Nos. 27739 and 225390 are used with,
but not included in, 225394

THREAD UNWINDER

FOR TWO SPOOLS

NO.	PLATE	NAME
225395	7233	Spool Rest with 201018c.....
225388	7233	" " Rod.....
200383c	5211	" " " Set Screw.....
201018c	5211	" " Set Screw.....
202490	7233	" Stand with 200383c.....
225391	7233	Thread Guide.....
201696j	5211	" " Lock Nut.....
225392	7233	" " Rod with 208E and 225393
208E	5164	" " " Screw.....
225393	5211	" " " Washer.....
225396	7233	Thread Unwinder complete, Nos. 201696j, 202490, 225388, 225392, 225395, two 225391 and three wood screws $\frac{7}{8}$ in. No. 13.....
27739	7234	Thread Cone (wood) for large cones.....
225390	7234	" " Holder, for inverted cones..

NOTE: Nos. 27739 and 225390 are used with,
but not included in, 225396

THREAD UNWINDER

FOR FOUR SPOOLS

NO.	PLATE	NAME
225395	8953	Spool Rest (for two spools) with 201018c
225388	8953	" " Rod.....
200383c	5211	" " " Set Screw.....
201018c	5211	" " Set Screw.....
202490	8953	" Stand with 200383c.....
225391	8953	Thread Guide.....
201696j	5211	" " Lock Nut.....
225392	8953	" " Rod with 208E and 225393
208E	5164	" " " Screw.....
225393	5211	" " " Washer.....
225398	8953	Thread Unwinder complete, Nos. 201696j, 202490, 225388, 225392, two 225395, four 225391 and three wood screws $\frac{7}{8}$ in. No. 13.....
27739	7234	Thread Cone (wood) for large cones.....
225390	7234	" " Holder, for inverted cones..

NOTE: Nos. 27739 and 225390 are used with,
but not included in, 225398

UNDER DRIVER

LEVER PRESSURE, THREE SPEED, RIGHT HAND (OIL CONTROLLING PULLEY) FOR MACHINE No. 55-6

NO.	PLATE	NAME
27508	362	Belt Guard.....
649E	5245	" " Screw.....
126321	5212	Cone Pulley (grooved) three speed, 2 $\frac{1}{2}$ in., 3 $\frac{3}{4}$ in. and 5 $\frac{1}{4}$ in. diam., with 27473
27473	1101	Cone Pulley Centre Bearing.....
27474	363	Dress Guard (right hand).....
138E	1101	" " Screw.....
126315	5212	Driving Pulley (grooved) 6 in. diam., with 27598, 50992c, 126318 and two 7958....
27598	—	Driving Pulley Friction Ring (leather)....
7958	5241	" " " Stop Pin....
126316	5210	" " Hollow Stud with 27600 and 126317.....
126317	5211	Driving Pulley Hollow Stud Oil Pad (felt)
27600	1101	" " " " Position Stud

UNDER DRIVER

NO.	PLATE	NAME
356c	3817	Driving Pulley Hollow Stud Set Screw...
27632	—	“ “ “ “ Wick.....
27633	—	“ “ “ “ “ Wire with 27632.....
126318	—	Driving Pulley Oil Pad (felt).....
50992c	5211	“ “ Screw Centre Bearing.....
7958	5241	“ “ “ “ “ Dowel Pin.....
27634	362	Frame.....
41338	362	Lever.....
27483	1101	“ Brake Spring.....
27497	1101	“ “ Strip (leather).....
12178	1101	“ Centre Plug (wood).....
427E	1101	“ “ “ Adjusting Screw.....
1508c	1101	“ “ “ “ “ Nut.....
27485	1101	“ Hinge Pin.....
27635	362	Oil Cup.....
127E	5245	“ “ Screw.....
27070	363	Shaft Driving Pulley (sectional, grooved) 10 in. diam., 1 1/8 in. bore, with two 597c
597c	5245	Shaft Driving Pulley Clamping Screw....
126036	5212	Treadle.....
126205	5212	“ Bracket (left).....
126207	5211	“ “ “ Hook.....
126208	5211	“ “ “ “ Rivet.....
23258	5211	“ “ “ “ “ Washer
126206	—	Treadle Bracket (left) complete, Nos. 23258, 126205, 126207, 126208 and two wood screws 1 in. No. 14.....
46681	5212	Treadle Bracket (right).....
60502	—	“ “ “ 46681 with two wood screws 1 in. No. 14.....
27637	362	Treadle Pitman Rod (lower).....
27638	1101	“ “ “ “ Spring.....
6055	5245	“ “ “ “ “ Washer
27639	362	“ “ “ (upper).....
9079	362	“ “ “ Clamp with 354c....
354c	1101	“ “ “ “ Screw.....
27640	362	Treadle Pitman complete, Nos. 2762, 6055, 27637 to 27639 and two 9079.....
2762	5245	Treadle Stop Collar with 362F.....
362F	5245	“ “ “ Set Screw.....
126209	—	Treadle complete, Nos. 60502, 126036 and 126206.....
126210	—	Treadle and Pitman complete, Nos. 27640 and 126209.....

UNDER DRIVER

NO.	PLATE	NAME
27644	—	Transmitter complete, Nos. 138E, 356c, 427E, 649E, 1508c, 12178, 27474, 27483, 27485, 27497, 27508, 27633 to 27635, 41338, 126315, 126316, 126321, two 127E and four wood screws 1 1/2 in. No. 16.....
27645	—	Under Driver complete, Nos. 27070, 27644 and 126210.....

OBSOLETE PARTS

NO.	PLATE	NAME
18130	5161	Arm Oil Tube with 29599, for oiling 18190, for 55-3 Machine.....
25330	3816	Band Wheel Brake (rubber) for 25418.....
25418	3814	“ “ “ Lever with 443c and 25330, for 25255.....
25419	3816	Band Wheel Brake Lever Hinge Pin for 25418.....
443c	3817	Band Wheel Brake Lever Hinge Pin Set Screw for 25418.....
25420	3816	Band Wheel Brake Lever Spring for 25418
*18132	—	Bed for 55-3 to 55-5 Machines.....
*18330	—	“ “ 55-6 Machine.....
18040	5233	“ Slide (right) with 7393.....
18091	5233	“ “ “ “ “ for 18092.....
20021	—	Drip Pan with four 1 in. wire nails, use 44212.....
18137	5167	Feed Bar with 190b, for 55-3 to 55-6 Machines, use 20913.....
190b	5171	Feed Bar Adjusting Screw for 18137 and 20913.....
18138	5169	Feed Bar Screw Centre Oil Tube with 18139, for 55-3 to 55-6 Machines.....
18139	5169	Feed Bar Screw Centre Oil Tube Packing
20918	5209	“ Dog, 14 teeth (10 teeth to the inch) for 55-5 Machine.....
18006	5190	Feed Dog for 55-2 Machine.....
18065	5182	“ “ “ 55-1 Machine.....
18087	5190	“ “ “ heavy lap seam feller, for 55-2 and 55-12 Machines.....
18305	5243	Feed Dog for 55-5 Machine.....
1057E	5172	“ Eccentric Connecting Rod Adjusting Screw for 18141.....

OBSOLETE PARTS

NO.	PLATE	NAME
28969	5241	Guide (adjustable, hinged) complete for 55-5 Machine, Nos. 2860, 940b, 7071, 28971 to 28973 and 35610, use 120428.
18115	5233	Lap Seam Feller Holder with 8505 and 18116, for 55-2 Machine.
18117	5233	Lap Seam Feller Slide, for heavy lap seam feller, for 55-2 Machine.
18150	5174	Looper with 1077F, for double thread, for 55-3 Machine, use 18220.
18220	5173	Looper with 209F and 1389F, for double thread, for 55-3 Machine, use 18299.
18151	5174	Looper with 1077F, for single thread, for 55-3 Machine, use 18221.
18221	5173	Looper with 209F and 1389F, for single thread, for 55-3 Machine, use 18300.
18220	5173	Looper (inside) with 209F and 1389F, for double thread, for 55-4 Machine, use 18299.
18221	5173	Looper (inside) with 209F and 1389F, for single thread, for 55-4 Machine, use 18300.
18220	5173	Looper (outside) with 209F and 1389F, for double thread, for 55-4 Machine, use 18299.
18221	5173	Looper (outside) with 209F and 1389F, for single thread, for 55-4 Machine, use 18300.
209F	5173	Looper Set Screw for 18220 and 18221.
1077F	5164	" " " " 18150 and 18151.
12390	5174	Looper Shaft Crank complete, Nos. 457c, 1518E, 1902 and 19496.
1902	5174	Looper Shaft Crank Roller and Screw Stud for 12390.
1518E	5155	Looper Shaft Crank Roller and Screw Stud Nut for 12390.
460c	5155	Looper Shaft Crank Set Screw for 12390 and 19447.
229D	5155	Looper Shaft Crank Slide Block Cap Screw for 19449.
18014	5233	Needle Bar (hollow) for 55-2 Machine.
18015	—	" " Connecting Stud for 18016.
18016	5174	Needle Bar Connecting Stud complete, Nos. 453c, 1904 and 18015.
18017	5233	Needle Bar Crank with 453c and 855c, for 55-2 Machine, use 18226.
18061	5233	Needle Bar Crank with 453c and 855c, for 55-12 Machine, use 18232.

OBSOLETE PARTS

NO.	PLATE	NAME
18156	5233	Needle Bar Crank and Thread Nipper Eccentric with 448c and 855c, for 55-3 Machine, use 18231.
855c	5164	Needle Bar Crank Timing Screw for 18017, 18061 and 18156.
18158	—	Needle Bar Thread Retainer Bracket complete for 55-3 Machine, and 18350 for 55-5 and 55-6 Machines, Nos. 453c, 462c, 12400, 18157, 18159 and 18160, use 18343.
18277	—	Needle Bar Thread Retainer Bracket complete for 55-1 Machine, Nos. 453c, 462c, 12400, 18157, 18159, 18278 and 21020, use 18345.
18160	5170	Needle Bar Thread Retainer Stud for 18158.
18278	5172	Needle Bar Thread Retainer Stud for 18277.
210958	5241	Needle Bar Thread Retaining Collar for 18343, 18345 and 18350.
15694	5242	Presser Foot Bracket for 18304 and 120375.
18306	5242	" " for 55-5 Machine.
18302	5242	" " (left) with 7311, for 18304.
18303	5242	" " (right) with 7311, for 18304.
120374	—	" " " " " " 120375.
8285	5180	" " Hinge Pin for 18168 and 18213.
2532	5161	Presser Foot Hinge Pin for 18257 and 18264.
18304	5242	Presser Foot (compensating) complete for 18305, Nos. 1060, 2200, 7309, 7310, 15694, 18302 and 18303.
120375	5209	Presser Foot (compensating) complete for 55-5 Machine, Nos. 1060, 2200, 7309, 7310, 15694, 18302 and 120374, use 20925.
21638	5240	Pulley (loose) for 18337, use 66085.
18074	5174	Thread (under) Take-up for 18076.
18076	—	Thread (under) Take-up Lever complete for 55-1 Machine, Nos. 18033, 18074 and two 404b.
624c	5155	Thread (under) Take-up Thread Guard Set Screw for 18008 and 18059.
18106	—	Thread (upper) Controller complete for 55-21 Machine, Nos. 2400, 18048 and 18064.

OBSOLETE PARTS

NO.	PLATE	NAME
18050	—	Thread (upper) Controller complete for 55-1 Machine, Nos. 240b, 18048 and 18049.....
18049	5174	Thread (upper) Controller Spring for 18050.....
18181	5171	Thread (upper) Nipper Plate Stud and Thread Eyelet for 55-1 Machine.....
18039	5190	Throat Plate for 18006.....
18077	5182	" " " 18065.....
18092	5190	" " " 18087.....
18109	5182	" " " 18095.....
18125	5243	" " " 18124.....
18307	5243	" " with 335b and 18149, for 18305.....

NUMERICAL
LIST
OF PARTS

NUMERICAL LIST OF PARTS

NO. PLATE	NAME
58E 5155	Feed Regulator Hinge Screw for 55-1, 55-2, 55-11, 55-12, 55-21 and 55-22 Machines
66F 5172	Slack Thread Regulator Hinge Screw for 18136 and 18274.....
74D 5164	Edge Folder Hinge Screw for 35629.....
76D 5163	Lifting Lever Connecting Rod Joint Hinge Screw for 12445, 18209, 18210 and 20008
106D 5242	Presser Foot Hinge Connection Hinge Screw for 18304, 20925 and 120375.....
123E 5164	Starting Lever Bracket Screw for 55-6 Machine.....
127E 5245	Under Driver Oil Cup Screw for 27644.....
138E 1101	" " Dress Guard Screw for 27644
144D 5163	Arm Shaft Screw for 55-1 to 55-5, 55-11, 55-12, 55-21 and 55-22 Machines.....
145E 5169	Feed Eccentric Connecting Rod Cap Screw for 18111 and 18310.....
145E 5169	Thread Nipper Connection Cap Screw for 18173.....
145E 5169	Thread (upper) Nipper Connection Cap Screw for 18173.....
158C 1206	Bed Frame Cushion Screw for 20067.....
159E 5164	Starting Lever Belt Shifter Set Screw for 18339.....
172C 5163	Feed Dog Screw.....
175F 5171	Thread Nipper Plate Stud and Thread Eyelet Set Screw for 55-5 and 55-6 Machines.....
175F 5157	Thread (upper) Controller Bracket Stud Set Screw for 55-1, 55-2, 55-11, 55-12, 55-21 and 55-22 Machines.....
175F 5171	Thread (upper) Nipper Plate Stud and Thread Eyelet Set Screw for 55-3 and 55-4 Machines.....
176D 5211	Feed Bar Adjusting Screw for 20913.....
178E 5157	Bell Crank Bracket Screw for 12445, 18209, 18210 and 20008.....
178C 5157	Thread (under) Take-up Crank Cap Screw for 18035.....
184E 5241	Guide Screw Stud for 55-5 Machine.....
190D 5171	Face Plate Screw.....
190D 5171	Feed Bar Adjusting Screw for 18137 and 20913, obsolete.....

NUMERICAL LIST OF PARTS

NO. PLATE	NAME
190D 5171	Guide Adjusting Screw for 55-5 Machine
190D 5171	" Screw for 55-3 and 55-4 Machines
190D 5171	Oil Cup Screw for 55-21 and 55-22 Machines.....
190D 5171	Presser Foot Screw.....
190D 5171	Thread (under) Take-up Eyelet Screw for 55-3 and 55-4 Machines.....
191C 5171	Thread (under) Eyelet Screw for 55-3 and 55-4 Machines.....
196J 5809	Finger Guard Holder Clamping Screw for 36820.....
198D 5163	Looper Screw for 18201.....
207F 5157	Folder Holder Seat Cover Screw for 55-1, 55-2, 55-11 and 55-12 Machines.....
207F 5228	Lap Seam Feller Holder Screw for 18118
207F 5157	Thread (arm) Cover Screw (upper) for 55-1, 55-2, 55-11, 55-12, 55-21 and 55-22 Machines.....
207F 5157	Thread (upper) Controller Bracket Screw for 55-1, 55-2, 55-11, 55-12, 55-21 and 55-22 Machines.....
208E 5164	Thread Unwinder Thread Guide Rod Screw for 225392.....
209F 5173	Looper Set Screw for 18220 and 18221, obsolete.....
209F 5156	Needle Set Screw for 18052, 18099 and 18161.....
211F 1206	Bed Frame Hinge Connection Cap Screw for 19398.....
217D 5164	Belt Cover Screw for 55-6 Machine.....
219D 5163	Arm Side Cap Screw.....
219F 5172	Slack Thread Regulator Adjusting Bracket Screw for 18094, 18136 and 18274.....
219F 5224	Tape Guide Position Bracket Screw for 35658.....
219F 5224	Tape Guide Screw for 35658.....
220D 5242	Presser Foot Cap Screw for 18304, 20925 and 120375.....
226D 5211	Looper Shaft Crank Slide Block Cap Screw for 19449.....
229D 5155	Looper Shaft Crank Slide Block Cap Screw for 19449, obsolete.....
236J 5211	Finger Guard Screw for 120498.....
240D 5157	Bed Slide (left) Spring Screw for 18043 and 18237.....
240D 5157	Thread (upper) Controller Spring Screw for 18050, 18063 and 18106.....

NUMERICAL LIST OF PARTS

NO. PLATE	NAME
248A 5163	Clamp Stop Motion Clamp Stop Screw for 3022.....
256J 5154	Clamp Stop Motion Clamp Screw for 3022
286D 5163	Arm Side Cover Thumb Screw.....
286D 5163	Face Plate Thumb Screw.....
286D 5163	Guide Thumb Screw for 28969, 120373, 120428 and 120439.....
286D 5163	Tape Holder Disc Thumb Screw for 26062
286B 5163	" " Tension Adjusting Collar Thumb Screw for 26073.....
297C 3826	Band Wheel Crank Screw Centre for 46629
297C 3826	Treadle Screw Centre for 46629.....
307C 5163	Feed Rock Shaft Screw Centre.....
313C 5163	" Bar Screw Centre.....
335D 5176	Loop Retainer Screw for 18194, 18214, 18217, 18219, 18287, 18290, 18293, 18307, 18342, 20917 and 120376.....
354C 5164	Treadle Pitman Rod Clamp Screw for 9079
354C 1101	Under Driver Treadle Pitman Rod Clamp Screw for 9079.....
356C 3817	Band Wheel Shaft Driving Flange Set Screw for 25429.....
356C 3817	Rock Shaft Lifting Bracket Hook Set Screw for 6337.....
356C 3817	Rock Shaft Lifting Bracket Set Screw for 6337.....
356C 5163	Rock Shaft Knee Arm Hub Set Screw for 2766.....
356C 5163	Rock Shaft Knee Plate Set Screw for 2767
356C 5163	" " Stop Dog Set Screw for 2770
356C 3817	Under Driver Driving Pulley Hollow Stud Set Screw for 27644.....
362F 5245	Under Driver Treadle Stop Collar Set Screw for 2762.....
372C 5156	Needle Bar Connecting Link Hinge Screw for 55-1, 55-2, 55-11, 55-12, 55-21 and 55-22 Machines.....
375C 5155	Feed Connecting Link Hinge Screw for 55-1, 55-2, 55-11, 55-12, 55-21 and 55-22 Machines.....
375C 5155	Feed Forked Connection Hinge Screw for 55-1, 55-2, 55-11, 55-12, 55-21 and 55-22 Machines.....
389F 5169	Feed Eccentric Connecting Rod Stud Cap Screw for 55-3 to 55-6 Machines.....
399F 5245	Starting Lever Cushion Screw for 18339..

NO. PLATE	NAME
404D 5157	Thread (under) Take-up Screw for 18057, 18076 and 18107.....
405E 5163	Thread (arm) Cover Screw (lower) for 18026 and 18229.....
427E 1101	Under Driver Lever Centre Plug Adjusting Screw for 27644.....
430c 5170	Thread Take-up Lever Hinge Pin Set Screw for 55-5 and 55-6 Machines.....
430c 5170	Thread (upper) Take-up Lever Hinge Pin Set Screw for 55-3 and 55-4 Machines..
435c 3817	Driving Arm Hinge Pin Set Screw for 25431 and 25432.....
443c 3817	Band Wheel Brake Lever Hinge Pin Set Screw for 25418, obsolete.....
446c 5163	Feed Eccentric Set Screw for 5570.....
446c 5169	" Lifting Eccentric Set Screw for 18142
448c 5163	Arm Shaft Flanged Bushing Set Screw...
448c 5163	Balance Wheel Set Screw for 4370, 4388 and 12358.....
448c 5163	Feed Eccentric Set Screw for 18309.....
448c 5163	Lifting Lever Pin Set Screw for 12237...
448c 5163	Needle Bar Crank and Thread Nipper Eccentric Set Screw for 18156 and 18231
448c 5163	Oscillating Rock Shaft Hinge Pin Set Screw.....
453c 5156	Needle Bar Connecting Stud Set Screw for 12384 and 18016.....
453c 5156	Needle Bar Crank Set Screw for 18017, 18061, 18226 and 18232.....
453c 5170	Needle Bar Thread Retainer Bracket Set Screw for 18158, 18277, 18343, 18345 and 18350.....
453c 5156	Presser Bar Spring Bracket Set Screw for 11168.....
453c 5171	Thread (under) Take-up Body Set Screw for 18185.....
453c 5156	Thread (upper) Take-up Set Screw for 18038 and 18075.....
457c 5164	Looper Shaft Crank Set Screw for 12390 and 19447.....
457c 5164	Thread (under) Take-up Thread Guard Set Screw for 18008 and 18059.....
460c 5155	Looper Shaft Crank Set Screw for 12390 and 19447, obsolete.....
462c 5155	Clamp Stop Motion Flanged Bushing Set Screw for 4933.....
462c 5155	Feed Rock Shaft Crank Set Screw for 3043

NO. PLATE	NAME
462c 5170	Needle Bar Thread Retaining Stud Set Screw for 18158, 18277, 18343, 18345 and 18350.....
534E 3817	Driving Segment Bolt with 1510E, for 25255.....
564c 5164	Starting Lever Screw Centre for 55-6 Machine.....
578F 5161	Face Plate Thread Guard (upper) Screw for 18004 and 18239.....
597c 5245	Under Driver Shaft Driving Pulley Clamping Screw for 27070.....
624c 5155	Feed Lifting Eccentric Set Screw for 18007 and 18058.....
624c 5164	Pulley (tight) Set Screw for 18335.....
624c 5155	Thread (under) Take-up Lever Hinge Pin Set Screw for 55-1, 55-2, 55-11, 55-12, 55-21 and 55-22 Machines.....
624c 5155	Thread (under) Take-up Thread Guard Set Screw for 18008 and 18059, obsolete
637c 5161	Tension Screw Stud for 55-1, 55-2, 55-11, 55-12, 55-21 and 55-22 Machines.....
649E 5245	Under Driver Belt Guard Screw for 27644
686E 5171	Tension (under thread) Screw Stud for 55-3 and 55-4 Machines.....
688J 5163	Pressure Regulating Thumb Screw.....
689c 5156	Presser Bar Lifter Screw.....
690E 5170	Thread Take-up Crank Wedge Screw for 55-5 and 55-6 Machines.....
690E 5170	Thread (upper) Take-up Crank Wedge Screw for 55-3 and 55-4 Machines.....
691F 5163	Bed Cover Screw for 55-21 and 55-22 Machines.....
691F 5163	Cloth Plate Screw for 55-3 to 55-6 Machines.....
691F 5163	Thread (bed) Cover Screw for 55-1, 55-2, 55-11, 55-12, 55-21 and 55-22 Machines
691F 5163	Throat Plate Screw for 55-1, 55-2, 55-11, 55-12 and 55-22 Machines.....
697c 5169	Feed Eccentric Connecting Rod Stud for 55-3 to 55-6 Machines.....
736D 5163	Tape Holder Foot Screw for 26064 and 26325.....
742F 5171	Throat Plate Screw for 55-3 to 55-6 and 55-21 Machines.....
748E 5163	Arm Screw (back).....
748E 3826	Brace Screw for 25255, 25265, 25279 and 25284.....

NO. PLATE	NAME
766D 5172	Lifting Lever Link Hinge Screw for 12445 and 20008.....
766D 5172	Slack Thread Regulator Link Hinge Screw for 55-3 to 55-6, 55-21 and 55-22 Machines.....
775E 5170	Thread Take-up Lever Link Cap Screw for 55-5 and 55-6 Machines.....
775E 5170	Thread (upper) Take-up Lever Link Cap Screw for 55-3 and 55-4 Machines.....
790C 5169	Feed Rock Shaft Regulator Crank Position Screw for 18146.....
794E 5170	Needle Bar Connecting Link Adjusting Screw for 18155.....
802D 5163	Lifting Lever Hinge Screw for 12445, 18209, 18210 and 20008.....
803C 5164	Starting Lever Stop Screw for 18339.....
818D 5155	Feed Regulator Thumb Screw for 55-1, 55-2, 55-11, 55-12, 55-21 and 55-22 Machines.....
854E 5163	Arm Screw (front).....
855C 5164	Needle Bar Crank Timing Screw for 18017, 18061 and 18156, obsolete.....
871E 5164	Belt Cover Bracket Screw Stud for 18331
871E 5164	Stop Cam Spring Stop Screw for 18336..
878J 5163	Oscillating Rock Shaft Hinge Pin Oil Hole Stop Screw.....
880E 5164	Brace Section Screw for 46662.....
889C 5180	Presser Foot Spring Adjusting Screw for 18168, 18213 and 18282.....
894F 5161	Tension Bracket Screw for 55-1, 55-2, 55-11, 55-12, 55-21 and 55-22 Machines.....
896E 5163	Crank Connecting Rod Cap Screw for 20197.....
896E 5163	Feed Eccentric Connecting Rod Adjusting Screw for 18141.....
908C 5163	Crank Connecting Rod Hinge Screw.....
913C 5164	Stop Cam Interlocking Rod Spring Regulating Thumb Screw for 18339.....
924F 5156	Needle Clamp Thread Nipper Screw for 18018 and 18100.....
936D 5163	Needle Bar Screw Bushing.....
940D 5160	Guide Holder Hinge Screw for 28969, 120373, 120428 and 120439.....
940F 5160	Slack Thread Regulator Hinge Screw for 18094.....
972C 3826	Band Wheel Set Screw for 25301.....

NO. PLATE	NAME
988C 5155	Looper Shaft Crank Slide Block Screw Stud for 19449.....
990F 5224	Tape Guide Spring Screw for 35658.....
997D 5164	Stop Cam Spring Cover Screw for 18336
1014E 5172	Bed Oil Hole Cover Hinge Screw for 55-3 to 55-6 Machines.....
1015C 5169	Feed Bar Hinge Screw for 55-3 to 55-6 Machines.....
1016C 5171	Tension Screw Stud for 55-5 and 55-6 Machines.....
1016C 5171	Tension (upper thread) Screw Stud for 55-3 and 55-4 Machines.....
1057E 5172	Feed Eccentric Connecting Rod Adjusting Screw for 18141, obsolete.....
1065C 5163	Needle Bar Crank and Thread Nipper Eccentric Position Screw for 18231.....
1065C 5163	Needle Bar Crank Position Screw for 18226 and 18232.....
1069D 5164	Arm Shaft Screw for 55-6 Machine.....
1070C 5245	Stop Cam Interlocking Rod Guide Set Screw for 18341.....
1076C 5158	Looper Set Screw for 18011, 18012, 18066, 18097, 18119, 18120, 18202 and 18203..
1077E 5164	Looper Set Screw for 18150 and 18151, obsolete.....
1120F 5173	Looper Set Screw for 18299 and 18300.....
1147C 5169	Feed Rock Shaft Regulator Crank Set Screw for 18146.....
1312C 3817	Band Wheel Set Screw for 25329.....
1389F 5173	Looper Position Screw for 18220, 18221, 18299 and 18300.....
1443D 5224	Tape Guide Edge Guide Screw for 35666
1507J 3826	Band Wheel Crank Screw Centre Nut for 46629.....
1507J 3826	Treadle Screw Centre Nut for 46629.....
1508E 3817	Leg Stay Rod Nut for 25255.....
1508E 5164	Starting Lever Screw Centre Nut for 55-6 Machine.....
1508C 1101	Under Driver Lever Centre Plug Adjusting Screw Nut for 27644.....
1510E 3817	Driving Segment Bolt Nut for 534.....
1513J 5164	Feed Rock Shaft Screw Centre Nut.....
1518E 5169	" Bar Hinge Screw Nut for 55-3 to 55-6 Machines.....
1518E 5155	Feed Connecting Link Hinge Screw Nut for 55-1, 55-2, 55-11, 55-12, 55-21 and 55-22 Machines.....

NO.	PLATE	NAME
1518E	5169	Feed Eccentric Connecting Rod Stud Nut for 55-3 to 55-6 Machines.....
1518E	5155	Feed Forked Connection Hinge Screw Nut for 55-1, 55-2, 55-11, 55-12, 55-21 and 55-22 Machines.....
1518E	5155	Looper Shaft Crank Roller and Screw Stud Nut for 12390, obsolete.....
1518E	5155	Looper Shaft Crank Slide Block Screw Stud Nut for 19447.....
1518E	5155	Needle Bar Connecting Link Hinge Screw Nut for 55-1, 55-2, 55-11, 55-12, 55-21 and 55-22 Machines.....
1519E	5164	Feed Bar Screw Centre Nut.....
1520R	3826	Pitman Rod Lock Nut for 46520.....
1520R	3826	“ “ (upper) Lock Nut for 46656.....
1520E	5156	Presser Bar Lifter Screw Nut.....
1520E	5164	Starting Lever Stop Screw Nut for 18339.....
1521E	5171	Lifting Lever Connecting Rod Lock Nut for 12445, 18209, 18210 and 20008.....
1521E	5172	Slack Thread Regulator Hinge Screw Nut for 18136 and 18274.....
1521c	5171	Thread Nipper Regulating Nut for 55-5 and 55-6 Machines.....
1521c	5171	Thread Nipper Regulating Nut Lock Nut for 55-5 and 55-6 Machines.....
1521c	5171	Thread (upper) Nipper Regulating Nut for 55-3 and 55-4 Machines.....
1521c	5171	Thread (upper) Nipper Regulating Nut Lock Nut for 55-3 and 55-4 Machines.....
1547D	5161	Tension Screw Stud Nut for 55-1, 55-2, 55-11, 55-12, 55-21 and 55-22 Machines.....
1560c	5161	Tension Regulating Thumb Nut for 55-1, 55-2, 55-5, 55-6, 55-11, 55-12, 55-21 and 55-22 Machines.....
1560c	5161	Tension (under thread) Regulating Thumb Nut for 55-3 and 55-4 Machines.....
1560c	5161	Tension (upper thread) Regulating Thumb Nut for 55-3 and 55-4 Machines.....
1619E	5164	Crank Connecting Rod Hinge Screw Nut
1638E	5164	Stop Cam Interlocking Rod Spring Regulating Thumb Screw Nut for 18339.....
1670E	3826	Pitman Rod Ball Screw Bearing Nut for 46630.....
1670E	3826	Pitman Rod (lower) Ball Screw Bearing Nut for 46630.....
1820	5157	Thread (under) Take-up Crank Roller and Stud for 18035.....

NO.	PLATE	NAME
1902	5174	Looper Shaft Crank Roller and Screw Stud for 12390, obsolete.....
1904	5156	Needle Bar Connecting Stud Roller (roller only) for 12384 and 18016.....
1919	5172	Slack Thread Regulator Link Roller and Stud for 18111.....
2018	5169	Feed Eccentric Connecting Rod Stud Nut Washer for 55-3 to 55-6 Machines.....
2020	5154	Clamp Stop Motion Clamp Washer for 3022.....
2022	5161	Clamp Stop Motion Flanged Bushing Pin for 55-1 to 55-4, 55-11, 55-12, 55-21 and 55-22 Machines.....
2049	5155	Feed Rock Shaft Crank Pin for 55-1, 55-2, 55-11, 55-12, 55-21 and 55-22 Machines.....
2049	5155	Looper Shaft Crank Pin.....
2062	5156	Presser Bar Lifter.....
2102	5161	Tension Disc for 55-1, 55-2, 55-11, 55-12, 55-21 and 55-22 Machines.....
2102	5161	Tension (under thread) Disc for 55-3 and 55-4 Machines.....
2103	5161	Tension Spring (needle thread) for 55-1, 55-2, 55-11, 55-12, 55-21 and 55-22 Machines.....
2135	5150	Balance Wheel (stand) heavy rim, 2½ in. pulley, for 3022, for 55-1 to 55-4, 55-11, 55-12, 55-21 and 55-22 Machines.....
2273	5156	Needle Clamp Pin.....
2532	5161	Presser Foot Hinge Pin for 18257 and 18264, obsolete.....
2532	5171	Thread Nipper Connection Rod Dowel Pin for 18173.....
2532	5171	Thread (upper) Nipper Connection Rod Dowel Pin for 18173.....
2762	5245	Under Driver Treadle Stop Collar with 362F, for 27640.....
2763	819	Rock Shaft for 4880 and 12250.....
Nos. 2765 to 2767 for 2768		
2765	7711	Rock Shaft Knee Arm.....
2766	7711	“ “ “ “ Hub with 356c.....
2767	7711	“ “ “ “ Plate with 356c.....
2768	—	“ “ “ “ Arm 2765 with 2766 and 2767, for 12250.....
2770	819	Rock Shaft Stop Dog with 356c, for 4880 and 12250.....
2778	7711	Rock Shaft Lifting Bracket Hook for 12250.....

NO.	PLATE	NAME
2862	5150	Balance Wheel (stand) heavy rim, 3 in. pulley, for 3022, for 55-1 to 55-4, 55-11, 55-12, 55-21 and 55-22 Machines.....
2921	5171	Tension Disc for 55-5 and 55-6 Machines
2921	5171	Tension (upper thread) Disc for 55-3 and 55-4 Machines.....
3022	—	Clamp Stop Motion complete for 55-1 to 55-4, 55-11, 55-12, 55-21 and 55-22 Machines, Nos. 248A, 256A, 2020 and 4933.....
*3023	—	Clamp Stop Motion Flanged Bushing for 4933.....
3033	5155	Feed Connecting Link for 55-1, 55-2, 55-11, 55-12, 55-21 and 55-22 Machines.....
3039	5155	Feed Regulator for 55-1, 55-2, 55-11, 55-12, 55-21 and 55-22 Machines.....
3043	5155	Feed Rock Shaft Crank with 462c, for 18010.....
3094	5170	Thread Take-up Crank Wedge for 55-5 and 55-6 Machines.....
3094	5170	Thread (upper) Take-up Crank Wedge for 55-3 and 55-4 Machines.....
4307	5153	Bed Slide (left) Spring for 18043 and 18237
4370	5150	Balance Wheel (stand) heavy rim, 2 $\frac{3}{4}$ in. pulley, with two 448c, for 55-1 to 55-4, 55-11, 55-12, 55-21 and 55-22 Machines
4388	5150	Balance Wheel (power) light rim, 2 $\frac{3}{4}$ in. pulley, with two 448c, for 55-3 to 55-5 Machines.....
4784	5161	Oscillating Rock Shaft Oil Pad for 18163 and 18333.....
4822	5234	Wrench for 1521 and 1547 (Accessories)...
4879	5168	Chain Connecting Link for 4885.....
4880	819	Rock Shaft complete for 18210 and 20008, Nos. 2763, 2770, 7125, 12243 and two each 6337 and 12242.....
		Nos. 4881 to 4884 for 4885
4881	819	Treadle.....
4882	5168	“ Shaft.....
4883	5168	“ Spring.....
4884	819	“ Stand.....
4885	819	Treadle complete for 18210 and 20008, Nos. 4879, 4881 to 4884 and two wood screws 1 in. No. 16.....
4933	5154	Clamp Stop Motion Flanged Bushing 3023 with two 462c, for 3022.....

NO.	PLATE	NAME
5564	3817	Band Wheel Shaft Driver (left) Clutch Spring Hook for 25424.....
5564	3817	Band Wheel Shaft Driver (right) Clutch Spring Hook for 25428.....
5570	5152	Feed Eccentric with 446c, for 55-1 to 55-4, 55-6, 55-11, 55-12, 55-21 and 55-22 Machines.....
5596	5168	Bell Crank for 56848.....
5598	5168	Bell Crank complete for 12445, 18209, 18210 and 20008, Nos. 5735 and 56848
5599	5168	Bell Crank Bracket for 56848.....
5601	5162	“ “ Hinge Pin for 56848.....
5670	—	Chain, length 26 in. to 35 in., with 56864 and 56865, for 18210 and 20008.....
5735	5162	Bell Crank Spring for 5598.....
6055	5245	Under Driver Treadle Pitman Rod (lower) Spring Washer for 27640.....
6337	819	Rock Shaft Lifting Bracket with two 356c, for 4880 and 12250.....
7071	5241	Guide Adjusting Screw Washer for 55-5 Machine.....
7071	5241	Guide Thumb Screw Washer for 28969, 120373, 120428 and 120439.....
7125	819	Rock Shaft Lifting Bracket Hook for 4880
7309	5242	Presser Foot Cap for 18304, 20925 and 120375.....
7310	5242	Presser Foot Hinge Connection for 18304, 20925 and 120375.....
7311	5242	Presser Foot Hinge Connection Pin for 18302, 18303, 20923 and 120374.....
7393	5160	Bed Slide (right) Stop Pin for 18040, 18091 and 18110.....
7539	7711	Rock Shaft Hanger with two wood screws 1 in. No. 10, for 12250.....
7958	5241	Motor Pitman Pin for 25279.....
7958	5241	Under Driver Driving Pulley Friction Ring Stop Pin for 126315.....
7958	5241	Under Driver Driving Pulley Screw Centre Bearing Dowel Pin for 126315.....
8238	5161	Tension Spring for 55-5 and 55-6 Machines
8238	5161	“ “ (looper thread) for 55-1, 55-2, 55-11, 55-12, 55-21 and 55-22 Machines.....
8238	5161	Tension (upper thread) Spring for 55-3 and 55-4 Machines.....
8285	5180	Presser Foot Hinge Pin for 18168 and 18213, obsolete.....

NO.	PLATE	NAME
8505	5228	Lap Seam Feller Folder Slide Spring Rivet for 18115 and 18118.....
8582	5161	Arm Dowel Pin.....
8582	5161	Starting Lever Bracket Dowel Pin for 55-6 Machine.....
8908	5234	Wrench for 1519 and 1520 (Accessories)....
8909	5234	“ “ 1513 and 1518 (Accessories)....
9079	5244	Treadle Pitman Rod Clamp with 354c, for 67177.....
9079	362	Under Driver Treadle Pitman Rod Clamp with 354c, for 27640.....
9525	5171	Thread (under) Eyelet Screw Washer for 55-3 and 55-4 Machines.....
9610	5224	Presser Foot Spring for 35663.....
10148	5171	Tension (under thread) Spring for 55-3 and 55-4 Machines.....
10875	5234	Wrench for 46660 for 25284.....
*11104	—	Arm Shaft Bushing (front) for 18001, 18129, 18272 and 18327.....
11119	5170	Arm Oil Tube with 29599, for oiling 18190 and 18231, for 55-3 to 55-6 Machines...
*11136	—	Feed Eccentric Connecting Rod Cap for 18141.....
11137	5169	Feed Eccentric Connecting Rod Stud Cap Screw Washer for 55-3 to 55-6 Machines
11167	5152	Presser Bar Spring for 55-5 Machine.....
11167	5152	“ “ “ (light) for 55-1 to 55-4, 55-11, 55-12, 55-21 and 55-22 Machines
11168	5156	Presser Bar Spring Bracket with 453c....
11170	5156	“ “ “ Washer.....
11204	5170	Thread Take-up Lever Hinge Pin for 55-5 and 55-6 Machines.....
11204	5170	Thread (upper) Take-up Lever Hinge Pin for 55-3 and 55-4 Machines.....
12139	5152	Presser Bar Spring (medium) for 55-1 to 55-4, 55-11, 55-12, 55-21 and 55-22 Machines.....
12152	5161	Face Plate Thread Guard (lower) Rivet for 18027.....
12152	5161	Face Plate Thread Guard Rivet for 18027
12178	1101	Under Driver Lever Centre Plug (wood) for 27644.....
12193	5153	Arm Side Cover.....
12237	5151	Lifting Lever with 448c, for 12445, 18209, 18210 and 20008.....
12240	5162	Lifting Lever Pin for 12445, 18209, 18210 and 20008.....

NO.	PLATE	NAME
12241	5162	Lifting Lever Link for 12445 and 20008..
12242	819	Rock Shaft Hanger with two wood screws 1 in. No. 10, for 4880.....
12243	819	Rock Shaft Lifting Bracket Hook for 4880
12250	7711	Rock Shaft complete for 12445 and 18209, Nos. 2763, 2768, 2778, 6337 and two each 2770 and 7539.....
12357	5154	Arm Shaft Flanged Bushing (back) for 55-1 to 55-5, 55-11, 55-12, 55-21 and 55-22 Machines.....
12358	5150	Balance Wheel (power) light rim, 2 ³ / ₈ in. pulley, with two 448c. for 55-1, 55-2, 55-11, 55-12, 55-21 and 55-22 Machines
12361	5162	Machine Hinge Connection for 44140....
*12383	—	Needle Bar Connecting Stud for 12384...
12384	5156	Needle Bar Connecting Stud complete for 18301 and 55-1, 55-2, 55-11, 55-12, 55-21 and 55-22 Machines, Nos. 453c, 1904 and 12383.....
12388	5152	Oscillating Rock Shaft Hinge Pin for 18163
12390	5174	Looper Shaft Crank complete, Nos. 457c, 1518E, 1902 and 19496, obsolete.....
12391	5152	Presser Bar (hollow) for 55-1, 55-2, 55-11, 55-12, 55-21 and 55-22 Machines.....
12400	5170	Needle Bar Thread Retainer Sleeve for 18158, 18277, 18343, 18345 and 18350..
12405	5162	Machine Rest, felt (Accessories).....
12415	5168	Lifting Lever Connecting Rod for 12445, 18209, 18210 and 20008.....
12416	5162	Lifting Lever Connecting Rod Joint for 12445, 18209, 18210 and 20008.....
12424	5155	Looper Shaft Crank Slide Block Cap Screw Washer for 19449.....
12429	5152	Feed Forked Connection for 55-1, 55-2, 55-11, 55-12, 55-21 and 55-22 Machines
12445	—	Knee Lifter complete (power table) for 55-1, 55-2, 55-11 and 55-12 Machines, Nos. 76D, 766D, 802D, 1521E, 5598, 12237, 12240, 12241, 12250, 12415, 12416 and two 178E.....
12453	5161	Arm Oil Tube, for intermediate bearing...
12454	5161	“ “ “ with 29599, for oiling 5570 and 18189.....
12459	5161	Oscillating Rock Shaft Hinge Pin Oil Hole Stop Screw Washer (leather).....
12480	5153	Arm Side Cap.....

NO.	PLATE	NAME
13211	1206	Tape Holder Tension Adjusting Spring for 26074.....
13550	5160	Tension (under thread) Separating Disc for 55-4 Machine.....
13550	5160	Thread (upper) Nipper Separating Disc for 55-4 Machine.....
13589	5171	Tension Disc Steady Pin for 18180.....
13589	5171	" (upper thread) Disc Steady Pin for 18180.....
14010	1206	Bed Frame Hinge Plate Rivet for 20067..
14026	5161	Thread (bed) Cover Pin for 18026 and 18229.....
14058	5156	Presser Foot Spring for 18082.....
14174	5240	Starting Lever Spring for 55-6 Machine...
14260	5245	" " Belt Shifter for 18339.....
14263	5240	Stop Cam with 21652, for 18336.....
14277	5241	" " Interlocking Rod Guide Washer (rawhide) for 18339.....
15694	5242	Presser Foot Bracket for 18304 and 120375, obsolete.....
16555	1206	Bed Frame Hinge Plate for 20067.....
*18001	—	Arm with 14104, for 55-1, 55-2, 55-11, 55-12, 55-21 and 55-22 Machines.....
18002	5151	Arm Shaft for 55-1, 55-2, 55-11, 55-12, 55-21 and 55-22 Machines.....
*18003	—	Bed for 55-1, 55-2, 55-11 and 55-12 Machines.....
18004	5153	Face Plate complete for 55-1, 55-2, 55-11 and 55-12 Machines, Nos. 18027, 18051, 18056 and two 578e.....
18005	5152	Feed Bar for 55-1, 55-2, 55-11, 55-12, 55-21 and 55-22 Machines.....
18006	5190	Feed Dog for 55-2 Machine, obsolete.....
18007	5155	" Lifting Eccentric with two 624c, for 18008.....
18008	—	Feed Lifting Eccentric 18007 with 457c and 18037, for 55-1, 55-2, 55-21 and 55-22 Machines.....
18009	5151	Feed Rock Shaft for 18010.....
18010	—	Feed Rock Shaft complete for 55-1, 55-2, 55-11, 55-12, 55-21 and 55-22 Machines, Nos. 3043 and 18009.....
18011	5159	Looper (inside) with 1076c, for $\frac{13}{16}$ in. gauge and above, for 55-2, 55-12 and 55-22 Machines.....

NO.	PLATE	NAME
18012	5159	Looper (outside) with 1076c, for $\frac{13}{16}$ in. gauge and above, for 55-2, 55-12 and 55-22 Machines.....
18013	5151	Looper Shaft for 55-22 Machine.....
18014	5233	Needle Bar (hollow) for 55-2 Machine, obsolete.....
18015	—	Needle Bar Connecting Stud for 18016, obsolete.....
18016	5174	Needle Bar Connecting Stud complete, Nos. 453c, 1904 and 18015, obsolete...
18017	5233	Needle Bar Crank with 453c and 855c, for 55-2 Machine, obsolete, use 18226..
18018	5156	Needle Clamp complete for 55-2, 55-12 and 55-22 Machines, Nos. 924e and 18052 to 18054.....
18019	—	Presser Foot Plate for 18021.....
18020	—	" " Shank for 18021.....
18021	5213	Presser Foot (hinged) complete for 55-2, 55-12 and 55-22 Machines, Nos. 18019, 18020 and 18055.....
18022	5154	Tension Bracket for 55-2, 55-12 and 55-22 Machines.....
18023	5161	Tension Bracket Screw Collar for 55-1, 55-2, 55-11, 55-12, 55-21 and 55-22 Machines.....
18024	5154	Thread (arm) Cover for 18026 and 18229
18025	5154	" (bed) Cover for 18026.....
18026	—	Thread Cover complete for 55-1, 55-2, 55-11 and 55-12 Machines, Nos. 14026, 18024, 18025, 18044 and two each 405e and 23227.....
18027	5161	Face Plate Thread Guard (lower) with 12152, for 18004 and 18239.....
18027	5161	Face Plate Thread Guard with 12152, for 18094.....
18028	—	Thread Eyelet (triangular, top of arm) for 18046.....
18030	5157	Thread (upper) Controller Bracket Stud for 55-1, 55-2, 55-11, 55-12, 55-21 and 55-22 Machines.....
18032	5157	Thread (under) Take-up for 18057.....
18033	5157	" " " Lever (forked) for 18057, 18076 and 18107.....
18034	5157	Thread (under) Take-up Lever Hinge Pin for 55-1, 55-2, 55-11, 55-12, 55-21 and 55-22 Machines.....

NO.	PLATE	NAME
18035	5157	Thread (under) Take-up Crank with 1820, 18036 and two 178c, for 55-1, 55-2, 55-11, 55-12, 55-21 and 55-22 Machines
*18036	—	Thread (under) Take-up Crank Cap for 18035.....
18037	5155	Thread (under) Take-up Thread Guard for 18008 and 18059.....
18038	5157	Thread (upper) Take-up with 453c, for 55-2, 55-12 and 55-22 Machines.....
18039	5190	Throat Plate for 18006, obsolete.....
18040	5233	Bed Slide (right) with 7393, obsolete.....
18041	5160	" " " Spring for 18026.....
18042	—	" " (left) for 18043.....
18043	5153	Bed Slide (left) complete for 55-1, 55-2, 55-11 and 55-12 Machines, Nos. 4307, 18042 and two 240b.....
18045	5154	Tension Bracket for 55-1, 55-11 and 55-21 Machines.....
18046	5154	Thread Eyelet 18028 with 18047, for 55-2, 55-12 and 55-22 Machines.....
18047	5162	Thread Eyelet Stud for 18046 and 18073
18048	5157	" (upper) Controller Bracket for 18050, 18063 and 18106.....
18049	5174	Thread (upper) Controller Spring for 18050, obsolete.....
18050	—	Thread (upper) Controller complete for 55-1 Machine, Nos. 240b, 18048 and 18049, obsolete.....
18051	—	Face Plate for 18004.....
18052	5172	Needle Clamp with two 209e, for 55-4 Machine.....
18052	5172	Needle Clamp Body with two 209e, for 18018.....
18053	5156	Needle Clamp Thread Nipper for 18018..
18054	5156	" " " " Spring for 18018 and 18100.....
18055	5161	Presser Foot Hinge Pin for 18021, 18071, 18082, 18086, 18122, 18127 and 18197..
18056	5161	Face Plate Thread Guard (upper, adjustable) for 18004 and 18239.....
18057	—	Thread (under) Take-up Lever complete for 55-2, 55-12 and 55-22 Machines, Nos. 18032, 18033 and two 404b.....
18058	5156	Feed Lifting Eccentric with two 624c, for 18059.....
18059	—	Feed Lifting Eccentric 18058 with 457c and 18037, for 55-11 and 55-12 Machines

NO.	PLATE	NAME
18060	5156	Needle Bar Connecting Link for 55-1, 55-2, 55-11, 55-12, 55-21 and 55-22 Machines
18061	5233	Needle Bar Crank with 453c and 855c, for 55-12 Machine, obsolete, use 18232
18062	5157	Thread (upper) Controller Spring (inside) for 18063.....
18063	—	Thread (upper) Controller complete for 55-1, 55-2, 55-11, 55-12, 55-21 and 55-22 Machines, Nos. 240b, 18048, 18062 and 18064.....
18064	5157	Thread (upper) Controller Spring (outside) for 18063 and 18106.....
18065	5182	Feed Dog for 55-1 Machine, obsolete.....
18066	5158	Looper with 1076c, for 55-1 and 55-11 Machines.....
18067	5151	Looper Shaft for 55-1, 55-11 and 55-21 Machines.....
18069	5156	Needle Clamp Thread Nipper for 18100..
18070	—	Presser Foot Plate for 18071.....
18071	5188	Presser Foot (hinged) complete for 55-1 and 55-11 Machines, Nos. 18055, 18070 and 18128.....
18072	—	Thread Eyelet (triangular, top of arm) for 18073.....
18073	5154	Thread Eyelet 18072 with 18047, for 55-1, 55-11 and 55-21 Machines.....
18074	5174	Thread (under) Take-up for 18076, obsolete.....
18075	5156	Thread (upper) Take-up with 453c, for 55-1, 55-11 and 55-21 Machines.....
18076	—	Thread (under) Take-up Lever complete for 55-1 Machine, Nos. 18033, 18074 and two 404b, obsolete.....
18077	5182	Throat Plate for 18065, obsolete.....
18078	5191	Feed Dog, for $\frac{3}{8}$ in. to $\frac{1}{2}$ in. gauges, for banding trousers, for 55-2 and 55-12 Machines.....
18079	—	Presser Foot Band Guide for 18080.....
18080	—	" " Plate with 18079, for 18082
18081	—	" " Shank for 18082.....
18082	5213	Presser Foot (spring hinged) complete for 55-2 and 55-12 Machines, Nos. 14058, 18055, 18080 and 18081.....
18083	5191	Throat Plate for 18078.....
18084	—	Presser Foot Plate for 18086.....
18085	—	" " Shank for 18086.....

NO.	PLATE	NAME
18086	5213	Presser Foot (tube) hinged, complete, with centre guide, for covering seams with tape, for 55-2 and 55-12 Machines, Nos. 18055, 18084 and 18085.....
18087	5190	Feed Dog, for heavy lap seam feller, for 55-2 and 55-12 Machines, obsolete.....
18091	5233	Bed Slide (right) with 7393, for 18092, obsolete.....
18092	5190	Throat Plate for 18087, obsolete.....
18093	---	Face Plate for 18091.....
18094	5166	Face Plate complete for 55-21 and 55-22 Machines, Nos. 940F, 18027, 18093, 18104, 18105 and two 219F.....
18095	5184	Feed Dog for 55-21 Machine.....
18096	5153	Folder Holder Seat Cover for 55-1, 55-2, 55-11 and 55-12 Machines.....
18097	5158	Looper with 1076c, for 55-21 Machine....
18098	5152	Needle Bar (hollow).....
18099	---	" Clamp Body with 209F, for 18100.....
18100	5156	Needle Clamp complete for 55-1, 55-11 and 55-21 Machines, Nos. 924F, 18054, 18069 and 18099.....
18101	5162	Oil Cup with 18102, for 55-21 and 55-22 Machines.....
18102	5162	Oil Cup Pad (felt) for 18101.....
18104	5160	Slack Thread Regulator for 18094.....
18105	5160	" " " Adjusting Bracket for 18094.....
18106	---	Thread (upper) Controller complete for 55-21 Machine, Nos. 240b, 18048 and 18064, obsolete.....
18107	---	Thread (under) Take-up Lever complete for 55-1, 55-11 and 55-21 Machines, Nos. 18033, 18108 and two 404b.....
18108	5157	Thread (under) Take-up for 18107.....
18109	5182	Throat Plate for 18095, obsolete.....
18110	5154	Bed Slide (right) with 7393, for 55-1, 55-2, 55-11 and 55-12 Machines.....
18111	5172	Slack Thread Regulator Link with 1919, for 55-3 to 55-6, 55-21 and 55-22 Machines.....
18112	5183	Feed Dog, for shirt work, for 55-1 and 55-11 Machines.....
18113	5183	Throat Plate for 18112.....
18114	5227	Lap Seam Feller Folder Slide for 26272, 26397, 35631 and 35636.....

NO.	PLATE	NAME
18114	5227	Strip Folder Slide for 26413, 35621 and 35622.....
18115	5233	Lap Seam Feller Holder with 8505 and 18116, for 55-2 Machine, obsolete.....
18116	5228	Lap Seam Feller Folder Slide Spring for 18115 and 18118.....
18117	5233	Lap Seam Feller Slide, for heavy lap seam feller, for 55-2 Machine, obsolete.....
18118	5228	Lap Seam Feller Holder with 8505 and 18116, for 55-2 and 55-12 Machines....
18119	5159	Looper (inside) with 1076c, for No. 23 needle, for $\frac{3}{4}$ in. gauge and above, for 55-2, 55-4, 55-12 and 55-22 Machines..
18120	5159	Looper (outside) with 1076c, for No. 23 needle, for $\frac{3}{4}$ in. gauge and above, for 55-2, 55-4, 55-12 and 55-22 Machines..
18121	---	Presser Foot Plate for 18122.....
18122	5215	Presser Foot (hinged) complete, for medium or heavy lap seam feller, for 55-2 and 55-12 Machines, Nos. 18055, 18121 and 18123.....
18123	---	Presser Foot Shank for 18122 and 18127..
18124	5194	Feed Dog, for staying, for 55-12 and 55-22 Machines.....
18125	5193	Throat Plate for 18124, obsolete.....
18126	---	Presser Foot Plate for 18127.....
18127	5214	Presser Foot (hinged) complete, for inside stays, for 55-22 Machine, Nos. 18055, 18123 and 18126.....
18128	---	Presser Foot Shank for 18071.....
*18129	---	Arm with 11104, for 55-3 and 55-5 Machines.....
18130	5161	Arm Oil Tube with 29599, for oiling 18190, for 55-3 Machine, obsolete.....
18131	5151	Arm Shaft for 55-3 to 55-5 Machines.....
*18132	---	Bed for 55-3 to 55-5 Machines, obsolete..
18133	5172	" Oil Hole Cover for 55-3 to 55-6 Machines.....
18134	5168	Cloth Plate for 55-3, 55-5 and 55-6 Machines, and for 18286 and 18287 for 55-4 Machine.....
18135	---	Face Plate for 18136.....
18136	5167	Face Plate complete for 55-3, 55-5 and 55-6 Machines, Nos. 66F, 1521E, 18135, 18169, 18170 and two 219F.....
18137	5167	Feed Bar with 190b, for 55-3 to 55-6 Machines, obsolete, use 20913.....

NO.	PLATE	NAME
18138	5169	Feed Bar Screw Centre Oil Tube with 18139, for 55-3 to 55-6 Machines, obsolete.....
18139	5169	Feed Bar Screw Centre Oil Tube Packing for 18138, obsolete.....
18140	5175	Feed Dog, 17 teeth (12 teeth to the inch) for 55-3 Machine.....
18141	5167	Feed Eccentric Connecting Rod with 896E, 11136 and two 145E, for 55-3, 55-4 and 55-6 Machines.....

Nos. 18142 to 18148 FOR 55-3 TO 55-6 MACHINES

18142	5169	Feed Lifting Eccentric with 446c.....
18143	5169	" " " Connection.....
18144	5169	" " " Oil Pad.....
18145	5151	" Rock Shaft.....
18146	5169	" " " Regulator Crank with 790c and two 1147c.....
18147	5169	Feed Rock Shaft Screw Centre Oil Tube (crank end).....
18148	5169	Feed Rock Shaft Screw Centre Oil Tube (feed bar end).....
18149	5176	Loop Retainer, for single thread, for 18194, 18214, 18217, 18219, 18287, 18290, 18293, 18307, 18342, 20917 and 120376.....
18150	5174	Looper with 1077E, for double thread, for 55-3 Machine, obsolete, use 18220.....
18151	5174	Looper with 1077E, for single thread, for 55-3 Machine, obsolete, use 18221.....
18152	5151	Looper Shaft for 55-3, 55-5 and 55-6 Machines.....
18153	5169	Looper Shaft Oil Cup for 55-3 to 55-6 Machines.....
18154	5169	Looper Shaft Oil Cup Packing for 55-3 to 55-6 Machines.....
*18155	5170	Needle Bar Connecting Link with 794E, for 18301.....
18156	5233	Needle Bar Crank and Thread Nipper Eccentric with 448c and 855c, for 55-3 Machine, obsolete, use 18231.....
18157	5170	Needle Bar Thread Retainer Bracket for 18158, 18277, 18343, 18345 and 18350.....
18158	—	Needle Bar Thread Retainer Bracket complete for 55-3 Machine, and 18350 for 55-5 and 55-6 Machines, Nos. 453c, 462c, 12400, 18157, 18159 and 18160, obsolete, use 18343.....

NO.	PLATE	NAME
18159	5170	Needle Bar Thread Retainer Spring for 18158, 18277, 18343 and 18345.....
18160	5170	Needle Bar Thread Retainer Stud for 18158, obsolete.....
18161	5170	Needle Clamp with 209E, for 55-3, 55-5 and 55-6 Machines.....
*18162	5152	Oscillating Rock Shaft for 18163 and 18333.....
18163	—	Oscillating Rock Shaft complete for 55-1 to 55-5, 55-11, 55-12, 55-21 and 55-22 Machines, Nos. 4784, 12388 and 18162.....
18164	5167	Presser Bar for 55-3 to 55-6 Machines.....
18165	—	" Foot Body for 18168.....
18166	—	" " Plate for 18168.....
18167	5180	" " Spring Stud for 18168, 18213 and 18282.....
18168	5180	Presser Foot (spring hinged) complete for 55-3 Machine, Nos. 889c, 18165 to 18167, 18200, 18201 and 18325.....
18169	5172	Slack Thread Regulator for 18136 and 18274.....
18170	5172	Slack Thread Regulator Adjusting Bracket for 18136 and 18274.....
18171	5171	Thread (under) Eyelet for 55-3 and 55-4 Machines.....
18172	5171	Thread Eyelet (top of arm) for 55-3, 55-5 and 55-6 Machines.....
18173	5171	Thread Nipper Connection complete for 55-5 and 55-6 Machines, Nos. 2532, 18174 to 18176 and two 145E.....
18173	5171	Thread (upper) Nipper Connection complete for 55-3 and 55-4 Machines, Nos. 2532, 18174 to 18176 and two 145E.....
*18174	—	Thread Nipper Connection Cap for 18173.....
*18174	—	" (upper) Nipper Connection Cap for 18173.....
18175	—	Thread Nipper Connection Rod for 18173.....
18175	—	" (upper) Nipper Connection Rod for 18173.....
*18176	—	Thread Nipper Connection Rod End Bearing for 18173.....
*18176	—	Thread (upper) Nipper Connection Rod End Bearing for 18173.....
18177	5171	Thread Nipper Connection Sleeve for 55-5 and 55-6 Machines.....
18177	5171	Thread (upper) Nipper Connection Sleeve for 55-3 and 55-4 Machines.....

NO.	PLATE	NAME
18180	5171	Thread Nipper Plate with 13589, for 55-5 and 55-6 Machines.....
18180	5171	Thread (upper) Nipper Plate with 13589, for 55-3 and 55-4 Machines.....
18181	5171	Thread Nipper Plate Stud and Thread Eyelet for 55-5 and 55-6 Machines....
18181	5171	Thread (upper) Nipper Plate Stud and Thread Eyelet for 55-3 Machine and obsolete for 55-4 Machine.....
18182	5171	Thread Nipper Plate Washer for 55-5 and 55-6 Machines.....
18182	5171	Thread (upper) Nipper Plate Washer for 55-3 and 55-4 Machines.....
18183	---	Thread (under) Take-up complete for 55-3 and 55-4 Machines, Nos. 18184 and 18185.....
18184	5171	Thread (under) Take-up Arm for 18183....
18185	5171	" " " Body with 453c, for 18183.....
18186	5171	Thread (under) Take-up Eyelet for 55-3 and 55-4 Machines.....
18187	5170	Thread Take-up Crank for 55-5 and 55-6 Machines.....
18187	5170	Thread (upper) Take-up Crank for 55-3 and 55-4 Machines.....
18188	5170	Thread Take-up Lever for 18192.....
18188	5170	" (upper) Take-up Lever for 18192
18189	5170	" Take-up Lever Arm for 18192....
18189	5170	" (upper) Take-up Lever Arm for 18192 and 18285.....
18190	5170	Thread Take-up Lever Link for 55-5 and 55-6 Machines.....
18190	5170	Thread (upper) Take-up Lever Link for 55-3 and 55-4 Machines.....
18191	5170	Thread Take-up Lever Rivet for 18192..
18191	5170	" (upper) Take-up Lever Rivet for 18192 and 18285.....
18192	---	Thread Take-up Lever complete for 55-5 and 55-6 Machines, Nos. 18188, 18189 and two 18191.....
18192	---	Thread (upper) Take-up Lever complete for 55-3 Machine, Nos. 18188, 18189 and two 18191.....
18193	5175	Throat Plate, for double thread, for 18140, 18208 and 18326.....
18194	5175	Throat Plate with 335D and 18149, for single thread, for 18140, 18208 and 18326

NO.	PLATE	NAME
18195	---	Presser Foot Plate for 18197.....
18196	---	" " Shank for 18197.....
18197	5214	Presser Foot (tube) hinged, complete, for 55-2, 55-4, 55-12 and 55-22 Machines, Nos. 18055, 18195 and 18196.....
18198	5198	Feed Dog, for $\frac{1}{2}$ in. to $\frac{3}{4}$ in. gauges, for general work, for 55-2 and 55-12 Machines and for 35658 for the same machines.....
18199	5198	Throat Plate for 18198.....
18200	5180	Presser Foot Spring, for heavy work, for 18168, 18213 and 18282.....
18201	5180	Presser Foot Spring, for light work, for 18168, 18213 and 18282.....
18202	5159	Looper (inside) with 1076c, for $\frac{5}{8}$ in. to $\frac{3}{4}$ in. gauges, for 18204.....
18203	5159	Looper (outside) with 1076c, for $\frac{5}{8}$ in. to $\frac{3}{4}$ in. gauges, for 18204.....
18204	---	Loopers, for $\frac{5}{8}$ in. to $\frac{3}{4}$ in. gauges, for 55-2, 55-12 and 55-22 Machines, Nos. 198D, 18202 and 18203.....
18205	5197	Feed Dog, for $\frac{1}{4}$ in. to $\frac{1}{2}$ in. gauges, for 55-2 and 55-12 Machines.....
18206	5197	Throat Plate for 18205, for lap seam feller
18207	5194	" " (flush) for 18124.....
18208	5175	Feed Dog, 12 teeth (8 teeth to the inch) for 55-3 Machine.....
18209	---	Knee Lifter complete (power table) for 55-3 to 55-6, 55-21 and 55-22 Machines, Nos. 76D, 802D, 1521E, 5598, 12237, 12240, 12250, 12415, 12416 and two 178E
18210	---	Foot Lifter complete for 55-3 to 55-5, 55-21 and 55-22 Machines, Nos. 76D, 802D, 1521E, 4880, 4885, 5598, 5670, 12237, 12240, 12415, 12416 and two 178E.....
18211	5176	Feed Dog for 55-3 Machine.....
18212	---	Presser Foot Plate for 18213.....
18213	5180	Presser Foot (spring hinged) complete for 18211, Nos. 889c, 18167, 18200, 18201, 18212, 18215 and 18325.....
18214	5176	Throat Plate with 335D and 18149, for single thread, for 18211.....
18215	---	Presser Foot Body for 18213.....
18216	5176	Feed Dog for 55-3 Machine.....
18217	5176	Throat Plate with 335D and 18149, for single thread, for 18216.....
18218	5177	Feed Dog for 55-3 Machine.....

NO.	PLATE	NAME
18219	5177	Throat Plate with 335D and 18149, for single thread, for 18218.
18220	5173	Looper with 209F and 1389F, for double thread, for 55-3 Machine, obsolete, use 18299.
18220	5173	Looper (inside) with 209F and 1389F, for double thread, for 55-4 Machine, obsolete, use 18299.
18220	5173	Looper (outside) with 209F and 1389F, for double thread, for 55-4 Machine, obsolete, use 18299.
18221	5173	Looper with 209F and 1389F, for single thread, for 55-3 Machine, obsolete, use 18300.
18221	5173	Looper (inside) with 209F and 1389F, for single thread, for 55-4 Machine, obsolete, use 18300.
18221	5173	Looper (outside) with 209F and 1389F, for single thread, for 55-4 Machine, obsolete, use 18300.
*18222	—	Bed for 55-21 and 55-22 Machines.
18223	5166	“ Cover for 55-21 and 55-22 Machines.
18224	5166	“ Slide for 55-21 and 55-22 Machines.
18225	5184	Feed Dog for 55-21 Machine.
18226	5152	Needle Bar Crank with 453c and 1065c, for 55-1, 55-2, 55-21 and 55-22 Machines.
18227	5188	Presser Foot for 55-21 Machine.
18228	5166	Thread (bed) Cover for 18229.
18229	—	Thread Cover complete for 55-21 and 55-22 Machines, Nos. 14026, 18024, 18228 and two 405E.
18230	5184	Throat Plate for 18225.
18231	5167	Needle Bar Crank and Thread Nipper Eccentric with 448c and 1065c, for 55-3 to 55-6 Machines.
18232	5152	Needle Bar Crank with 453c and 1065c, for 55-11 and 55-12 Machines.
18233	5195	Feed Dog, $\frac{5}{8}$ in. to $\frac{1}{4}$ in. gauges, for 55-22 Machine, and for lap seam feller for 55-2 and 55-12 Machines.
18234	5195	Throat Plate for 18233.
18235	5151	Looper Shaft for 55-2 and 55-12 Machines.
18236	—	Bed Slide (left) for 18237.
18237	5154	Bed Slide (left) $\frac{1}{8}$ in. long, for $\frac{3}{8}$ in. to $1\frac{1}{4}$ in. gauges, complete, for 55-2 and 55-12 Machines, Nos. 4307, 18236 and two 240D.

NO.	PLATE	NAME
18238	—	Face Plate for 18239.
18239	5153	Face Plate complete for 35658, for 55-2 and 55-12 Machines, Nos. 18027, 18056, 18238 and two 578F.
18240	5196	Throat Plate for 18233, for lap seam feller.
18241	5198	Feed Dog, for $\frac{3}{4}$ in. to $\frac{3}{4}$ in. gauges, for lap seam feller, for 55-2 and 55-12 Machines.
18242	5198	Throat Plate for 18241 and 18316, for lap seam feller.
18243	5199	Feed Dog, for $\frac{1}{2}$ in. to $1\frac{1}{4}$ in. gauges, for 55-2 and 55-12 Machines, and for lap seam feller for the same machines.
18244	5200	Throat Plate for 18243 and 18271, for lap seam feller.
18245	5199	Throat Plate for 18243 and 18271.
18246	5201	Feed Dog, for $1\frac{1}{4}$ in. to $1\frac{5}{8}$ in. gauges, for 55-2 and 55-12 Machines.
18247	5201	Throat Plate for 18246.
18248	5197	Feed Dog (spiked teeth) for $\frac{1}{4}$ in. to $\frac{1}{2}$ in. gauges, for 55-2 and 55-12 Machines.
18249	5197	Throat Plate for 18205 and 18248.
18250	—	Presser Foot Plate for 18252.
18251	—	“ “ Shank for 18252.
18252	5214	Presser Foot (hinged) complete, for outside stays and strips, for 55-2 and 55-12 Machines, Nos. 18250, 18251 and 26276.
18253	5183	Feed Dog, for general work, for 55-1 Machine.
18254	5183	Throat Plate for 18253.
18255	—	Presser Foot Plate for 18257.
18256	—	“ “ Shank for 18257.
18257	5188	Presser Foot (hinged) complete for 18253, Nos. 18255, 18256 and 62527.
18258	5202	Feed Dog, for $\frac{1}{4}$ in. to $1\frac{1}{4}$ in. gauges, for banding knit underwear, for 35620, for 55-2 Machine.
18259	5202	Throat Plate for 18258.
18260	5185	Feed Dog, for silk mitt work, for 55-1 Machine.
18261	5185	Throat Plate, small needle hole, for 18260.
18262	—	Presser Foot Plate for 18264.
18263	—	“ “ Shank for 18264.
18264	5185	Presser Foot Hinge complete for 18260, Nos. 18262, 18263 and 62527.
18265	5184	Throat Plate for 18095.

NO.	PLATE	NAME
18266	5192	Feed Dog, for $\frac{3}{8}$ in. to $\frac{1}{4}$ in. gauges, for vamping, for 55-22 Machine.....
18267	5192	Throat Plate for 18266.....
18268	5192	Presser Foot for 18266.....
18269	5195	Throat Plate for 18233, for under strip....
18270	5234	Looper Threading Wire (Accessories)....
18271	5199	Feed Dog (spiked teeth) for $\frac{3}{4}$ in. to $1\frac{1}{4}$ in. gauges, for 55-2 and 55-12 Machines, and for lap seam feller for the same machines.....
Nos. 18272 TO 18295 FOR 55-4 MACHINE		
*18272	—	Arm with 11104.....
18273	—	Face Plate for 18274.....
18274	5236	Face Plate complete, Nos. 66F, 1521E, 18169, 18170, 18273 and two 219F.....
18275	5203	Feed Dog, for $\frac{7}{8}$ to $\frac{5}{8}$ in. gauges.....
18276	5151	Looper Shaft.....
18277	—	Needle Bar Thread Retainer Bracket complete, Nos. 453c, 462c, 12400, 18157, 18159, 18278 and 21020, obsolete, use 18345.....
18278	5172	Needle Bar Thread Retainer Stud for 18277, obsolete.....
18279	—	Presser Foot Body for 18282.....
18280	5160	" " Hinge Pin for 18282.....
18281	—	" " Plate for 18282.....
18282	5203	Presser Foot (spring hinged) complete for 18275, Nos. 889c, 18167, 18200, 18201 and 18279 to 18281.....
18283	5160	Tension (under thread) Eyelet (double)....
18284	5172	Thread (upper) Take-up Lever for 18285
18285	—	Thread (upper) Take-up Lever complete, Nos. 18189, 18284 and two 18191.....
18286	5203	Throat Plate, for double thread, for 18275
18287	5203	" " with two each 335D and 18149, for single thread, for 18275.....
18288	5204	Feed Dog, for $1\frac{1}{8}$ in. to $1\frac{1}{2}$ in. gauges....
18289	5204	Throat Plate, for double thread, for 18288
18290	5205	" " with two each 335D and 18149, for single thread, for 18288.....
18291	5206	Feed Dog, for $1\frac{3}{8}$ in. and $1\frac{1}{4}$ in. gauges
18292	5206	Throat Plate for 18291, for double thread
18293	5207	" " with two each 335D and 18149, for single thread, for 18291.....
18294	5237	Cloth Plate for 18289 and 18290.....
18295	5237	" " " 18292 and 18293.....

NO.	PLATE	NAME
18296	5239	Feed Dog, for $\frac{3}{8}$ in. to $1\frac{3}{16}$ in. gauges, for general work, for 55-2 and 55-12 Machines.....
18297	5239	Throat Plate for 18296.....
18298	5242	" " " double thread, for 18211
18299	5173	Looper with 1120F and 1389F, for double thread, for 55-3 Machine.....
18299	5173	Looper (inside) with 1120F and 1389F, for double thread, for 55-4 Machine.....
18299	5173	Looper (outside) with 1120F and 1389F, for double thread, for 55-4 Machine....
18300	5173	Looper with 1120F and 1389F, for single thread, for 55-3, 55-5 and 55-6 Machines
18300	5173	Looper (inside) with 1120F and 1389F, for single thread, for 55-4 Machine....
18300	5173	Looper (outside) with 1120F and 1389F, for single thread, for 55-4 Machine....
18301	—	Needle Bar Connecting Link 18155 with 12384, for 55-3 to 55-6 Machines.....
18302	5242	Presser Foot (left) with 7311, for 18304 and 120375, obsolete.....
18303	5242	Presser Foot (right) with 7311, for 18304
18304	5242	Presser Foot (compensating) complete for 18305, Nos. 106D, 220D, 7309, 7310, 15694, 18302 and 18303, obsolete.....
18305	5243	Feed Dog for 55-5 Machine, obsolete.....
18306	5242	Presser Foot for 55-6 Machine and obsolete for 55-5 Machine.....
18307	5243	Throat Plate with 335D and 18149, for 18305, obsolete.....
18309	5240	Feed Eccentric with two 448c, for 55-5 Machine.....
18310	5240	Feed Eccentric Connecting Rod with 18311 and two 145E, for 55-5 Machine.....
*18311	—	Feed Eccentric Connecting Rod Cap for 18310.....
18312	5241	Thread (upper) Nipper Plate Stud and Thread Eyelet for 55-4 Machine.....
18316	5198	Feed Dog (spiked teeth) for $\frac{3}{4}$ in. to $\frac{3}{4}$ in. gauges, for lap seam feller, for 55-2 and 55-12 Machines.....
18325	5241	Presser Foot Hinge Pin for 18168 and 18213.....
18326	5175	Feed Dog, 23 teeth (16 teeth to the inch) for 55-3 Machine.....

NO.	PLATE	NAME
Nos. 18327 TO 18342 FOR 55-6 MACHINE		
*18327	—	Arm with 11104.....
18328	5244	" Shaft.....
18329	5240	" " Flanged Bushing (back).....
*18330	—	Bed, obsolete.....
18331	5244	Belt Cover Bracket with 871E and 43585
18332	5243	Feed Dog.....
18333	—	Oscillating Rock Shaft complete, Nos. 4784, 18162 and 18334.....
18334	5240	Oscillating Rock Shaft Hinge Pin for 18333
18335	5240	Pulley (tight) with 624c, for 18336.....
18336	—	Pulley (tight) complete for 18337, Nos. 871E, 14263, 18335, 21615 to 21617, 21653 and two 997E.....
18337	—	Pulleys complete, Nos. 18336 and 66085..
18338	5244	Starting Lever for 18339.....
18339	—	Starting Lever complete, Nos. 159F, 803c, 913c, 1520E, 1638E, 14260, 14277, 18338, 18341, 21645, 21651, 43583 and two 399F
18340	5244	Starting Lever Bracket.....
18341	5245	Stop Cam Interlocking Rod Guide with 1070c, for 18339.....
18342	5243	Throat Plate with 335D and 18149, for 18332.....
18343	—	Needle Bar Thread Retainer Bracket complete for 55-3 Machine, Nos. 453c, 462c, 12400, 18157, 18159, 18344 and 20910.....
18344	5241	Needle Bar Thread Retaining Stud for 18343 and 18350.....
18345	—	Needle Bar Thread Retainer Bracket complete for 55-4 Machine, Nos. 453c, 462c, 12400, 18157, 18159, 18346, 20910 and 21020.....
18346	5241	Needle Bar Thread Retaining Stud for 18345.....
18347	—	Starting Lever Chain, 38 in. long, with two 56865, for 55-6 Machine.....
18348	5245	Starting Lever Chain Connection for 55-6 Machine.....
18349	5241	Needle Bar Thread Retainer Spring for 18350.....
18350	—	Needle Bar Thread Retainer Bracket complete for 55-5 and 55-6 Machines, Nos. 453c, 462c, 12400, 18157, 18344, 18349 and 20910.....

NO.	PLATE	NAME
18498	5244	Belt Cover for 55-6 Machine.....
19219	1206	Bed Frame Cushion (leather) for 20067..
19220	1206	" " " Spring for 20067....
19221	5234	Wrench for 936 and 1619 (Accessories) ..
19226	1206	Bed Frame Hinge Connection for 19398...
19397	1206	" " " " Cap for 19398
19398	—	" " " " 19226 with 211F and 19397, for 20067.....
19447	5155	Looper Shaft Crank complete, Nos. 457c, 1518E, 19449 and 19496.....
19448	5155	Looper Shaft Crank Slide Block for 19449
19449	—	Looper Shaft Crank Slide Block complete for 19447, Nos. 226D, 988c, 12424 and 19448.....
19496	—	Looper Shaft Crank for 12390 and 19447
20008	—	Foot Lifter complete for 55-1, 55-2, 55-11 and 55-12 Machines, Nos. 76D, 766D, 802D, 1521E, 4880, 4885, 5598, 5670, 12237, 12240, 12241, 12415, 12416 and two 178E.....
20021	—	Drip Pan with four 1 in. wire nails, obsolete, use 44212.....
20023	5152	Presser Bar Spring (heavy) for 55-1 to 55-4, 55-11, 55-12, 55-21 and 55-22 Machines.....
20023	5152	Presser Bar Spring for 55-6 Machine.....
20067	819	Bed Frame with two each 16555, 19398, four each 19219, 19220, six each 14010, wood screws 1¼ in. No. 12 and eight 158c.....
20197	5152	Crank Connecting Rod with 20198 and two 896E.....
*20198	—	Crank Connecting Rod Cap for 20197.....
20910	5241	Needle Bar Thread Retaining Collar for 18343, 18345 and 18350.....
*20912	—	Bed for 55-3 to 55-5 Machines.....
20913	5240	Feed Bar with 176D, for 55-3 to 55-6 Machines.....
20915	—	Bed for 55-6 Machine.....
20916	5208	Feed Dog for 55-5 Machine.....
20917	5208	Throat Plate with 335D and 18149, for 20916.....
20918	5209	Feed Dog, 14 teeth (10 teeth to the inch) for 55-5 Machine, obsolete.....
Nos. 20921 TO 20924 FOR 20925		
20921	—	Presser Foot Plate (left).....

NO.	PLATE	NAME
20922	—	Presser Foot Plate (right).....
20923	—	“ “ “ Shank with 7311.....
20924	—	“ “ “ Bracket.....
20925	5209	Presser Foot (hinged, compensating) for 55-5 Machine, Nos. 106b, 220b, 7309, 7310, 20921, 20922, 20924 and two each 20923 and 62527.....
21020	5172	Needle Bar Thread Retaining Thread Separator for 18277 and 18345.....
Nos. 21615 to 21617 FOR 18336		
21615	5240	Stop Cam Spring (long).....
21616	5240	“ “ “ (short).....
21617	5245	“ “ “ Stop Block.....
21638	5240	Pulley (loose) for 18337, obsolete, use 66085
21645	5245	Starting Lever Cushion (rawhide) for 18339.....
21651	5240	Stop Cam Interlocking Rod Spring for 18339.....
21652	5241	Stop Cam Pin for 14263.....
21653	5240	“ “ Spring Cover for 18336.....
21654	5234	Wrench for 1508 and 1638 (Accessories)...
23227	5160	Bed Slide (right) Spring Rivet for 18026
23258	5211	Under Driver Treadle Bracket (left) Hook Rivet Washer for 126206.....
23668	5241	Pulley (tight) Pin for 55-6 Machine.....
23868	5160	Thread Eyelet (top of arm) for 55-4 Ma- chine.....
25016	—	Belt, size $\frac{1}{4}$ in., length $69\frac{1}{2}$ in., with 25127, from band wheel to machine, for 25265 and 25285.....
25082	8382	Treadle for 25279.....
25086	3813	Wrench for 1507, 1510 and 1670, for 25255, 25265, 25279 and 25284.....
25127	3826	Belt Hook for 25016, 25370, 25490 and 46657.....
25200	5210	Wrench for 972, for 25265 and 25284....
25255	—	Stand (iron work) high speed, complete, Nos. 25086, 25329, 25421, 25430 to 25432, 25436 to 25438, 46604, 46605, two each 25345, 25349, 25350, 25433 and four each 534E, 748E, 1508E and 25446.....
25265	—	Stand (iron work) rocking treadle, ball bearing pitman, complete, Nos. 25086, 25200, 25301, 46520, 46524, 82985, two 82973 and four 748E.....

NO.	PLATE	NAME
25279	—	Stand (iron work) complete, for electric motor, Nos. 7958, 25082, 25086, 82985, two 82973 and four 748E.....
25284	—	Stand (iron work) rocking treadle, ball bearing pitman, complete, for foot power and S. D. 11 or S. D. 12 electric motor, Nos. 10875, 25086, 25200, 25301, 46524, 46656, 82985, two 82973 and four 748E
25301	5216	Band Wheel, 16 in. diam., with 972c, for 25265 and 25284.....
25329	3813	Band Wheel, 16 in. diam., with 1312c, for 25255.....
25330	3816	Band Wheel Brake (rubber) for 25418, obsolete.....
25345	3813	Driving Segment (rack) for 25255.....
25349	3813	Foot Rest for 25255.....
25350	3817	“ “ Cotter Pin for 25255.....
*25360	—	Pitman Rod Ball for 46523.....
*25360	—	“ “ (lower) Ball for 46658.....
25361	3826	“ “ Ball Screw Bearing for 46630
25361	3826	“ “ (lower) Ball Screw Bearing for 46630.....
25362	3826	Pitman Ball, size $\frac{3}{16}$ in., for 46520 and 46656.....
25370	—	Belt, size $\frac{1}{4}$ in., length $67\frac{1}{2}$ in., with 25127, for 25255.....
25371	3826	Pitman Rod Ball Bushing for 46520.....
25371	3826	“ “ (lower) Ball Bushing for 46656.....
25418	3814	Band Wheel Brake Lever with 443c and 25330, for 25255, obsolete.....
25419	3816	Band Wheel Brake Lever Hinge Pin for 25418, obsolete.....
25420	3816	Band Wheel Brake Lever Spring for 25418, obsolete.....
25421	3814	Band Wheel Shaft for 25255.....
Nos. 25422 to 25425 FOR 46604		
25422	3815	Band Wheel Shaft Driver (left).....
25423	3815	“ “ “ “ “ Clutch (left).....
25424	3815	Band Wheel Shaft Driver (left) Clutch (right) with 5564.....
25425	3817	Band Wheel Shaft Driver (left) Clutch Spring.....

NO.	PLATE	NAME
Nos. 25425 TO 25428 FOR 46605		
25425	3817	Band Wheel Shaft Driver (right) Clutch Spring.....
25426	3815	Band Wheel Shaft Driver (right).....
25427	3815	" " " " Clutch (left).....
25428	3815	Band Wheel Shaft Driver (right) Clutch (right) with 5564.....
25429	3815	Band Wheel Shaft Driving Flange with 356c, for 46604 and 46605.....
Nos. 25430 TO 25433 FOR 25255		
25430	3814	Brace.....
25431	3813	Driving Arm (left) with 435c and 25435....
25432	3813	" " (right) with 435c and 25435....
25433	3816	" " Hinge Pin.....
25434	3815	" Pinion for 46604 and 46605....
25435	3816	Foot Rest Hinge Pin for 25431 and 25432
Nos. 25436 TO 25438 FOR 25255		
25436	3813	Leg (left).....
25437	3813	" (right).....
25438	3814	" Stay Rod.....
25446	3817	Driving Segment Bolt Nut Washer for 25255.....
25490	—	Belt, size $\frac{1}{4}$ in., length 36 in., with 25127, for 25279.....
26026	5234	Screw Driver, machine (Accessories).....
26061	989	Tape Holder Bracket Wire with Disc for 26063.....
26062	989	Tape Holder Disc (adjustable) with 286b and 35925, for 26063.....
26063	989	Tape Holder (straight) 8 in. disc, complete, for 26065, Nos. 26061 and 26062
26064	5234	Tape Holder Foot with 736b and three wood screws 1 in. No. 12, for 26343....
26065	—	Tape Holder (8 in. disc) with Foot complete, Nos. 26063 and 26325.....
26066	989	Tape Holder Bracket Wire for 26067.....
26067	—	Tape Holder Bracket Wire complete for 26074, Nos. 26066, 26068 and 26072....
26068	989	Tape Holder Disc for 26067 and 26071....
26069	989	" " " Hub for 26071.....
26070	—	" " " " Rivet for 26071..
26071	—	Tape Holder Disc complete for 26074, Nos. 26068, 26069 and three 26070.....

NO.	PLATE	NAME
26072	989	Tape Holder Tape Guide for 26067.....
26073	1206	" " Tension Adjusting Collar with 286b, for 26074.....
26074	989	Tape Holder complete for 26343, Nos. 13211, 26067, 26071 and 26073.....
*26269	—	Lap Seam Feller Folder for 26272.....
26272	5225	Lap Seam Feller (right hand) on Slide complete for 55-2 and 55-12 Machines, Nos. 18114 and 26269.....
26276	5160	Presser Foot Hinge Pin for 18252, 35616, 35620, 35625, 35639, 35642, 35645, 35648, 35652 and 35663.....
26325	5234	Tape Holder Foot with 736b and three wood screws 1 in. No. 12, for 26065....
26343	—	Tape Holder (10 in. disc) with Foot complete, Nos. 26064 and 26074.....
*26396	—	Lap Seam Feller Folder for 26397.....
26397	5225	Lap Seam Feller (left hand) on Slide complete for 55-2 and 55-12 Machines, Nos. 18114 and 26396.....
*26412	—	Strip Folder for 26413.....
25413	5227	" " 26412 with 18114, for 55-2 Machine.....
26463	956	Guide (1 $\frac{1}{2}$ in. face) for 55-3 and 55-4 Machines.....
26485	5234	Screw Driver, shuttle tension (Accessories)
26693	956	Guide (4 in. face) for 55-3 and 55-4 Machines.....
27070	363	Under Driver Shaft Driving Pulley (sectional, grooved) 10 in. diam., $1\frac{3}{8}$ in. bore, with two 597c, for 27645.....
27473	1101	Under Driver Cone Pulley Centre Bearing for 126321.....
27474	363	Under Driver Dress Guard (right hand) for 27644.....
27483	1101	Under Driver Lever Brake Spring for 27644.....
27485	1101	Under Driver Lever Hinge Pin for 27644..
27497	1101	" " " Brake Strip (leather) for 27644.....
27508	362	Under Driver Belt Guard for 27644.....
27598	—	" " Driving Pulley Friction Ring (leather) for 126315.....
27600	1101	Under Driver Driving Pulley Hollow Stud Position Stud for 126316.....
27632	—	Under Driver Driving Pulley Hollow Stud Wick for 27633.....

NO.	PLATE	NAME
Nos. 27633 TO 27635 FOR 27644		
27633	—	Under Driver Driving Pulley Hollow Stud Wick Wire with 27632.....
27634	362	Under Driver Frame.....
27635	362	“ “ Oil Cup.....
Nos. 27637 TO 27639 FOR 27640		
27637	362	Under Driver Treadle Pitman Rod (lower)
27638	1101	“ “ “ “ “ “ Spring.....
27639	362	Under Driver Treadle Pitman Rod (upper)
27640	362	Under Driver Treadle Pitman complete for 126210, Nos. 2762, 6055, 27637 to 27639 and two 9079.....
27644	—	Under Driver Transmitter complete for 27645, Nos. 138E, 356C, 427E, 649E, 1508C, 12178, 27474, 27483, 27485, 27497, 27508, 27633 to 27635, 41338, 126315, 126316, 126321, two 127E and four wood screws 1½ in. No. 16.....
27645	—	Under Driver, lever pressure, three speed, right hand (oil controlling pulley) complete for 55-6 Machine, Nos. 27070, 27644 and 126210.....
27739	7234	Thread Unwinder Thread Cone (wood) for large cones, for 225394, 225396 and 225398.....
28084	5245	Machine Rest Pin (Accessories).....
28969	5241	Guide (adjustable, hinged) complete for 55-5 Machine, Nos. 286D, 940D, 7071, 28971 to 28973 and 35610, obsolete, use 120428.....
28971	5241	Guide for 28969 and 120428.....
28972	5241	“ Holder for 28969, 120373, 120428 and 120439.....
28973	5241	Guide Holder Shank for 28969, 120373 and 120439.....
29599	5161	Arm Oil Tube Packing (felt) for 11119, 12454 and 18130.....
35610	5241	Guide Holder Friction Washer for 28969, 120373, 120428 and 120439.....
35612	5232	Hemmer (foot) ¼ in. hem, for shirts, for 18253, for 55-1 Machine.....
35613	5227	Binder on Slide 18114, for binding knit underwear, for 55-1 Machine.....
35614	—	Presser Foot Plate for 35616.....
35615	—	“ “ Shank for 35616.....

NO.	PLATE	NAME
35616	5227	Presser Foot (hinged) complete for 35613, Nos. 26276, 35614 and 35615.....
35617	5229	Edge Folder (right hand) with left hand lower guide on Slide 18114 complete, to sew narrow tape on flannel and lace material, for 55-2 Machine.....
35618	—	Presser Foot Plate for 35620.....
35619	—	“ “ Shank for 35620.....
35620	5221	Presser Foot (hinged) complete for 35621, Nos. 26276, 35618 and 35619.....
35621	5220	Strip Folder on Slide 18114, for banding knit underwear, for 55-2 Machine.....
35622	5220	Strip Folder with Guide on Slide 18114, for folding the left hand edge and hemming the right hand edge on strip, for harvest gloves, for 55-2 Machine.....
35623	—	Presser Foot Plate for 35625.....
35624	—	“ “ Shank for 35625.....
35625	5222	Presser Foot (hinged) complete for 35622, Nos. 26276, 35623 and 35624.....
35626	5230	Hemmer on Shank, for heavy toweling, for 55-3 Machine.....
35627	5220	Edge Folder for 35629.....
35628	5220	“ “ Hinge Plate for 35629.....
35629	5220	Edge Folder (double) swinging, complete, for burlap bags, for 55-3 Machine, Nos. 74D, 35627 and 35628.....
35630	5220	Edge Folder (double) on Shank, for closing burlap bags, for 55-3 Machine.....
35631	5226	Lap Seam Feller (right hand) on Slide 18114, for mackintosh material, for 55-12 Machine.....
35632	5230	Lap Seam Feller (right hand) on Shank, to fold top only, for shoe linings, for 55-22 Machine.....
35633	5229	Stay Guide (lower) for 35635.....
35634	5229	“ “ (upper) for 35635.....
35635	—	Stay Guide complete for 55-22 Machine, Nos. 35633 and 35634.....
35636	5226	Lap Seam Feller (left hand) on Slide 18114, to fold bottom only, for 55-2 and 55-12 Machines.....
35637	—	Presser Foot Plate for 35639.....
35638	—	“ “ Shank for 35639.....
35639	5231	Presser Foot (strip folding) hinged, complete, with guide for opening seams, for 55-2 and 55-12 Machines, Nos. 26276, 35637 and 35638.....

NO.	PLATE	NAME
35640	—	Presser Foot Plate for 35642.....
35641	—	“ “ Shank for 35642.....
35642	5231	Presser Foot (strip folding) hinged, complete, for 55-2 and 55-12 Machines, Nos. 26276, 35640 and 35641.....
35643	—	Presser Foot Plate for 35645.....
35644	—	“ “ Shank for 35645.....
35645	5231	Presser Foot (strip folding) hinged, complete, with tube for cording, for 55-2 and 55-12 Machines, Nos. 26276, 35643 and 35644.....
35646	—	Presser Foot Plate for 35648.....
35647	—	“ “ Shank for 35648.....
35648	5221	Presser Foot (tube) hinged, complete, for taping, for 55-2 and 55-12 Machines, Nos. 26276, 35646 and 35647.....
35649	5227	Edge Guide on Slide 18114, for general work, for 55-2 and 55-12 Machines....
35650	—	Presser Foot Plate for 35652.....
35651	—	“ “ Shank for 35652.....
35652	5222	Presser Foot (tube) hinged, complete, plain bottom, for 55-2 and 55-12 Machines, Nos. 26276, 35650 and 35651..

Nos. 35653 TO 35657 FOR 35658

35653	5223	Tape Guide.....
35654	5224	“ “ Bracket.....
35655	5224	“ “ “ Hinge Stud.....
35656	5224	“ “ Position Bracket.....
35657	5224	“ “ Spring.....
35658	—	Tape Guide (hinged) complete, for stitching woolen lace on the edge of knit underwear, for 18239, for 55-2 and 55-12 Machines, Nos. 990r, 35653 to 35657 and four 219F.....

Nos. 35659 TO 35662 FOR 35663

35659	—	Presser Foot Plate.....
35660	5224	“ “ Roller.....
35661	5224	“ “ “ Pin.....
35662	—	“ “ Shank.....
35663	5224	Presser Foot (spring hinged) roller, complete, for 18198 and 35658, Nos. 9610, 26276 and 35659 to 35662.....
35664	5224	Tape Guide Edge Guide for 35666.....
35665	5224	“ “ “ “ Slide for 35666..

NO.	PLATE	NAME
35666	—	Tape Guide Edge Guide complete for 35658, Nos. 35664, 35665 and two 1443D
35713	5238	Edge Folder on Shank for 55-4 Machine..
35714	5238	Lap Seam Guide on Shank, for canvas work, for 55-4 Machine.....
35925	—	Tape Holder Disc Hub for 26062.....

Nos. 36818 TO 36820 FOR 36821

36818	5809	Finger Guard.....
36819	5809	“ “ Friction Washer.....
36820	5809	“ “ Holder with 196a.....
36821	5809	Finger Guard complete for 55-1, 55-3, 55-5, 55-6, 55-11 and 55-21 Machines, Nos. 36818 to 36820 and 50316.....
41338	362	Under Driver Lever for 27644.....
43583	5240	Stop Cam Interlocking Rod for 18339.....
43585	5241	Belt Cover Bracket Stud for 18331.....
44139	5162	Machine Hinge Plate for 44140.....
44140	—	Machine Hinge complete, Nos. 12361, 44139 and merlized wood screw 1¼ in. No. 14 (Accessories).....
44212	7711	Drip Pan with four 1 in. wire nails.....

Nos. 46506 TO 46509 FOR 46520 AND 46656

46506	3826	Pitman Ball Bearing Adjusting Screw Ring
46507	3826	“ “ “ “ “ “ “ Locking Washer (brass).....
46508	3826	Pitman Ball Bearing Ring.....
46509	3826	“ “ Case.....
46519	5210	Band Wheel Crank for 46520 and 46656..
46520	—	Band Wheel Crank and Pitman (ball bearing) complete for 25265, Nos. 1520r, 25371, 46506 to 46509, 46519, 46523, 46630, 46655 and six 25362.....
46523	5210	Pitman Rod with 25360, for 46520.....
46524	5216	Treadle for 25265 and 25284.....
46528	6142	Brace Section (left) with 46629, for 46662
*46604	—	Band Wheel Shaft Driving Flange (left) complete for 25255, Nos. 25422 to 25425, 25429 and 25434.....
*46605	—	Band Wheel Shaft Driving Flange (right) complete for 25255, Nos. 25425 to 25429 and 25434.....
*46629	—	Band Wheel Crank Screw Centre 297c with 1507J, for 46528, 46663 and 82985
*46629	—	Treadle Screw Centre 297c with 1507J, for 46663 and 82985.....

NO.	PLATE	NAME
46630	—	Pitman Rod Ball Screw Bearing 25361 with 1670e, for 46520.....
46630	—	Pitman Rod (lower) Ball Screw Bearing 25361 with 1670e, for 46656.....
46655	3826	Pitman Ball Separator for 46520 and 46656
46656	—	Band Wheel Crank and Pitman (ball bearing) complete for 25284, Nos. 1520r, 25371, 46506 to 46509, 46519, 46630, 46655, 46658 to 46660 and six 25362....
46657	—	Belt, size $\frac{1}{4}$ in., length $36\frac{1}{2}$ in., with 25127, from motor to machine, for 25284
Nos. 46658 to 46660 for 46656		
46658	5245	Pitman Rod (lower) with 25360.....
46659	5240	" " (upper).....
46660	5245	" " Coupling.....
46662	6142	Brace (sectional) complete for 25265, 25279 and 25284, Nos. 46528, 46663 and three 880e.....
46663	6142	Brace Section (right) with two 46629, for 46662.....
46667	—	Brace for 82985.....
46681	5212	Under Driver Treadle Bracket (right) for 60502.....
50302a	5211	Finger Guard Holder Set Screw for 120497
50316a	5809	" " Hinge Screw for 36821.....
50992c	5211	Under Driver Driving Pulley Screw Centre Bearing for 126315.....
56848	—	Bell Crank 5596 with 5599 and 5601, for 5598.....
56864	5211	Chain Hook (large) for 5670.....
56865	5211	" " (small) for 5670.....
56865	5211	Starting Lever Chain Hook for 18347.....
60502	—	Under Driver Treadle Bracket (right) 46681 with two wood screws 1 in. No. 14, for 126209.....
62527	5211	Presser Foot Hinge Pin for 18257, 18264 and 20925.....
66085	5210	Pulley (loose) for 18337.....
67086	5244	Treadle Pitman Rod (upper) for 67177....
67175	5245	Hook for 67072 for 25284.....
67176	5244	Treadle Pitman Rod (lower) for 67177....
67177	5244	Treadle Pitman complete for 25284, Nos. 9079, 67086 and 67176.....
82973	5216	Leg for 25265, 25279 and 25284.....
82985	5216	Brace 46667 with three 46629, for 25265, 25279 and 25284.....

NO.	PLATE	NAME
120341	5234	Tweezers (curved) Accessories.....
120344	5234	Oiler (copper plated) with 120345 (Accessories).....
120345	5234	Oiler Spout, 5 in. long, for 120344.....
120371	5208	Feed Dog for 55-5 Machine.....
120372	5209	Guide for 120373.....
120373	5209	Guide (adjustable, hinged) complete for 55-5 Machine, Nos. 286b, 940b, 7071, 28972, 28973, 35610 and 120372.....
120374	—	Presser Foot (right) with 7311, for 120375, obsolete.....
120375	5209	Presser Foot (compensating) complete for 55-5 Machine, Nos. 106b, 220b, 7309, 7310, 15691, 18302 and 120374, obsolete, use 20925.....
120376	5208	Throat Plate with 335b and 18149, for single thread, for 120371.....
120427	—	Guide Holder Shank for 120428.....
120428	5209	Guide (adjustable, hinged) complete for 55-5 Machine, Nos. 286b, 940b, 7071, 28971, 28972, 35610 and 120427.....
120438	5209	Guide for 120439.....
120439	5209	Guide (adjustable, hinged) complete, for thick material, for 55-5 Machine, Nos. 286b, 940b, 7071, 28972, 28973, 35610 and 120438.....
120496	5211	Finger Guard for 120498.....
120497	5211	" " Holder with 50302a, for 120498.....
120498	5211	Finger Guard complete for 55-1, 55-3, 55-5, 55-6, 55-11 and 55-21 Machines, Nos. 236a, 120496 and 120497.....
126036	5212	Under Driver Treadle for 126209.....
126205	5212	" " " Bracket (left) for 126206.....
126206	—	Under Driver Treadle Bracket (left) complete for 126209, Nos. 23258, 126205, 126207, 126208 and two wood screws 1 in. No. 14.....
126207	5211	Under Driver Treadle Bracket (left) Hook for 126206.....
126208	5211	Under Driver Treadle Bracket (left) Hook Rivet for 126206.....
126209	—	Under Driver Treadle complete for 126210, Nos. 60502, 126036 and 126206.....
126210	—	Under Driver Treadle and Pitman complete for 27645, Nos. 27640 and 126209

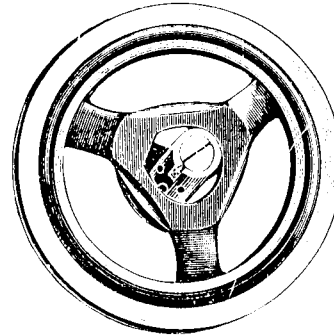
NO.	PLATE	NAME
126315	5212	Under Driver Driving Pulley (grooved) 6 in. diam., with 27598, 50992c, 126318 and two 7958, for 27644.....
126316	5210	Under Driver Driving Pulley Hollow Stud with 27600 and 126317, for 27644.....
126317	5211	Under Driver Driving Pulley Hollow Stud Oil Pad (felt) for 126316.....
126318	—	Under Driver Driving Pulley Oil Pad (felt) for 126315.....
126321	5212	Under Driver Cone Pulley (grooved) three speed, 2½ in., 3¾ in. and 5¼ in. diam., with 27473, for 27644.....
200383c	5211	Thread Unwinder Spool Rest Rod Set Screw for 202490.....
201018c	5211	Thread Unwinder Spool Rest Set Screw for 225389 and 225395.....
201696j	5211	Thread Unwinder Thread Guide Lock Nut for 225394, 225396 and 225398....
202490	3398	Thread Unwinder Spool Stand with 200383c, for 225394, 225396 and 225398
210958	5241	Needle Bar Thread Retaining Collar for 18343, 18345 and 18350, obsolete.....
225388	3398	Thread Unwinder Spool Rest Rod for 225394, 225396 and 225398.....
225389	3398	Thread Unwinder Spool Rest with 201018c, for 225394.....
225390	7234	Thread Unwinder Thread Cone Holder, for inverted cones, for 225394, 225396 and 225398.....
225391	3398	Thread Unwinder Thread Guide for 225394, 225396 and 225398.....
225392	3398	Thread Unwinder Thread Guide Rod with 208E and 225393, for 225394, 225396 and 225398.....
225393	5211	Thread Unwinder Thread Guide Rod Washer for 225392.....
225394	3398	Thread Unwinder complete, for one spool, Nos. 201696j, 202490, 225388, 225389, 225391, 225392 and three wood screws ⅞ in. No. 13.....
225395	7233	Thread Unwinder Spool Rest with 201018c, for 225396 and 225398.....
225396	7233	Thread Unwinder complete, for two spools, Nos. 201696j, 202490, 225388, 225392, 225395, two 225391 and three wood screws ⅞ in. No. 13.....

NO.	PLATE	NAME
225398	8953	Thread Unwinder complete, for four spools, Nos. 201696j, 202490, 225388, 225392, two 225395, four 225391 and three wood screws ⅞ in. No. 13.....

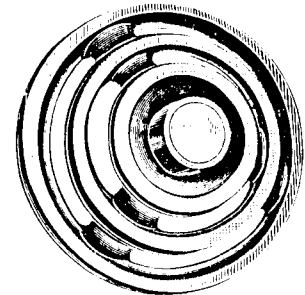
ILLUSTRATIONS
OF
PARTS

PLATE 362 ONE-FOURTH SIZE

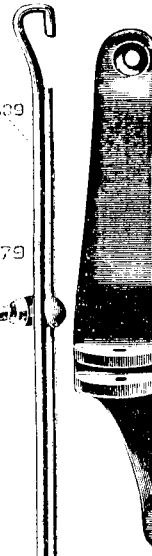
27630



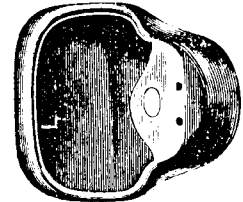
27509



27640



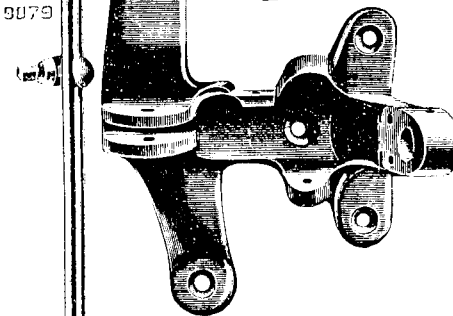
27635



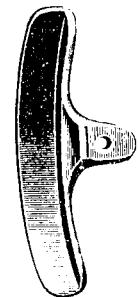
27609

9079

27634



27503



27637



41338

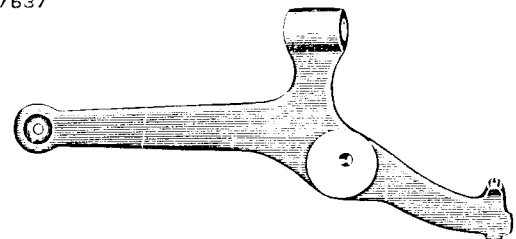


PLATE 363—ONE-FOURTH SIZE

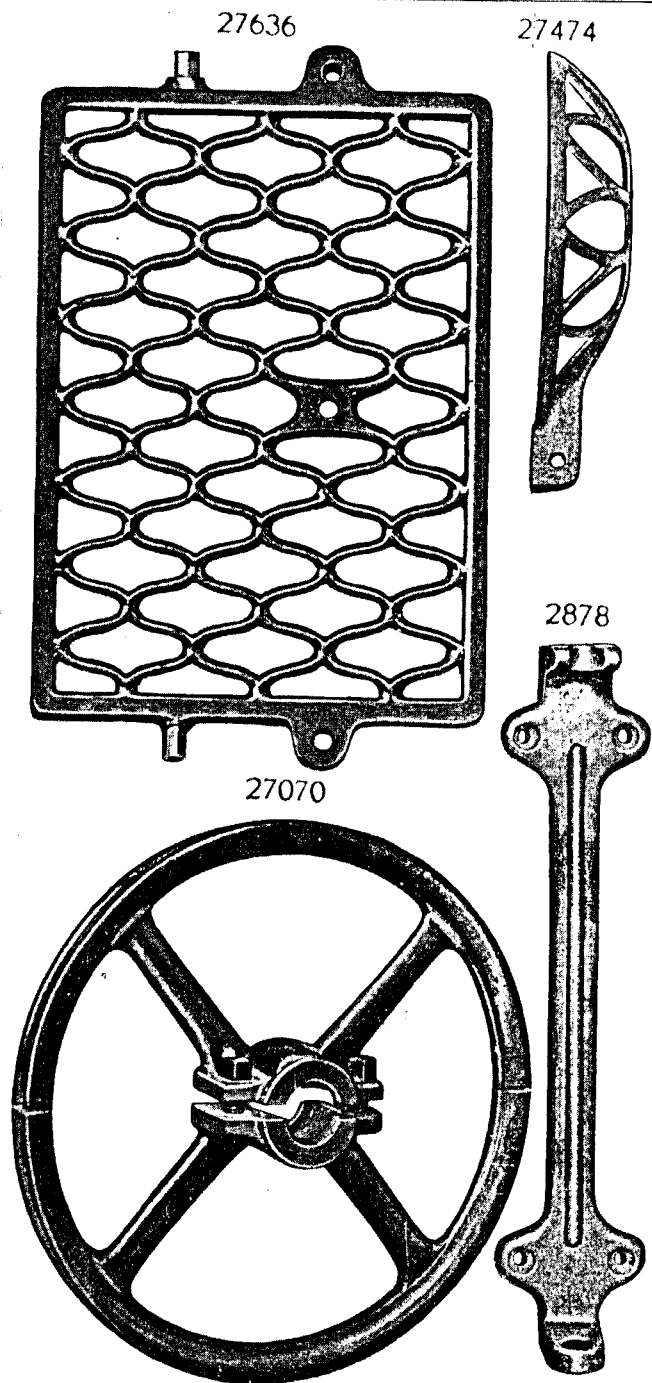


PLATE 819—ONE-FOURTH SIZE

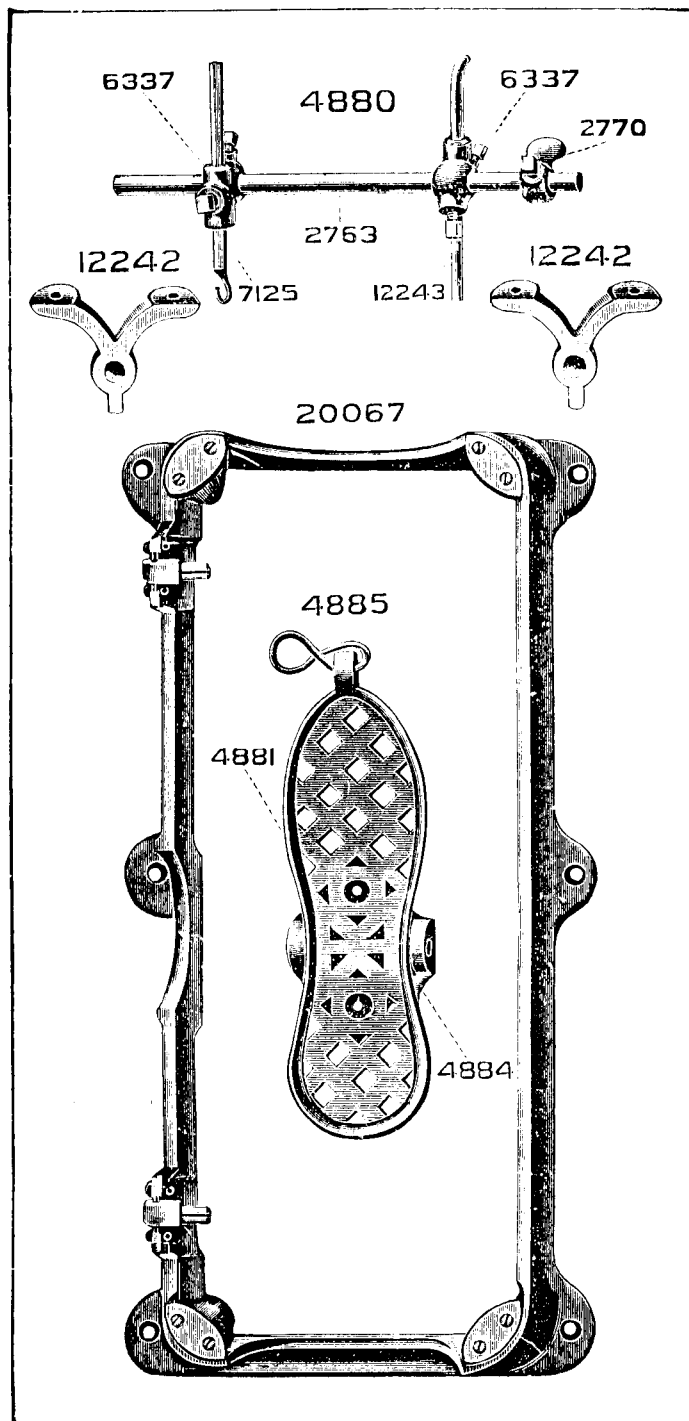
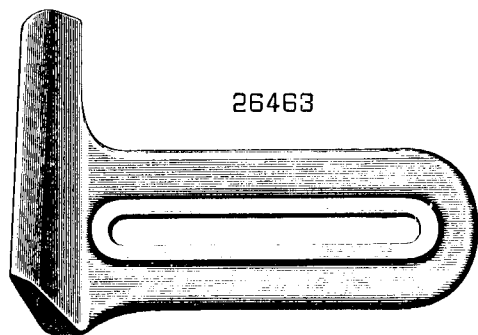
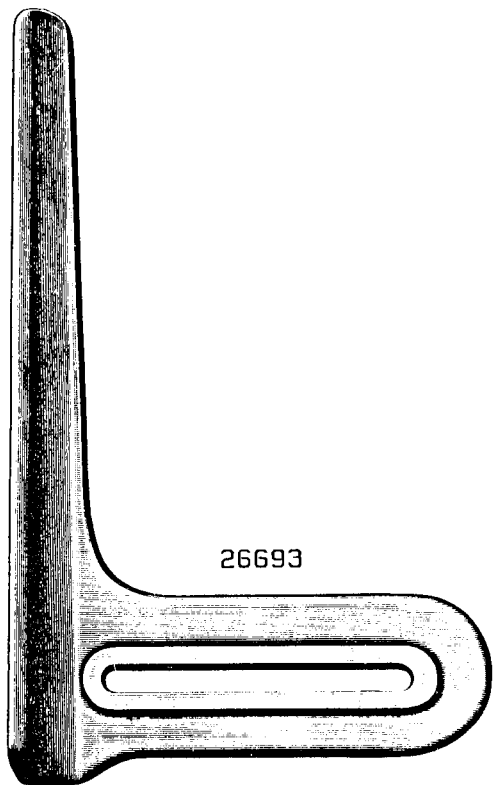


PLATE 956—FULL SIZE



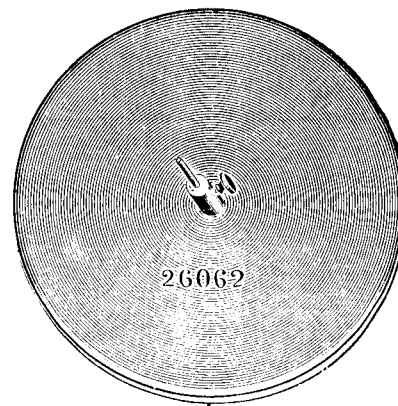
26463



26693

PLATE 989—ONE-FOURTH SIZE

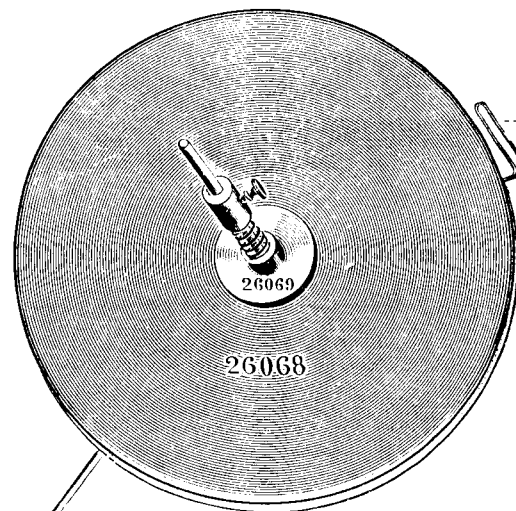
26063



26062

26061

26074



26069

26068

26072

26066

PLATE 1101—FULL SIZE

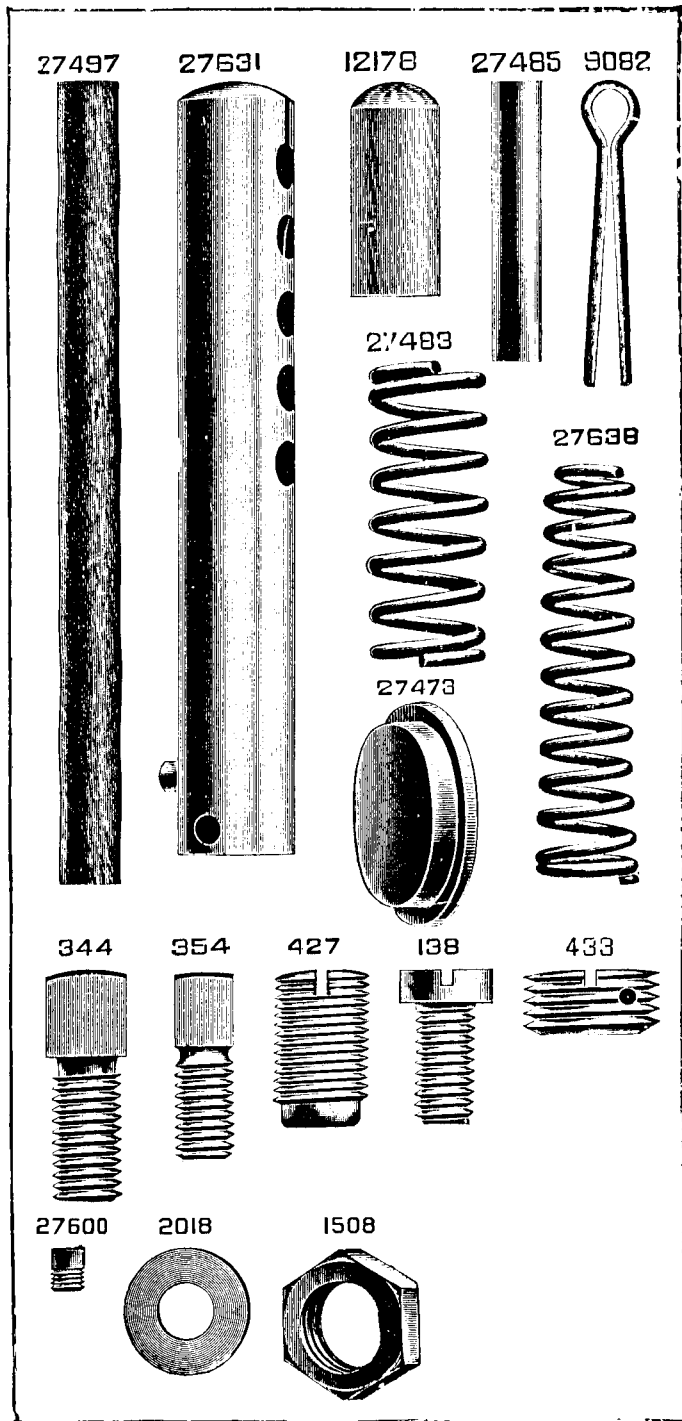


PLATE 1206—FULL SIZE

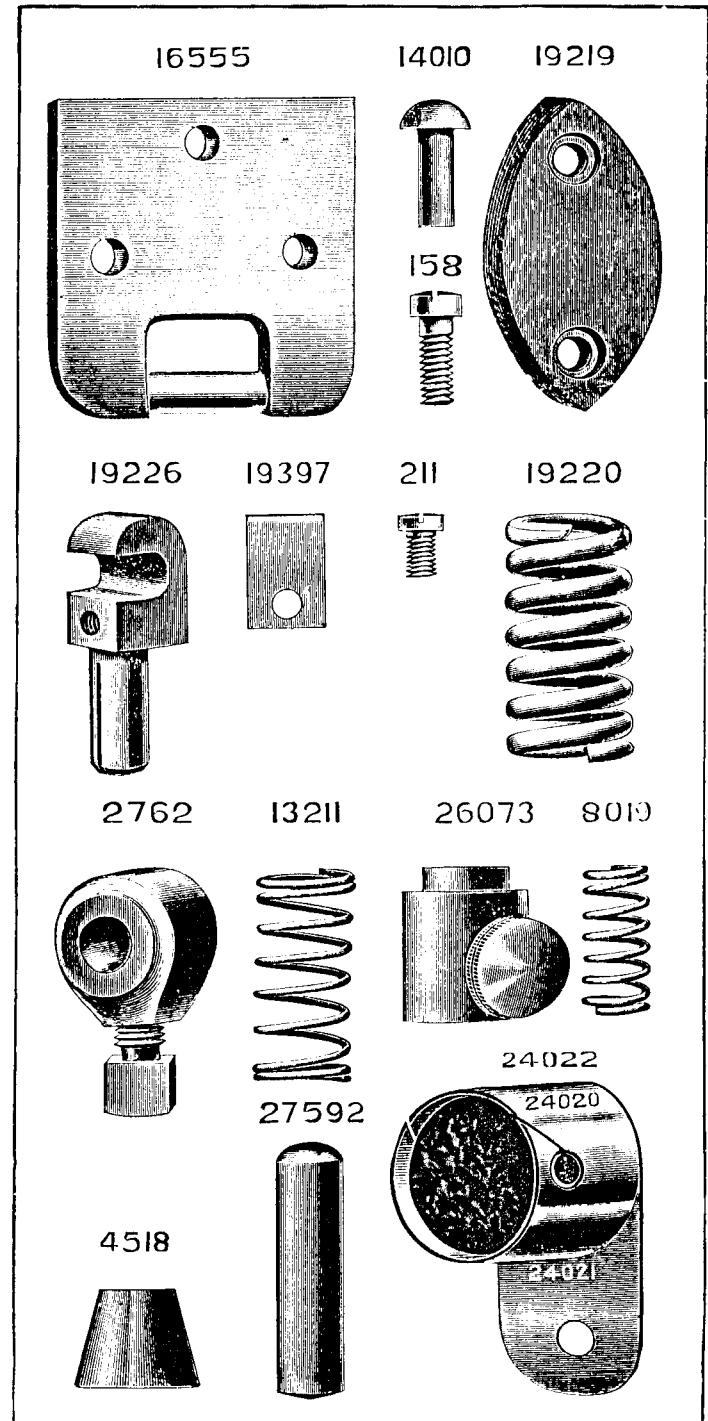


PLATE 3398—ONE-FOURTH SIZE

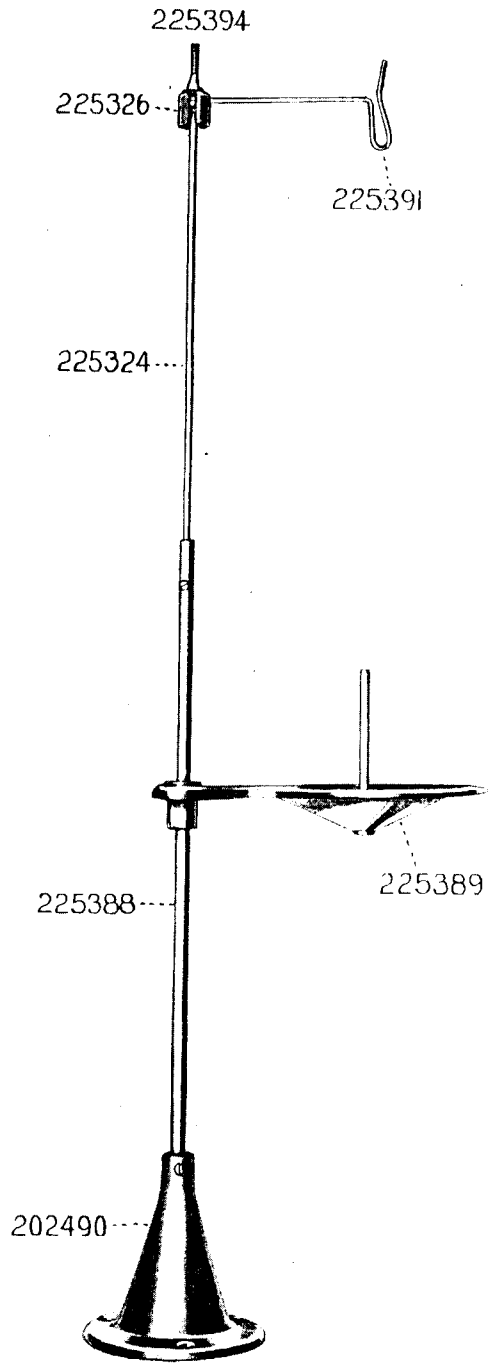


PLATE 3813—ONE-NINTH SIZE

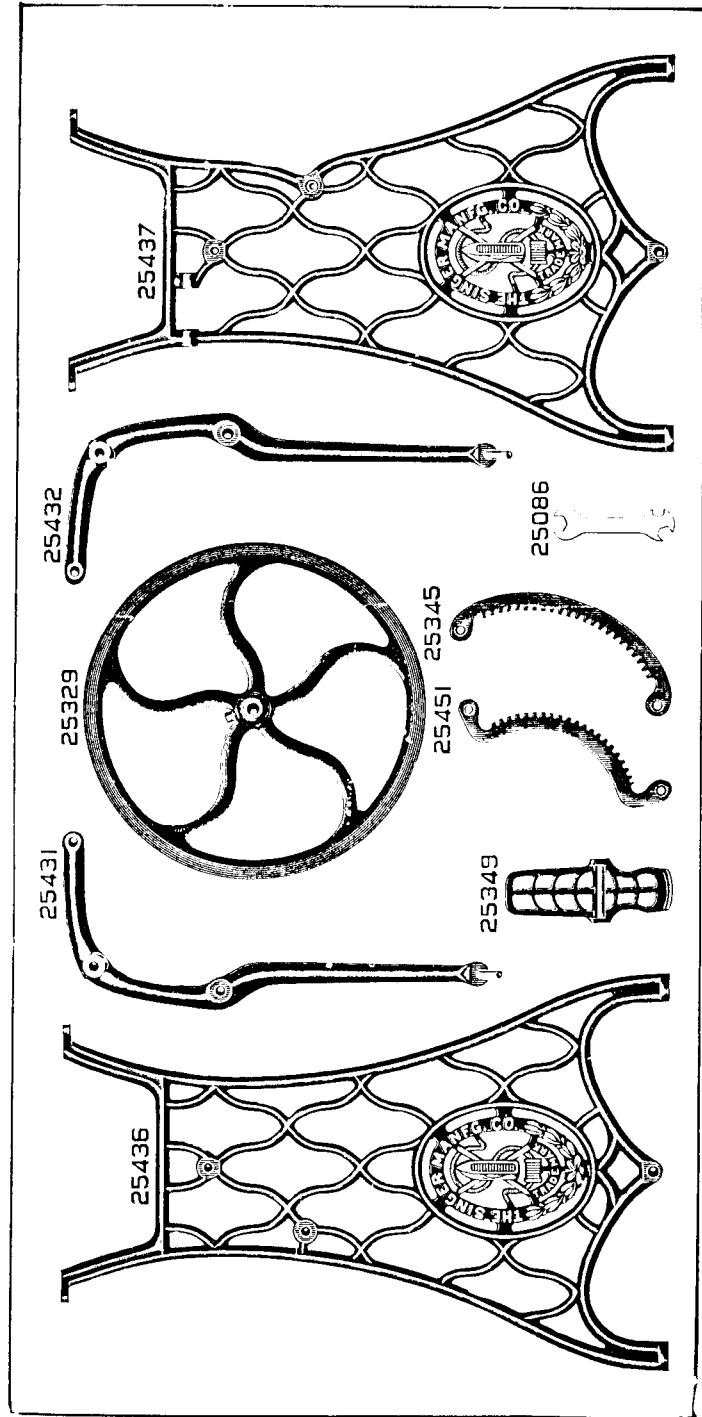


PLATE 3814—ONE-NINTH SIZE

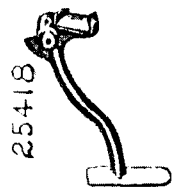
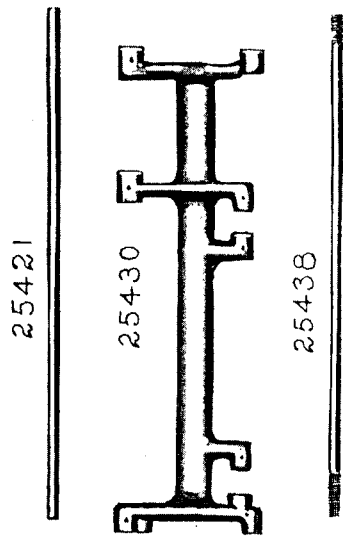
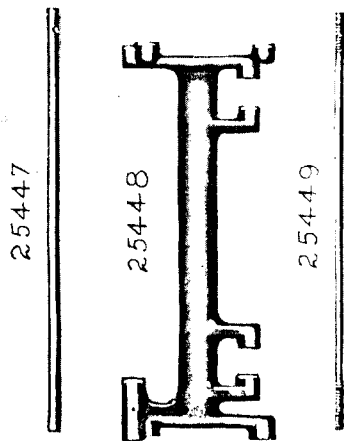


PLATE 3815—ONE-HALF SIZE

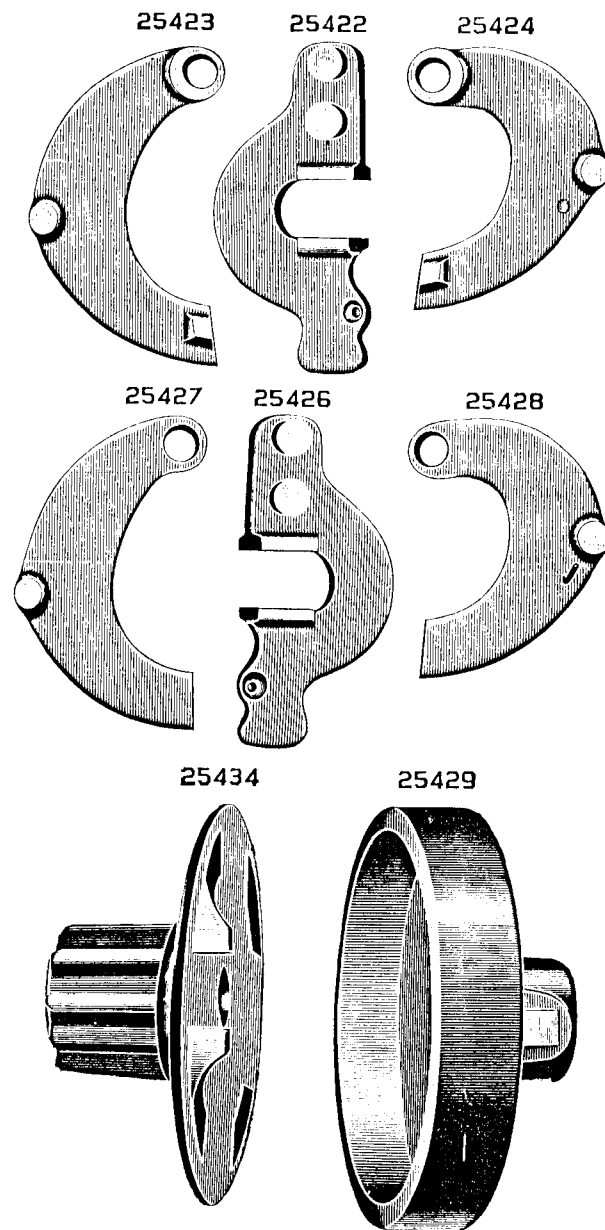


PLATE 3816—ONE-HALF SIZE

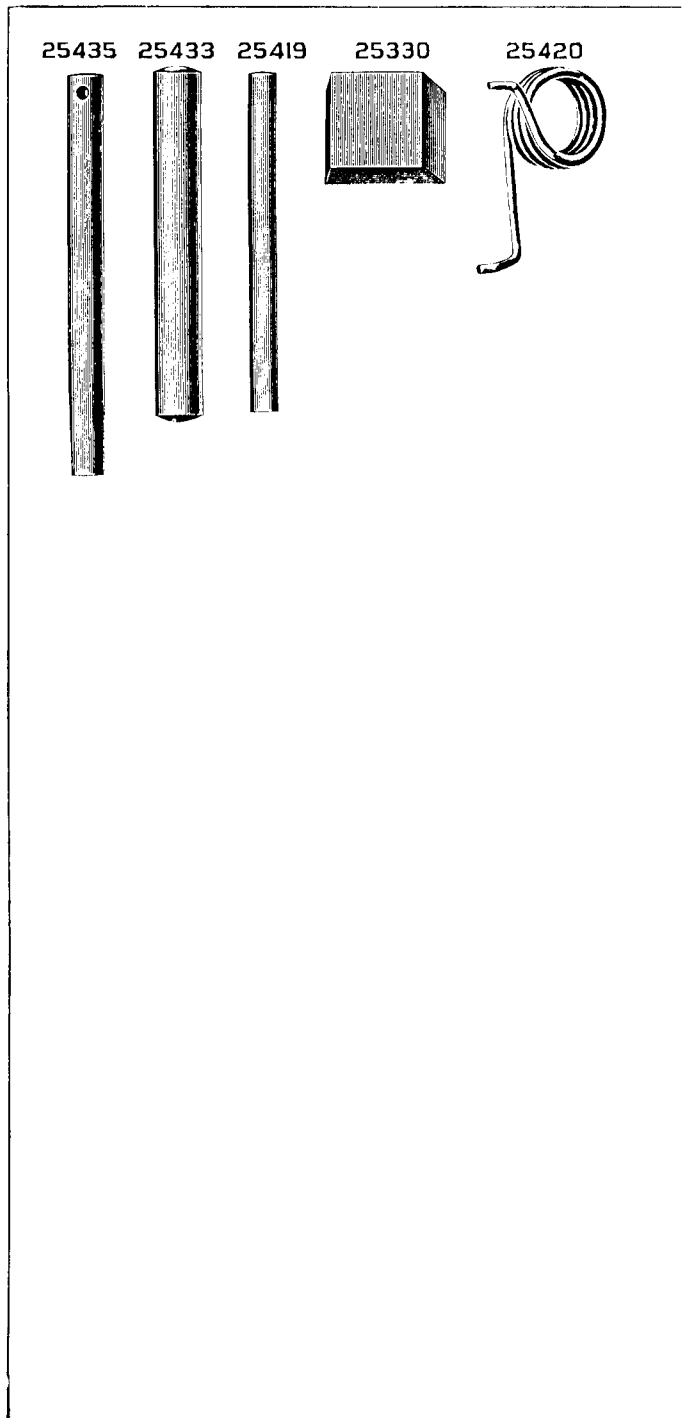


PLATE 3817—FULL SIZE

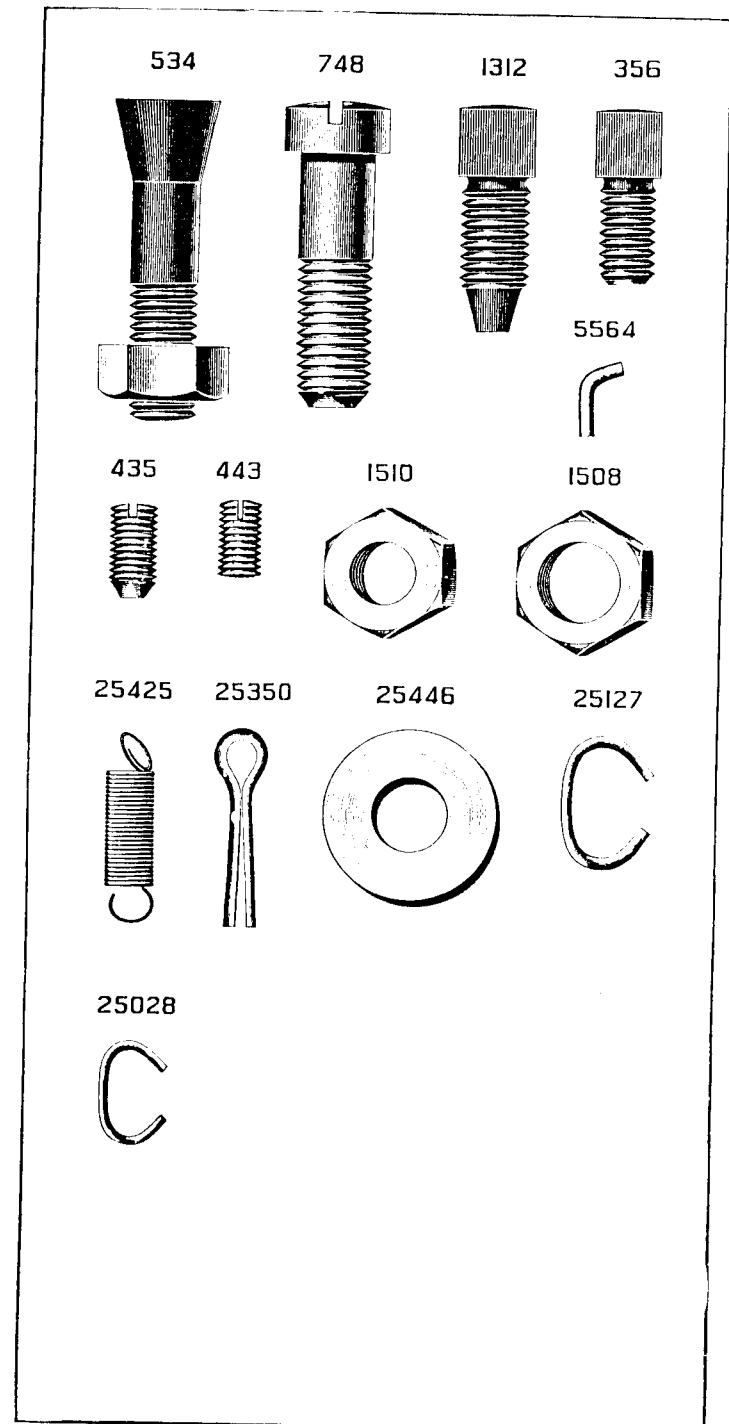


PLATE 3826—FULL SIZE

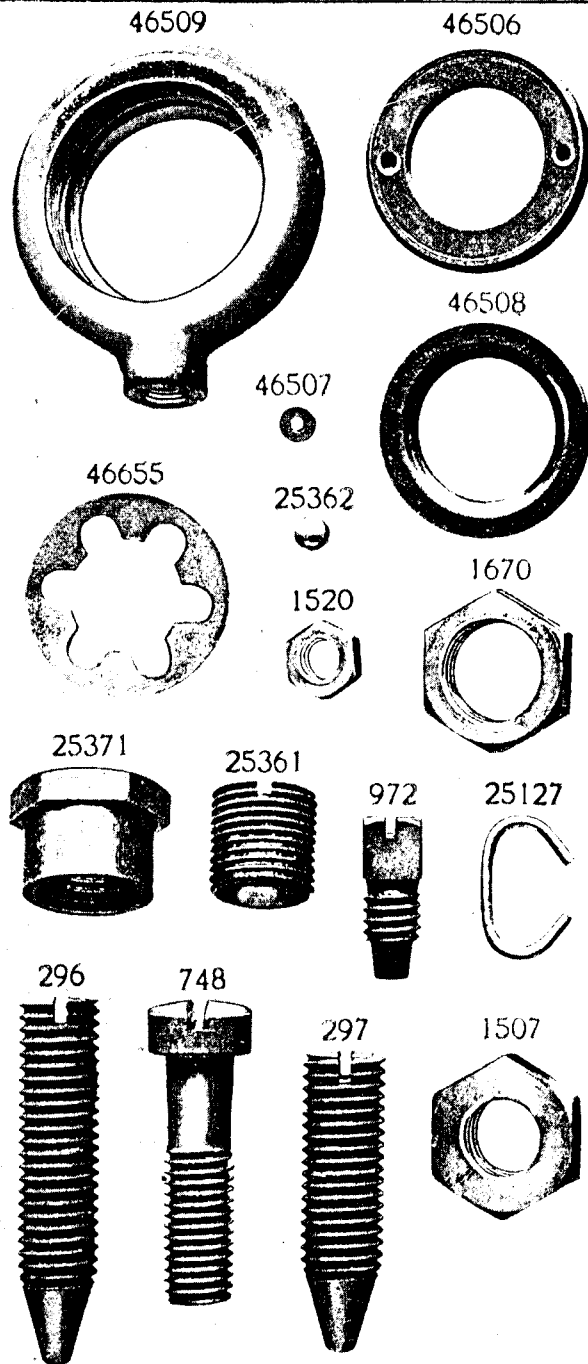


PLATE 5150—ONE-FOURTH SIZE

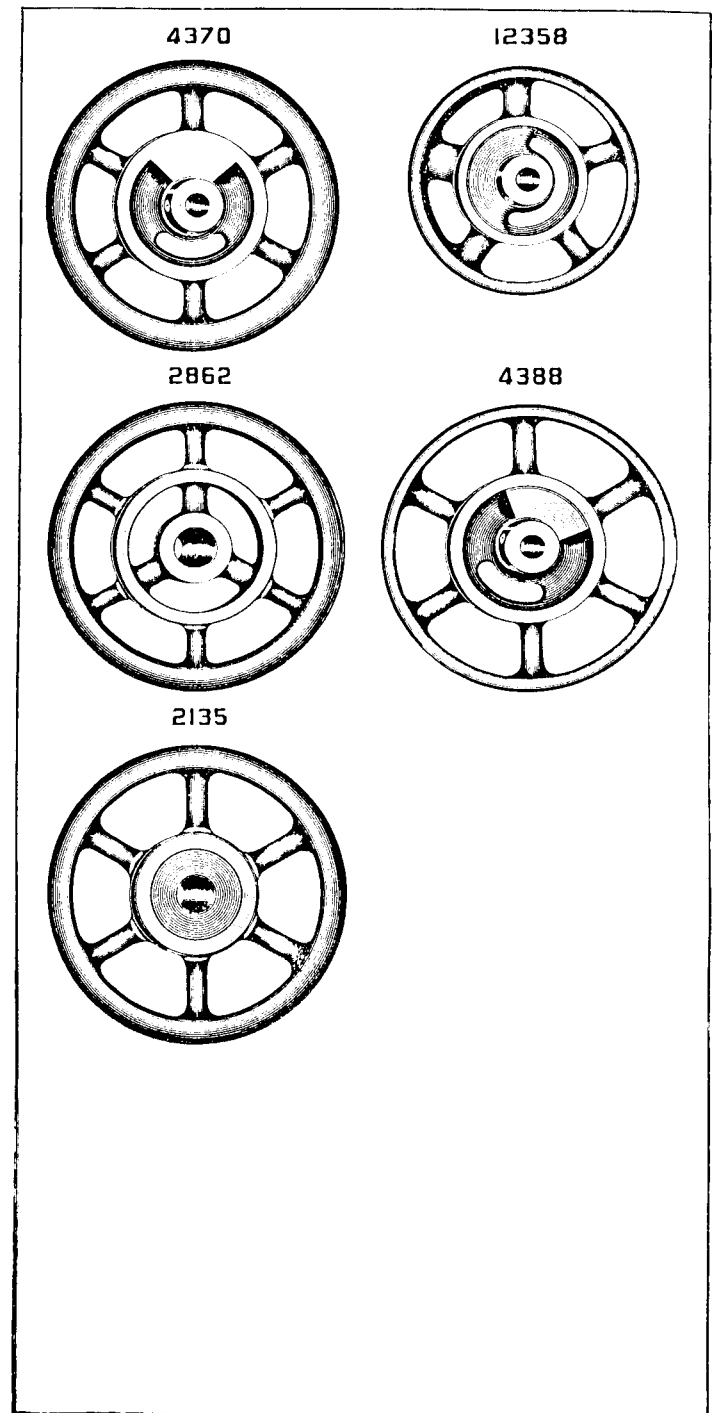


PLATE 5151—ONE-FOURTH SIZE

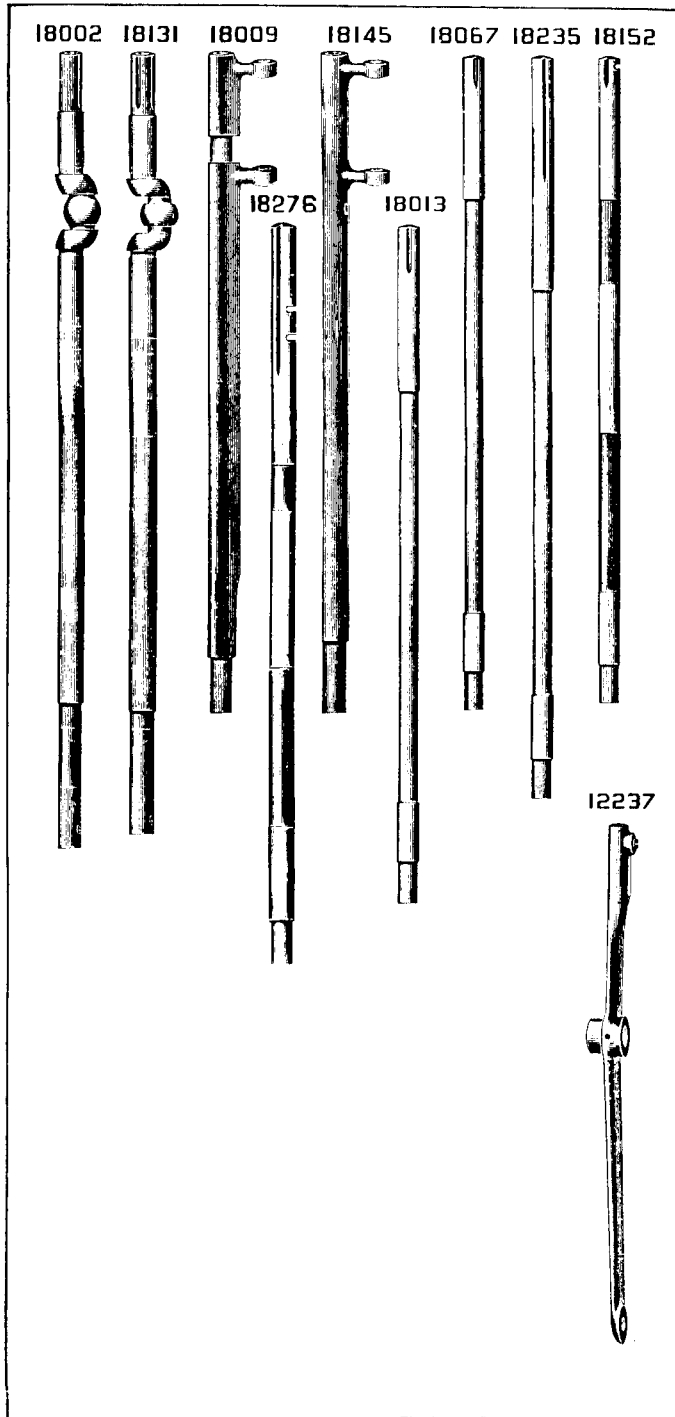


PLATE 5152—ONE-HALF SIZE

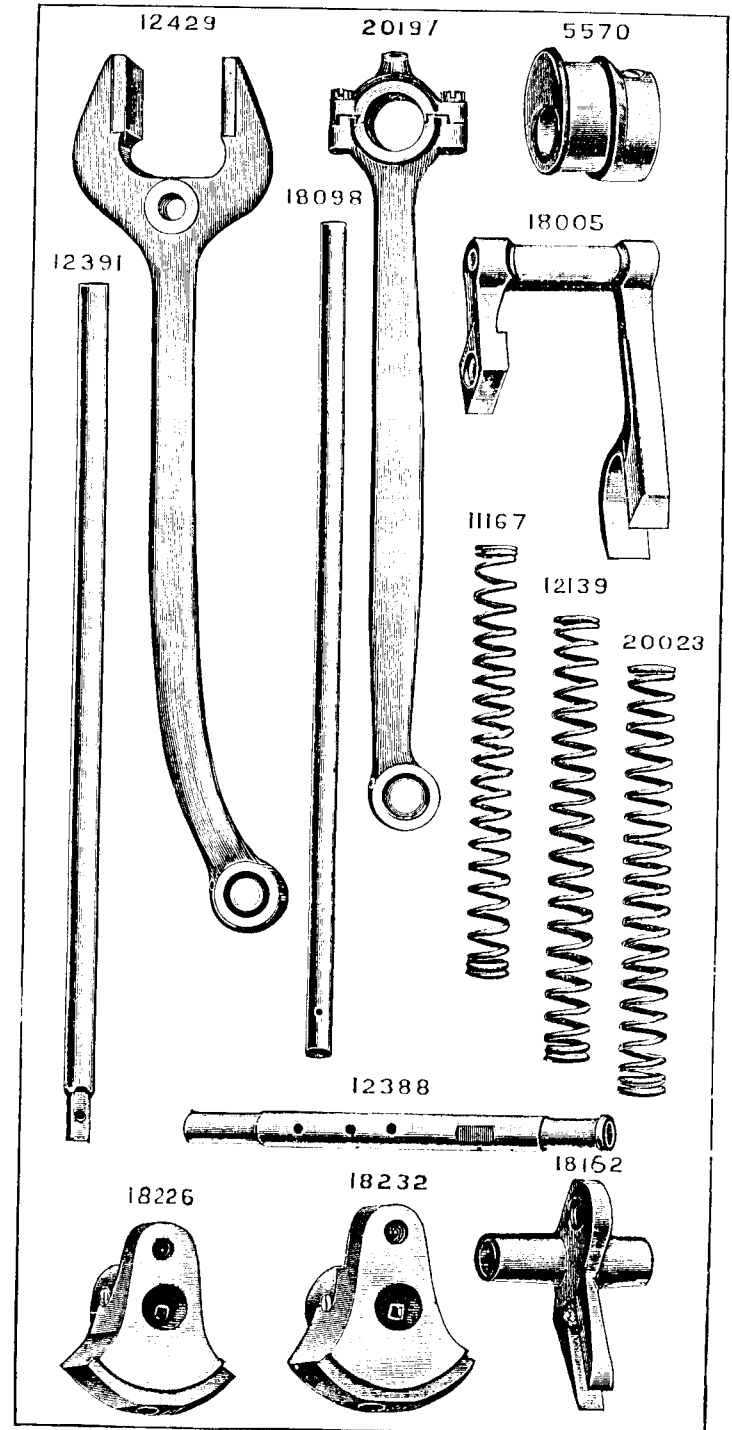


PLATE 5153—ONE-HALF SIZE

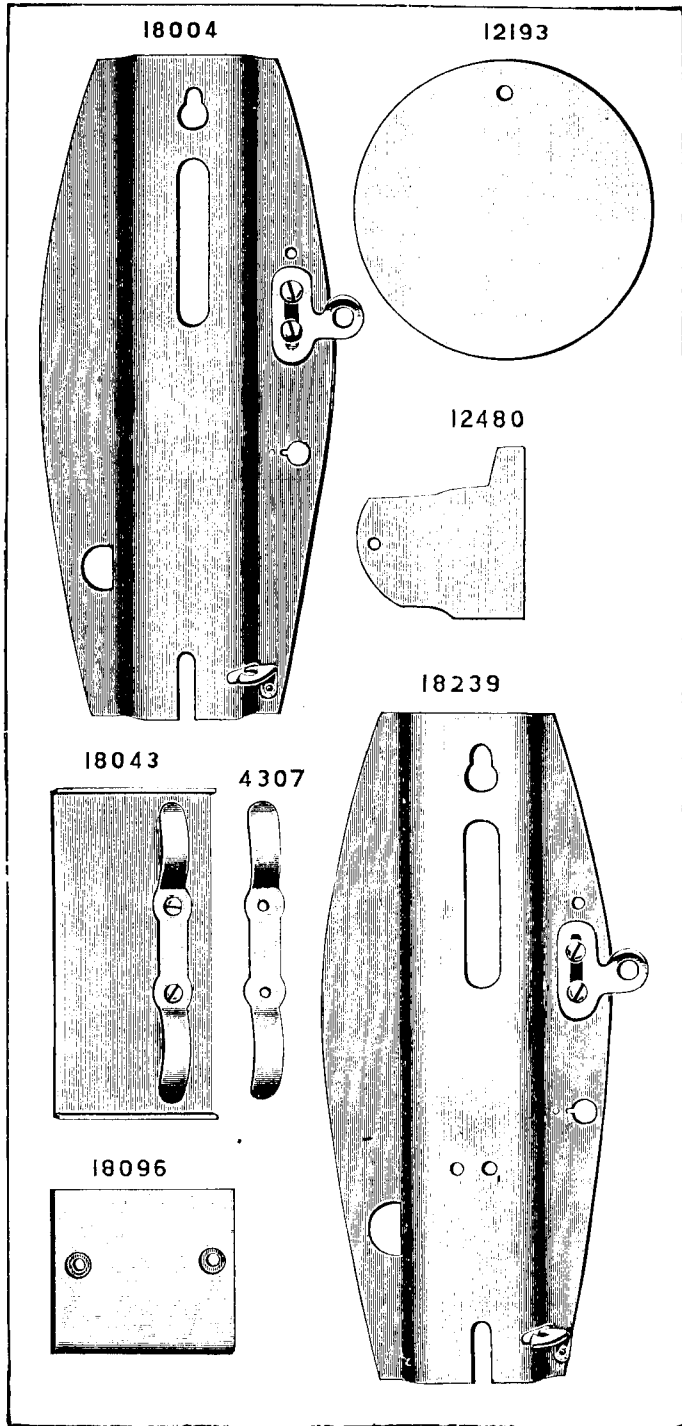


PLATE 5154—ONE-HALF SIZE

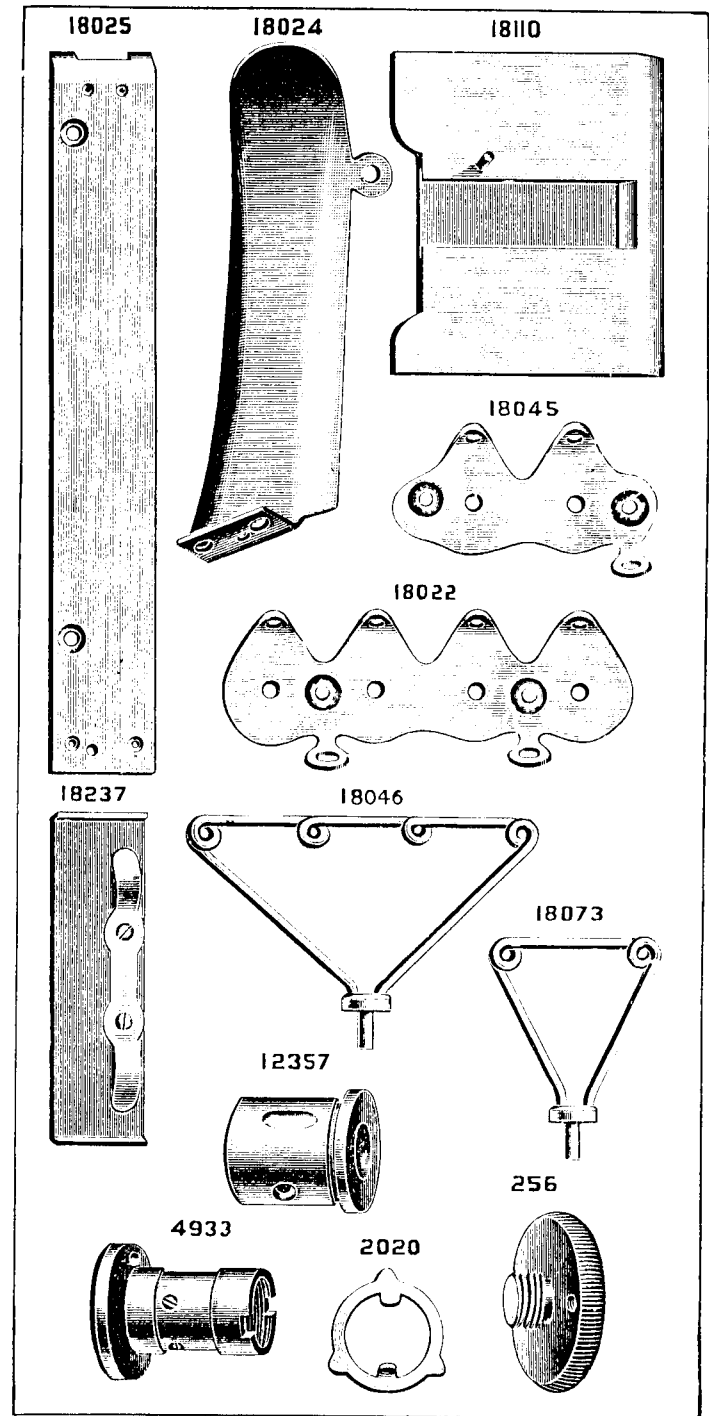


PLATE 5155—FULL SIZE

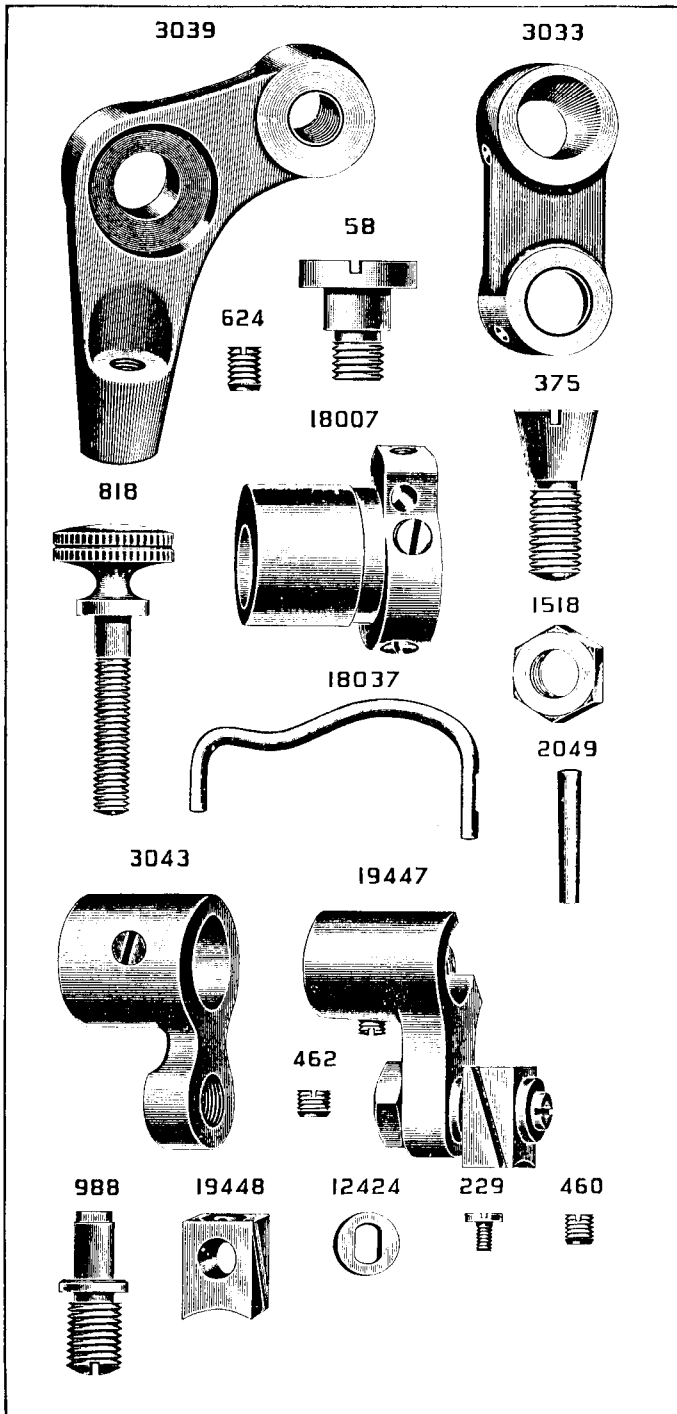


PLATE 5156—FULL SIZE

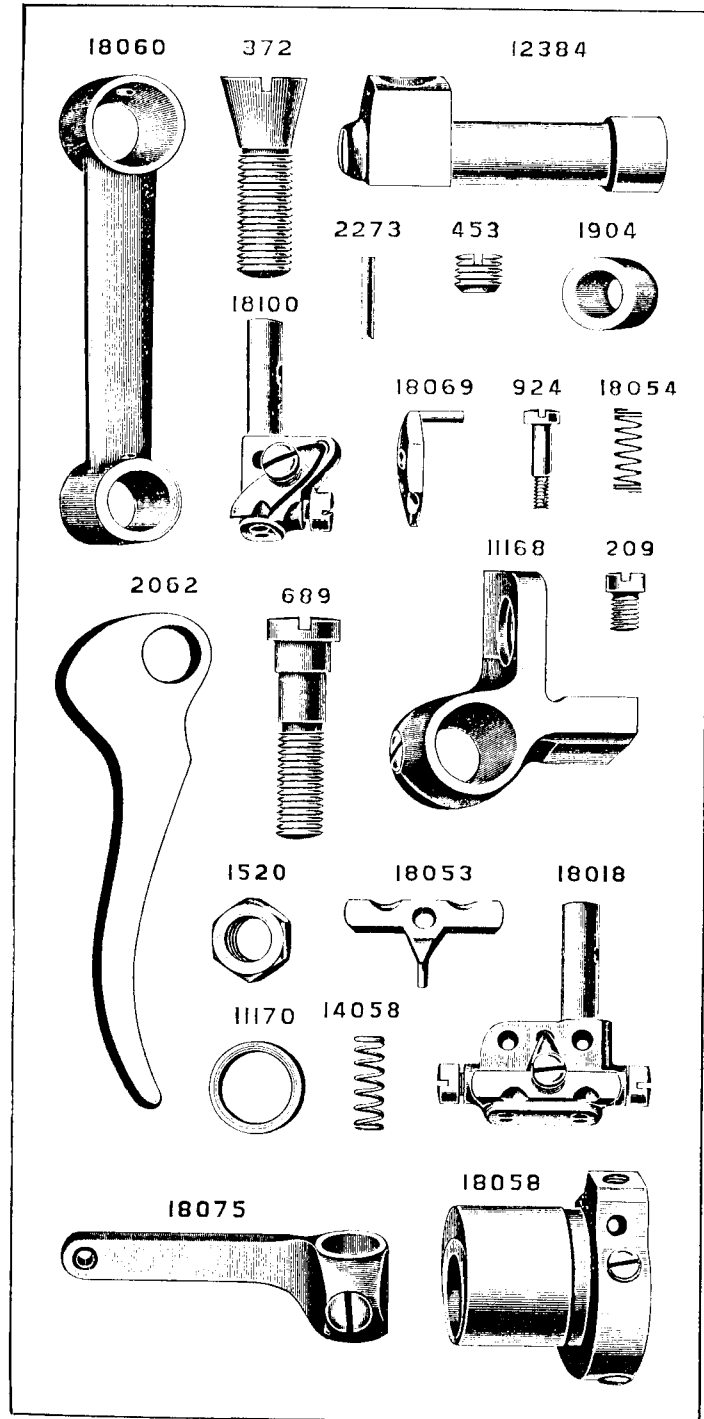


PLATE 5157—FULL SIZE

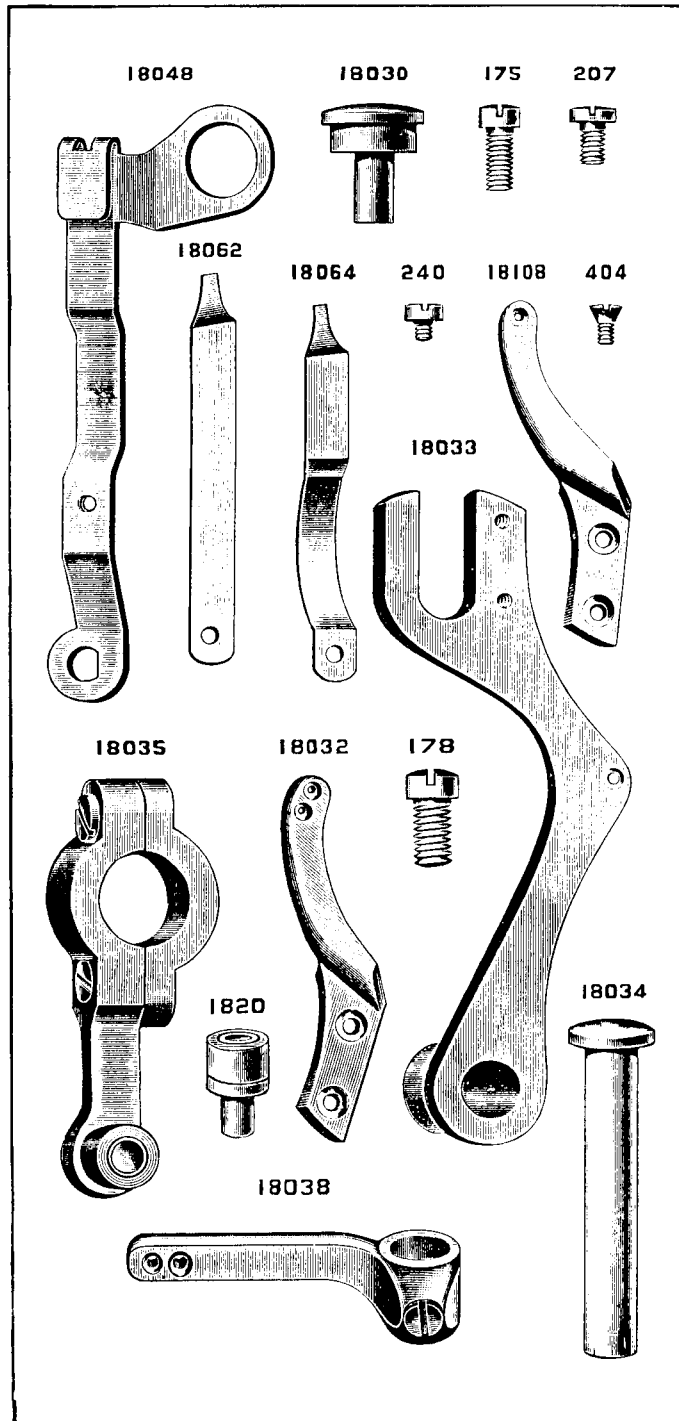


PLATE 5158—FULL SIZE

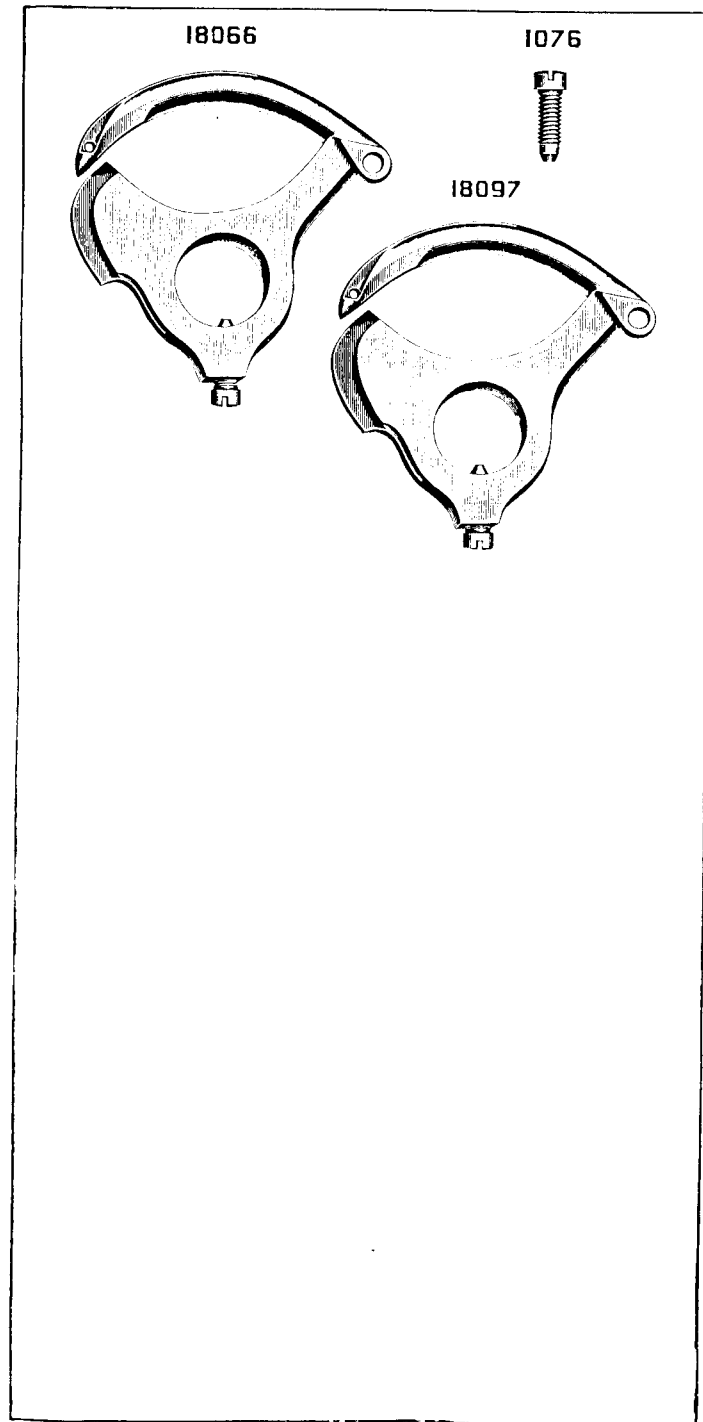


PLATE 5159—FULL SIZE

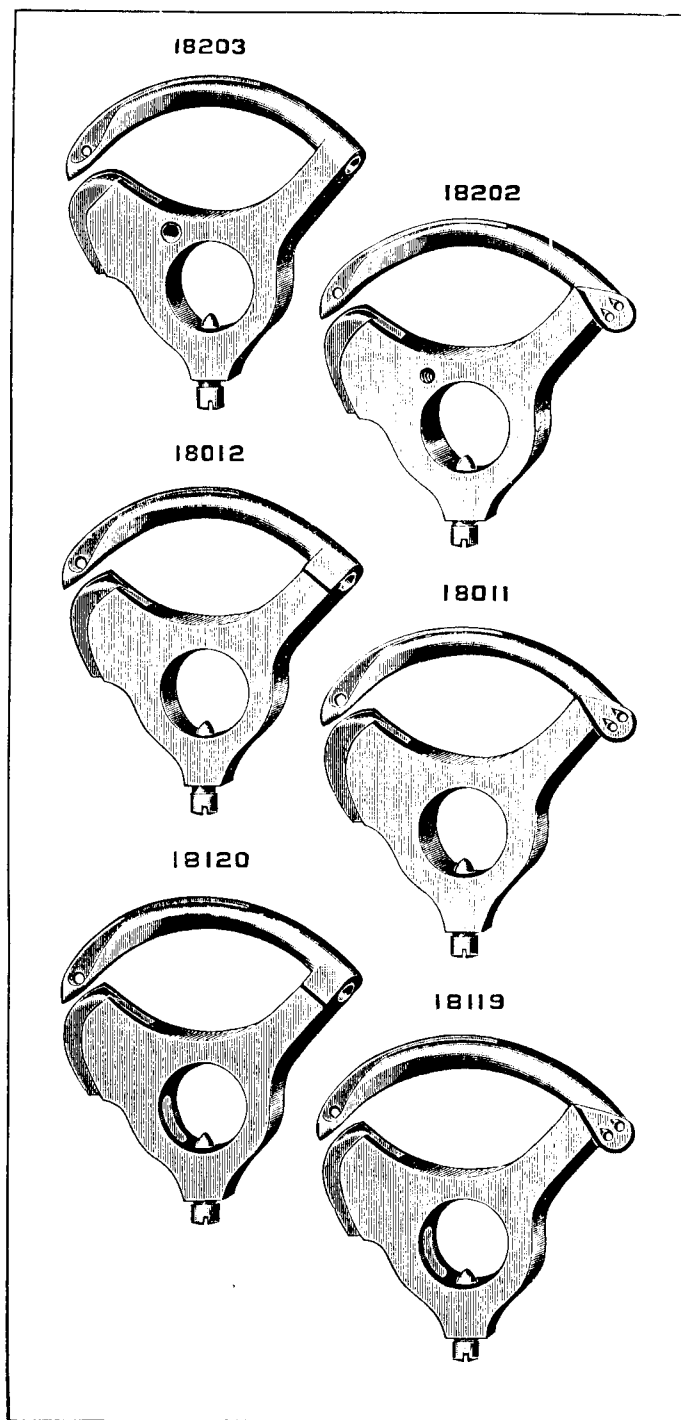


PLATE 5160—FULL SIZE

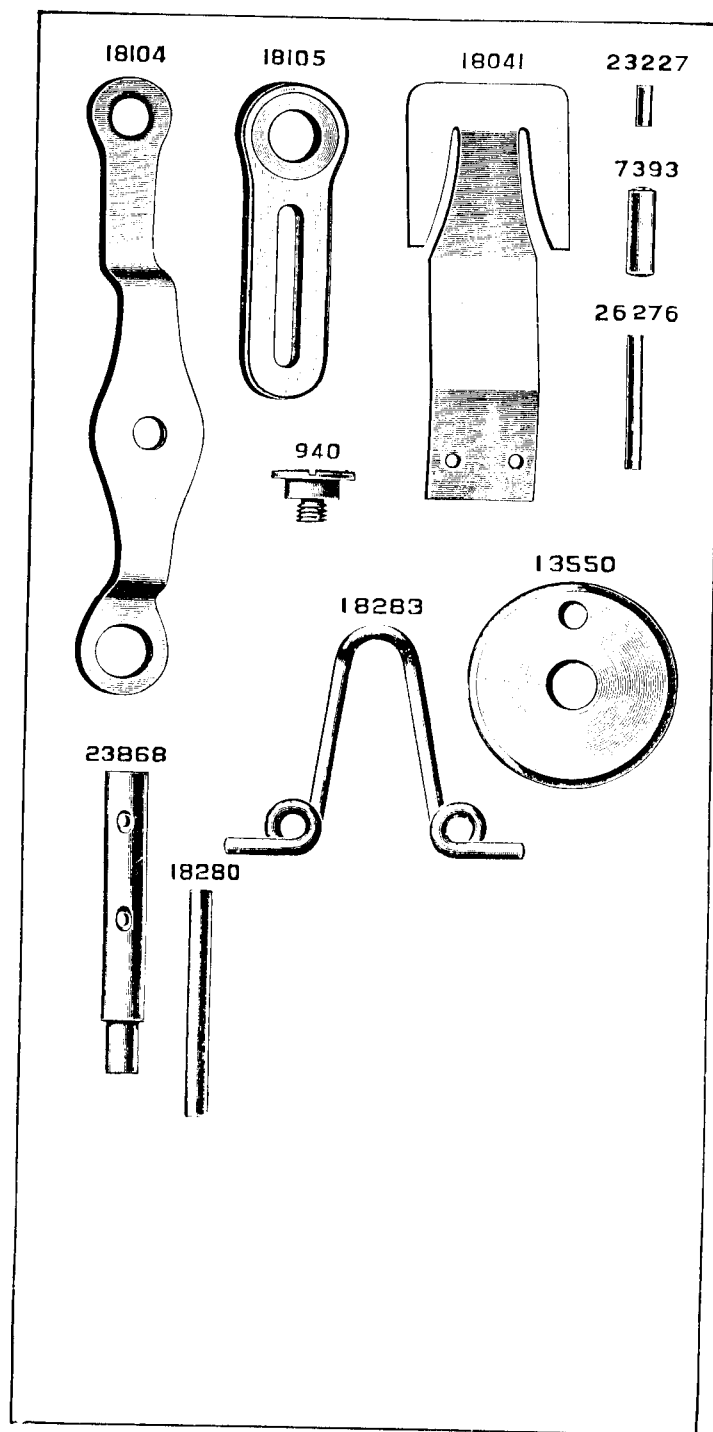


PLATE 5161—FULL SIZE

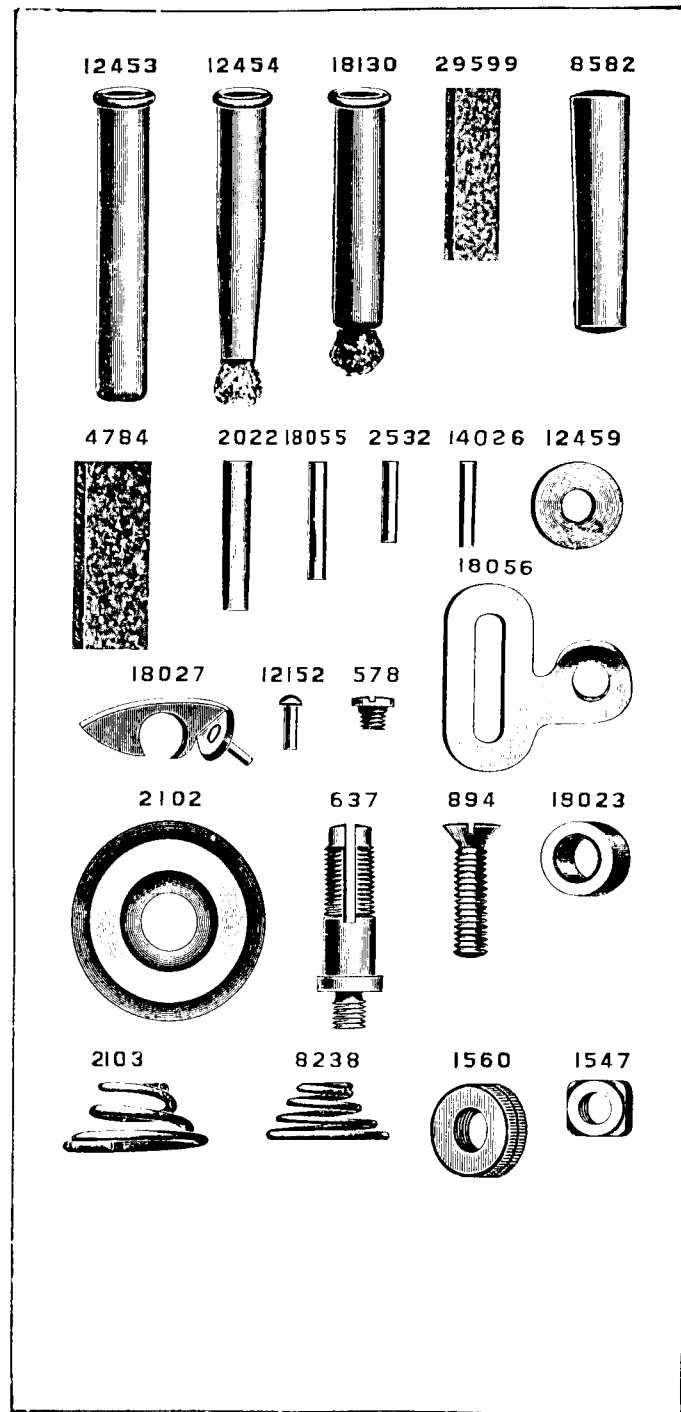


PLATE 5162—FULL SIZE

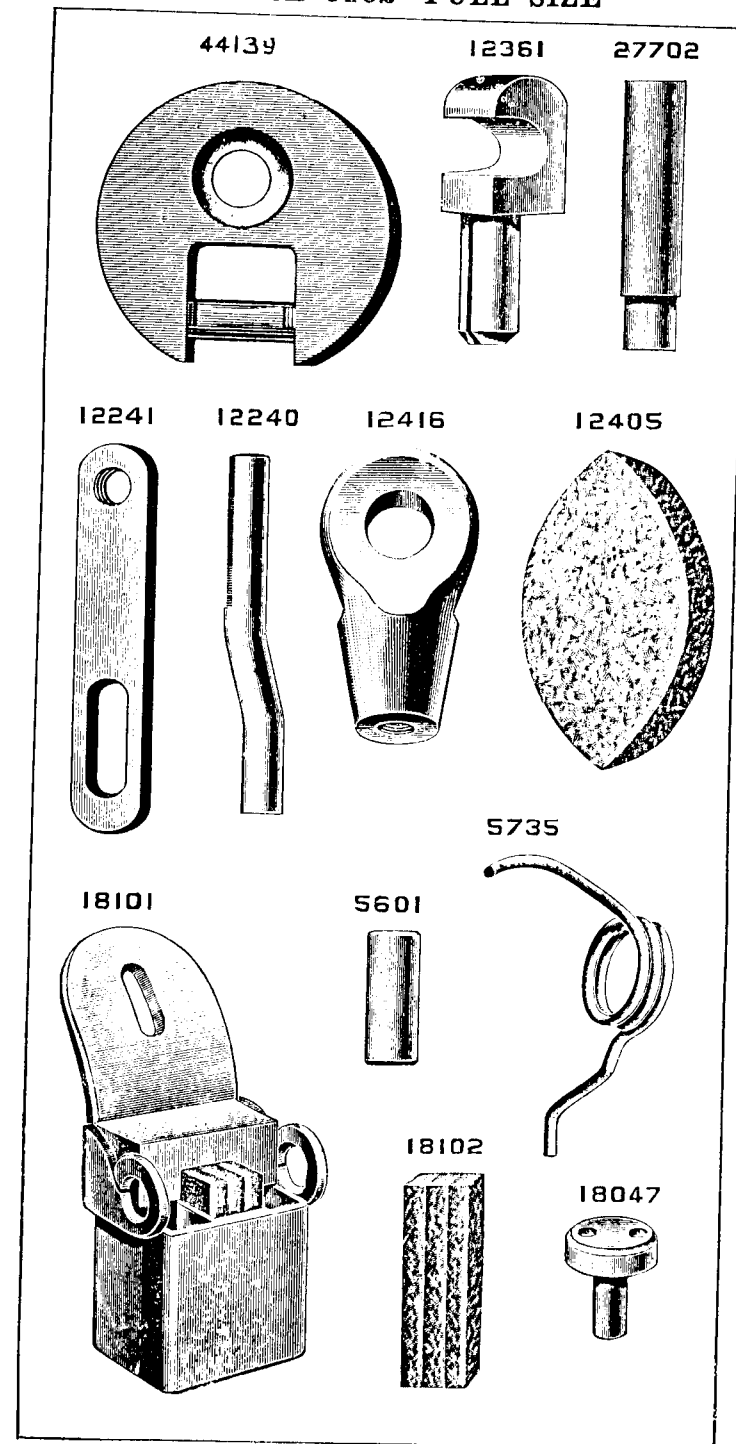


PLATE 5163—FULL SIZE

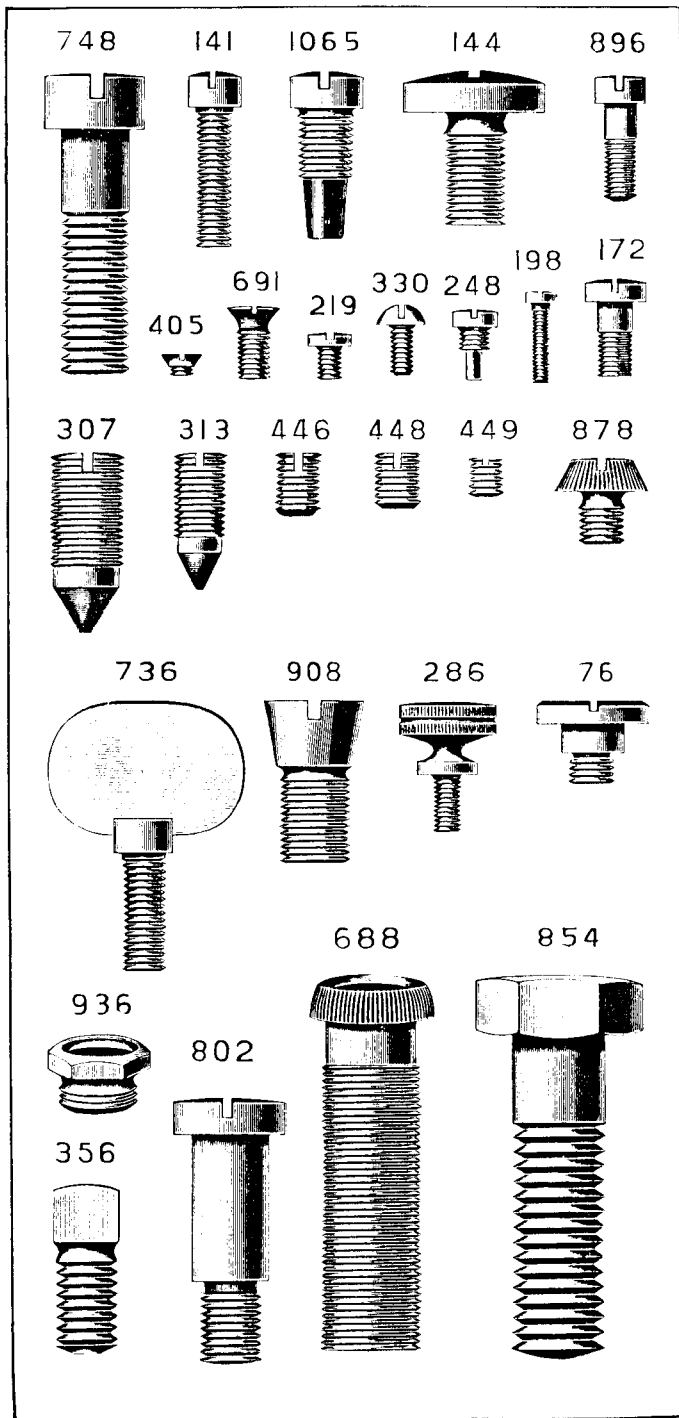


PLATE 5164—FULL SIZE

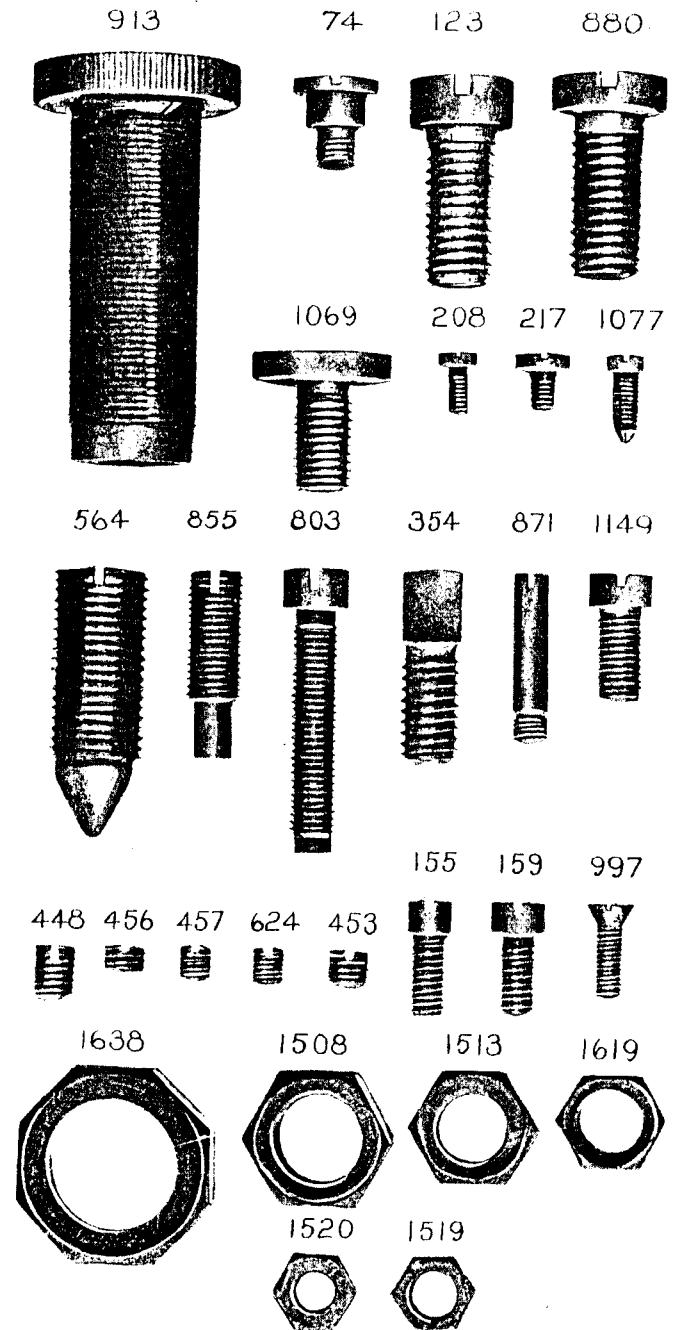


PLATE 5166—ONE-HALF SIZE

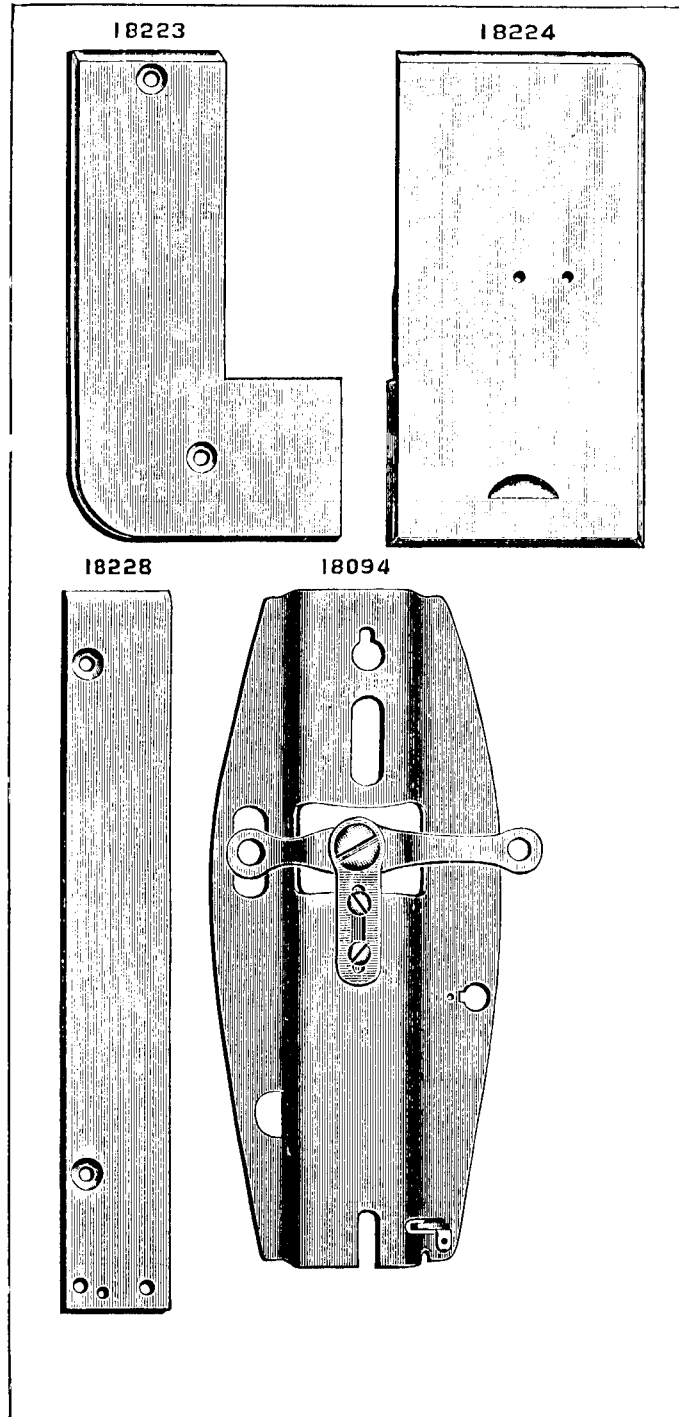


PLATE 5167—ONE-HALF SIZE

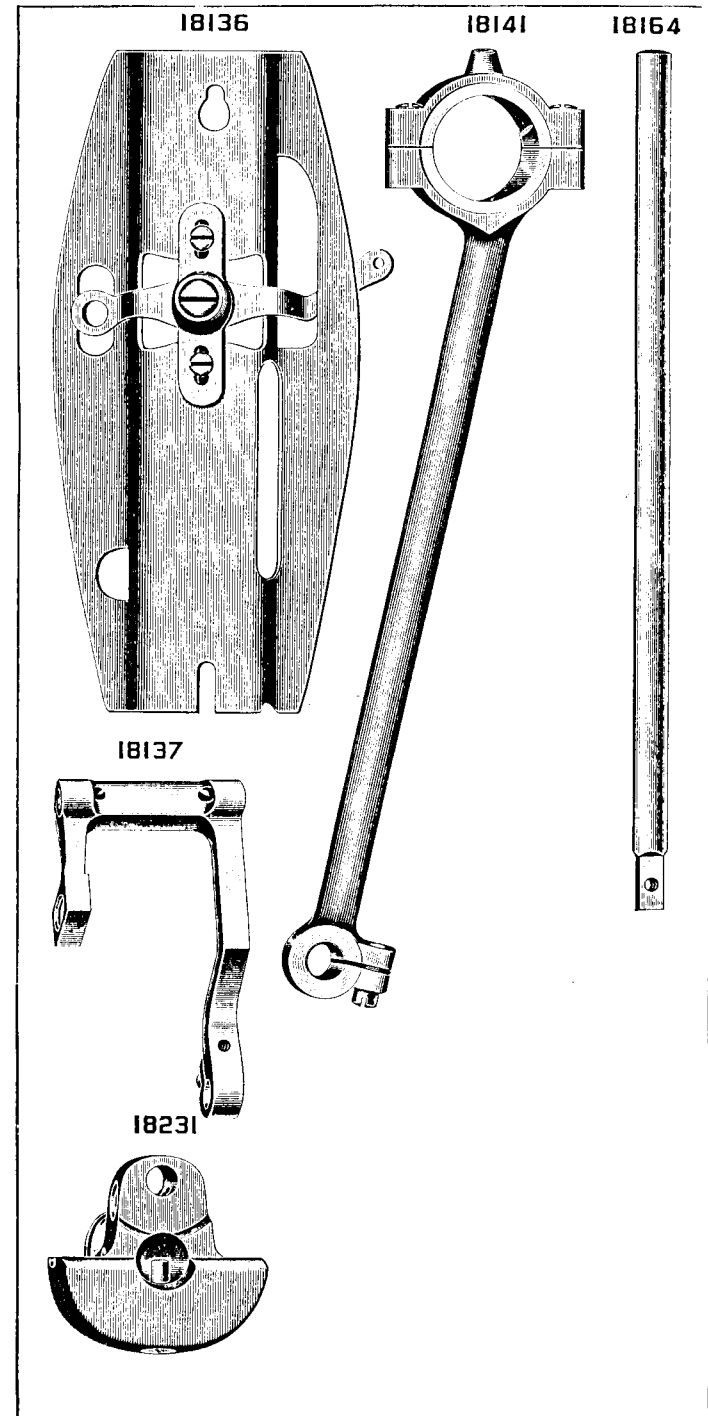


PLATE 5168—ONE-HALF SIZE

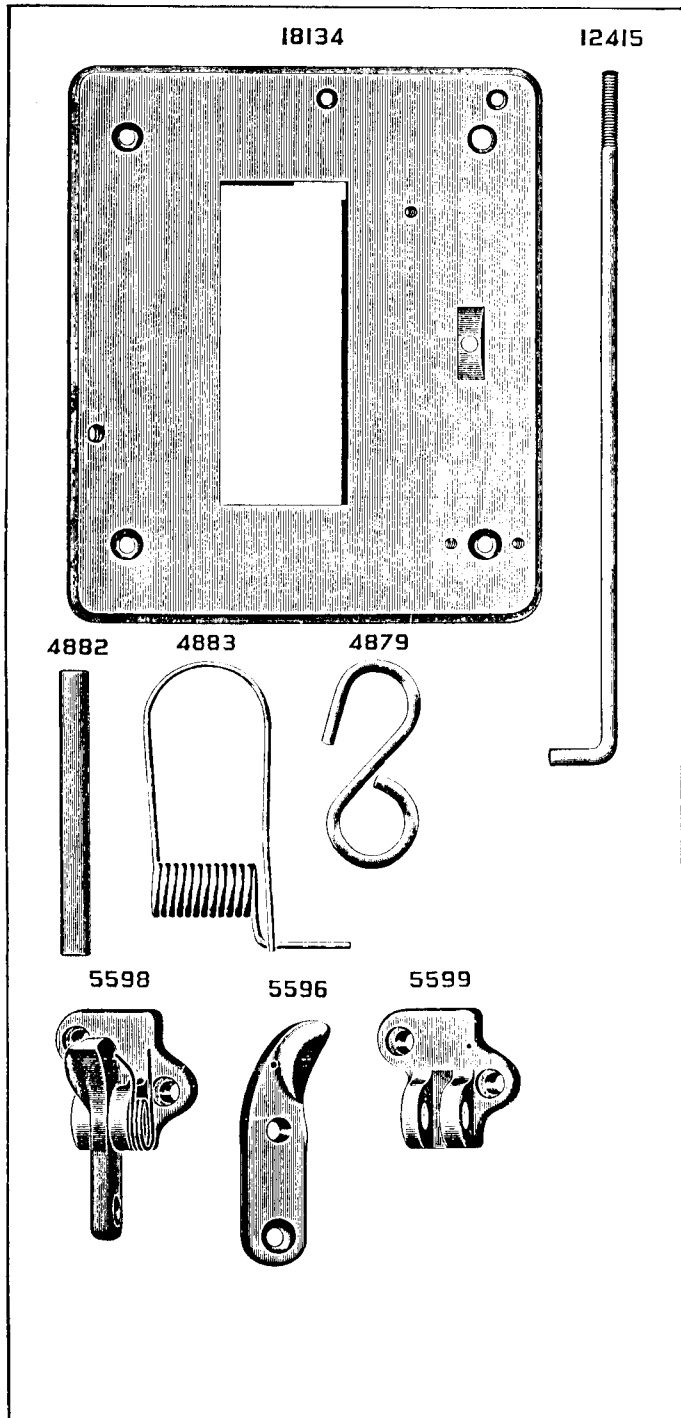


PLATE 5169—FULL SIZE

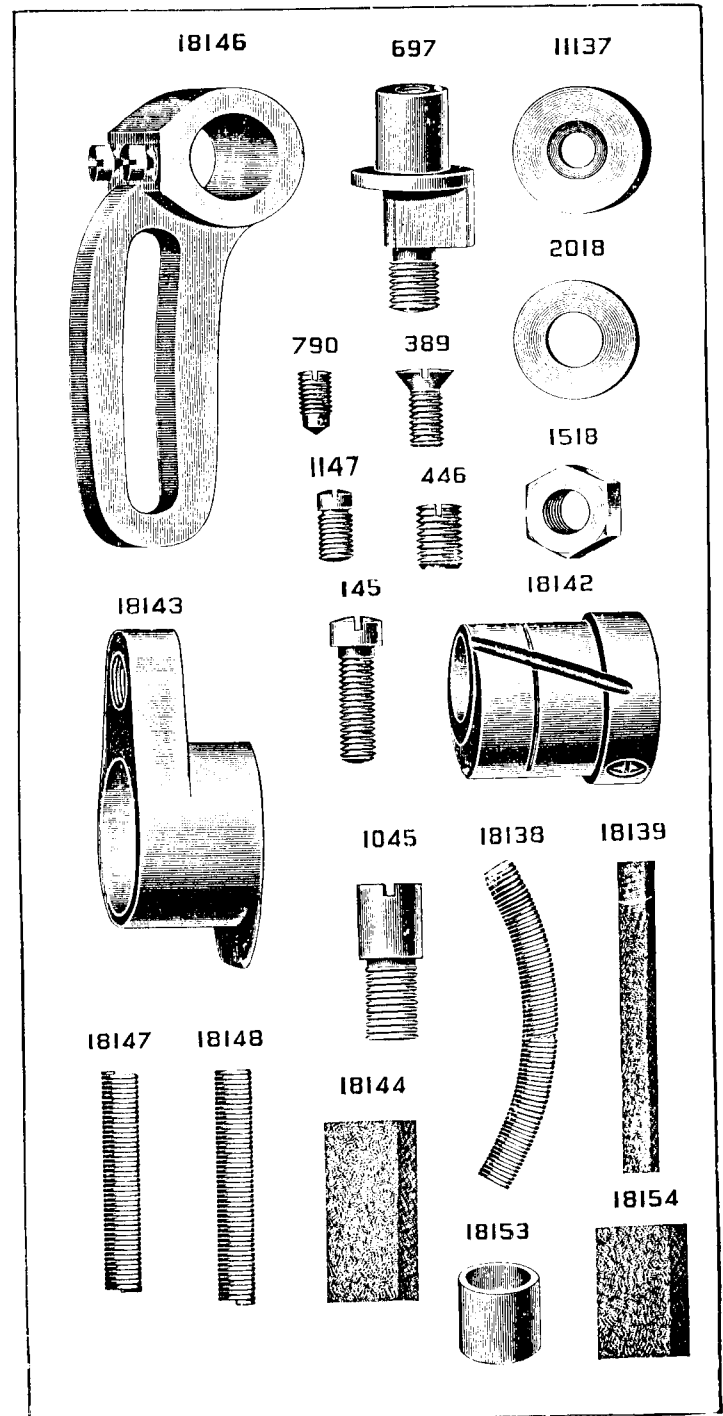


PLATE 5170—FULL SIZE

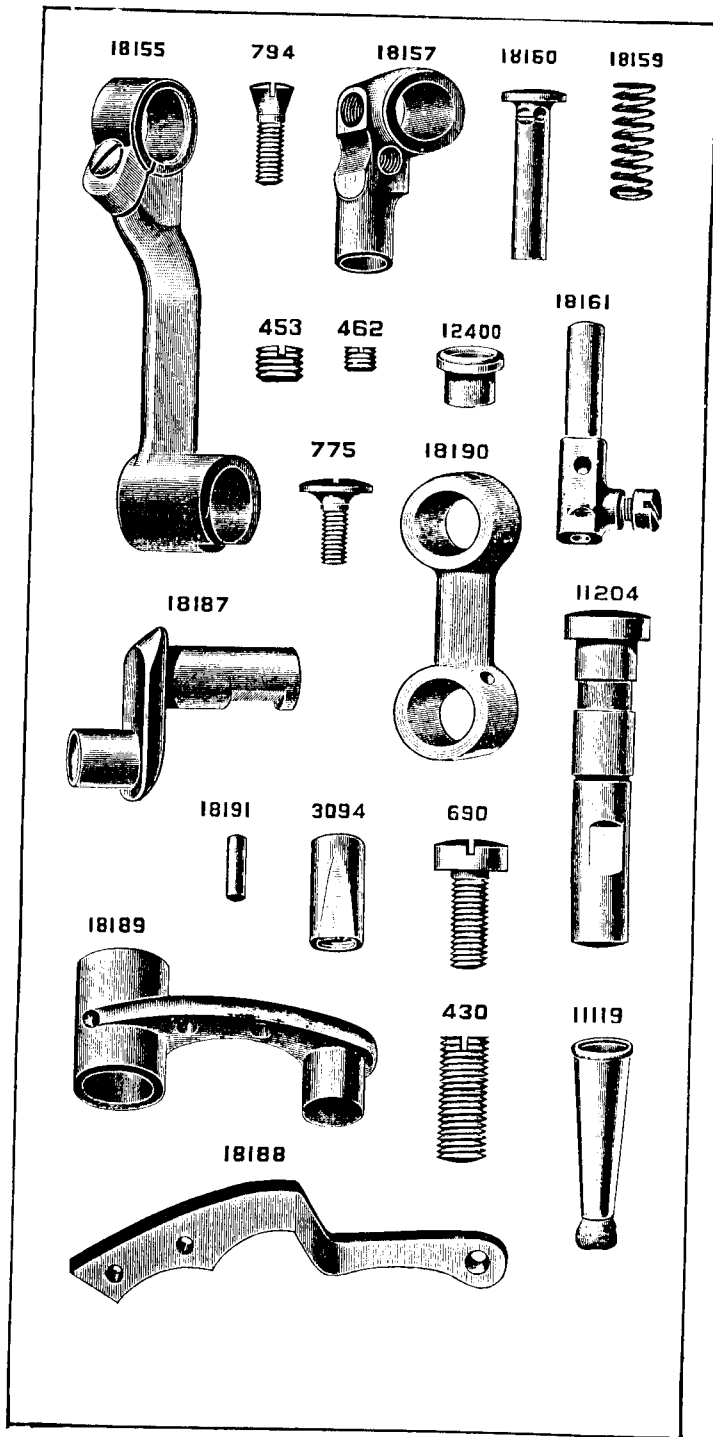


PLATE 5171—FULL SIZE

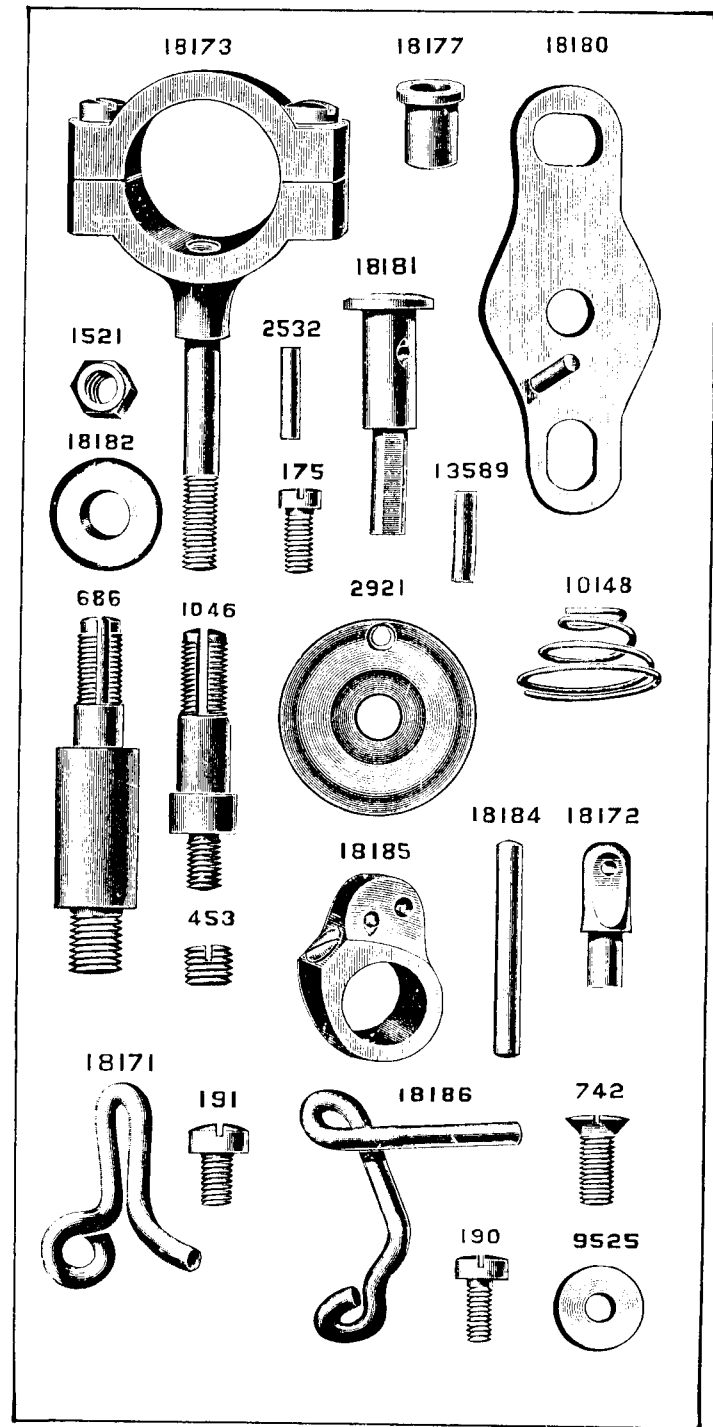


PLATE 5172—FULL SIZE

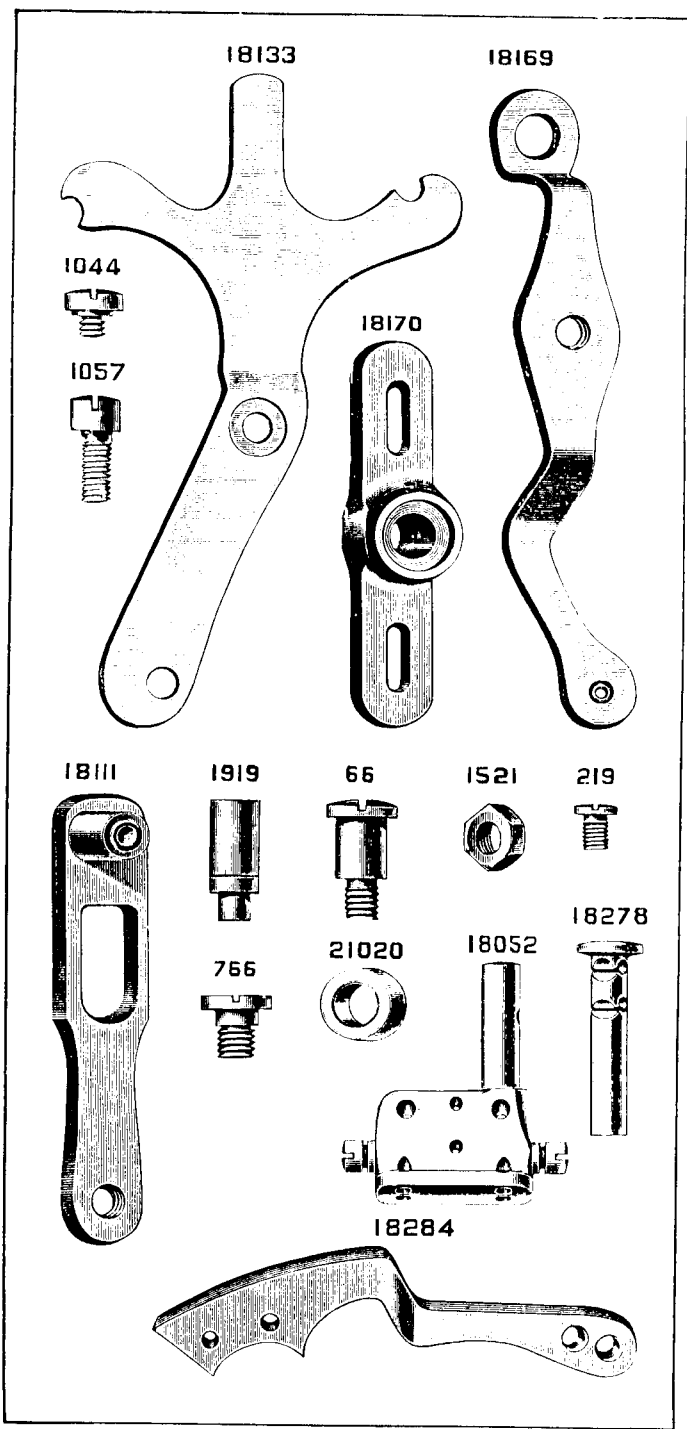


PLATE 5173—FULL SIZE

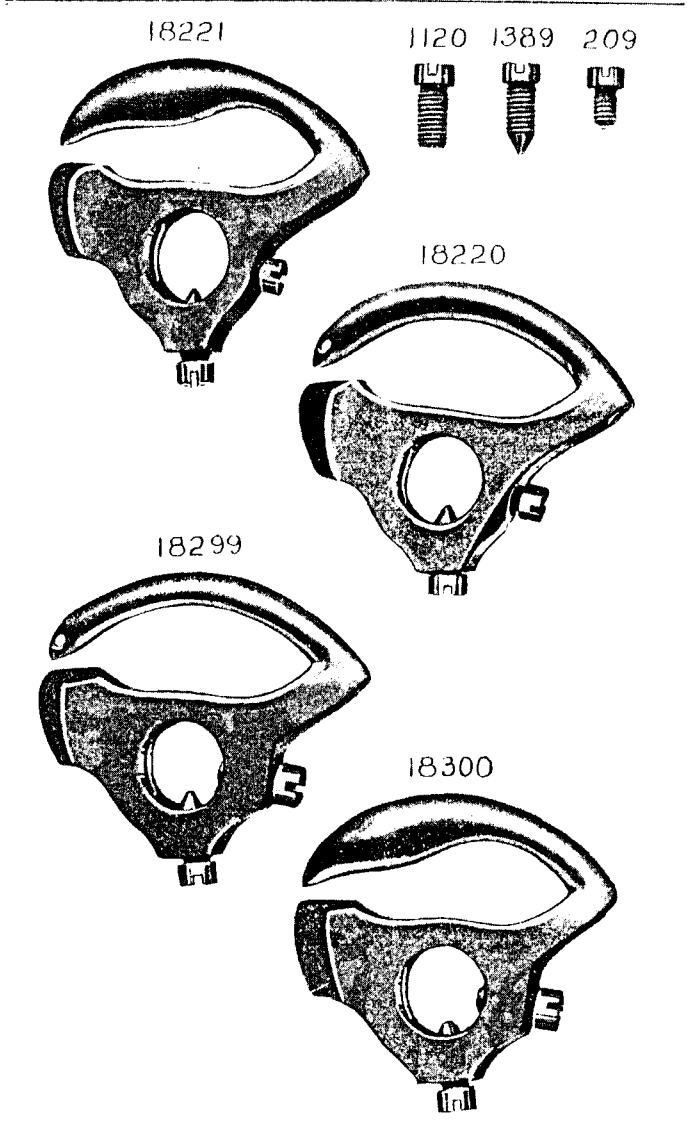


PLATE 5174—FULL SIZE

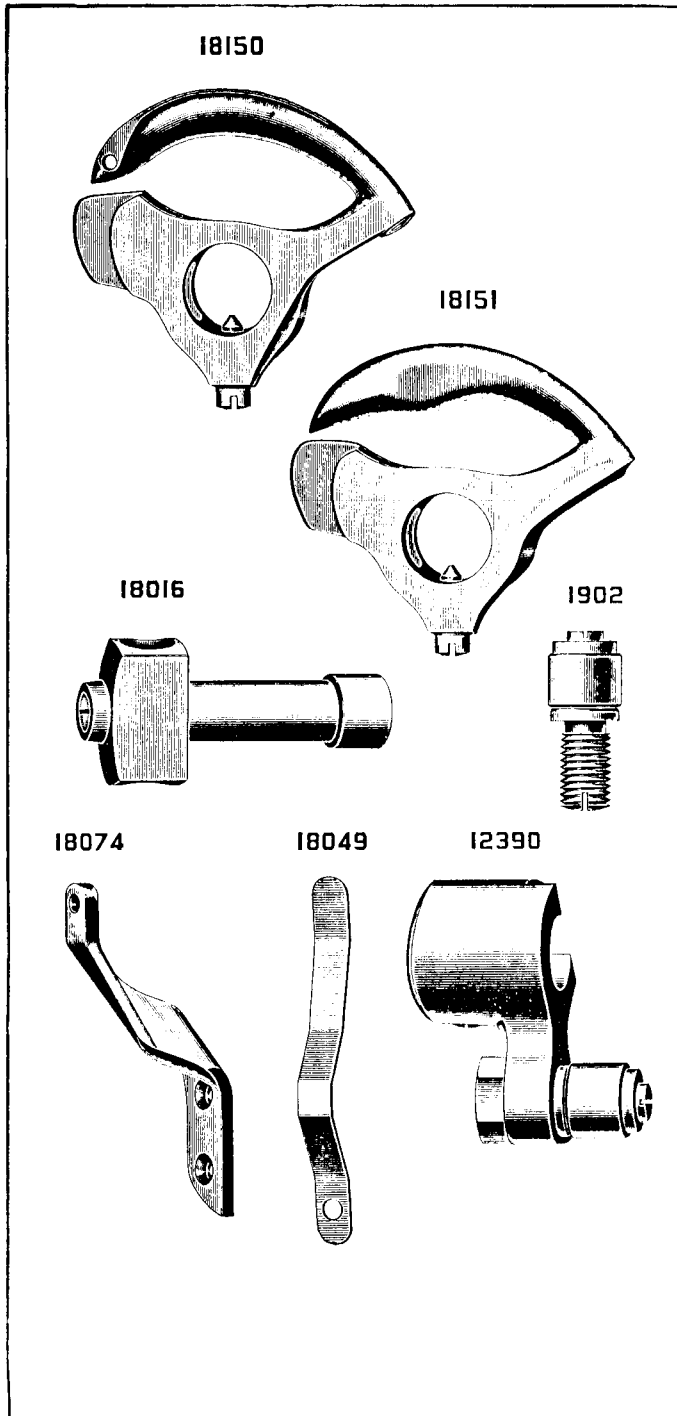


PLATE 5175—FULL SIZE

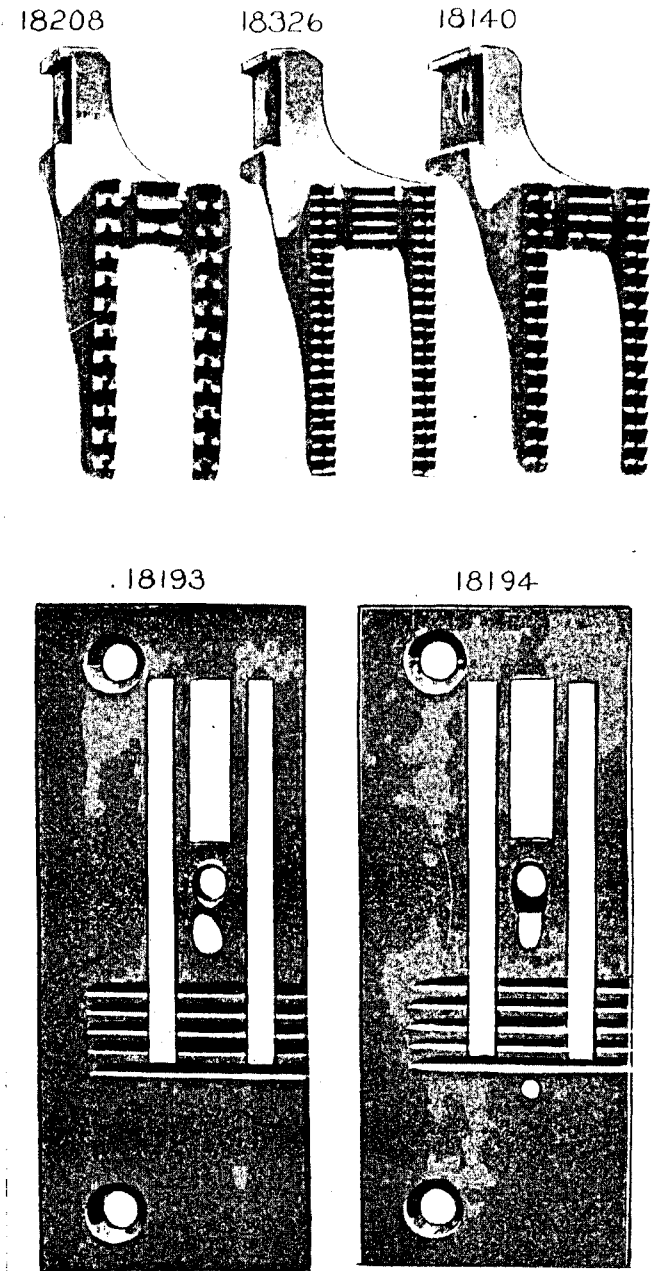


PLATE 5176—FULL SIZE

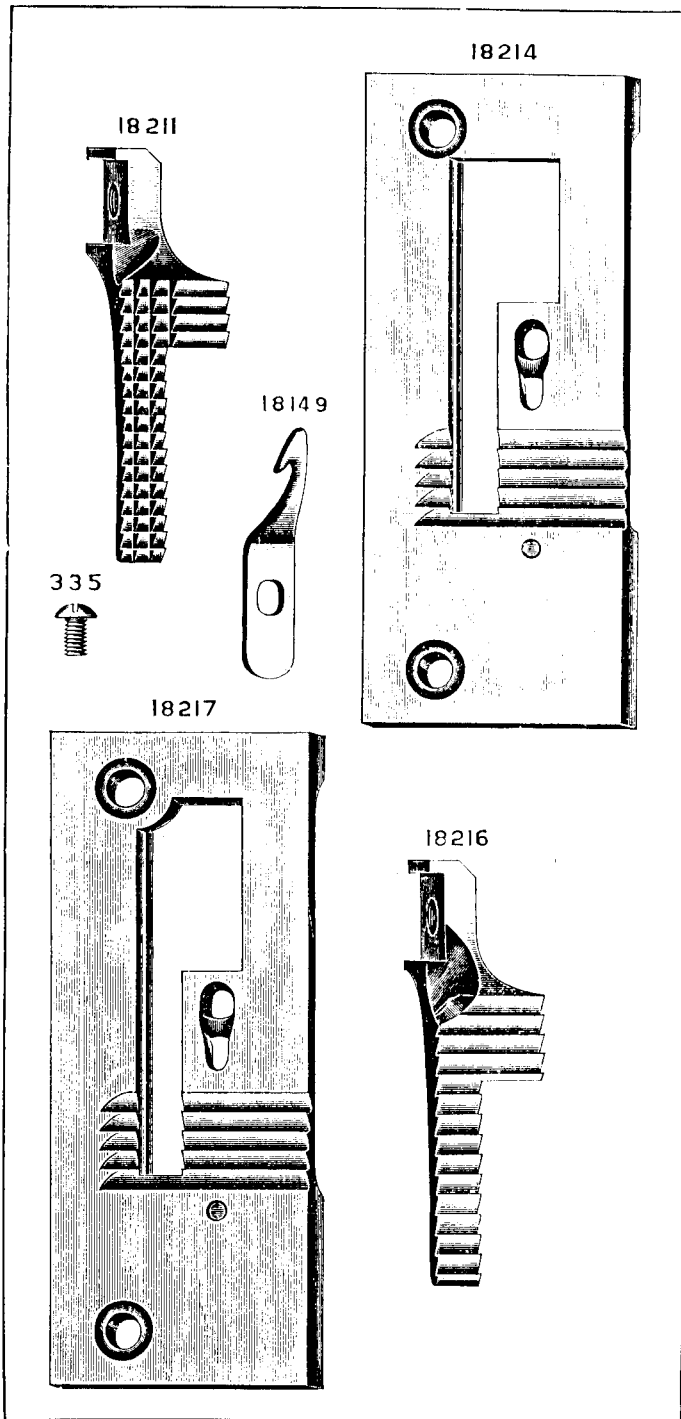


PLATE 5177—FULL SIZE

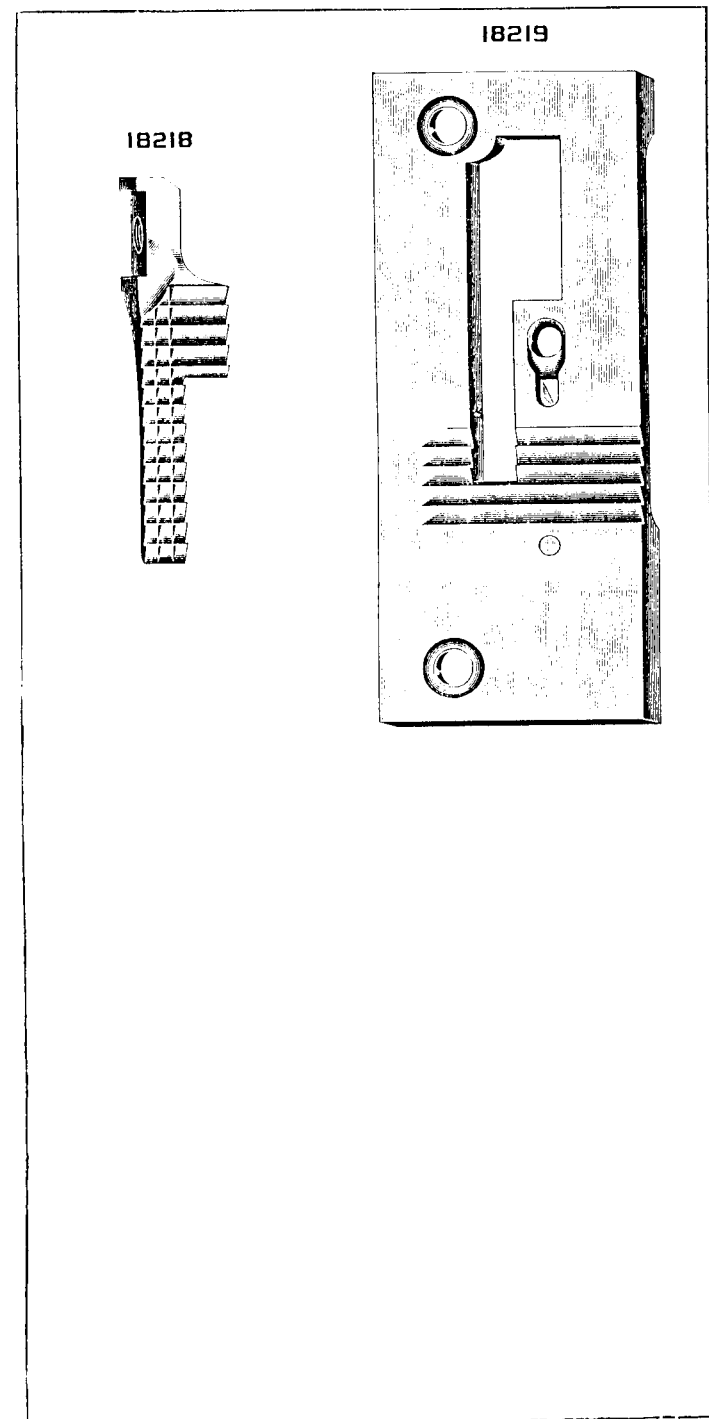
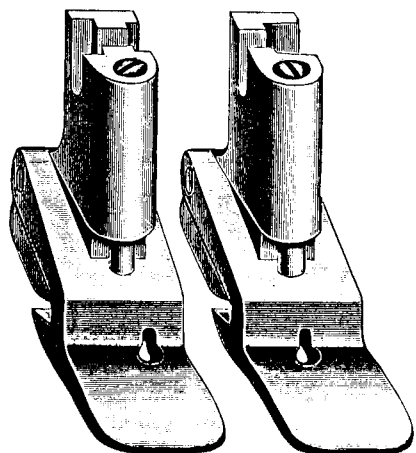


PLATE 5180—FULL SIZE

18213

18168



18200

18201

8285

889

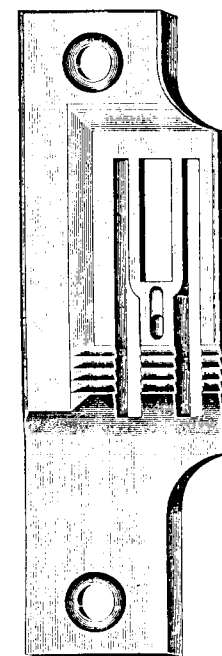
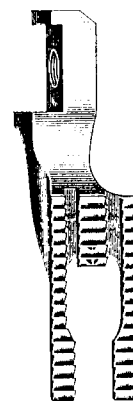
18167



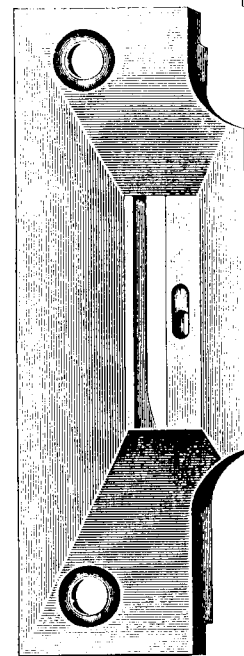
PLATE 5182—FULL SIZE

18077

18065



18109



18095



PLATE 5183—FULL SIZE

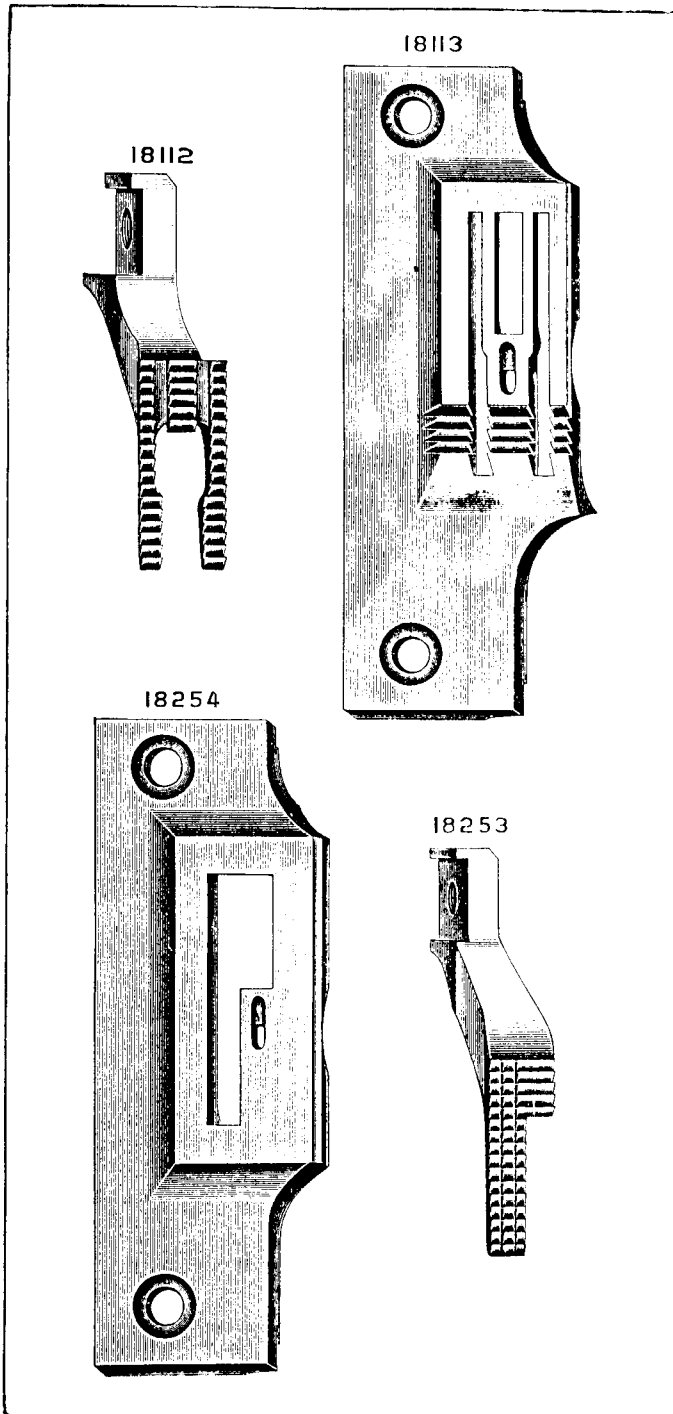


PLATE 5184—FULL SIZE

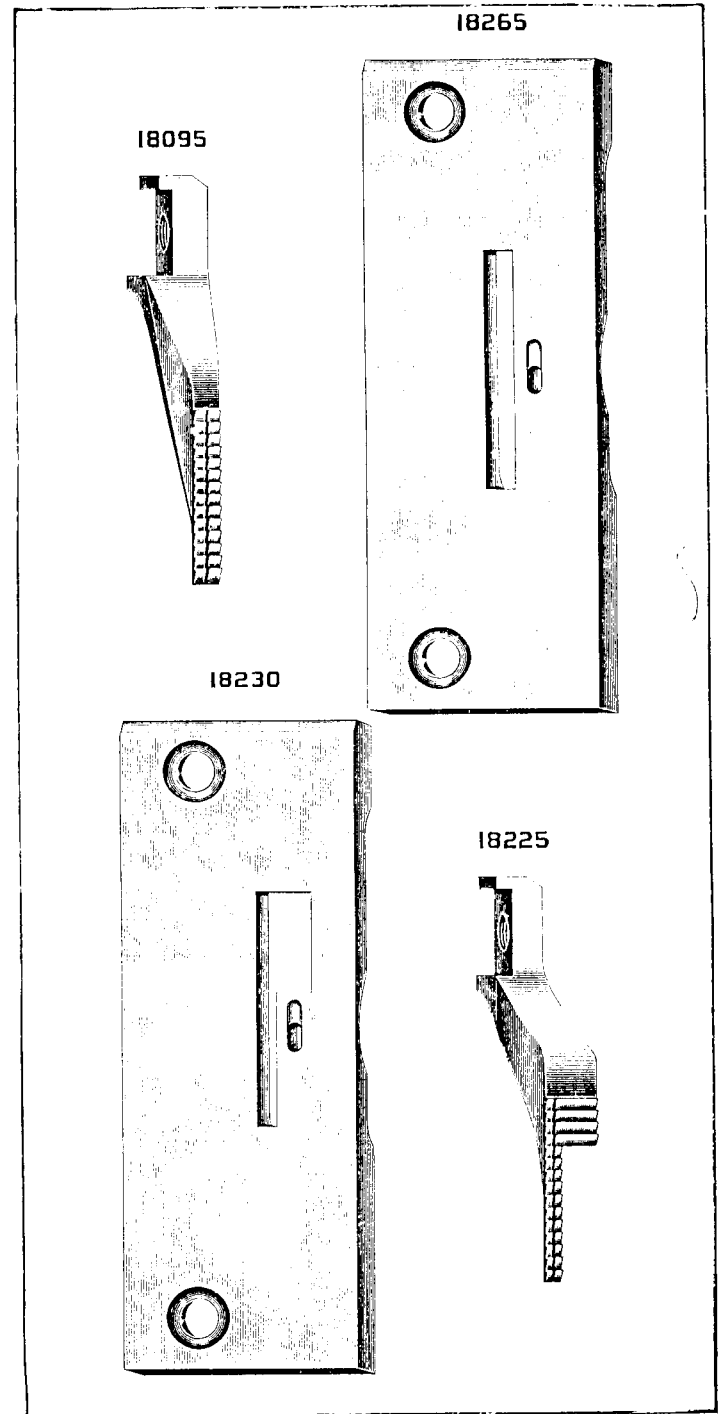


PLATE 5185—FULL SIZE

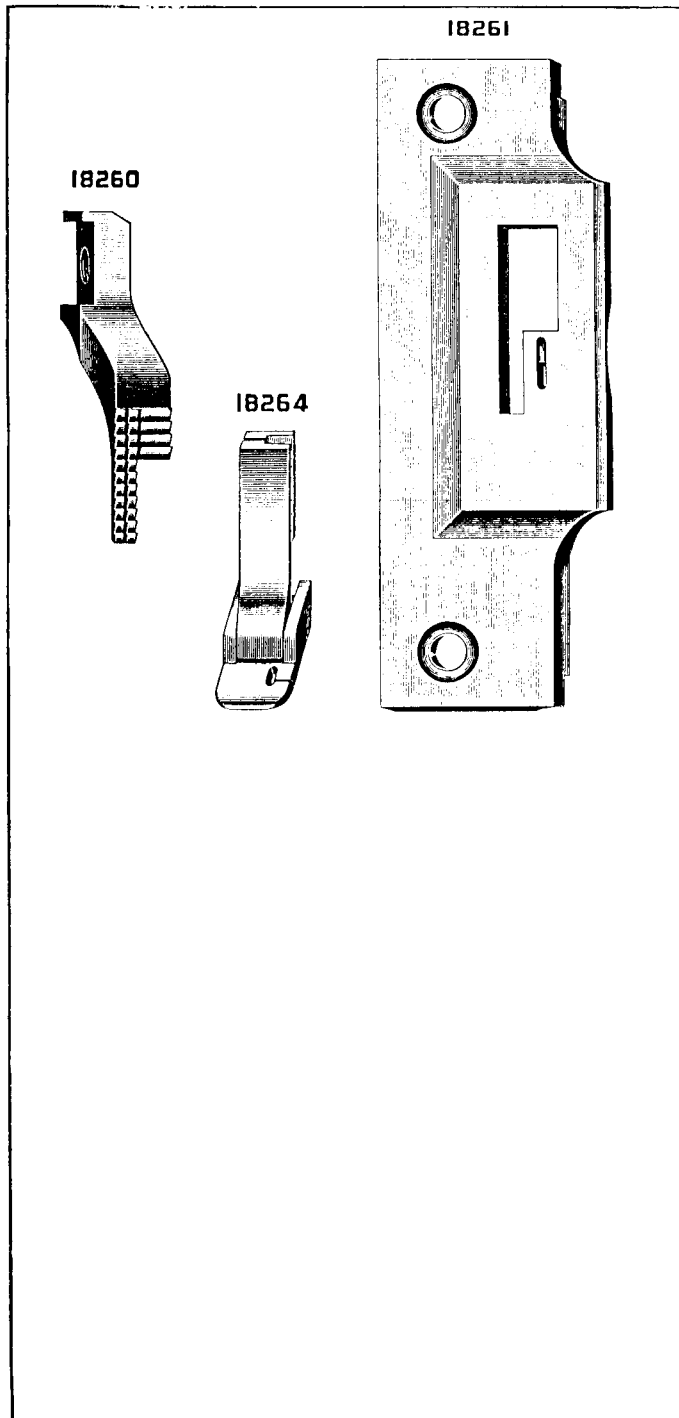


PLATE 5188—FULL SIZE

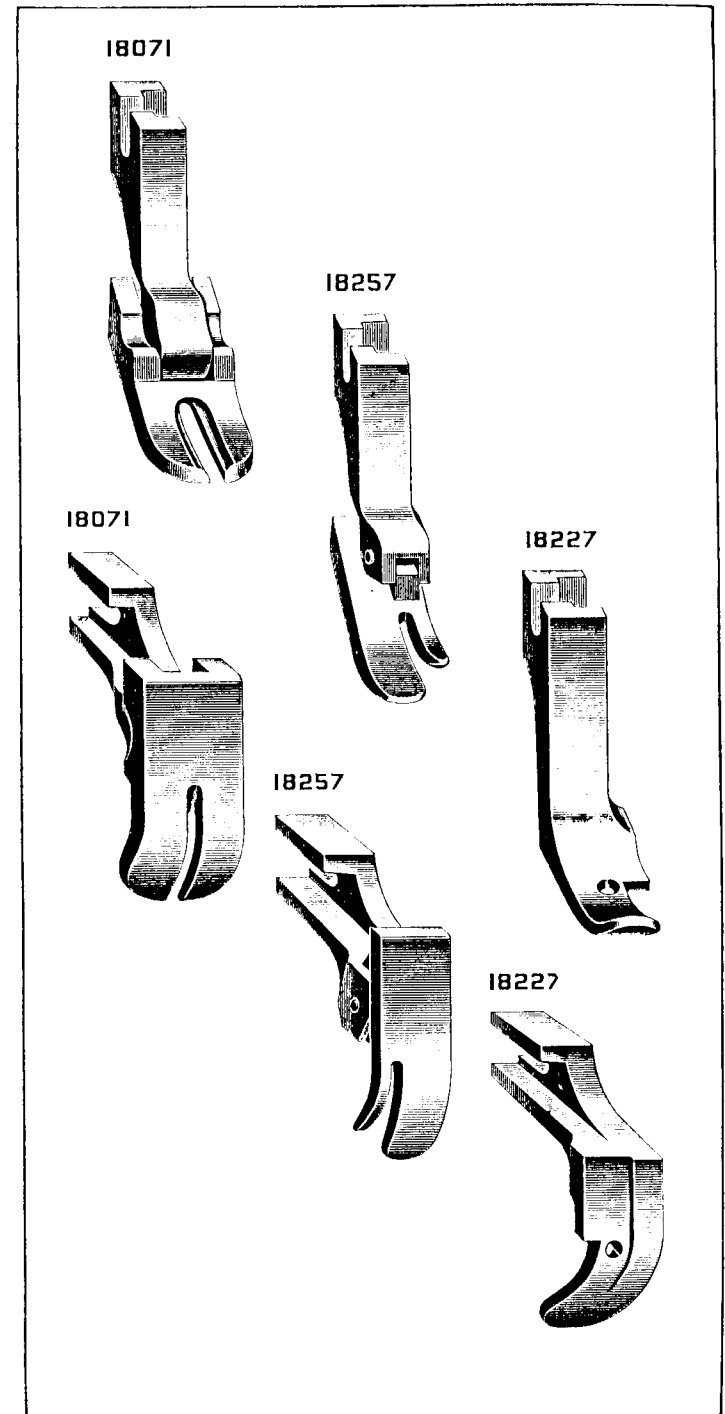


PLATE 5190—FULL SIZE

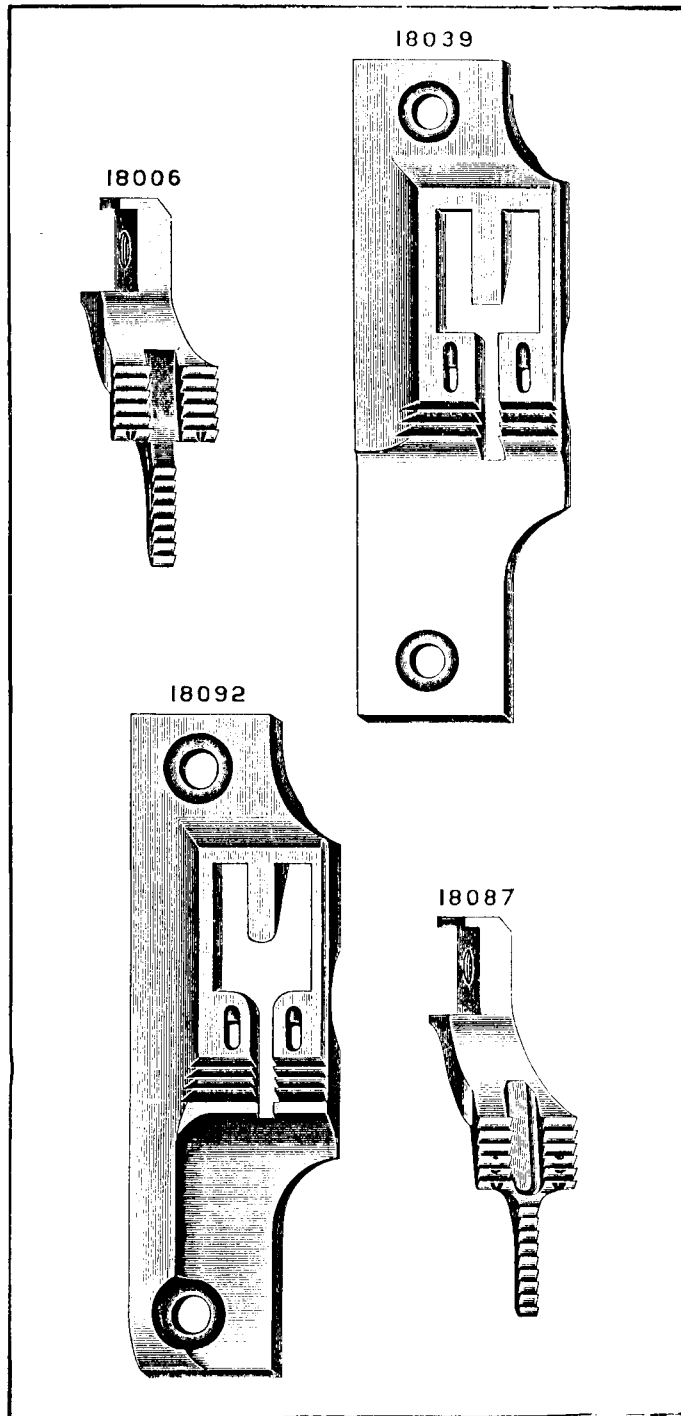


PLATE 5191—FULL SIZE

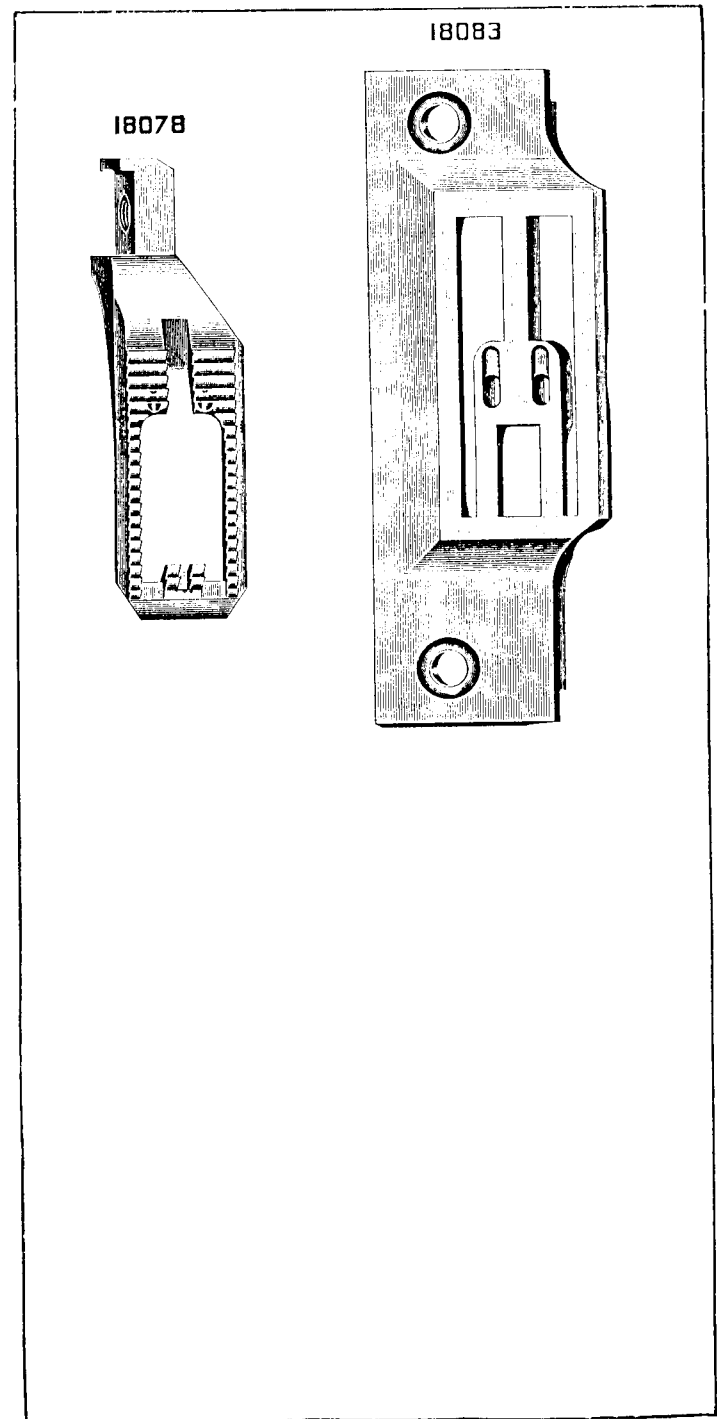
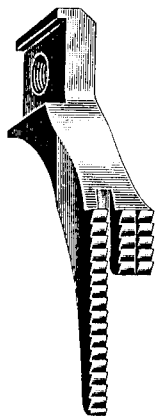
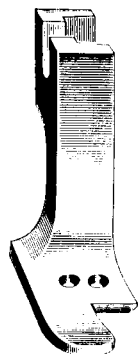


PLATE 5192—FULL SIZE

18266



18268



18267

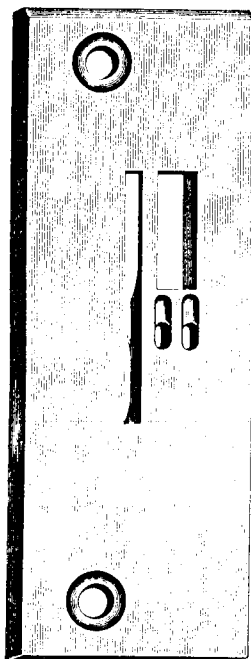
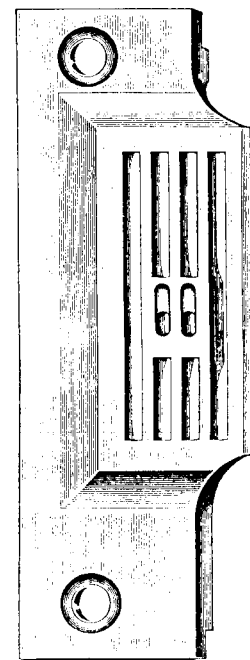


PLATE 5193—FULL SIZE

18125



18124

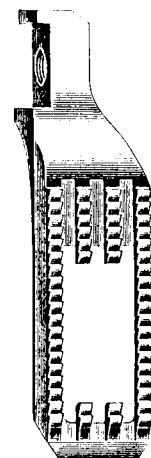


PLATE 5194—FULL SIZE

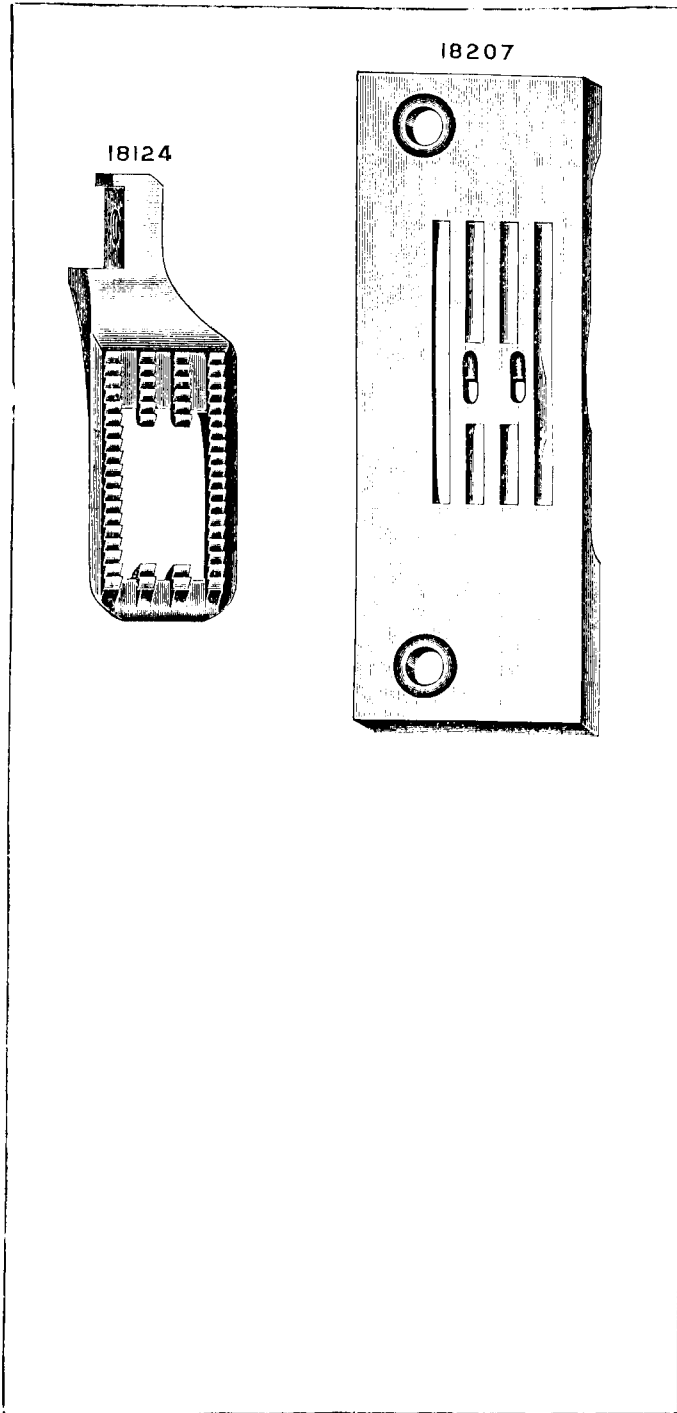


PLATE 5195—FULL SIZE

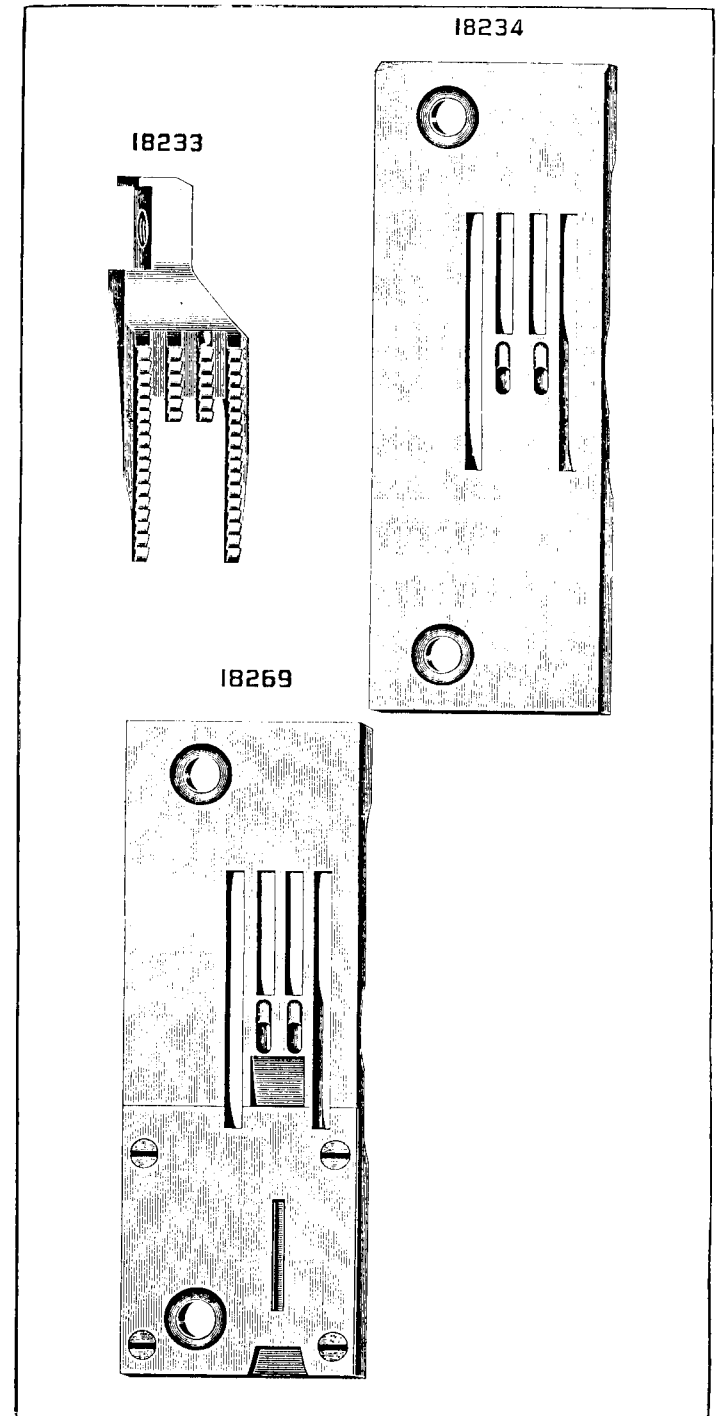


PLATE 5196—FULL SIZE

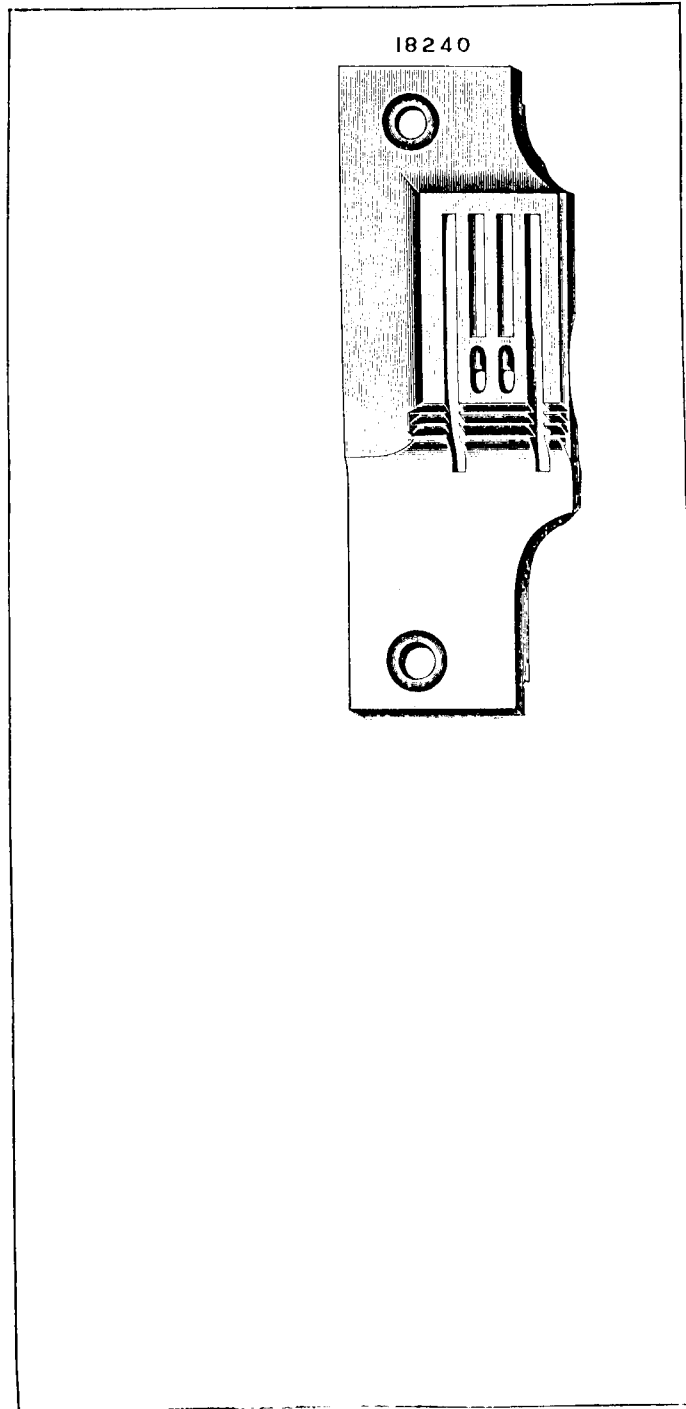


PLATE 5197—FULL SIZE

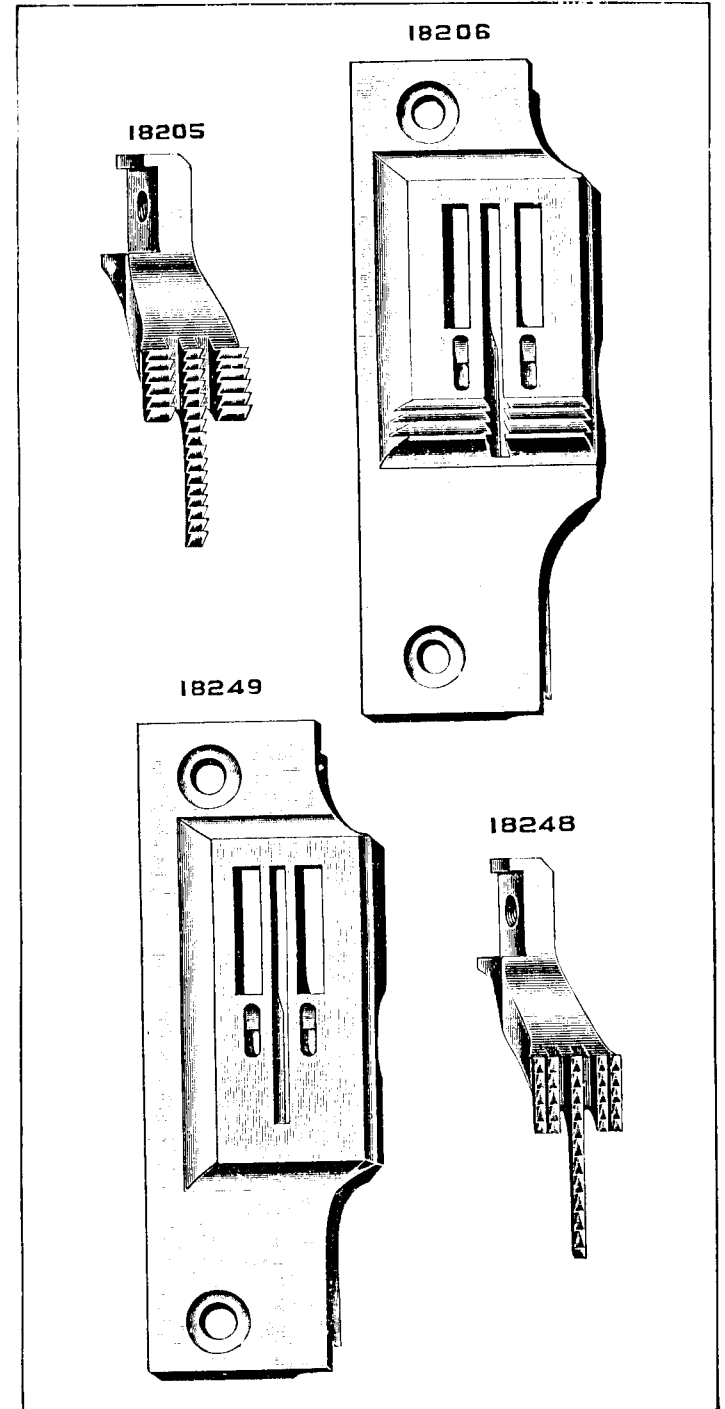
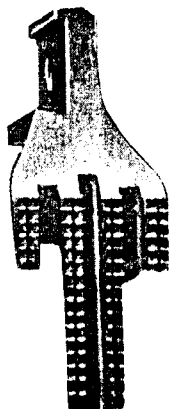
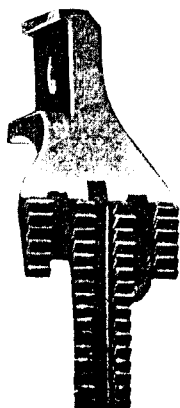


PLATE 5198—FULL SIZE

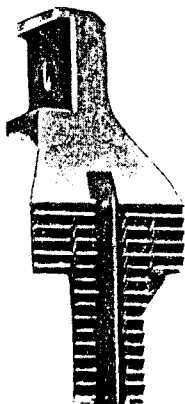
18316



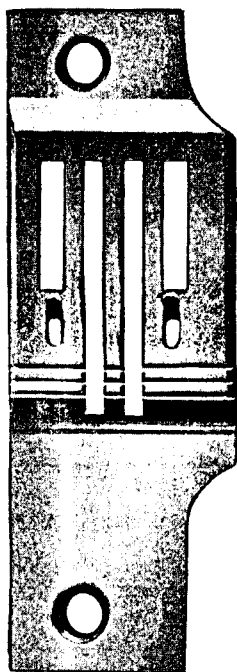
18241



18198



18242



18199

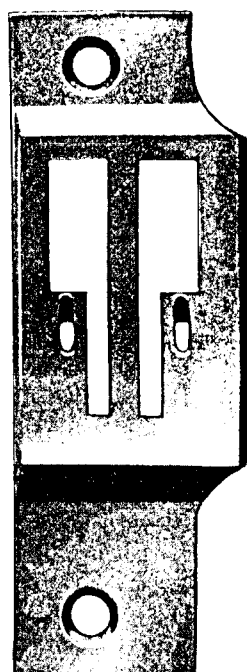
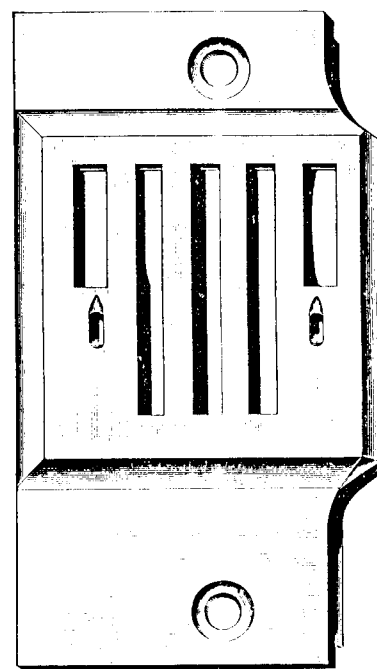
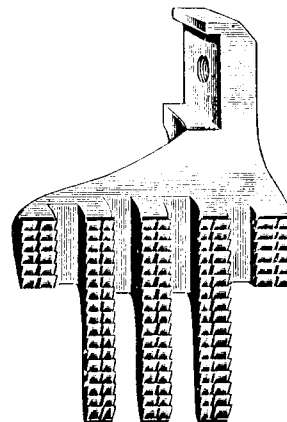


PLATE 5199—FULL SIZE

18245



18243



18271

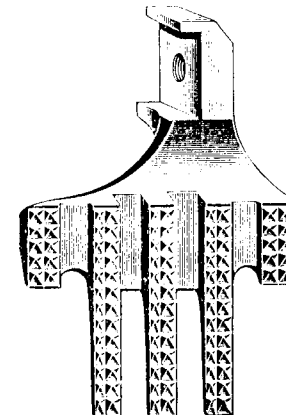


PLATE 5200—FULL SIZE

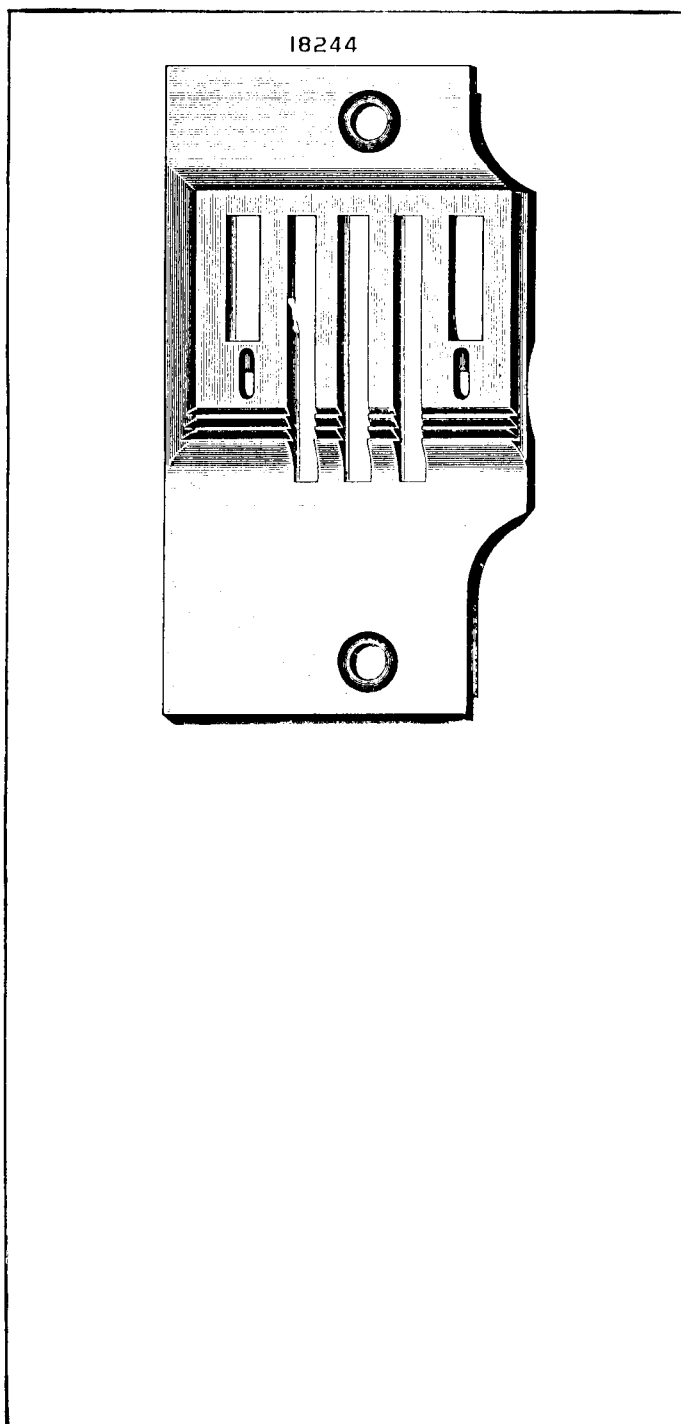


PLATE 5201—FULL SIZE

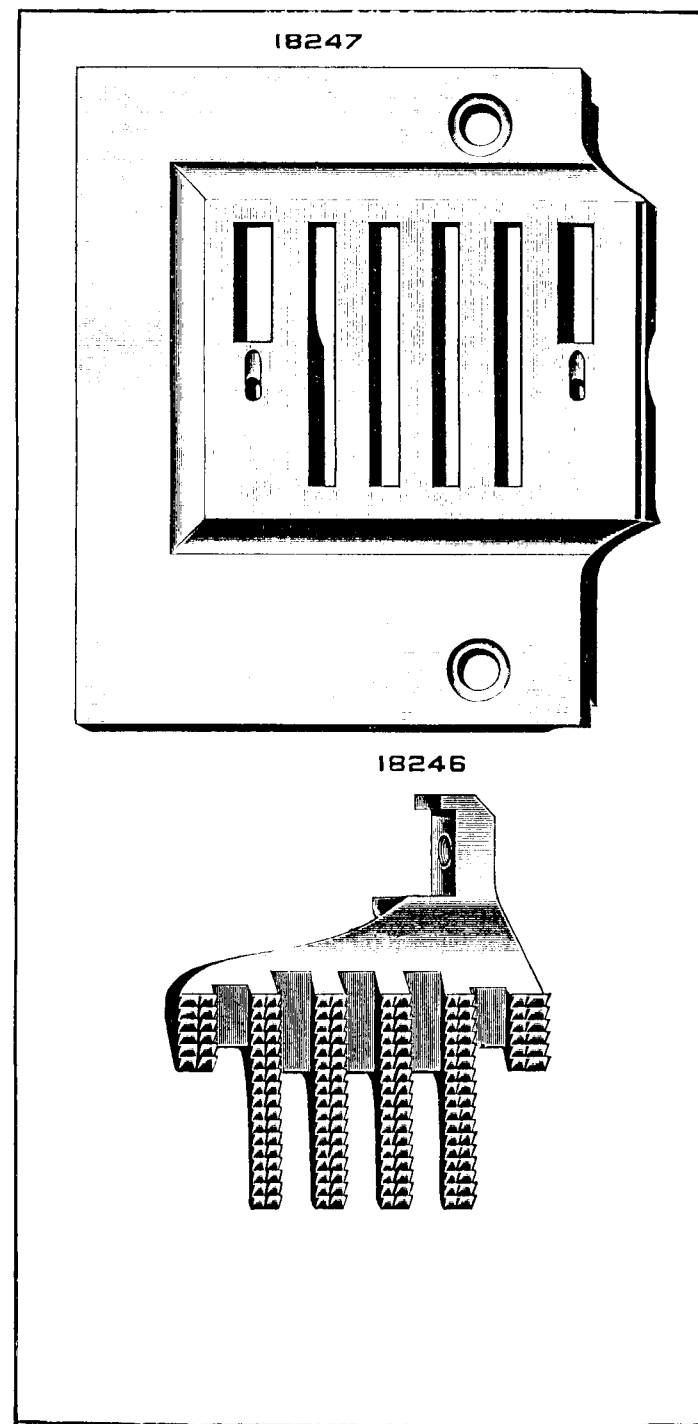
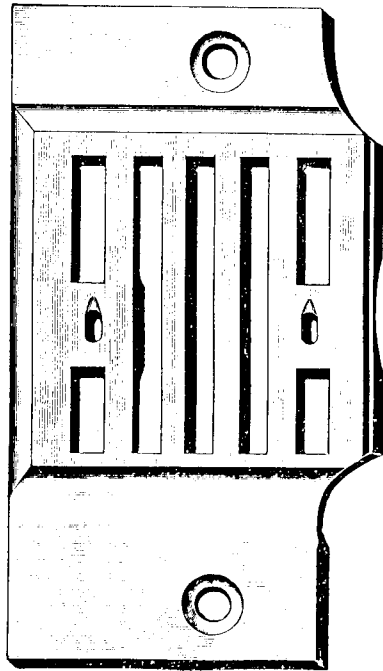


PLATE 5202—FULL SIZE

18259



18258

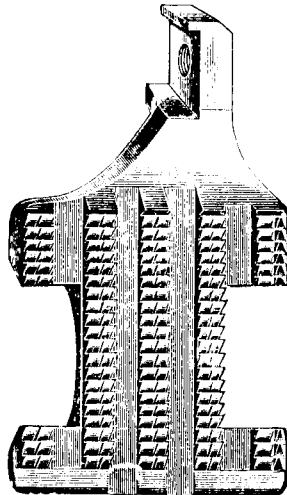
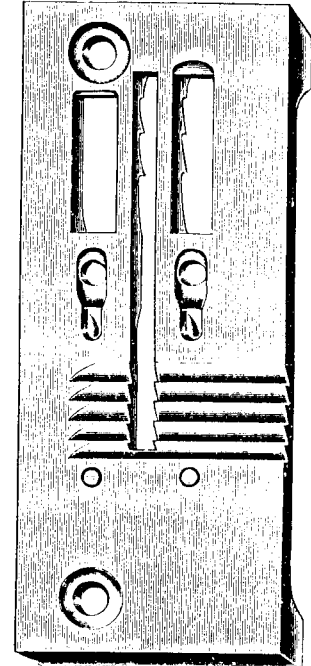
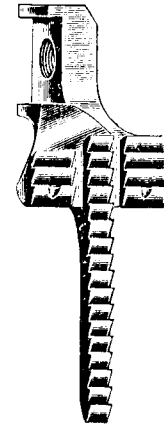


PLATE 5203—FULL SIZE

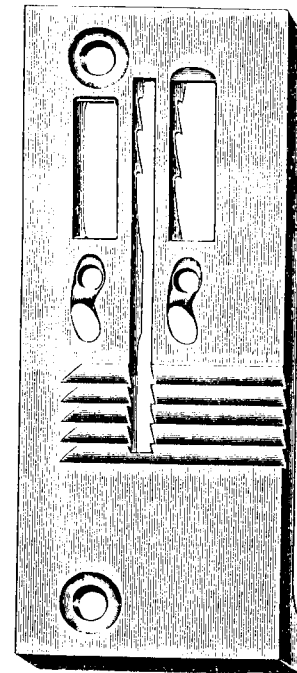
18287



18275



18286



18282

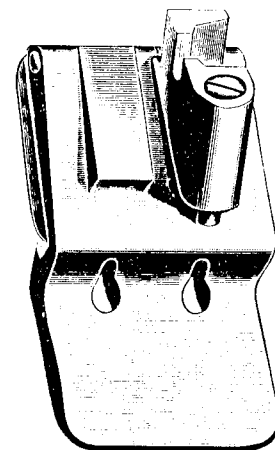
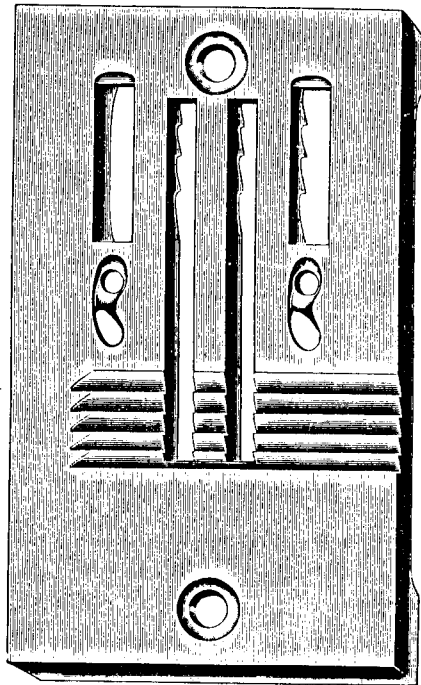


PLATE 5204—FULL SIZE

18289



18286

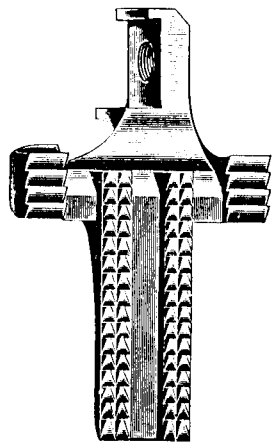


PLATE 5205—FULL SIZE

18290

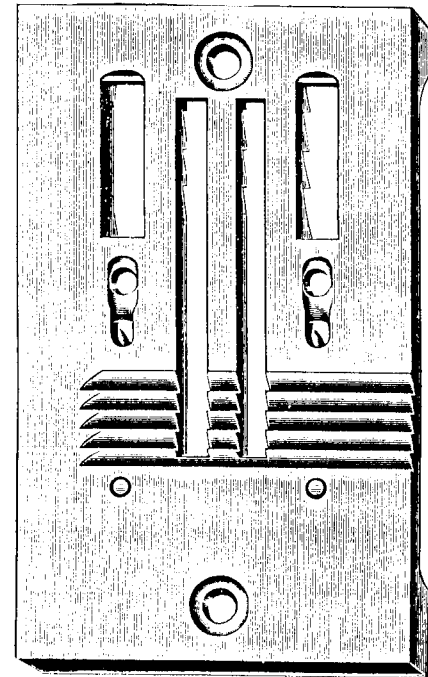


PLATE 5206—FULL SIZE

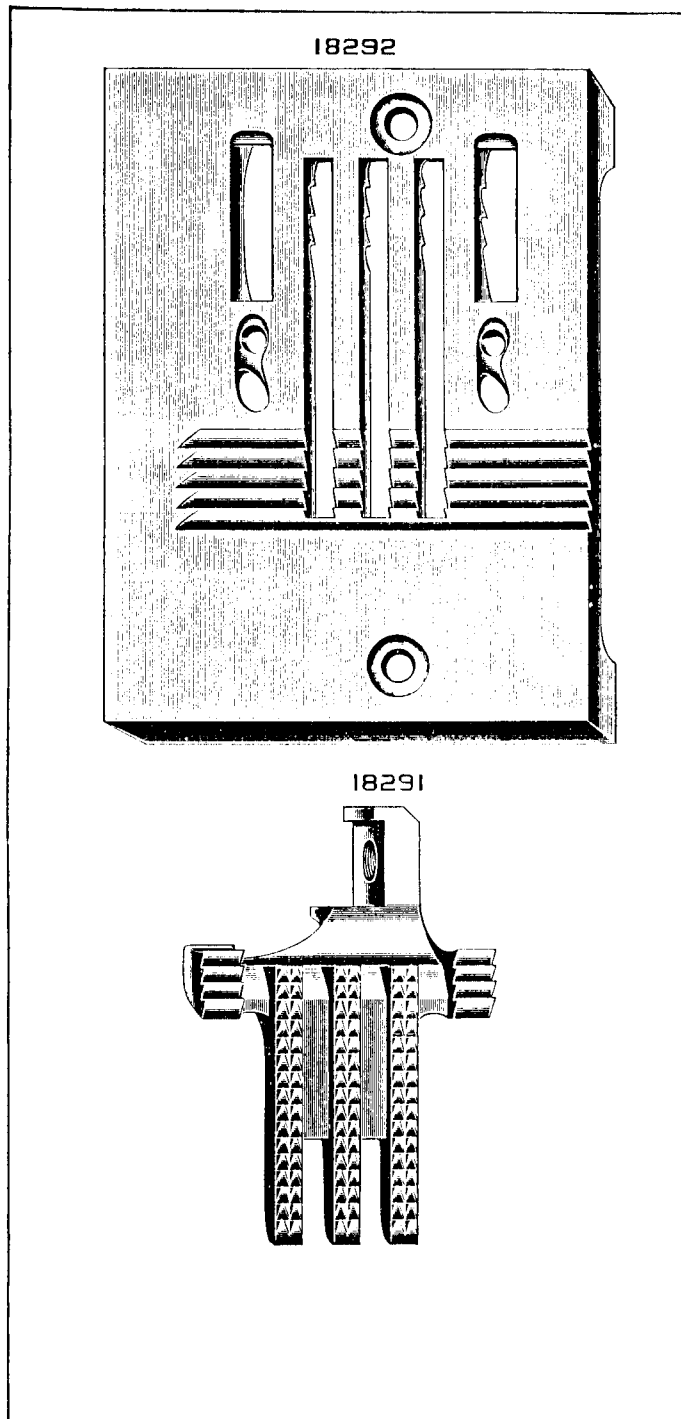


PLATE 5207—FULL SIZE

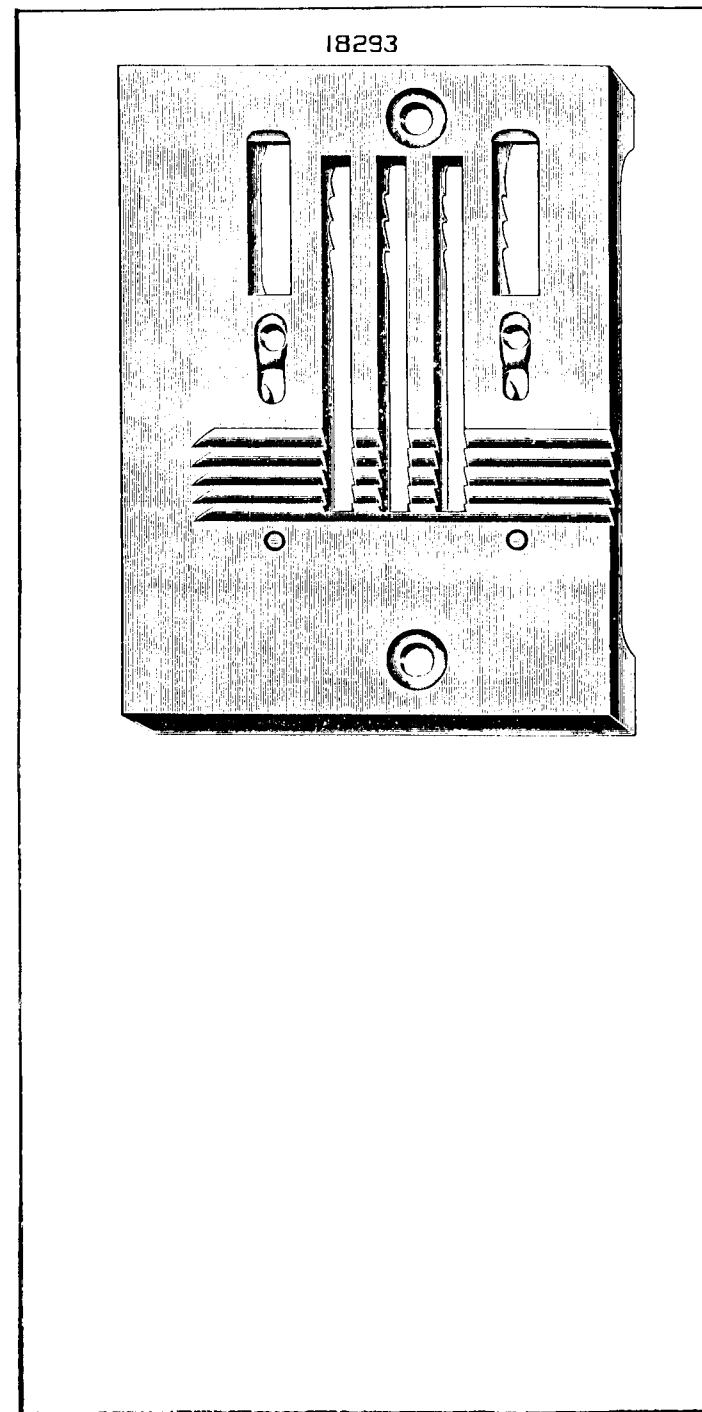
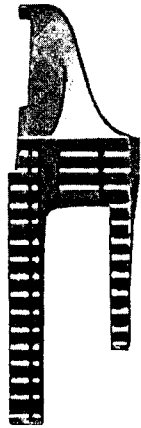
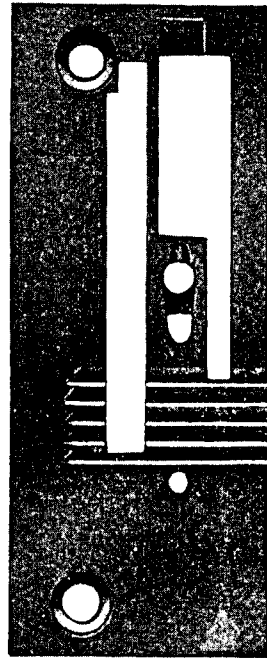


PLATE 5208—FULL SIZE

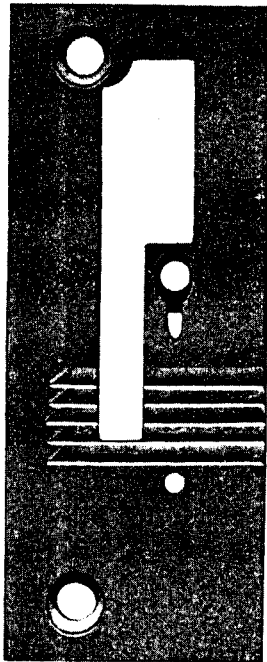
120371



120376



20917

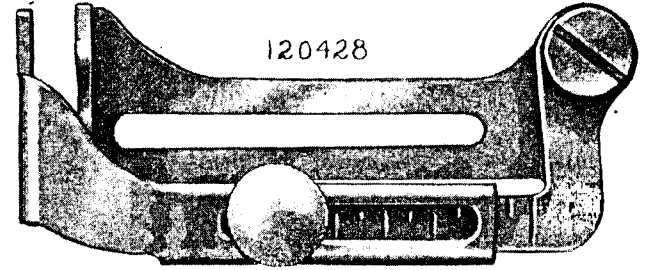


20916



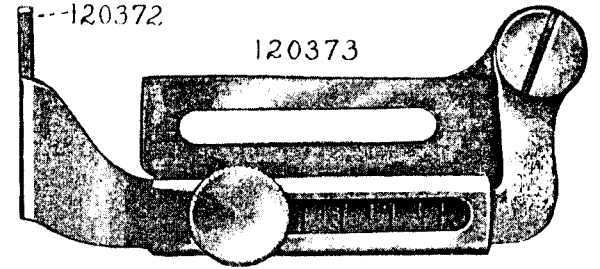
PLATE 5209—FULL SIZE

28971



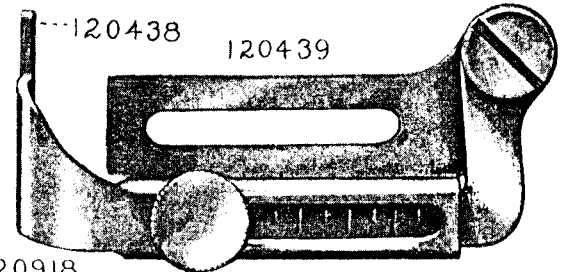
120428

120372



120373

120438

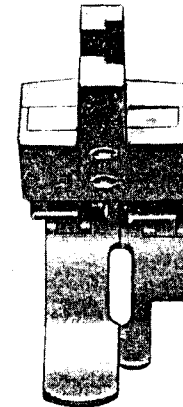


120439

20918



20925



120375

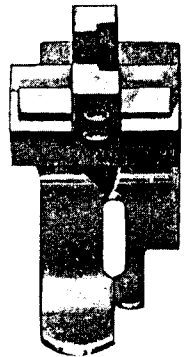
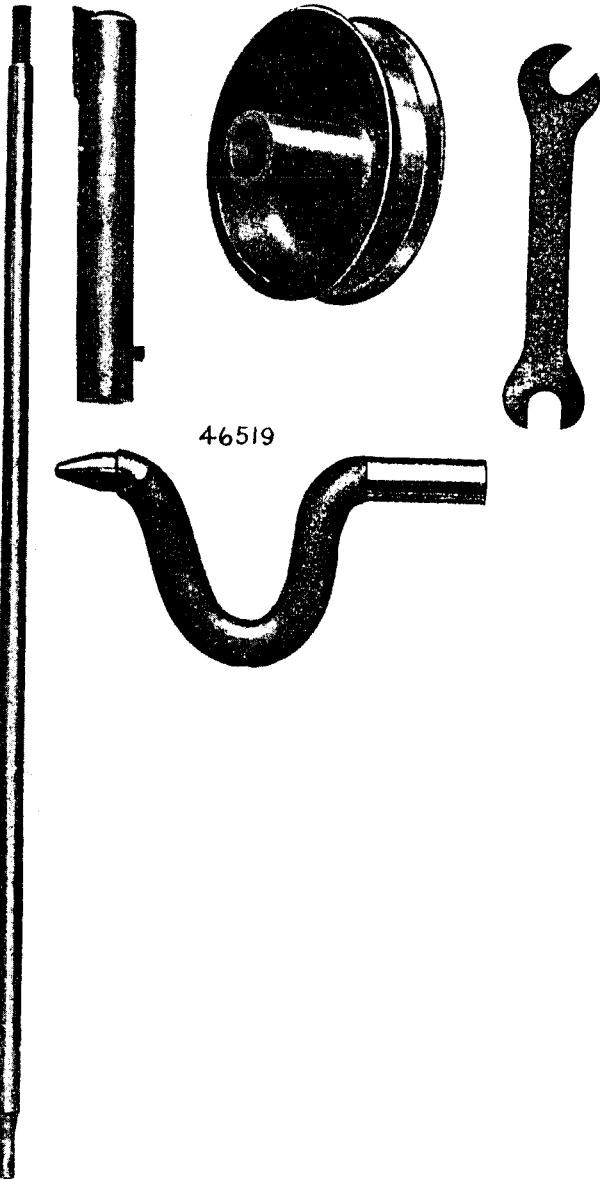


PLATE 5210—ONE-HALF SIZE

46523 126316

66085

25200



46519

PLATE 5211—ONE-HALF SIZE

176

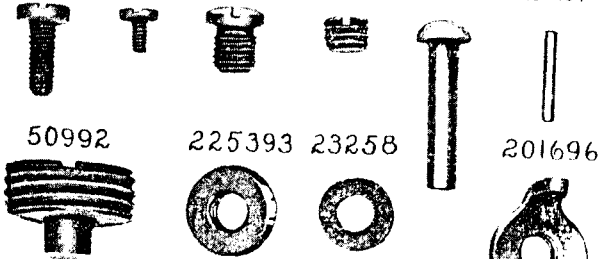
226

201018

200383

126208

62527



50992

225393

23258

201696

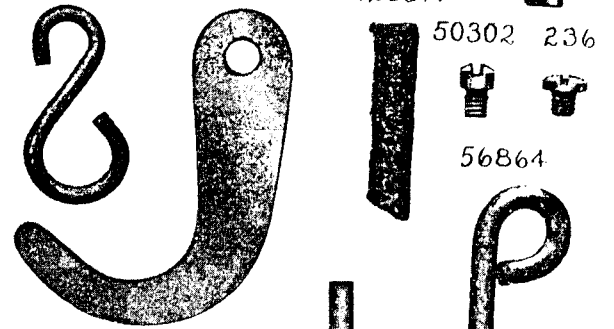
56865

126207

126317

50302

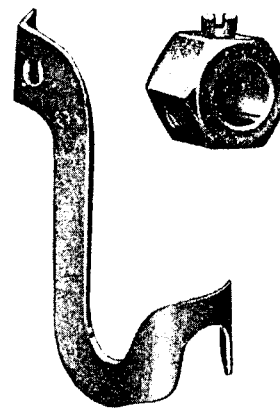
236



56864

120496

120497



120498

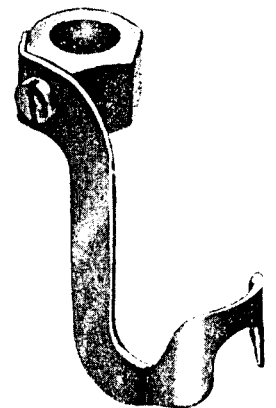
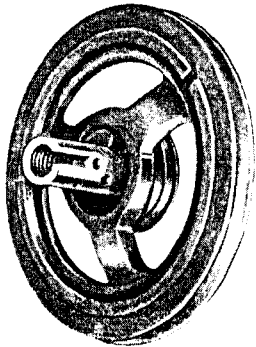
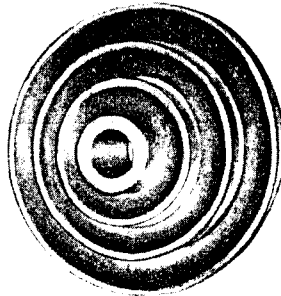


PLATE 5212—ONE-FOURTH SIZE

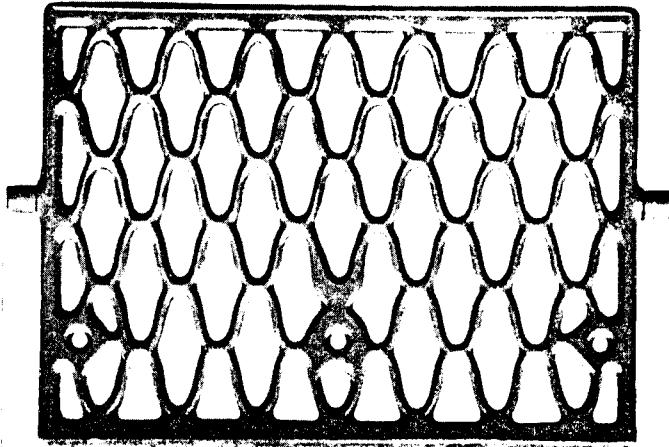
126315



126321



126036



46681

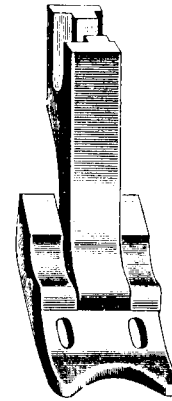


126205

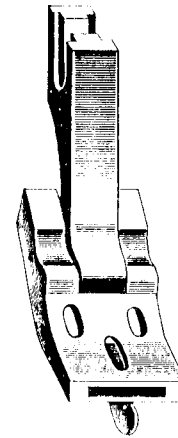


PLATE 5213—FULL SIZE

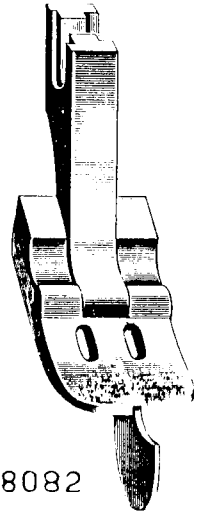
18021



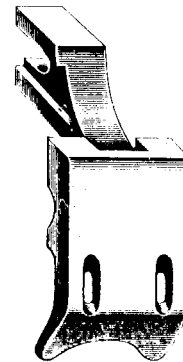
18086



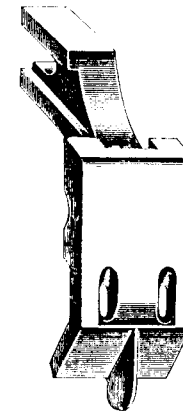
18082



18021



18086



18082

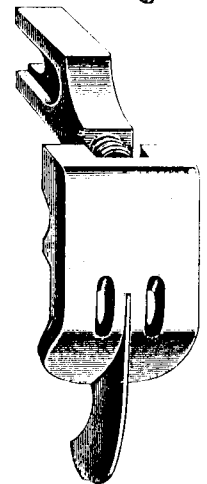
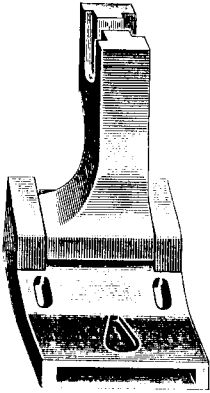
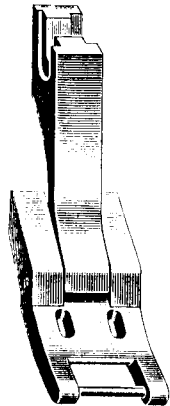


PLATE 5214—FULL SIZE

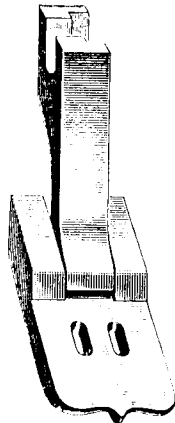
18197



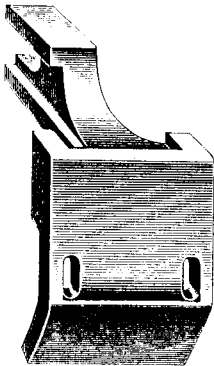
18252



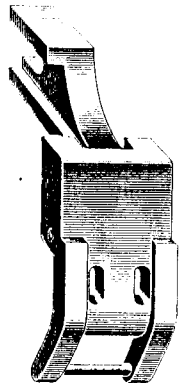
18127



18197



18252



18127

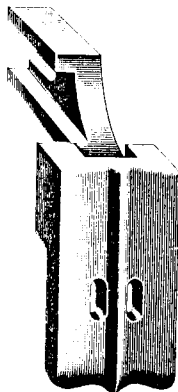
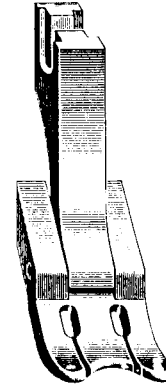


PLATE 5215—FULL SIZE

18122



18122

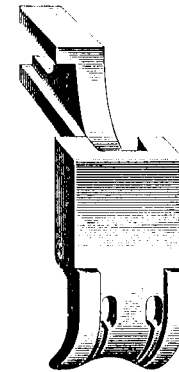


PLATE 5216—ONE-NINTH SIZE

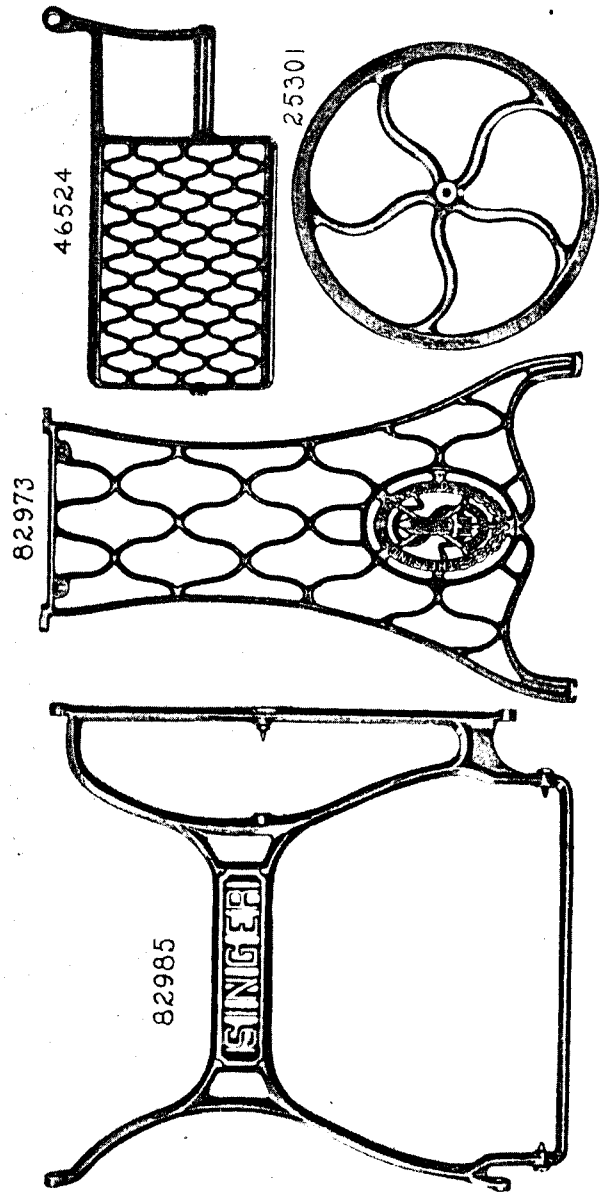


PLATE 5220—ONE-HALF SIZE

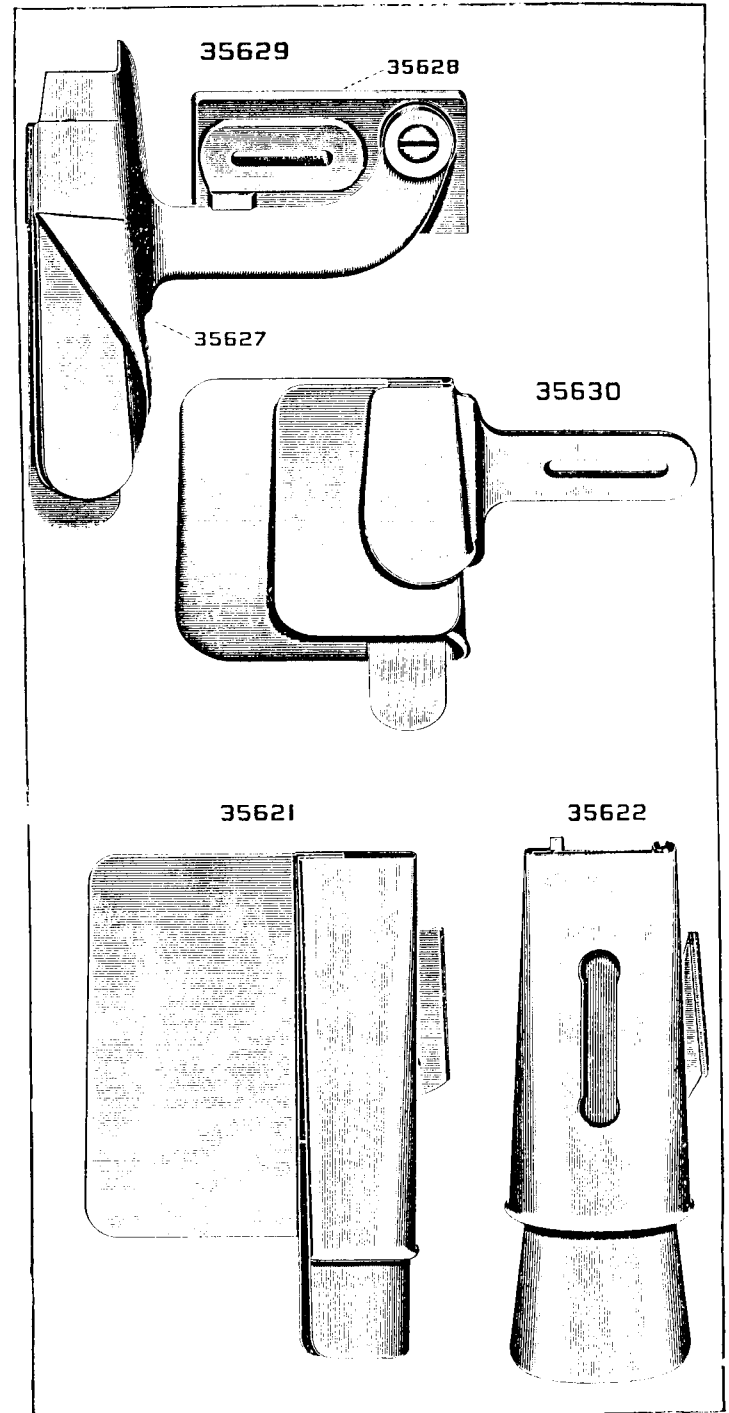
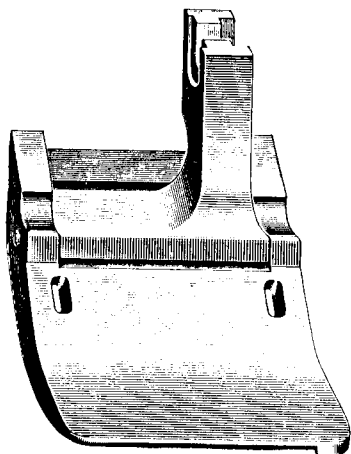
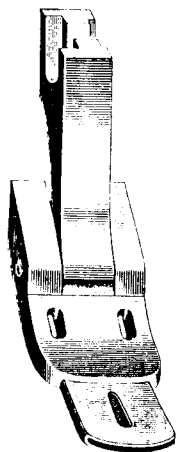


PLATE 5221—FULL SIZE

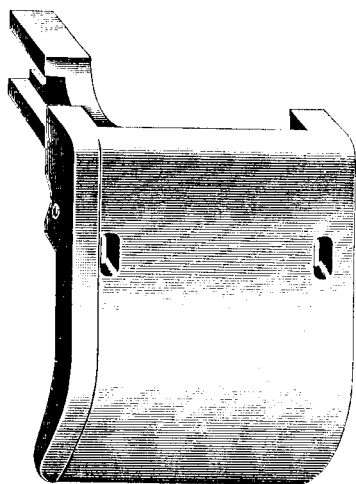
35620



35648



35620



35648

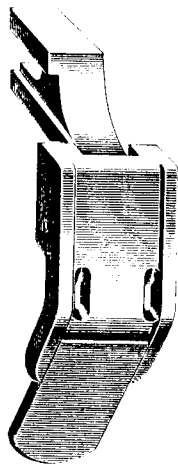
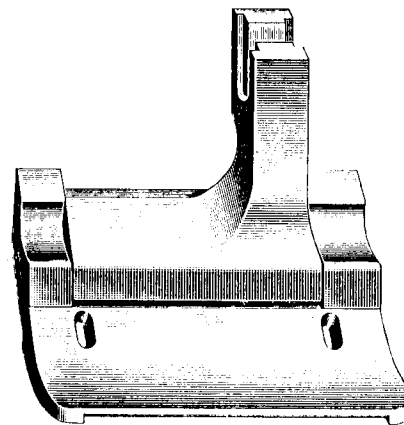
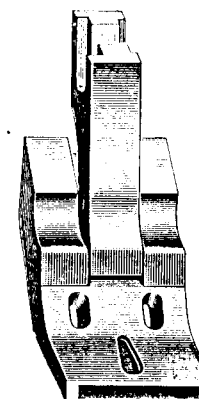


PLATE 5222—FULL SIZE

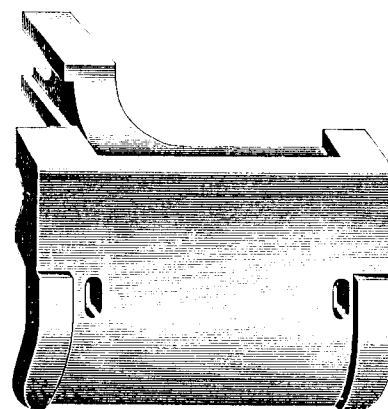
35625



35652



35625



35652

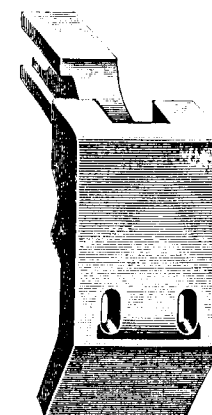


PLATE 5223—ONE-HALF SIZE

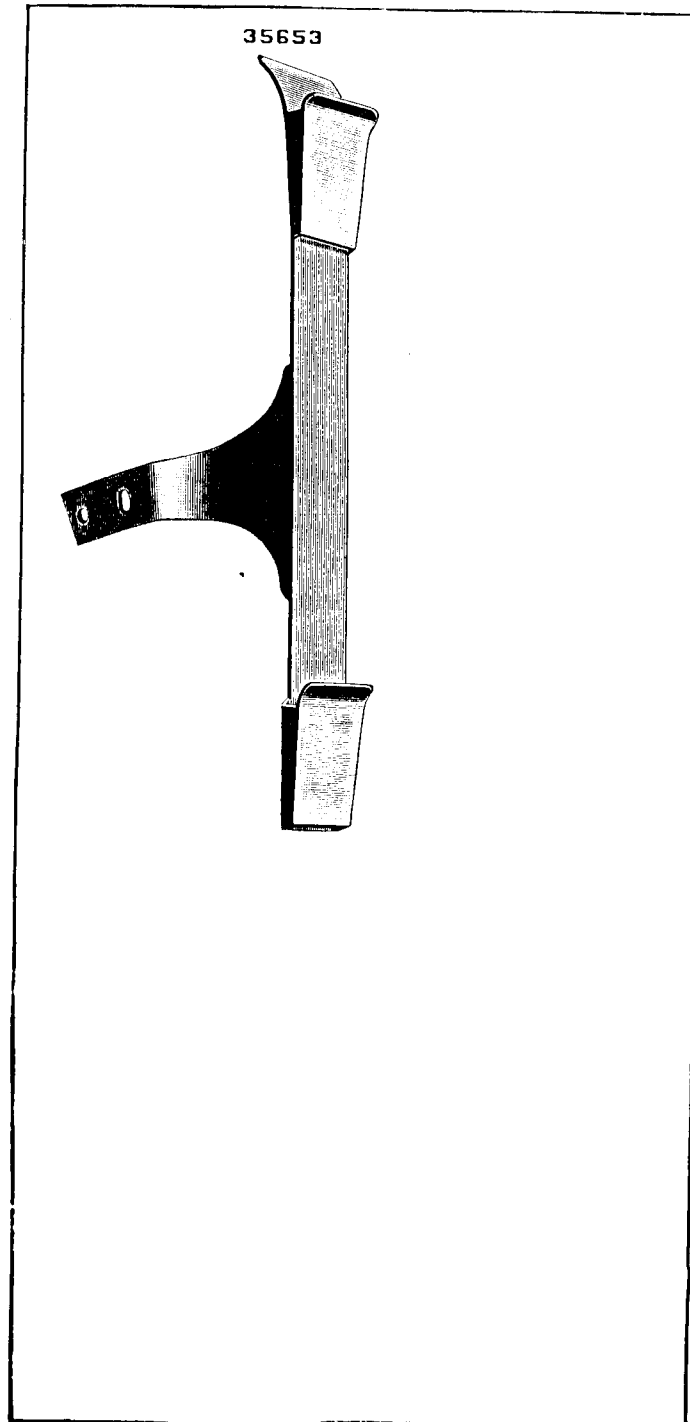


PLATE 5224—FULL SIZE

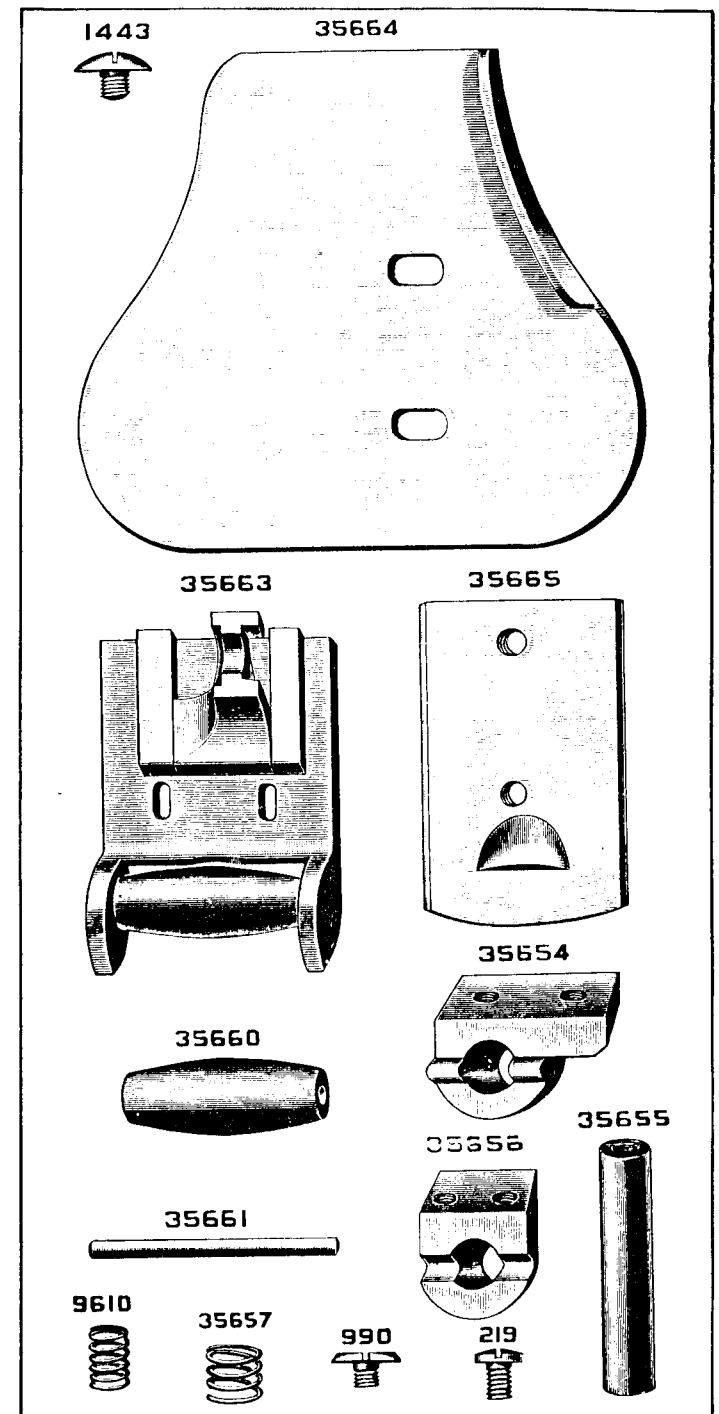
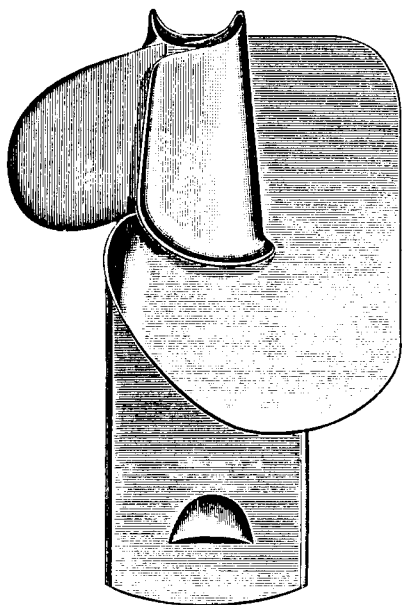


PLATE 5225—FULL SIZE

26397



26272

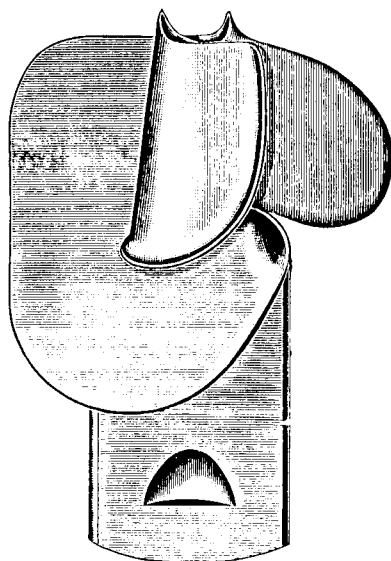
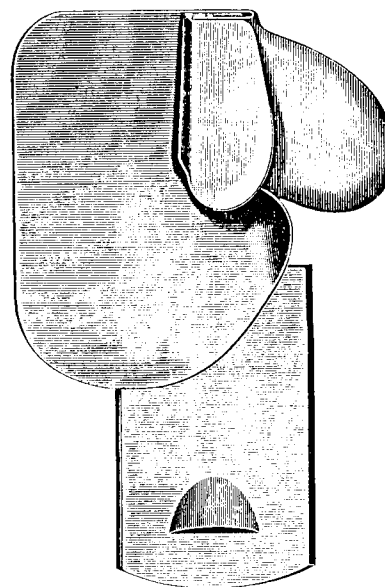


PLATE 5226—FULL SIZE

35636



35631

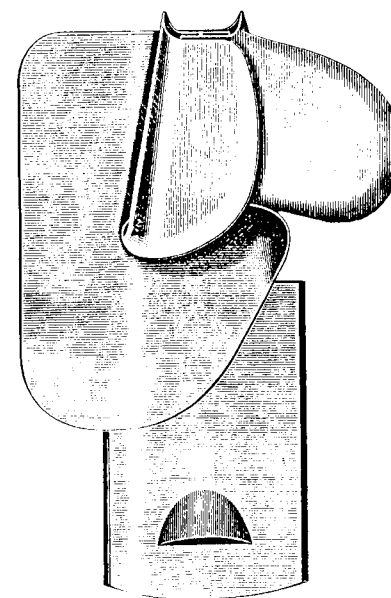


PLATE 5227—FULL SIZE

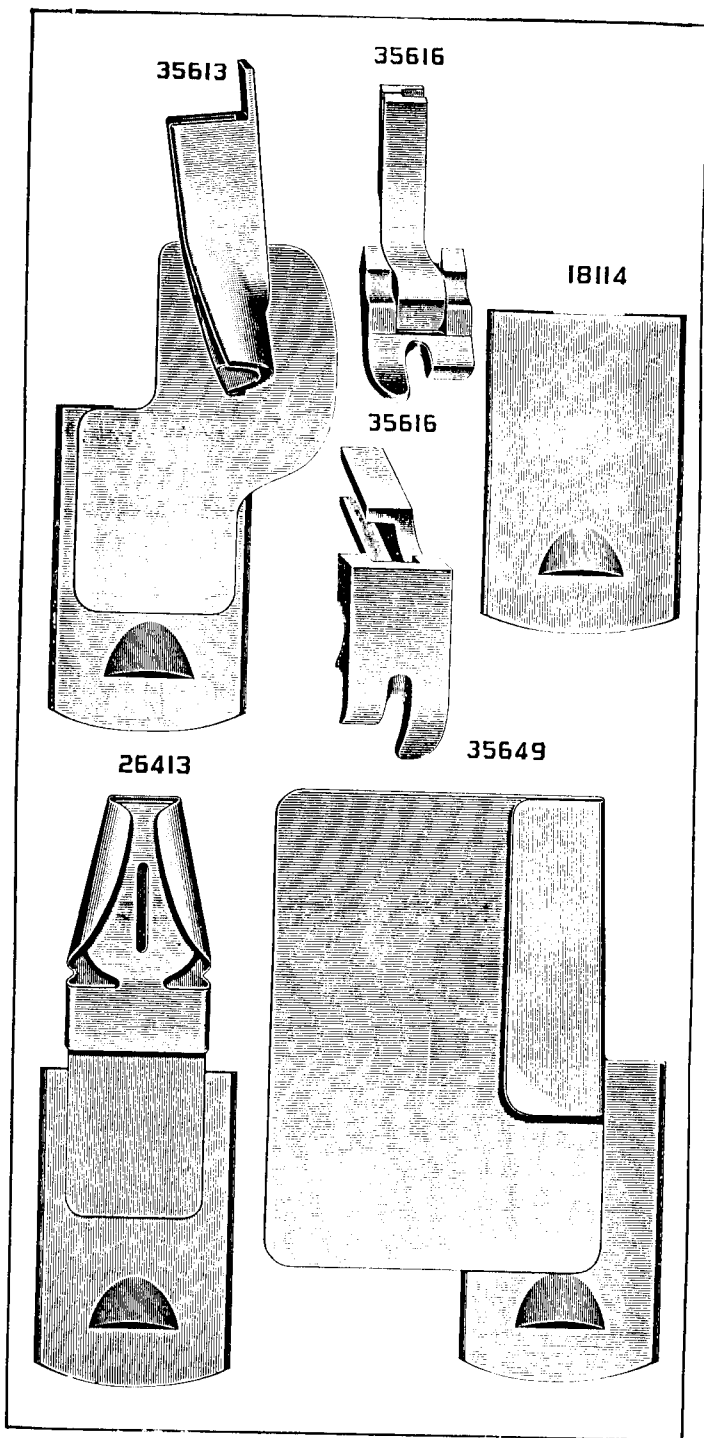


PLATE 5228—FULL SIZE

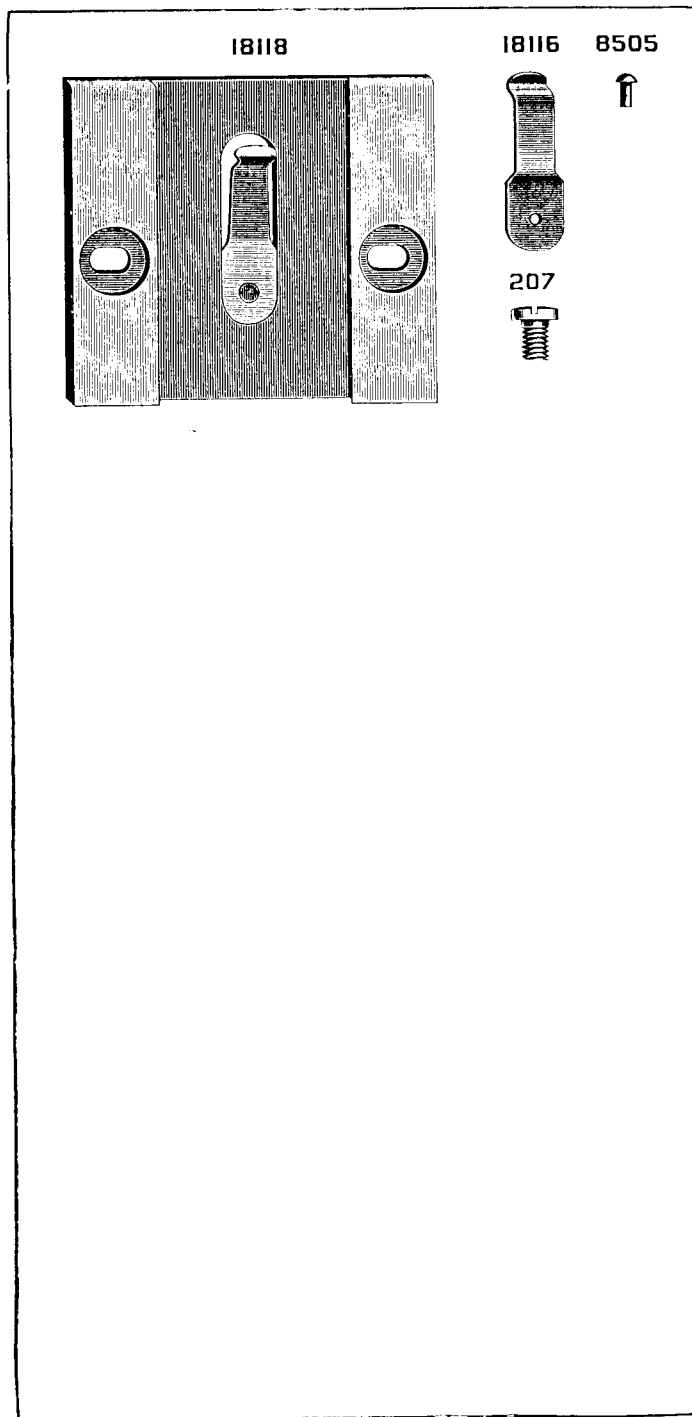
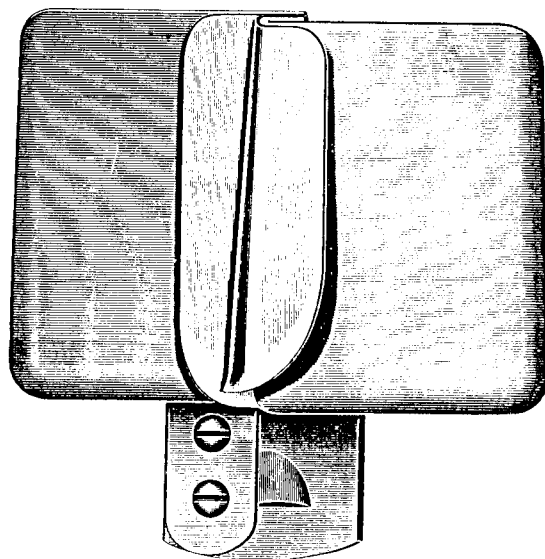
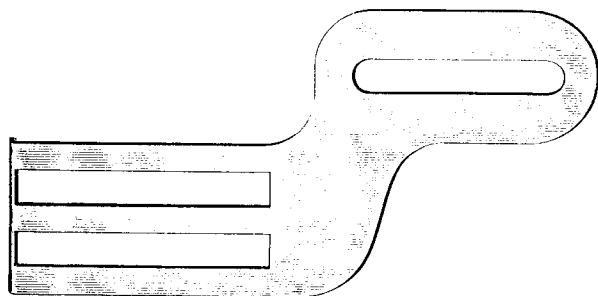


PLATE 5229—FULL SIZE

35617



35634



35633

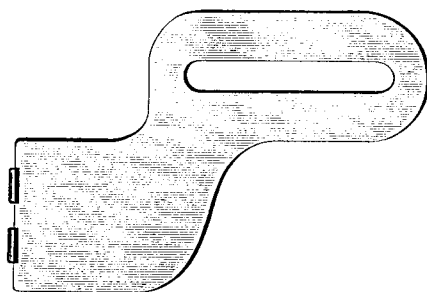
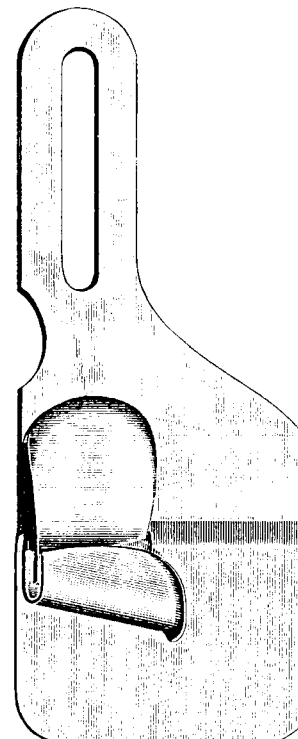


PLATE 5230—FULL SIZE

35632



35626

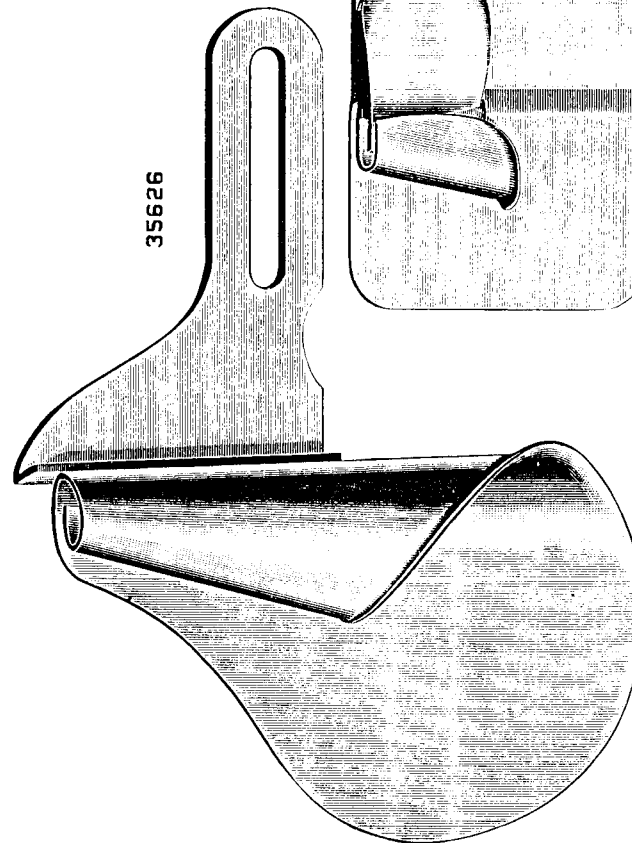


PLATE 5231—FULL SIZE

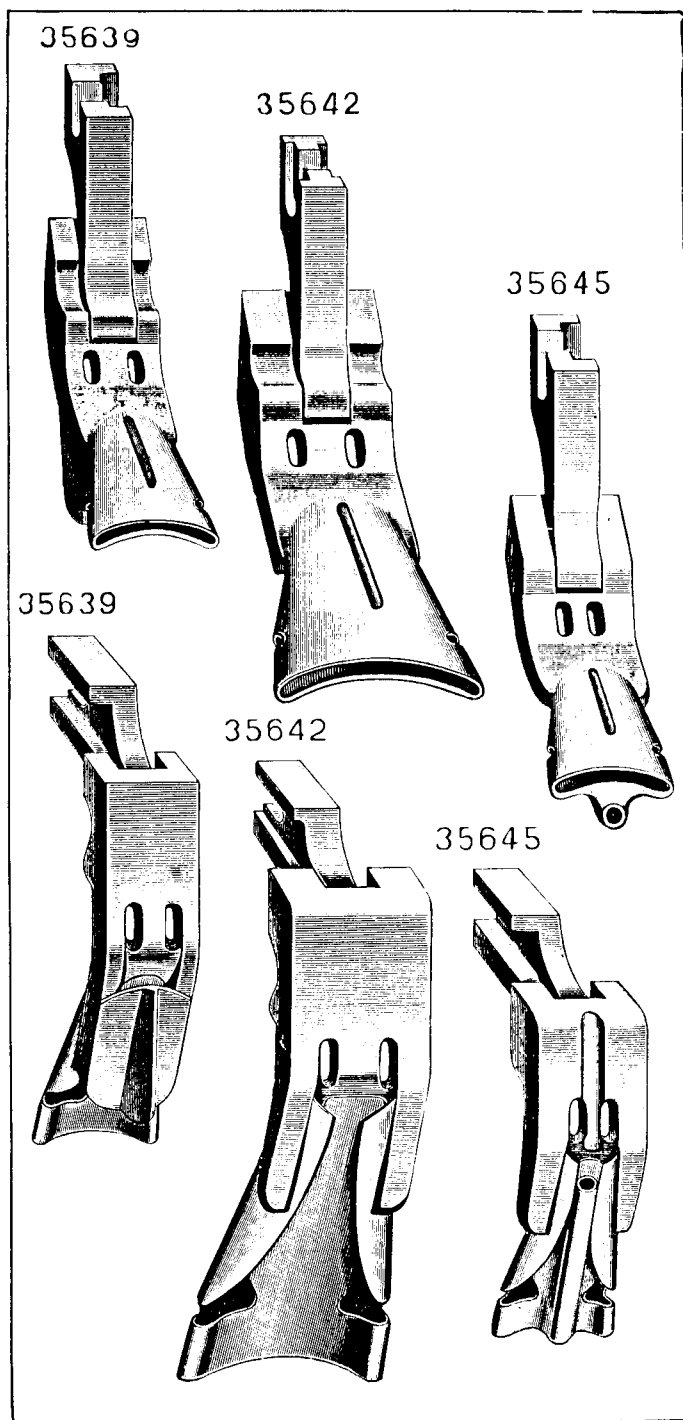


PLATE 5232—FULL SIZE

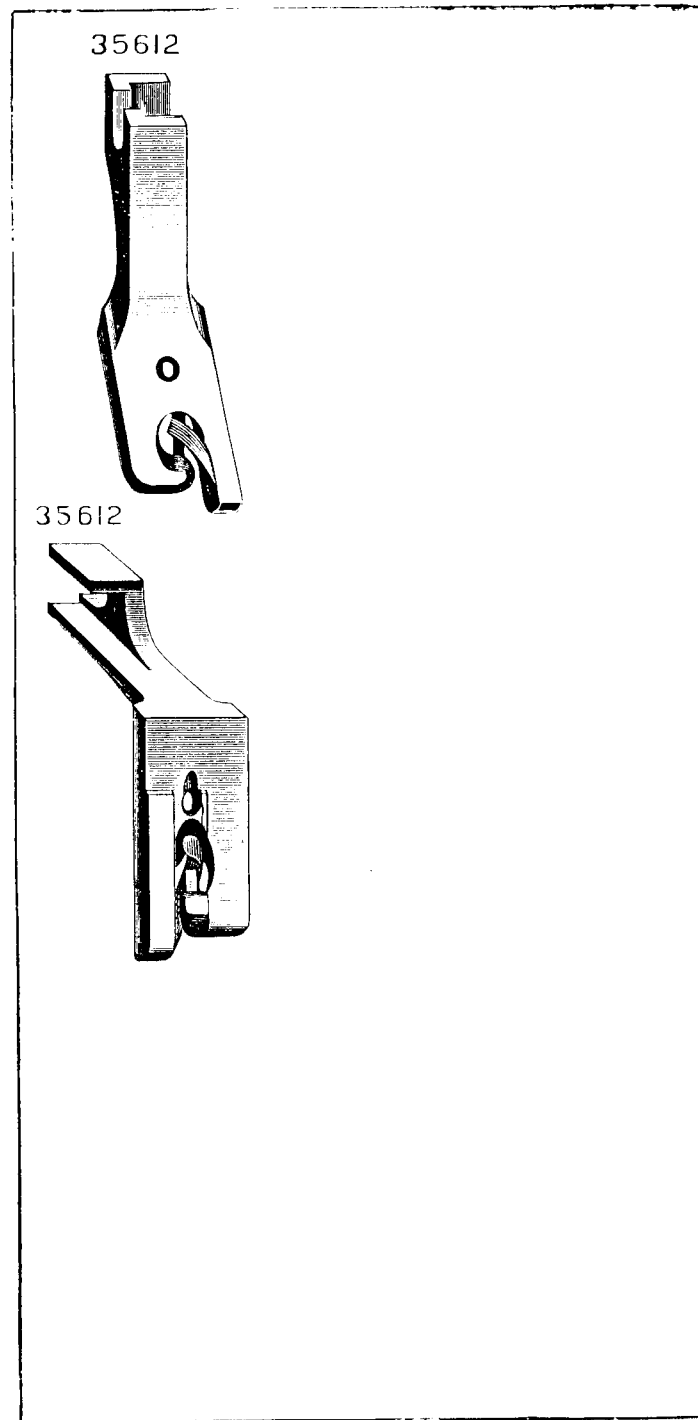


PLATE 5233—ONE-HALF SIZE

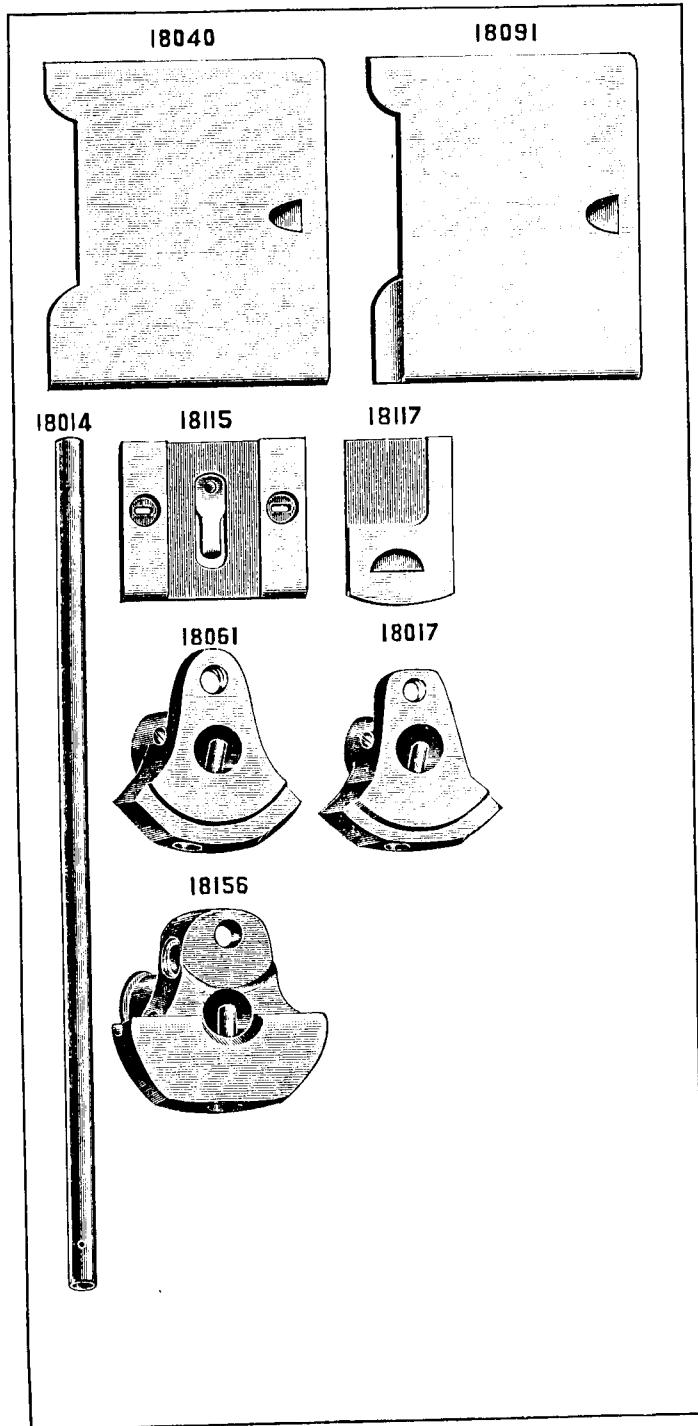


PLATE 5234—ONE-HALF SIZE

26026 26485 120344 120341 10875 18270

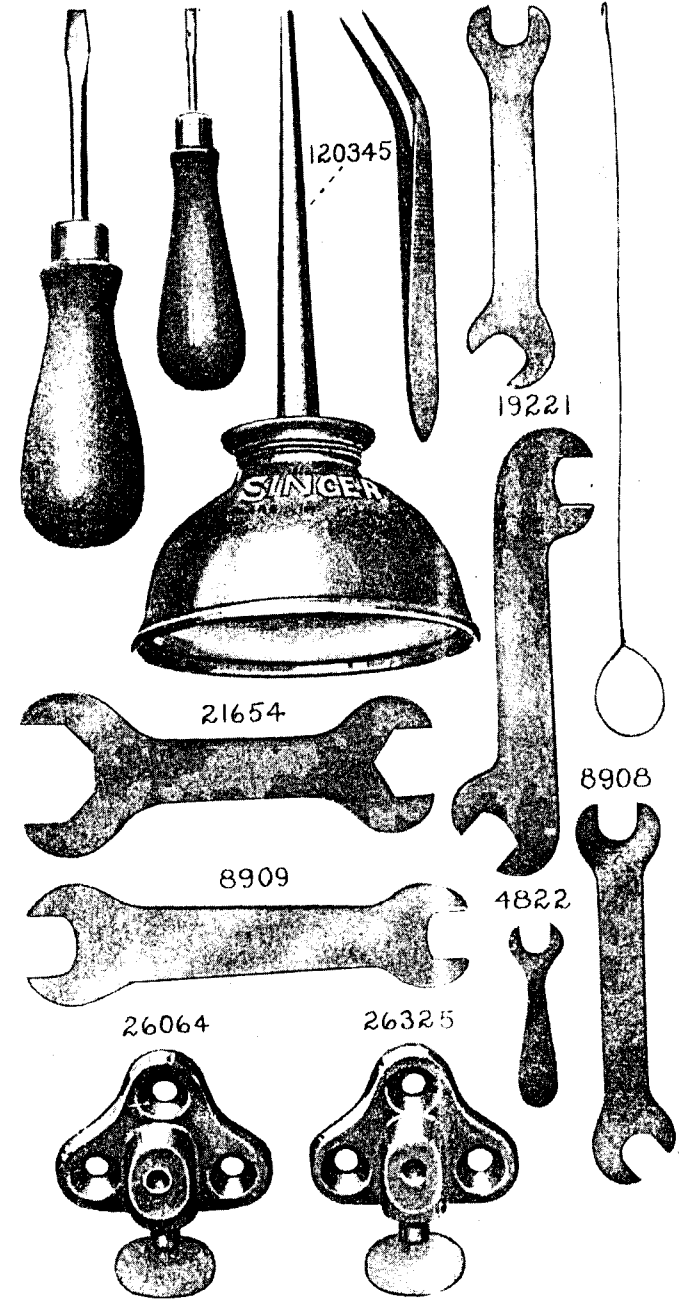


PLATE 5236—ONE-HALF SIZE

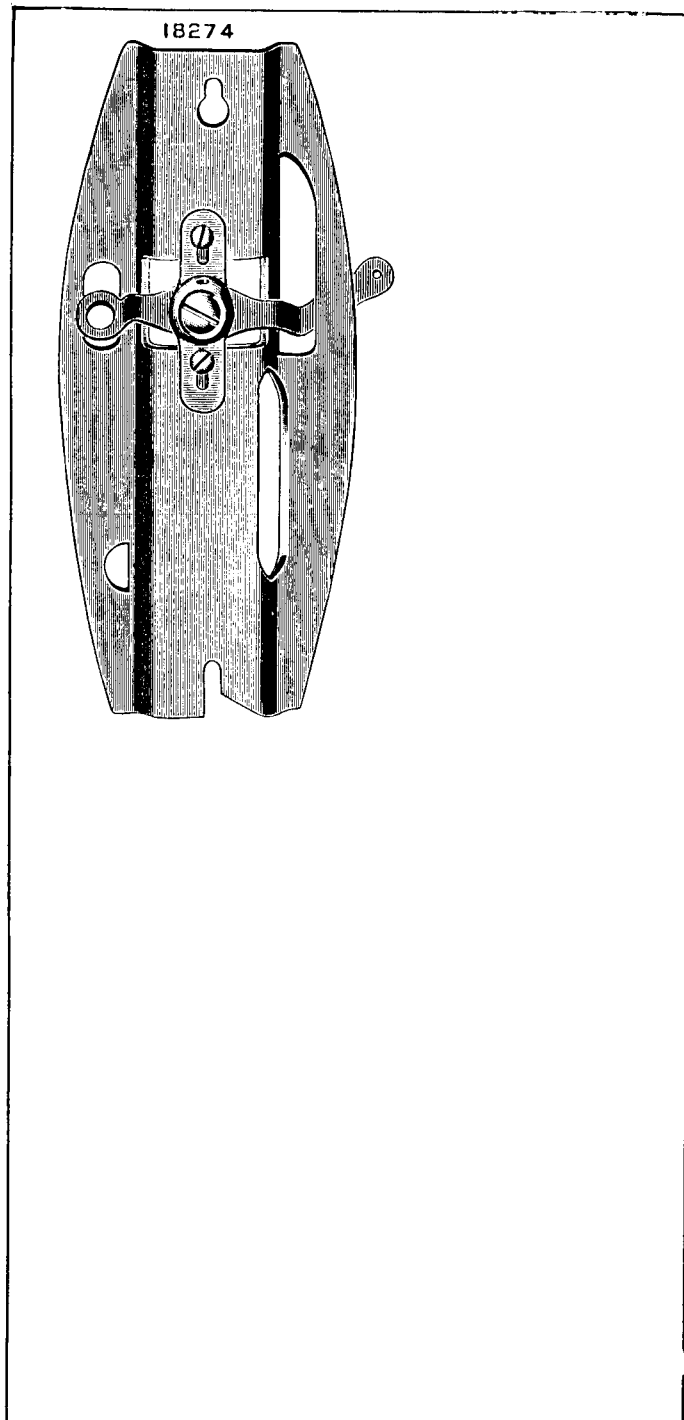


PLATE 5237—ONE-HALF SIZE

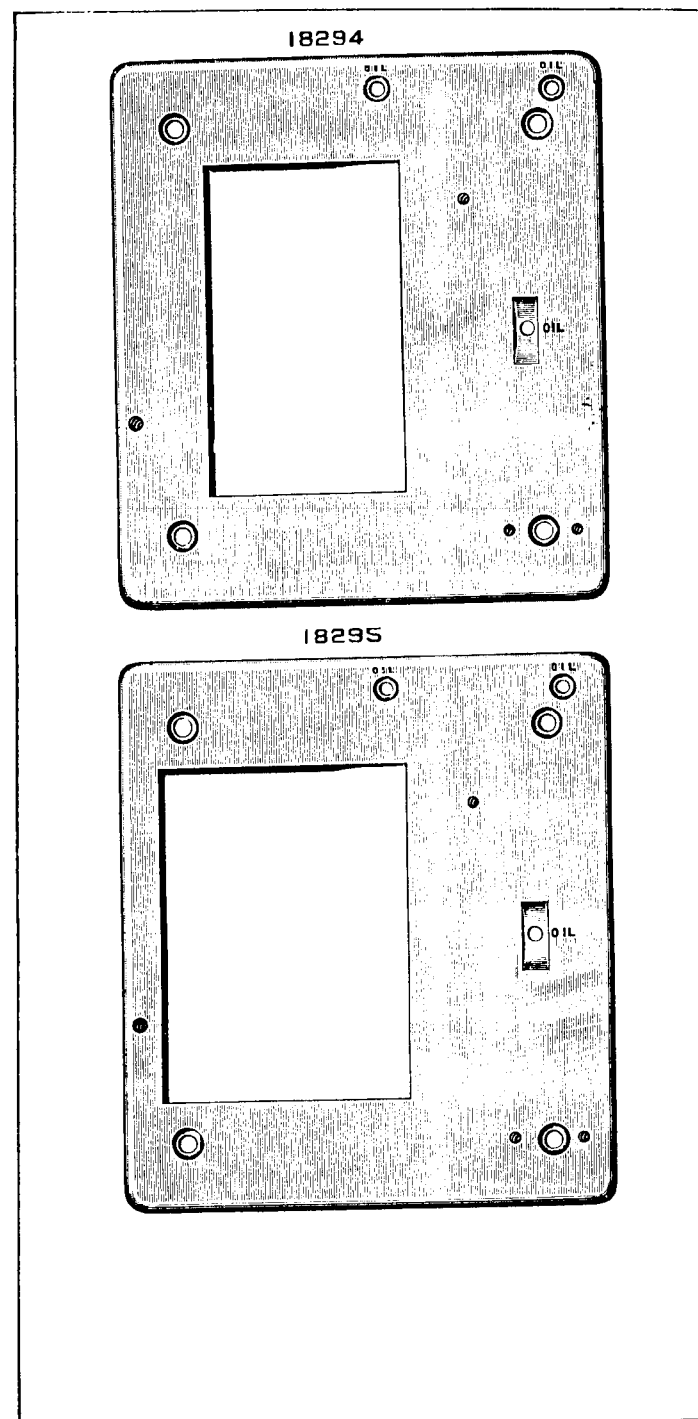


PLATE 5238—FULL SIZE

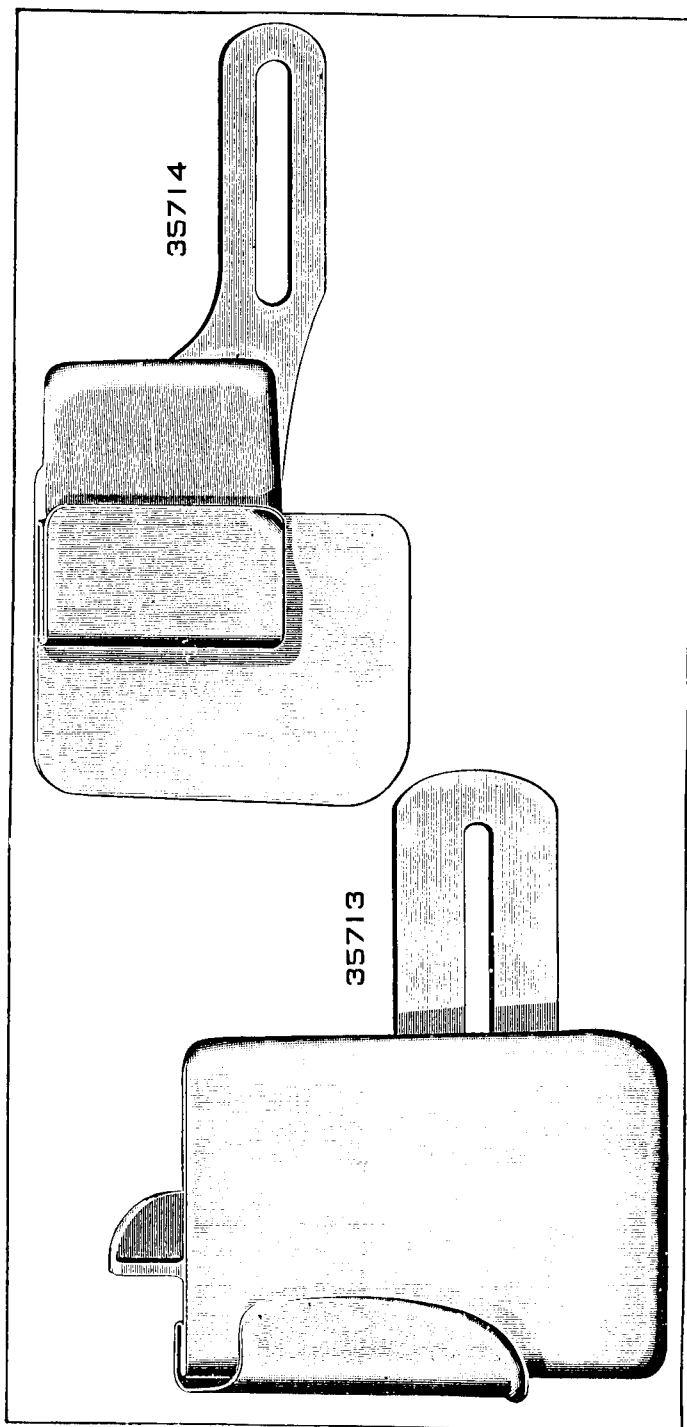


PLATE 5239—FULL SIZE

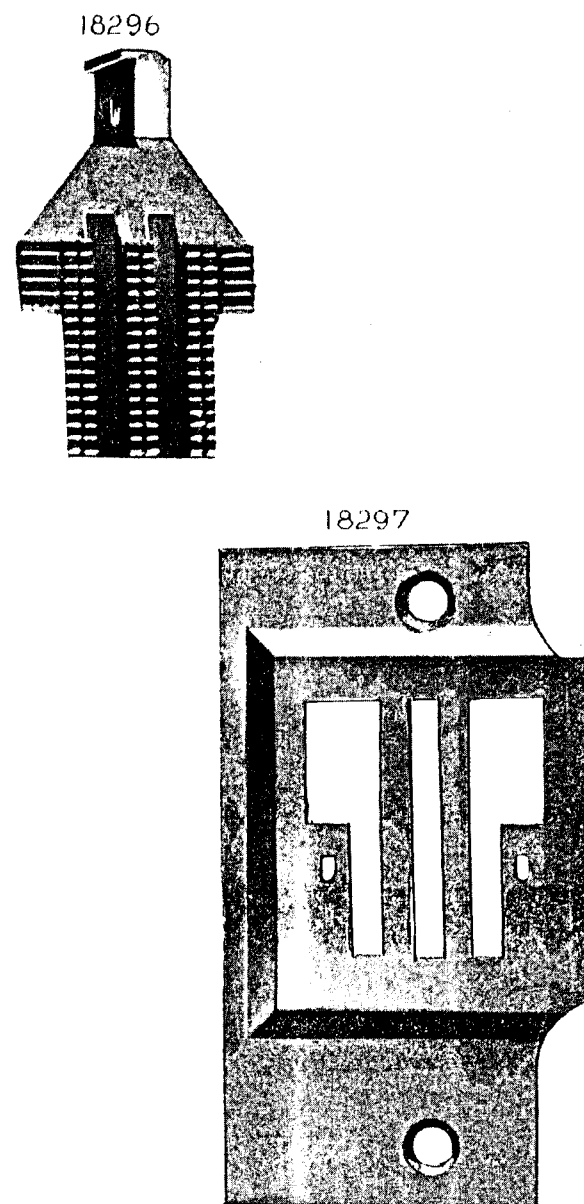


PLATE 5240—ONE-HALF SIZE

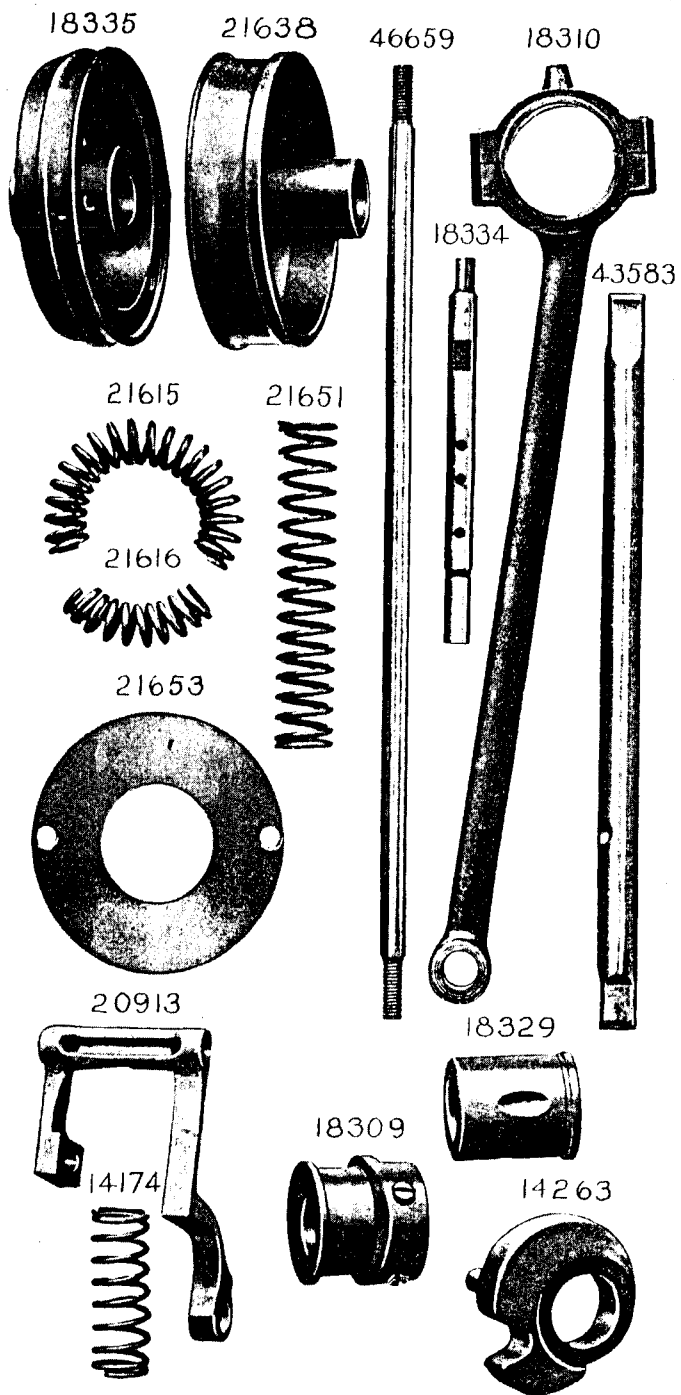


PLATE 5241—FULL SIZE

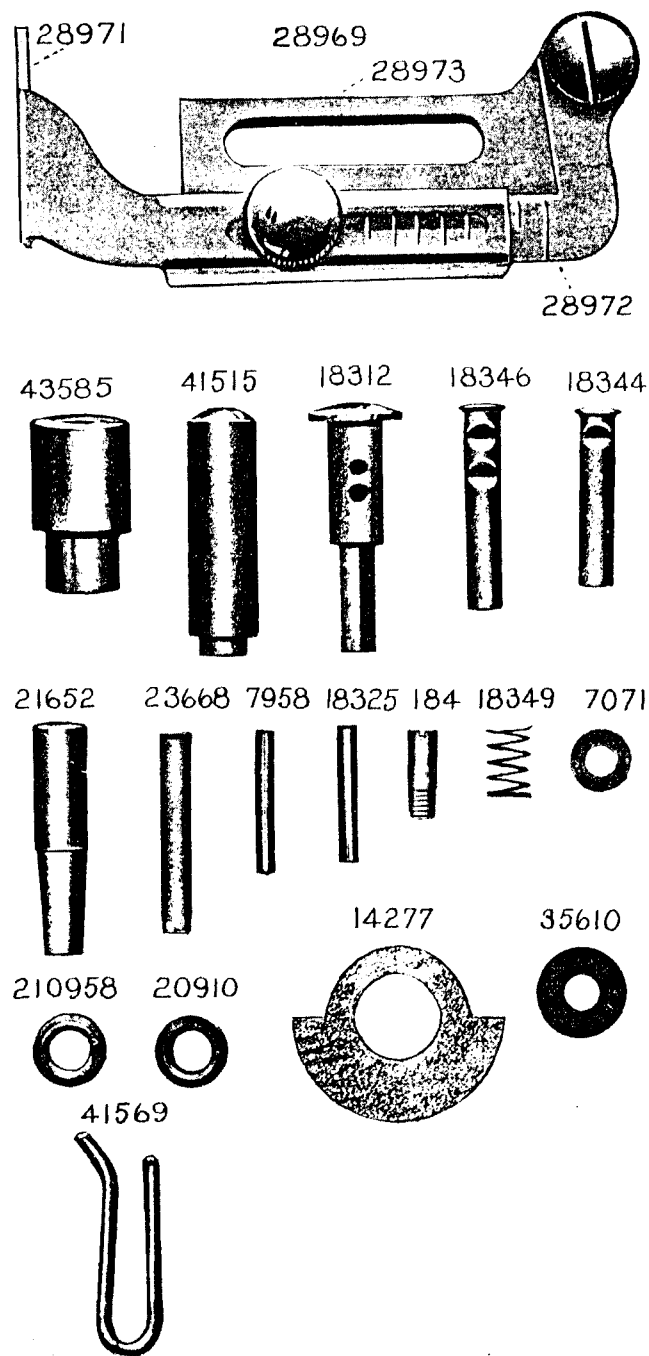


PLATE 5242—FULL SIZE

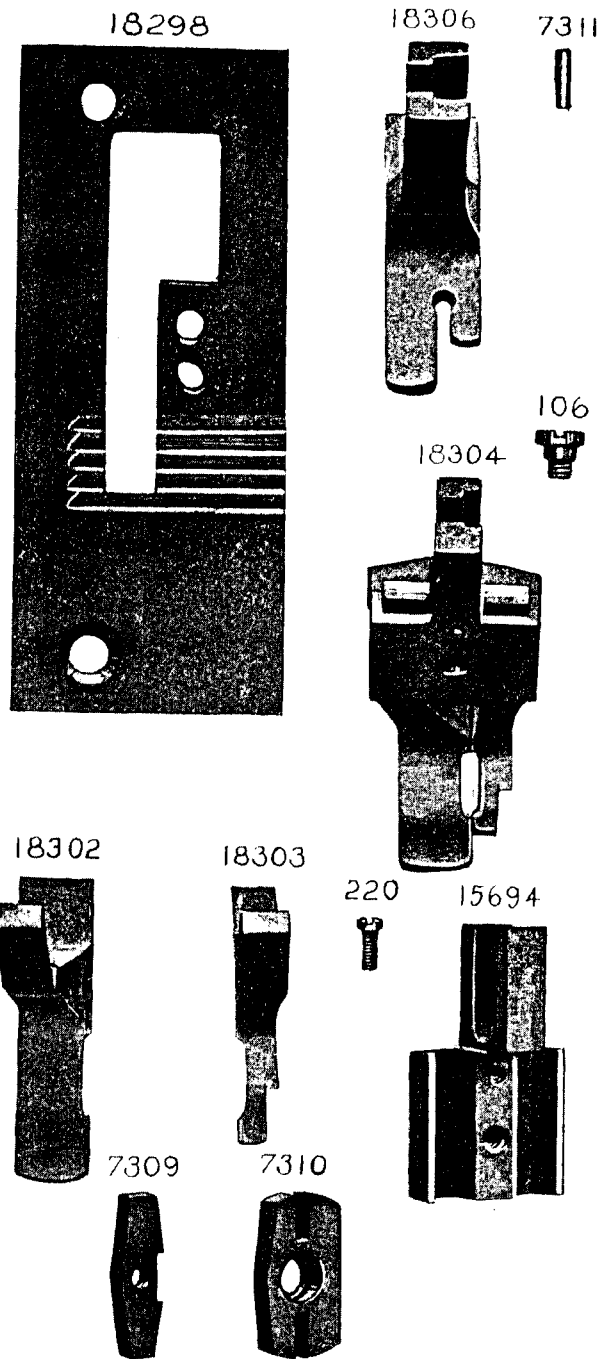


PLATE 5243—FULL SIZE

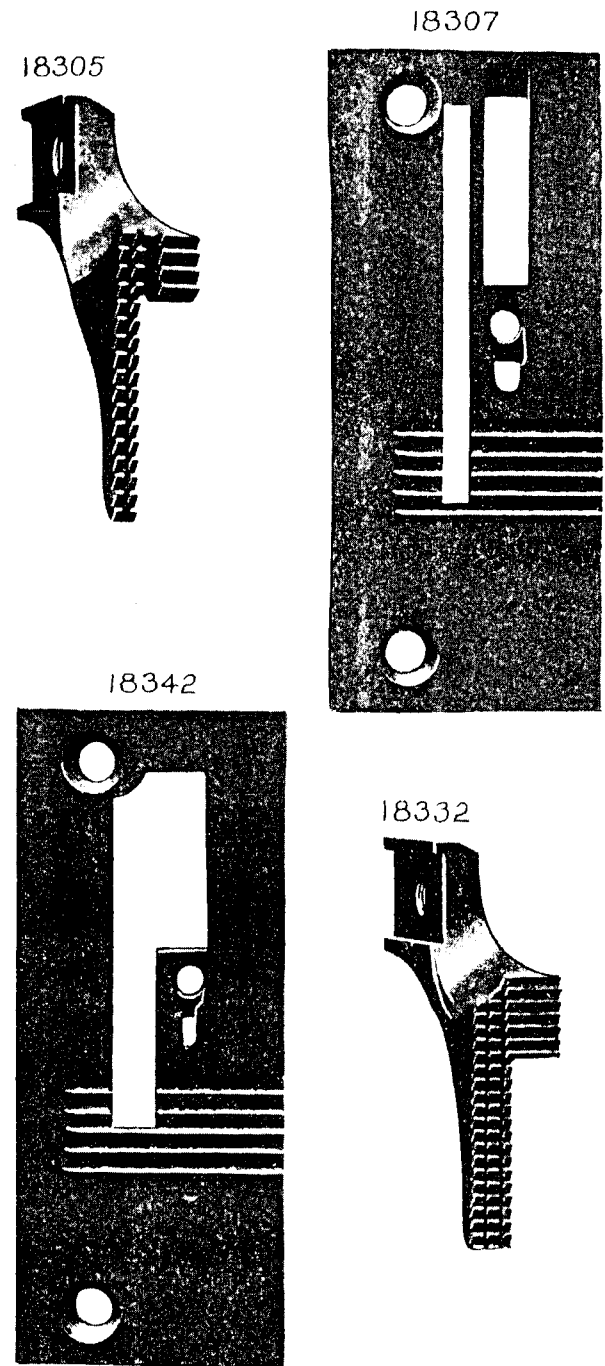


PLATE 5244—ONE-FOURTH SIZE

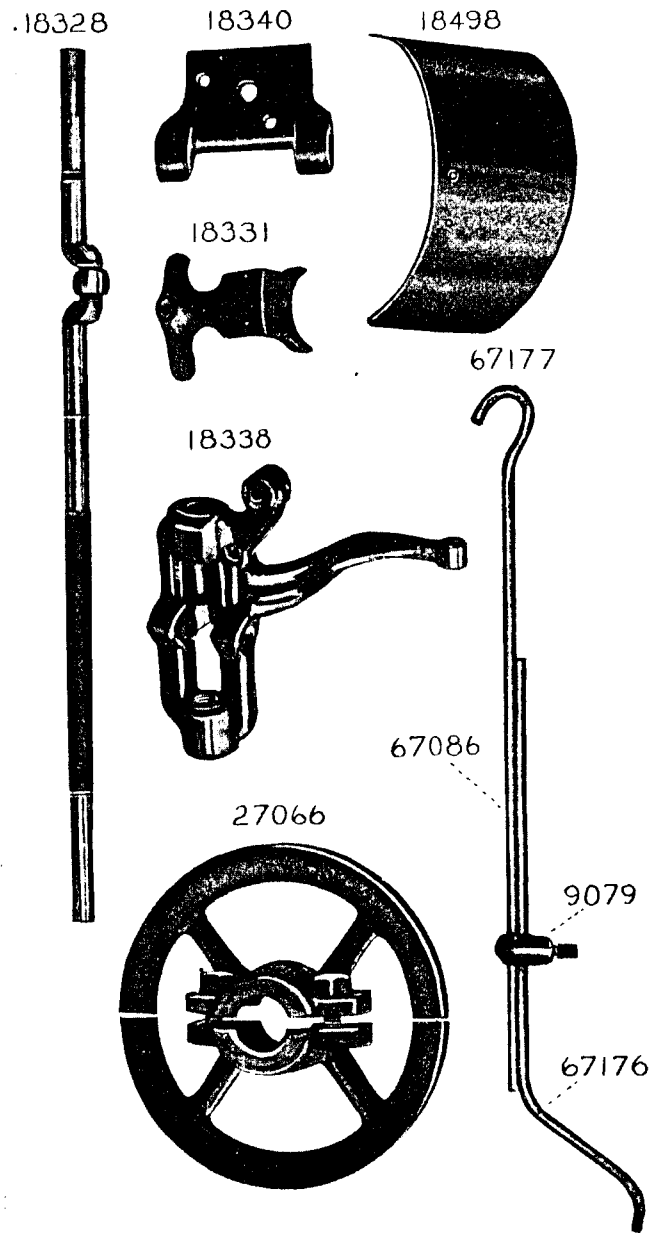


PLATE 5245—FULL SIZE

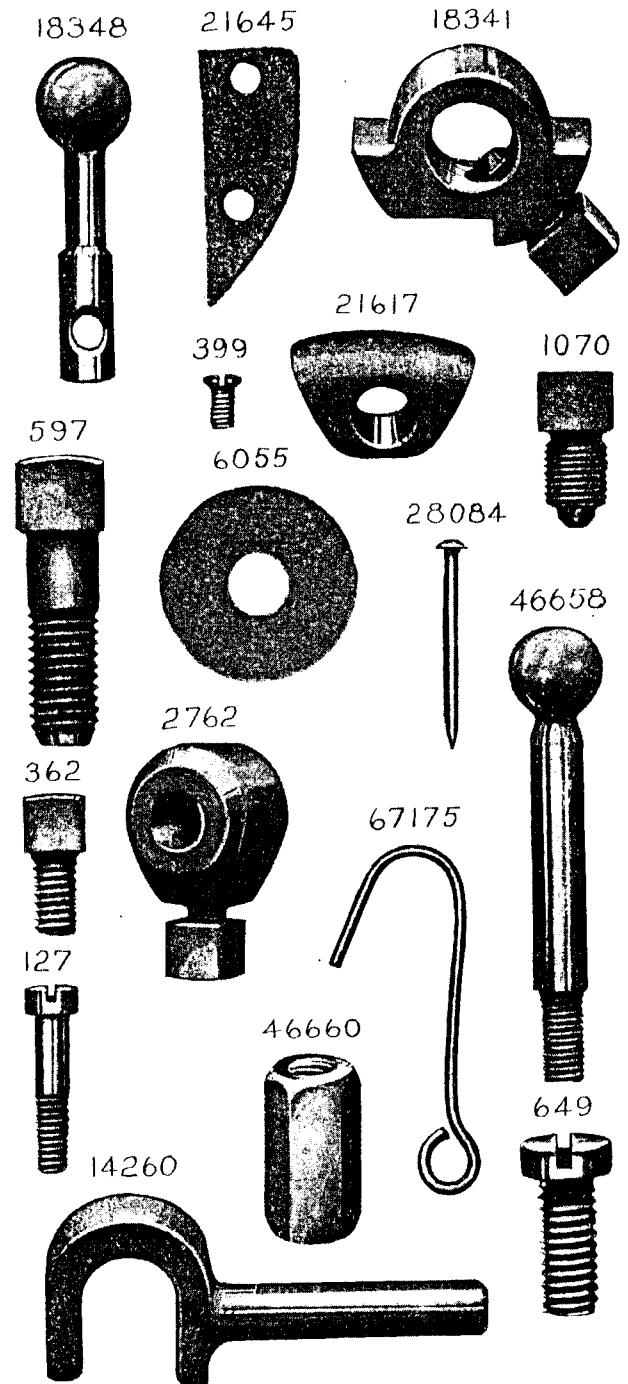
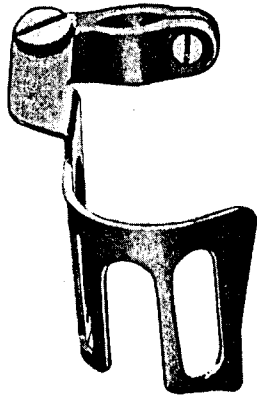
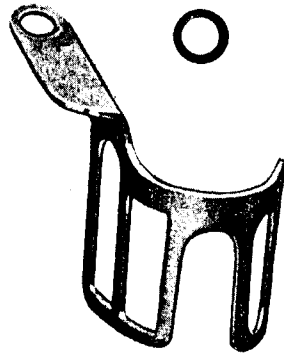


PLATE 5809—FULL SIZE

36821



36818



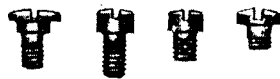
36819



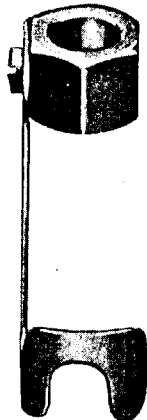
36820



50316 196 50302 236



120498



120496



120497

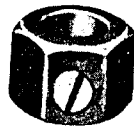
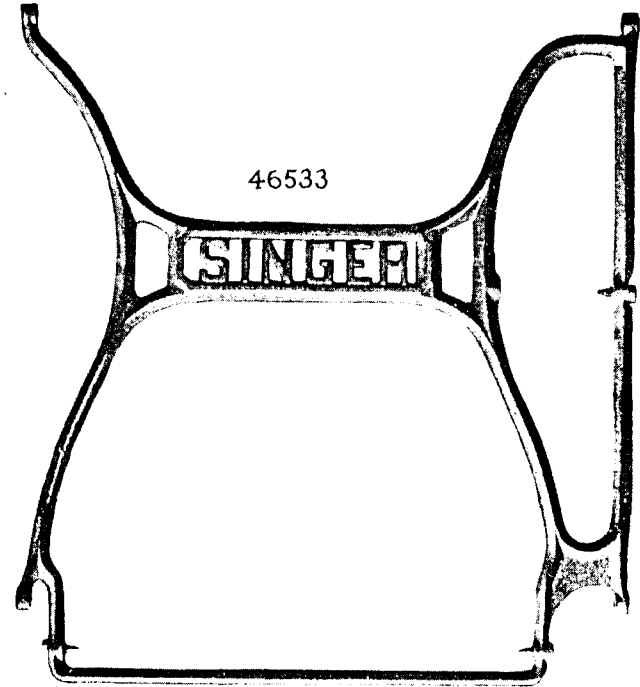


PLATE 6142—ONE-EIGHTH SIZE

46533



46662

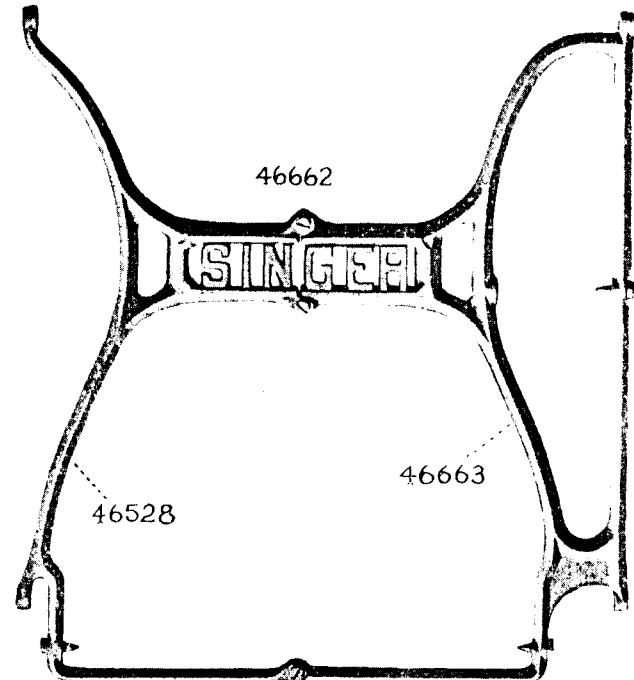


PLATE 7233—ONE-FOURTH SIZE

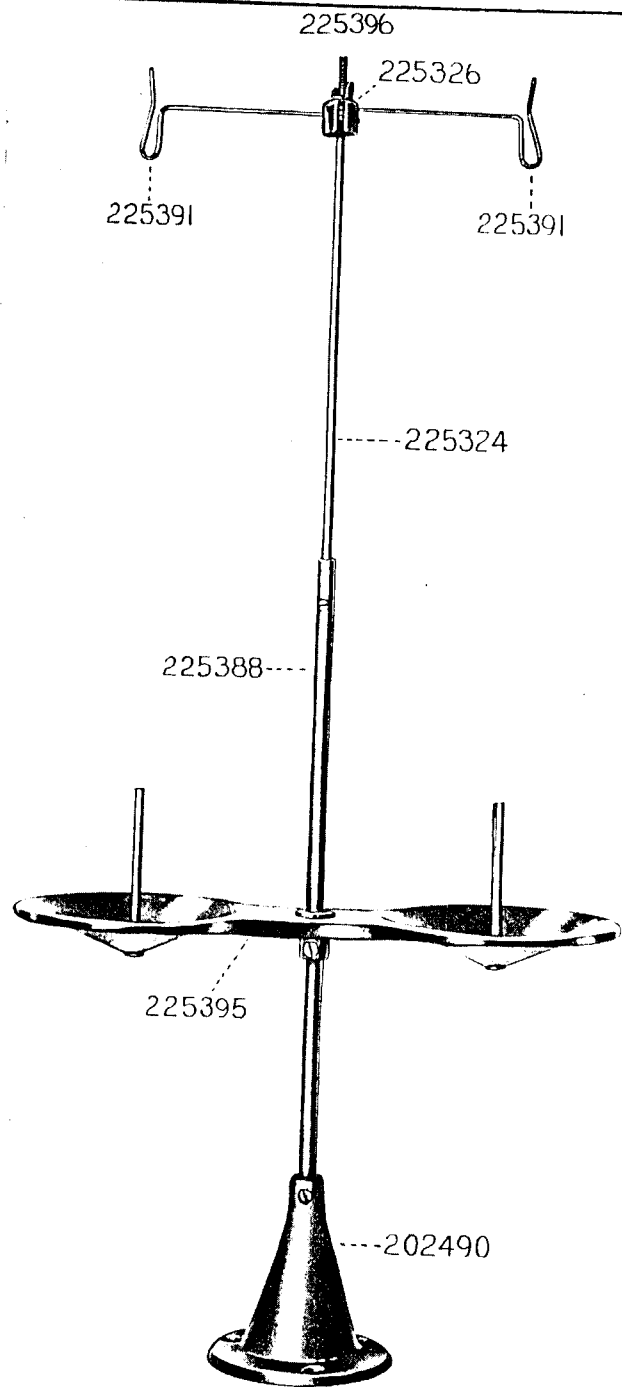


PLATE 7234—ONE-HALF SIZE

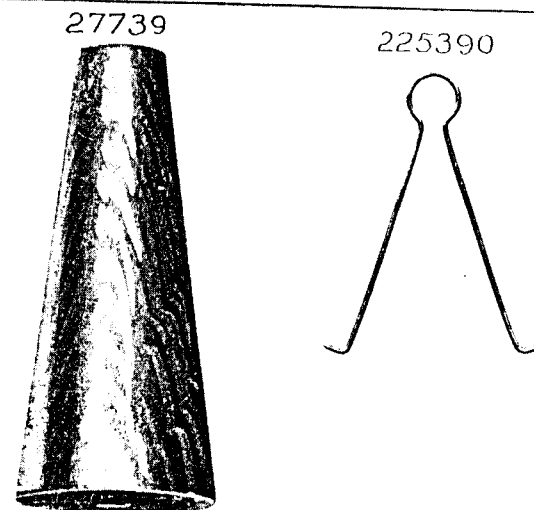


PLATE 7711—ONE-FOURTH SIZE

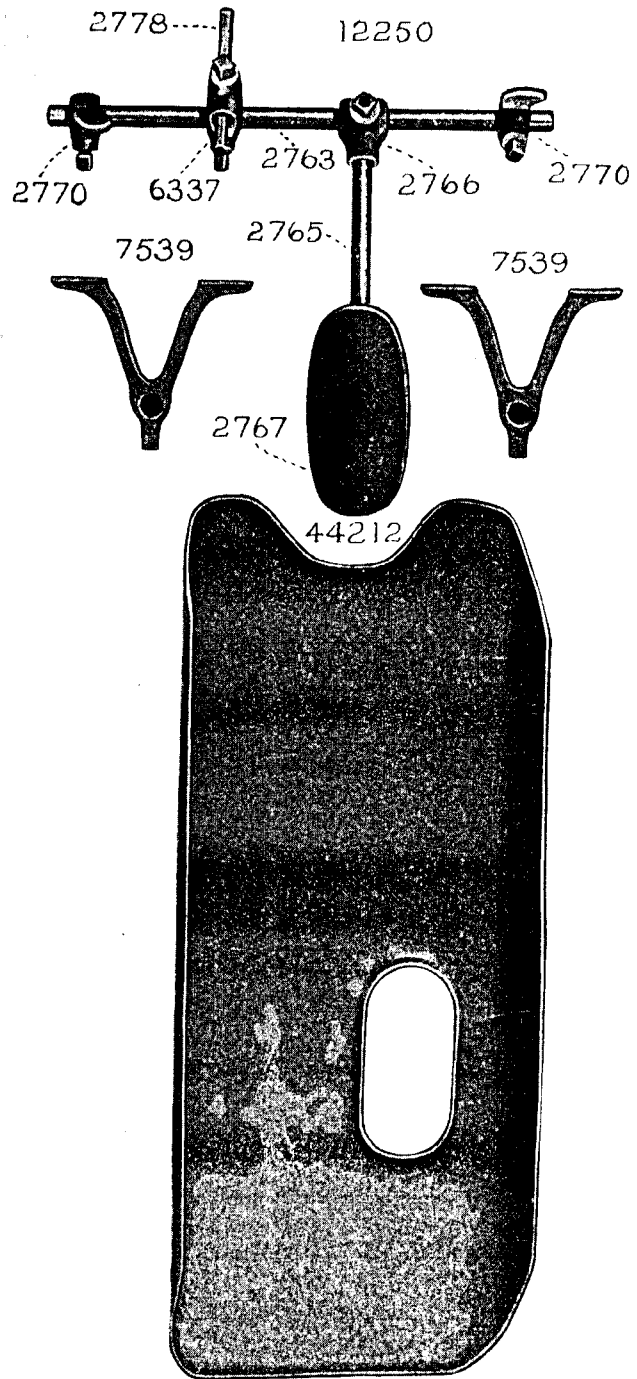


PLATE 8382—ONE-FOURTH SIZE

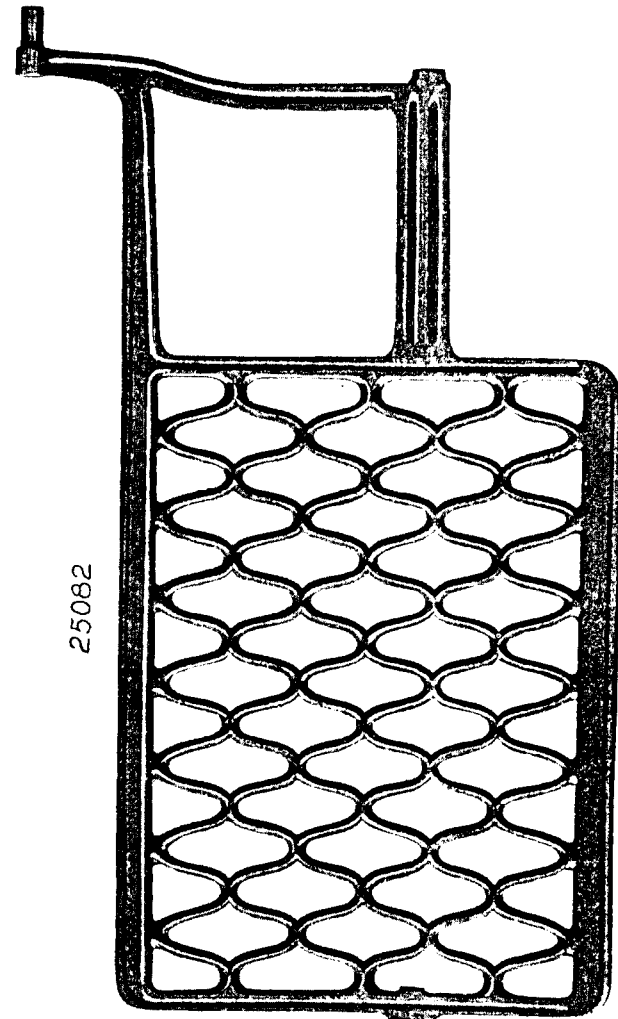


PLATE 8953—ONE-FOURTH SIZE

