

SINGER
155B8BV

SINGER

PARTS LIST

FOR

155B8BV

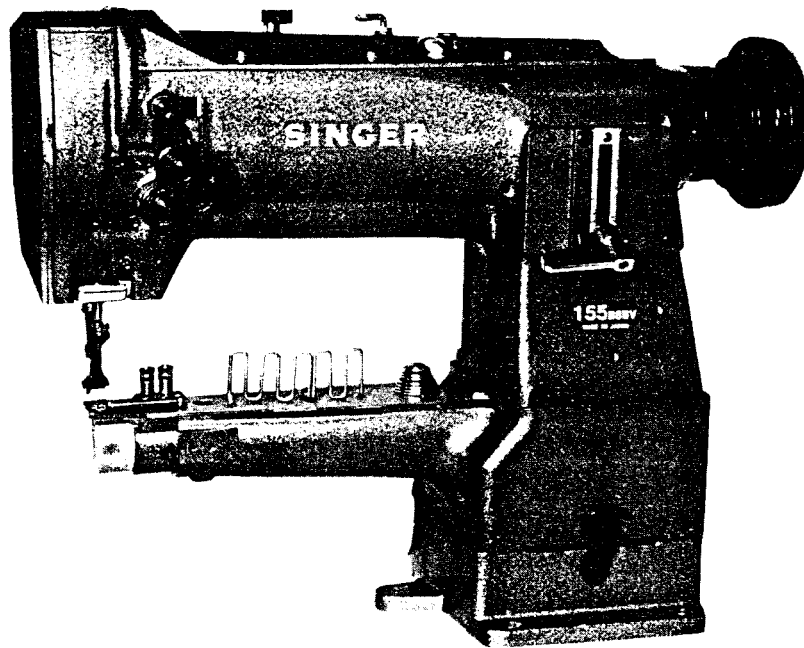

INDEX

	Page
Needle bar, Presser bar	1-2
Thread take up lever, Vibrating presser bar	3-4
Arm shaft, Knee lifter lifting lever	5-6
Balance wheel, Feed regulator	7-8
Special parts for 155B8BV	9-10
Arm top cover, Thread tension	11-12
Accessories	13-16
Hook	17-18

1

NEEDLE BAR, PRESSER BAR

Fig. No.	Parts No.	Quantity	Name	Remarks
1	10543	1	Presser bar position guide	
2	10761	1	Set screw for # 10543	
3	10538	1	Presser bar bushing (upper)	
4	10539	1	Presser bar bushing (lower)	
5	10761	2	Set screw for presser bar bushing	
6	10540	1	Presser bar	
7	17083	1	Lifting presser foot (9mm)	The length is 9mm from center of Needle plate to edge of left side.
	17084	1	Lifting presser foot (7mm)	The length is 7mm from center of Needle plate to edge of left side.
8	10664	1	Lifting presser foot set screw	
9	10659	1	Presser bar lifter	
10	10660	1	Pin for # 10659	
11	10541	1	Presser bar position guide bracket	
12	10662	1	Set screw for # 10541	
13	10544	1	Presser bar lifting bracket	
14	10548	1	Presser bar lifting bracket guide screw	
15	10545	1	Set screw for # 10544	
16	10559	1	Set screw for # 10558	
17	10547	1	Tension release spring	
18	10546	1	Tension release slide	
19	10549	1	Presser bar spring bracket	
20	10532	1	Set screw for # 10549	
21	10537	1	Needle bar rock frame hinged stud	
22	10525	1	Set screw for # 10537	
23	15030	1	Needle bar rock frame	
24	10560	1	Needle bar rock frame position bracket	
25	10561	1	Set screw for # 10560	
26	15031	1	Oil wick for # 15030	
27	15032	1	Needle bar	
28	6332	1	Needle DPx17	
29	15089	1	Needle bar thread guide	
30	10535	1	Needle set screw	
31	4221	1	Oil wick catcher	
32	10514	2	Lifting rock shaft bushing	
33	10515	1	Lifting rock shaft	
34	15053	1	Lifting bell crank link screw stud	
35	10728	1	Oil wick for # 15053	
36	10517	1	Lifting bell crank link screw stud nut	
37	10775	1	Hinge screw for # 10772	
38	10703	1	Washer for # 10775	
39	16505	1	Lifting eccentric connecting crank	
40	10754	1	Set screw for # 16505	
41	10774	1	Lifting eccentric connection collar	
42	10772	1	Lifting eccentric connection	
43	10773	1	Needle bearing for # 10772	
44	10776	1	Wing nut for # 10772	
45	10771	1	Lifting eccentric	
46	10566	2	Set screw for # 10771	

NOTE! WHEN ORDERING PARTS, PREFIX ALL NUMBERS WITH CS; EXAMPLE: CS_____

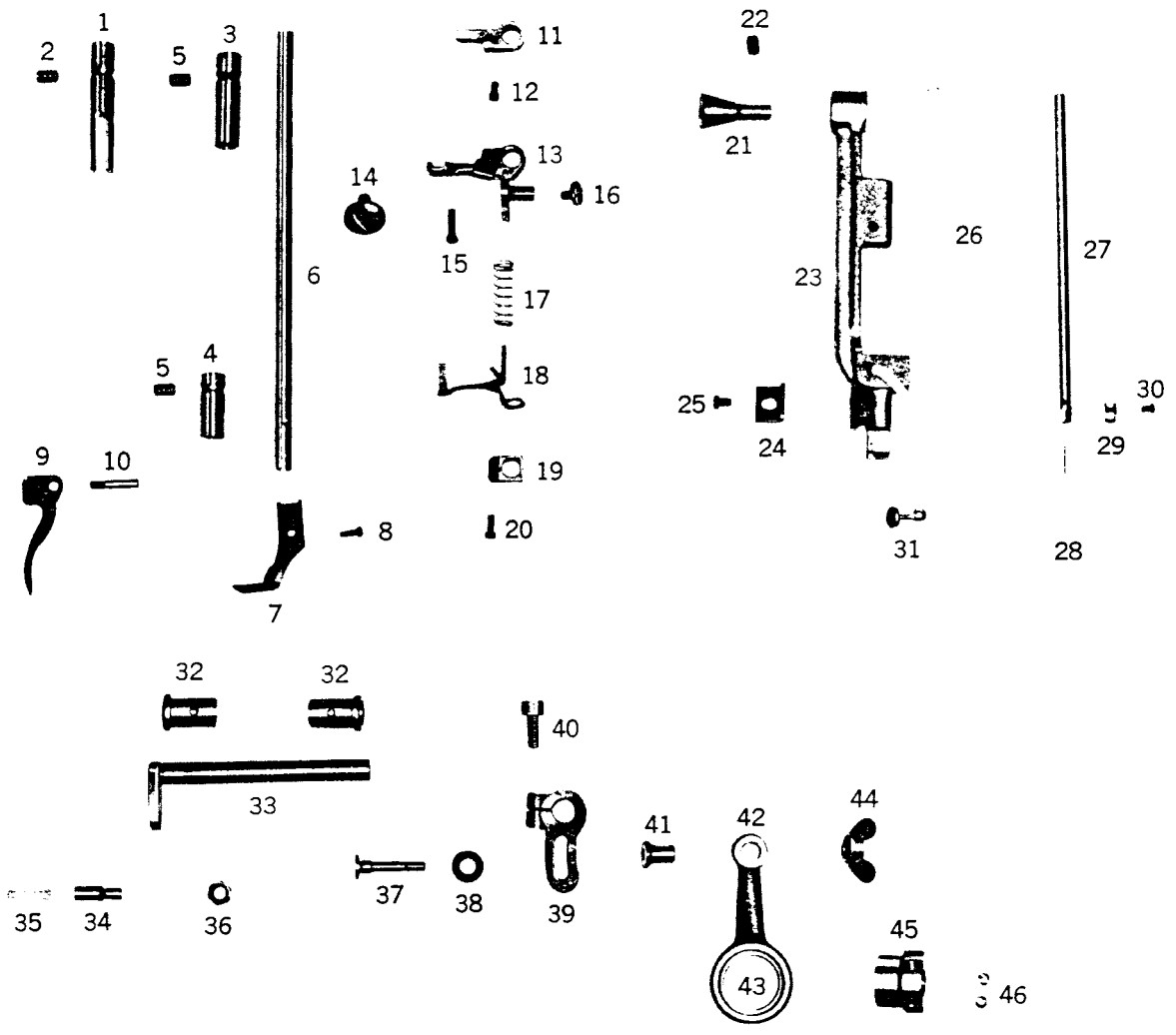
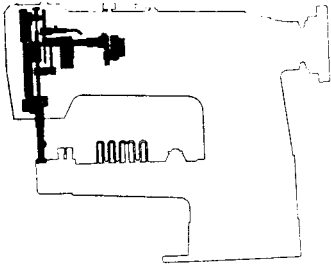

3

THREAD TAKE UP LEVER, VIBRATING PRESSER BAR

Fig. No.	Parts No.	Quantity	Name	Remarks
47	10557	1	Lifting bell crank link	
48	10558	1	Lifting bell crank	
49	10556	1	Vibrating presser bar connecting link	
50	17042	1	Vibrating presser bar spring	
51	10555	1	Vibrating presser bar	
52	17086	1	Vibrating presser foot (9mm)	The length is 9mm from center of Needle plate to edge of left side.
	17087	1	Vibrating presser foot (7mm)	The length is 7mm from center of Needle plate to edge of left side.
53	10662	1	Set screw for vibrating presser foot	
54	15060	1	Screw for #10555	
55	10553	1	Vibrating presser bar extension	
56	10524	1	Set screw for #15013	
57	15013	1	Thread take up lever hinged stud	
58	11042	1	Oil wick for #15013	
59	17010	1	Thread take up lever	
60	10529	1	Take up lever driving stud	
61	10728	1	Oil wick for #10529	
62	10532	1	Set screw for #10531	
63	10531	1	Needle bar connecting stud	
64	10726	1	Oil wick for #10531	
65	10528	1	Needle bar connecting link	
66	10551	1	Needle bar connecting link oil guard	
67	10650	1	Set screw for #10551	
68	10523	1	Needle bar connecting link stud	
69	10726	1	Oil wick for #10523	
70	10563	1	Arm shaft bushing(front) washer	
71	10520	1	Needle bar crank	
72	10764	1	Set screw (B) for #10523	
73	10524	1	Set screw (A) for #10523	
74	10521	1	Set screw (A) for #10520	
75	10522	1	Set screw (B) for #10520	

NOTE! WHEN ORDERING PARTS, PREFIX ALL NUMBERS WITH CS; EXAMPLE: CS_____

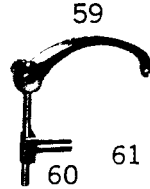
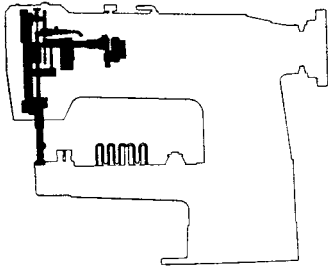

49

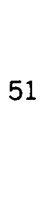

51



52



53



60



61



68



69



72



73

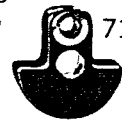

71



74



75



62



63



64



65

5

ARM SHAFT, KNEE LIFTER LIFTING LEVER

Fig. No.	Parts No.	Quantity	Name
1	13056	1	Knee lifter lifting lever
2	10712	1	Set screw for # 13056
3	11387	1	Foot lifter lifting lever spring
4	10705	1	Presser bar spring (flat)
5	11156	1	Presser bar spring regulating screw
6	10706	1	Presser bar spring support screw
7	13084	2	Nut for # 13057
8	13057	1	Foot lifter lever stop flanger
9	13058	1	Screw for # 13057
10	10562	1	Arm shaft bushing (front)
11	10729	1	Oil wick for # 10562
12	10725	3	Oiling felt for # 10562
13	10571	1	Set screw for # 17012
14	17012	1	Arm shaft bushing (middle)
15	10725	2	Oiling felt for # 17012
16	10766	2	Set screw for # 17014
17	17014	1	Arm shaft bushing collar
18	10766	2	Set screw for # 17039
19	17039	1	Feed driving eccentric
20	17018	1	Set screw (A) for # 17017
21	17019	1	Set screw (B) for # 17017
22	17017	1	Arm shaft gear (spiral)
23	10571	1	Set screw for # 17013
24	17013	1	Arm shaft bushing (rear)
25	13081	1	Oiling felt for # 17013
26	10506	1	Arm shaft oil packing stop screw
27	15033	1	Oil wick for # 17011
28	17011	1	Arm shaft
29	17048	1	Needle bar rock frame rock shaft
30	10582	1	Needle bar rock frame slide block
31	10580	1	Needle bar rock frame slide block stud
32	10581	1	Set screw for # 10580
33	10519	1	Set screw for # 17049
34	17049	1	Needle bar rock frame rock shaft crank
35	17047	1	Rock shaft crank stud screw
36	17050	1	Connecting rod
37	17095	1	Washer for # 17047
38	10723	1	Oiling felt presser pin
39	17041	1	Oiling felt for # 17040
40	17040	1	Feed fork collar
41	17043	1	Feed fork
42	17044	1	Feed fork connecting link
43	17038	1	Hinge screw (long) for # 17044
44	8105	2	Nut for # 17038
45	8014	1	Hinge screw (short) for # 17044

NOTE! WHEN ORDERING PARTS, PREFIX ALL NUMBERS WITH CS; EXAMPLE: CS_____

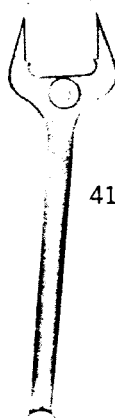
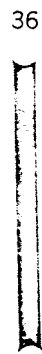
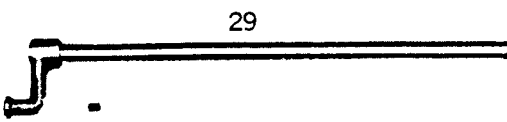
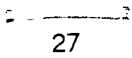
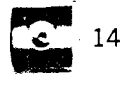
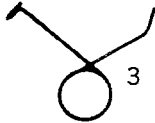
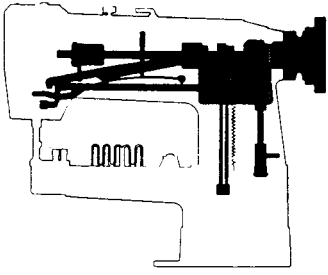

7

BALANCE WHEEL, FEED REGULATOR

Fig. No.	Parts No.	Quantity	Name
46	17056	1	Set screw for \approx 17055
47	17055	1	Feed regulating support stud
48	17057	1	Washer for \approx 17052
49	17053	1	Set screw for \approx 17052
50	17052	1	Feed regulator
51	17059	1	Set screw for \approx 10806
52	4135	1	Nut for \approx 10806
53	10806	1	Feed regulating lever spring
54	4019	1	Set screw for \approx 17061
55	17061	1	Feed regulating lever
56	13417	1	Feed adjusting pipe
57	13416	1	Feed adjusting knurling tool
58	13414	1	Reverse stitch lever
59	8157	1	Spring for \approx 8158
60	8158	1	Bearing ball 1/8"
61	8103	2	Screw (small) for \approx 17061
62	17054	1	Feed regulating base
63	1368	1	Supporting stud pushing screw
64	12361	4	Set screw for \approx 17054
65	50174	2	Pin for \approx 17054
66	8100	2	Set screw for \approx 17005
67	17005	1	Arm side cover
68	17058	1	Stitch length indicator
69	17093	2	Set screw for \approx 17058
70	17015	1	Gear cover (upper)
71	17016	2	Set screw for \approx 17015
72	17021	1	Arm shaft (upright) gear (upper)
73	17022	2	Set screw for \approx 17021
74	17020	1	Arm shaft (upright)
75	17023	1	Arm shaft (upright) gear (lower)
76	17022	2	Set screw for \approx 17023
77	17024	1	Arm shaft (upright) bushing (upper)
78	17026	1	Oiling felt for \approx 17024
79	10761	1	Set screw for \approx 17024
80	17025	1	Arm shaft (upright) bushing (lower)
81	17026	1	Oiling felt for \approx 17025
82	10571	1	Set screw for \approx 17025
83	10566	1	Set screw for \approx 13423A & \approx 13423B
84	13423A	1	Stitch length indicator ring (used with belt guard)
	13423B	1	Stitch length indicator ring (used without belt guard)
85	10504	1	Balance wheel
86	10576	1	Set screw (A) for \approx 10504
87	10579	1	Set screw (B) for \approx 10504
88	10577	1	Adjusting screw for \approx 10504

NOTE! WHEN ORDERING PARTS, PREFIX ALL NUMBERS WITH CS; EXAMPLE: CS_____

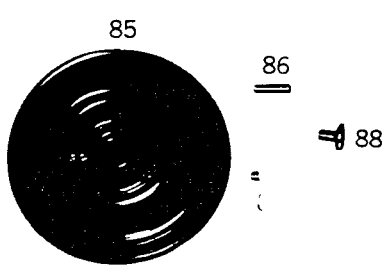
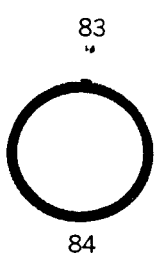
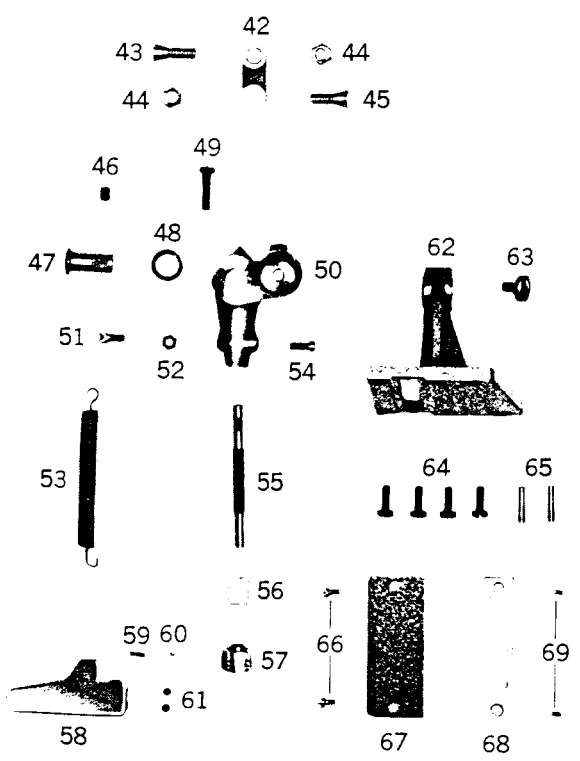
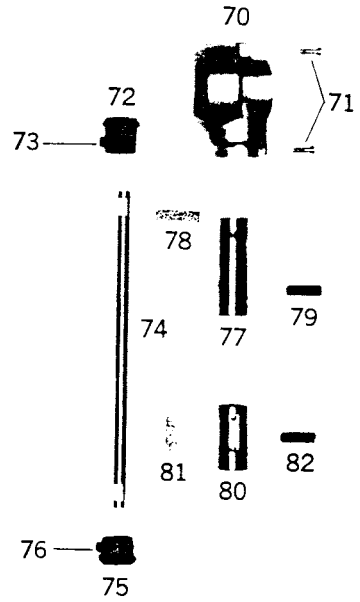
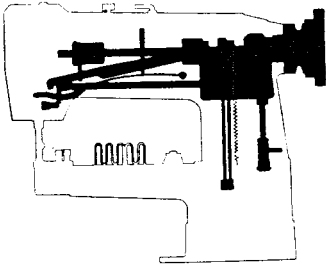

9

SPECIAL PARTS FOR 155B8BV

Fig. No.	Parts No.	Quantity	Name	Remarks
1	2A-14-6	1	Binder (Standard)	Standard
2	13256	1	Tape guide	
3	13235	1	Washer for \approx 21104	
4	21104	1	Set screw for \approx 13256	
5	17080	2	Nut for \approx 13256	
6	17078	1	Binder set plate	
7	17079	2	Binder set screw	
8	17071	1	Spring for \approx 17078	
9	17070	1	Washer for \approx 17064	
10	17064	1	Pushing screw for \approx 17078	
11	17089	1	Needle plate	The length is 9mm from center of Needle plate to edge of left side.
	17090	1	Needle plate	The length is 7mm from center of Needle plate to edge of left side.
12	6031	2	Set screw for \approx 17090	
13	17094	1	Cylinder	
14	17092	1	Needle plate supporting plate	
15	17093	4	Set screw for \approx 17092	
16	17073	1	Feed dog	The length is 9mm from center of Needle plate to edge of left side.
	17074	1	Feed dog	The length is 7mm from center of Needle plate to edge of left side.
17	17076	2	Set screw for \approx 17073 & \approx 17074	
18	17068	1	Feed regulating swing arm	
19	17072	1	Hinge screw for \approx 17068	
20	17067	1	Slide block	
21	17065	1	Feed fork	
22	17066	1	Set screw for \approx 17065	
23	17069	1	Feed swing arm base	
24	21104	2	Set screw for \approx 17069	
25	17064	1	Screw for \approx 17062	
26	17062	1	Feed bar	
27	17063	1	Feed bar stop collar	
28	12421	2	Set screw for \approx 17063	
29	17095	2	Snap ring for \approx 17047	
30	17047	2	Feed connecting screw stud	
31	17051	1	Feed shaft bell crank	
32	4050	2	Set screw (A) for \approx 17051 & \approx 17045	
33	17046	2	Set screw (B) for \approx 17051 & \approx 17045	
34	17045	1	Feed fork connecting link	
35	17035	1	Bobbin	
36	17033	1	Rotating hook complete	
37	17034	1	Bobbin case base	
38	17036	2	Hook set screw	
39	17027	1	Hook driving shaft	
40	17030	2	Felt for \approx 17029	
41	17032	1	Hook driving shaft bushing (front)	
42	17031	1	Hook driving shaft collar	
43	7018	2	Set screw for \approx 17031	
44	17029	1	Hook driving shaft bushing (rear)	
45	10571	1	Set screw for \approx 17029	
46	17028	1	Hook driving shaft gear	
47	17022	2	Set screw for \approx 17028	

NOTE! WHEN ORDERING PARTS, PREFIX ALL NUMBERS WITH CS; EXAMPLE: CS___

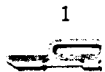
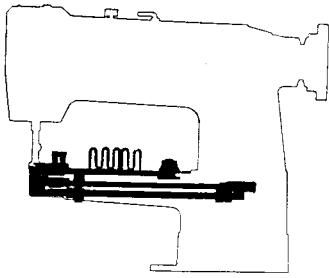

2

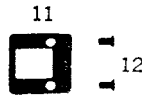

6

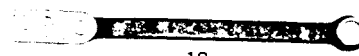
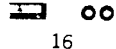

18



26

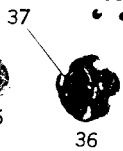

36

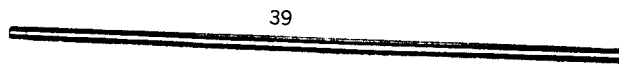

46



11

ARM TOP COVER, THREAD TENSION

Fig. No.	Parts No.	Quantity	Name
1	15035	1	Face plate
2	15036	1	Face plate hinge connection
3	15039	6	Set screw for \approx 15036
4	15037	1	Face plate spring
5	15039	2	Set screw for \approx 15037
6	15038	1	Top arm thread guide oil stop
7	15258	1	Thread take up lever cover
8	6031	1	Set screw for \approx 15258
9	15058	1	Oil intercept stud
10	15059	1	Spring for \approx 15058
11	15057	1	Dial for \approx 15058
12	8009	1	Set screw for \approx 15057
13	11006	1	Top arm thread guide
14	13076	1	Nut for \approx 11006
15	15038	1	Top arm thread guide oil stop
16	15007	7	Set screw for \approx 17003
17	17003	1	Arm top cover
18	15061	1	Oil intercept pin
19	11007	1	Oil level indicator
20	15004	1	Gasket for arm top cover
21	11012	1	Oil wick
22	15034	1	Oil regulator vinyl pipe
23	10597	1	Set screw for \approx 11004
24	11004	1	Oil regulator
25	15086	1	Oil regulator spring
26	8040	1	Set screw for \approx 15086
27	11142	1	Washer for \approx 8040
28	8100	2	Set screw for \approx 17009
29	17009	1	Bed rear cover
30	10682	1	Face plate thread guide (upper)
31	11160	1	Face plate thread guide (middle)
32	10760	1	Felt for \approx 10759
33	10759	1	Face plate thread guide (lower)
34	10685	3	Face plate thread guide set screw
35	10720	1	Tension release lever rod
36	15055	1	Tension bracket set screw
37	15062	1	Thread retainer
38	10679	2	Tension release lever hinge screw
39	10678	1	Tension release lever
40	10675	1	Tension bracket
41	10789	1	Tension stud
42	10791	1	Tension bracket pin
43	10793	1	Tension release plunger
44	10691	2	Tension disc
45	10692	1	Tension release washer
46	10693	1	Tension release spring
47	10697	3	Tension thumb nut
48	10792	1	Thread controller stud
49	10689	1	Thread controller spring
50	10694	1	Thread controller disc
51	10695	1	Set screw for \approx 10694
52	8060	1	Set screw for \approx 10792
53	10690	1	Thread controller spring stop
54	10650	1	Set screw for \approx 10690

NOTE! WHEN ORDERING PARTS, PREFIX ALL NUMBERS WITH CS; EXAMPLE: CS___

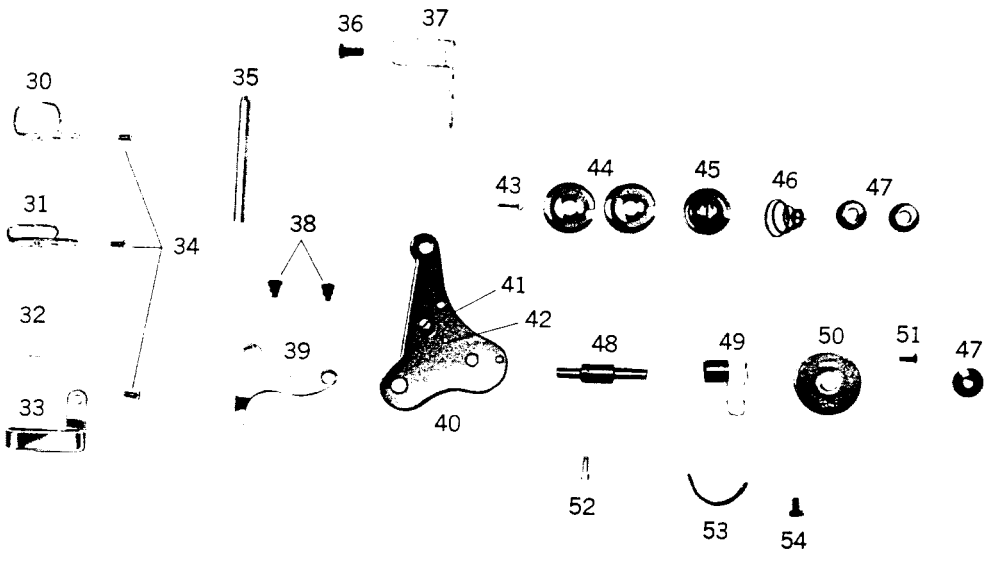
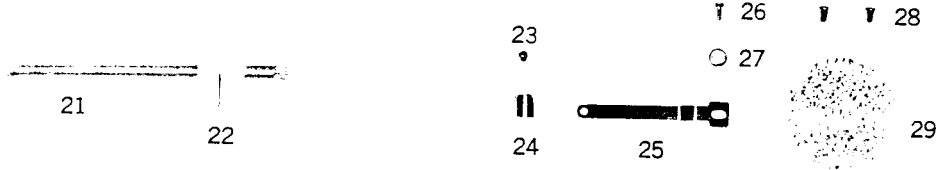
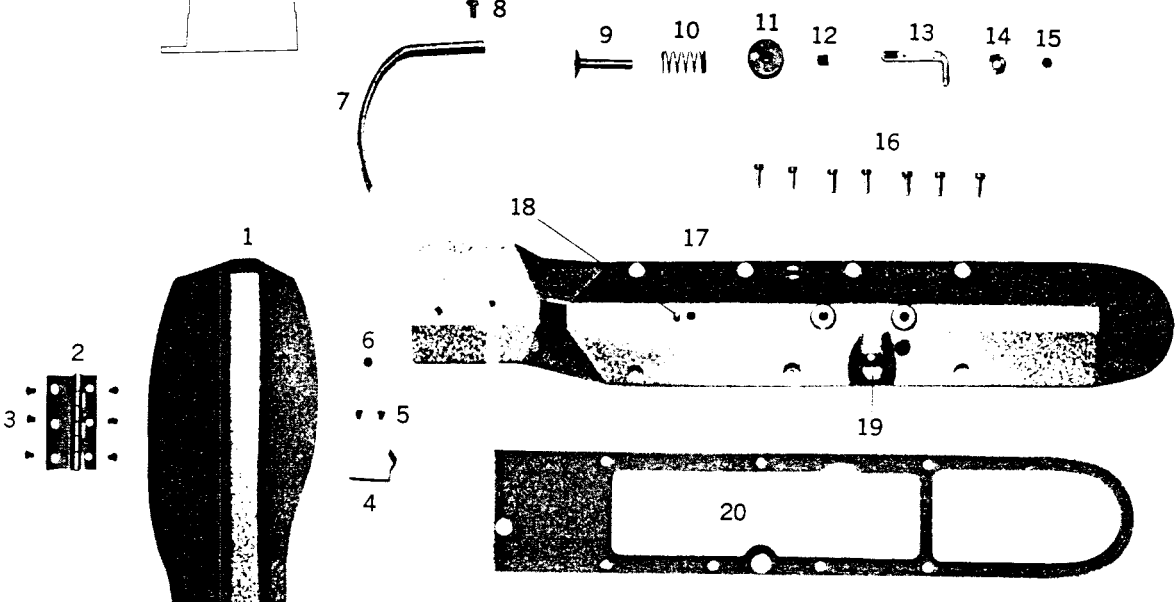
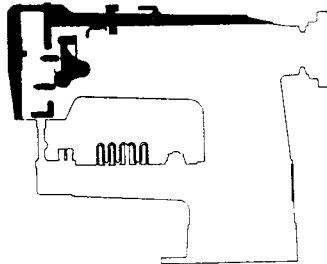

13

ACCESSORIES

Fig. No.	Parts No.	Quantity	Name	Remarks
1	8132	1	Accessories Box	
2	10734	1	Bobbin winder complete	
3	8118	1	Screw driver (large)	
4	8120	1	Screw driver (middle)	
5	8121	1	Screw driver (small)	
6	17035	6	Bobbin	
7	6332	3	Needle DPx17 # 16	
8	10748	1	Wrench	
9	15571(4)& 11969(2.5)	1&1	Wrench (4mm) & (2.5mm)	
10	11193	1	Oil can	
11	10780	1	Thread stand	
12	17081	1	Knee lifter complete	
13	8125	1	Oil bottle	
14	8124	1	Vinyl cover (large)	
15	13096	4	Machine base set screw complete	

NOTE! WHEN ORDERING PARTS, PREFIX ALL NUMBERS WITH CS; EXAMPLE: CS___

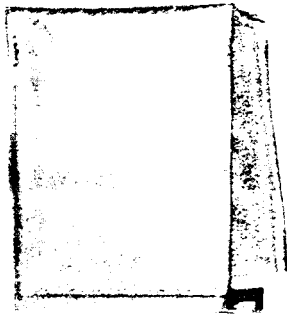
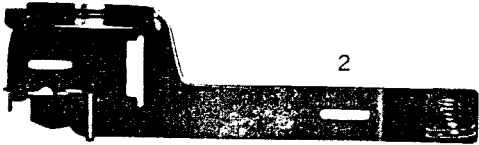
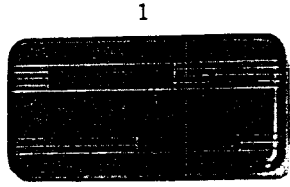

14

11

13

15

12

10

2

1

3

4

5

9

8

6

7

1

2

3

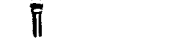
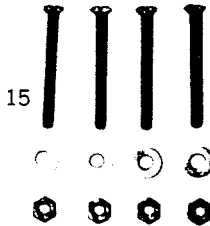
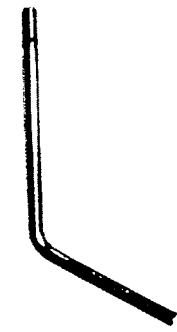
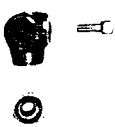
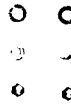

15

ACCESSORIES

Fig. No.	Parts No.	Quantity	Name
16	13260	1	Tape stand
17	13261	1	Tape stand collar
18	11830	1	Set screw for #13261
19	13263	1	Tape stand bar
20	13264	1	Nut for #13263
21	13004	1	Hinge for bed
22	13005	6	Hinge set screw
23	17002	1	Machine base
24	13006	1	Bed clamp
25	10712	1	Set screw for #13006
26	13008	1	Bed clamp thumb screw washer
27	13007	1	Bed clamp thumb screw
28	17082	1	Chain

NOTE! WHEN ORDERING PARTS, PREFIX ALL NUMBERS WITH CS; EXAMPLE: CS____

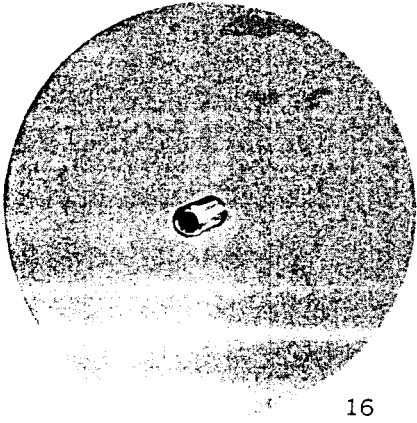

16

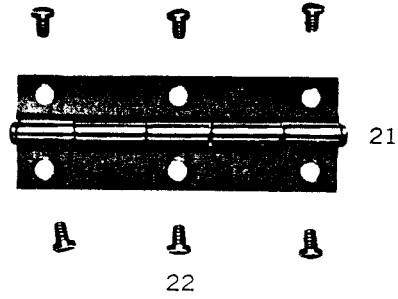

21

22

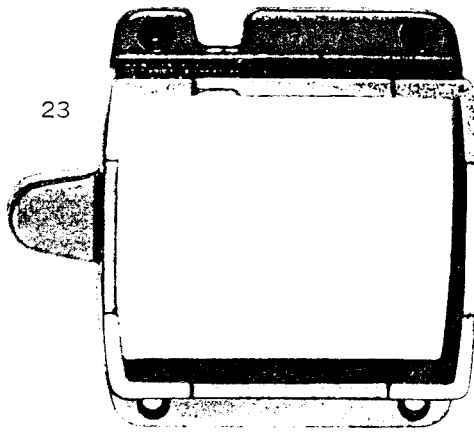

23

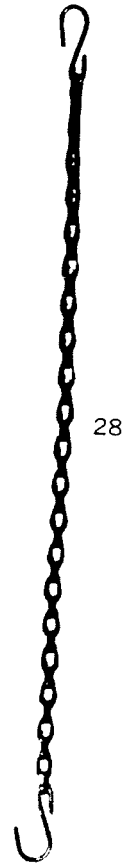

28



17

18

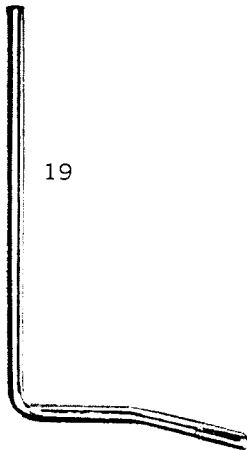

19



20



24



26



25



27

17

HOOK

Fig. No.	Parts No.	Quantity	Name
1	17033-1	1	Rotating hook only
2	17033-2	1	Thread releasing protecting spring
3	17033-3	3	Set screw for #17033-2
4	17033-4	1	Bobbin case base
5	17033-5	1	Hook gib
6	17033-3	3	Set screw for #17033-5
7	17034-1	1	Bobbin case
8	17034-2	1	Bobbin case tension spring
9	17034-3	1	Set screw for #17034-2
10	17034-4	1	Bobbin case pulling plate
11	17034-5	1	Bobbin set plate
12	17034-6	1	Bobbin set plate pin
13	17034-7	1	Bobbin set plate spring
14	17034-8	1	Set screw for #17034-4
15	17036	2	Hook set screw
16	17034-9	1	Regulating screw for #17034-2

NOTE! WHEN ORDERING PARTS, PREFIX ALL NUMBERS WITH CS; EXAMPLE: CS_____

