

FORM 8901
MARCH, 1923

LIST
OF
PARTS



MACHINES
Nos. 43-1 to 43-6

THE SINGER MANUFACTURING COMPANY

COPYRIGHT, U. S. A.,
1918, 1920, 1922 AND 1923,
BY
THE SINGER MANUFACTURING COMPANY
ALL RIGHTS RESERVED FOR ALL COUNTRIES

INDEX

	PAGE
ACCESSORIES.....	39
BINDER.....	38
BOBBIN WINDERS.....	39
IRON BASE.....	39
KNEE LIFTER PARTS.....	43
MACHINE No. 43-1.....	7
" " 43-2.....	13
" " 43-3.....	18
" " 43-4.....	23
" " 43-5.....	28
" " 43-6.....	33
NUMERICAL LIST OF PARTS.....	47
OBSOLETE PARTS.....	46
STAND.....	45

INSTRUCTIONS FOR ORDERING

In ordering from this list, use **ONLY** the **PART** number in the **FIRST** column.

The number stamped on a Sewing Machine part is in every case the number of the single part only.

Every combination of parts sent out as such has its specific number, which, although not stamped on the parts, must be used when ordering the combination.

Each number always indicates the **SAME PART** in whatever list it appears, or for whatever machine.

The letters after some of the numbers indicate the style of finish only, as follows:

- A. Hardened, Polished and Plated.
- B. Polished and Plated.
- C. Hardened only.
- D. Polished only.
- E. Soft, not Polished.
- F. Hardened and Polished.
- G.
- H. Blued.
- J. Plated only.
- K. Hardened and Plated.
- L. Brass or Gilt
- M. Oxidized.
- P. Japanned.
- R. Parkerized.

These letters **MUST BE USED** when they appear in the list, and **AFTER** the number as in the list.

In this series

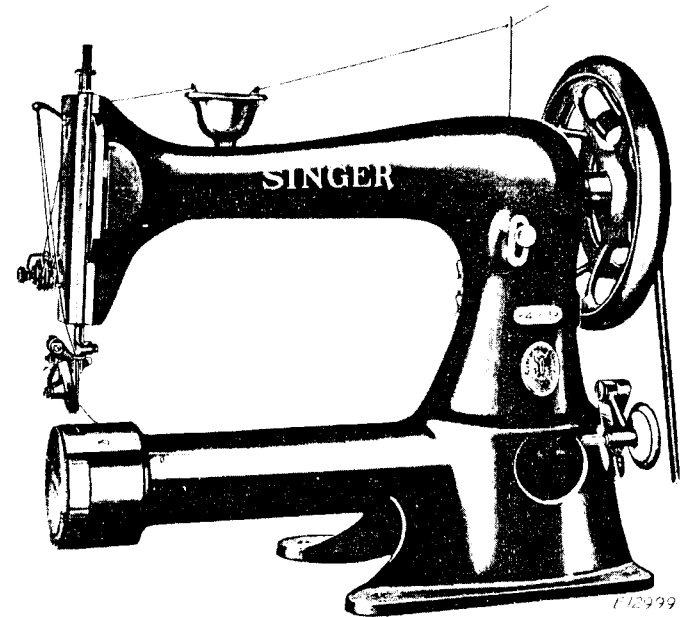
- 1 to 1500 and 50001 to 51500 are Screw Numbers.
- 1501 to 1800 are Nut Numbers.
- 1801 to 2000 are Roller Numbers.
- 2001 to 50000 and 52001 and upward are numbers of Machine Parts.

The figures in the second column refer only to the plates illustrating the parts, and are **NOT TO BE USED** in ordering.

Parts marked with an asterisk (*) are furnished only when repairs are made at factory.

LIST OF PARTS COMPLETE

FOR



MACHINE No. 43-1

FOR LEATHER. C. B., CAM ON NEEDLE BAR. DROP FEED AT LEFT OF NEEDLE. ROLLER PRESSER

NO.	PLATE	NAME
*13044	—	Arm with 4448 and 4449.....
2002	686	" Dowel Pin.....
4448	695	" Oil Tube for intermediate bearing...
123E	691	" Screw.....
6109	696	" Shaft for 3011.....
6107	696	" " " 5977.....
3005	678	" " Bushing (back).....
448C	691	" " " " Set Screw....
*4449	—	" " " (front).....
144b	691	" " Screw.....

NO.	PLATE	NAME
4288	678	Arm Side Cover.....
286D	692	" " " Thumb Screw.....
5811	695	" Spool Pin and Thread Eyelet.....
8879	7801	" " " Washer (cloth).....
3011	696	Balance Wheel (two speed) 3 in. and 5 in. pulleys, with two 448c.....
5977	696	Balance Wheel (two speed) for 5981.....
448c	691	" " " Set Screw.....
13045	718	Cloth Plate.....
13046	718	" " Bracket with 1107c.....
1107c	724	" " " Set Screw.....
13047	718	" " Slide.....
3286	723	" " " Spring.....
240D	691	" " " " Screw.....
13048	—	Cloth Plate complete, Nos. 3286, 13045, 13047 and two 240D.....
13049	—	Cloth Plate with Bracket complete, Nos. 13046, 13048 and two 389F.....
389F	724	Cloth Plate Screw.....
13002	717	Crank Connecting Rod with 4349 and two 158E.....
*4349	—	Crank Connecting Rod Cap.....
158E	691	" " " " Screw.....
566c	692	" " " Hinge Screw.....
1513J	693	" " " " " Nut
*13001	—	Cylinder, 3¼ in. diam.....
5978	696	Driving Flange with two 435c.....
5979	3632	" " Latch.....
136F	691	" " " Hinge Screw.....
5980	3632	" " " Spring.....
330D	692	" " " " Screw.....
435c	691	" " " Set Screw.....
5993	—	Driving Flange complete, Nos. 136F, 330D and 5978 to 5980.....
5808	696	Face Plate.....
8177	—	" " 5808 with 2105.....
8180	—	Face Plate complete, Nos. 448c, 2107, 2127, 5797, 5989, 5991, 8177 and two 233D.....
164D	691	Face Plate Screw.....
2107	686	" " Thread Guard.....
233D	691	" " " " Screw.....
13018	715	Feed Cam with 446c.....
446c	691	" " " Set Screw.....
3033	3632	" Connecting Link.....
375c	692	" " " Hinge Screw.....
1518E	693	" " " " " Nut

NO.	PLATE	NAME
13004	716	Feed Dog, 12 teeth.....
13005	715	" " Carrier.....
805c	691	" " " Screw.....
13006	717	" Forked Connection.....
375c	692	" " " Hinge Screw.....
1518E	693	" " " " " Nut
3039	3632	" Regulator.....
1128E	3632	" " Hinge Screw.....
818D	692	" " Thumb Screw.....
13007	717	" Rock Shaft.....
13008	715	" " " Crank.....
156c	691	" " " " Position Screw.....
190D	691	" " " " Set Screw.....
5981	—	Loose Wheel Attachment complete, Nos. 5977 and 5993.....
5465	678	Needle Bar.....
5457	681	" " Cam with two 175E.....
175E	691	" " " Clamping Screw.....
5458	681	" " " Guide.....
647c	724	" " " " Screw.....
1860	693	" " " Roller and Stud.....
453c	692	" " " " " Set Screw
290E	692	" " Screw Bushing.....
4803	686	Needle Clamp complete, Nos. 651D, 808F and 4802.....
808F	691	Needle Clamp Screw.....
4802	686	" " Thread Guide.....
651D	692	" " " " Screw.....
6436	727	Oil Cup with 1111E and three 6437.....
1111E	724	" " Screw Stud.....
6437	723	" " Thread Eyelet.....
*13009	715	Oscillating Rock Shaft with 11165.....
13062	—	" " " 13009 with 56812
3052	678	" " " Hinge Pin.....
56812	—	" " " " " 3 0 5 2 with 1513J.....
1513J	693	Oscillating Rock Shaft Hinge Pin Nut...
11165	695	" " " Oil Pad.....
13022	717	" Shaft.....
5966	—	" " Crank.....
5967	681	Oscillating Shaft Crank complete, Nos. 453c, 1513J, 1885 and 5966.....
2049	686	Oscillating Shaft Crank Pin.....
1885	693	" " " Roller with 190D, 1054c and 5968.....
190D	691	Oscillating Shaft Crank Roller Cap Screw

NO.	PLATE	NAME
5968	686	Oscillating Shaft Crank Roller Cap Screw Washer
1054c	3632	Oscillating Shaft Crank Roller Screw Stud
1513j	693	" " " " " "
		Nut
453c	692	Oscillating Shaft Crank Set Screw
3054	678	Presser Bar
5990	681	" " Lifter
689c	691	" " " Screw
1520E	693	" " " Nut
5827	727	" " Lifting Bracket with two 453c
453c	692	" " " " Set Screw
290E	692	" " Screw Bushing
6466	678	" " Spring
2070	686	" " Washer
5971	728	" Foot (long shank)
190D	691	" " Screw
262j	692	Pressure Regulating Thumb Screw
1875	723	Roller, 1½ in. diam., with 634D and 1528J
8152	723	" Arm
440F	691	" " Adjusting Screw
1547j	693	" " " " Nut
2206	723	" " Bracket
2205	695	" " Lock Spring
176D	691	" " " " Screw
1549j	693	" " " " " Nut
316F	692	" " Screw Centre
1547j	693	" " " " Nut
634D	692	" Screw
1528j	693	" Nut
5964	—	Roller Presser complete, 1½ in. roller, Nos. 176D, 440F, 1549j, 1875, 2205, 2206, 8152, two 316F and three 1547j
190D	691	Roller Presser Screw
5810	684	Shuttle Bobbin
5786	684	" " Case Latch
5787	684	" " " " Lever
5788	684	" " " " " Fulerum Pin
5838	684	Shuttle Bobbin Case Latch Spring
592E	692	" " " " Stop Screw
5785	—	" " " " Hinge, Nos. 5786 to 5788
5789	684	Shuttle Bobbin Case Position Finger
5933	684	" " " " " Rivet
5784	684	Shuttle Bobbin Case complete, Nos. 591F, 592E, 5785, 5789, 5838, 5933 and 5935

NO.	PLATE	NAME
5934	684	Shuttle Body
591F	692	" Tension Regulating Screw
5935	684	" " Spring
5783	—	Shuttle, 2½ in. diam., Nos. 5784, 5810 and 5934
13038	715	Shuttle Driver and Feed Lifting Cam
2022	723	" " " " " " Pin
13012	715	" Race Ring
13013	715	" " " Cap
13015	721	" " " " Latch
240D	691	" " " " " Screw
13014	—	Shuttle Race Ring Cap complete, Nos. 13013, 13015 and two 240D
102D	724	Shuttle Race Ring Cap Screw
145D	691	" " " Screw
1560c	693	Tension Regulating Thumb Nut
817c	693	" Screw Stud
8183	—	" " " 817c with 1560c
448c	691	" " " Set Screw
2103	685	" Spring
2105	686	" Thread Guard
5983	686	" Washer (felt)
5984	686	" " (steel)
5795	686	" Wheel with 5796
*5796	—	" " Flange
5797	—	Tension complete (wheel) Nos. 2103, 5795, 8183 and two each 5983 and 5984
12296	686	Thread Eyelet (side of arm)
2455	685	" Retaining Disc
1562j	693	" " Regulating Thumb Nut
418E	693	" " Screw Stud
10141	685	" " Spring
5989	—	Thread Retainer complete, Nos. 418E, 1562j, 10141 and two 2455
5952	678	Thread Take-up Cam with 446c and 453c
3012	3636	" " " Pin
446c	691	" " " Set Screw
*5954	678	" " Lever with 1819
8161	—	" " " 5954 with 1088c
1088c	3636	" " " Hinge Screw
1819	693	" " " Roller and Stud
5991	686	" " Spring
2127	686	" " " Regulator Plate
233D	691	" " " " " Adjusting Screw

NO.	PLATE	NAME
13016	716	Throat Plate for 13004.....
742F	692	" " Screw.....
6053	3543	Drip Pan.....

SPECIAL PARTS FOR CAP WORK

13093	729	Guide.....
13094	729	Shuttle Race Cap.....
13095	—	Shuttle Race Cap complete, Nos. 13015, 13094 and two 240D.....
13096	729	Throat Plate for 13004.....
13097	729	" " Extension, for attaching visors to uniform caps.....

LIST OF PARTS COMPLETE

FOR

MACHINE No. 43-2FOR CLOTH. LINK NEEDLE BAR CONNECTION,
DROP FEED, BOTH SIDES OF NEEDLE

NO.	PLATE	NAME
*13019	—	Arm with 4448 and 4449.....
2002	686	" Dowel Pin.....
4448	695	" Oil Tube for intermediate bearing ..
123E	691	" Screw.....
6109	696	" Shaft for 3011.....
6107	696	" " " 5977.....
3005	678	" " Bushing (back).....
448c	691	" " " " Set Screw.....
*4449	—	" " " (front).....
144D	691	" " Screw.....
4288	678	" Side Cover.....
286D	692	" " " Thumb Screw.....
5811	695	" Spool Pin and Thread Eyelet.....
8879	7801	" " " Washer (cloth).....
3011	696	Balance Wheel (two speed) 3 in. and 5 in. pulleys, with two 448c.....
5977	696	Balance Wheel (two speed) for 5981.....
448c	691	" " " Set Screw.....
13045	718	Cloth Plate.....
13046	718	" " Bracket with 1107c.....
1107c	724	" " " Set Screw.....
13047	718	" " Slide.....
3286	723	" " " Spring.....
240D	691	" " " " Screw.....
13048	—	Cloth Plate complete, Nos. 3286, 13045, 13047 and two 240D.....
13049	—	Cloth Plate with Bracket complete, Nos. 13046, 13048 and two 389F.....
389F	724	Cloth Plate Screw.....
13002	717	Crank Connecting Rod with 4349 and two 158E.....
*4349	—	Crank Connecting Rod Cap.....
158E	691	" " " " Screw.....
566c	692	" " " Hinge Screw.....
1513J	693	" " " " " Nut

NO.	PLATE	NAME
*13001	—	Cylinder, 3¼ in. diam.....
5978	696	Driving Flange with two 435c.....
5979	3632	“ “ Latch.....
136F	691	“ “ “ Hinge Screw.....
5980	3632	“ “ “ Spring.....
330D	692	“ “ “ “ Screw.....
435c	691	“ “ “ Set Screw.....
5993	—	Driving Flange complete, Nos. 136F, 330D and 5978 to 5980.....
5982	696	Face Plate.....
8173	—	“ “ 5982 with 2105.....
8179	—	Face Plate complete, Nos. 448c, 2107, 2127, 5797, 5989, 5991, 8173 and two 233D.....
164D	691	Face Plate Screw.....
2107	686	“ “ Thread Guard.....
233D	691	“ “ “ “ Screw.....
3032	678	Feed Cam with 446c.....
446c	691	“ “ Set Screw.....
3033	3632	“ Connecting Link.....
375c	692	“ “ “ Hinge Screw.....
1518E	693	“ “ “ “ “ Nut.....
13028	716	“ Dog, two rows of teeth.....
13056	726	“ “
13005	715	“ “ Carrier.....
805c	691	“ “ Screw.....
13006	717	“ Forked Connection.....
375c	692	“ “ “ Hinge Screw.....
1518E	693	“ “ “ “ “ Nut.....
3039	3632	“ Regulator.....
1128E	3632	“ “ Hinge Screw.....
818D	692	“ “ Thumb Screw.....
13007	717	“ Rock Shaft.....
13008	715	“ “ “ Crank.....
156c	691	“ “ “ “ Position Screw.....
190D	691	“ “ “ “ Set Screw.....
5981	—	Loose Wheel Attachment complete, Nos. 5977 and 5993.....
5465	678	Needle Bar.....
*3045	681	“ “ Connecting Link.....
56773	—	“ “ “ “ 3045 with 2052.....
377c	692	Needle Bar Connecting Link Hinge Screw.....
1518E	693	“ “ “ “ “ “ Nut.....
2052	723	Needle Bar Connecting Stud with 155c.....
155c	691	“ “ “ “ Set Screw.....

NO.	PLATE	NAME
290E	692	Needle Bar Screw Bushing.....
4803	686	Needle Clamp complete, Nos. 651D, 808F and 4802.....
808F	691	Needle Clamp Screw.....
4802	686	“ “ Thread Guide.....
651D	692	“ “ “ “ Screw.....
6436	727	Oil Cup with 1111E and three 6437.....
1111E	724	“ “ Screw Stud.....
6437	723	“ “ Thread Eyelet.....
*13009	715	Oscillating Rock Shaft with 11165.....
13062	—	“ “ “ 13009 with 56812..
3052	678	“ “ “ Hinge Pin.....
56812	—	“ “ “ “ “ 3052 with 1513J.....
1513J	693	Oscillating Rock Shaft Hinge Pin Nut.....
11165	695	“ “ “ Oil Pad.....
13022	717	“ Shaft.....
5966	—	“ “ Crank.....
5967	681	Oscillating Shaft Crank complete, Nos. 453c, 1513J, 1885 and 5966.....
2049	3632	Oscillating Shaft Crank Pin.....
1885	693	“ “ “ Roller with 190D, 1054c and 5968.....
190D	691	Oscillating Shaft Crank Roller Cap Screw.....
5968	3632	“ “ “ “ “ “ Washer.....
1054c	3632	Oscillating Shaft Crank Roller Screw Stud.....
1513J	693	“ “ “ “ “ “ Nut.....
453c	692	Oscillating Shaft Crank Set Screw.....
3054	678	Presser Bar.....
5990	681	“ “ Lifter.....
689c	691	“ “ “ Screw.....
1520E	693	“ “ “ “ Nut.....
5608	727	“ “ Lifting Bracket with 453c.....
453c	692	“ “ “ “ Set Screw.....
290E	692	“ “ Screw Bushing.....
3056	678	“ “ Spring.....
2070	686	“ “ “ Washer.....
5922	—	“ Foot Bracket.....
5924	—	“ “ Plate.....
5923	686	“ “ “ Hinge Pin.....
5921	728	Presser Foot (hinged) complete, Nos. 5922 to 5924.....
13029	716	Presser Foot (solid) short shank.....
190D	691	“ “ Screw.....
262J	692	Pressure Regulating Thumb Screw.....

LIST OF PARTS COMPLETE

FOR

MACHINE No. 43-3

FOR LEATHER. LONG BEAK CYLINDER SHUTTLE, DROP FEED
BOTH SIDES OF NEEDLE, VIBRATING PRESSER.

NO.	PLATE	NAME
*13039	—	Arm with 4448 and 4449
2002	686	" Dowel Pin
4448	695	" Oil Tube for intermediate bearing...
123E	691	" Screw
6109	696	" Shaft for 3011
6107	696	" " " 5977
3005	678	" " Bushing (back)
448c	691	" " " " Set Screw
*4449	—	" " " (front)
144d	691	" " Screw
4288	678	" Side Cover
286d	692	" " " Thumb Screw
5811	695	" Spool Pin and Thread Eyelet
8879	7801	" " " Washer (cloth)
3011	696	Balance Wheel (two speed) 3 in. and 5 in. pulleys, with two 448c
5977	696	Balance Wheel (two speed) for 5981
448c	691	" " Set Screw
13045	718	Cloth Plate
13052	718	" " Bracket with 1107c
1107c	724	" " " Set Screw
13047	718	" " Slide
3286	723	" " " Spring
240d	691	" " " " Screw
13048	—	Cloth Plate complete, Nos. 3286, 13045, 13047 and two 240d
13053	—	Cloth Plate with Bracket complete, Nos. 13048, 13052 and two 389F
389F	724	Cloth Plate Screw
13002	717	Crank Connecting Rod with 4349 and two 158E
*4349	—	Crank Connecting Rod Cap
158E	691	" " " " Screw
566c	692	" " " Hinge Screw
1513j	693	" " " " " Nut

NO.	PLATE	NAME
*13020	—	Cylinder, 3¼ in. diam
5978	696	Driving Flange with two 435c
5979	3632	" " Latch
136F	691	" " " Hinge Screw
5980	3632	" " " Spring
330d	692	" " " " Screw
435c	691	" " " Set Screw
5993	—	Driving Flange complete, Nos. 136F, 330d and 5978 to 5980
5820	727	Face Plate
*8181	—	" " 5820 with 2105
8182	—	Face Plate complete, Nos. 233d, 448c, 2127, 5797, 5989, 5991 and 8181
164d	691	Face Plate Screw
3032	678	Feed Cam with 446c
446c	691	" " Set Screw
3033	3632	" Connecting Link
375c	692	" " " Hinge Screw
1518E	693	" " " " " Nut
13050	726	" Dog, 12 teeth, double rows of teeth
13054	726	" " 8 teeth
13060	728	" " 12 spiked teeth
13005	715	" " Carrier
805c	691	" " Screw
13006	717	" Forked Connection
375c	692	" " " Hinge Screw
1518E	693	" " " " " Nut
3039	3632	" Regulator
1128E	3632	" " Hinge Screw
818d	692	" " Thumb Screw
13007	717	" Rock Shaft
13008	715	" " " Crank
156c	691	" " " " Position Screw
190d	691	" " " " Set Screw
5826	676	Lifting Cam
902E	3646	" " Screw
5821	727	" Lever
5878	3646	" " Adjusting Screw Head
2653	3646	" " " " " Rivet
1068d	3646	" " " Screw
5879	3646	" " " Slide
5823	676	" " " " Roller
5824	676	" " " " " Pin
5835	676	" " Hinge Bracket
5836	—	" " " " 5835 with 4810
180d	691	Lifting Lever Hinge Bracket Screw

NO.	PLATE	NAME
4810	723	Lifting Lever Hinge Stud.....
207D	691	" " " " Screw.....
3146	686	" " " " " Washer..
5825	—	Lifting Lever complete, Nos. 1068D, 2653, 5821, 5823, 5824, 5878 and 5879.....
7299	727	Lifting Presser Bar.....
5990	681	" " " " Lifter.....
689C	691	" " " " " Screw.....
1520E	693	" " " " " Nut.....
5827	727	" " " " Lifting Bracket with two 453c.....
453c	692	Lifting Presser Bar Lifting Bracket Set Screw.....
290E	692	Lifting Presser Bar Screw Bushing.....
3056	678	" " " " Spring.....
2070	686	" " " " " Washer.....
5981	—	Loose Wheel Attachment complete, Nos. 5977 and 5993.....
5465	678	Needle Bar.....
*3045	681	" " " " Connecting Link.....
56815	—	" " " " " 3045 with 3147.....
377c	692	Needle Bar Connecting Link Hinge Screw
1518E	693	" " " " " " " "
		Nut.....
3147	3646	Needle Bar Connecting Stud with 155c...
155c	691	" " " " " Set Screw...
290E	692	" " " " " Screw Bushing.....
4803	686	Needle Clamp complete, Nos. 651D, 808F and 4802.....
808F	691	Needle Clamp Screw.....
4802	686	" " " " Thread Guide.....
651D	692	" " " " " Screw.....
6436	727	Oil Cup with 1111E and three 6437.....
1111E	724	" " " " " Screw Stud.....
6437	723	" " " " " Thread Eyelet.....
*13009	715	Oscillating Rock Shaft with 11165.....
13062	—	" " " " " 13009 with 56812.
3052	678	" " " " " Hinge Pin.....
56812	—	" " " " " " 3 0 5 2 with 1513J.....
1513J	693	Oscillating Rock Shaft Hinge Pin Nut...
11165	695	" " " " " Oil Pad.....
13063	727	" " " " " Shaft.....
5999	—	" " " " " Crank.....
6000	3632	Oscillating Shaft Crank complete, Nos. 453c, 1513J, 1885 and 5999.....

NO.	PLATE	NAME
2049	3632	Oscillating Shaft Crank Pin.....
1885	693	" " " " " Roller with 190D, 1054c and 5968.....
190D	691	Oscillating Shaft Crank Roller Cap Screw
5968	3632	" " " " " " " "
		Washer.....
1054c	3632	Oscillating Shaft Crank Roller Screw Stud
1513J	693	" " " " " " " "
		Nut.....
453c	692	Oscillating Shaft Crank Set Screw.....
262J	692	Pressure Regulating Thumb Screw.....
14535	685	Shuttle Bobbin.....
8187	730	" " " " " Cylinder.....
*8194	—	" " " " " 8187 with 773F and 8188
12000	685	" " " " " Hinge Pin.....
12001	685	" " " " " Latch.....
12002	685	" " " " " Pin.....
11854	730	" " " " " Spring.....
	590D	" " " " " " Screw.....
5752	685	" " " " " Frame.....
*8162	—	" " " " " 5752 with 590D, 11854, 12001 and 12002.....
773F	692	Shuttle Tension Regulating Screw.....
8188	730	" " " " " Spring.....
8189	730	Shuttle (cylinder) 2½ in. diam., complete, Nos. 8162, 8194, 12000 and 14535....
13023	715	Shuttle Driver and Feed Lifting Eccentric
2022	723	" " " " " " " "
		Pin.....
13024	715	Shuttle Race.....
13025	717	" " " " " Cap.....
13026	—	Shuttle Race Cap complete, Nos. 13015, 13025 and two 240D.....
13015	721	Shuttle Race Cap Latch.....
240D	691	" " " " " " Screw.....
102D	724	" " " " " " Screw.....
127E	691	" " " " " " Screw.....
1560C	693	Tension Regulating Thumb Nut.....
817C	693	" " " " " " Screw Stud.....
8183	—	" " " " " 817c with 1560c.....
448C	691	" " " " " " Set Screw.....
2103	685	" " " " " Spring.....
2105	686	" " " " " Thread Guard.....
5983	686	" " " " " Washer (felt).....
5984	686	" " " " " (steel).....
5795	686	" " " " " Wheel with 5796.....
*5796	—	" " " " " " Flange.....

NO.	PLATE	NAME
5797	—	Tension complete (wheel) Nos. 2103, 5795, 8183 and two each 5983 and 5984.....
12296	686	Thread Eyelet (side of arm).....
2455	685	" Retainer Disc.....
1562J	693	" " Regulating Thumb Nut.....
418E	693	" " Screw Stud.....
10141	685	" " Spring.....
5989	—	Thread Retainer complete, Nos. 418E, 1562J, 10141 and two 2455.....
13043	720	Thread Take-up Cam with 446c, 902E and 5826.....
3012	3636	Thread Take-up Cam Pin.....
446c	691	" " " Set Screw.....
13041	720	" " Lever with 1819.....
1088c	3636	" " " Hinge Screw.....
1819	693	" " " Roller and Stud.....
5991	686	" " Spring.....
2127	686	" " " Regulator Plate.....
233D	691	" " " " " ".....
		Adjusting Screw.....
13051	726	Throat Plate for 13050, 13054 and 13060.....
742F	692	" " Screw.....
5885	3646	Vibrating Presser Bar.....
5886	—	Vibrating Presser Bar complete, Nos. 191F, 5885 and 5887.....
5887	3646	Vibrating Presser Foot.....
191F	691	" " " Screw.....
5837	676	" " Guide Bracket.....
190D	691	" " " " Screw.....
5830	676	" " Hinge Bracket with 453c.....
212D	691	Vibrating Presser Hinge Bracket Cap Screw.....
453c	692	Vibrating Presser Hinge Bracket Set Screw.....
5831	676	Vibrating Presser Spring.....
233D	691	" " " Screw.....
2269	686	" " Stop Pin.....
6053	3543	Drip Pan.....

LIST OF PARTS COMPLETE FOR MACHINE No. 43-4

FOR LEATHER. LONG BEAK CYLINDER SHUTTLE, LINK
NEEDLE BAR CONNECTION, DROP FEED AT LEFT OF
NEEDLE, ROLLER PRESSER.

NO.	PLATE	NAME
*13019	—	Arm with 4448 and 4449.....
2002	686	" Dowel Pin.....
4448	695	" Oil Tube for intermediate bearing.....
123E	691	" Screw.....
6109	696	" Shaft for 3011.....
6107	696	" " " 5977.....
3005	678	" " Bushing (back).....
448c	691	" " " " Set Screw.....
*4449	—	" " " (front).....
144D	691	" " Screw.....
4288	678	" Side Cover.....
286D	692	" " " Thumb Screw.....
5811	695	" Spool Pin and Thread Eyelet.....
8879	7801	" " " Washer (cloth).....
3011	696	Balance Wheel (two speed) 3 in. and 5 in. pulleys, with two 448c.....
5977	696	Balance Wheel (two speed) for 5981.....
448c	691	" " Set Screw.....
13045	718	Cloth Plate.....
13052	718	" " Bracket with 1107c.....
1107c	724	" " " Set Screw.....
13047	718	" " Slide.....
3286	723	" " " Spring.....
240D	691	" " " " Screw.....
13048	—	Cloth Plate complete, Nos. 3286, 13045, 13047 and two 240D.....
13053	—	Cloth Plate with Bracket complete, Nos. 13048, 13052 and two 389F.....
389F	724	Cloth Plate Screw.....
13002	717	Crank Connecting Rod with 4349 and two 158E.....
*4349	—	Crank Connecting Rod Cap.....
158E	691	" " " " Screw.....
566c	692	" " " Hinge Screw.....
1513J	693	" " " " " Nut.....

NO.	PLATE	NAME
*13020	—	Cylinder, 3¼ in. diam.
5978	696	Driving Flange with two 435c.
5979	3632	" " Latch.
136F	691	" " " Hinge Screw.
5980	3632	" " " Spring.
330D	692	" " " " Screw.
435c	691	" " " Set Screw.
5993	—	Driving Flange complete, Nos. 136F, 330D and 5978 to 5980.
5982	696	Face Plate.
8173	—	" " 5982 with 2105.
8179	—	Face Plate complete, Nos. 448c, 2107, 2127, 5797, 5989, 5991, 8173 and two 233d.
164D	691	Face Plate Screw.
2107	686	" " Thread Guard.
233D	691	" " " " Screw.
3032	678	Feed Cam with 446c.
446c	691	" " Set Screw.
3033	3632	" Connecting Link.
375c	692	" " " Hinge Screw.
1518E	693	" " " " " Nut.
13058	728	" Dog, 12 teeth.
13061	728	" " 6 teeth.
13005	715	" " Carrier.
805c	691	" " Screw.
13006	717	" Forked Connection.
375c	692	" " " Hinge Screw.
1518E	693	" " " " " Nut.
3039	3632	" Regulator.
1128E	3632	" " Hinge Screw.
818D	692	" " Thumb Screw.
13007	717	" Rock Shaft.
13008	715	" " " Crank.
156c	691	" " " " Position Screw.
190D	691	" " " " Set Screw.
5981	—	Loose Wheel Attachment complete, Nos. 5977 and 5993.
5465	678	Needle Bar.
*3045	681	" " Connecting Link.
56773	—	" " " " 3045 with 2052.
377c	692	Needle Bar Connecting Link Hinge Screw.
1518E	693	" " " " " Nut.
2052	683	Needle Bar Connecting Stud with 155c.
155c	691	" " " " Set Screw.

NO.	PLATE	NAME
290E	692	Needle Bar Screw Bushing.
4803	686	Needle Clamp complete, Nos. 651D, 808F and 4802.
808F	691	Needle Clamp Screw.
4802	686	" " Thread Guide.
651D	692	" " " " Screw.
6436	727	Oil Cup with 1111E and three 6437.
1111E	724	" " Screw Stud.
6437	723	" " Thread Eyelet.
*13009	715	Oscillating Rock Shaft with 11165.
13062	—	" " " 13009 with 56812.
3052	678	" " " Hinge Pin.
56812	—	" " " " " 3052 with 1513J.
1513J	693	Oscillating Rock Shaft Hinge Pin Nut.
11165	695	" " " Oil Pad.
13063	727	" Shaft.
5999	—	" Crank.
6000	3632	Oscillating Shaft Crank complete, Nos. 453c, 1513J, 1885 and 5999.
2049	686	Oscillating Shaft Crank Pin.
1885	693	" " " Roller with 190D, 1054c and 5968.
190D	691	Oscillating Shaft Crank Roller Cap Screw.
5968	686	" " " " " Washer.
1054c	3632	Oscillating Shaft Crank Roller Screw Stud.
1513J	693	" " " " " Nut.
453c	692	Oscillating Shaft Crank Set Screw.
3054	678	Presser Bar.
5990	681	" " Lifter.
689c	691	" " " Screw.
1520E	693	" " " " Nut.
5608	727	" " Lifting Bracket with 453c.
453c	692	" " " " Set Screw.
290E	692	" " Screw Bushing.
3056	678	" " Spring.
2070	686	" " Washer.
5971	728	" Foot (long shank).
190D	691	" " Screw.
262J	692	Pressure Regulating Thumb Screw.
1875	723	Roller, 1½ in. diam., with 634D and 1528J.
8152	723	" Arm.
440F	691	" " Adjusting Screw.
1517J	693	" " " " Nut.
2206	723	" " Bracket.

LIST OF PARTS COMPLETE

FOR

MACHINE No. 43-5

FOR CLOTH OR LEATHER. LONG BEAK CYLINDER SHUTTLE.
DROP FEED AT LEFT OF NEEDLE, ALTERNATING
PRESSERS.

NO.	PLATE	NAME
*13055	—	Arm with 4448 and 4449.....
2002	3636	" Dowel Pin.....
4448	695	" Oil Tube for intermediate bearing ..
123E	691	" Screw.....
6178	3543	" Shaft for 3011.....
6179	3543	" " " 5977.....
3005	678	" " Bushing (back).....
448c	691	" " " " Set Screw.....
*4449	—	" " " (front).....
144b	691	" " Screw.....
4288	678	" Side Cover.....
286D	692	" " " Thumb Screw.....
5811	695	" Spool Pin and Thread Eyelet.....
8879	7801	" " " Washer (cloth).....
3011	696	Balance Wheel (two speed) 3 in. and 5 in. pulleys, with two 448c.....
5977	696	Balance Wheel (two speed) for 5981.....
448c	691	" " " Set Screw.....
13045	718	Cloth Plate.....
13052	718	" " Bracket with 1107c.....
1107c	724	" " " Set Screw.....
13047	718	" " Slide.....
3286	723	" " " Spring.....
240b	691	" " " " Screw.....
13048	—	Cloth Plate complete, Nos. 3286, 13045, 13047 and two 240b.....
13053	—	Cloth Plate with Bracket complete, Nos. 13048, 13052 and two 389F.....
389F	724	Cloth Plate Screw.....
13002	717	Crank Connecting Rod with 4349 and two 158E.....
*4349	—	Crank Connecting Rod Cap.....
158E	691	" " " " Screw.....
566c	692	" " " " Hinge Screw.....
1513j	693	" " " " " Nut.....

NO.	PLATE	NAME
*13020	—	Cylinder, 3¼ in. diam.....
5978	696	Driving Flange with two 435c.....
5979	3632	" " Latch.....
136F	691	" " " Hinge Screw.....
5980	3632	" " " Spring.....
330D	692	" " " " Screw.....
435c	691	" " " Set Screw.....
5993	—	Driving Flange complete, Nos. 136F, 330D and 5978 to 5980.....
5791	696	Face Plate.....
8174	—	" " 5791 with 2105.....
8178	—	Face Plate complete, Nos. 233D, 448c, 2108, 2127, 5797, 5989, 5991 and 8174
175D	691	Face Plate Screw.....
2108	3636	" " Thread Guard.....
3032	678	Feed Cam with 446c.....
446c	691	" " Set Screw.....
3033	3632	" Connecting Link.....
375c	692	" " " Hinge Screw.....
1518E	693	" " " " " Nut.....
13050	726	" Dog, 12 teeth, double rows of teeth
13054	726	" " 8 teeth.....
13060	728	" " 12 spiked teeth.....
13005	715	" " Carrier.....
805c	691	" " Screw.....
13006	717	" Forked Connection.....
375c	692	" " " Hinge Screw.....
1518E	693	" " " " " Nut.....
3039	3632	" Regulator.....
1128E	3632	" " Hinge Screw.....
818D	692	" " Thumb Screw.....
13007	717	" Rock Shaft.....
13008	715	" " Crank.....
156c	691	" " " " Position Screw.....
190D	691	" " " " Set Screw.....
3126	3633	Guide Bar.....
56752	—	" " 3126 with 2361 and two 2362
56844	—	" " 56752 with 337D and 3137...
16781	—	Guide Bar complete, Nos. 810D, 810E, 4723, 4897, 16780, 56844 and three 404D
4854	3633	Guide Bar Driving Crank with 1862 and 3131.....
1862	3633	Guide Bar Driving Crank Roller.....
3131	3633	" " " " " Cap.....
3094	3633	" " " " Wedge.....
690E	691	" " " " " Screw.....
4723	3633	" " Lifting Bracket.....

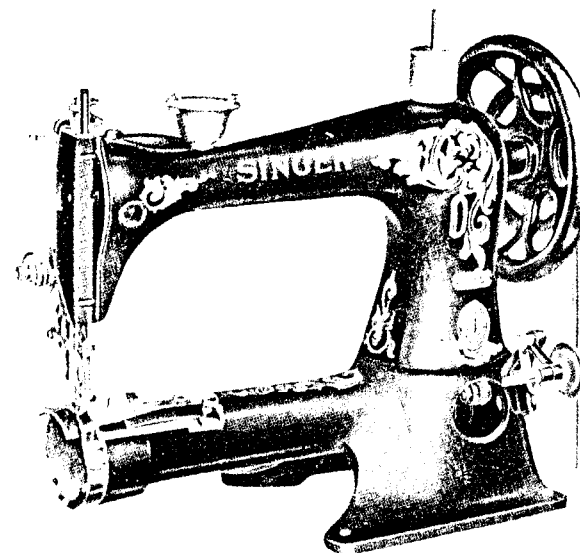
NO.	PLATE	NAME
404D	692	Guide Bar Lifting Bracket Screw.....
2058	727	Lifting Presser Bar.....
3133	3632	" " " Bracket with 641E and 1823.....
641E	691	Lifting Presser Bar Bracket Clamping Screw.....
1823	693	Lifting Presser Bar Bracket Roller and Stud.....
4855	723	Lifting Presser Bar Lifter.....
598C	691	" " " " Screw.....
4725	695	" " " Lifting Bracket.....
4726	695	" " " " " Guide Pin.....
3100	727	Lifting Presser Bar Spring.....
2070	686	" " " " Washer.....
5816	728	" " Foot.....
193D	691	" " " Screw.....
5981	—	Loose Wheel Attachment complete, Nos. 5977 and 5993.....
4264	727	Needle Bar.....
*4898	3633	" " Connecting Link with 390E...
56764	—	" " " " 4898 with 15472.....
390E	692	Needle Bar Connecting Link Adjusting Screw.....
15472	3633	Needle Bar Connecting Stud with 155c...
155C	691	" " " " Set Screw...
4265	686	" Clamp with 196F.....
4865	3632	Needle Clamp complete, Nos. 651D, 4265 and 4266.....
4266	3632	Needle Clamp Thread Guide.....
651D	692	" " " " Screw.....
196F	3632	" " " Screw.....
6436	727	Oil Cup with 1111E and three 6437.....
1111E	724	" " Screw Stud.....
6437	723	" " Thread Eyelet.....
*13009	715	Oscillating Rock Shaft with 11165.....
13062	—	" " " 13009 with 56812..
3052	678	" " " Hinge Pin.....
56812	—	" " " " " 3 0 5 2 with 1513J.....
1513J	693	Oscillating Rock Shaft Hinge Pin Nut...
11165	695	" " " Oil Pad.....
13063	727	" Shaft.....
5999	—	" " Crank.....
6000	3632	Oscillating Shaft Crank complete, Nos. 453c, 1513J, 1885 and 5999.....

NO.	PLATE	NAME
2049	3632	Oscillating Shaft Crank Pin.....
1885	693	" " " Roller with 190D, 1054c and 5968.....
190D	691	Oscillating Shaft Crank Roller Cap Screw
5968	3632	" " " " " " " Washer.....
1054c	3632	Oscillating Shaft Crank Roller Screw Stud
1513J	693	" " " " " " " Nut.....
453c	692	Oscillating Shaft Crank Set Screw.....
262J	692	Pressure Regulating Thumb Screw.....
14535	685	Shuttle Bobbin.....
8187	730	" Cylinder.....
*8191	—	" " 8187 with 773F and 8188
12000	685	" " Hinge Pin.....
12001	685	" " Latch.....
12002	685	" " " Pin.....
11854	730	" " " Spring.....
590D	692	" " " " Screw.....
5752	685	" Frame.....
*8162	—	Shuttle Frame 5752 with 590D, 11854, 12001 and 12002.....
773F	692	Shuttle Tension Regulating Screw.....
8188	730	" " Spring.....
8189	730	Shuttle (cylinder) 2½ in. diam., complete, Nos. 8162, 8194, 12000 and 14535....
13023	715	Shuttle Driver and Feed Lifting Eccentric
2022	723	" " " " " " " Pin.....
13024	715	Shuttle Race.....
13025	717	" " Cap.....
13026	—	Shuttle Race Cap complete, Nos. 13015, 13025 and two 240D.....
13015	721	Shuttle Race Cap Latch.....
240D	691	" " " " Screw.....
102D	724	" " " Screw.....
127E	691	" " " Screw.....
1560C	693	Tension Regulating Thumb Nut.....
817C	693	" Screw Stud.....
8183	—	" " " 817c with 1560c....
448C	691	" " " Set Screw.....
2103	685	" Spring.....
2105	686	" Thread Guard.....
5983	686	" Washer (felt).....
5984	686	" " (steel).....
5795	686	" Wheel with 5796.....
*5796	—	" " Flange.....

NO.	PLATE	NAME
5797	—	Tension complete (wheel) Nos. 2103, 5795, 8183 and two each 5983 and 5984
12296	686	Thread Eyelet (side of arm)
2455	685	" Retainer Disc
1562r	693	" " Regulating Thumb Nut
418E	693	" " Screw Stud
10141	685	" " Spring
5989	—	Thread Retainer complete, Nos. 418E, 1562r, 10141 and two 2455
*8184	—	Thread Take-up Cam
5793	727	" " " 8184 with 446c
3012	3636	" " " Pin
446c	691	" " " Set Screw
*5758	678	" " Lever with 1819
8159	—	" " " 5758 with 1088c
1088c	3636	" " " Hinge Screw
1819	693	" " " Roller and Stud
5991	686	" " Spring
2127	686	" " Regulator Plate
233D	691	" " " " " "
		Adjusting Screw
13051	726	Throat Plate for 13050, 13054 and 13060
742F	692	" " Screw
16780	727	Vibrating Presser Bar
2361	3633	" " " Hinge Bracket
2362	3633	" " " " Rivet
810D	3633	" " " " Cap Screw
4897	3633	" " " Lifting Bell Crank
810E	3633	" " " " " "
		Hinge Cap Screw
3137	3633	Vibrating Presser Bar Spring
337D	692	" " " " Screw
5814	728	" " Foot
217F	691	" " " Screw
6053	3543	Drip Pan

LIST OF PARTS COMPLETE

FOR



MACHINE No. 43-6

FOR STITCHING THE VISORS, SWEAT BANDS, CAP BANDS AND VISOR CUSHIONS INTO THE BODIES OF CAPS. HAS GUIDES FOR VISORS, SWEAT BAND AND CAP BAND AND FOLDER FOR THE VISOR CUSHION. CYLINDER SHUTTLE, UPPER FEED.

NO.	PLATE	NAME
*13068	—	Arm with 159D, 180D, 4448, 4449, 4891, 4892, 6305 and four 129D
2002	686	Arm Dowel Pin
4448	695	" Oil Tube for intermediate bearing
123E	691	" Screw
6178	3543	" Shaft for 3011
3005	678	" " Bushing (back)
448C	691	" " " " Set Screw
*4449	—	" " " (front)
144D	691	" " Screw

NO.	PLATE	NAME
4743	3541	Arm Side Cover
286D	692	" " " Thumb Screw
5811	695	" Spool Pin and Thread Eyelet
8879	7801	" " " Washer (cloth)
3011	696	Balance Wheel (two speed) 3 in. and 5 in. pulleys, with two 448c
448c	691	Balance Wheel Set Screw
13002	717	Crank Connecting Rod with 4349 and two 158E
*4349	—	Crank Connecting Rod Cap
158E	691	" " " " Screw
566c	692	" " " " Hinge Screw
1513J	693	" " " " " Nut
*13069	—	Cylinder, 3¼ in. diam
13070	3541	Face Plate
13071	—	" " 13070 with 2105
13072	—	Face Plate complete, Nos. 233D, 448c, 2108, 2127, 5797, 5989, 5991 and 13071
175D	691	Face Plate Screw
2108	686	" " Thread Guard
13073	3541	Feed Bar
6306	723	" " Connecting Link
89F	723	" " " " Hinge Screw
2361	3633	" " Hinge Bracket
2362	3633	" " " " Rivet
810D	3633	" " Cap Screw
24630	730	" Cam with two 435c
435c	691	" " Set Screw
13074	3541	" Forked Connection with 453c
3093	723	" " " Pin
453c	692	" " " Set Screw
4904	3541	" Lever
*6305	—	" " Bracket with two 620c
180D	691	" " " " Screw (lower)
159D	691	" " " " " (upper)
6307	723	" " Hinge Pin
620c	723	" " " " Set Screw
13077	3542	" Point
217D	691	" " Screw
4905	3541	" Regulator with 4907 and two 237D
13075	—	Feed Regulator complete, Nos. 666F, 1014D, 4905, 4959 and 13076
2049	3632	Feed Regulator Pin
13076	723	" " Slide Block
1014D	723	" " Thumb Screw
666F	724	" " " " Lock Screw

NO.	PLATE	NAME
4959	723	Feed Regulator Thumb Screw Lock Stud (brass)
4907	723	Feed Regulator Thumb Screw Stop Bracket
237D	723	Feed Regulator Thumb Screw Stop Bracket Screw
4908	3541	Feed Shaft
*4892	—	" " Bracket (back)
129D	691	" " " " Screw
*4891	—	" " " (front)
129D	691	" " " " Screw
120167	5664	Guide, for band of caps, for stitching visors and sweat bands in caps in one operation
120168	5664	Guide, for visors, for stitching visors and sweat bands in caps in one operation
120169	5664	Guide, for visors, when cushion is fitted on visor and sweat band stitched in by hand
120170	5695	Guide
120171	5695	" Block
234D	5695	" " Screw
120172	5695	" Body
234D	5695	" " Screw
120173	5695	" Shank
120174	5695	" Tension Block
120175	5695	" " " Holder with 120174 and two 19088
19088	5695	Guide Tension Block Rivet
120176	5695	" " Spring with 17830
17830	5695	" " " Steady Pin
732D	724	" " Thumb Screw
658D	724	" Thumb Screw
7071	695	" " " Washer
120177	—	Guide (adjustable) complete, for sweat bands, for stitching visors and sweat bands in caps in one operation, Nos. 658D, 732D, 7071, 120170 to 120173, 120175, 120176 and four 234D
3126	3633	Guide Bar
13078	—	Guide Bar complete, Nos. 810D, 810E, 2361, 3126, 4723, 4897, 13073, two 2362 and three 404D
4854	3633	Guide Bar Driving Crank with 1862 and 3131
1862	3633	Guide Bar Driving Crank Roller
3131	3633	" " " " Cap
3094	3633	" " " " Wedge

NO.	PLATE	NAME
240b	691	Shuttle Race Cap Latch Screw
102d	724	" " " Screw
13089	730	" " Thread Guard
1161d	730	" " " " Screw
13090	730	" " " " Steady Pin
127E	691	" " Screw
1560c	693	Tension Regulating Thumb Nut
817c	693	" Screw Stud
8183	—	" " " 817c with 1560c
448c	691	" " " Set Screw
2103	685	" Spring
2105	686	" Thread Guard
5983	686	" Washer (felt)
5984	686	" " (steel)
5795	686	" Wheel with 5796
*5796	—	" Flange
5797	—	Tension complete (wheel) Nos. 2103, 5795, 8183 and two each 5983 and 5984
12296	686	Thread Eyelet (side of arm)
2455	685	" Retaining Disc
1562r	693	" " Regulating Thumb Nut
418E	693	" " Screw Stud
10141	685	" " Spring
5989	—	Thread Retainer complete, Nos. 418E, 1562r, 10141 and two 2455
*8184	—	Thread Take-up Cam (steel)
5793	727	" " " 8184 with 446c
3012	3636	" " " Pin
446c	691	" " " Set Screw
*5758	678	" " Lever with 1819
8159	—	" " " 5758 with 1088c
1088c	3636	" " " Hinge Screw
1819	693	" " " Roller and Stud
5991	686	" " Spring
2127	686	" " " Regulator Plate
233d	691	" " " " "
		Adjusting Screw
6053	3543	Drip Pan

BINDER

FOR 43-6 MACHINE

NO.	PLATE	NAME
120178	5664	Binder on Shank, for visor cushion
190d	691	" Screw
7071	695	" " Washer
120179	5664	" Stop Stud

IRON BASE

NO.	PLATE	NAME
13036	722	Machine Base with four each 318E, 599E and eight 6055
599E	724	Machine Base Bolt with 1524E, to secure base to table
1524E	724	Machine Base Bolt Nut
6055	730	" " " " Washer
318E	724	" Bolt with 1524E, to secure ma- chine to base
1524E	724	Machine Bolt Nut
6055	730	" " " Washer

ACCESSORIES

NO.	PLATE	NAME
599E	724	Machine Bolt with 1524E, to secure machine to table
1524E	724	Machine Bolt Nut
6055	730	" " " Washer
120342	5901	Oiler (copper plated) with 120343
120343	5901	" Spout, 3 1/2 in. long
26026	5901	Screw Driver (large)
26485	5901	" " (small)
4822	5901	Wrench for 1528, 1547 and 1549
8908	5901	" " 1520
4347	5901	" " 1513 and 1518

BOBBIN WINDER

FOR 5810

NO.	PLATE	NAME
13031	715	Bracket
145d	691	" Screw
12169	715	Frame
13034	—	Frame complete, Nos. 333d, 5960 to 5963 and 12169
32d	691	Frame Hinge Screw
5960	678	Friction Wheel (leather)
5961	678	" " Washer
333d	692	" " " Screw
5962	678	Spindle
5963	678	" Flange
12170	715	Spring
180d	691	" Screw
13033	—	Bobbin Winder complete, Nos. 32d, 180d, 12170, 13031 and 13034

BOBBIN WINDER

FOR 14535

NO.	PLATE	NAME
13031	715	Bracket.....
145D	691	" Screw.....
12169	715	Frame.....
13035	—	Frame complete, Nos. 333D, 5761, 5960, 5961, 5963 and 12169.....
32D	691	Frame Hinge Screw.....
5960	678	Friction Wheel (leather).....
5961	678	" " Washer.....
333D	692	" " " Screw.....
5761	678	Spindle.....
5963	678	" Flange.....
12170	715	Spring.....
180D	691	" Screw.....
13032	715	Bobbin Winder complete, Nos. 32D, 180D, 12170, 13031 and 13035.....

BOBBIN WINDER(SWINGING AUTOMATIC, RIGHT HAND)
FOR 5810

NO.	PLATE	NAME
27540	7800	Base.....
27302	7805	Frame.....
50356D	7801	" Hinge Screw.....
1620J	7801	" " " Nut.....
27303	7801	" Spring.....
27541	7800	Pulley.....
27333	7805	Spindle.....
27323	7805	Spool Pin.....
27324	7805	" Stand.....
27325	7805	Spool Stand complete, Nos. 418E, 1562J, 10141, 11241, 27323, 27324, 34358M and two each 2455 and wood screws 1 in. No. 10.....
11241	7800	Spool Washer (cloth).....
27334	7805	Stop Latch.....
35D	7801	" " Hinge Screw.....
2455	685	Tension Disc.....
1562J	693	" Regulating Thumb Nut.....
418E	693	" Screw Stud.....
10141	685	" Spring.....
34358	730	" Thread Guide.....

BOBBIN WINDERS

NO.	PLATE	NAME
27648	7805	Bobbin Winder, Nos. 35D, 1620J, 27302, 27303, 27333, 27334, 27540, 27541, 50356D and two wood screws 1 in. No. 7
27550	—	Bobbin Winder (swinging automatic, right hand) complete, Nos. 27325 and 27648

BOBBIN WINDER(SWINGING AUTOMATIC, RIGHT HAND)
FOR 14535

NO.	PLATE	NAME
27540	7800	Base.....
15072	7801	Bobbin Position Pin.....
27527	7800	Frame.....
50356D	7801	" Hinge Screw.....
1620J	7801	" " " Nut.....
27303	7801	" Spring.....
27541	7800	Pulley.....
27330	7800	Spindle with 15072.....
27323	7805	Spool Pin.....
27324	7805	" Stand.....
27325	7805	Spool Stand complete, Nos. 418E, 1562J, 10141, 11241, 27323, 27324, 34358M and two each 2455 and wood screws 1 in. No. 10.....
11241	7800	Spool Washer (cloth).....
27331	7800	Stop Latch.....
35D	7801	" " Hinge Screw.....
2455	685	Tension Disc.....
1562J	693	" Regulating Thumb Nut.....
418E	693	" Screw Stud.....
10141	685	" Spring.....
34358	730	" Thread Guide.....
27649	7800	Bobbin Winder, Nos. 35D, 1620J, 27303, 27330, 27331, 27527, 27540, 27541, 50356D and two wood screws 1 in. No. 7
27551	—	Bobbin Winder (swinging automatic, right hand) complete, Nos. 27325 and 27649

BOBBIN WINDER(SWINGING AUTOMATIC, RIGHT HAND)
FOR FLAT OR ROUND BELT, FOR 14535.

NO.	PLATE	NAME
41439	7804	Base with 458C, 27916 and two 28084...
41398	3583	Bobbin Carrier Key.....

BOBBIN WINDERS

NO.	PLATE	NAME
27916	3583	Brake (leather)
28084	3583	" Rivet
41440	3581	Frame
41441	3581	" Hinge Pin
458c	3583	" " " Set Screw
4784	3583	" Oil Pad
41442	3581	" Spring
41443	3581	Pulley with 155c
155c	3583	" Set Screw
41444	7804	Spindle with 41398
41445	7804	Stop Latch
41446	7804	" " Hinge Pin
2269	686	" " Pin
41447	3581	Tripping Arm with 176d
176d	3583	" " Clamping Screw
41448	7804	Bobbin Winder, Nos. 2269, 41439 to 41447, two 4784 and three wood screws 1 in. No. 7

THREAD UNWINDER PARTS

27555	3582	Spool Pin
41450	3582	" Rest
41451	—	" " 41450 with 138B and 27555
138B	3583	" " Set Screw
27557	3582	" Stand with 138B
41514	3582	" Weight, 4 in. diam., with 41515
41515	3583	" " Centre Pin
2102	3583	Tension Disc
1560c	3583	" Regulating Thumb Nut
828c	7801	" Screw Stud
2103	3583	" Spring
5769	3583	" Thread Eyelet
17547	7801	" " Guard
60608	3582	Thread Guard
27560	3582	" " Rod, 26 in. long
138B	3583	" " Set Screw
330D	3583	" " Set Screw
60609	—	Thread Guard complete, Nos. 330D, 828c, 1560c, 2103, 5769, 17547, 60608 and two 2102
41454	3582	Thread Unwinder complete, for one large spool, Nos. 27557, 27560, 41451, 41514, 60609 and three wood screws 1¼ in. No. 12
41449	—	Bobbin Winder (swinging automatic, right hand) complete, Nos. 41448 and 41454

KNEE LIFTER PARTS

FOR 43-1 TO 43-4 MACHINES

NO.	PLATE	NAME
7170	3543	Lifting Lever
802b	691	" " Hinge Screw
16659	3543	" " Spring
6703	3543	Pitman, length 14½ in.
2763	3543	Rock Shaft
6334	3543	" " Hanger with two wood screws 1 in. No. 10
16646	3543	Rock Shaft Knee Arm
16647	—	Rock Shaft Knee Arm complete, Nos. 2766, 2767 and 16646
2766	3543	Rock Shaft Knee Arm Hub with 356c
356c	693	" " " " " Set Screw
2767	3543	" " " Plate with 356c
356c	693	" " " " " Set Screw
6337	3543	" " Lifting Bracket with two 356c
6338	3543	" " " " " Hook
356c	693	" " " " " " Set Screw
356c	693	Rock Shaft Lifting Bracket Set Screw
2770	3543	" " Stop Dog with 356c
356c	693	" " " " " Set Screw
6339	3543	Rock Shaft complete, Nos. 2763, 2770, 6337, 6338, 16647 and two 6334
13037	—	Knee Lifter complete, Nos. 802b, 6339, 6703, 7170 and 16659

KNEE LIFTER PARTS

FOR 43-5 MACHINE

NO.	PLATE	NAME
16648	3543	Lifting Lever with 448c
802D	691	" " Hinge Screw
4727	695	" " Pin
448c	691	" " " Set Screw
16659	3543	" " Spring
4725	695	" Presser Bar Lifting Bracket
4726	695	" " " " " Guide Pin
6703	3543	Pitman, length 14½ in.
2763	3543	Rock Shaft
6334	3543	" " Hanger with two wood screws 1 in. No. 10

KNEE LIFTER PARTS

NO.	PLATE	NAME
16646	3543	Rock Shaft Knee Arm.....
16647	—	Rock Shaft Knee Arm complete, Nos. 2766, 2767 and 16646.....
2766	3543	Rock Shaft Knee Arm Hub with 356c....
356c	693	" " " " " Set Screw....
2767	3543	" " " " Plate with 356c.....
356c	693	" " " " Set Screw.....
6337	3543	" " " " Lifting Bracket with two 356c.....
6338	3543	" " " " Hook.....
356c	693	" " " " " " Set Screw.....
356c	693	Rock Shaft Lifting Bracket Set Screw....
2770	3543	" " " " Stop Dog with 356c.....
356c	693	" " " " Set Screw.....
6339	3543	Rock Shaft complete, Nos. 2763, 2770, 6337, 6338, 16647 and two 6334.....
13098	—	Knee Lifter complete, Nos. 802D, 4725 to 4727, 6339, 6703, 16648 and 16659

KNEE LIFTER PARTS

FOR 43-6 MACHINE

NO.	PLATE	NAME
16641	3543	Lifting Lever with 448c.....
1064D	724	" " Hinge Screw.....
4896	3541	" " Hook.....
448c	691	" " " " Set Screw.....
16659	3543	" " Spring.....
4725	695	" Presser Bar Lifting Bracket.....
4726	695	" " " " " " Guide Pin.....
6343	3543	Pitman.....
2763	3543	Rock Shaft.....
6334	3543	" " Hanger with two wood screws 1 in. No. 10.....
16646	3543	Rock Shaft Knee Arm.....
16647	—	Rock Shaft Knee Arm complete, Nos. 2766, 2767 and 16646.....
2766	3543	Rock Shaft Knee Arm Hub with 356c....
356c	693	" " " " " " Set Screw....
2767	3543	" " " " Plate with 356c.....
356c	693	" " " " Set Screw.....
6337	3543	" " " " Lifting Bracket with two 356c.....
6338	3543	" " " " Hook.....
356c	693	" " " " " " Set Screw.....

KNEE LIFTER PARTS

NO.	PLATE	NAME
356c	693	Rock Shaft Lifting Bracket Set Screw ...
2770	3543	" " " " Stop Dog with 356c.....
356c	693	" " " " " " Set Screw.....
6339	3543	Rock Shaft complete, Nos. 2763, 2770, 6337, 6338, 16647 and two 6334.....
16645	—	Knee Lifter complete, Nos. 1064D, 4725, 4726, 4896, 6339, 6343, 16641 and 16659

STAND

ROCKING TREADLE

NO.	PLATE	NAME
25133	381	Band Wheel (two speed) 10 in. and 12 in. diam., with 2117 and 25010.....
25010	381	Band Wheel Crank.....
2117	695	" " " " Pin.....
297c	692	" " " " Screw Centre.....
46629	—	" " " " " " 297cwith 1507J.....
1507J	693	Band Wheel Crank Screw Centre Nut...
25176	—	Belt, size $\frac{1}{8}$ in., length 68 in., with 25029
25029	695	" Hook.....
25368	381	Brace with three 46629.....
506E	692	" Bolt with 1510E.....
1510E	693	" " Nut.....
25065	381	Leg.....
25123	—	Pitman Adjusting Block.....
558E	693	" " " " Screw.....
1570E	693	" " " " Nut.....
25075	695	" " " " Washer.....
25074	381	Pitman (adjustable) complete, with two each 558E, 1570E, 25075 and 25123....
7958	695	Pitman Pin.....
11742	695	" Washer.....
25077	381	Table Support.....
1059E	724	" " Bolt with 1510E.....
1510E	693	" " " " Nut.....
25082	381	Treadle.....
297c	692	" Screw Centre.....
1507J	693	" " " " Nut.....
46629	—	" " " " 297c with 1507J...
25086	381	Wrench for 1507 and 1510.....
25246	—	Stand (iron work) complete, Nos. 1059E, 7958, 11742, 25074, 25077, 25082, 25086, 25133, 25368, two 25065 and four 506E

OBSOLETE PARTS

NO.	PLATE	NAME
13003	719	Face Plate for 600 and 2111, for 43-1 and 43-2 Machines
13040	725	Feed Dog (double) for 13042, for 43-3 Machine
13021	725	Feed Dog, for leather, 12 teeth, for 43-4 Machine
13010	717	Oscillating Shaft for 43-1 and 43-2 Machines
12093	685	Shuttle Cylinder
56514	—	“ “ 12093 with 773r and 12095
12095	685	Shuttle Tension Spring
5751	685	Shuttle (cylinder) 2½ in. diam., complete, Nos. 8162, 12000, 14535 and 56514, use 8189
13011	721	Shuttle Driver and Feed Cam for 43-1 and 43-2 Machines
13042	725	Throat Plate for 13040
13027	725	“ “ “ 13021

**NUMERICAL
LIST
OF PARTS**

NUMERICAL LIST OF PARTS

NO.	PLATE	NAME
32D	691	Bobbin Winder Frame Hinge Screw for 13032 and 13033.....
35D	7801	Bobbin Winder Stop Latch Hinge Screw for 27648 and 27649.....
89F	723	Feed Bar Connecting Link Hinge Screw for 43-6 Machine.....
102D	724	Shuttle Race Ring Cap Screw for 43-1 and 43-2 Machines.....
102D	724	Shuttle Race Cap Screw for 43-3 to 43-6 Machines.....
123E	691	Arm Screw.....
127E	691	Shuttle Race Screw for 43-3 to 43-6 Machines.....
129D	691	Feed Shaft Bracket (back) Screw for 13068
129D	691	“ “ “ (front) Screw for 13068
136F	691	Driving Flange Latch Hinge Screw for 5993.....
138B	3583	Thread Unwinder Spool Rest Set Screw for 41451.....
138B	3583	Thread Unwinder Thread Guard Rod Set Screw for 27557.....
144D	691	Arm Shaft Screw.....
145D	691	Bobbin Winder Bracket Screw for 13031..
145D	691	Shuttle Race Ring Screw for 43-1 and 43-2 Machines.....
155C	3583	Bobbin Winder Pulley Set Screw for 41443
155C	691	Needle Bar Connecting Stud Set Screw for 2052, 3147 and 15472.....
156C	691	Feed Rock Shaft Crank Position Screw for 43-1 to 43-5 Machines.....
158E	691	Crank Connecting Rod Cap Screw for 13002.....
159D	691	Feed Lever Bracket Screw (upper) for 13068.....
164D	691	Face Plate Screw for 43-1 to 43-4 Machines.....
175D	691	Face Plate Screw for 43-5 and 43-6 Machines.....
175E	691	Needle Bar Cam Clamping Screw for 5457.....
176D	3583	Bobbin Winder Tripping Arm Clamping Screw for 41447.....
176D	691	Roller Arm Lock Spring Screw for 5964..

NUMERICAL LIST OF PARTS

NO.	PLATE	NAME
180D	691	Bobbin Winder Spring Screw for 13032 and 13033.....
180D	691	Feed Lever Bracket Screw (lower) for 13068.....
180D	691	Lifting Lever Hinge Bracket Screw for 43-3 Machine.....
185D	724	Guide Screw for 120168 and 120169.....
190D	691	Binder Screw for 120178.....
190D	691	Feed Rock Shaft Crank Set Screw for 43-1 to 43-5 Machines.....
190D	691	Guide Screw for 120177.....
190D	691	Oscillating Shaft Crank Roller Cap Screw for 1885.....
190D	691	Presser Foot Screw for 43-1, 43-2 and 43-4 Machines.....
190D	691	Roller Presser Screw for 43-1 and 43-4 Machines.....
190D	691	Vibrating Presser Guide Bracket Screw for 43-3 Machine.....
191F	691	Vibrating Presser Foot Screw for 5886..
193D	691	Lifting Presser Foot Screw for 43-5 and 43-6 Machines.....
196F	3632	Needle Clamp Screw for 4265 and 13081
207D	691	Lifting Lever Hinge Stud Screw for 43-3 Machine.....
212D	691	Vibrating Presser Hinge Bracket Cap Screw for 43-3 Machine.....
217D	691	Feed Point Screw for 43-6 Machine.....
217F	691	Vibrating Presser Foot Screw for 43-5 Machine.....
233D	691	Face Plate Thread Guard Screw for 8179 and 8180.....
233D	691	Thread Take-up Spring Regulator Plate Adjusting Screw for 8178 to 8180, 8182 and 13072.....
233D	691	Vibrating Presser Spring Screw for 43-3 Machine.....
234D	5695	Guide Block Screw for 120177.....
234D	5695	" Body Screw for 120177.....
237D	723	Feed Regulator Thumb Screw Stop Bracket Screw for 4905.....
240D	691	Cloth Plate Slide Spring Screw for 13048
240D	691	Shuttle Race Ring Cap Latch Screw for 13014.....
240D	691	Shuttle Race Cap Latch Screw for 13026, 13088 and 13095.....
262J	692	Pressure Regulating Thumb Screw.....

NUMERICAL LIST OF PARTS

NO.	PLATE	NAME
286D	692	Arm Side Cover Thumb Screw.....
290E	692	Lifting Presser Bar Screw Bushing for 43-3 Machine.....
290E	692	Needle Bar Screw Bushing for 43-1 to 43-4 Machines.....
290E	692	Presser Bar Screw Bushing for 43-1, 43-2 and 43-4 Machines.....
297C	692	Band Wheel Crank Screw Centre for 46629
297C	692	Treadle Screw Centre for 46629.....
316F	692	Roller Arm Screw Centre for 5964...
318E	724	Machine Bolt with 1524E, to secure machine to base, for 13036.....
330D	692	Driving Flange Latch Spring Screw for 5993.....
330D	3583	Thread Unwinder Thread Guard Set Screw for 60609.....
333D	692	Bobbin Winder Friction Wheel Washer Screw for 13034 and 13035.....
335D	724	Guide Screw for 120167.....
337D	692	Vibrating Presser Bar Spring Screw for 56844.....
356C	693	Rock Shaft Knee Arm Hub Set Screw for 2766.....
356C	693	Rock Shaft Knee Plate Set Screw for 2767
356C	693	Rock Shaft Lifting Bracket Hook Set Screw for 6337.....
356C	693	Rock Shaft Lifting Bracket Set Screw for 6337.....
356C	693	Rock Shaft Stop Dog Set Screw for 2770
375C	692	Feed Connecting Link Hinge Screw for 43-1 to 43-5 Machines.....
375C	692	Feed Forked Connection Hinge Screw for 43-1 to 43-5 Machines.....
377C	692	Needle Bar Connecting Link Hinge Screw for 43-2 to 43-4 Machines.....
389F	724	Cloth Plate Screw for 13049 and 13053
390E	692	Needle Bar Connecting Link Adjusting Screw for 4898.....
401E	7801	Needle Plate Screw for 13084.....
404D	692	Guide Bar Lifting Bracket Screw for 13078 and 16781.....
418E	693	Bobbin Winder Tension Screw Stud for 27325.....
418E	693	Thread Retaining Screw Stud for 5989..
435C	691	Driving Flange Set Screw for 5978.....
435C	691	Feed Cam Set Screw for 24630.....
440F	691	Roller Arm Adjusting Screw for 5964....

NUMERICAL LIST OF PARTS

NO.	PLATE	NAME
446c	691	Feed Cam Set Screw for 3032 and 13018
446c	691	Thread Take-up Cam Set Screw for 5757, 5793, 5952, 13017 and 13043.....
448c	691	Arm Shaft Bushing (back) Set Screw....
448c	691	Balance Wheel Set Screw for 3011.....
448c	691	Lifting Lever Hook Set Screw for 10041
448c	691	" " Pin Set Screw for 10048....
448c	691	Tension Screw Stud Set Screw for 8178 to 8180, 8182 and 13072.....
453c	692	Needle Bar Cam Roller and Stud Set Screw for 5952.....
453c	692	Feed Forked Connection Set Screw for 13074.....
453c	692	Oscillating Shaft Crank Set Screw for 5967 and 6000.....
453c	692	Presser Bar Lifting Bracket Set Screw for 5608 and 5827.....
453c	692	Lifting Presser Bar Lifting Bracket Set Screw for 5827.....
453c	692	Vibrating Presser Hinge Bracket Set Screw for 5830.....
458c	3583	Bobbin Winder Frame Hinge Pin Set Screw for 41439.....
506E	692	Brace Bolt with 1510E, for 25246.....
558E	693	Pitman Adjusting Screw for 25074.....
566c	692	Crank Connecting Rod Hinge Screw....
590D	692	Shuttle Cylinder Latch Spring Screw for 8162.....
591F	692	Shuttle Tension Regulating Screw for 5784.....
592E	692	Shuttle Bobbin Case Latch Stop Screw for 5784.....
598c	691	Lifting Presser Bar Lifter Screw for 43-5 and 43-6 Machines.....
599E	724	Machine Base Bolt with 1524E, to secure base to table, for 13036.....
599E	724	Machine Bolt with 1524E, to secure machine to table (Accessories).....
620c	723	Feed Lever Hinge Pin Set Screw for 6305
634D	692	Roller Screw for 1875.....
641E	691	Lifting Presser Bar Bracket Clamping Screw for 3133.....
647c	724	Needle Bar Cam Guide Screw for 43-1 Machine.....
651D	692	Needle Clamp Thread Guide Screw for 4803 and 4865.....
658D	724	Guide Thumb Screw for 120177.....

NUMERICAL LIST OF PARTS

NO.	PLATE	NAME
666F	724	Feed Regulator Thumb Screw Lock Screw for 13075.....
689c	691	Presser Bar Lifter Screw for 43-1, 43-2 and 43-4 Machines.....
6S9c	691	Lifting Presser Bar Lifter Screw for 43-3 Machine.....
690E	691	Guide Bar Driving Crank Wedge Screw for 43-5 and 43-6 Machines.....
691F	724	Needle Plate Body Screw for 43-6 Machine
732D	724	Guide Tension Thumb Screw for 120177
742F	692	Throat Plate Screw for 43-1 to 43-5 Machines.....
773F	692	Shuttle Tension Regulating Screw for 8194 and 56514.....
802D	691	Lifting Lever Hinge Screw for 13037 and 13098.....
805c	691	Feed Dog Screw for 43-1 to 43-5 Machines
808F	691	Needle Clamp Screw for 4803.....
810D	3633	Feed Bar Hinge Cap Screw for 13078....
810D	3633	Vibrating Presser Bar Hinge Cap Screw for 16781.....
810E	3633	Vibrating Presser Bar Lifting Bell Crank Hinge Cap Screw for 16781.....
810E	3633	Lifting Presser Bar Lifting Bell Crank Hinge Cap Screw for 13078.....
817c	693	Tension Screw Stud for 8183.....
818D	692	Feed Regulator Thumb Screw for 43-1 to 43-5 Machines.....
828c	7801	Thread Unwinder Tension Screw Stud for 60609.....
902E	3646	Lifting Cam Screw for 13043.....
1014D	723	Feed Regulator Thumb Screw for 13075
1054c	3632	Oscillating Shaft Crank Roller Screw Stud for 1885.....
1059E	724	Table Support Bolt with 1510E, for 25246
1064D	724	Lifting Lever Hinge Screw for 16645.....
1068D	3646	" " Adjusting Screw for 5825....
108Sc	3636	Thread Take-up Lever Hinge Screw for 8159, 8161 and 43-3 Machine.....
1107c	724	Cloth Plate Bracket Set Screw for 13046 and 13052.....
1111E	724	Oil Cup Screw Stud for 6436.....
1128E	3632	Feed Regulator Hinge Screw for 43-1 to 43-5 Machines.....
1161D	730	Shuttle Race Thread Guard Screw for 13086.....

NO.	PLATE	NAME
1507J	693	Band Wheel Crank Screw Centre Nut for 46629.....
1507J	693	Treadle Screw Centre Nut for 46629.....
1510E	693	Brace Bolt Nut for 506.....
1510E	693	Table Support Bolt Nut for 1059.....
1513J	693	Crank Connecting Rod Hinge Screw Nut
1513J	693	Oscillating Rock Shaft Hinge Pin Nut for 56812.....
1513J	693	Oscillating Shaft Crank Roller Screw Stud Nut for 5967 and 6000.....
1518E	693	Feed Connecting Link Hinge Screw Nut for 43-1 to 43-5 Machines.....
1518E	693	Feed Forked Connection Hinge Screw Nut for 43-1 to 43-5 Machines.....
1518E	693	Needle Bar Connecting Link Hinge Screw Nut for 43-2 to 43-4 Machines.....
1520E	693	Presser Bar Lifter Screw Nut for 43-1, 43-2 and 43-4 Machines.....
1520E	693	Lifting Presser Bar Lifter Screw Nut for 43-3 Machine.....
1524E	724	Machine Base Bolt Nut for 599.....
1524E	724	" Bolt Nut for 318 and 599.....
1528J	693	Roller Screw Nut for 1875.....
1547J	693	" Arm Adjusting Screw Nut for 5964
1547J	693	" " Screw Centre Nut for 5964...
1549J	693	" " Lock Spring Screw Nut for 5964.....
1560c	693	Tension Regulating Thumb Nut for 8183
1560c	3583	Thread Unwinder Tension Regulating Thumb Nut for 60609.....
1562J	693	Bobbin Winder Tension R e g u l a t i n g Thumb Nut for 27325.....
1562J	693	Thread Retaining Regulating Thumb Nut for 5989.....
1570E	693	Pitman Adjusting Screw Nut for 25074
1620J	7801	Bobbin Winder Frame Hinge Screw Nut for 27648 and 27649.....
1632c	724	Pressure Regulating Thumb Screw Lock Nut for 43-6 Machine.....
1819	693	Thread Take-up Lever Roller and Stud for 5758, 5954 and 13041.....
1823	693	Lifting Presser Bar Bracket Roller and Stud for 3133.....
1860	693	Needle Bar Cam Roller and Stud for 43-1 Machine.....
1862	3633	Guide Bar Driving Crank Roller for 4854

NO.	PLATE	NAME
1875	723	Roller, 1½ in. diam., with 634b and 1528J, for 5964.....
1885	693	Oscillating Shaft Crank Roller with 190D, 1054c and 5968, for 5967 and 6000....
2002	686	Arm Dowel Pin.....
2022	723	Shuttle Driver and Feed Lifting Cam Pin for 43-1 and 43-2 Machines.....
2022	723	Shuttle Driver and Feed Lifting Eccentric Pin for 43-3 to 43-6 Machines.....
2049	3632	Feed Regulator Pin for 43-6 Machine....
2049	686	Oscillating Shaft Crank Pin.....
2052	723	Needle Bar Connecting Stud with 155c, for 56773.....
2058	727	Lifting Presser Bar for 43-5 and 43-6 Machines.....
2070	686	Presser Bar Spring Washer for 43-1, 43-2 and 43-4 Machines.....
2070	686	Lifting Presser Bar Spring Washer for 43-3, 43-5 and 43-6 Machines.....
2102	3583	Thread Unwinder Tension Disc for 60609
2103	3583	" " " Spring for 60609.....
2103	685	Tension Spring for 5797.....
2105	686	" Thread Guard for 8173, 8174, 8177, 8181 and 13071.....
2107	686	Face Plate Thread Guard for 8179 and 8180.....
2108	3636	Face Plate Thread Guard for 8178 and 13072.....
2117	695	Band Wheel Crank Pin for 25133.....
2127	686	Thread Take-up Spring Regulator Plate for 8178 to 8180, 8182 and 13072.....
2205	695	Roller Arm Lock Spring for 5964.....
2206	723	" " Bracket for 5964.....
2269	686	Bobbin Winder Stop Latch Pin for 41448
2269	686	Vibrating Presser Stop Pin for 43-3 Machine.....
2361	3633	Feed Bar Hinge Bracket for 13078.....
2361	3633	Vibrating Presser Bar Hinge Bracket for 56752.....
2362	3633	Feed Bar Hinge Bracket Rivet for 13078
2362	3633	Vibrating Presser Bar Hinge Bracket Rivet for 56752.....
2455	685	Bobbin Winder Tension Disc for 27325
2455	685	Thread Retaining Disc for 5989.....
2653	3646	Lifting Lever Adjusting Screw Head Rivet for 5825.....

NUMERICAL LIST OF PARTS

NO.	PLATE	NAME
2763	3543	Rock Shaft for 6339.....
2766	3543	" " Knee Arm Hub with 356c, for 16647.....
2767	3543	Rock Shaft Knee Plate with 356c, for 16647.....
2770	3543	Rock Shaft Stop Dog with 356c, for 6339
3005	678	Arm Shaft Bushing (back).....
3011	696	Balance Wheel (two speed) 3 in. and 5 in. pulleys, with two 448c.....
3012	3636	Thread Take-up Cam Pin.....
3032	678	Feed Cam with 446c, for 43-2 to 43-5 Machines.....
3033	3632	Feed Connecting Link for 43-1 to 43-5 Machines.....
3039	3632	Feed Regulator for 43-1 to 43-5 Machines
*3045	681	Needle Bar Connecting Link for 56773 and 56815.....
3052	678	Oscillating Rock Shaft Hinge Pin for 56812
3054	678	Presser Bar for 43-1, 43-2 and 43-4 Ma- chines.....
3056	678	Lifting Presser Bar Spring for 43-3 Machine.....
3056	678	Presser Bar Spring for 43-2 and 43-4 Machines.....
3093	723	Feed Forked Connection Pin for 43-0 Machine.....
3094	3633	Guide Bar Driving Crank Wedge for 43-5 and 43-6 Machines.....
3100	727	Lifting Presser Bar Spring for 43-5 and 43-6 Machines.....
3126	3633	Guide Bar for 13078 and 56752.....
3131	3633	" " Driving Crank Roller Cap for 4854.....
3133	3632	Lifting Presser Bar Bracket with 641E and 1823, for 43-5 and 43-6 Machines.....
3137	3633	Vibrating Presser Bar Spring for 50844..
3146	686	Lifting Lever Hinge Stud Screw Washer for 43-3 Machine.....
3147	3636	Needle Bar Connecting Stud with 155c, for 56815.....
3286	723	Cloth Plate Slide Spring for 13048.....
4264	727	Needle Bar for 43-5 Machine.....
4265	686	" Clamp with 196F, for 4865.....
4266	3632	" " Thread Guide for 4865....
4288	678	Arm Side Cover for 43-1 to 43-5 Machines
4347	5901	Wrench for 1513 and 1518 (Accessories)..
*4349	—	Crank Connecting Rod Cap for 13002....

NUMERICAL LIST OF PARTS

NO.	PLATE	NAME
4448	695	Arm Oil Tube for intermediate bearing for 13019, 13039, 13044, 13055 and 13068.....
*4449	—	Arm Shaft Bushing (front) for 13019, 13039, 13044, 13055 and 13068.....
4723	3633	Guide Bar Lifting Bracket for 13078 and 16781.....
4725	695	Lifting Presser Bar Lifting Bracket for 13098 and 16645.....
4726	695	Lifting Presser Bar Lifting Bracket Guide Pin for 13098 and 16645.....
4727	695	Lifting Lever Pin for 13098.....
4743	3541	Arm Side Cover for 43-6 Machine.....
4784	3583	Bobbin Winder Frame Oil Pad for 41448
4802	686	Needle Clamp Thread Guide for 4803...
4803	686	Needle Clamp complete for 43-1 to 43-4 Machines, Nos. 651D, 808F and 4802..
4810	723	Lifting Lever Hinge Stud for 5836.....
4822	5901	Wrench for 1528, 1547 and 1549 (Acces- sories).....
4854	3633	Guide Bar Driving Crank with 1862 and 3131, for 43-5 and 43-6 Machines.....
4855	723	Lifting Presser Bar Lifter for 43-5 Ma- chine.....
4865	3632	Needle Clamp complete for 43-5 Machine, Nos. 651D, 4265 and 4266.....
*4891	—	Feed Shaft Bracket (front) for 13068.....
*4892	—	" " " (back) for 13068.....
4896	3541	Lifting Lever Hook for 16645.....
4897	3633	Vibrating Presser Bar Lifting Bell Crank for 16781.....
4897	3633	Lifting Presser Bar Lifting Bell Crank for 13078.....
*4898	3633	Needle Bar Connecting Link with 390E, for 56764.....
4904	3541	Feed Lever for 43-6 Machine.....
4905	3541	" Regulator with 4907 and two 237D, for 13075.....
4907	723	Feed Regulator Thumb Screw Stop Bracket for 4905.....
4908	3541	Feed Shaft for 43-6 Machine.....
4909	730	Lifting Presser Bar Lifter for 43-6 Ma- chine.....
4959	723	Feed Regulator Thumb Screw Lock Stud (brass) for 13075.....
5457	681	Needle Bar Cam with two 175E, for 43-1 Machine.....

NUMERICAL LIST OF PARTS

NO.	PLATE	NAME
5458	681	Needle Bar Cam Guide for 43-1 Machine.
5465	678	" " for 43-1 to 43-4 Machines...
5608	727	Presser Bar Lifting Bracket with 453c, for 43-2 and 43-4 Machines.....
5751	685	Shuttle Cylinder, 2½ in. diam., complete, Nos. 8162, 12000, 14535 and 56514, obsolete, use 8189.....
5752	685	Shuttle Frame for 8162.....
5757	678	Thread Take-up Cam 8185 with 440c, for 43-4 Machine.....
*5758	678	Thread Take-up Lever with 1819, for 8159
5761	678	Bobbin Winder Spindle for 13035.....
5769	3583	Thread Unwinder Tension Thread Eyelet for 60609.....
5783	—	Shuttle, 2½ in. diam., for 43-1 and 43-2 Machines, Nos. 5784, 5810 and 5934..
5784	684	Shuttle Bobbin Case complete for 5783, Nos. 591F, 592E, 5785, 5789, 5838, 5933 and 5935.....
5785	—	Shuttle Bobbin Case Hinge for 5784, Nos. 5786 to 5788.....
Nos. 5786 to 5788 for 5785		
5786	684	Shuttle Bobbin Case Latch.....
5787	684	" " " " Lever.....
5788	684	" " " " " Fulcrum Pin.....
5789	684	Shuttle Bobbin Case Position Finger for 5784.....
5791	696	Face Plate for 8174.....
5793	727	Thread Take-up Cam 8184 with 440c, for 43-5 and 43-6 Machines.....
5795	686	Tension Wheel with 5796, for 5797.....
*5796	—	" " Flange for 5795.....
5797	—	Tension complete (wheel) for 8178 to 8180, 8182 and 13072, Nos. 2103, 5795, 8183 and two each 5983 and 5984.....
5808	696	Face Plate for 8177.....
5810	684	Shuttle Bobbin for 5783.....
5811	695	Arm Spool Pin and Thread Eyelet.....
5814	728	Vibrating Presser Foot for 43-5 Machine
5816	728	Lifting Presser Foot for 43-5 Machine...
5820	727	Face Plate for 8181.....
5821	727	Lifting Lever for 5825.....
5823	676	" " Adjusting Slide Roller for 5825.....

NUMERICAL LIST OF PARTS

NO.	PLATE	NAME
5824	676	Lifting Lever Adjusting Slide Roller Pin for 5825.....
5825	—	Lifting Lever complete for 43-3 Machine, Nos. 1068D, 2653, 5821, 5823, 5824, 5878 and 5879.....
5826	676	Lifting Cam for 13043.....
5827	727	Presser Bar Lifting Bracket with two 453c, for 43-1 Machine.....
5827	727	Lifting Presser Bar Lifting Bracket with two 453c, for 43-3 Machine.....
5830	676	Vibrating Presser Hinge Bracket with 453c, for 43-3 Machine.....
5831	676	Vibrating Presser Spring for 43-3 Machine
5835	676	Lifting Lever Hinge Bracket for 5836....
5836	—	" " " " 5835 with 4810, for 43-3 Machine.....
5837	676	Vibrating Presser Guide Bracket for 43-3 Machine.....
5838	684	Shuttle Bobbin Case Latch Spring for 5784
5878	3646	Lifting Lever Adjusting Screw Head for 5825.....
5879	3646	Lifting Lever Adjusting Slide for 5825..
5885	3646	Vibrating Presser Bar for 5886.....
5886	—	Vibrating Presser Bar complete for 43-3 Machine, Nos. 191F, 5885 and 5887..
5887	3646	Vibrating Presser Foot for 5886.....
5921	728	Presser Foot (hinged) complete for 43-2 Machine, Nos. 5922 to 5924.....
5922	—	Presser Foot Bracket for 5921.....
5923	686	" " Plate Hinge Pin for 5921....
5924	—	" " " for 5921.....
5933	684	Shuttle Bobbin Case Position Finger Rivet for 5784.....
5934	684	Shuttle Body for 5783.....
5935	684	" Tension Spring for 5784.....
5952	678	Thread Take-up Cam with 446c and 453c, for 43-1 Machine.....
*5954	678	Thread Take-up Lever with 1819, for 8161
5960	678	Bobbin Winder Friction Wheel (leather) for 13034 and 13035.....
5961	678	Bobbin Winder Friction Wheel Washer for 13034 and 13035.....
5962	678	Bobbin Winder Spindle for 13034.....
5963	678	" " " Flange for 13034 and 13035.....

NUMERICAL LIST OF PARTS

NO.	PLATE	NAME
5964	—	Roller Presser complete, 1½ in. roller, for 43-1 and 43-4 Machines, Nos. 170D, 440F, 1549J, 1875, 2205, 2206, 8152, two 316F and three 1547J.....
5966	—	Oscillating Shaft Crank for 5967.....
5967	681	Oscillating Shaft Crank complete for 43-1 and 43-2 Machines, Nos. 453c, 1513J, 1885 and 5966.....
5968	686	Oscillating Shaft Crank Roller Cap Screw Washer for 1885.....
5971	728	Presser Foot (long shank) for 43-1 and 43-4 Machines.....
5977	696	Balance Wheel (two speed) for 5981.....
Nos. 5978 to 5980 FOR 5993		
5978	696	Driving Flange with two 435c.....
5979	3632	" " Latch.....
5980	3632	" " Spring.....
5981	—	Loose Wheel Attachment complete for 43-1 to 43-5 Machines, Nos. 5977 and 5993.....
5982	696	Face Plate for 8173.....
5983	686	Tension Washer (felt) for 5797.....
5984	686	" " (steel) for 5797.....
5989	—	Thread Retainer complete for 8178 to 8180, 8182 and 13072, Nos. 418E, 1502J, 10141 and two 2455.....
5990	681	Presser Bar Lifter for 43-1, 43-2 and 43-4 Machines.....
5990	681	Lifting Presser Bar Lifter for 43-3 Machine
5991	686	Thread Take-up Spring for 8178 to 8180, 8182 and 13072.....
5993	—	Driving Flange complete for 5981, Nos. 136F, 330D and 5978 to 5980.....
5999	—	Oscillating Shaft Crank for 6000.....
6000	3632	Oscillating Shaft Crank complete for 43-3 to 43-6 Machines, Nos. 453c, 1513J, 1885 and 5999.....
6053	3543	Drip Pan.....
6055	730	Machine Base Bolt Nut Washer for 13036
6055	730	" Bolt Nut Washer for 13036.....
6107	696	Arm Shaft for 5977, for 43-1 to 43-4 Machines.....
6109	696	Arm Shaft for 3011, for 43-1 to 43-4 Machines.....
6178	3543	Arm Shaft for 3011, for 43-5 and 43-6 Machines.....

NUMERICAL LIST OF PARTS

NO.	PLATE	NAME
6179	3543	Arm Shaft for 5977, for 43-5 Machine...
*6305	—	Feed Lever Bracket with two 620c, for 13068.....
6306	723	Feed Bar Connecting Link for 43-6 Machine.....
6307	723	Feed Lever Hinge Pin for 43-6 Machine...
6334	3543	Rock Shaft Hanger with two wood screws 1 in. No. 10, for 6339.....
6337	3543	Rock Shaft Lifting Bracket with two 356c, for 6339.....
6338	3543	Rock Shaft Lifting Bracket Hook for 6339
6339	3543	Rock Shaft complete for 13037, 13098 and 16645, Nos. 2763, 2770, 6337, 6338, 16647 and two 6334.....
6343	3543	Pitman for 16645.....
6436	727	Oil Cup with 1111E and three 6437.....
6437	723	" " Thread Eyelet for 6436.....
6466	678	Presser Bar Spring for 43-1 Machine.....
6703	3543	Pitman, length 14½ in., for 13037 and 13098.....
7071	695	Binder Screw Washer for 120178.....
7071	695	Guide Screw Washer for 43-6 Machine...
7071	695	" Thumb Screw Washer for 120177..
7170	3543	Lifting Lever for 13037.....
7299	727	" Presser Bar for 43-3 Machine.....
7958	695	Pitman Pin for 25246.....
8152	723	Roller Arm for 5964.....
8159	—	Thread Take-up Lever 5758 with 1088c, for 43-4 and 43-6 Machines.....
8161	—	Thread Take-up Lever 5954 with 1088c, for 43-1 and 43-2 Machines.....
*8162	—	Shuttle Frame 5752 with 590D, 11854, 12001 and 12002, for 5751 and 8189...
8173	—	Face Plate 5982 with 2105, for 8179.....
8174	—	" " 5791 with 2105, for 8178.....
8177	—	" " 5808 with 2105, for 8180.....
8178	—	Face Plate complete for 43-5 Machine, Nos. 233D, 448c, 2108, 2127, 5797, 5989, 5991 and 8174.....
8179	—	Face Plate complete for 43-2 and 43-4 Machines, Nos. 448c, 2107, 2127, 5797, 5989, 5991, 8173 and two 233D.....
8180	—	Face Plate complete for 43-1 Machine, Nos. 448c, 2107, 2127, 5797, 5989, 5991, 8177 and two 233D.....
*8181	—	Face Plate 5820 with 2105, for 8182.....

NUMERICAL LIST OF PARTS

NO.	PLATE	NAME
8182	—	Face Plate complete for 43-3 Machine, Nos. 233b, 448c, 2127, 5797, 5989, 5991 and 8181.
8183	—	Tension Screw Stud 817c with 1560c, for 5797.
*8184	—	Thread Take-up Cam for 5793.
*8185	—	" " " " 5757.
8187	730	Shuttle Cylinder for 8194.
8188	730	" Tension Spring for 8194.
8189	730	Shuttle (cylinder) 2½ in. diam., complete, for 43-3 to 43-6 Machines, Nos. 8162, 8194, 12000 and 14535.
*8194	—	Shuttle Cylinder 8187 with 773f and 8188, for 8189.
8879	7801	Arm Spool Pin Washer (cloth).
8908	5901	Wrench for 1520 (Accessories).
10141	685	Bobbin Winder Tension Spring for 27325.
10141	685	Thread Retaining Spring for 5989.
11165	695	Oscillating Rock Shaft Oil Pad for 13009.
11241	7800	Bobbin Winder Spool Washer (cloth) for 27325.
11742	695	Pitman Washer for 25246.
11854	730	Shuttle Cylinder Latch Spring for 8162.
12000	685	" " Hinge Pin for 5751 and 8189.
12001	685	Shuttle Cylinder Latch for 8162.
12002	685	" " " Pin for 8162.
12093	685	" " for 56514, obsolete.
12095	685	" Tension Spring for 56514, obsolete.
12169	715	Bobbin Winder Frame for 13034 and 13035.
12170	715	" " Spring for 13032 and 13033.
12296	686	Thread Eyelet (side of arm).
*13001	—	Cylinder, 3¼ in. diam., for 43-1 and 43-2 Machines.
13002	717	Crank Connecting Rod with 4349 and two 158E.
13003	719	Face Plate for 600 and 2111 for 43-1 and 43-2 Machines, obsolete.
13004	716	Feed Dog, 12 teeth, for 43-1 Machine.
13005	715	" " Carrier for 43-1 to 43-5 Machines.
13006	717	Feed Forked Connection for 43-1 to 43-5 Machines.
13007	717	Feed Rock Shaft for 43-1 to 43-5 Machines.
13008	715	" " " Crank for 43-1 to 43-5 Machines.

NUMERICAL LIST OF PARTS

NO.	PLATE	NAME
*13009	715	Oscillating Rock Shaft with 11165, for 13062.
13010	717	Oscillating Shaft for 43-1 and 43-2 Machines, obsolete.
13011	721	Shuttle Driver and Feed Cam for 43-1 and 43-2 Machines, obsolete.
13012	715	Shuttle Race Ring for 43-1 and 43-2 Machines.
13013	715	Shuttle Race Ring Cap for 13014.
13014	—	Shuttle Race Ring Cap complete for 43-1 and 43-2 Machines, Nos. 13013, 13015 and two 240b.
13015	721	Shuttle Race Cap Latch for 13026, 13088 and 13095.
13015	721	Shuttle Race Ring Cap Latch for 13014.
13016	716	Throat Plate for 13004.
13017	678	Thread Take-up Cam with 446c, for 43-2 Machine.
13018	715	Feed Cam with 446c, for 43-1 Machine.
*13019	—	Arm with 4448 and 4449, for 43-2 and 43-4 Machines.
*13020	—	Cylinder, 3¼ in. diam., for 43-3 to 43-5 Machines.
13021	725	Feed Dog, for leather, 12 teeth, for 43-4 Machine, obsolete.
13022	717	Oscillating Shaft for 43-1 and 43-2 Machines.
13023	715	Shuttle Driver and Feed Lifting Eccentric for 43-3 to 43-6 Machines.
13024	715	Shuttle Race for 43-3 to 43-5 Machines.
13025	717	" " Cap for 13026.
13026	—	Shuttle Race Cap complete for 43-3 to 43-5 Machines, Nos. 13015, 13025 and two 240b.
13027	725	Throat Plate for 13021, obsolete.
13028	716	Feed Dog, two rows of teeth, for 43-2 Machine.
13029	716	Presser Foot (solid) short shank, for 43-2 Machine.
13030	716	Throat Plate for 13028.
13031	715	Bobbin Winder Bracket for 13032 and 13033.
13032	715	Bobbin Winder complete for 14535, Nos. 32b, 180b, 12170, 13031 and 13035.
13033	—	Bobbin Winder complete for 5810, Nos. 32b, 180b, 12170, 13031 and 13034.

NO.	PLATE	NAME
13097	729	Throat Plate Extension, for attaching visors to uniform caps.....
13098	—	Knee Lifter complete for 43-5 Machine, Nos. 802D, 4725 to 4727, 6339, 6703, 16648 and 16659.....
14535	685	Shuttle Bobbin for 5751 and 8189.....
15072	7801	Bobbin Winder Bobbin Position Pin for 27330.....
15472	3633	Needle Bar Connecting Stud with 155c, for 56764.....
16641	3543	Lifting Lever with 448c, for 16645.....
16645	—	Knee Lifter complete for 43-6 Machine, Nos. 1064D, 4725, 4726, 4896, 6339, 6343, 16641 and 16659.....
16646	3543	Rock Shaft Knee Arm for 16647.....
16647	—	Rock Shaft Knee Arm complete for 6339, Nos. 2766, 2767 and 16646.....
16648	3543	Lifting Lever with 448c, for 13098.....
16659	3543	" " Spring for 13037, 13098 and 16645.....
16780	727	Vibrating Presser Bar for 16781.....
16781	—	Guide Bar complete for 43-5 Machine, Nos. 810D, 810E, 4723, 4897, 16780, 56844 and three 404D.....
17547	7801	Thread Unwinder Tension Thread Guard for 60609.....
17830	5695	Guide Tension Spring Steady Pin for 120176.....
19088	5695	Guide Tension Block Rivet for 120175....
24630	730	Feed Cam with two 435c, for 43-6 Machine.....
25010	381	Band Wheel Crank for 25133.....
25029	695	Belt Hook for 25176.....
25065	381	Leg for 25246.....
25074	381	Pitman (adjustable) complete with two each 558E, 1570E, 25075 and 25123, for 25246.....
25075	695	Pitman Adjusting Screw Washer for 25074
25077	381	Table Support for 25246.....
25082	381	Treadle for 25246.....
25086	381	Wrench for 1507 and 1510, for 25246....
25123	—	Pitman Adjusting Block for 25074.....
25133	381	Band Wheel (two speed) 10 in. and 12 in. diam., with 2117 and 25010, for 25240
25176	—	Belt, size $\frac{1}{8}$ in., length 68 in., with 25029, for 25246.....

NO.	PLATE	NAME
25246	—	Stand (iron work) complete, Nos. 1059E, 7958, 11742, 25074, 25077, 25082, 25086, 25133, 25368, two 25065 and four 506E
25368	381	Brace with three 46629, for 25246.....
26026	5901	Screw Driver, large (Accessories).....
26485	5901	" " small (Accessories).....
27302	7805	Bobbin Winder Frame for 27648.....
27303	7801	" " " Spring for 27648 and 27649.....
27323	7805	Bobbin Winder Spool Pin for 27325.....
27324	7805	" " " Stand for 27325....
27325	7805	Bobbin Winder Spool Stand complete for 27550 and 27551, Nos. 418E, 1562J, 10141, 11241, 27323, 27324, 34358M and two each 2455 and wood screws 1 in. No. 10.....
27330	7800	Bobbin Winder Spindle with 15072, for 27649.....
27331	7800	Bobbin Winder Stop Latch for 27649....
27333	7805	" " Spindle for 27648.....
27334	7805	" " Stop Latch for 27648....
27527	7800	" " Frame for 27649.....
27540	7800	" " Base for 27648 and 27649
27541	7800	" " Pulley for 27648 and 27649.....
27550	—	Bobbin Winder (swinging automatic, right hand) complete for 5810, Nos. 27325 and 27648.....
27551	—	Bobbin Winder (swinging automatic, right hand) complete for 14535, Nos. 27325 and 27649.....
27555	3582	Thread Unwinder Spool Pin for 41451....
27557	3582	" " " Stand with 138B, for 41451.....
27560	3582	Thread Unwinder Thread Guard Rod, 26 in. long, for 41451.....
27648	7805	Bobbin Winder for 27550, Nos. 35D, 1620r, 27302, 27303, 27333, 27334, 27540, 27541, 50356D and two wood screws 1 in. No. 7.....
27649	7800	Bobbin Winder for 27551, Nos. 35D, 1620r, 27303, 27330, 27331, 27527, 27540, 27541, 50356D and two wood screws 1 in. No. 7.....
27916	3583	Bobbin Winder Brake (leather) for 41439.
28084	3583	" " " Rivet for 41439....

NUMERICAL LIST OF PARTS

NO.	PLATE	NAME
34358	730	Bobbin Winder Tension Thread Guide for 27325.....
41398	3583	Bobbin Winder Bobbin Carrier Key for 41444.....
Nos. 41439 TO 41447 FOR 41448		
41439	7804	Bobbin Winder Base with 458c, 27916 and two 28084.....
41440	3581	Bobbin Winder Frame.....
41441	3581	" " " Hinge Pin.....
41442	3581	" " " Spring.....
41443	3581	" " Pulley with 155c.....
41444	7804	" " Spindle with 41398.....
41445	7804	" " Stop Latch.....
41446	7804	" " " " Hinge Pin....
41447	3581	" " Tripping Arm with 176b..
41448	7804	Bobbin Winder for 41449, Nos. 2269, 41439 to 41447, two 4784 and three wood screws 1 in. No. 7.....
41449	—	Bobbin Winder (swinging automatic, right hand) complete for 14535, Nos. 41448 and 41454.....
41450	3582	Thread Unwinder Spool Rest for 41451...
41451	—	" " " " 41450 with 138b and 27555, for 41454.....
41454	3582	Thread Unwinder complete, for one large spool, for 41449, Nos. 27557, 27560, 41451, 41514, 60609 and three wood screws 1¼ in. No. 12.....
41514	3582	Thread Unwinder Spool Weight, 4 in. diam., with 41515, for 41454.....
41515	3583	Thread Unwinder Spool Weight Centre Pin for 41514.....
46629	—	Band Wheel Crank Screw Centre 297c with 1507j, for 25368.....
46629	—	Treadle Screw Centre 297c with 1507j, for 25368.....
50356d	7801	Bobbin Winder Frame Hinge Screw for 27648 and 27649.....
56514	—	Shuttle Cylinder 12093 with 773f and 12095, for 5751, obsolete.....
56752	—	Guide Bar 3126 with 2361 and two 2362, for 56844.....
56764	—	Needle Bar Connecting Link 4898 with 15472, for 43-5 and 43-6 Machines....
56773	—	Needle Bar Connecting Link 3045 with 2052, for 43-2 and 43-4 Machines.....

NUMERICAL LIST OF PARTS

NO.	PLATE	NAME
56812	—	Oscillating Rock Shaft Hinge Pin 3052 with 1513j, for 13062.....
56815	—	Needle Bar Connecting Link 3045 with 3147, for 43-3 Machine.....
56844	—	Guide Bar 56752 with 337d and 3137, for 16781.....
60608	3582	Thread Unwinder Thread Guard for 60609
60609	—	Thread Unwinder Thread Guard complete for 41454, Nos. 330b, 828c, 1560c, 2103, 5769, 17547, 60608 and two 2102.....
120167	5664	Guide, for band of caps, for stitching visors and sweat bands in one operation, for 43-6 Machine.....
120168	5664	Guide, for visors, for stitching visors and sweat bands in caps in one operation, for 43-6 Machine.....
120169	5664	Guide, for visors, when cushion is fitted on visor and sweat band stitched in by hand, for 43-6 Machine.....
Nos. 120170 TO 120173 FOR 120177		
120170	5695	Guide.....
120171	5695	" Block.....
120172	5695	" Body.....
120173	5695	" Shank.....
120174	5695	" Tension Block for 120175.....
120175	5695	" " " Holder with 120174 and two 19088, for 120177.....
120176	5695	Guide Tension Spring with 17830, for 120177.....
120177	—	Guide (adjustable) complete, for sweat bands, for stitching visors and sweat bands in caps in one operation, for 43-6 Machine, Nos. 658b, 732b, 7071, 120170 to 120173, 120175, 120176 and four 234b.....
120178	5664	Binder on Shank, for visor cushion, for 43-6 Machine.....
120179	5664	Binder Stop Stud for 13083 and 120178..
120342	5901	Oiler (copper plated) with 120343 (Accessories).....
120343	5901	Oiler Spout, 3½ in. long, for 120342.....

ILLUSTRATIONS

OF

PARTS

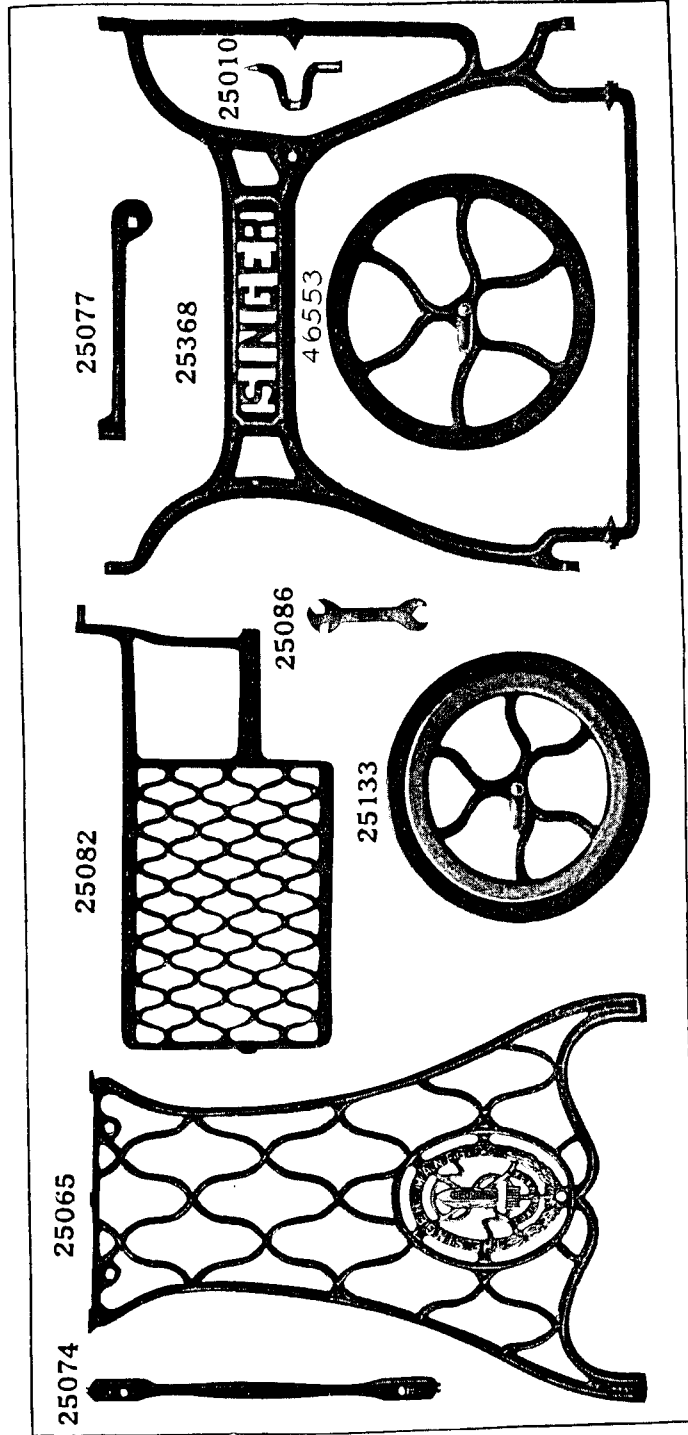


PLATE 676—FULL SIZE

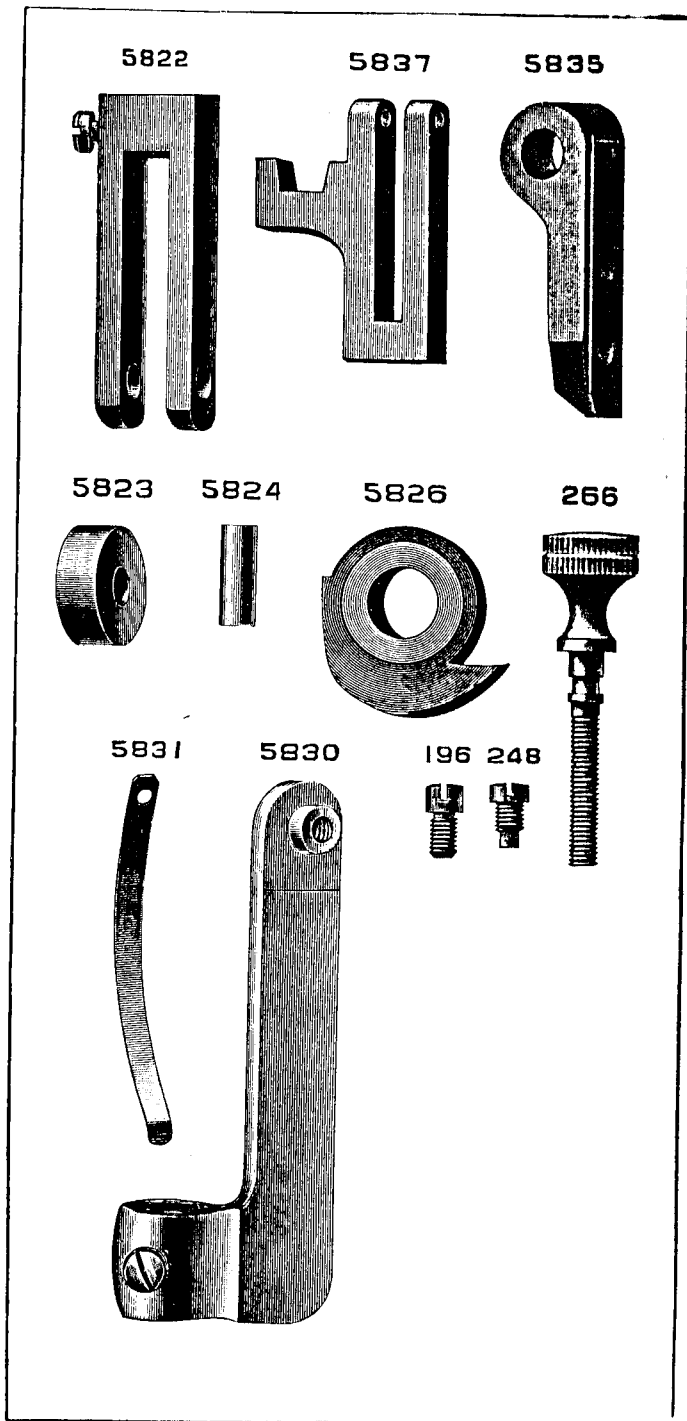


PLATE 678—ONE-HALF SIZE

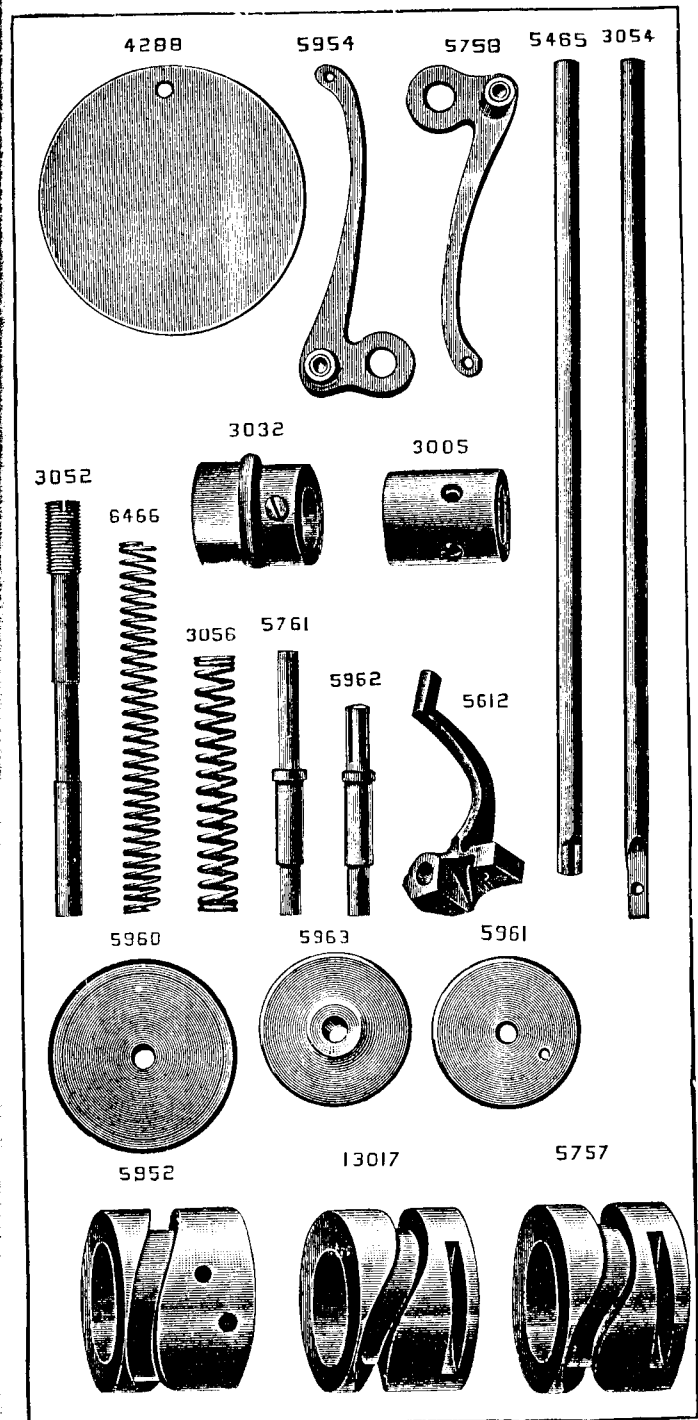


PLATE 681—FULL SIZE

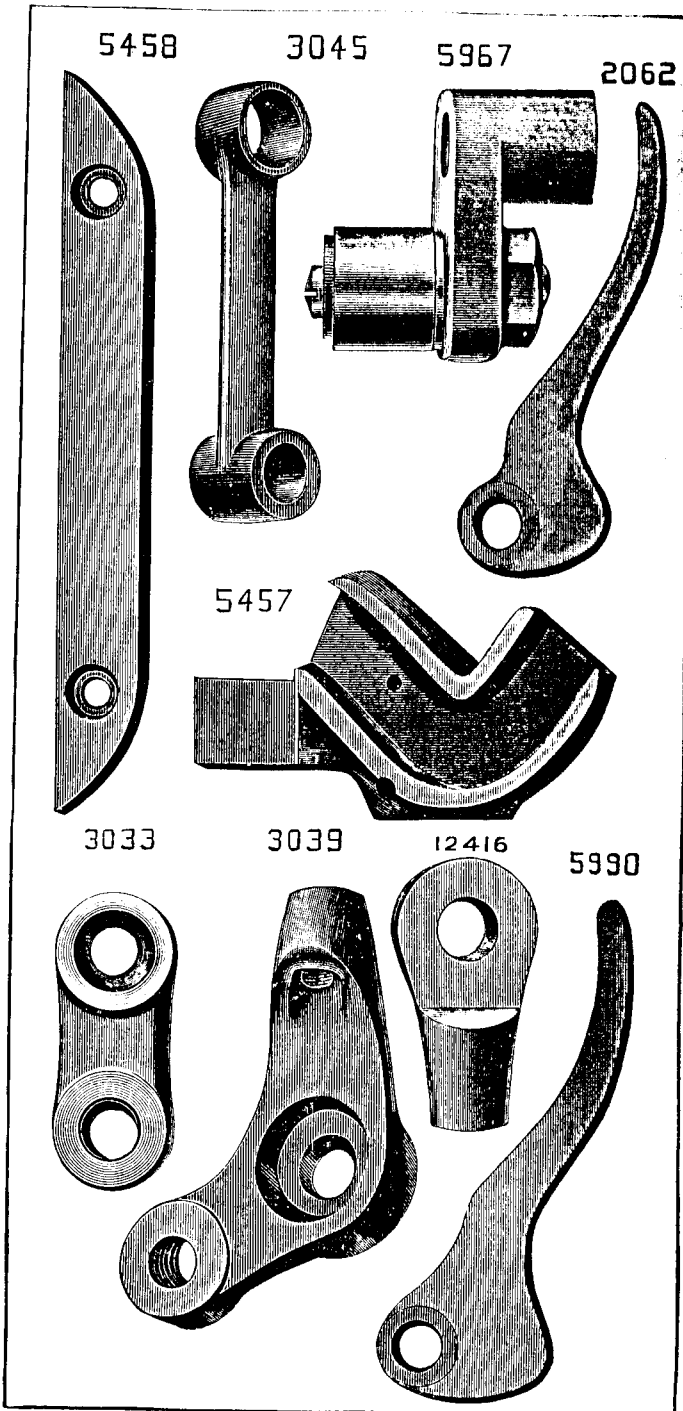


PLATE 684—FULL SIZE

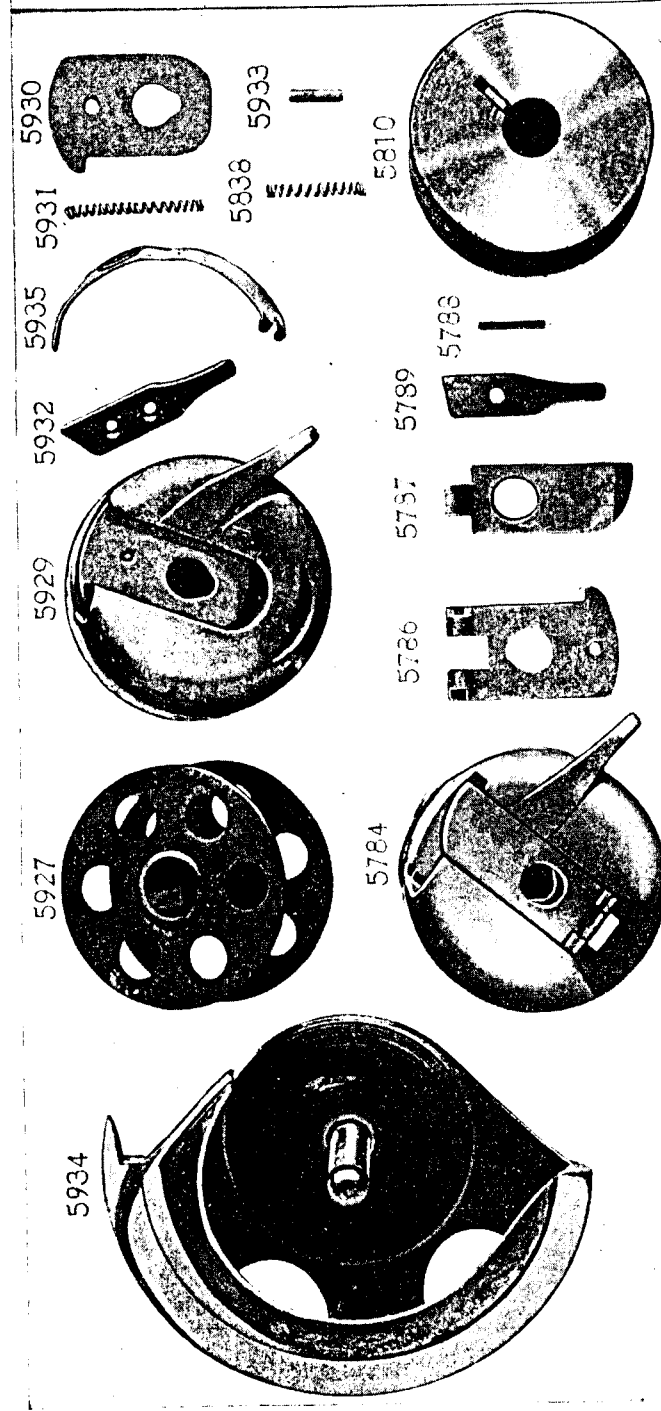


PLATE 685—FULL SIZE

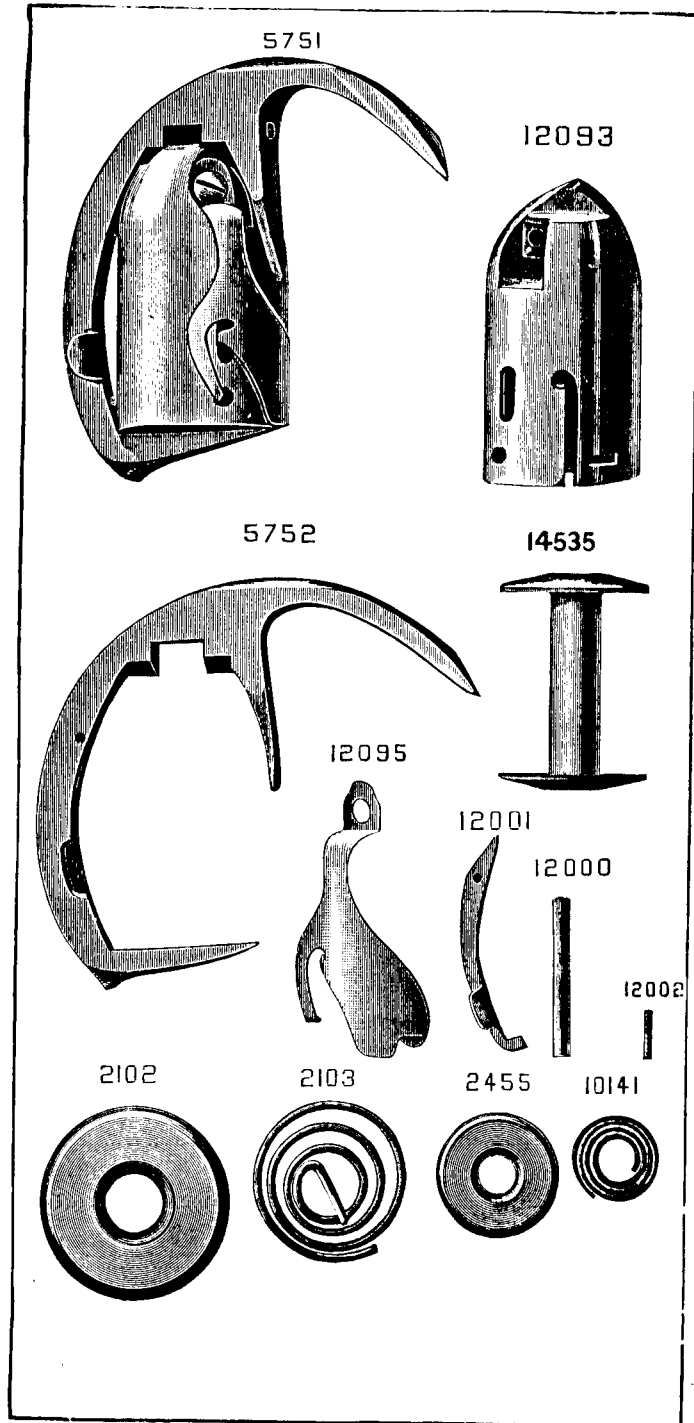


PLATE 686—FULL SIZE

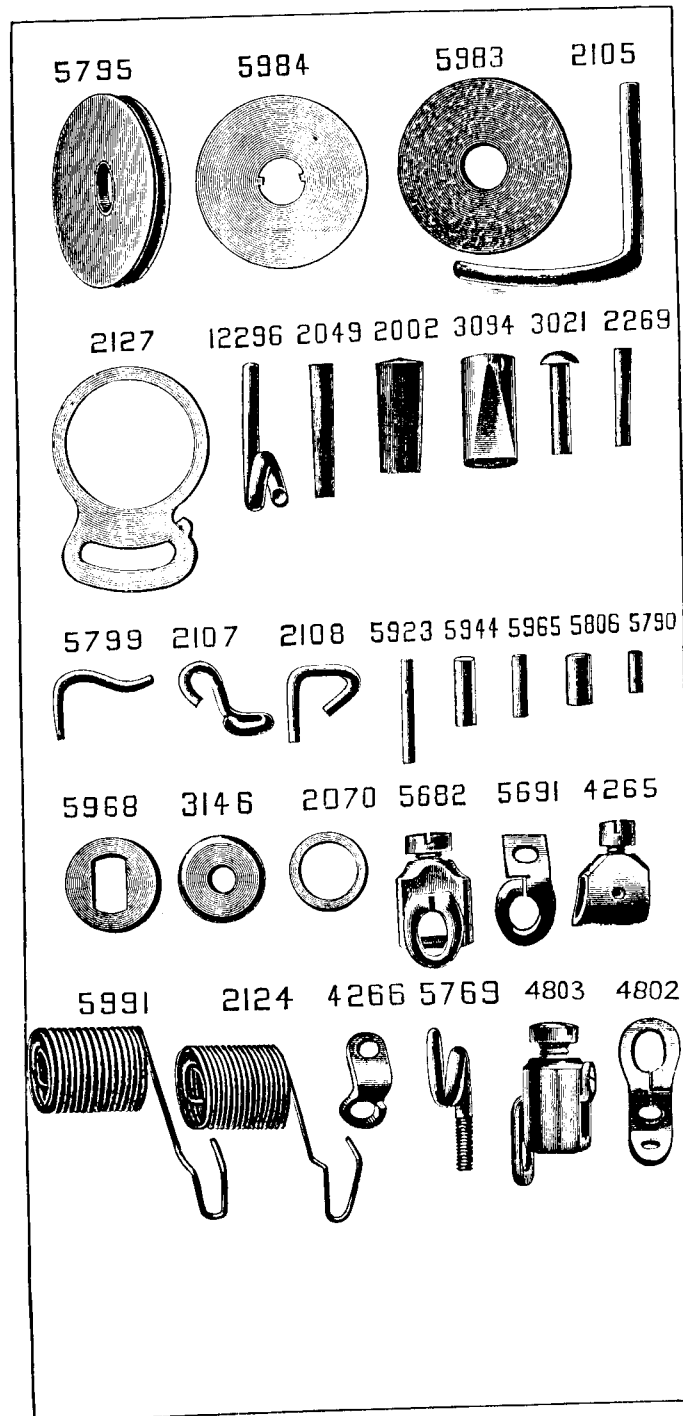


PLATE 691—FULL SIZE

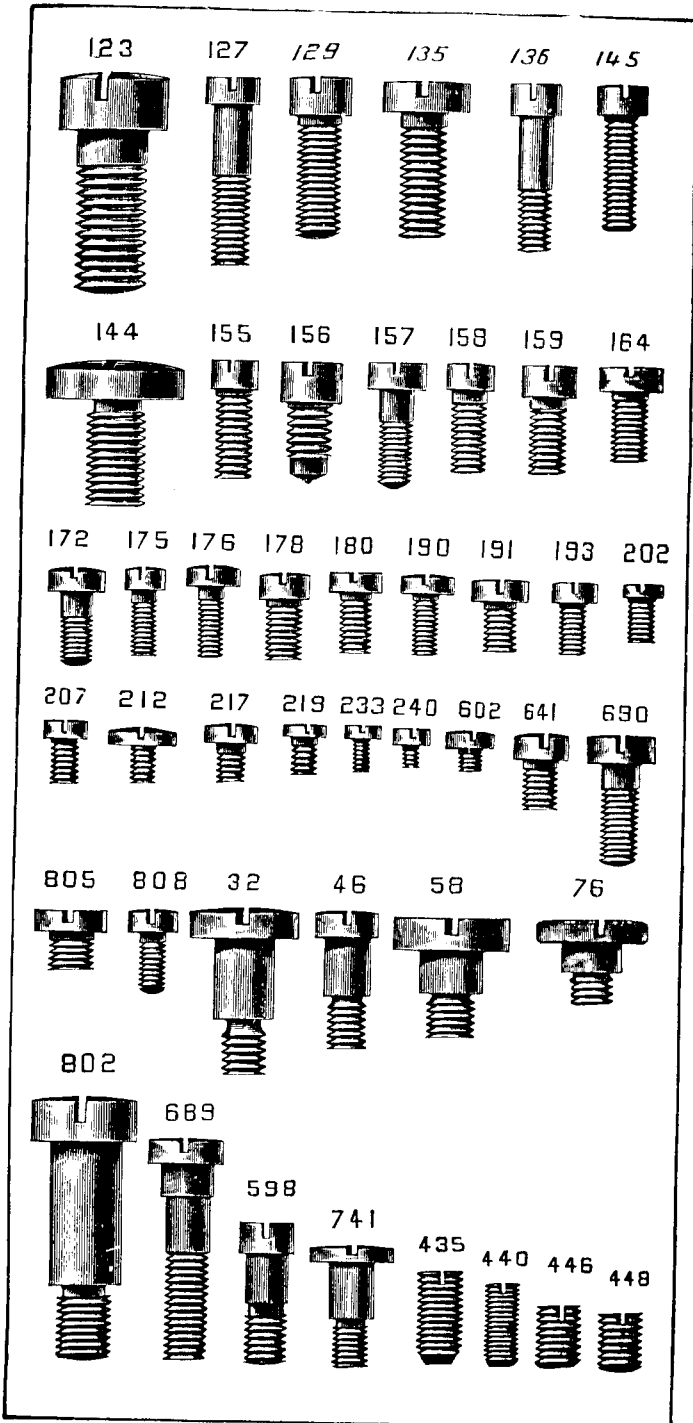


PLATE 692—FULL SIZE

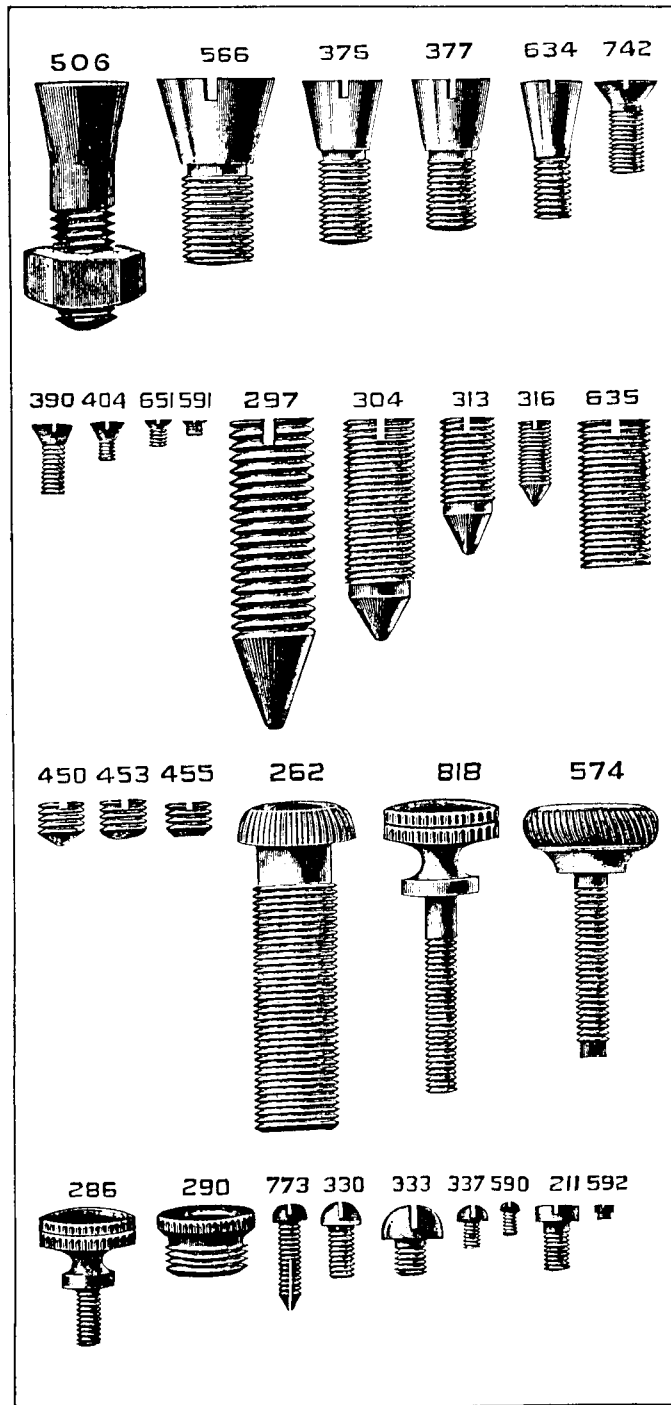


PLATE 693—FULL SIZE

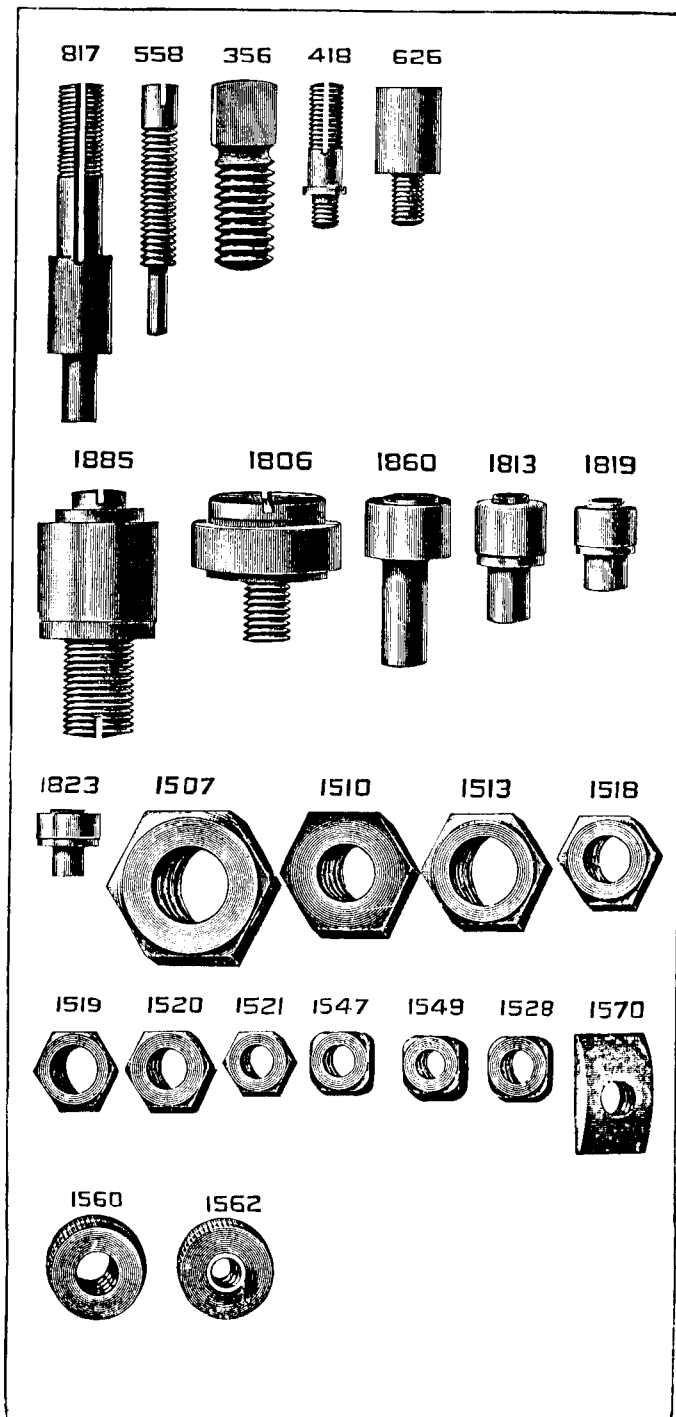


PLATE 695—FULL SIZE

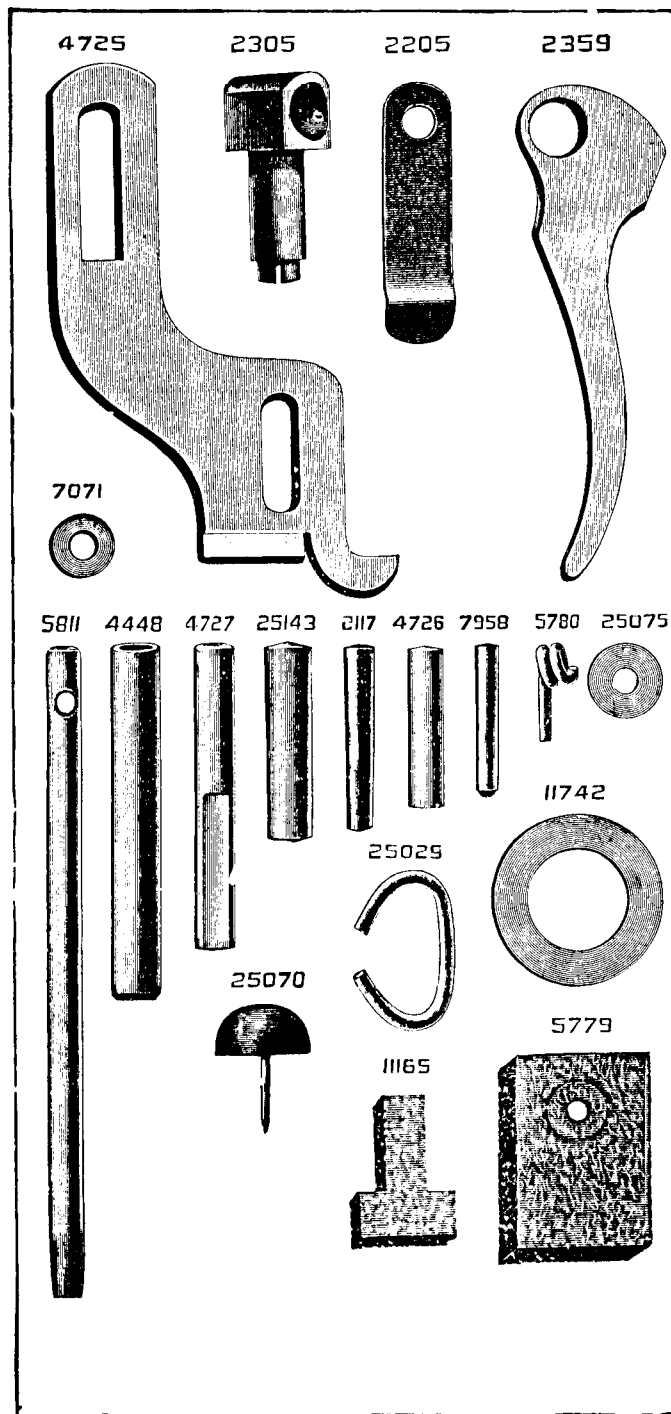


PLATE 696—ONE-FOURTH SIZE

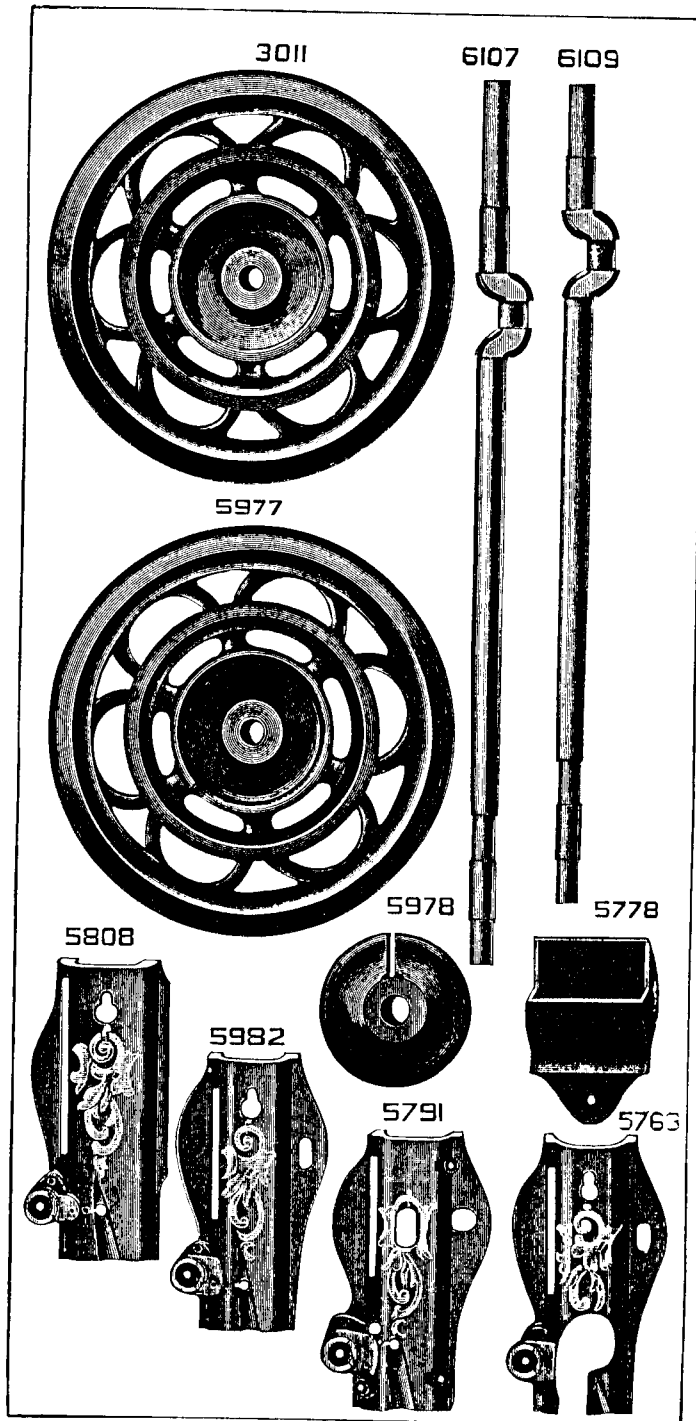


PLATE 715—ONE-HALF SIZE

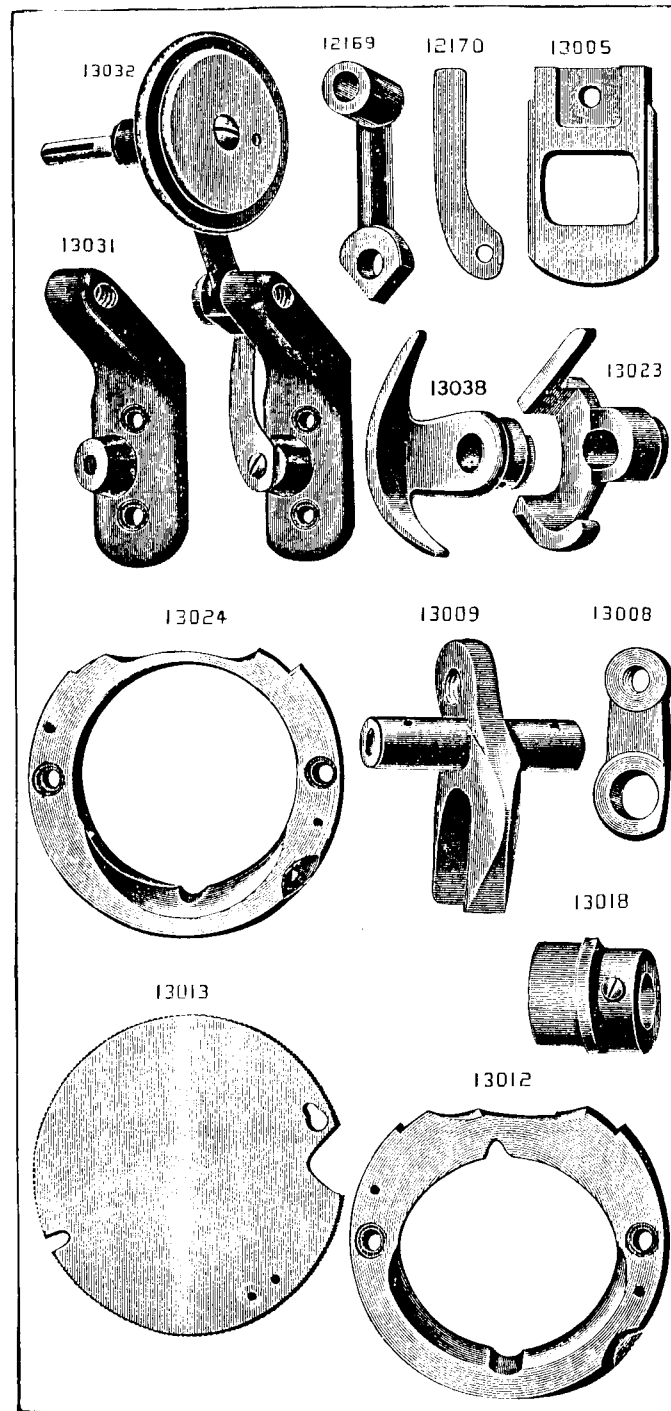


PLATE 716--FULL SIZE

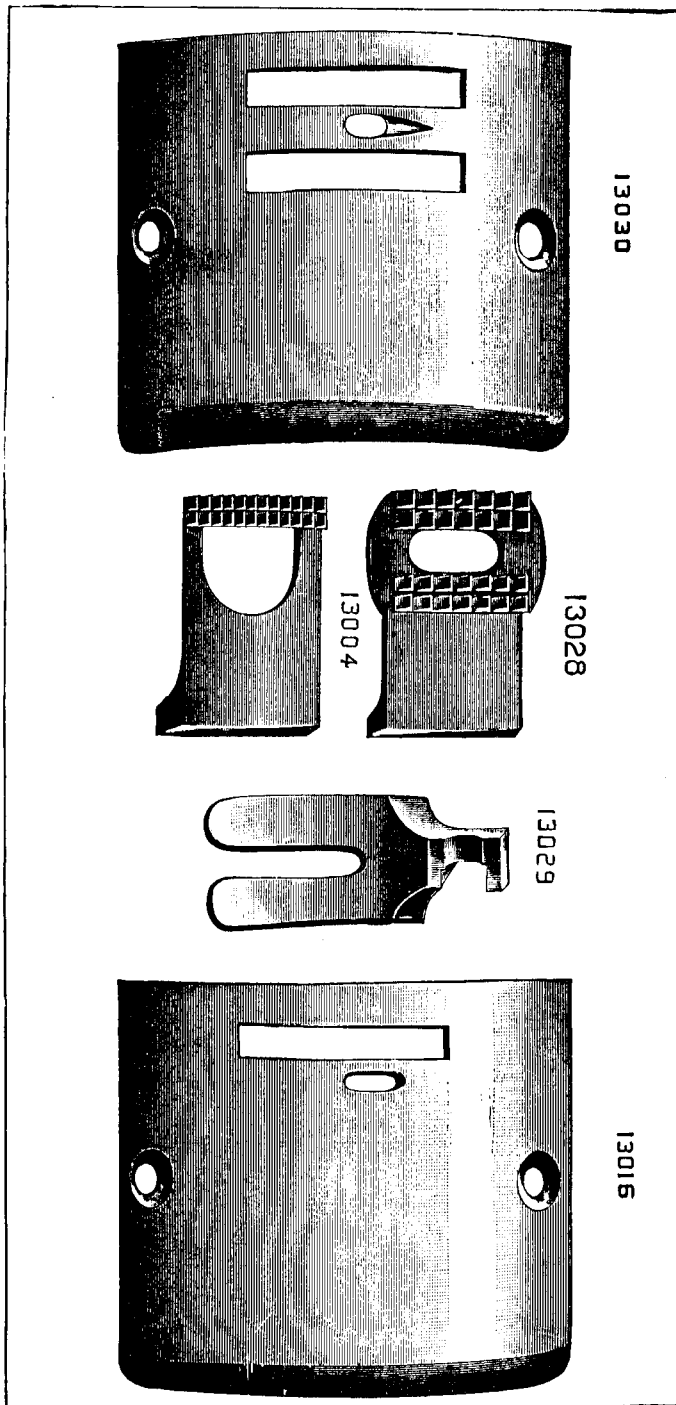


PLATE 717--ONE-HALF SIZE

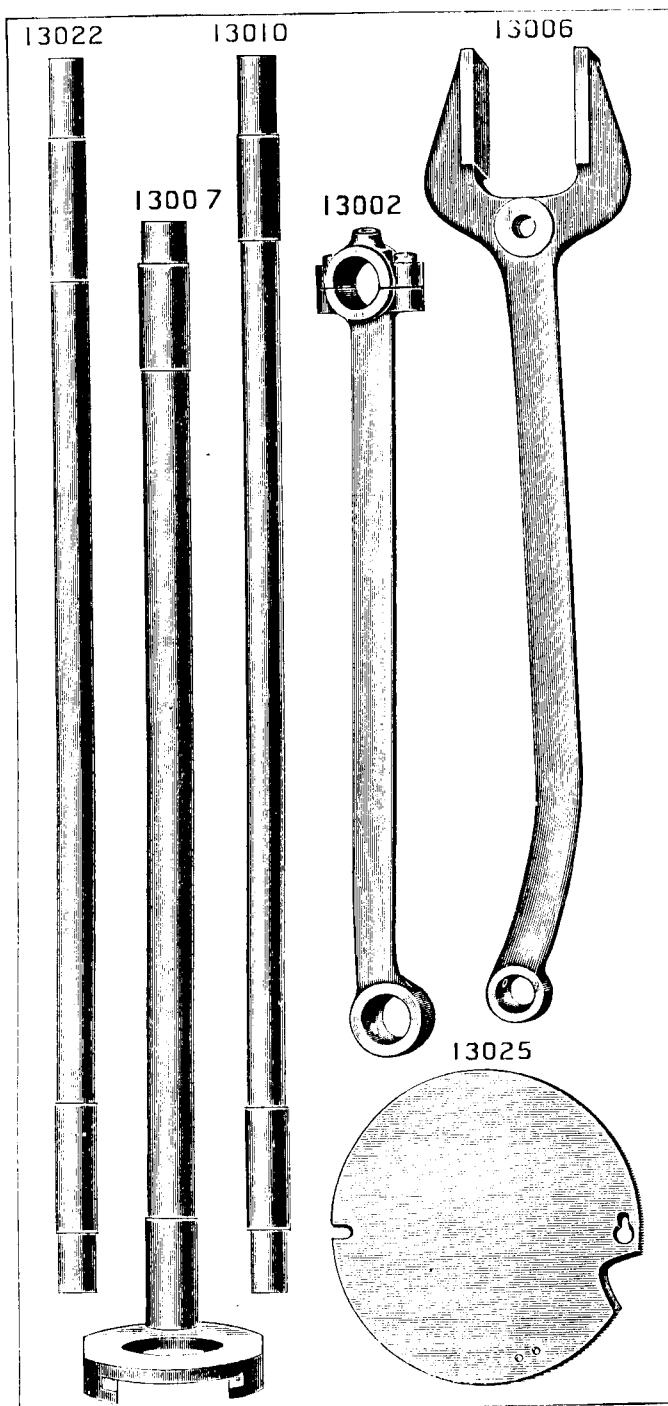


PLATE 718—ONE-FOURTH SIZE

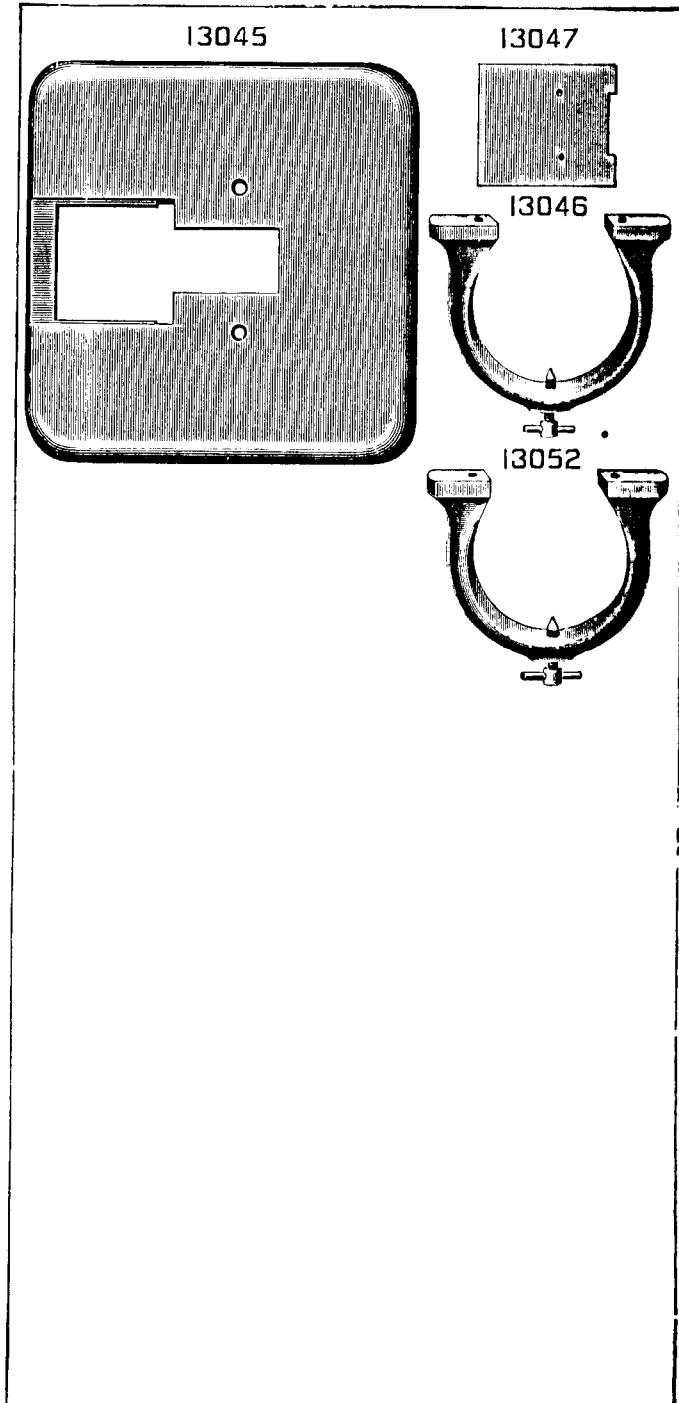


PLATE 719 ONE-HALF SIZE

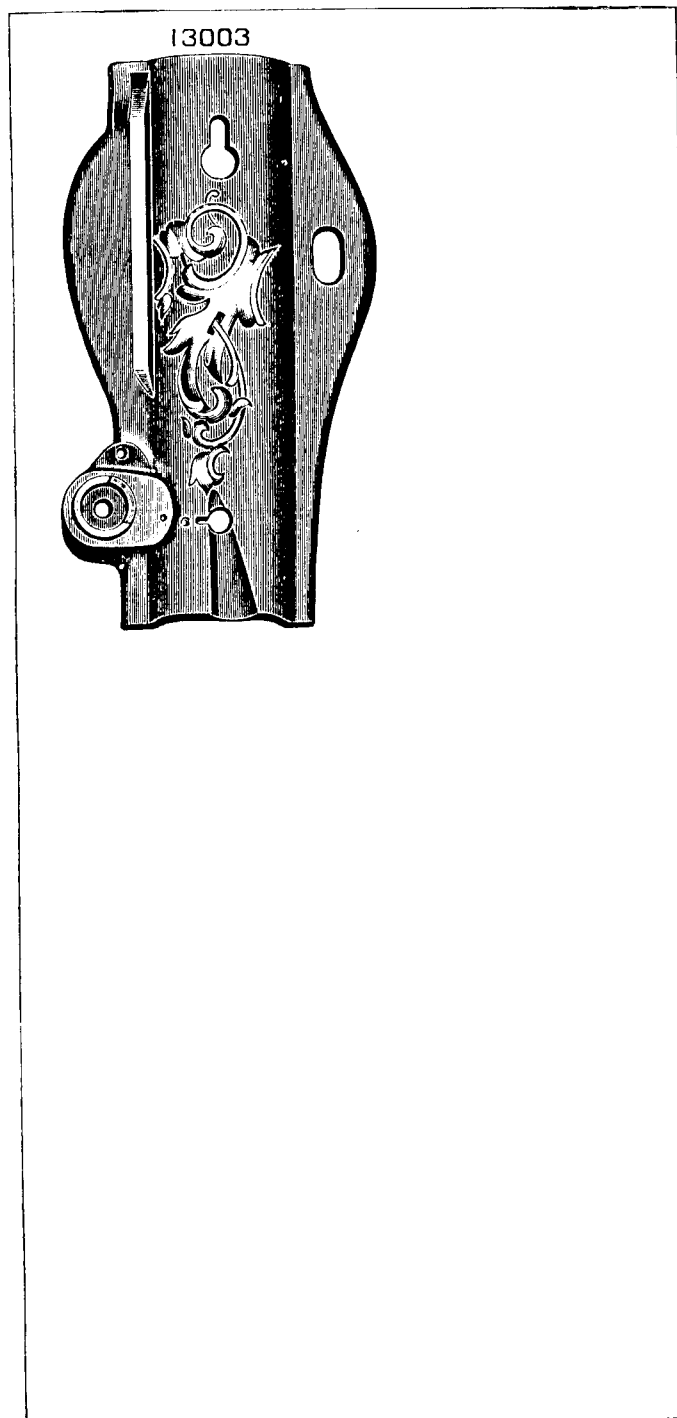
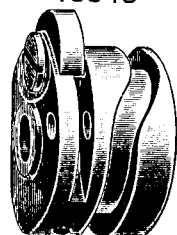


PLATE 720—ONE-HALF SIZE

13043



13041

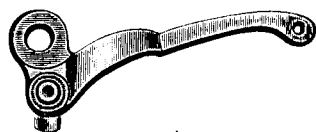
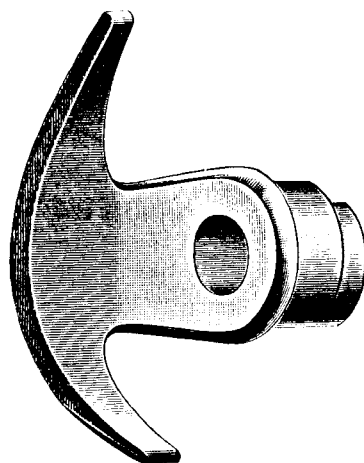


PLATE 721—FULL SIZE

13011



13015



PLATE 722 - ONE-FOURTH SIZE

13036

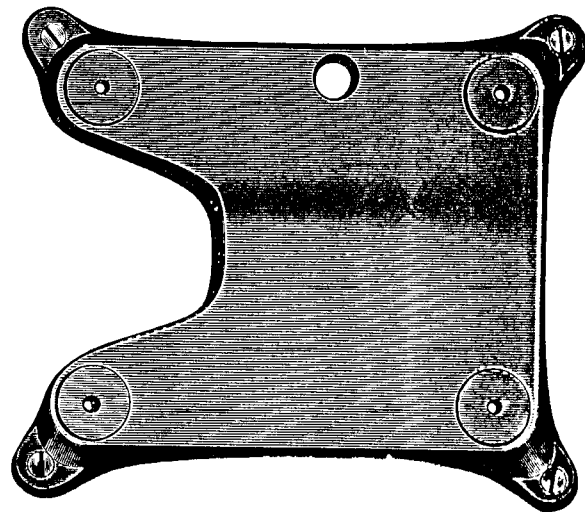


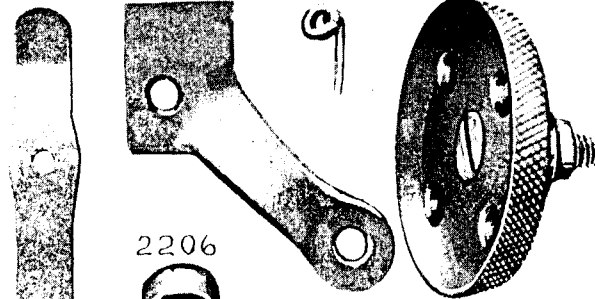
PLATE 723 - FULL SIZE

3286

8152

6437

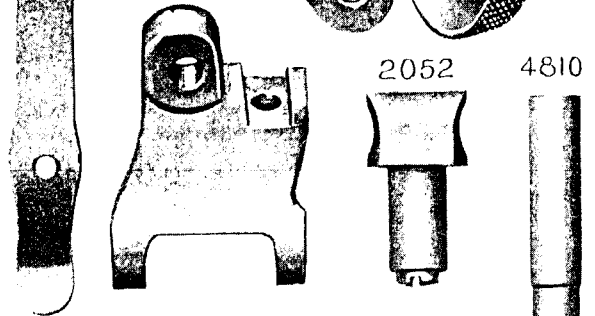
1875



2206

2052

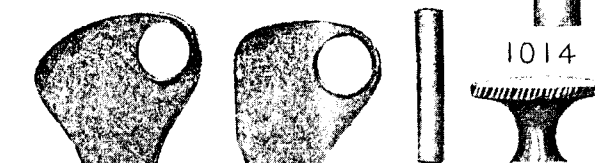
4810



5990

4855

2022



1014

6306

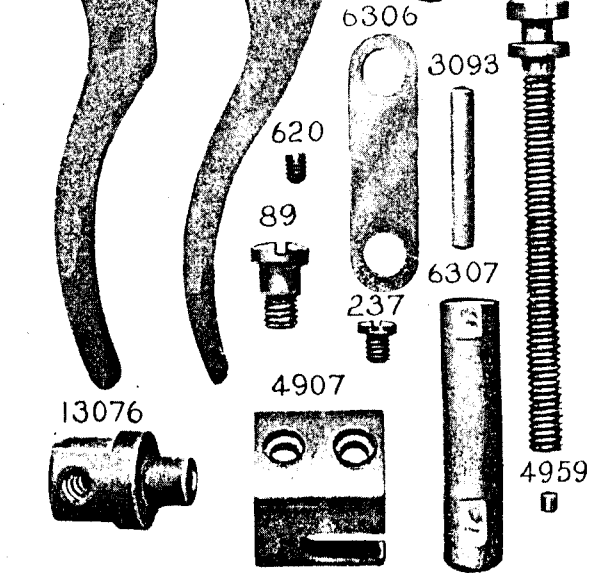
3093

620

89

237

6307



13076

4907

4959

PLATE 724—FULL SIZE

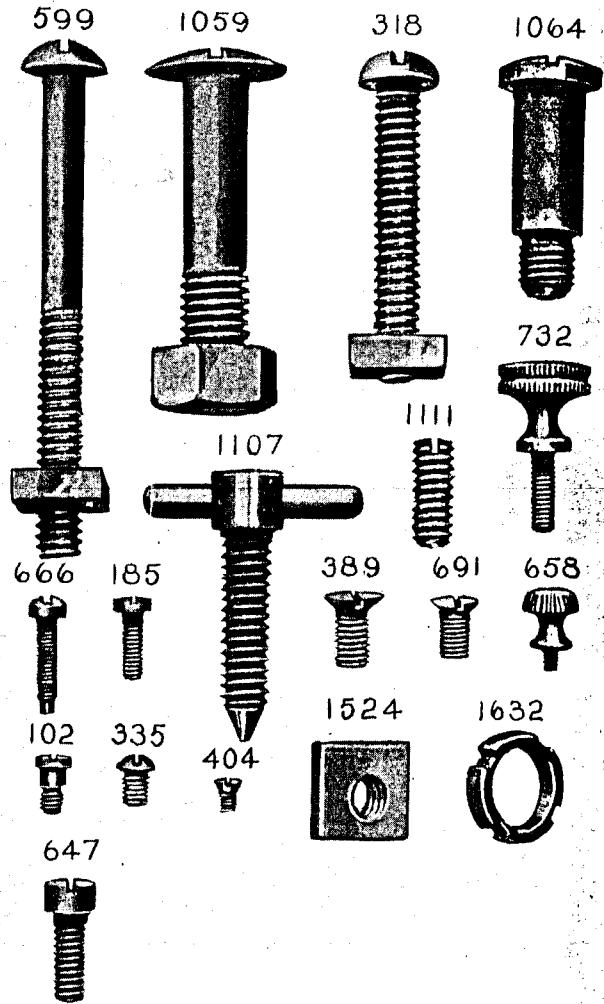


PLATE 725—FULL SIZE

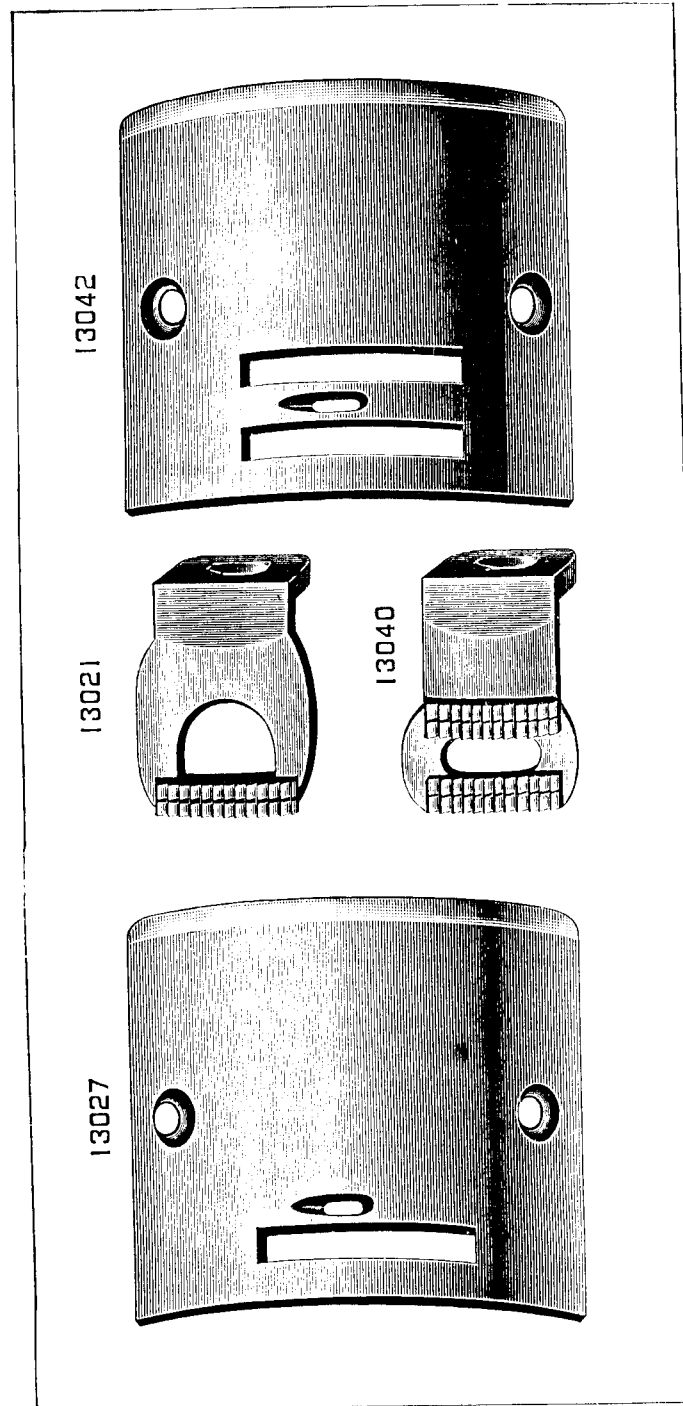


PLATE 726—FULL SIZE

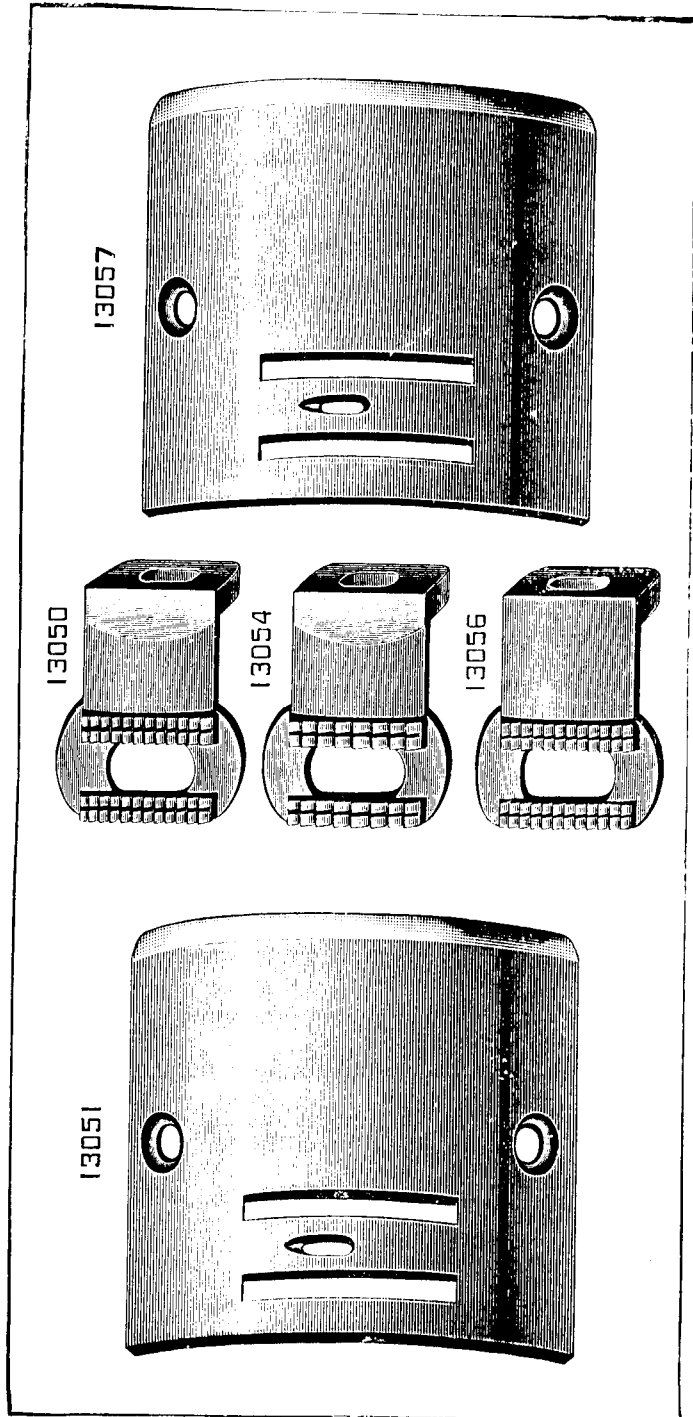


PLATE 727—ONE-HALF SIZE

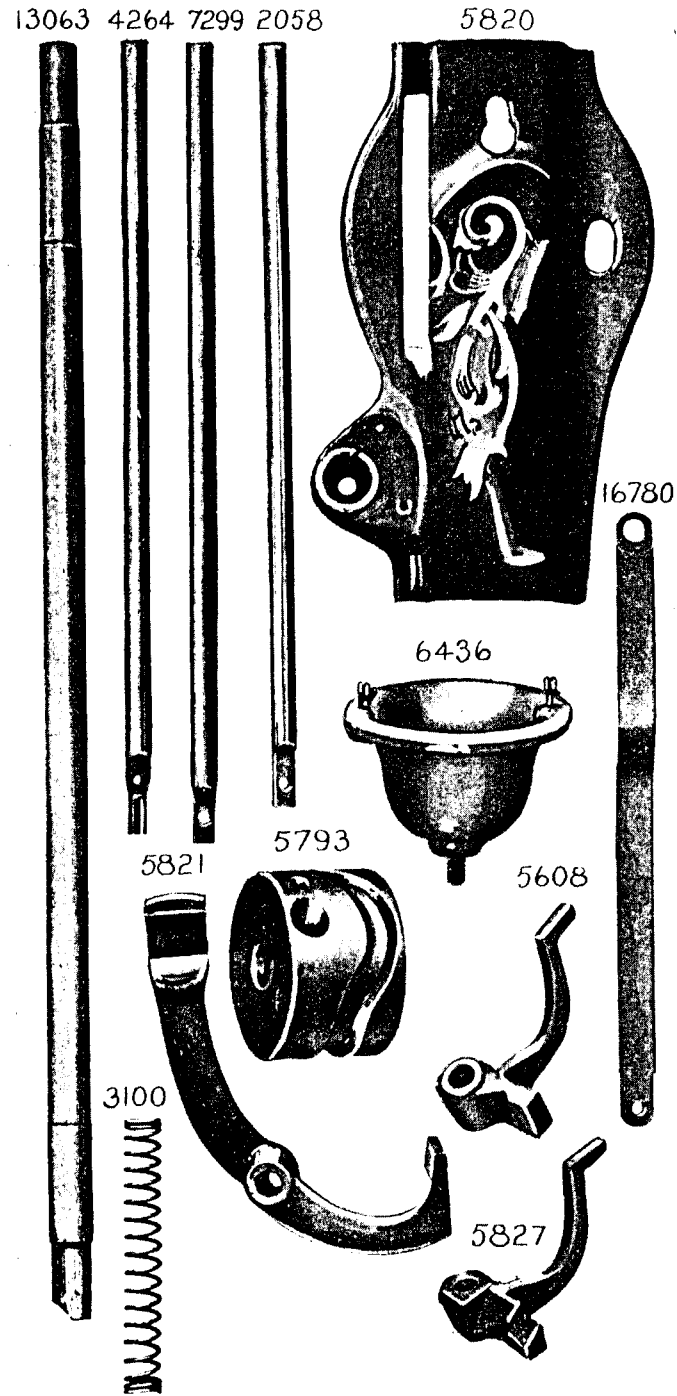
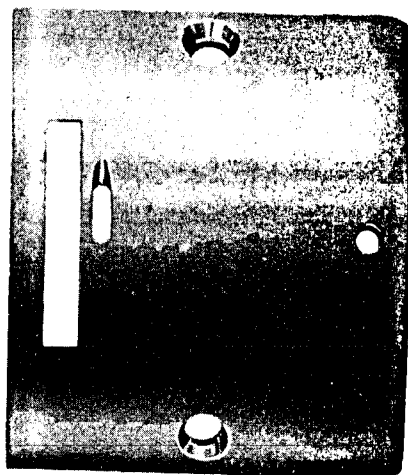


PLATE 728—FULL SIZE

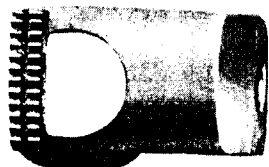
5971



13059



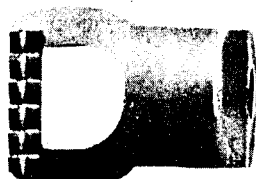
13058



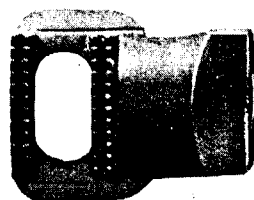
5921



13061



13060



5814

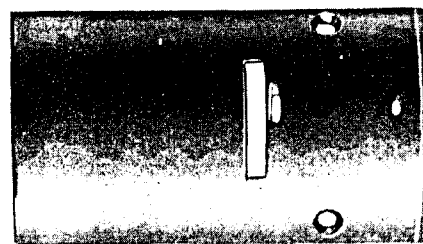


5816

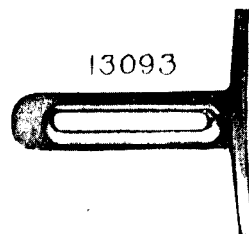


PLATE 729—ONE-HALF SIZE

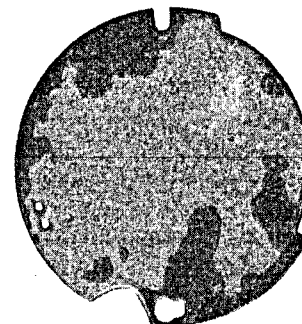
13096



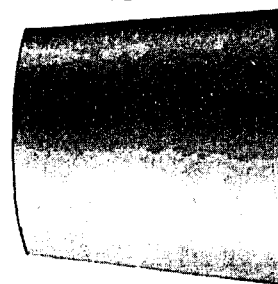
13093



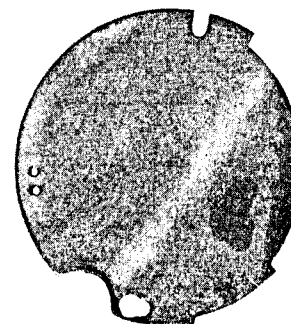
13094



13097



13087



13085

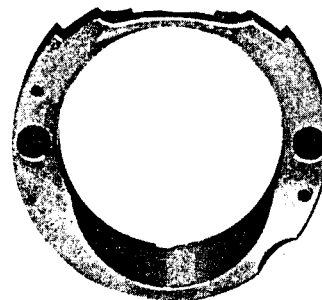


PLATE 730—FULL SIZE

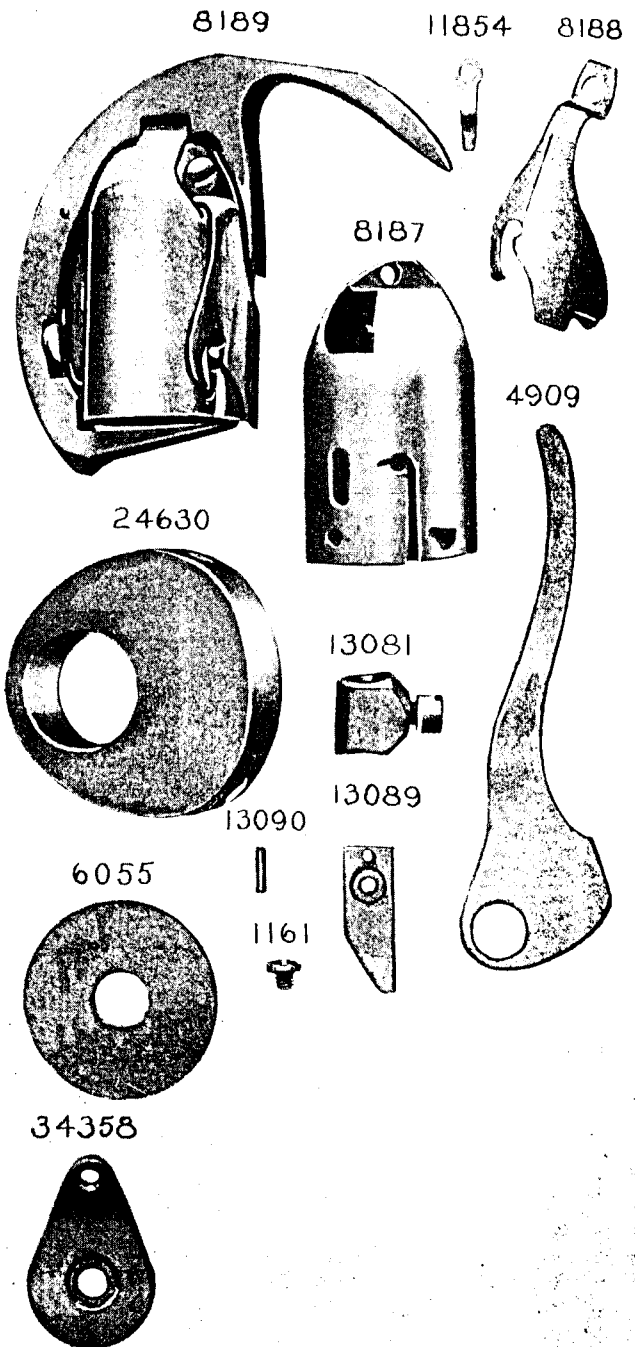


PLATE 3541—ONE-HALF SIZE

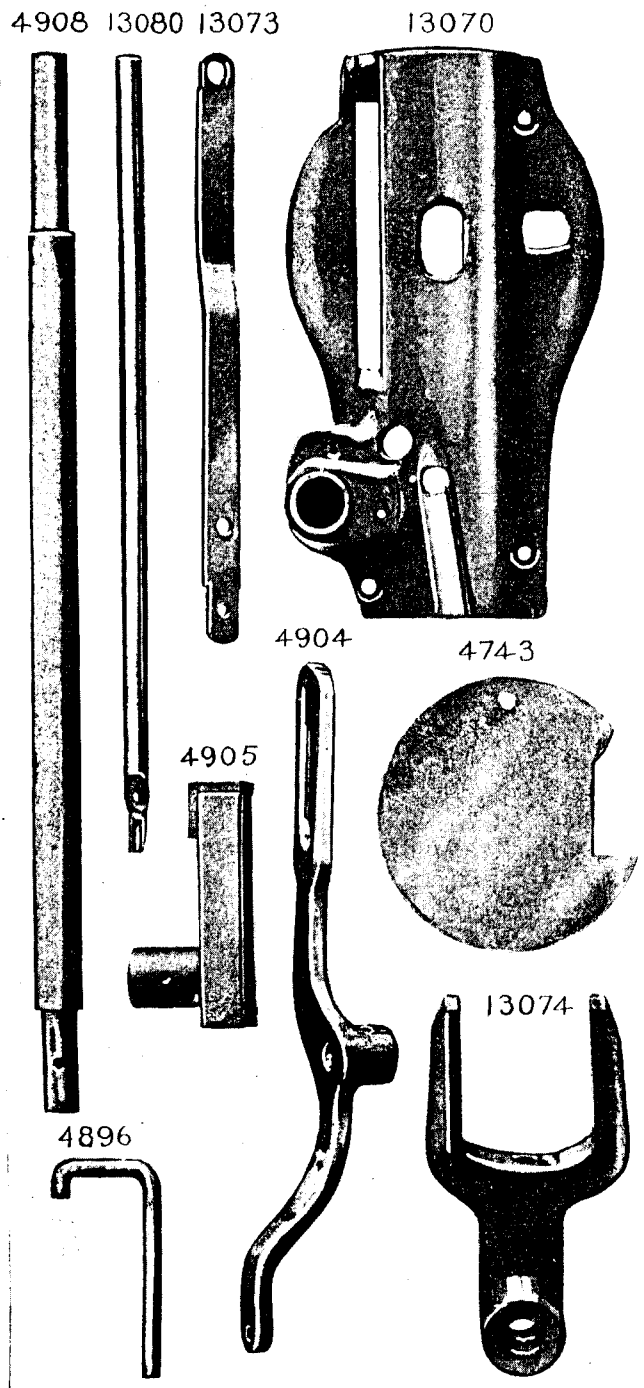
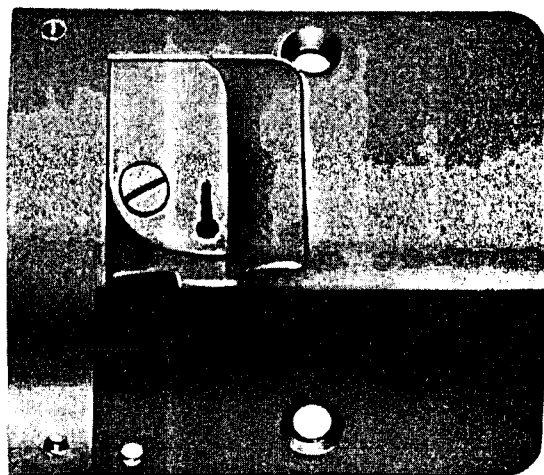


PLATE 3542—FULL SIZE

13084



13077



13079

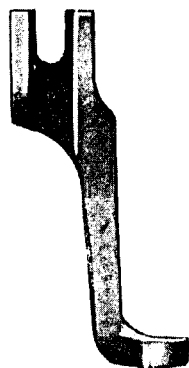
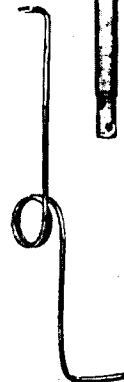


PLATE 3543—ONE-FOURTH SIZE

6179



16659



6338

6337

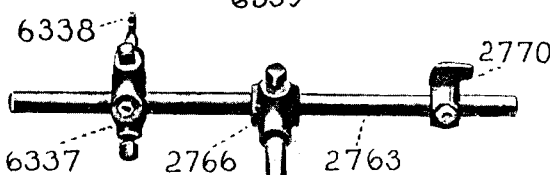
6178



6703



6339



2770

2766

2763

6334



6334



16646



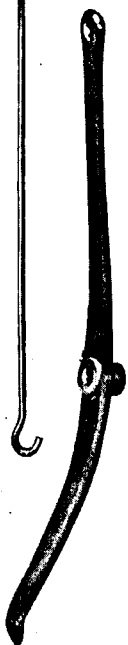
16648



16641



7170



6343



6053

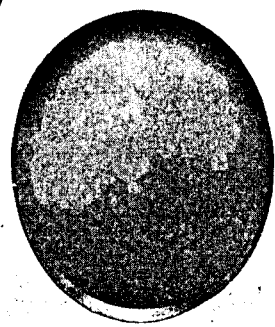
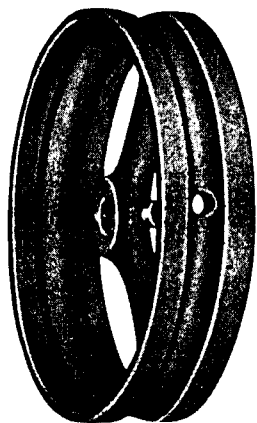


PLATE 3581—ONE-HALF SIZE

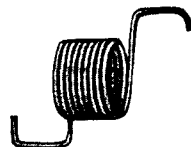
41443



41447



41442



41441



41440

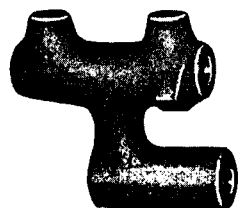
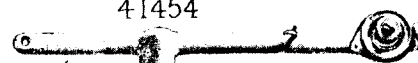


PLATE 3582—ONE-FOURTH SIZE

41454

60608

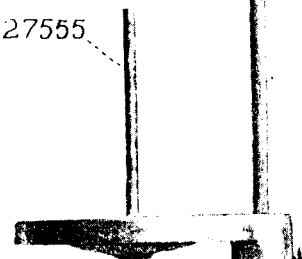


27560

41514



27555



41450

27557

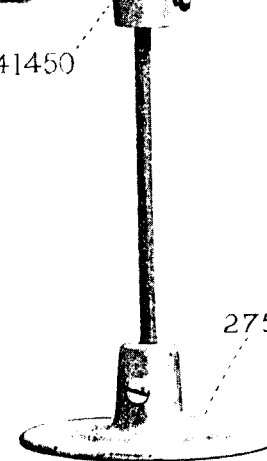
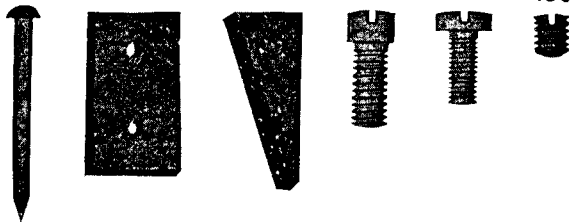


PLATE 3583—FULL SIZE

28084 27916 4784 155 176 458



41553 41551 449 2269 41398 330



637 2102 2103 1560



41515 138 5769

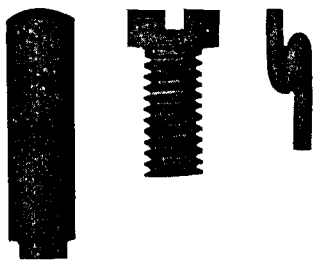
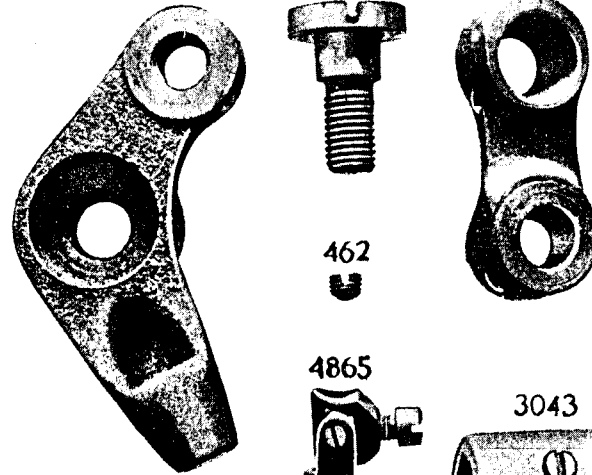


PLATE 3632—FULL SIZE

3039 1128 3033



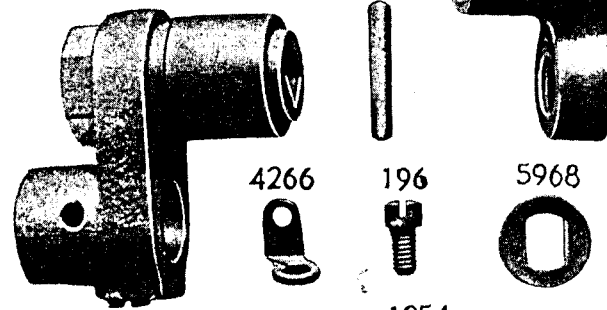
462

4865

3043

6000

2049



4266

196

5968

1054

3133



5980

2070

5979



PLATE 3633—FULL SIZE

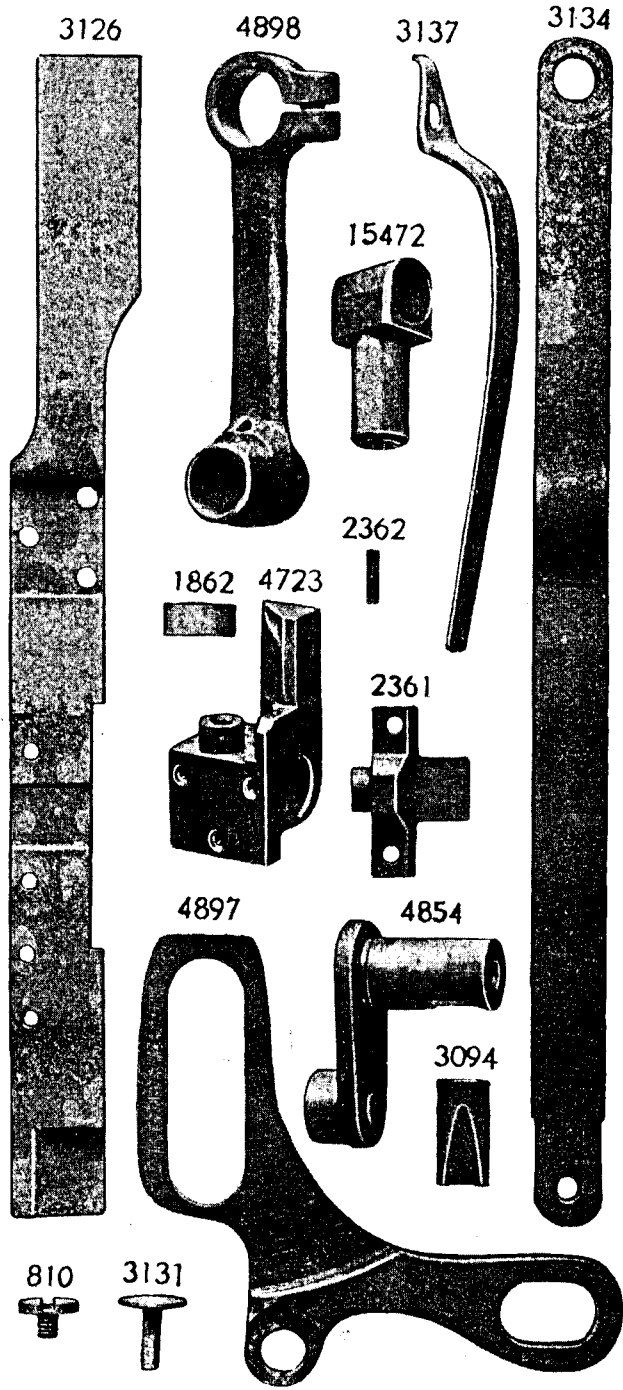


PLATE 3636—FULL SIZE

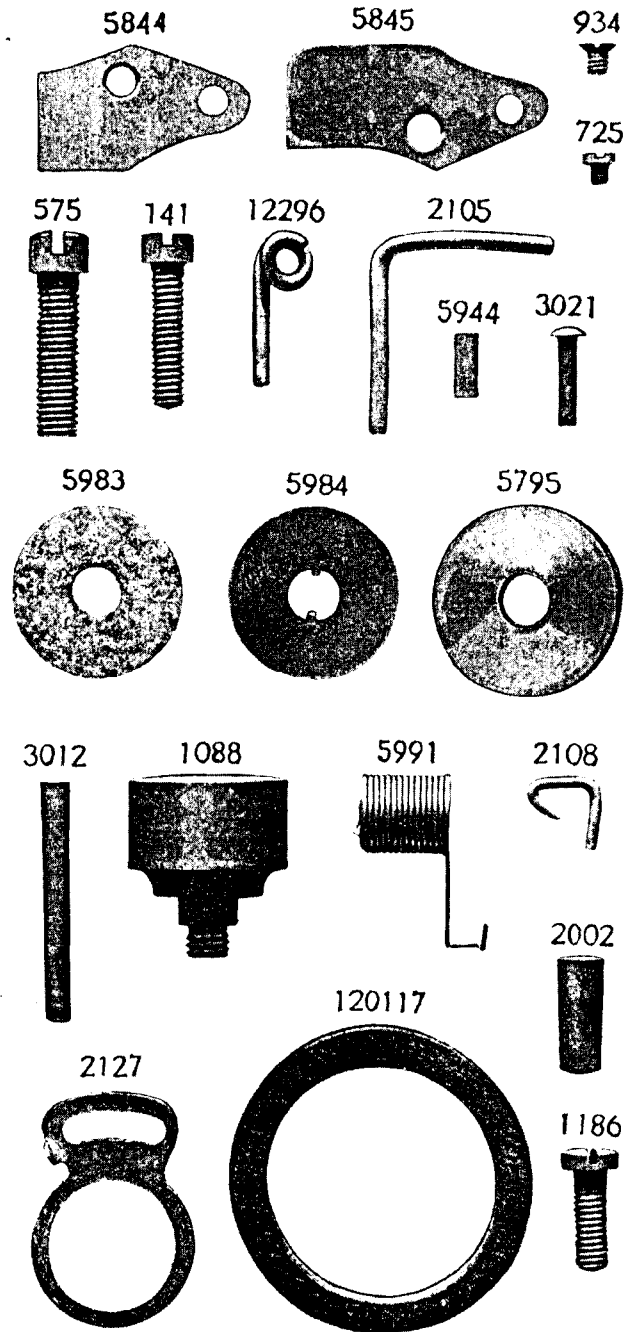
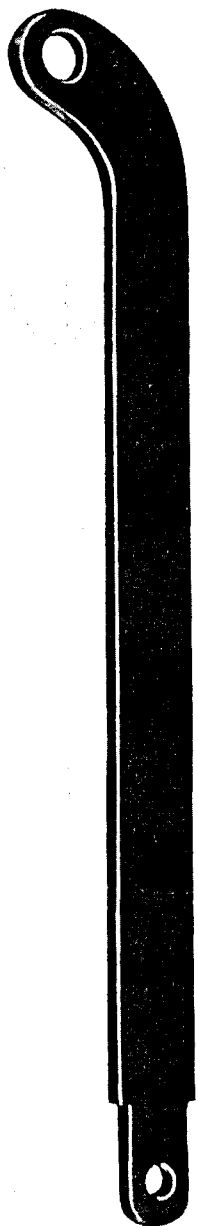
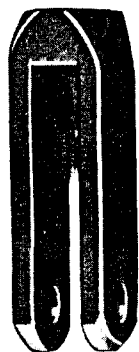


PLATE 3646—FULL SIZE

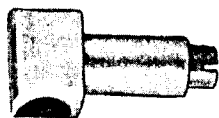
5885



5879



3147



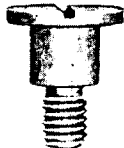
5878



1068



902



2653



5887

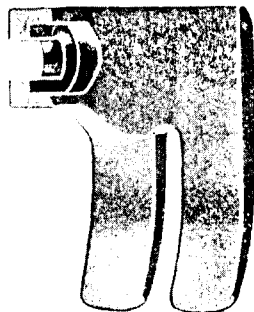
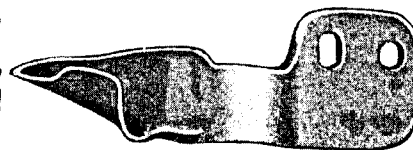
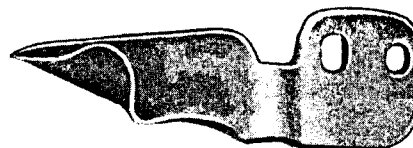


PLATE 5664—FULL SIZE

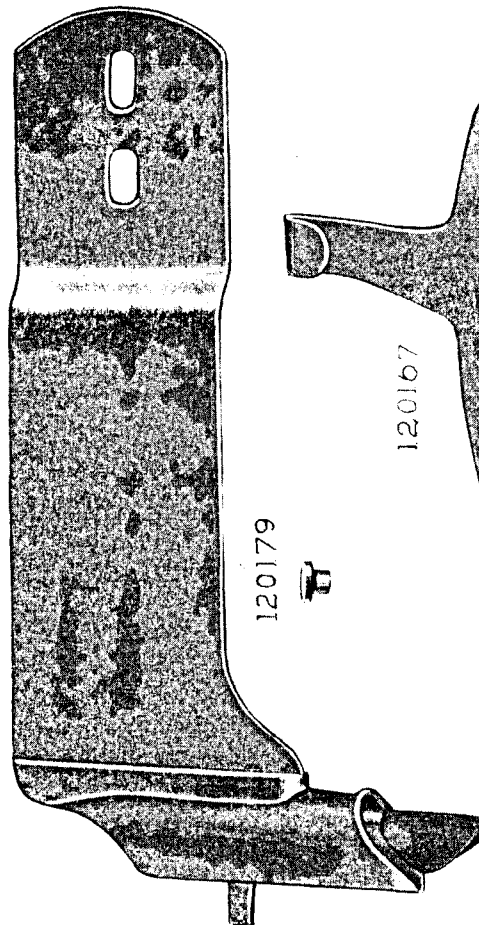
120169



120168



120178



120179



120167

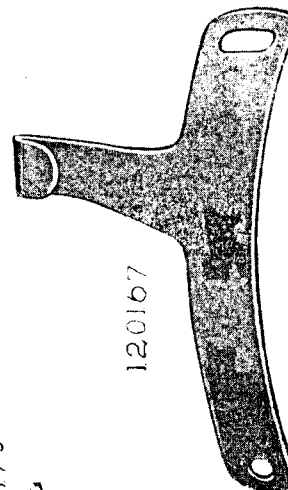


PLATE 7800—ONE-HALF SIZE

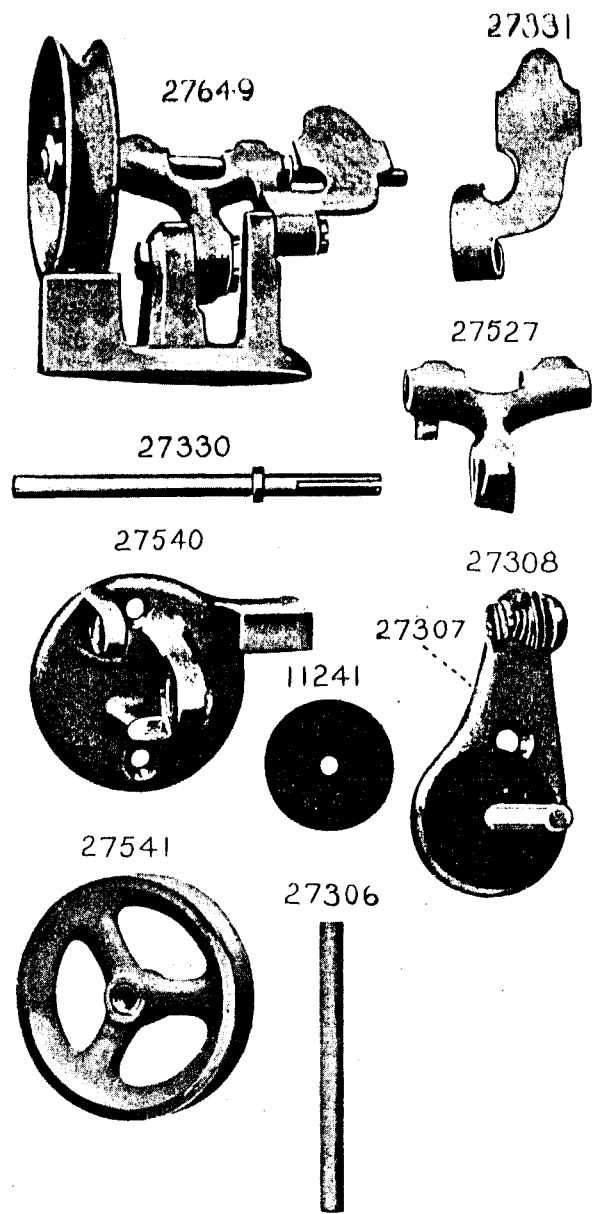


PLATE 7801—FULL SIZE

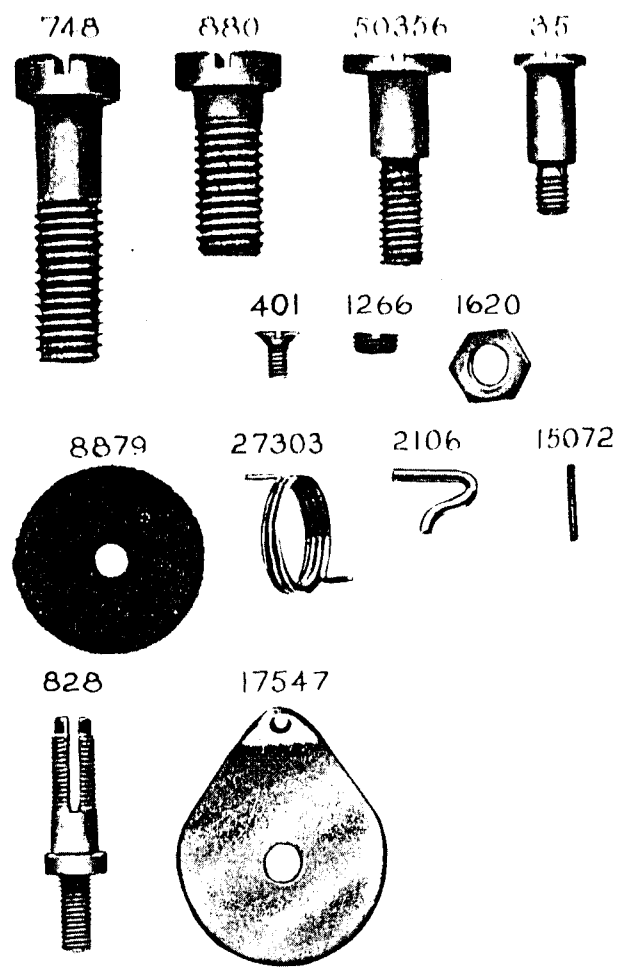


PLATE 7804—ONE-HALF SIZE

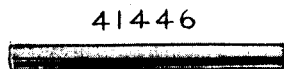
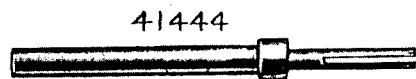
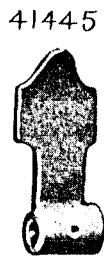
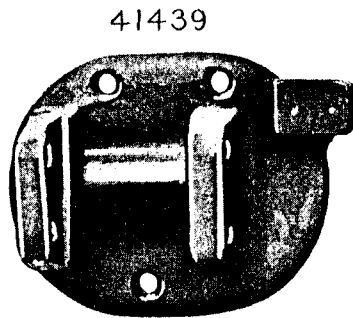
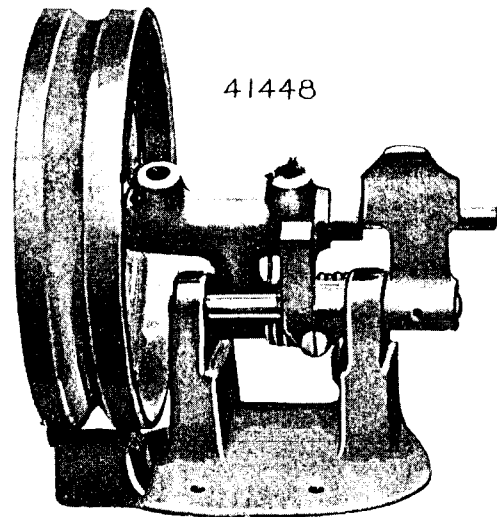


PLATE 7805—ONE-HALF SIZE

