

FORM 8934
JUNE, 1923
PRINTED IN U. S. A.

LIST OF PARTS



MACHINES

Nos. 114-22 to 114-24

THE SINGER MANUFACTURING COMPANY

COPYRIGHT, U. S. A.,
1916, 1917, 1920, 1921, 1922 AND 1923,
BY
THE SINGER MANUFACTURING COMPANY
ALL RIGHTS RESERVED FOR ALL COUNTRIES

INDEX

	PAGE
ATTACHMENTS AND ACCESSORIES	41
MACHINE No. 114-22	7
“ “ 114-23	18
“ “ 114-24	29
NUMERICAL LIST OF PARTS	47
OBSOLETE PARTS	45
PROTECTOR	41
STAND	42
STARTING LEVER AND FOOT LIFTER PARTS	42
TABLE BELT GUIDE	43
THREAD UNWINDER	44
TRIMMINGS FOR TABLE 5380	44

INSTRUCTIONS FOR ORDERING

In ordering from this list, use ONLY the part NUMBER in the FIRST column.

The number stamped on a Sewing Machine part is in every case the number of the single part only.

Every combination of parts sent out as such has its specific number, which, although not stamped on the parts, must be used when ordering the combination.

Each number always indicates the SAME PART in whatever list it appears, or for whatever machine.

The letters after some of the numbers indicate the style of finish only, as follows:

- A. Hardened, Polished and Plated.
- B. Polished and Plated
- C. Hardened only.
- D. Polished only.
- E. Soft, not Polished.
- F. Hardened and Polished.
- G.
- H. Blued.
- J. Plated only.
- K. Hardened and Plated.
- L. Brass or Gilt.
- M. Oxidized.
- P. Japanned.
- R. Parkerized.

These letters MUST BE USED when they appear in the list, and AFTER the number as in the list.

In this series

- 1 to 1500 and 50001 to 51500 are Screw Numbers
- 1501 to 1800 are Nut Numbers.
- 1801 to 2000 are Roller Numbers.
- 2001 to 50000 and 52001 and upward are numbers of Machine Parts.

The figures in the second column refer only to the plates, illustrating the parts, and are NOT TO BE USED in ordering.

Parts marked with an asterisk (*) are furnished only when repairs are made at factory.

LIST OF PARTS COMPLETE FOR

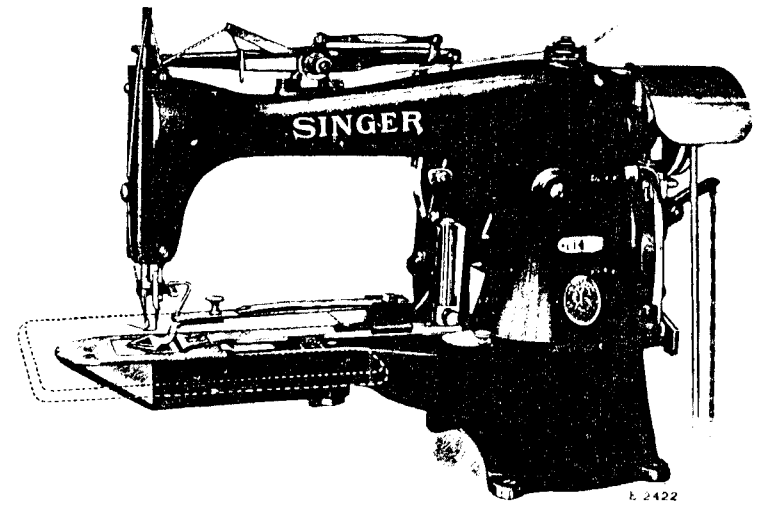

MACHINE No. 114-22

FOR TACKING PAPER TICKETS ON CLOTHING TO DISTINGUISH LOT, COLOR, SIZE, ETC., WHILE IN PROCESS OF MANUFACTURE. MAKES A TRIANGULAR SHAPED TACK CONSISTING OF FOURTEEN STITCHES 5/8 INCH ACROSS THE BASE AND 3/8 INCH FROM THE APEX TO THE BASE. THE LONG STITCH IN THE CENTRE OF THE BASE OF THE TRIANGLE INDICATES THE PLACE AT WHICH TO START TO UNRAVEL THE THREAD FOR DETACHING THE TICKET.

SUPERSEDES 114-20 MACHINE.

OBSOLETE

NO.	PLATE	NAME
*59701	—	Arm with 4449, 59767 and two 164E...
16532	6976	" Dowel Pin.....
4448	6976	" Oil Tube for intermediate bearing .
56015	6976	" " " " oiling 59705 and 59706
880E	6998	" Screw.....
59702	6975	" Shaft (horizontal).....
17703	6981	" " " " Bushing (back) .
50333c	6998	" " " " " "
		Adjusting Screw.....

NO.	PLATE	NAME
1520E	6994	Arm Shaft (horizontal) Bushing (back) Adjusting Screw Nut.....
*1449	—	Arm Shaft (horizontal) Bushing (front).
59703	6976	" " " Gear with two 1036c.....
1036c	6976	Arm Shaft (horizontal) Gear Set Screw.
59704	6976	" " (upright).....
59705	6976	" " " Bushing (lower)...
448c	6992	" " " " " Set Screw.....
59706	6976	Arm Shaft (upright) Bushing (upper)...
448c	6992	" " " " " Set Screw.....
59707	6976	Arm Shaft (upright) Gear (lower) with two 1253c.....
1253c	6976	Arm Shaft (upright) Gear (lower) Set Screw.....
59708	6976	Arm Shaft (upright) Gear (upper) with two 1253c.....
1253c	6976	Arm Shaft (upright) Gear (upper) Set Screw.....
124674	7020	Arm Side Cover.....
190D	6990	" " " Screw.....
18498	6975	Belt Cover.....
59795	6977	" " Bracket with 184E and 59796.
184E	6998	" " " Screw Stud.....
59796	7019	" " " Stud.....
217D	6998	" " Screw.....
39222	6977	" Shifter.....
39223	6976	" " Clamp.....
1255D	6976	" " " Screw.....
62174	7026	Clamp with 1220E and 17928.....
62258	7026	" Arm with 17714.....
62259	—	" " 62258 with 62260 and two 201D.....
17710	7026	Clamp Arm Hinge Plate.....
1176J	7026	" " " " Screw.....
62260	7026	" " Hook.....
201D	7026	" " " Screw.....
59710	6979	" Lifter.....
176D	7009	" " Screw.....
17928	7000	" Position Stud.....
17712	7001	" Pressure Spring.....
17713	7026	" " " Bracket.....
1177D	7026	" " " " Screw..
17714	7026	" " " Guide Block....
1178J	7026	" " " Screw.....

NO.	PLATE	NAME
1220E	7000	Clamp Screw Stud.....
1656J	7000	" Thumb Nut.....
62262	—	Clamp complete, Nos. 1656J, 62174 and 62259.....
*62101	—	Cloth Plate.....
62102	6980	" " Guide Block (left).....
742F	6980	" " " " " Screw...
1547D	6980	" " " " " S c r e w Nut.....
62103	6980	Cloth Plate Guide Block (right).....
3021	6980	" " " " " R i v e t
190D	6990	" " Screw.....
62104	6980	" " Stop.....
26770	6980	" " " Rivet.....
62105	6975	Cloth Plate complete, Nos. 742F, 1547D, 26770, 62101 to 62104 and two 3021..
*62178	—	Cylinder.....
62189	7032	" Bottom Cover.....
62108	6981	" End Cover.....
62190	—	" " " 62108 with 1034D, 62111 to 62113, 62185, 62189 and four 1477D.....
62185	6980	Cylinder End Cover Bracket.....
62111	6980	" " " " Hinge Pin..
1477D	6980	" " " " Screw.....
62112	6980	" " " Hinge.....
1477D	6980	" " " " Screw.....
62113	6980	" " " Spring.....
1034D	6980	" " " " Screw.....
62114	6980	" Top Cover.....
286D	6980	" " " Thumb Screw.....
59711	6981	Face Plate.....
59712	—	Face Plate complete, Nos. 208B, 9544, 9545, 59711 and two each 229D, 2107 and 9543.....
164D	6990	Face Plate Screw.....
2107	6980	" " Thread Guard.....
229D	7027	" " " " Screw.....
9543	6980	" " " Nipper Disc.....
9544	6980	" " " " " Cover..
208D	6980	" " " " " " Screw.....
9545	6980	Face Plate Thread Nipper Disc Spring..
62115	6982	Feed Across Connection Adjusting Stud
1649C	6982	" " " " " Nut (left hand thread).....

NO.	PLATE	NAME
1650c	6982	Feed Across Connection Adjusting Stud Nut (right hand thread).....
63940	---	Feed Across Connecting (lever end) with 42076 and two 896E.....
63941	7027	Feed Across Connection (lever end) 63940 with 55381.....
55381	7027	Feed Across Connecting (lever end) Ball Stud.....
1185c	6982	Feed Across Connection (lever end) Ball Stud Set Screw.....
63942	---	Feed Across Connection (regulator end) with 42076 and two 896E.....
63943	7027	Feed Across Connection (regulator end) 63942 with 63944.....
63944	7027	Feed Across Connection (regulator end) Ball Stud.....
*42076	---	Feed Across Connection Cap.....
896E	7027	" " " " Screw.....
62147	7002	" " Lever with 1185c and 1952.....
17737	7004	" " " Hinge Stud.....
160D	6998	" " " " Clamping Screw.....
62149	7001	Feed Across Lever Plate with 62153.....
62150	7001	" " " " Cover.....
1094F	6985	" " " " Screw.....
55300	6985	" " " " Steady Pin.....
1952	7027	" " " Roller and Stud.....
62151	7002	" " Regulator.....
50599D	7027	" " " Adjusting Screw Stud.....
1676c	6982	Feed Across Regulator Adjusting Screw Stud Nut.....
46244	7027	Feed Across Regulator Adjusting Screw Stud Nut Washer (fibre).....
17738	6982	Feed Across Regulator Adjusting Screw Stud Nut Washer (steel).....
1188D	6998	Feed Across Regulator Hinge Screw.....
62152	7001	" " " Link.....
1189E	7001	" " " " Screw Stud.....
62153	7001	" " " " Stud.....
62284	7030	" Cam with two 1192c and three each 190D, 208D, 227D, 17874 and 62138.....
18415	6987	Feed Cam Driving Worm with 1441c and 1442c.....
1442c	6987	Feed Cam Driving Worm Position Screw.....
1441c	6987	" " " " Set Screw.....

NO.	PLATE	NAME
17797	6977	Feed Cam Driving Worm Wheel with 453c.....
3012	7019	Feed Cam Driving Worm Wheel Pin.....
453c	6987	" " " " " Set Screw.....
18384	7019	Feed Cam Pin.....
1192c	6987	" " Set Screw.....
62155	7002	" " Shaft.....
1653c	6999	" " " Nut.....
39358	7004	" Plate.....
*18445	6989	" " Carrier Bar.....
62156	---	" " " " 18445 with 934J, 1094F, 1195E, 17743, 18368, 62149, 62150, two 55300 and four 17806.....
59730	6987	Feed Plate Carrier Bar Pivot Block.....
50306c	6987	" " " " " " Screw.....
18368	6987	" " " " Plate.....
934J	6987	" " " " " Screw.....
1654c	7027	" " Nut.....
17806	7027	" " Position Stud.....
1195E	7027	" " Screw Stud.....
62157	7002	" Regulator with 1953.....
62148	7002	" " Bracket with 39310 and three 160D.....
*39310	---	Feed Regulator Bracket Cap.....
160D	6998	" " " " Screw.....
8589	7019	" " " Dowel Pin.....
1177D	7026	" " " Screw.....
17744	6987	" " Hinge Stud.....
17743	6987	" " Post.....
1953	7019	" " Roller and Screw Stud with 1655c and 14017.....
1655c	6985	Feed Regulator Roller and Screw Stud Nut.....
14017	6985	Feed Regulator Roller and Screw Stud Nut Washer.....
1190c	6987	Feed Regulator Stop Screw.....
39313	7004	" " Swivel.....
1191D	6987	" " Thumb Screw.....
59731	6990	Knife.....
62124	6975	" Bar with 62130 and two 3021.....
62125	6990	" " Cap.....
164D	6990	" " " Screw.....
62126	6990	Knife Bar Connection with 17917.....
190D	6990	" " " Screw.....
17915	6990	" " " Slide Block.....

NO.	PLATE	NAME
17917	—	Knife Bar Connection Slide Block 17915 with 17916.....
17916	6990	Knife Bar Connection Slide Block Stud.
59734	6990	" " Driving Lever with 223F and 59735.....
1382F	6998	Knife Bar Driving Lever Hinge Screw
1681c	6999	" " " " " "
		Nut.....
59735	6990	Knife Bar Driving Lever Lock Stud
223F	6990	" " " " " "
		Screw.....
62127	6990	Knife Bar Guide.....
1235F	6990	" " " Screw.....
8734	7015	" " Retaining Spring.....
62192	7015	" " " " Bracket....
62128	6990	" Holder with 59739.....
62129	6990	" " Cap with 59739.....
691F	6990	" " " Screw.....
59739	6990	" " " Stud.....
62130	6990	" " Connection.....
3021	6980	" " " Rivet.....
59739	6990	" " Stud.....
236F	6990	" Screw.....
62179	7015	Looper with 34418.....
*59742	—	" Collar.....
59743	6991	" Driving Shaft.....
62131	6991	" " " Bushing.....
52045	6992	" " " " Packing (cotton).....
1148c	7015	Looper Driving Shaft Bushing Set Screw
59745	6991	" " " Collar with two 465c.....
465c	6991	Looper Driving Shaft Collar Set Screw .
59746	6991	" " " Coupling with two 50150c.....
50150c	6991	Looper Driving Shaft Coupling Set Screw
59707	6976	" " " Gear with two 1253c.....
59747	6992	Looper Driving Shaft Gear Cover.....
199D	6990	" " " " " Screw .
1253c	6976	" " " " Set Screw....
59748	6991	" " " Universal Joint....
50150c	6991	" Set Screw.....
62158	7002	" Shaft with 50150c and 59742....
59745	6991	" " Collar with two 465c.....
465c	6991	" " " Set Screw.....
59746	6991	" " Coupling with two 50150c.

NO.	PLATE	NAME
50150c	6991	Looper Shaft Coupling Set Screw.....
59750	6991	" " Eccentric with two 624c...
62132	6991	" " " Connection with 59752 and two 171E.....
*59752	—	Looper Shaft Eccentric Connection Cap.
171E	6991	" " " " " "
		Screw.....
62133	6991	Looper Shaft Eccentric Connection Stud (eccentric).....
1095F	6991	Looper Shaft Eccentric Connection Stud Cap Screw.....
1259c	6991	Looper Shaft Eccentric Connection Stud Set Screw.....
624c	6991	Looper Shaft Eccentric Set Screw.....
62134	6991	" " Slide Block.....
62135	6991	" " " " Cap.....
1186c	6991	" " " " " Screw....
34418	6991	" Washer.....
59756	6989	Needle Bar with 1072F.....
*39203	6992	" " Connecting Link.....
62283	—	" " " " 39203 with 377c, 1518E and 2052.....
377c	6992	Needle Bar Connecting Link Hinge Screw
1518E	6992	" " " " " "
		Nut.....
2052	6992	Needle Bar Connecting Stud with 155c.
155c	6992	" " " " Set Screw.
59757	6992	" " Crank Wheel with 448c and 1293c.....
1293c	6992	Needle Bar Crank Wheel Position Screw
448c	6992	" " " " Set Screw....
59758	6993	" Guard.....
59759	6993	" " Cam with two 465c.....
465c	6991	" " " Set Screw.....
2273	7027	" " Pin.....
59760	6989	" " Shaft.....
59761	6993	" " " Collar with two 465c
465c	6991	" " " " Set Screw..
59762	6993	" " " Crank with 51812 and two 465c.....
51812	6993	Needle Guard Shaft Crank Roller and Stud.....
465c	6991	Needle Guard Shaft Crank Set Screw...
59763	6993	" " " E n d B e a r i n g
59764	6989	" " " " "
		Bracket.....

NO.	PLATE	NAME
2022	7027	Needle Guard Shaft End Bearing Bracket Dowel Pin.....
965D	6993	Needle Guard Shaft End Bearing Bracket Screw.....
1480H	6993	Needle Guard Shaft End Bearing Cap Screw.....
59765	6993	Needle Guard Shaft Spring.....
59766	6993	" " " " Collar with 624c.....
624c	6991	Needle Guard Shaft Spring Collar Set Screw.....
233D	6995	Needle Guard Shaft Spring Screw.....
1072F	6993	" Set Screw.....
2058	6989	Presser Bar.....
17841	6992	" " Collar with two 196e.....
196F	6992	" " " Set Screw.....
17842	6992	" " Guide Bracket with 453c...
453C	6987	" " " " Set Screw..
17843	6981	" " Lifting Lever.....
59767	6996	" " " " Bracket.....
164E	6990	" " " " " Screw
1201D	7006	" " " " Hinge Screw..
17845	7032	" " " " Rod.....
17846	—	" " " " " Chain...
8414	6989	" " Spring.....
17941	6977	Pulley (loose) 2 $\frac{7}{8}$ in. diam.....
17848	6977	" " Bushing.....
2269	6994	" " " Position Pin....
1202D	6998	" " Cap Screw.....
17942	6977	" (tight) 2 $\frac{7}{8}$ in. diam., with 2269..
2022	7027	" " Pin.....
17955	—	Pulleys complete, Nos. 1202b, 1206c, 17848, 17854, 17941 and 17942.....
17853	6994	Starting Lever.....
1262C	6998	" " Hinge Screw.....
1662C	6999	" " " " Nut.....
17886	7032	" " Pitman.....
17854	6994	Stop Cam.....
17855	6994	" " Interlocking Rod.....
124697	—	" " " " Case.....
62136	6977	" " " " " 124697 with 59771 and two 193D.....
62159	—	Stop Cam Interlocking Rod Case 62136 with 1318D, 17855, 17863, 17864, 39222, 39223 and two 1255D.....
59769	6977	Stop Cam Interlocking Rod Case Bracket

NO.	PLATE	NAME
62186	—	Stop Cam Interlocking Rod Case Bracket complete, Nos. 1182E, 1196C, 1204E, 1254C, 1262C, 1508E, 1662C, 17853, 17859, 17861, 17862, 17872, 17873, 59769, 62159 and two 898D.....
62137	—	Stop Cam Interlocking Rod Case Bracket 62186 with 39343, 39344 and two 1186D
21828	6976	Stop Cam Interlocking Rod Case Bracket Dowel Pin.....
50372D	7015	Stop Cam Interlocking Rod Case Bracket Screw.....
1204E	6998	Stop Cam Interlocking Rod Case Hinge Screw.....
17859	6977	Stop Cam Interlocking Rod Case Socket Joint.....
898D	6998	Stop Cam Interlocking Rod Case Socket Joint Cap Screw.....
39343	6981	Stop Cam Interlocking Rod Case Spring (flat).....
430C	6994	Stop Cam Interlocking Rod Case Spring Adjusting Screw.....
1520E	6994	Stop Cam Interlocking Rod Case Spring Adjusting Screw Nut.....
39344	6994	Stop Cam Interlocking Rod Case Spring Bracket with 430C and 1520E.....
1186D	6991	Stop Cam Interlocking Rod Case Spring Bracket Screw.....
17861	6994	Stop Cam Interlocking Rod Case Stop Stud.....
1254C	6998	Stop Cam Interlocking Rod Case Stop Stud Screw Bushing.....
1508E	6999	Stop Cam Interlocking Rod Case Stop Stud Screw Bushing Lock Nut.....
17862	6994	Stop Cam Interlocking Rod Case Stop Stud Spring.....
59771	6994	Stop Cam Interlocking Rod Case Wearing Block.....
193D	7027	Stop Cam Interlocking Rod Case Wearing Block Screw.....
17863	6994	Stop Cam Interlocking Rod Spring.....
17864	6994	" " " " Stop.....
1318D	6994	" " " " " Screw.
3012	7019	" " Pin.....
1206C	6994	" " Screw.....
2102	6995	Tension Disc.....
1560C	6995	" Regulating Thumb Nut.....
50148C	6995	" Screw Stud.....

NO.	PLATE	NAME
42336	6995	Tension Spring.....
13915	6995	“ “ Bushing.....
10145	6995	“ Thread Guide.....
59772	6995	Thread Eyelet (head of arm).....
233b	6995	“ “ “ “ “ Set Screw.....
1743b	6979	“ Nipper Adjusting Thumb Nut..
59773	6995	“ “ Body.....
624c	6991	“ “ “ Set Screw.....
59774	6995	“ “ Cam with two 50150c....
50150c	6991	“ “ “ Set Screw.....
2921	6995	“ “ Disc.....
12162	6995	“ “ “ Guide Pin.....
62169	6979	“ “ “ Spring.....
59775	6995	“ “ Eyelet.....
1527b	6995	“ “ Lock Nut.....
59776	6995	“ “ Stud with 13538.....
13538	6995	“ “ “ Position Pin.....
13539	6995	“ “ “ Roller.....
13540	6995	“ “ “ “ Pin.....
2026	6995	“ “ “ Spring.....
59777	—	Thread Nipper Stud complete, Nos. 13539, 13540 and 59776.....
59778	—	Thread Nipper complete, Nos. 1527b, 1743b, 2026, 59773, 59775, 59777, 62169 and two 2921.....
62138	6987	Thread Pull-off Cam.....
208b	6980	“ “ “ Screw (long).....
227b	7015	“ “ “ “ (short).....
59780	6996	“ “ Driving Lever.....
1196c	6998	“ “ “ “ H i n g e Screw.....
59781	6996	Thread Pull-off Driving Lever Spring...
59782	6996	“ “ Lever.....
59783	6996	“ “ “ Bushing.....
1445h	6996	Thread Pull-off Lever Bushing Screw...
59784	6996	“ “ “ Connection.....
50116b	6996	“ “ “ “ H i n g e Screw (driving lever end).....
50111b	6996	Thread Pull-off Lever Connection Hinge Screw (lever end).....
59785	6996	Thread Pull-off Regulator.....
62170	—	“ Take-up Body with 62172.....
42808	6979	“ “ Roller.....
62171	6979	“ “ “ Cap.....
337b	6979	“ “ “ “ Screw.....
62172	6979	“ “ “ Pin.....

NO.	PLATE	NAME
62173	6979	Thread Take-up complete, Nos. 337b, 42808, 62170 and 62171.....
691f	6990	Thread Take-up Screw.....
39452	6979	“ Wiper Body.....
39453	6979	“ “ “ Finger.....
330b	6979	“ “ “ “ Screw.....
1207b	6979	“ “ “ Hinge Screw.....
59787	6979	“ “ “ Support.....
641c	6979	“ “ “ “ Set Screw.....
39455	6979	“ “ “ Wire.....
39456	6979	“ “ “ “ Clamp.....
1302b	6979	“ “ “ “ “ Screw.....
62139	6997	Throat Plate.....
59799	6997	“ “ Needle Guard.....
208e	6980	“ “ “ “ Screw.....
691f	6990	“ “ Screw.....
59790	6997	“ “ Thread Retainer.....
206e	7024	“ “ “ “ Screw...
17872	6994	Trip Lever.....
1196c	6998	“ “ Hinge Screw.....
17873	6994	“ “ Spring.....
1182e	7027	“ “ “ Screw.....
17874	6987	Tripping Point.....
190b	6990	“ “ “ Screw.....

**LIST OF PARTS COMPLETE
FOR**

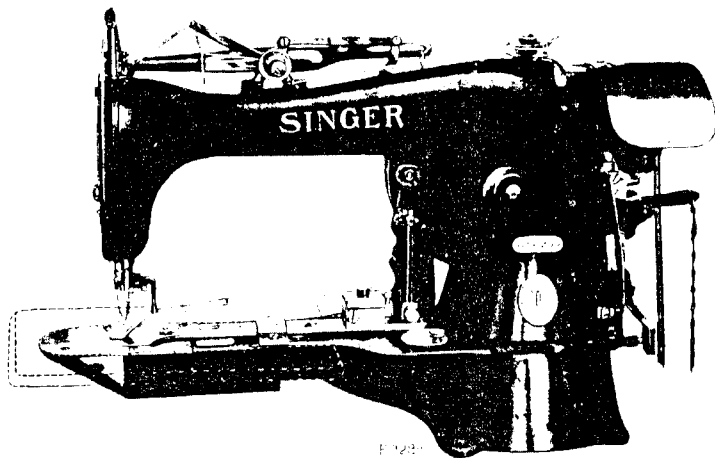

MACHINE No. 114-23

**FOR TACKING PAPER TICKETS ON CLOTHING. MAKES SIX
CROSS STITCHES, INCLUDING THE FASTENING STITCH.
THE WORK HOLDING CLAMP VIBRATES UP THE ARM
INSTEAD OF ACROSS.**

NO.	PLATE	NAME
*62295	—	Arm with 4449, 124606 and two 164E...
16532	6976	" Dowel Pin.....
4448	6976	" Oil Tube for intermediate bearing .
56015	6976	" " " " oiling 59705 and 59706
880E	6998	" Screw.....
59702	6975	" Shaft (horizontal).....
17703	6981	" " " Bushing (back) .
50333c	6998	" " " " " "
		Adjusting Screw.....
1520E	6994	Arm Shaft (horizontal) Bushing (back)
		Adjusting Screw Nut.....
*4449	—	Arm Shaft (horizontal) Bushing (front).
59703	6976	" " " Gear with two
		1036c.....

NO.	PLATE	NAME
1036c	6976	Arm Shaft (horizontal) Gear Set Screw .
59704	6976	" " (upright).....
59705	6976	" " " Bushing (lower)...
448c	6992	" " " " " Set
		Screw.....
59706	6976	Arm Shaft (upright) Bushing (upper)...
448c	6992	" " " " " Set
		Screw.....
59707	6976	Arm Shaft (upright) Gear (lower) with
		two 1253c.....
1253c	6976	Arm Shaft (upright) Gear (lower) Set
		Screw.....
59708	6976	Arm Shaft (upright) Gear (upper) with
		two 1253c.....
1253c	6976	Arm Shaft (upright) Gear (upper) Set
		Screw.....
124674	7020	Arm Side Cover.....
190D	6990	" " " Screw.....
18498	6975	Belt Cover.....
59795	6977	" " Bracket with 184E and 59796
184E	6998	" " " Screw Stud.....
59796	7019	" " " Stud.....
217D	6998	" " Screw.....
39222	6977	" Shifter.....
39223	6976	" " Clamp.....
1255D	6976	" " " Screw.....
124646	7029	Clamp with 1220E and 17928.....
17927	7029	" Arm with 17714 and 63788.....
17710	7026	" " Hinge Plate.....
1176J	7026	" " " " Screw.....
63788	7015	" " Hook.....
59710	6979	" Lifter.....
176D	7009	" " Screw.....
124677	7019	" Locking Device Latch with 704J.
704J	7019	" " " " Clamping
		Screw.....
124678	7020	Clamp Locking Device Latch Shaft
124679	7019	" " " " " "
		Crank.....
124680	7019	Clamp Locking Device Latch Shaft
		Crank Connection.....
1282c	7019	Clamp Locking Device Latch Shaft
		Crank Connection Hinge Screw (lower)
1282c	7019	Clamp Locking Device Latch Shaft
		Crank Connection Hinge Screw (upper)
2269	6994	Clamp Locking Device Latch Shaft
		Crank Pin.....

NO.	PLATE	NAME
17928	7000	Clamp Position Stud.....
17712	7001	" Pressure Spring.....
17713	7026	" " " Bracket.....
1177D	7026	" " " " Screw..
17714	7026	" " " Guide Block....
1178J	7026	" " " Screw.....
1220E	7000	" Screw Stud.....
1656J	7000	" Thumb Nut.....
124647	-----	Clamp complete, Nos. 1656J, 17927 and 124646.....
*62101	-----	Cloth Plate.....
62102	6980	" " Guide Block (left).....
742F	6980	" " " " " S c r e w
1547D	6980	" " " " " " "
		Nut.....
62103	6980	Cloth Plate Guide Block (right).....
3021	6980	" " " " " Rivet..
190D	6990	" " Screw.....
62104	6980	" " Stop.....
26770	6980	" " Rivet.....
62105	6975	Cloth Plate complete, Nos. 742F, 1547D, 26770, 62101 to 62104 and two 3021.
*62177	-----	Cylinder.....
62189	7032	" Bottom Cover.....
62108	6981	" End Cover.....
62190	-----	" " " 62108 with 1034D, 62111 to 62113, 62185, 62189 and four 1477D.....
62185	6980	Cylinder End Cover Bracket.....
62111	6980	" " " " Hinge Pin.
1477D	6980	" " " " Screw.....
62112	6980	" " " Hinge.....
1477D	6980	" " " " Screw.....
62113	6980	" " " Spring.....
1034D	6980	" " " " Screw.....
62114	6980	" Top Cover.....
286D	6980	" " " Thumb Screw.....
59711	6981	Face Plate.....
59712	-----	Face Plate complete, Nos. 208D, 9544, 9545, 59711 and two each 229D, 2107 and 9543.....
164D	6990	Face Plate Screw.....
2107	6980	" " Thread Guard.....
229D	7027	" " " " Screw.....
9543	6980	" " " Nipper Disc.....
9544	6980	" " " " " Cover..

NO.	PLATE	NAME
208D	6980	Face Plate Thread Nipper Disc Cover Screw.....
9545	6980	Face Plate Thread Nipper Disc Spring .
124648	7031	Feed Cam with two 1192c, six each 190D, 17874, 124652 and twelve 335J.....
18415	6987	Feed Cam Driving Worm with 1441c and 1442c.....
1442c	6987	Feed Cam Driving Worm Position Screw
1441c	6987	" " " " Set Screw....
17797	6977	" " " " Wheel with 453c.....
3012	7019	Feed Cam Driving Worm Wheel Pin
453c	6987	" " " " " Set Screw.....
18384	7019	Feed Cam Pin.....
1192c	6987	" " Set Screw.....
59728	6989	" " Shaft.....
1653c	6999	" " " Nut.....
124649	7029	" Plate.....
*18445	6989	Feed Plate Carrier Bar.....
62123	-----	" " " " 18445 with 934J, 1094F, 1195E, 17743, 18368, 62118, 62119, two 55300 and four 17806.....
124650	7032	Feed Plate Carrier Bar Guide.....
190J	6990	" " " " " Screw....
59730	6987	" " " " Pivot Block
50306c	6987	" " " " " " Screw.....
18368	6987	Feed Plate Carrier Bar Plate.....
934J	6987	" " " " " Screw....
62118	6985	" " " " Position Plate with 17741.....
62119	6985	Feed Plate Carrier Bar Position Plate Cover.....
1094F	6985	Feed Plate Carrier Bar Position Plate Screw.....
55300	6985	Feed Plate Carrier Bar Position Plate Steady Pin.....
17741	6985	Feed Plate Carrier Bar Position Plate Stud.....
1654c	7027	Feed Plate Nut.....
17806	7027	" " Position Stud.....
1195E	7027	" " Screw Stud.....
17742	7032	" Regulator with 1953.....
124651	7032	" " Bracket with 17732 and two 160D.....

NO.	PLATE	NAME
*17732	—	Feed Regulator Bracket Cap.....
160D	6998	“ “ “ “ Screw.....
8589	7019	“ “ “ Dowel Pin.....
1177D	7026	“ “ “ Screw.....
17744	6987	“ “ Hinge Stud.....
17743	6987	“ “ Post.....
1953	7019	“ “ Roller and Screw Stud with 1655c and 14017.....
1655c	6985	Feed Regulator Roller and Screw Stud Nut.....
14017	6985	Feed Regulator Roller and Screw Stud Nut Washer.....
1190c	6987	Feed Regulator Stop Screw.....
17745	6987	“ “ Swivel.....
1191D	6987	“ “ Thumb Screw.....
59731	6990	Knife.....
62124	6975	“ Bar with 62130 and two 3021....
62125	6990	“ “ Cap.....
164D	6990	“ “ Screw.....
62126	6990	“ “ Connection with 17917.....
190D	6990	“ “ “ Screw.....
17915	6990	“ “ “ Slide Block.....
17917	—	“ “ “ “ “ 17915 with 17916.....
17916	6990	Knife Bar Connection Slide Block Stud.
59734	6990	“ “ Driving Lever with 223F and 59735.....
1382F	6998	Knife Bar Driving Lever Hinge Screw
1681c	6999	“ “ “ “ “ “ Nut.....
59735	6990	Knife Bar Driving Lever Lock Stud
223F	6990	“ “ “ “ “ “ Screw.....
62127	6990	Knife Bar Guide.....
1235F	6990	“ “ “ Screw.....
8734	7015	“ “ Retaining Spring.....
62192	7015	“ “ “ “ Bracket.....
62128	6990	“ Holder with 59739.....
62129	6990	“ “ Cap with 59739.....
691F	6990	“ “ “ Screw.....
59739	6990	“ “ “ Stud.....
62130	6990	“ “ Connection.....
3021	6980	“ “ “ Rivet.....
59739	6990	“ “ Stud.....
236F	6990	“ Screw.....
62298	7027	Looper with 34418.....
*59742	—	“ Collar.....

NO.	PLATE	NAME
59743	6991	Looper Driving Shaft.....
62131	6991	“ “ “ Bushing.....
52045	6992	“ “ “ “ Packing (cotton).....
1148c	7015	Looper Driving Shaft Bushing Set Screw
59745	6991	“ “ “ Collar with two 465c.....
465c	6991	Looper Driving Shaft Collar Set Screw..
59746	6991	“ “ “ Coupling with two 50150c.....
50150c	6991	Looper Driving Shaft Coupling Set Screw
59707	6976	“ “ “ Gear with two 1253c.....
59747	6992	Looper Driving Shaft Gear Cover.....
190D	6990	“ “ “ “ “ Screw..
1253c	6976	“ “ “ “ Set Screw....
59748	6991	“ “ “ Universal Joint....
50150c	6991	“ Set Screw.....
59749	6989	“ Shaft with 50150c and 59742...
62197	7015	“ “ Ball with two 624c.....
62132	6991	“ “ “ Connection with 59752 and two 171E.....
*59752	—	Looper Shaft Ball Connection Cap
171E	6991	“ “ “ “ “ “ Screw.....
62133	6991	Looper Shaft Ball Connection Stud (eccentric).....
1095F	6991	Looper Shaft Ball Connection Stud Cap Screw.....
1259c	6991	Looper Shaft Ball Connection Stud Set Screw.....
624c	6991	Looper Shaft Ball Set Screw.....
59745	6991	“ “ Collar with two 465c....
465c	6991	“ “ “ Set Screw.....
59746	6991	“ “ Coupling with two 50150c.
50150c	6991	“ “ “ Set Screw.....
62134	6991	“ “ Slide Block.....
62135	6991	“ “ “ “ Cap.....
1186c	6991	“ “ “ “ “ Screw....
34418	6991	“ Washer.....
62299	7020	Needle Bar with 1072F.....
*39203	6992	“ “ Connecting Link.....
62283	—	“ “ “ “ 39203 with 377c, 1518E and 2052.....
377c	6992	Needle Bar Connecting Link Hinge Screw.....

NO.	PLATE	NAME
1518E	6992	Needle Bar Connecting Link Hinge Screw Nut.....
2052	6992	Needle Bar Connecting Stud with 155c.
155c	6992	“ “ “ “ Set Screw.
59757	6992	“ “ Crank Wheel with 448c and 1293c.....
1293c	6992	Needle Bar Crank Wheel Position Screw
448c	6992	“ “ “ “ Set Screw.....
124603	7019	“ “ Thread Retainer Bracket with 460c.....
460c	7019	Needle Bar Thread Retainer Bracket Set Screw.....
42348	7019	Needle Bar Thread Retainer Disc (inside).....
10106	7019	Needle Bar Thread Retainer Disc (outside).....
10107	7019	Needle Bar Thread Retainer Disc Spring
93c	7019	“ “ “ “ “ “ “ “ Screw.....
124604	7019	Needle Bar Thread Retainer Thread Guide.....
124605	—	Needle Bar Thread Retainer complete, Nos. 93c, 10106, 10107, 42348, 124603 and 124604.....
62300	7019	Needle Guard.....
124601	7019	“ “ Cam with two 465c.....
465c	6991	“ “ “ Set Screw.....
2273	7027	“ “ Pin.....
59760	6989	“ “ Shaft.....
59761	6993	“ “ “ Collar with two 465c
465c	6991	“ “ “ “ Set Screw...
124602	7019	“ “ “ Crank with 51812 and two 465c.....
51812	6993	Needle Guard Shaft Crank Roller and Stud.....
465c	6991	Needle Guard Shaft Crank Set Screw...
59763	6993	“ “ “ End Bearing
59764	6989	“ “ “ “ “ “ “ “ Bracket.....
2022	7027	Needle Guard Shaft End Bearing Bracket Dowel Pin.....
965D	6993	Needle Guard Shaft End Bearing Bracket Screw.....
1480H	6993	Needle Guard Shaft End Bearing Cap Screw.....
59765	6993	Needle Guard Shaft Spring.....

NO.	PLATE	NAME
59766	6993	Needle Guard Shaft Spring Collar with 624c.....
624c	6991	Needle Guard Shaft Spring Collar Set Screw.....
233D	6995	Needle Guard Shaft Spring Screw.....
1072F	6993	“ Set Screw.....
2058	6989	Presser Bar.....
17841	6992	“ “ Collar with two 196F.....
196F	6992	“ “ “ Set Screw.....
17842	6992	“ “ Guide Bracket with 453c...
453c	6987	“ “ “ Set Screw...
124681	7020	“ “ Lifting Lever.....
124606	7020	“ “ “ “ Bracket.....
164E	6990	“ “ “ “ “ Screw
1201D	7006	“ “ “ “ Hinge Screw..
17845	7032	“ “ “ “ Rod.....
17846	—	“ “ “ “ “ Chain...
8414	6989	“ “ Spring.....
17941	6977	Pulley (loose) 2 $\frac{3}{8}$ in. diam.....
17848	6977	“ “ Bushing.....
2269	6994	“ “ “ Position Pin....
1202D	6998	“ “ Cap Screw.....
17942	6977	“ (tight) 2 $\frac{3}{8}$ in. diam, with 2269..
2022	7027	“ “ Pin.....
17955	—	Pulleys complete, Nos. 1202D, 1206c, 17848, 17854, 17941 and 17942.....
17853	6994	Starting Lever.....
1262c	6998	“ “ Hinge Screw.....
1662c	6999	“ “ “ “ Nut.....
17886	7032	“ “ Pitman.....
17854	6994	Stop Cam.....
17855	6994	“ “ Interlocking Rod...*
124697	—	“ “ “ “ Case.....
62136	6977	“ “ “ “ “ 124697 with 59771 and two 193D,.....
62159	—	Stop Cam Interlocking Rod Case 62136 with 1318D, 17855, 17863, 17864, 39222, 39223 and two 1255D.....
59769	6977	Stop Cam Interlocking Rod Case Bracket
62186	—	Stop Cam Interlocking Rod Case Bracket complete, Nos. 1182E, 1196c, 1204E, 1254c, 1262c, 1508E, 1662c, 17853, 17859, 17861, 17862, 17872, 17873, 59769, 62159 and two 898D.....
62137	—	Stop Cam Interlocking Rod Case Bracket 62186 with 39343, 39344 and two 1186D

NO.	PLATE	NAME
21828	6976	Stop Cam Interlocking Rod Case Bracket Dowel Pin.....
50372d	7015	Stop Cam Interlocking Rod Case Bracket Screw.....
1204E	6998	Stop Cam Interlocking Rod Case Hinge Screw.....
17859	6977	Stop Cam Interlocking Rod Case Socket Joint.....
898d	6998	Stop Cam Interlocking Rod Case Socket Joint Cap Screw.....
39343	6981	Stop Cam Interlocking Rod Case Spring (flat).....
430c	6994	Stop Cam Interlocking Rod Case Spring Adjusting Screw.....
1520E	6994	Stop Cam Interlocking Rod Case Spring Adjusting Screw Nut.....
39344	6994	Stop Cam Interlocking Rod Case Spring Bracket with 430c and 1520E.....
1186d	6991	Stop Cam Interlocking Rod Case Spring Bracket Screw.....
17861	6994	Stop Cam Interlocking Rod Case Stop Stud.....
1254c	6998	Stop Cam Interlocking Rod Case Stop Stud Screw Bushing.....
1508E	6999	Stop Cam Interlocking Rod Case Stop Stud Screw Bushing Lock Nut.....
17862	6994	Stop Cam Interlocking Rod Case Stop Stud Spring.....
59771	6994	Stop Cam Interlocking Rod Case Wearing Block.....
193D	7027	Stop Cam Interlocking Rod Case Wearing Block Screw.....
17863	6994	Stop Cam Interlocking Rod Spring.....
17864	6994	" " " " Stop.....
1318d	6994	" " " " " Screw.....
3012	7019	" " Pin.....
1206c	6994	" " Screw.....
2102	6995	Tension Disc.....
1560c	6995	" Regulating Thumb Nut.....
50148c	6995	" Screw Stud.....
42336	6995	" Spring.....
13915	6995	" " Bushing.....
10145	6995	" Thread Guide.....
124609	7027	Thread Controller Sleeve.....
124607	7027	" " Spring.....
124608	7027	" " " Collar with 1477F.....

NO.	PLATE	NAME
1477F	6980	Thread Controller Spring Collar Set Screw.....
124610	7027	Thread Controller Stud with 56549 and 124631.....
*124631	—	Thread Controller Stud Collar.....
56549	—	" " " " Pin.....
457c	7027	" " " Set Screw.....
124611	—	Thread Controller complete, Nos. 124607 to 124610.....
*124612	—	Thread Nipper (lower) Blade.....
*124613	—	" " " " Carrier with 124619.....
124614	7028	Thread Nipper (lower) Blade Carrier 124613 with 124612 and two 6037.....
665j	7028	Thread Nipper (lower) Blade Carrier Cap Screw.....
124615	7028	Thread Nipper (lower) Blade Carrier Hinge Stud.....
6037	7028	Thread Nipper (lower) Blade Rivet.....
124652	7032	" " " Cam.....
335j	7027	" " " " Screw.....
124653	7020	" " " Connection.....
124618	7028	" " " " Extension.....
99k	7028	Thread Nipper (lower) Connection Extension Hinge Screw.....
206j	7024	Thread Nipper (lower) Connection Extension Screw.....
124619	7028	Thread Nipper (lower) Connection Hinge Stud.....
124620	7020	Thread Nipper (lower) Driving Arm.....
8554	7019	" " " " " Pin.....
124621	7020	" " " Lever with 237k.....
8554	7019	" " " " Pin.....
237k	7009	" " " " Set Screw.....
124623	7020	" " " " Shaft.....
*124682	7020	" " " " " Bracket.....
1177j	7026	" " " " " " Screw.....
1743d	6979	Thread Nipper (upper) Adjusting Thumb Nut.....
59773	6995	Thread Nipper (upper) Body.....
624c	6991	" " " " Set Screw.....
59774	6995	" " " Cam with two 50150c.....

NO.	PLATE	NAME
50150c	6991	Thread Nipper (upper) Cam Set Screw..
2921	6995	" " " Disc.....
12162	6995	" " " " Guide Pin..
62169	6979	" " " " Spring....
59775	6995	" " " " Eyelet.....
1527D	6995	" " " " Lock Nut.....
59776	6995	" " " " Stud with 13538.
13538	6995	" " " " Position Pin
13539	6995	" " " " Roller.....
13540	6995	" " " " " Pin..
2026	6995	" " " " Spring.....
59777	—	Thread Nipper (upper) Stud complete, Nos. 13539, 13540 and 59776.....
59778	—	Thread Nipper (upper) complete, Nos. 1527D, 1743D, 2026, 59773, 59775, 59777, 62169 and two 2921.....
124625	—	Thread Take-up Body with 62172.....
42808	6979	" " " Roller.....
62171	6979	" " " Cap.....
337D	6979	" " " " Screw.....
62172	6979	" " " " Pin.....
124626	7019	Thread Take-up complete, Nos. 337D, 42808, 62171 and 124625.....
691F	6990	Thread Take-up Screw.....
39452	6979	" Wiper Body.....
39453	6979	" " " Finger.....
330D	6979	" " " " Screw.....
1207D	6979	" " " Hinge Screw.....
59787	6979	" " " Support.....
641C	6979	" " " " Set Screw.
39455	6979	" " " Wire.....
39456	6979	" " " " Clamp.....
1302D	6979	" " " " " Screw.
124627	7024	Throat Plate with 124615.....
124628	7024	" " Needle Guard.....
208E	6980	" " " " Screw.....
691F	6990	" " " Screw.....
17872	6994	Trip Lever.....
1196C	6998	" " Hinge Screw.....
17873	6994	" " Spring.....
1182E	7027	" " " " Screw.....
17874	6987	Tripping Point.....
190D	6990	" " " Screw.....

LIST OF PARTS COMPLETE FOR

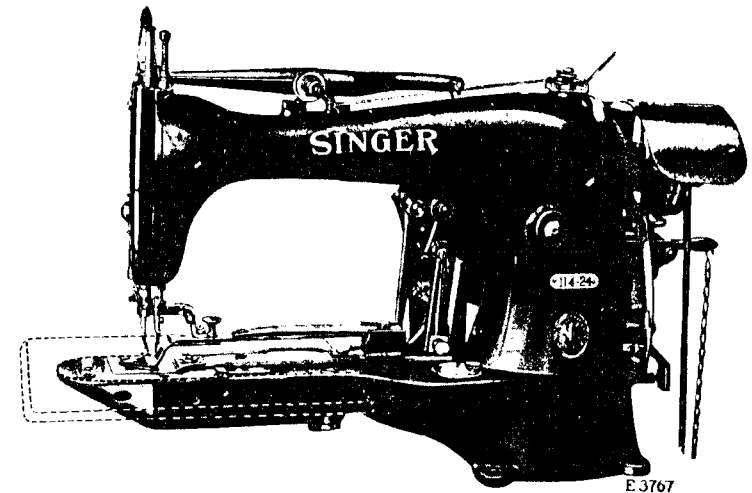

MACHINE No. 114-24

FOR TACKING PAPER TICKETS ON CLOTHING TO DISTINGUISH LOT, COLOR, SIZE, ETC., WHILE IN THE PROCESS OF MANUFACTURE. MAKES A TRIANGULAR SHAPE TACK, CONSISTING OF THIRTEEN STITCHES, $\frac{5}{8}$ IN. ACROSS THE BASE AND $\frac{3}{8}$ IN. FROM THE APEX TO THE BASE. FITTED WITH IMPROVED THREAD CONTROLLING MECHANISM AND THREAD NIPPING DEVICE TO HOLD THE END OF THE THREAD UNTIL THE FIRST STITCH IS MADE; ALSO AN IMPROVED THREAD CUTTER THAT LEAVES A LONG END TO UNRAVEL THE THREAD IN DETACHING THE TICKET. SUPERSEDES 114-22 MACHINE.

NO.	PLATE	NAME
*62295	—	Arm with 4449, 124606 and two 164E...
16532	6976	" Dowel Pin.....
4448	6976	" Oil Tube for intermediate bearing .
56015	6976	" " " " oiling 59705 and 59706
880E	6998	" Screw.....
59702	6975	" Shaft (horizontal).....
17703	6981	" " " Bushing (back)

NO.	PLATE	NAME
50333c	6998	Arm Shaft (horizontal) Bushing (back) Adjusting Screw.....
1520E	6994	Arm Shaft (horizontal) Bushing (back) Adjusting Screw Nut.....
*4449	—	Arm Shaft (horizontal) Bushing (front).
59703	6976	" " " Gear with two 1036c.....
1036c	6976	Arm Shaft (horizontal) Gear Set Screw .
59704	6976	" " (upright).....
59705	6976	" " " Bushing (lower)...
448c	6992	" " " " " Set Screw.....
59706	6976	Arm Shaft (upright) Bushing (upper)...
448c	6992	" " " " " Set Screw.....
59707	6976	Arm Shaft (upright) Gear (lower) with two 1253c.....
1253c	6976	Arm Shaft (upright) Gear (lower) Set Screw.....
59708	6976	Arm Shaft (upright) Gear (upper) with two 1253c.....
1253c	6976	Arm Shaft (upright) Gear (upper) Set Screw.....
124674	7020	Arm Side Cover.....
190D	6990	" " " Screw.....
18498	6975	Belt Cover.....
59795	6977	" " Bracket with 184E and 59796.
184E	6998	" " " Screw Stud.....
59796	7019	" " " Stud.....
217D	6998	" " " Screw.....
39222	6977	" Shifter.....
39223	6976	" " Clamp.....
1255D	6976	" " " Screw.....
62174	7026	Clamp with 1220E and 17928.....
62258	7026	" Arm with 17714.....
62259	—	Clamp Arm 62258 with 62260 and two 201D.....
17710	7026	Clamp Arm Hinge Plate.....
1176J	7026	" " " " Screw.....
62260	7026	" " Hook.....
201D	7026	" " " Screw.....
62261	7026	" Lifter.....
176D	7009	" " Screw.....
124677	7019	" Locking Device Latch with 704J.
704J	7019	" " " " Clamping Screw.....

NO.	PLATE	NAME
124678	7020	Clamp Locking Device Latch Shaft
124679	7019	" " " " " "
		Crank.....
124680	7019	Clamp Locking Device Latch Shaft Crank Connection.....
1282c	7019	Clamp Locking Device Latch Shaft Crank Connection Hinge Screw (lower)
1282c	7019	Clamp Locking Device Latch Shaft Crank Connection Hinge Screw (upper)
2269	6994	Clamp Locking Device Latch Shaft Crank Pin.....
17928	7000	Clamp Position Stud.....
17712	7001	" Pressure Spring.....
17713	7026	" " " Bracket.....
1177D	7026	" " " " Screw..
17714	7026	" " " Guide Block....
1178J	7026	" " " Screw.....
1220E	7000	" Screw Stud.....
1656J	7000	" Thumb Nut.....
62262	—	Clamp complete, Nos. 1656J, 62174 and 62259.....
*62101	—	Cloth Plate.....
62102	6980	" " Guide Block (left).....
742F	6980	" " " " " S c r e w
1547D	6980	" " " " " "
		Nut.....
62103	6980	Cloth Plate Guide Block (right).....
3021	6980	" " " " " Rivet..
190D	6990	" " Screw.....
62104	6980	" " Stop.....
26770	6980	" " " Rivet.....
62105	6975	Cloth Plate complete, Nos. 742F, 1547D, 26770, 62101 to 62104 and two 3021..
*62178	—	Cylinder.....
62189	7032	" Bottom Cover.....
62108	6981	" End Cover.....
62190	—	" " " 62108 with 1034D, 62111 to 62113, 62185, 62189 and four 1477D.....
62185	6980	Cylinder End Cover Bracket.....
62111	6980	" " " " Hinge Pin.
1477D	6980	" " " " Screw.....
62112	6980	" " " Hinge.....
1477D	6980	" " " " Screw.....
62113	6980	" " " Spring.....
1034D	6980	" " " " Screw.....
62114	6980	" Top Cover.....

NO.	PLATE	NAME
286D	6980	Cylinder Top Cover Thumb Screw
59711	6981	Face Plate
59712	—	Face Plate complete, Nos. 208D, 9544, 9545, 59711 and two each 229D, 2107 and 9543
164D	6990	Face Plate Screw
2107	6980	“ “ Thread Guard
229D	7027	“ “ “ “ Screw
9543	6980	“ “ “ Nipper Disc
9544	6980	“ “ “ “ Cover
208D	6980	Face Plate Thread Nipper Disc Cover Screw
9545	6980	Face Plate Thread Nipper Disc Spring . .
62115	6982	Feed Across Connection Adjusting Stud.
1649c	6982	“ “ “ “ “ Nut (left hand thread)
1650c	6982	Feed Across Connection Adjusting Stud Nut (right hand thread)
63940	—	Feed Across Connection (lever end) with 42076 and two 896E
63941	7027	Feed Across Connection (lever end) 63940 with 55381
55381	7027	Feed Across Connection (lever end) Ball Stud
1185c	6982	Feed Across Connection (lever end) Ball Stud Set Screw
63942	—	Feed Across Connection (regulator end) with 42076 and two 896E
63943	7027	Feed Across Connection (regulator end) 63942 with 63944
63944	7027	Feed Across Connection (regulator end) Ball Stud
*42076	—	Feed Across Connection Cap
896E	7027	“ “ “ “ Screw
62147	7002	“ “ Lever with 1185c and 1952.
17737	7004	“ “ “ Hinge Stud
160D	6998	“ “ “ “ “ Clamping Screw
62149	7001	Feed Across Lever Plate with 62153
124660	7028	“ “ “ “ Cover
1094F	6985	“ “ “ “ Screw
55300	6985	“ “ “ “ Steady Pin
1952	7027	“ “ “ Roller and Stud
62151	7002	“ “ Regulator
50599D	7027	“ “ “ Adjusting Screw Stud

NO.	PLATE	NAME
1676c	6982	Feed Across Regulator Adjusting Screw Stud Nut
46244	7027	Feed Across Regulator Adjusting Screw Stud Nut Washer (fibre)
17738	6982	Feed Across Regulator Adjusting Screw Stud Nut Washer (steel)
1188D	6998	Feed Across Regulator Hinge Screw
62152	7001	“ “ “ Link
1189E	7001	“ “ “ “ Screw Stud.
62153	7001	“ “ “ “ Stud
124661	7031	“ Cam with two 1192c, three each 190D, 17874, 124616, 124622 and twelve 335J
18415	6987	Feed Cam Driving Worm with 1441c and 1442c
1442c	6987	Feed Cam Driving Worm Position Screw
1441c	6987	“ “ “ “ Set Screw
17797	6977	“ “ “ “ Wheel with 453c
3012	7019	Feed Cam Driving Worm Wheel Pin
453c	6987	“ “ “ “ “ Set Screw
18384	7019	Feed Cam Pin
1192c	6987	“ “ Set Screw
62155	7002	“ “ Shaft
1653c	6999	“ “ “ Nut
62176	7028	“ Plate
*18445	6989	“ “ Carrier Bar
124662	—	“ “ “ “ 18445 with 934J, 1094F, 1195E, 17743, 18368, 62149, 124660, two 55300 and four 17806
59730	6987	Feed Plate Carrier Bar Pivot Block
50306c	6987	“ “ “ “ “ “ Screw
18368	6987	Feed Plate Carrier Bar Plate
934J	6987	“ “ “ “ “ Screw
1654c	7027	“ “ Nut
17806	7027	“ “ Position Stud
1195E	7027	“ “ Screw Stud
62157	7002	“ Regulator with 1953
62148	7002	“ “ Bracket with 39310 and three 160D
*39310	—	Feed Regulator Bracket Cap
160D	6998	“ “ “ “ “ Screw
8589	7019	“ “ “ Dowel Pin
1177D	7026	“ “ “ Screw
17744	6987	“ “ Hinge Stud

NO.	PLATE	NAME
17743	6987	Feed Regulator Post.....
1953	7019	" " Roller and Screw Stud with 1655c and 14017.....
1655c	6985	Feed Regulator Roller and Screw Stud Nut.....
14017	6985	Feed Regulator Roller and Screw Stud Nut Washer.....
1190c	6987	Feed Regulator Stop Screw.....
39313	7004	" " Swivel.....
1191D	6987	" " Thumb Screw.....
124684	7028	Knife.....
208D	6980	" Screw.....
17718	6979	" " Washer.....
124666	7027	Looper with 34418 and 124675.....
*59742	—	" Collar.....
59743	6991	" Driving Shaft.....
62131	6991	" " " Bushing.....
52045	6992	" " " " Packing (cotton).....
1148c	7015	Looper Driving Shaft Bushing Set Screw
59745	6991	" " " Collar with two 465c.....
465c	6991	Looper Driving Shaft Collar Set Screw..
59746	6991	" " " Coupling with two 50150c.....
50150c	6991	Looper Driving Shaft Coupling Set Screw
59707	6976	" " " Gear with two 1253c.....
59747	6992	Looper Driving Shaft Gear Cover.....
190D	6990	" " " " " Screw
1253c	6976	" " " " Set Screw...
59748	6991	" " " Universal Joint...
50150c	6991	" Set Screw.....
62158	7002	" Shaft with 50150c and 59742....
59745	6991	" " Collar with two 465c.....
465c	6991	" " " Set Screw.....
59746	6991	" " Coupling with two 50150c.
50150c	6991	" " " Set Screw.....
59750	6991	" " Eccentric with two 624c..
62132	6991	" " " Connection with 59752 and two 171E.....
*59752	—	Looper Shaft Eccentric Connection Cap
171E	6991	" " " " " "
		Screw.....
62133	6991	Looper Shaft Eccentric Connection Stud (eccentric).....

NO.	PLATE	NAME
1095F	6991	Looper Shaft Eccentric Connection Stud Cap Screw.....
1259c	6991	Looper Shaft Eccentric Connection Stud Set Screw.....
624c	6991	Looper Shaft Eccentric Set Screw.....
62134	6991	" " Slide Block.....
62135	6991	" " " " Cap.....
1186c	6991	" " " " " Screw...
124675	7027	" Thread Retaining Pin.....
34418	6991	" Washer.....
59756	6989	Needle Bar with 1072F.....
*39203	6992	" " Connecting Link.....
62283	—	" " " " 39203 with 377c, 1518E and 2052.....
377c	6992	Needle Bar Connecting Link Hinge Screw.....
1518E	6992	Needle Bar Connecting Link Hinge Screw Nut.....
2052	6992	Needle Bar Connecting Stud with 155c.
155c	6992	" " " " Set Screw..
59757	6992	" " Crank Wheel with 448c and 1293c.....
1293c	6992	Needle Bar Crank Wheel Position Screw
448c	6992	" " " " Set Screw....
124603	7019	" " Thread Retainer Bracket with 460c.....
460c	7019	Needle Bar Thread Retainer Bracket Set Screw.....
42348	7019	Needle Bar Thread Retainer Disc (inside)
10106	7019	" " " " " (out- side).....
10107	7019	Needle Bar Thread Retainer Disc Spring
93c	7019	" " " " " "
		Screw.....
124604	7019	Needle Bar Thread Retainer Thread Guide.....
124605	—	Needle Bar Thread Retainer complete, Nos. 93c, 10106, 10107, 42348, 124603 and 124604.....
62300	7019	Needle Guard.....
59759	6993	" " Cam with two 465c.....
465c	6991	" " " Set Screw.....
2273	7027	" " Pin.....
59760	6989	" " Shaft.....
59761	6993	" " " Collar with two 465c
465c	6991	" " " " Set Screw...

NO.	PLATE	NAME
59762	6993	Needle Guard Shaft Crank with 51812 and two 465c.....
51812	6993	Needle Guard Shaft Crank Roller and Stud.....
465c	6991	Needle Guard Shaft Crank Set Screw...
59763	6993	" " " End Bearing
59764	6989	" " " " " " " Bracket.....
2022	7027	Needle Guard Shaft End Bearing Bracket Dowel Pin.....
965D	6993	Needle Guard Shaft End Bearing Bracket Screw.....
1480H	6993	Needle Guard Shaft End Bearing Cap Screw.....
59765	6993	Needle Guard Shaft Spring.....
59766	6993	" " " " Collar with 624c.....
624c	6991	Needle Guard Shaft Spring Collar Set Screw.....
233D	6995	Needle Guard Shaft Spring Screw.....
1072F	6993	" Set Screw.....
2058	6989	Presser Bar.....
17841	6992	" " Collar with two 196F.....
196F	6992	" " " Set Screw.....
17842	6992	" " Guide Bracket with 453c...
453c	6987	" " " " Set Screw...
124681	7020	" " Lifting Lever.....
124606	7020	" " " " Bracket.....
164E	6990	" " " " " Screw
1201D	7006	" " " " Hinge Screw..
17845	7032	" " " " Rod.....
17846	—	" " " " Chain...
8414	6989	" " Spring.....
17941	6977	Pulley (loose) 2 $\frac{1}{8}$ in. diam.....
17848	6977	" " Bushing.....
2269	6994	" " " Position Pin....
1202D	6998	" " Cap Screw.....
17942	6977	" (tight) 2 $\frac{1}{8}$ in. diam., with 2269.
2022	7027	" " Pin.....
17955	—	Pulleys complete, Nos. 1202D, 1206c, 17848, 17854, 17941 and 17942.....
17853	6994	Starting Lever.....
1262c	6998	" " Hinge Screw.....
1662c	6999	" " " Nut.....
17886	7032	" " Pitman.....
17854	6994	Stop Cam.....
17855	6994	" " Interlocking Rod.....

NO.	PLATE	NAME
124697	—	Stop Cam Interlocking Rod Case.....
62136	6977	" " " " " 124697 with 59771 and two 193D.....
62159	—	Stop Cam Interlocking Rod Case 62136 with 1318D, 17855, 17863, 17864, 39222, 39223 and two 1255D.....
59769	6977	Stop Cam Interlocking Rod Case Bracket
62186	—	Stop Cam Interlocking Rod Case Bracket complete, Nos. 1182E, 1196c, 1204E, 1254c, 1262c, 1508E, 1662c, 17853, 17859, 17861, 17862, 17872, 17873, 59769, 62159 and two 898D.....
62137	—	Stop Cam Interlocking Rod Case Bracket 62186 with 39343, 39344 and two 1186D
21828	6976	Stop Cam Interlocking Rod Case Bracket Dowel Pin.....
50372D	7015	Stop Cam Interlocking Rod Case Bracket Screw.....
1204E	6998	Stop Cam Interlocking Rod Case Hinge Screw.....
17859	6977	Stop Cam Interlocking Rod Case Socket Joint.....
898D	6998	Stop Cam Interlocking Rod Case Socket Joint Cap Screw.....
39343	6981	Stop Cam Interlocking Rod Case Spring (flat).....
430c	6994	Stop Cam Interlocking Rod Case Spring Adjusting Screw.....
1520E	6994	Stop Cam Interlocking Rod Case Spring Adjusting Screw Nut.....
39344	6994	Stop Cam Interlocking Rod Case Spring Bracket with 430c and 1520E.....
1186D	6991	Stop Cam Interlocking Rod Case Spring Bracket Screw.....
17861	6994	Stop Cam Interlocking Rod Case Stop Stud.....
1254c	6998	Stop Cam Interlocking Rod Case Stop Stud Screw Bushing.....
1508E	6999	Stop Cam Interlocking Rod Case Stop Stud Screw Bushing Lock Nut.....
17862	6994	Stop Cam Interlocking Rod Case Stop Stud Spring.....
59771	6994	Stop Cam Interlocking Rod Case Wearing Block.....
193D	7027	Stop Cam Interlocking Rod Case Wearing Block Screw.....

NO.	PLATE	NAME
17863	6994	Stop Cam Interlocking Rod Spring
17864	6994	“ “ “ “ Stop
1318D	6994	“ “ “ “ “ Screw
3012	7019	“ “ Pin
1206c	6994	“ “ Screw
2102	6995	Tension Disc
1560c	6995	“ Regulating Thumb Nut
50148c	6995	“ Screw Stud
42336	6995	“ Spring
13915	6995	“ “ Bushing
10145	6995	“ Thread Guide
124609	7027	Thread Controller Sleeve
124607	7027	“ “ Spring
124608	7027	“ “ “ Collar with 1477F
1477F	6980	Thread Controller Spring Collar Set Screw
124610	7027	Thread Controller Stud with 56549 and 124631
*124631	-----	Thread Controller Stud Collar
56549	-----	“ “ “ “ Pin
457c	7027	“ “ “ “ Set Screw
124611	-----	Thread Controller complete, Nos. 124607 to 124610
*124612	-----	Thread Nipper (lower) Blade
*124613	-----	“ “ “ “ Carrier with 124619
124614	7028	Thread Nipper (lower) Blade Carrier 124613 with 124612 and two 6037
665j	7028	Thread Nipper (lower) Blade Carrier Cap Screw
124615	7028	Thread Nipper (lower) Blade Carrier Hinge Stud
6037	7028	Thread Nipper (lower) Blade Rivet
124616	7020	“ “ “ “ Cam
335j	7027	“ “ “ “ Screw
124653	7020	“ “ “ “ Connection
124618	7028	“ “ “ “ “ Ex- tension
99k	7028	Thread Nipper (lower) Connection Ex- tension Hinge Screw
206j	7024	Thread Nipper (lower) Connection Ex- tension Screw
124619	7028	Thread Nipper (lower) Connection Hinge Stud
124620	7020	Thread Nipper (lower) Driving Arm
8554	7019	“ “ “ “ “ Pin

NO.	PLATE	NAME
124621	7020	Thread Nipper (lower) Lever with 237k . . .
124622	7020	“ “ “ “ Guide
335j	7027	“ “ “ “ “ Screw
8554	7019	“ “ “ “ Pin
237k	7009	“ “ “ “ Set Screw
124623	7020	“ “ “ “ Shaft
*124682	7020	“ “ “ “ “ Bracket 1177j 7026 “ “ “ “ “ “
1743D	6979	Screw Thread Nipper (upper) Adjusting Thumb Nut
59773	6995	Thread Nipper (upper) Body
624c	6991	“ “ “ “ Set Screw
59774	6995	“ “ “ “ Cam with two 50150c
50150c	6991	Thread Nipper (upper) Cam Set Screw . .
2921	6995	“ “ “ “ Disc
12162	6995	“ “ “ “ Guide Pin
62169	6979	“ “ “ “ Spring
59775	6995	“ “ “ “ Eyelet
1527D	6995	“ “ “ “ Lock Nut
59776	6995	“ “ “ “ Stud with 13538
13538	6995	“ “ “ “ Position Pin
13539	6995	“ “ “ “ Roller
13540	6995	“ “ “ “ “ Pin
2026	6995	“ “ “ “ Spring
59777	-----	Thread Nipper (upper) Stud complete, Nos. 13539, 13540 and 59776
59778	-----	Thread Nipper (upper) complete, Nos. 1527D, 1743D, 2026, 59773, 59775, 59777, 62169 and two 2921
124685	7028	Thread Pull-off
62124	6975	“ “ “ “ Bar with 62130 and two 3021
62125	6990	Thread Pull-off Bar Cap
164D	6990	“ “ “ “ Screw
62126	6990	“ “ “ “ Connection with 17917
190D	6990	Thread Pull-off Bar Connection Screw . .
17915	6990	“ “ “ “ “ Slide Block
17917	-----	Thread Pull-off Bar Connection Slide Block 17915 with 17916
17916	6990	Thread Pull-off Bar Connection Slide Block Stud
59734	6990	Thread Pull-off Bar Driving Lever with 223F and 59735

NO.	PLATE	NAME
1382F	6998	Thread Pull-off Bar Driving Lever Hinge Screw.....
1681c	6999	Thread Pull-off Bar Driving Lever Hinge Screw Nut.....
59735	6990	Thread Pull-off Bar Driving Lever Lock Stud.....
223F	6990	Thread Pull-off Bar Driving Lever Lock Stud Screw.....
124686	7028	Thread Pull-off Bar Guide and Knife Holder.....
1235F	6990	Thread Pull-off Bar Guide Screw.....
8734	7015	" " " Retaining Spring
62192	7015	" " " " " Bracket.....
62128	6990	Thread Pull-off Holder with 59739.....
62129	6990	" " " Cap with 59739.
691F	6990	" " " " Screw.....
59739	6990	" " " " Stud.....
62130	6990	" " " Connection.....
3021	6980	" " " " Rivet
59739	6990	" " " Stud.....
236F	6990	" " Screw.....
124625	—	Take-up Body with 62172.....
42808	6979	" " Roller.....
62171	6979	" " " Cap.....
337D	6979	" " " " Screw.....
62172	6979	" " " Pin.....
124626	7019	Thread Take-up complete, Nos. 337D, 42808, 62171 and 124625.....
691F	6990	Thread Take-up Screw.....
39452	6979	" Wiper Body.....
39453	6979	" " " Finger.....
330D	6979	" " " " Screw.....
1207D	6979	" " " Hinge Screw.....
59787	6979	" " " Support.....
641c	6979	" " " " Set Screw.
39455	6979	" " " Wire.....
39456	6979	" " " " Clamp.....
1302D	6979	" " " " " Screw.
124627	7024	Throat Plate with 124615.....
59799	7024	" " Needle Guard.....
208E	6980	" " " " Screw.....
691F	6990	" " Screw.....
59790	7024	" " Thread Retainer.....
206E	7024	" " " " Screw...
17872	6994	Trip Lever.....
1196c	6998	" " Hinge Screw.....

NO.	PLATE	NAME
17873	6994	Trip Lever Spring.....
1182E	7027	" " " Screw.....
17874	6987	Tripping Point.....
190D	6990	" " Screw.....

ATTACHMENTS AND ACCESSORIES

NO.	PLATE	NAME
18419	—	Cylinder Base Plate with two 453c.....
18420	7006	" " " Hinge Connection
18423	7006	" " " " " Hinge Pin.....
453c	6987	Cylinder Base Plate Hinge Connection Hinge Pin Set Screw.....
18424	7005	Cylinder Base Plate (hinged) complete, Nos. 18419, two each 18420, 18423, three wood screws 1¼ in. No. 12 and four 134D.....
134D	7006	Cylinder Base Plate Screw.....
120346	7007	Oiler (copper plated) with 120347.....
120347	7007	" Spout, 9 in. long.....
11831	7007	Screw Driver (large).....
26026	7007	" " (small).....
4822	7007	Wrench for 1547.....
10875	7007	" " 1518, 1520 and 1662.....
17905	7007	" " 1176, 1178, 1654, 1655 and 1681.....
25200	7007	Wrench for 1527.....
27662	7007	" " 1254 and 1508.....

PROTECTOR

NO.	PLATE	NAME
39489	7008	Arm with 39490.....
160c	7009	" Clamping Screw.....
39490	—	Blade.....
39491	7008	Bracket with two each 426c and 448c...
426c	7009	" Adjusting Screw.....
50351D	7009	" Screw.....
39492	7009	Crank with 160c.....
39493	7009	" Bracket with 1120c and two 454c
454c	7009	" " Set Screw.....
52598	7009	" Hinge Stud.....
1120c	7009	" " " Set Screw.....
39494	7008	Rod.....
15261	7009	" Collar with 237F.....

PROTECTOR

NO.	PLATE	NAME
	237F 7009	Rod Collar Set Screw.....
39495	7009	“ Connection.....
	176D 7009	“ “ Screw.....
	1099F 7009	“ Screw Stud.....
39496	7008	“ Sleeve.....
	448C 7009	“ “ Set Screw.....
39497	7009	“ Spring.....
15261	7009	“ “ Collar with 237F.....
	237F 7009	“ “ “ Set Screw.....
63753	—	Protector (front of needle) Nos. 1099F, 39489, 39491 to 39494, 39496, 39497, 52598 and two 15261.....
39498	—	Protector (front of needle) complete, Nos. 39495, 63753 and two each 176D and 50351D.....

STARTING LEVER AND FOOT LIFTER PARTS

NO.	PLATE	NAME
17876	7005	Treadle with 443c.....
17877	7005	“ Pitman Rod (lower).....
17878	7005	“ “ “ (upper).....
17879	7005	“ “ “ Clamp with two 161D.....
	161D 6998	Treadle Pitman Rod Clamp Screw.....
17880	7005	Treadle Pitman complete, Nos. 17877 to 17879.....
17881	7006	Treadle Shaft.....
	443c 7015	“ “ Set Screw.....
17882	7006	“ Spring.....
17883	7005	“ Stand.....
17884	—	Treadle complete, Nos. 17876, 17881 to 17883 and two wood screws 1 in. No. 10
17885	—	Treadle and Pitman complete, Nos. 17880 and 17884.....

STAND FOR ELECTRIC MOTOR

NO.	PLATE	NAME
46645	—	Belt, size $\frac{1}{4}$ in., length 45 $\frac{1}{2}$ in. with 25127.....
25127	7006	Belt Hook.....
46667	7033	Brace.....
	748E 7006	“ Screw.....

STAND

NO.	PLATE	NAME
46522	7033	Leg.....
4881	7033	Motor Treadle.....
46614	7033	“ “ Bracket (left).....
	1177E 7026	“ “ “ “ Screw....
46615	7033	“ “ “ (right).....
	1177E 7026	“ “ “ “ Screw....
4879	7010	“ “ Chain Connecting Link..
4882	7010	“ “ Shaft.....
4883	7010	“ “ Spring.....
46616	7033	Motor Treadle complete, Nos. 4879, 4881 to 4883, 46614 and 46615.....
	4881 7033	Starting Treadle.....
46614	7033	“ “ Bracket (left).....
	1177E 7026	“ “ “ “ Screw....
46615	7033	“ “ “ (right).....
	1177E 7026	“ “ “ “ Screw..
4879	7010	“ “ Chain Connecting Link
4882	7010	“ “ Shaft.....
4883	7010	“ “ Spring.....
46616	7033	Starting Treadle complete, Nos. 4879, 4881 to 4883, 46614 and 46615.....
46642	7033	Treadle Support.....
46643	—	“ “ 46642 with two 46616 and four 1177E.....
	780E 6998	Treadle Support Bolt with 1600E.....
	1600E 6999	“ “ “ Nut.....
25086	7033	Wrench.....
25286	—	Stand (iron work) complete, Nos. 25086, 46643, 46667, two each 780E, 46522 and four 748E.....

TABLE BELT GUIDE

NO.	PLATE	NAME
39218	7005	Belt Guide with two 168E.....
	168E 6998	“ “ Set Screw.....
17892	7005	Bracket with two 153E.....
17893	7005	Pulley.....
39219	7005	“ Shaft (long) with 17896.....
39220	7005	“ “ (short) with 17896.....
17896	7006	“ “ Plug.....
	153E 6998	“ “ Set Screw.....
39221	—	Table Belt Guide complete, Nos. 17892, 39219, 39220, two each 17893, 39218 and three wood screws $\frac{1}{4}$ in. No. 12.

OBSOLETE PARTS

NO.	PLATE	NAME
145F	6982	Feed Across Lever Socket Bearing Block Set Screw
1528J	6982	Feed Across Lever Socket Bearing Block Set Screw Nut
1187E	6982	Feed Across Regulator Adjusting Screw Stud
17739	6982	Feed Across Regulator Adjusting Screw Stud Sleeve
124663	7028	Knife for 114-24 Machine
208D	6980	" Clamping Screw
124664	7028	" Holder with 208b, for 114-24 Ma- chine
203D	7027	Knife Holder Screw for 124664
59741	6993	Looper with 34418, for 114-22 Machine, use 62162
62162	—	Looper with 34418, for 114-22 Machine, use 62179
124624	7032	Thread Nipper (lower) Lever Shaft Bracket for 114-23 and 114-24 Ma- chines
124667	7028	Thread Pull-off for 114-24 Machine
59789	6993	Throat Plate Needle Guard, use 59799

PLATE 2836—ONE-FOURTH SIZE

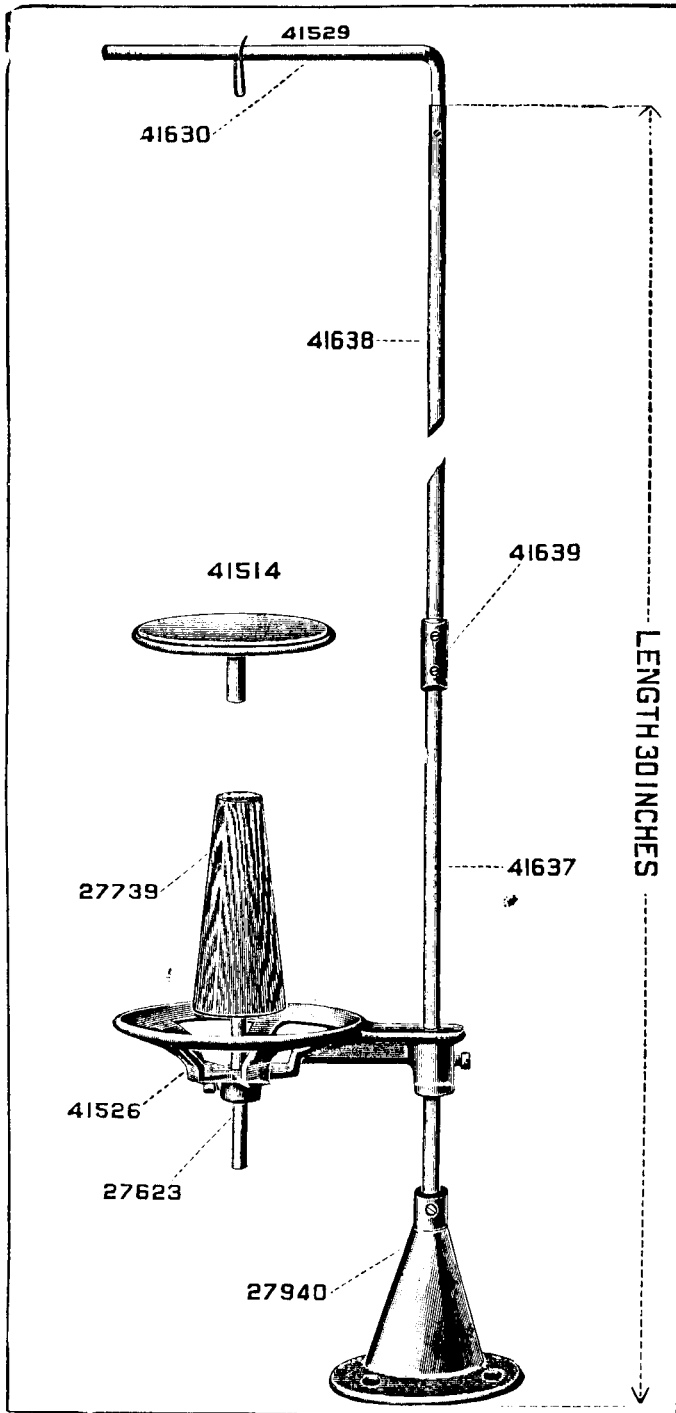
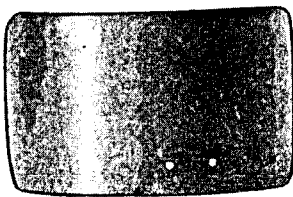

PLATE 6975—ONE-FOURTH SIZE

59702



18498



62124



62105

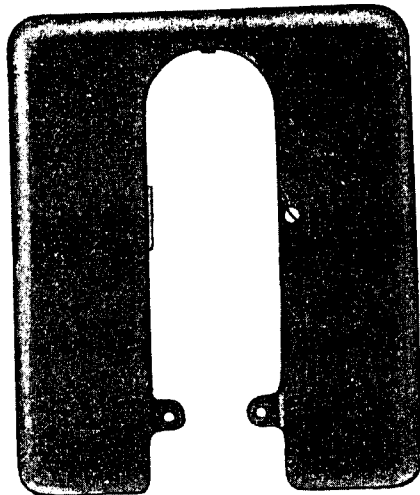

62182

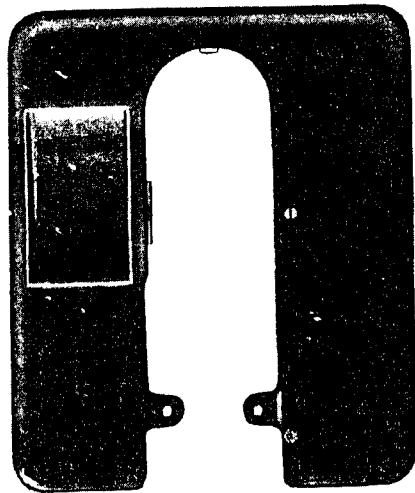
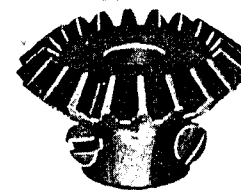

PLATE 6976—FULL SIZE

59704



59708



59703

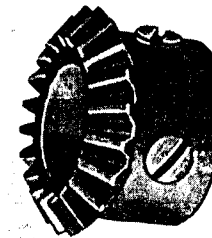

59706



1036



39223

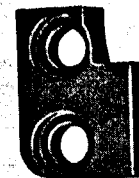

1253



4448



1255



59705



56015



59707



16532



21828



PLATE 6977—ONE-HALF SIZE

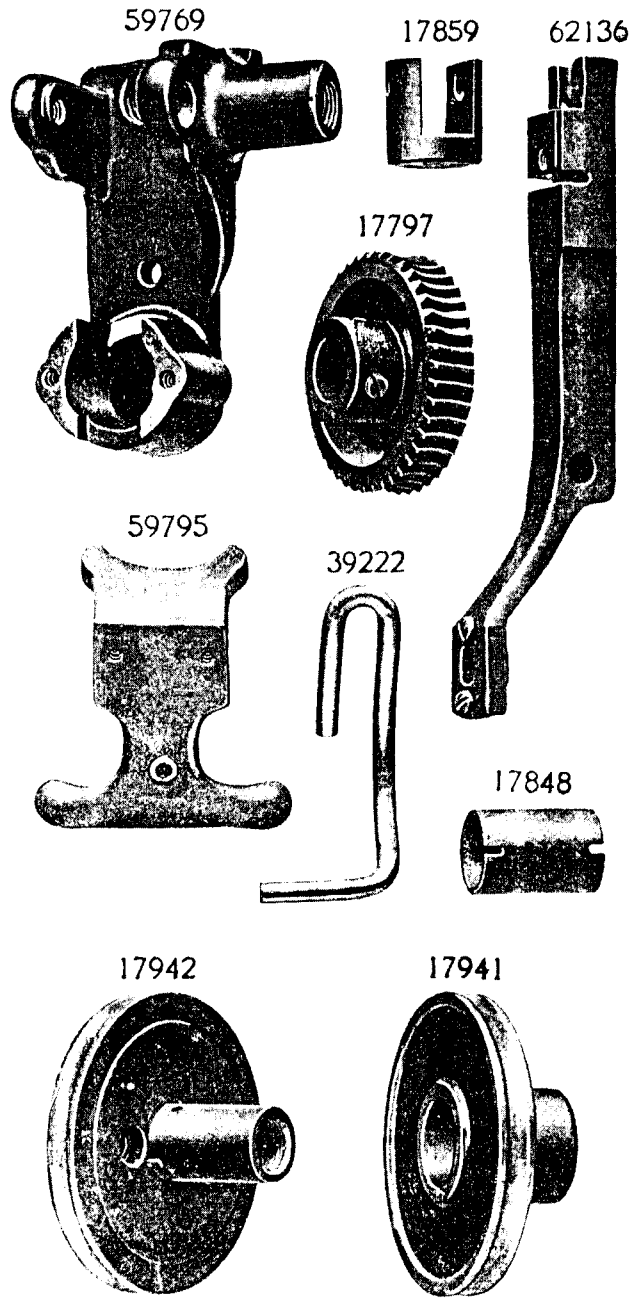

PLATE 6979—FULL SIZE

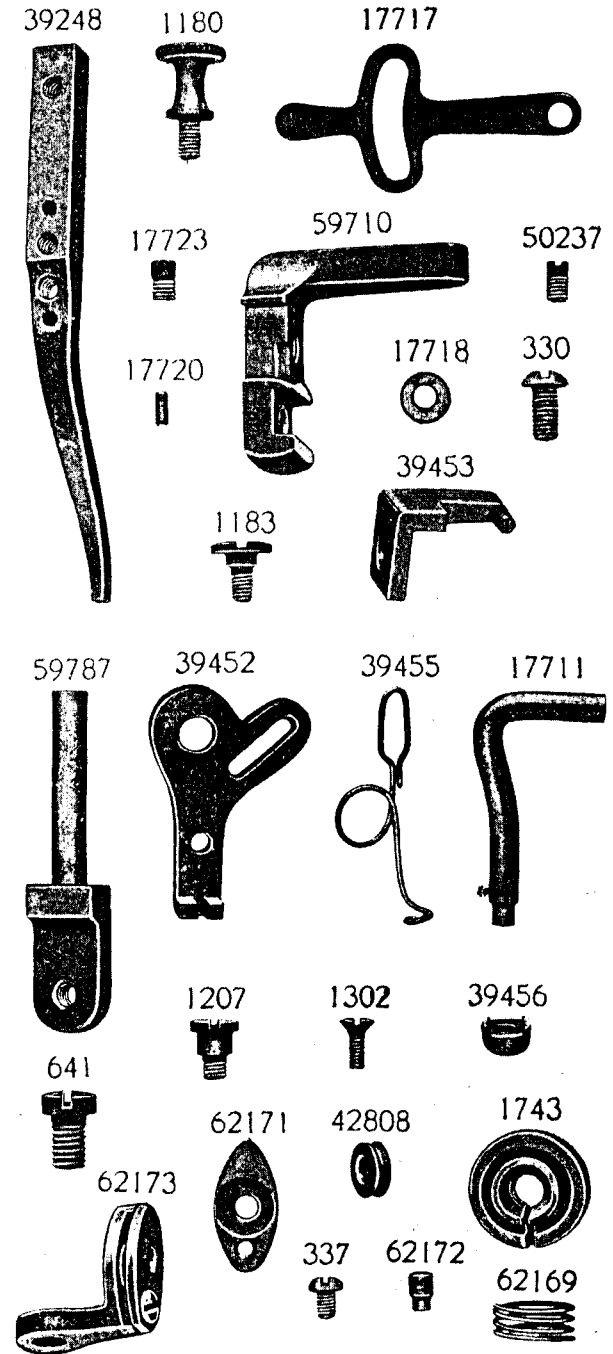

PLATE 6980—FULL SIZE

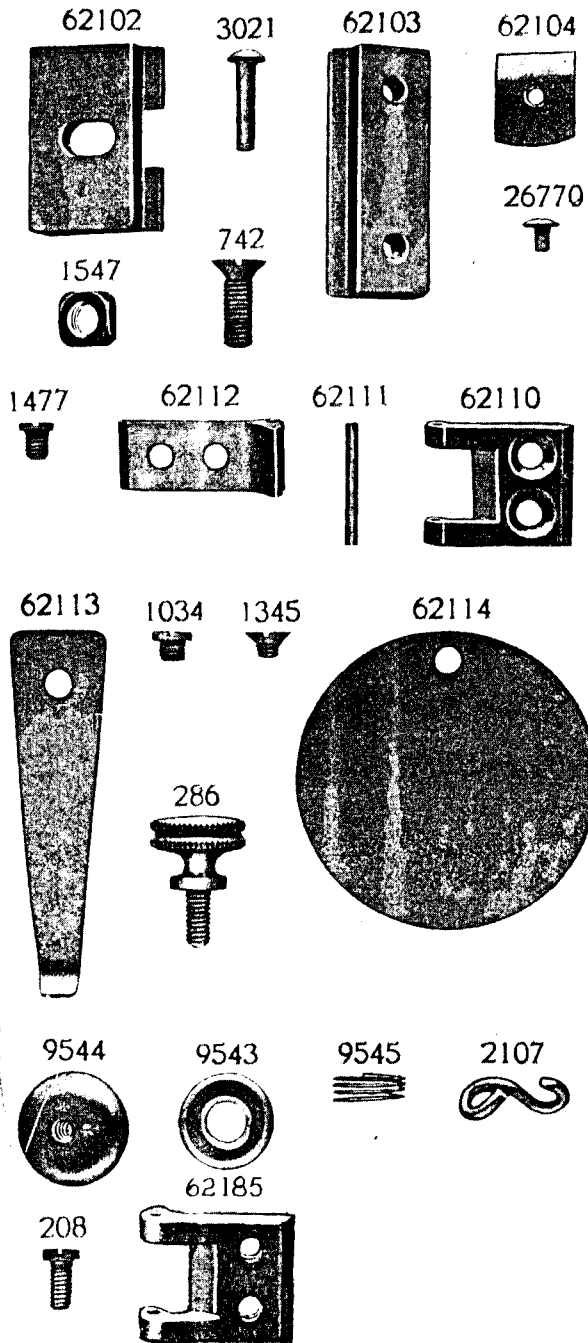

PLATE 6981—ONE-HALF SIZE

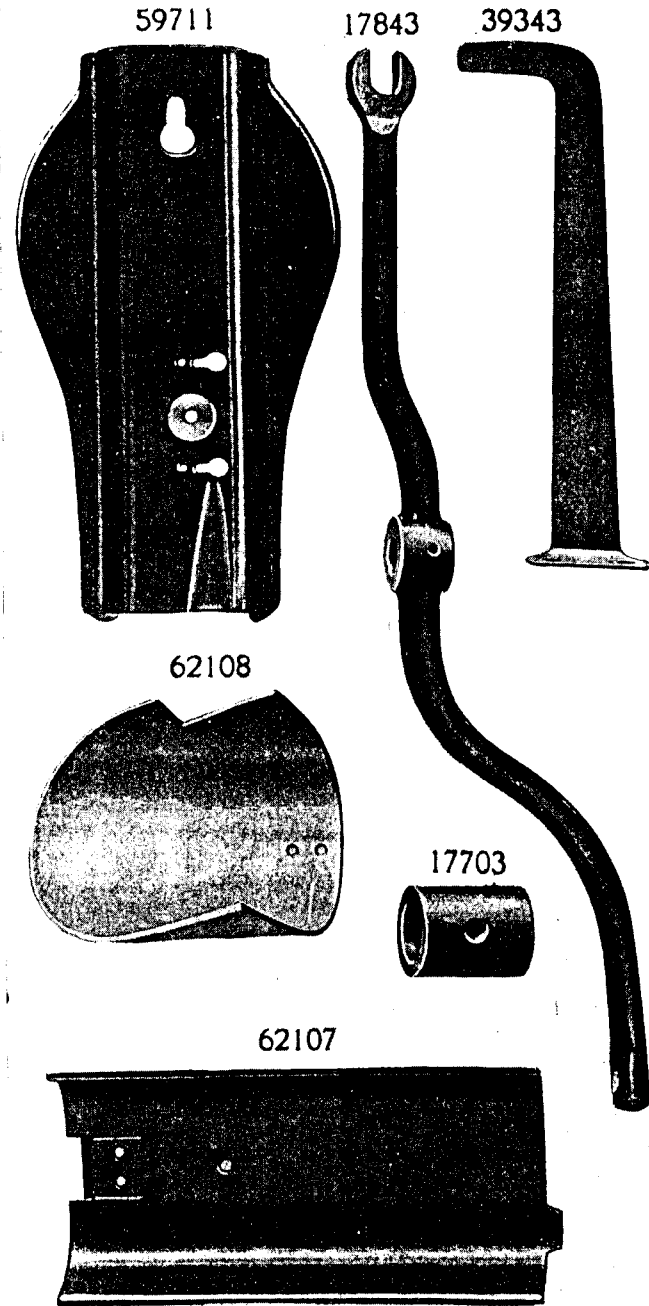

PLATE 6982—FULL SIZE

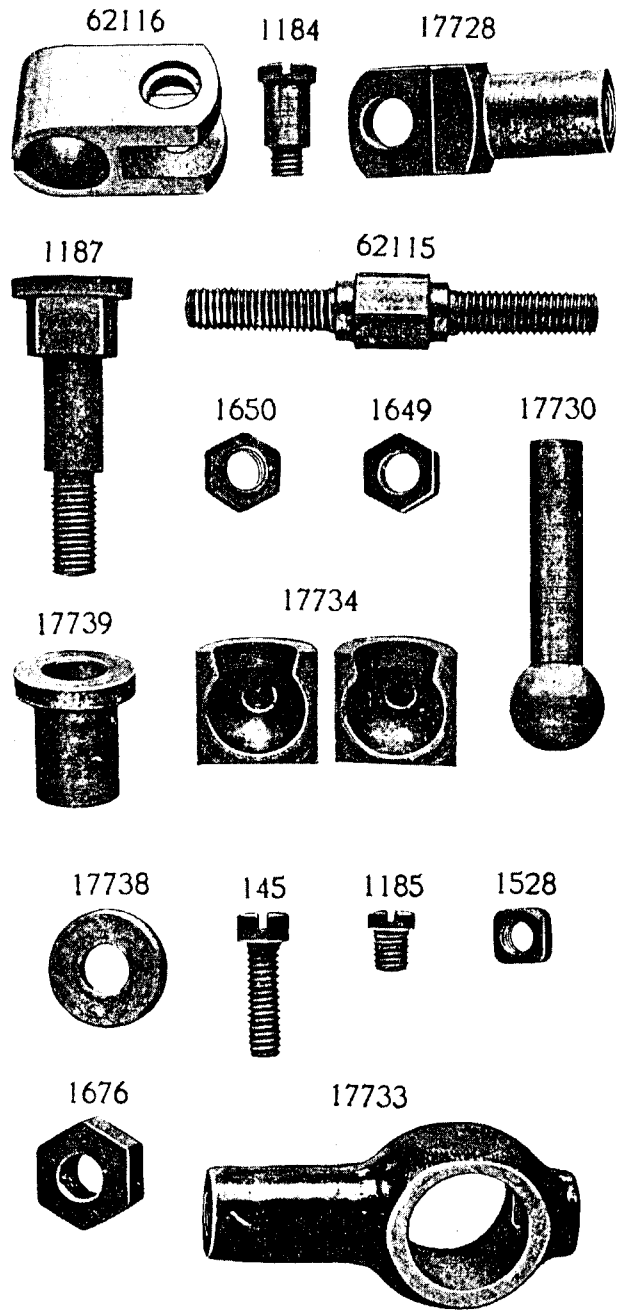

PLATE 6985—FULL SIZE

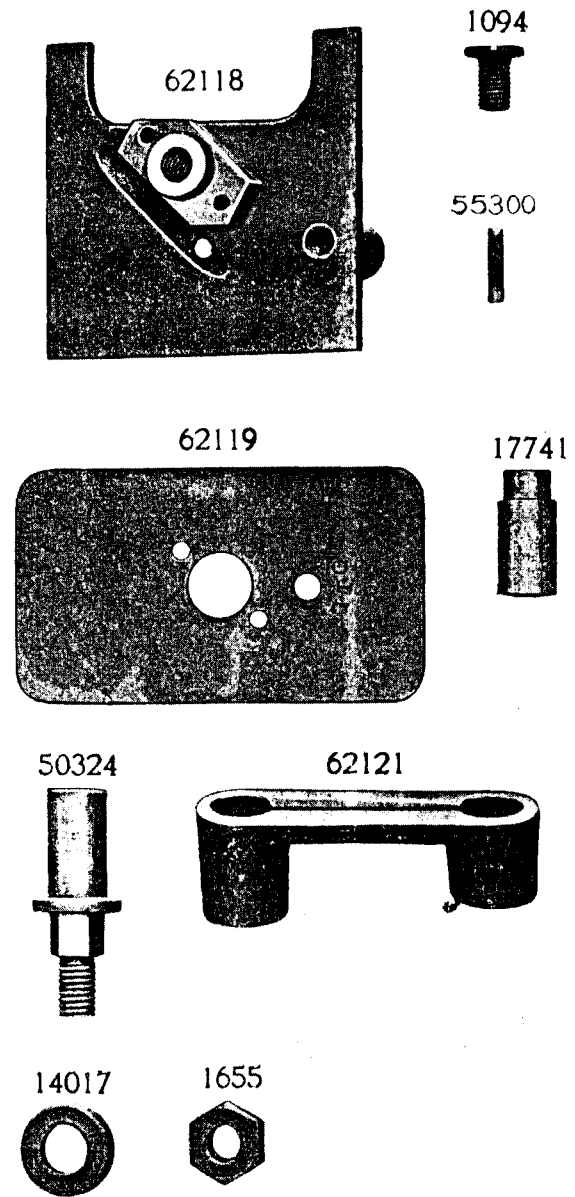

PLATE 6987—FULL SIZE

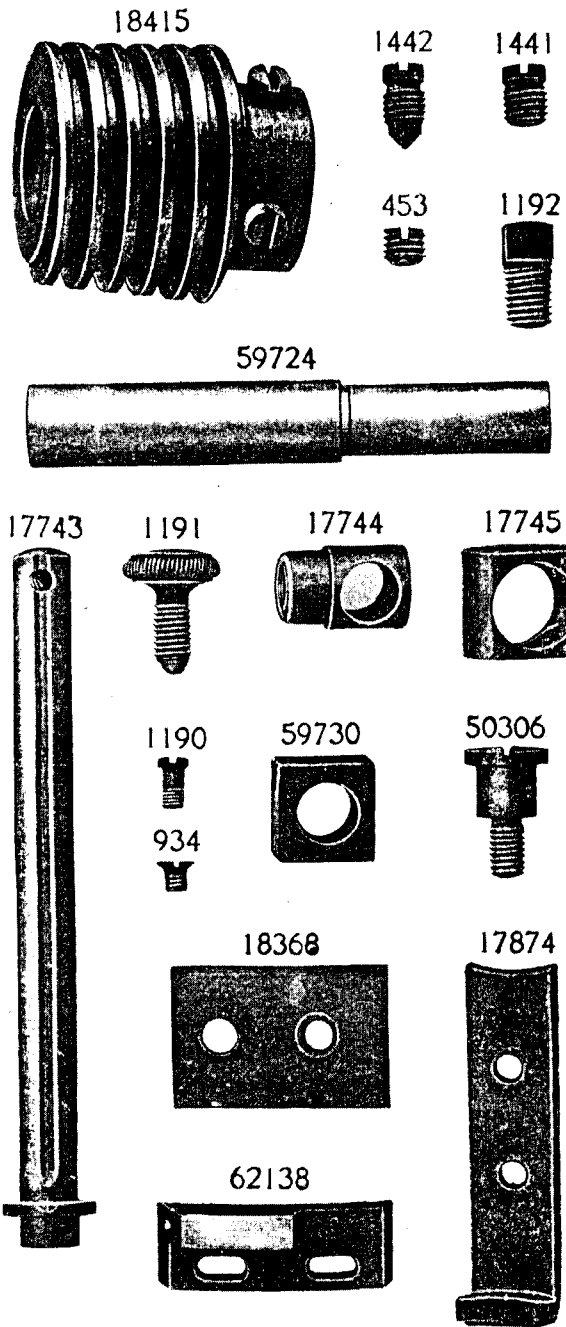

PLATE 6989—ONE-HALF SIZE

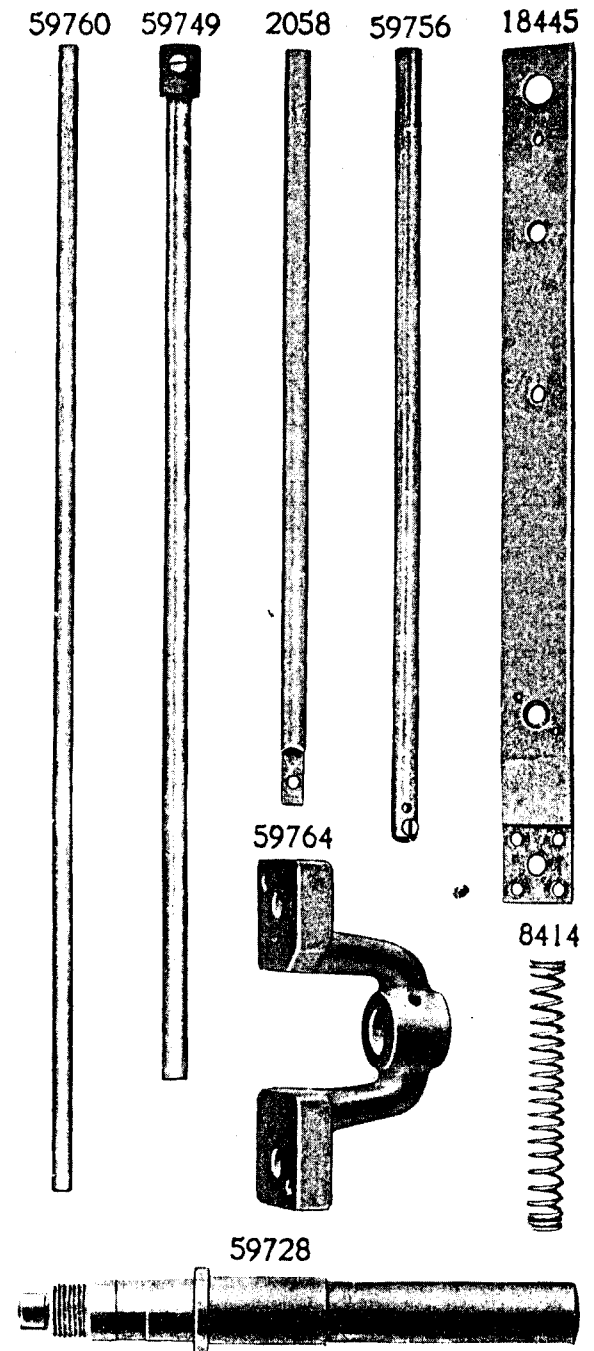

PLATE 6990—FULL SIZE

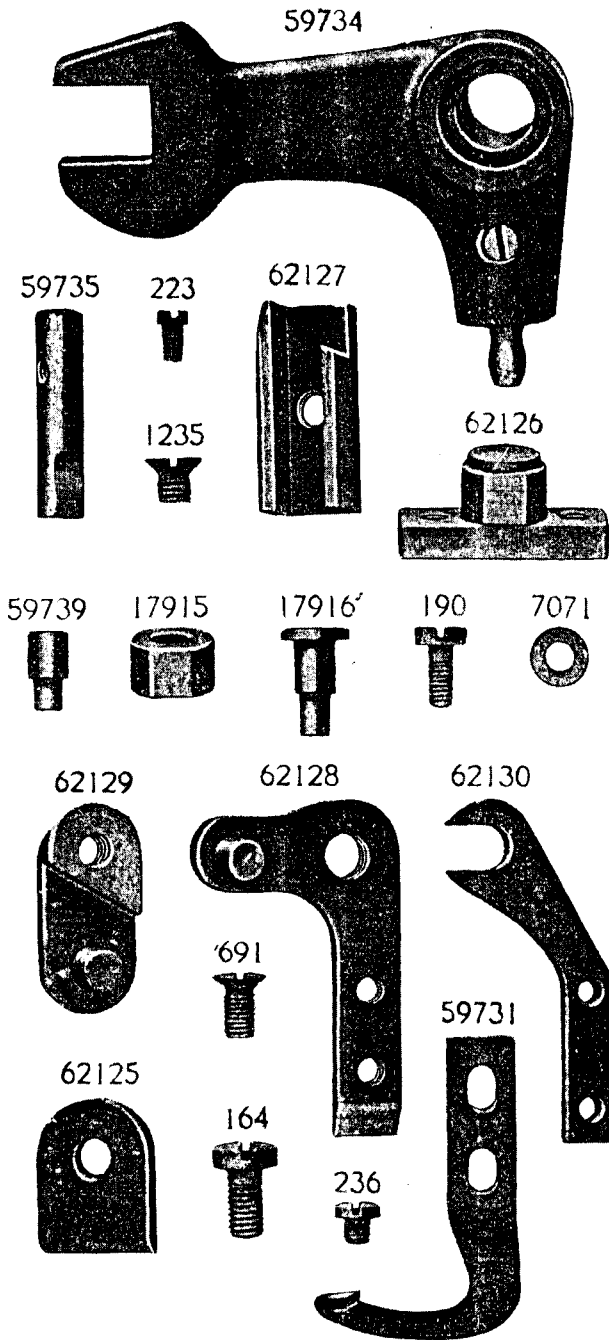

PLATE 6991—FULL SIZE

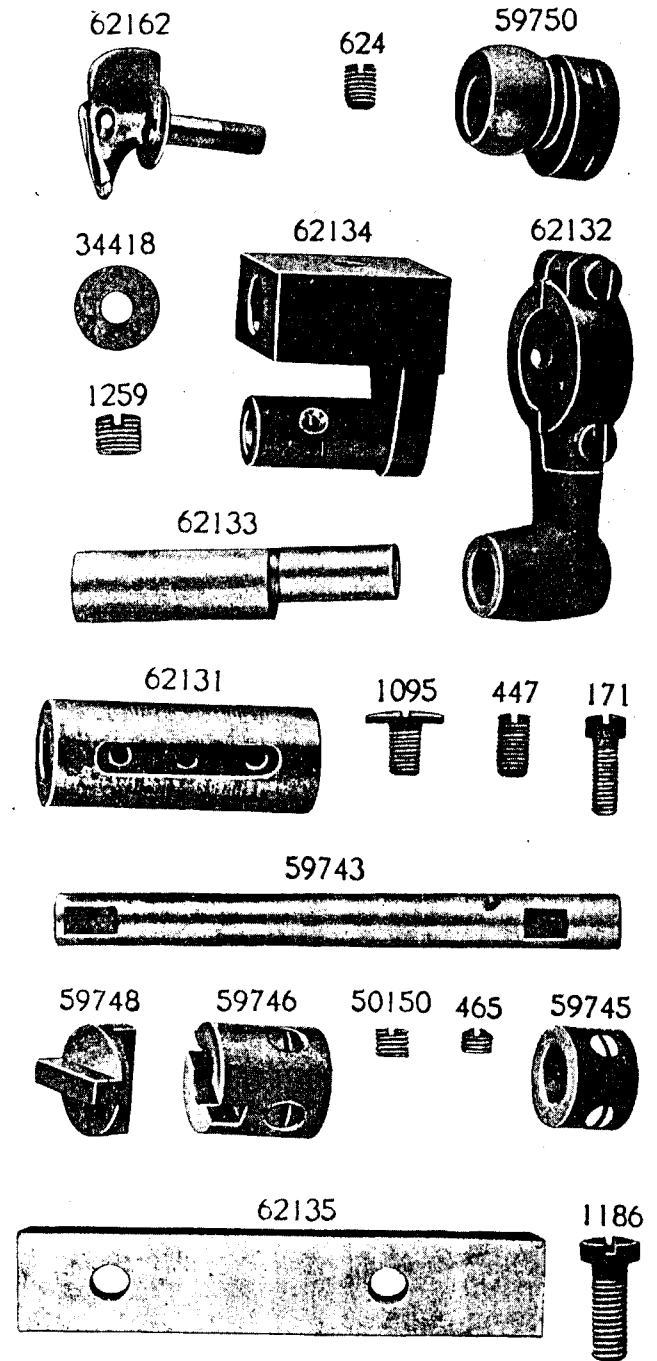

PLATE 6992—FULL SIZE

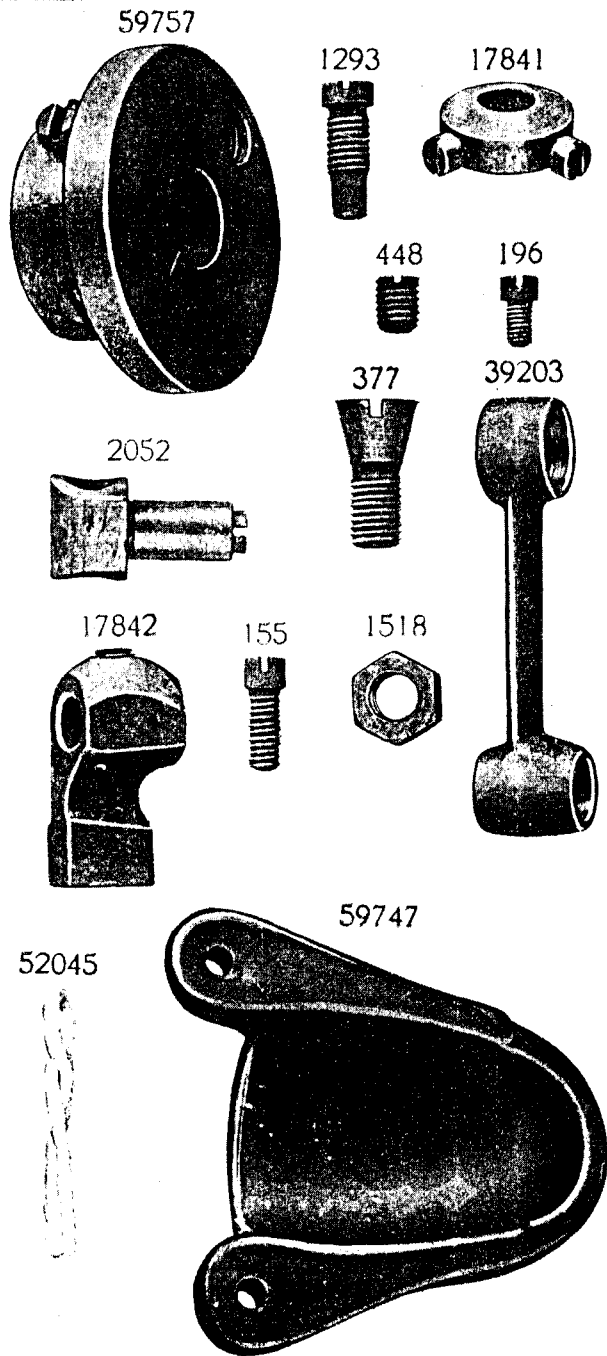

PLATE 6993—FULL SIZE

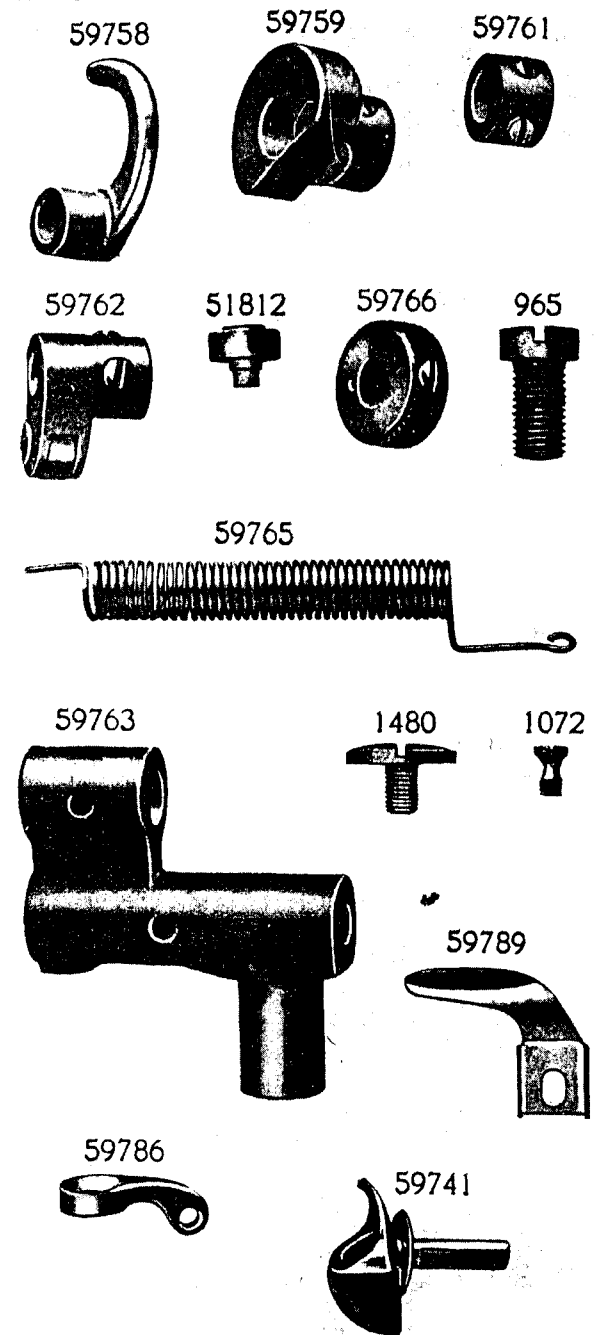

PLATE 6994—FULL SIZE

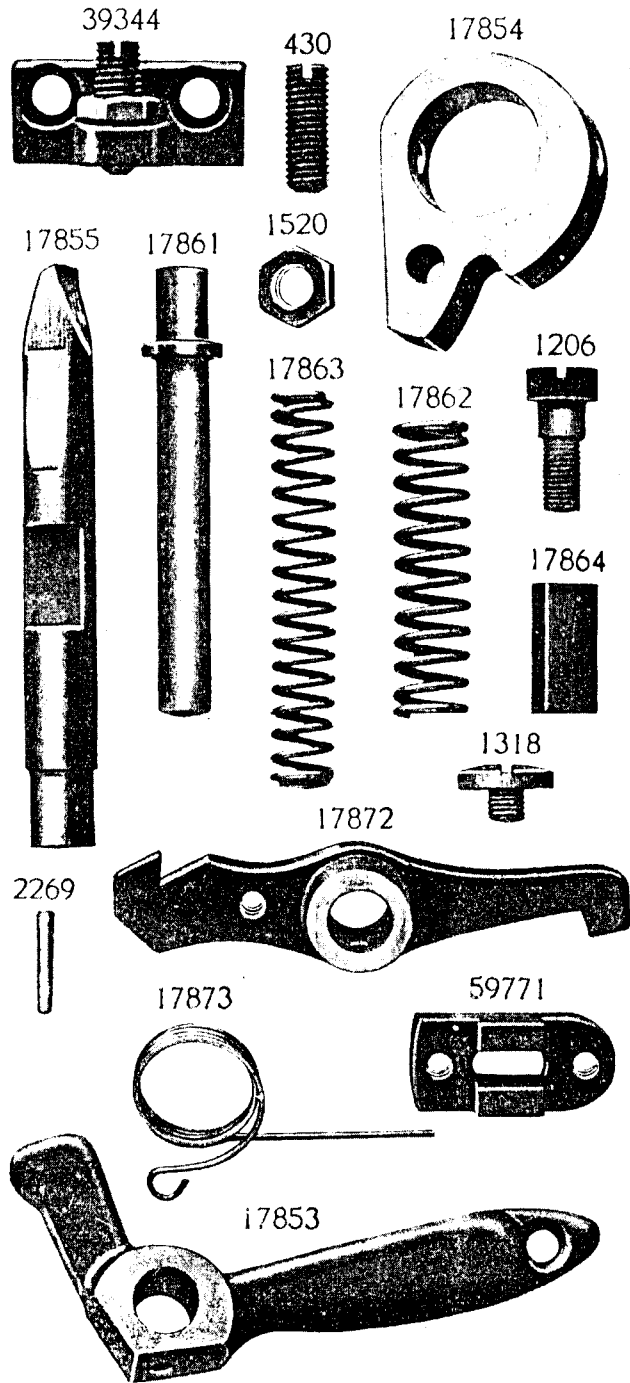

PLATE 6995—FULL SIZE

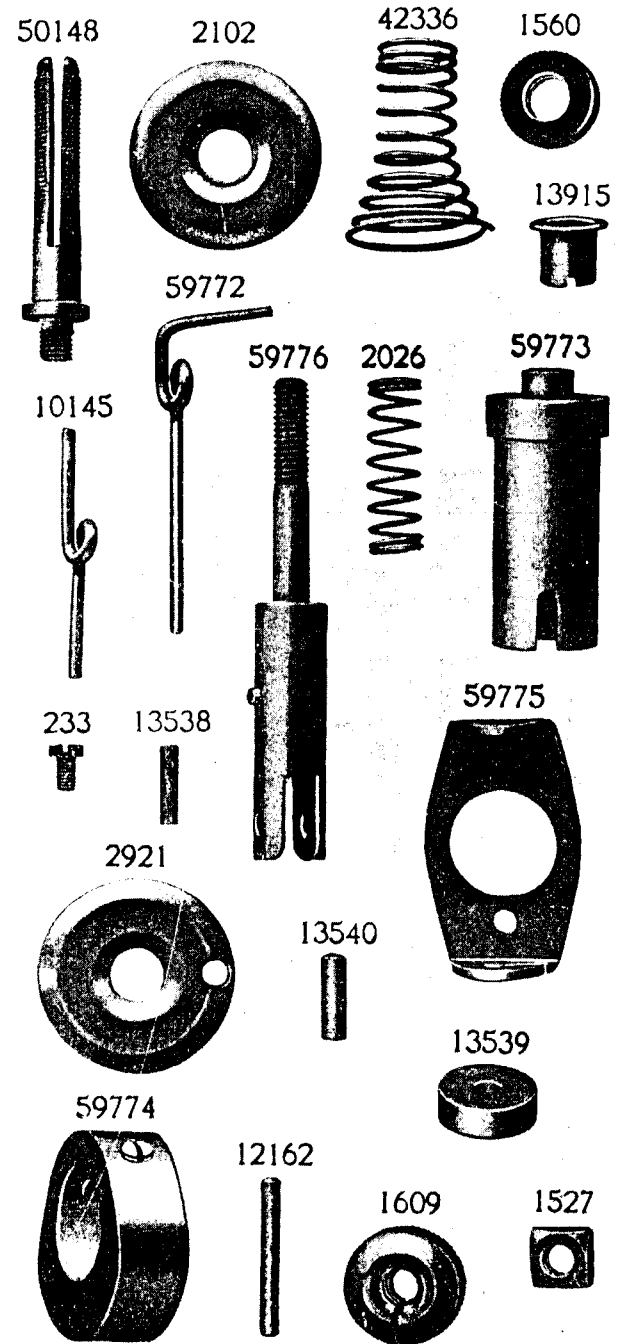

PLATE 6996—FULL SIZE

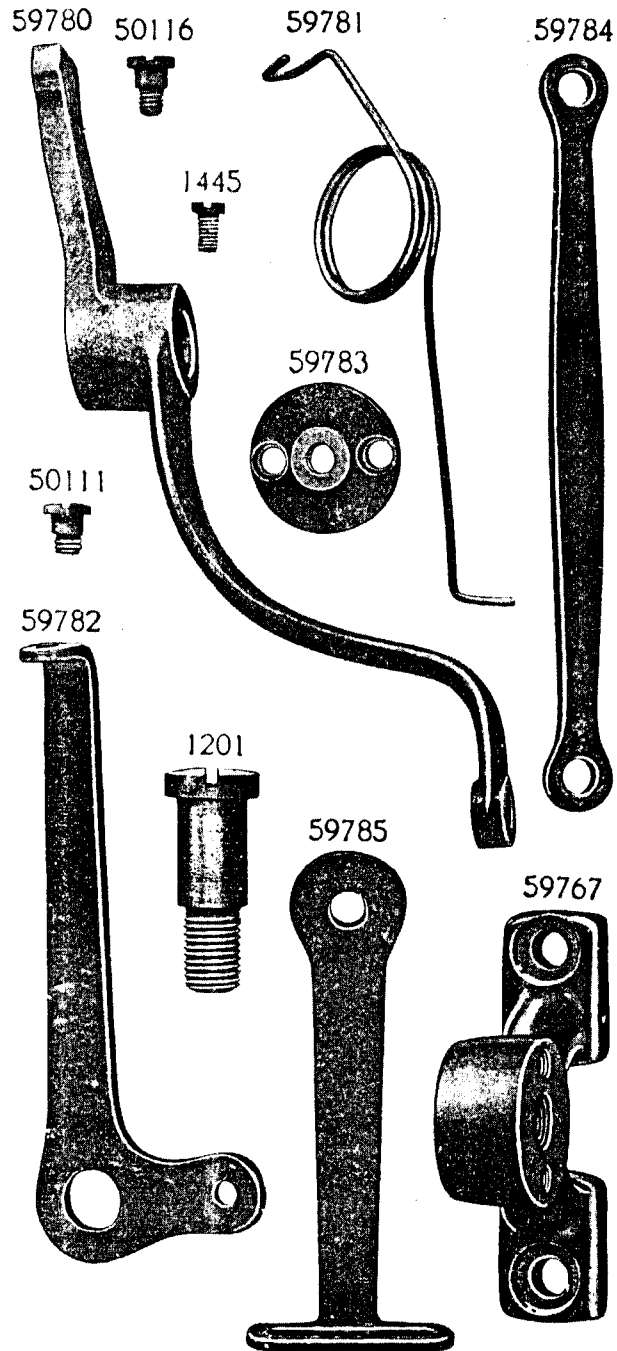

PLATE 6997—FULL SIZE

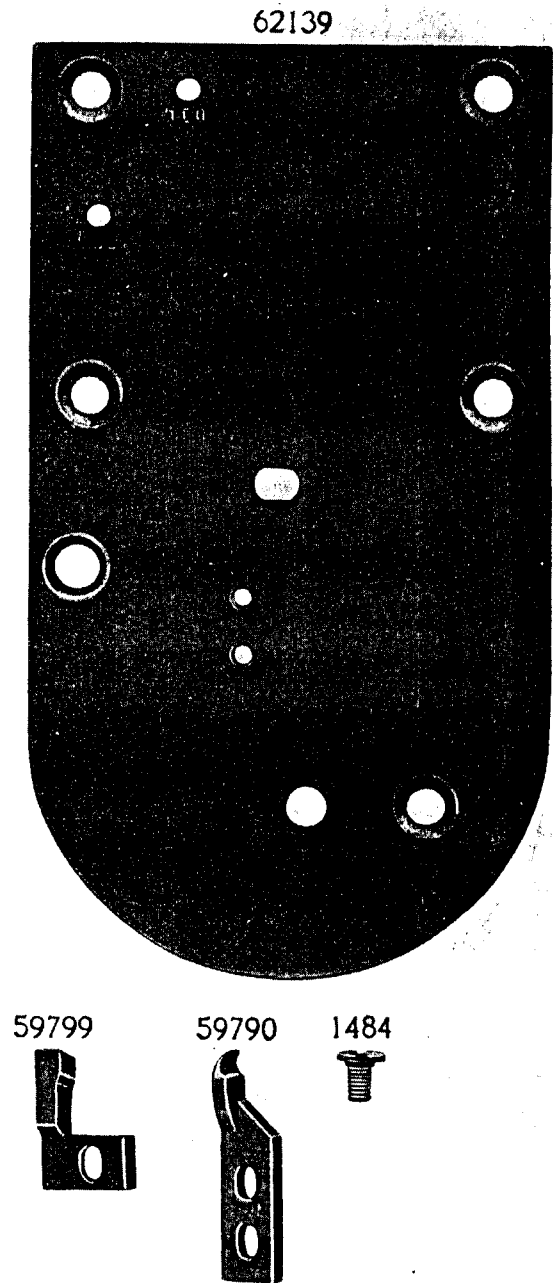

PLATE 6998—FULL SIZE

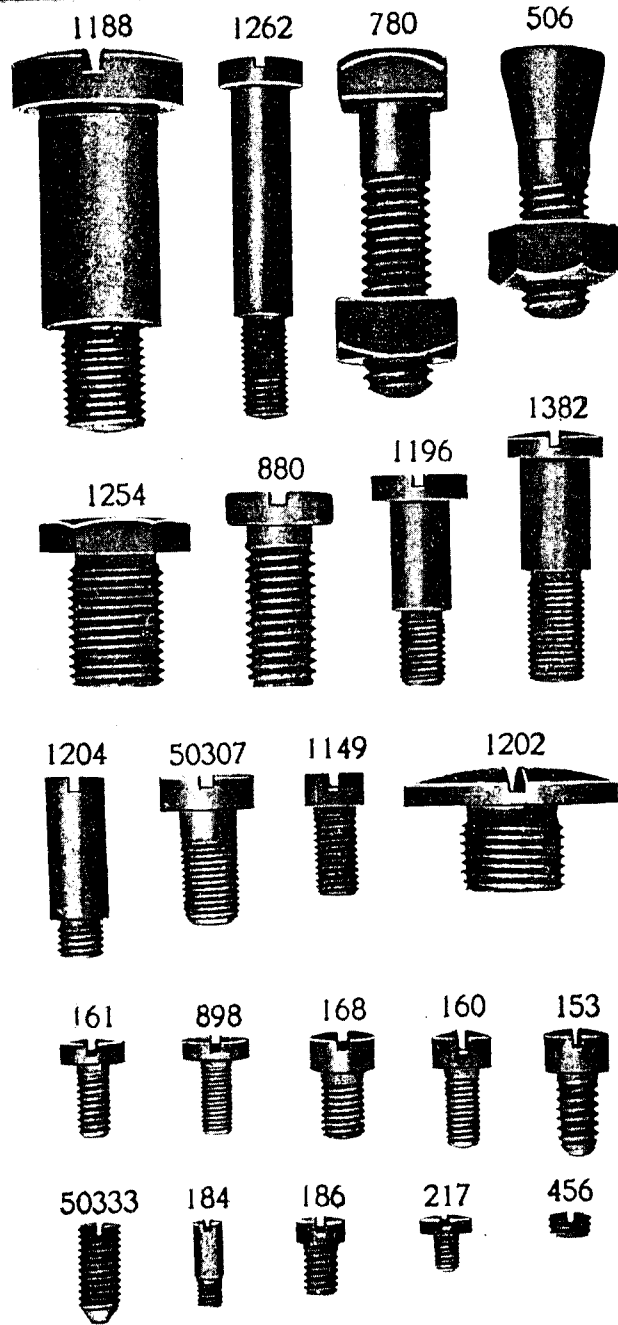

PLATE 6999—FULL SIZE

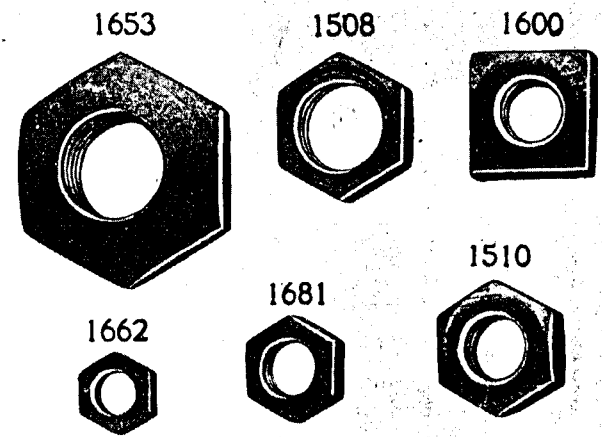

PLATE 7000—FULL SIZE

1220



1656



62141

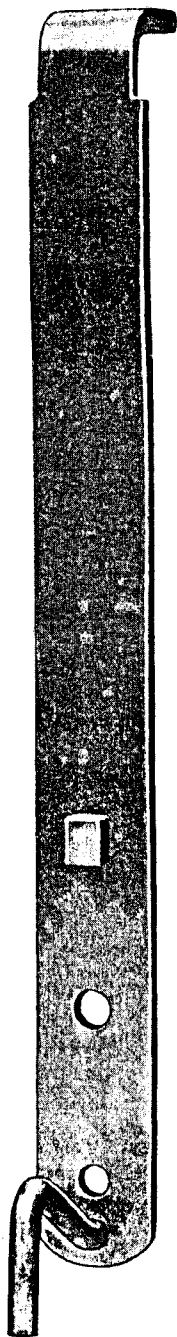

62140

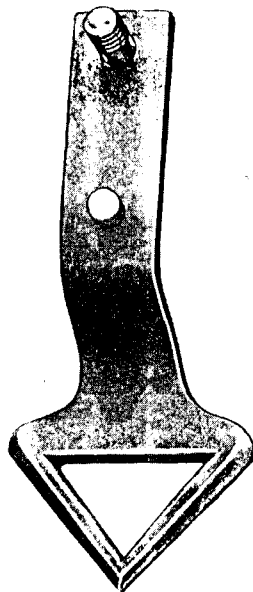

62142



17928

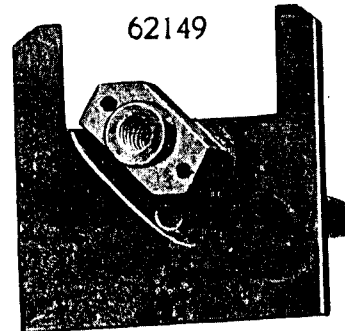

PLATE 7001—FULL SIZE

17712



62149



1189



62153



62152

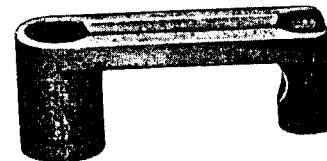

62150

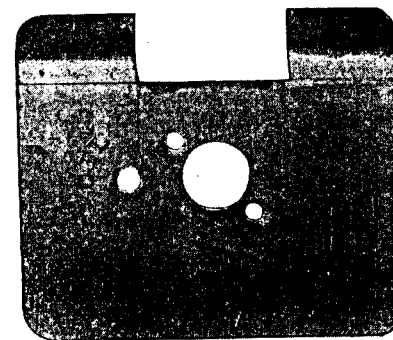

PLATE 7002—ONE-HALF SIZE

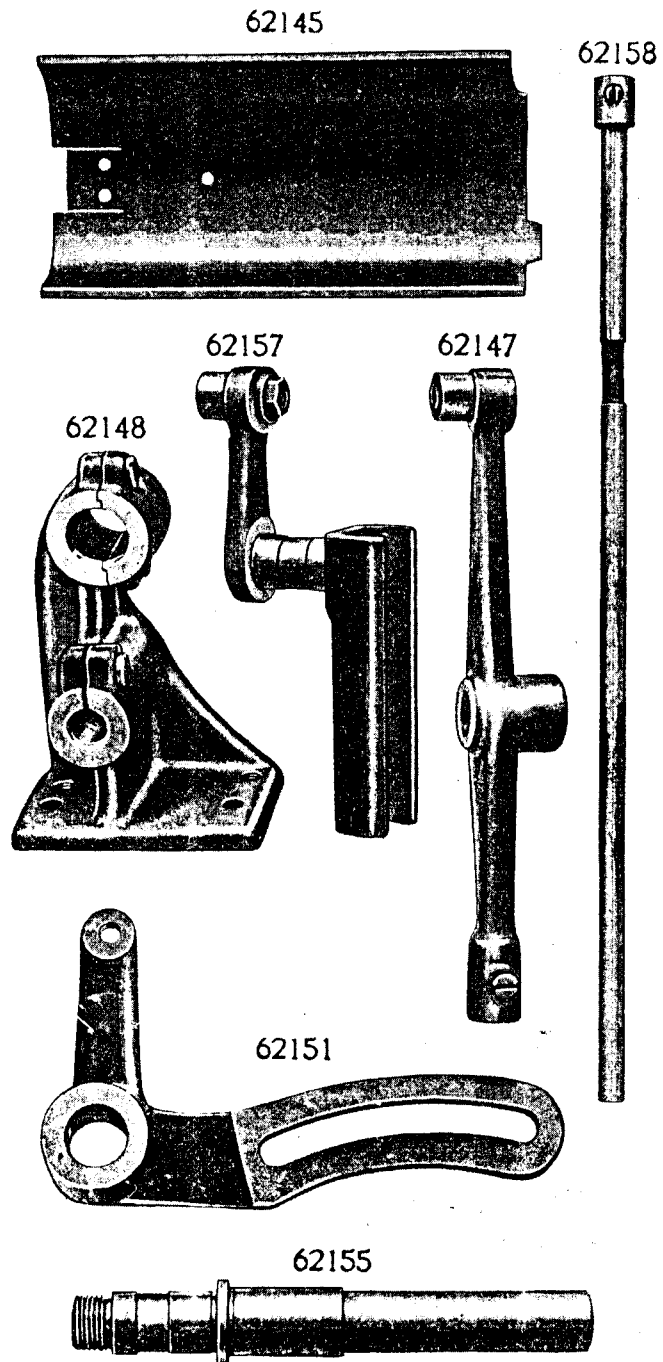

PLATE 7004—FULL SIZE

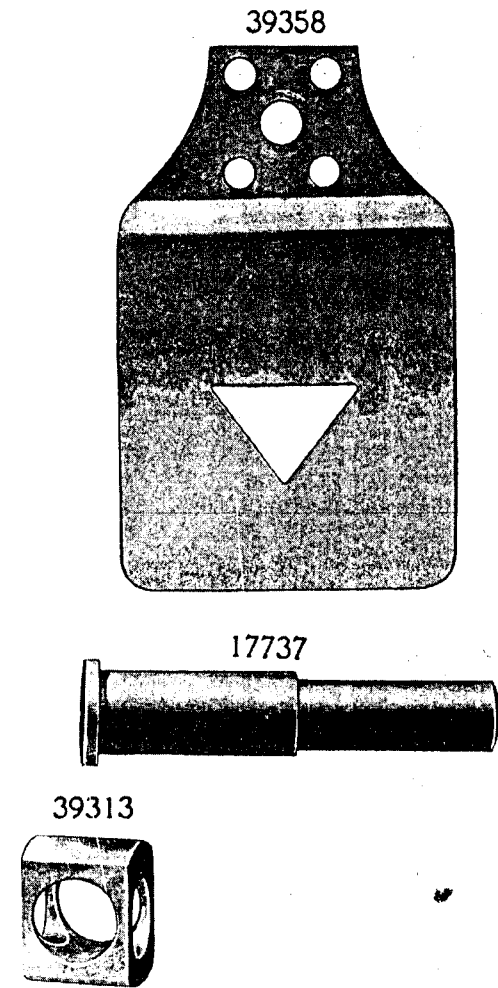

PLATE 7005—ONE-FOURTH SIZE

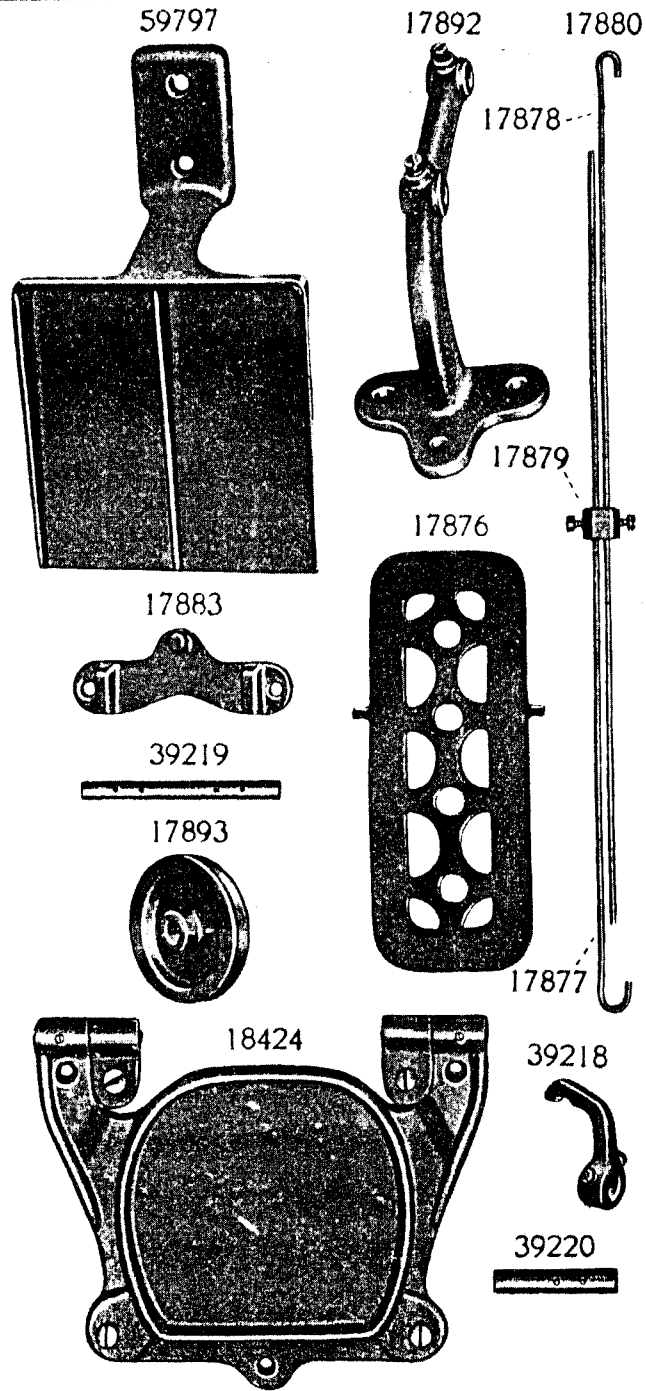

PLATE 7006—FULL SIZE

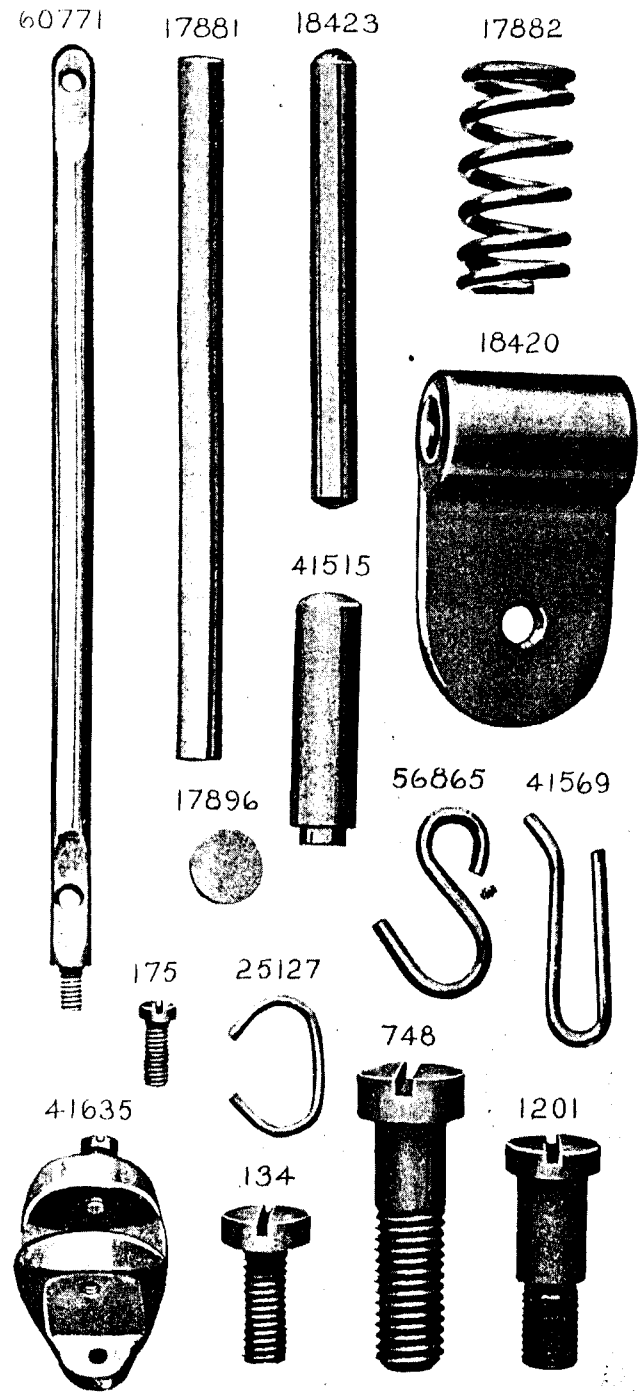

PLATE 7007—ONE-HALF SIZE

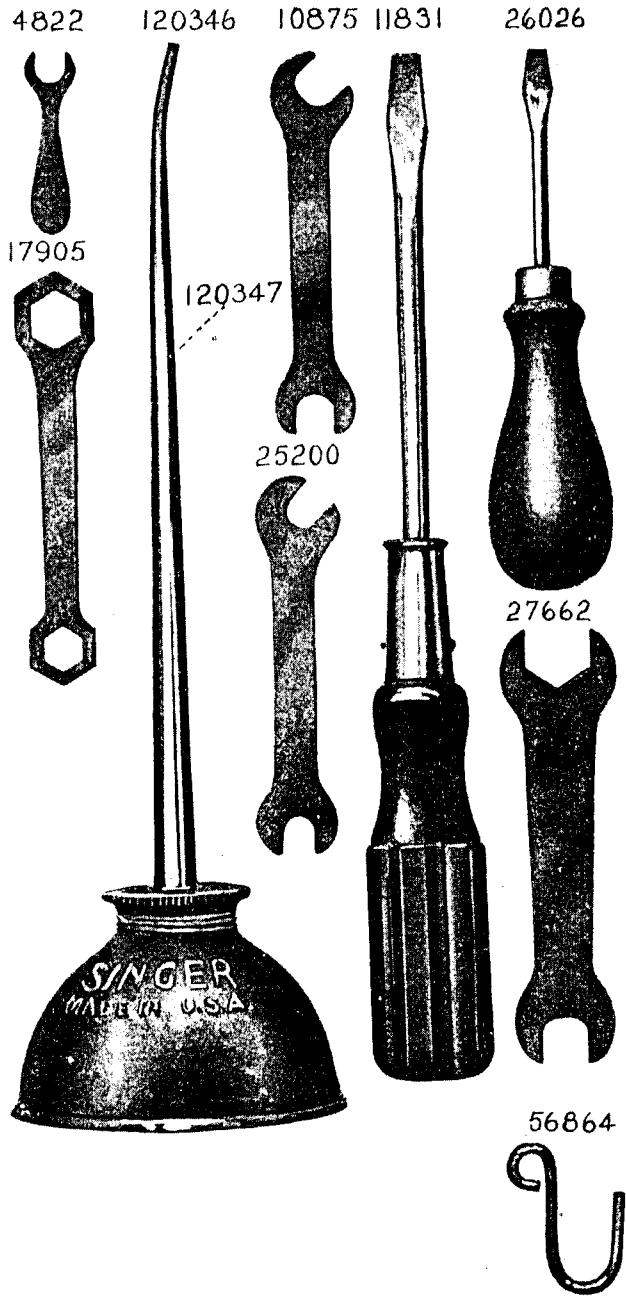

PLATE 7008—ONE-HALF SIZE

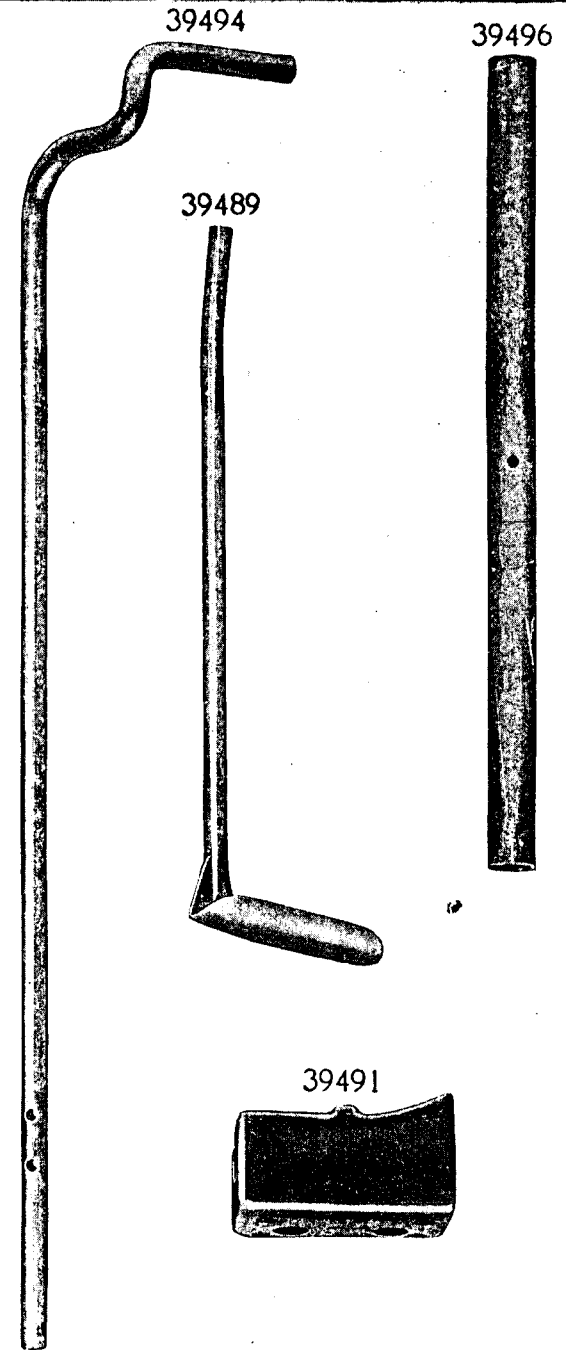
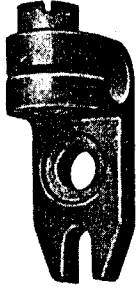

PLATE 7009--FULL SIZE

39492



160



39495

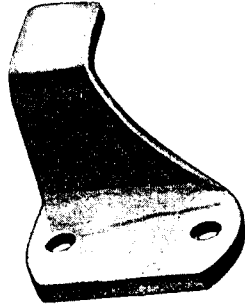

15261



237



52598



176



39497



50351



426



1099



454



448



1120



39493

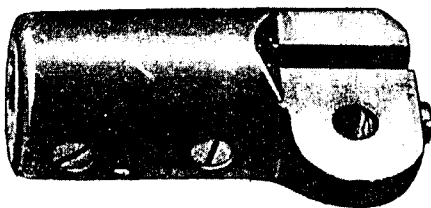
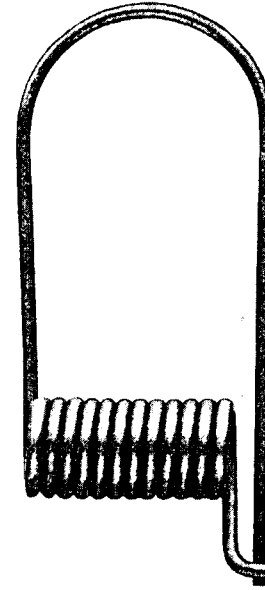

PLATE 7010--FULL SIZE

4883



4879



4882



62168



62167

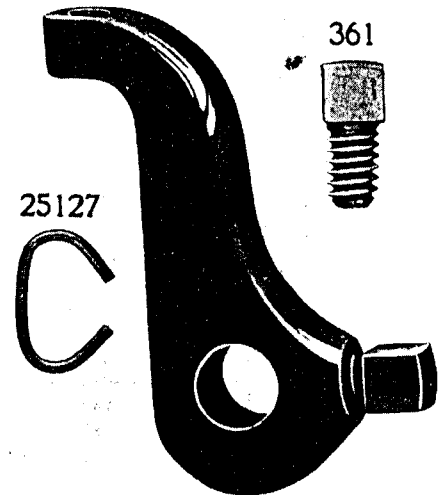

361



25127



PLATE 7011—FULL SIZE

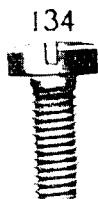
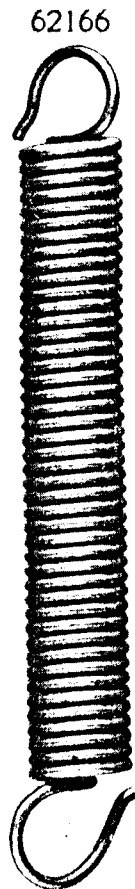
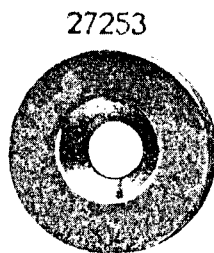
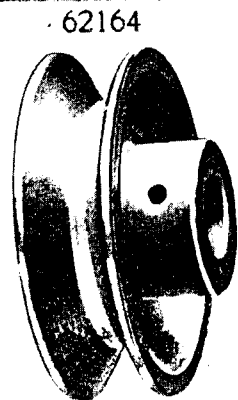
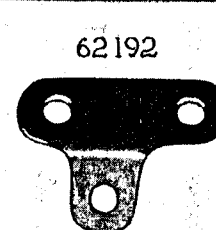
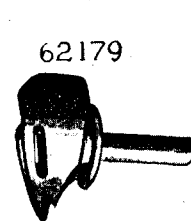

PLATE 7015—FULL SIZE



8734

63788

50372

1148

227

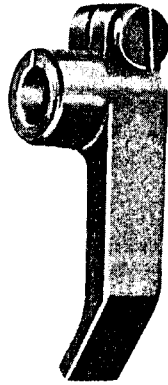

PLATE 7019—FULL SIZE

124680



124677



124679



17719



1282



1181



704



1953



59796

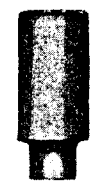

460



93



124603



10107



10106



42348



124604



62300



124601

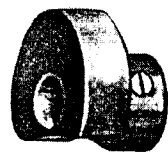

124602

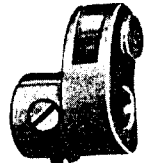

18384



3012



8589



8554



124626



PLATE 7020—ONE-HALF SIZE

124678 62299 124630 124681

62183



124653

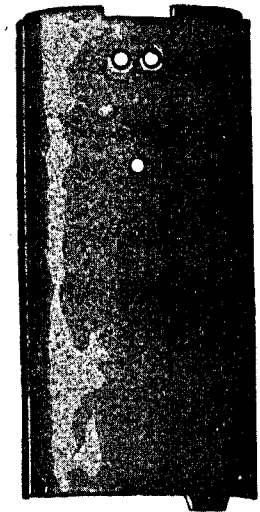

124606



124621



124620



124616



124682

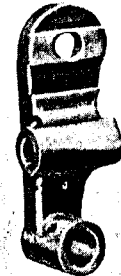

124623



124622



124674



PLATE 7024—FULL SIZE

124627

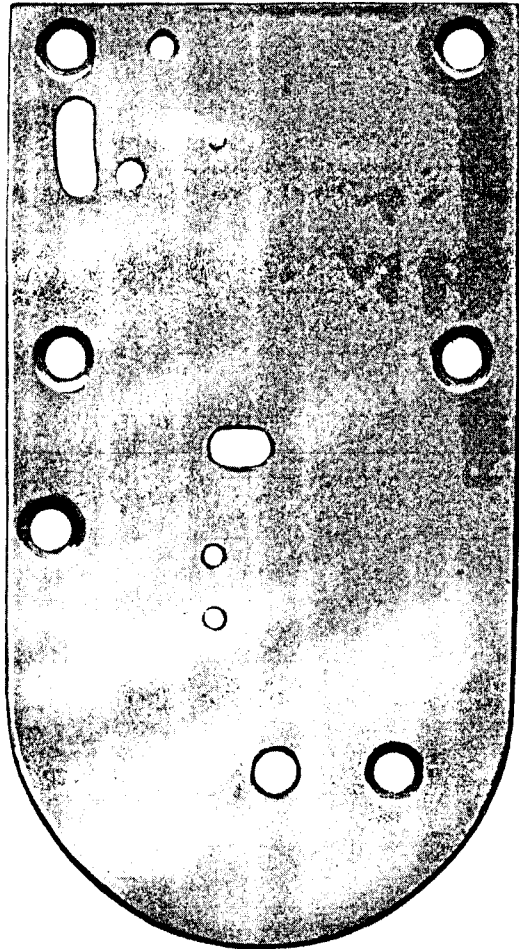

124628



59790



59799



206



PLATE 7026—FULL SIZE

1178



62174



17710



62258



1176



17714



62261

1177



201



17713

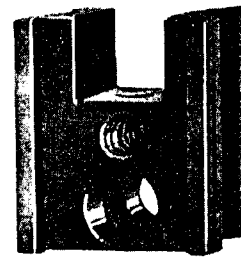

62260



PLATE 7027—FULL SIZE

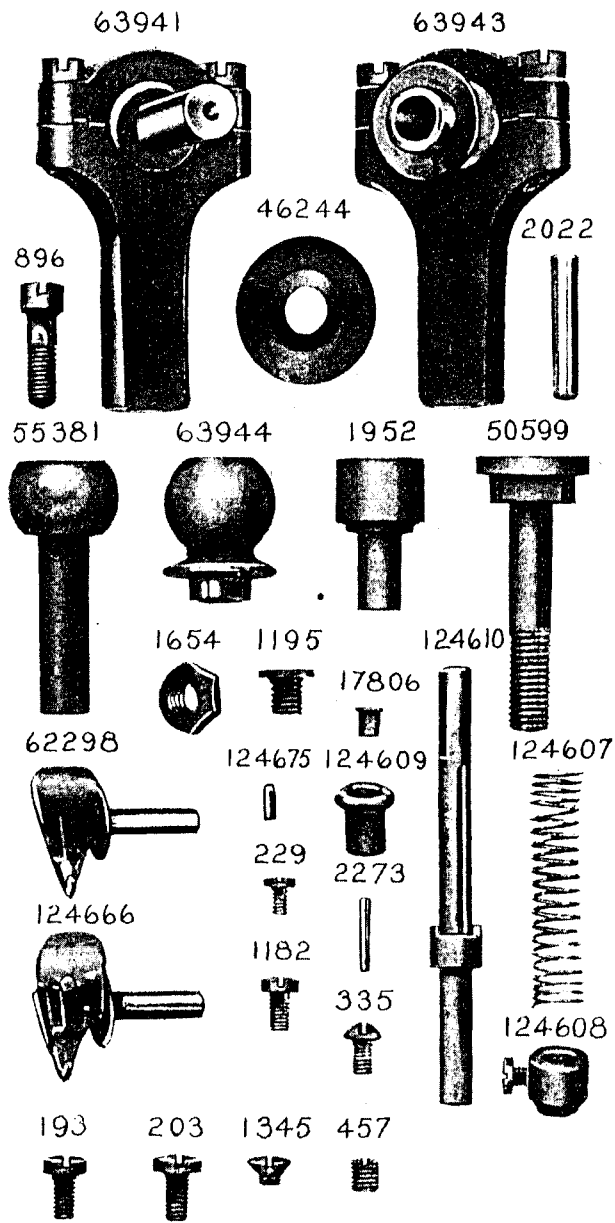

PLATE 7028—FULL SIZE

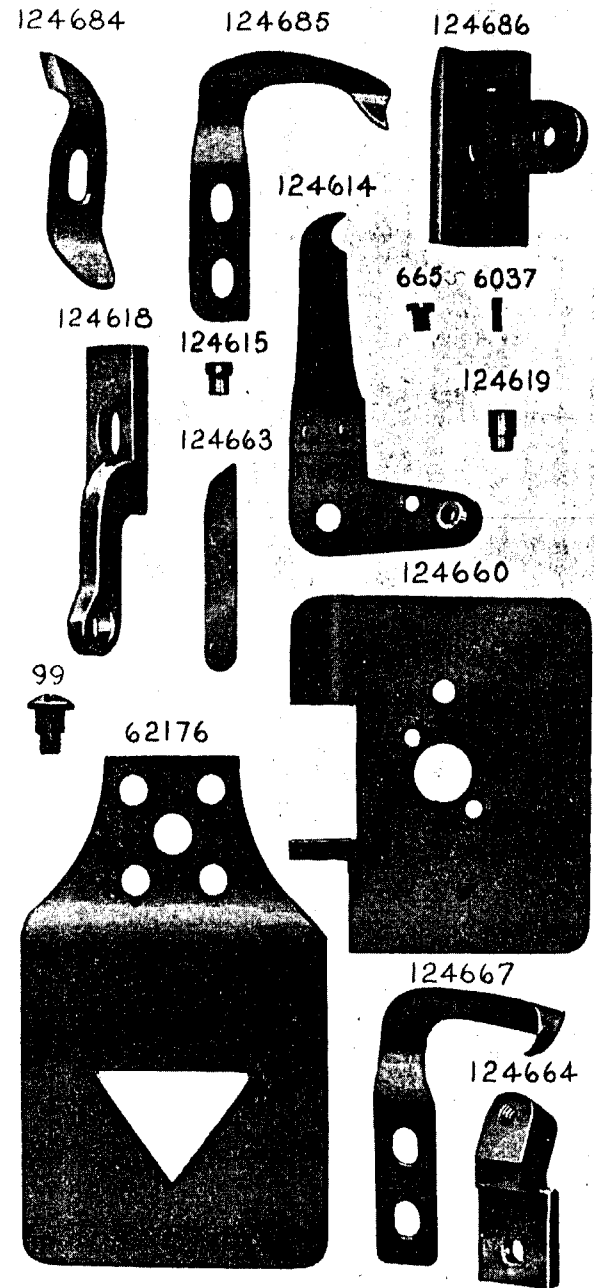
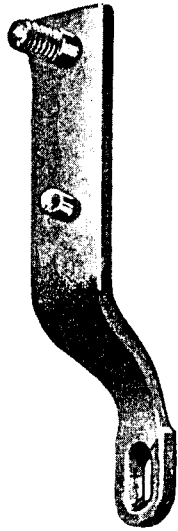
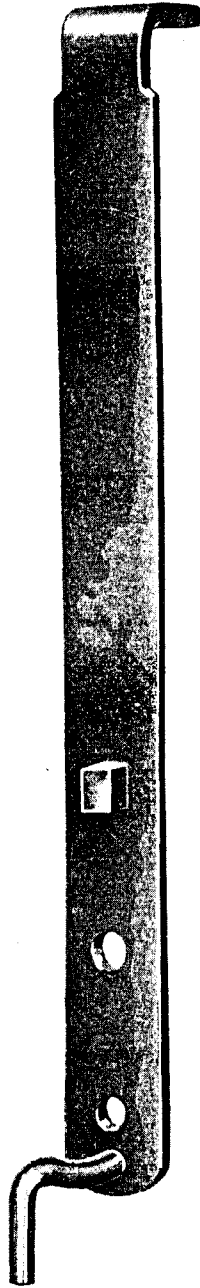

PLATE 7029—FULL SIZE

124646



124783



124649

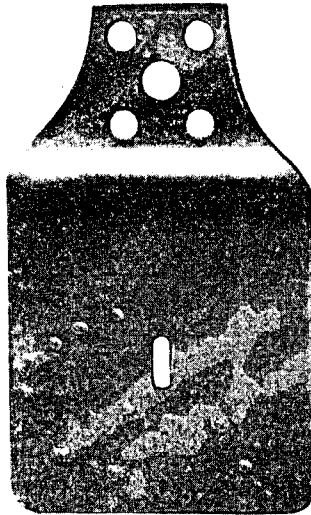

PLATE 7030—ONE-HALF SIZE

62284

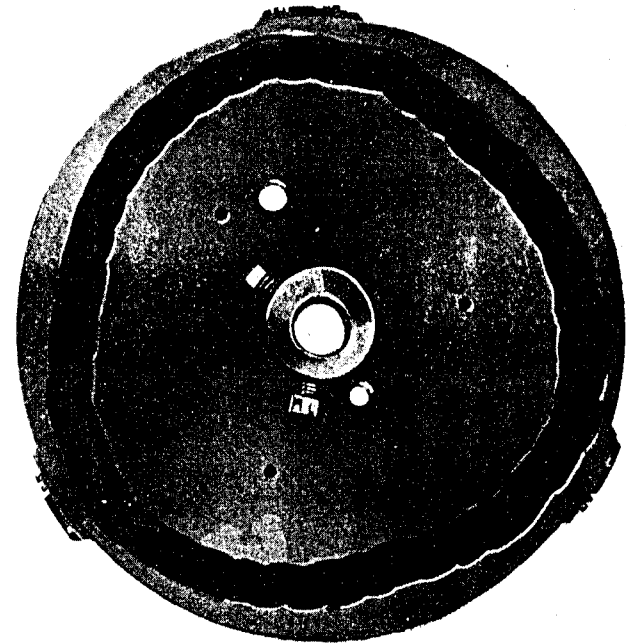
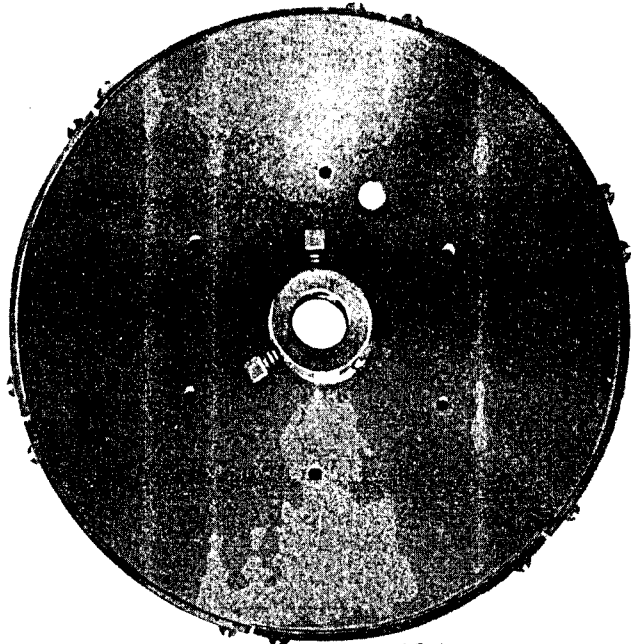

PLATE 7031—ONE-HALF SIZE

124648



124661

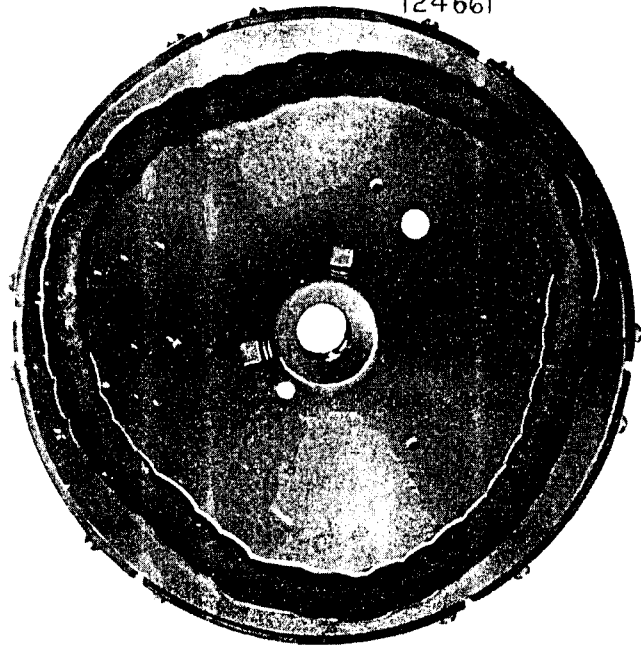
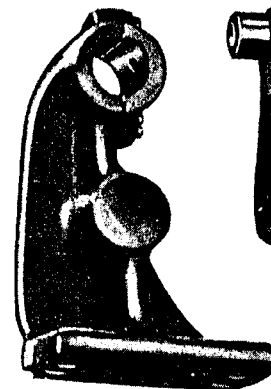
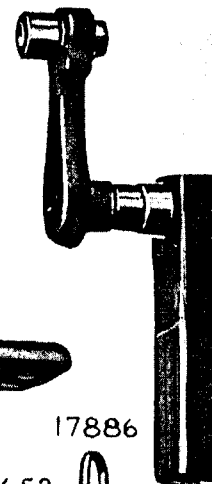

PLATE 7032—ONE-HALF SIZE

124651



17742



17845



17886



124650



124652



124624



62189

