

**SINGER**  
**21W**

# INDEX

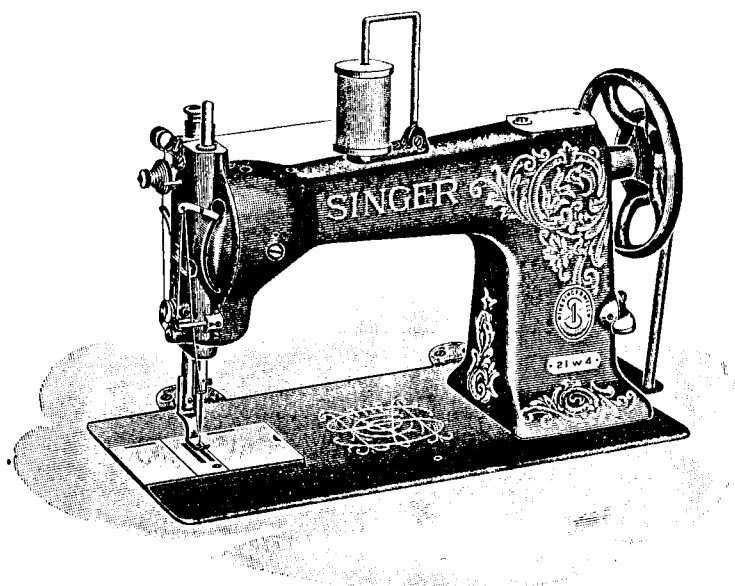
---

	PAGE
ACCESSORIES .....	79
BINDERS .....	106
BORBIN WINDER .....	79
DRIVING ATTACHMENT .....	115
FEED DOGS .....	84
GUIDE .....	110
HEMMERS .....	111
HEMMER FEET .....	114
KNEE LIFTER .....	80
“ “ .....	82
MACHINE NO. 21w4 .....	7
“ “ 21w15 .....	15
“ “ 21w25 .....	23
“ “ 21w30 .....	31
“ “ 21w50 .....	39
“ “ 21w54 .....	47
“ “ 21w115 .....	55
“ “ 21w118 .....	63
“ “ 21w122 .....	71
“ “ 21w160 .....	78
NUMERICAL LIST OF PARTS .....	119
OBSOLETE PARTS .....	117
PRESSER BAR .....	106
“ FEET .....	86
ROLLER PRESSERS .....	95
“ WELT GAUGE .....	114
STARTING TREADLE .....	83
THROAT PLATES .....	98

COPYRIGHT, U. S. A., 1925 AND 1928,  
BY THE SINGER MANUFACTURING CO.  
ALL RIGHTS RESERVED FOR ALL COUNTRIES

**LIST OF PARTS COMPLETE**

FOR



**MACHINE No. 21w4**

**DROP FEED**

For General Cloth Work, Shirts, Underwear,  
Shirt Waists, Wrappers, Corsets, etc.

No.	Plate	Name
*204161	—	Arm with 200439c, 202036 and 204705 .....
204163	12305	Arm Cap .....
200278H	12311	" " Screw .....
202248	12307	" " Washer .....
204235	13049	" Position Pin (2) .....
200963E	12311	" Screw (3) .....
202005	12308	" " Washer (3) .....
203202	12298	" Shaft .....
204705	12304	" " Bushing (front) .....
200439c	12311	" " " Position Screw ..
204440	12041	" " Connection with four 200054E (2) .....
200054E	12307	Arm Shaft Connection Screw ....
202299	—	" " Oil Packing (wick) (2)

**Instructions for Ordering**

In ordering from this list, use **ONLY** the **PART** number in the **FIRST** column.

The number stamped on a Sewing Machine Part is the number of the Single Part only, except when the part includes Set Screws, Clamping Screws, Studs and Rollers Spun on, Small Wires riveted, or Parts soldered together, etc., which it is necessary to furnish in combination.

Every combination of parts sent out has its specific number which, although not stamped on Parts (except in above cases) must be used when ordering the combination.

Each number always indicates the **SAME PART** in whatever list it appears, or for whatever Machine.

The letters after some of the numbers indicate the style of finish only, as follows:

- A. Hardened, Polished and Plated.
- B. Polished and Plated.
- C. Hardened only.
- D. Polished only.
- E. Soft, not polished.
- F. Hardened and Polished.
- H. Blued.

These letters **MUST BE USED** when they appear in the list and **AFTER** the number, as in the list.

In this series

- 200001 to 201500 are Screw Numbers.
- 201501 to 201800 are Nut Numbers.
- 201801 to 202000 are Roller Numbers.
- 202001 and upward are numbers of Machine Parts.

The figures in the second column refer only to the plate in which the illustration of the part is shown and are **NOT TO BE USED** in ordering.

Two or more numbers over a cut indicate that the difference between such parts is not visible in an illustration.

Parts marked with an asterisk (\*) are furnished only when repairs are made at the factory.

## Parts for Machine No. 21w4

9

No.	Plate	Name
200106E	12311	Feed Dog Screw .....
203233	12305	" Driving Cam with 200382c and 200437c .....
204192	12304	Feed Driving Cam Fork Lever with 204195 and 204293 .....
204193	12041	Feed Driving Cam Fork Lever Connection with 200668c and 201525E .....
204194	12306	Feed Driving Cam Fork Lever Connection Clamp with 200031E .....
200031E	12311	Feed Driving Cam Fork Lever Connection Clamp Pinch Screw .....
200668c	12310	Feed Driving Cam Fork Lever Connection Clamp Screw Stud .....
201525E	11143	Feed Driving Cam Fork Lever Connection Clamp Screw Stud Nut .....
200002E	12310	Feed Driving Cam Fork Lever Connection Hinge Screw .....
201522E	12310	Feed Driving Cam Fork Lever Connection Hinge Screw Nut .....
*204195	---	Feed Driving Cam Fork Lever Shaft
204197	12306	" " " " " " Collar with 200113E .....
200113E	12308	Feed Driving Cam Fork Lever Shaft Collar Set Screw .....
204293	12308	Feed Driving Cam Fork Lever Shaft Position Pin .....
204196	12307	Feed Driving Cam Fork Lever Shaft Sleeve (split) .....
200043c	12311	Feed Driving Cam Fork Lever Shaft Sleeve Set Screw .....
201524E	12310	Feed Driving Cam Fork Lever Shaft Sleeve Set Screw Nut .....
204198	12304	Feed Driving Cam Fork Lever complete, Nos. 204192 and 204194 .....
200437c	12311	Feed Driving Cam Position Screw .....
200382c	13049	" " " Set Screw .....
204199	12298	" " Rock Shaft .....
206554	---	" " " " 204199 with 200002E, 201522E and 204193 .....
202305	12307	Feed Driving Rock Shaft Center (2)
200043c	12311	" " " " " Set Screw (2) .....
204200	12305	Feed Driving Rock Shaft Crank with 204189 (on left side) and two 200383c .....
200383c	12311	Feed Driving Rock Shaft Crank Set Screw .....
203235	12308	Feed Lifting Cam with 202126 .....
204202	12308	" " " Fork with 200027E .....
200027E	12310	" " " " Pinch Screw .....

8

## Parts for Machine No. 21w4

No.	Plate	Name
203204	12298	Balance Wheel, 5 1/2 in. diam. (belt groove 2 in. diam.), with 206328c and 200335c .....
200062H	12311	Balance Wheel Adjusting Screw ..
200328c	12311	" " Position Screw .....
200335c	12335	" " Set Screw .....
*203205	---	Bed with 202062, 203248, 203249, two each 200362c, 200516E, 200840E and 202299 .....
202258	12153	Bed Hinge Connection (2) .....
200570E	12311	" " " Screw (4) .....
203329	12041	" Slide (back) .....
203207	12041	" " (front) .....
203208	12312	Bobbin .....
203210	12312	" Case Base with 202056, 203211 to 203213 and 203216 .....
203211	12312	Bobbin Case Base Latch .....
*202056	---	" " " " Pin .....
203212	12312	" " " " Plunger .....
203213	12312	" " " " Spring .....
203209	12312	" " Cap with 200984c, 203214, 203215 and two 200594c .....
203214	12312	Bobbin Case Tension Spring .....
200984c	12312	" " " " Regulating Screw .....
200594c	12312	Bobbin Case Tension Spring Screw .....
203215	12312	" " Thread Guide .....
200594c	12312	" " " " Screw ..
203216	12312	" " Washer (cloth) .....
203217	12312	Bobbin Case complete, Nos. 203209 and 203210 .....
200459D	12306	Cloth Guide Thumb Screw .....
204184	12298	Face Plate with 200355H, 200368H, 200688c, 202690, 204185, 204281 and two 200397H .....
200053c	12311	Face Plate Screw .....
204185	12310	" " Thread Guide .....
200397H	12309	" " " " Set Screw .....
204186	12298	Face Plate complete, Nos. 200135E, 200309E, 200319c, 200577H, 204059, 204184, 204267, 204272 and 204277 to 204280 .....
203218	10999	Feed Bar with 204189 .....
203761	---	" " 203218 with 200214E, 201525E and 204200 .....
200214E	12310	Feed Bar Hinge Screw .....
201525E	11143	" " " " Nut .....
204188	12310	" " Spring .....
204189	12306	" " " Hook .....
211079	12001	" Dog .....

## Parts for Machine No. 21w4

11

No.	Plate	Name
*203239	—	Hook (sewing) .....
203240	12312	" 203239 with 201253E, 201376F and 203251 .....
203290	12312	Hook and Bobbin Case complete, Nos. 203217 and 203240 .....
203241	12312	Hook Bevel Gear Socket, 24 teeth
200555H	12312	" " " " Screw ...
203242	12305	" " Pinion, 24 teeth, with two 200383c .....
200383c	12311	Hook Bevel Pinion Set Screw ....
203243	12041	" Counter Shaft .....
203244	12309	" " " Collar with two 200393c .....
200393c	12308	Hook Counter Shaft Collar Set Screw .....
203245	13049	Hook Counter Shaft Driving Gear, 44 teeth, with 200362c and 200439c
213154	12305	Hook Counter Shaft Driving Gear 203245 with 200045E and 203235..
200439c	12311	Hook Counter Shaft Driving Gear Position Screw .....
200362c	12311	Hook Counter Shaft Driving Gear Set Screw .....
203246	12305	Hook Counter Shaft Gear, 22 teeth, with two 200383c .....
200383c	12311	Hook Counter Shaft Gear Set Screw
202299	—	" " " Oil Packing (wick) .....
200840E	12223	Hook Counter Shaft Oil Packing (wick) Stop Screw .....
203247	12298	Hook Driving Shaft .....
203248	12304	" " " Bearing with 202299 .....
202299	—	Hook Driving Shaft Bearing Oil Packing (wick) .....
202126	12308	Hook Driving Shaft Bearing Posi- tion Pin .....
200516E	12311	Hook Driving Shaft Bearing Screw
203249	12305	" " " Bushing (eccen- tric) .....
202299	—	Hook Driving Shaft Bushing Oil Packing (wick) .....
200362c	12311	Hook Driving Shaft Bushing Set Screw .....
213141	13049	Hook Driving Shaft Collar with two 200393c .....
200393c	12308	Hook Driving Shaft Collar Set Screw .....

10

## Parts for Machine No. 21w4

No.	Plate	Name
202126	12308	Feed Lifting Cam Position Pin ...
200045E	12310	" " " Screw .....
203236	12298	" " Rock Shaft .....
203316	12298	" " " " 203236 with 203238 .....
202305	12307	Feed Lifting Rock Shaft Center (2)
200043c	12311	" " " " " Set Screw (2) .....
202276	12308	Feed Lifting Rock Shaft Slide Block
203238	12308	" " " " " "
		202276 with 200243E and 201531E
200243E	12310	Feed Lifting Rock Shaft Slide Block Hinge Screw .....
201531E	12308	Feed Lifting Rock Shaft Slide Block Hinge Screw Nut .....
204206	12306	Feed Regulating Handle .....
204207	12304	" " " 204206 with 200098F, 202622, 204208 to 204210, 204213 and 204925 .....
204208	12307	Feed Regulating Handle Adjustable Stop .....
200098F	11143	Feed Regulating Handle Adjustable Stop Screw .....
204925	12306	Feed Regulating Handle Adjustable Stop Screw Washer .....
204209	12307	Feed Regulating Handle Position Pin .....
204210	12306	Feed Regulating Handle Shaft ....
204211	12306	" " " " Crank with 200098F .....
204212	12307	Feed Regulating Handle Shaft Crank Link .....
200271E	12311	Feed Regulating Handle Shaft Crank Link Hinge Screw (lower)
200291E	12307	Feed Regulating Handle Shaft Crank Link Hinge Screw (upper)
200098F	11143	Feed Regulating Handle Shaft Crank Set Screw .....
204213	12307	Feed Regulating Handle Shaft Sleeve (split) .....
200362c	12311	Feed Regulating Handle Shaft Sleeve Set Screw .....
202622	12306	Feed Regulating Handle Shaft Sleeve Washer .....
202036	12310	Feed Regulating Handle Stop Pin
204214	—	Feed Regulating Handle complete, Nos. 200291E, 204207, 204211 and 204212 .....

## Parts for Machine No. 21w4

13

No.	Plate	Name
200086c	12308	Presser Bar Lifting Bracket Pinch Screw .....
204254	12307	Presser Bar Lifting Bracket Position Guide .....
200362c	12311	Presser Bar Lifting Bracket Position Guide Set Screw .....
204327	12306	Presser Bar Packing Washer (felt)
200594E	12310	" " Screw Bushing (lower)
204255	12310	" " Spring .....
200491B	12305	" " Thumb Screw (pressure regulating) .....
229854	11122	Presser Foot .....
200074F	12308	" " Screw .....
202068	12153	Spool Holder Base .....
200575H	12311	" " " Screw .....
204296	12153	" " Wire .....
200079H	12311	" " " Hinge Screw ....
204297	12153	Spool Holder complete, Nos. 200079H, 202068 and 204296 .....
212920	---	Take-up Cam with 200335c and 200430c .....
203268	12304	Take-up Cam 212920 with 200383c, 200658c and 201519E .....
203172	12307	Take-up Cam Friction Washer ....
200430c	12311	" " Position Screw .....
200383c	12311	" " " " Check Screw .....
200335c	12223	Take-up Cam Set Screw .....
203270	12310	" Lever .....
203291	---	" " 203270 with 204263 ..
204263	12310	" " Bearing with 204264 ..
204264	12306	" " " Position Pin ...
200042F	12311	" " " Screw .....
201816	12307	" " Roller .....
203271	12310	Take-up Lever complete, Nos. 200042F, 201816 and 203291 .....
202402	12309	Tension Disc .....
202090	12309	" " Position Pin .....
204267	12310	" Release Lever .....
200688c	13049	" " " Position Screw
200309E	12309	" " " Screw .....
202075	12369	" " Plunger .....
208489	11004	" " Slide .....
206608	11004	" " " Spring .....
202407	12309	" Spring .....
200632B	12309	" Stud .....
200397H	12309	" " Set Screw .....
201572B	12309	" Thumb Nut .....
204271	12309	" Washer .....

12

## Parts for Machine No. 21w4

No.	Plate	Name
203251	12312	Hook Gib .....
201376F	13049	" " Hinge Screw .....
201253F	12312	" " Screw .....
203252	12313	" Saddle with 202299 .....
202299	---	" " Oil Packing (wick) ...
200006E	12307	" " Screw (2) .....
225585	12307	" " " Washer (2) .....
203254	12312	" Washer .....
203253	12313	Hook Saddle complete, Nos. 200555H, 203241, 203252, 203254 and 203290
208490	11000	Knee Lifter Connection Lever ....
227311	---	" " " " 208490 with 227302, 227308 and two 200262H .....
200262H	12306	Knee Lifter Connection Lever Hinge Screw .....
227308	11000	Knee Lifter Connection Lever Lifting Rod with 202302 .....
202302	12306	Knee Lifter Connection Lever Lifting Rod Cotter Pin .....
227302	11000	Knee Lifter Lifting Lever .....
200262H	12306	" " " " Hinge Screw .....
208613	---	Needle Bar (hollow) .....
204247	12304	" " 208613 with 200125F, 200175D and 204250 .....
204248	12307	Needle Bar Connecting Link .....
200658c	12307	" " " " Hinge Screw Stud .....
201519E	12307	Needle Bar Connecting Link Hinge Screw Stud Nut .....
204249	12308	Needle Bar Connecting Stud with 200072c and 202277 .....
202277	---	Needle Bar Connecting Stud Oil Packing (wick) .....
200072c	12308	Needle Bar Connecting Stud Pinch Screw .....
204326	---	Needle Bar Packing Cord (2) ....
200504E	12310	" " Screw Bushing (lower)
200503B	12310	" " " " (upper)
204250	12308	" " Thread Guide .....
200175E	12308	" " " " Screw ..
200125F	12308	" Set Screw .....
204251	12304	Presser Bar (hollow) with 200074F
204252	12308	" " Lifter .....
200550c	12311	" " " Hinge Screw ...
204253	12308	" " Lifting Bracket with 200086c .....

## LIST OF PARTS COMPLETE

FOR

## MACHINE No. 21w15

DROP FEED

For Shirts, Underwear, Corsets, Shirt Waists,  
Wrappers, etc.

No.	Plate	Name
*204161	----	Arm with 200439c, 202036 and 204705 .....
204163	12305	Arm Cap .....
200278H	12311	" " Screw .....
202248	12307	" " Washer .....
204235	13049	" Position Pin (2) .....
200963E	12311	" Screw (3) .....
202005	12308	" " Washer (3) .....
203202	12298	" Shaft .....
204705	12304	" " Bushing (front) .....
200439c	12311	" " Position Screw .....
204440	12041	" " Connection with four 200054E (2) .....
200054E	12307	Arm Shaft Connection Screw .....
202299	----	" " Oil Packing (wick) (2) .....
203204	12298	Balance Wheel, 5½ in. diam. (belt groove 2 in. diam.) with 200328c and 200335c .....
200062H	12311	Balance Wheel Adjusting Screw .....
200328c	12311	" " Position Screw .....
200335c	12335	" " Set Screw .....
*203205	----	Bed with 202062, 203248, 203249, two each 200362c, 200516c, 200840c and 202299 .....
202258	12153	Bed Hinge Connection (2) .....
200570E	12311	" " " Screw (4) .....
203329	12041	" Slide (back) .....
203207	12041	" " (front) .....
203470	12393	Bobbin .....
*203498	----	" Case .....
203648	12393	" " Latch .....
*202056	----	" " " Pin .....
203473	12393	" " " Plunger .....
203474	12393	" " " Spring .....
203499	12039	" " Lever .....
*203476	----	" " " Eccentric .....

## Parts for Machine No. 21w4

No.	Plate	Name
204272	12309	Tension complete, Nos. 200632B, 201572B, 202075, 202407, 204271 and two 202402 .....
204273	12308	Thread Controller Adjusting Collar with 200684H (for Presser Bar) .....
200684H	12308	Thread Controller Adjusting Collar Screw .....
204274	12309	Thread Controller Plate .....
200577H	12311	" " " Screw .....
202098	12309	" " Roller .....
204275	12309	" " " Guard .....
202084	12309	" " " " Washer .....
200300c	12309	" " " Screw .....
204276	12309	" " Spring .....
204333	12309	" " " Guard .....
200581H	12309	" " " " Screw .....
204277	12309	" " " Stop .....
204278	12309	" " " " Driving Gear .....
200319c	12309	Thread Controller Spring Stop Driving Gear Hinge Screw .....
200135E	12309	Thread Controller Spring Stop Screw .....
204279	12309	Thread Controller Spring Stud with 204925 .....
200355H	12319	Thread Controller Spring Stud Set Screw .....
204925	12306	Thread Controller Spring Stud Washer .....
205987	12309	Thread Controller complete, Nos. 200300c, 200581H, 202084, 202098, 204274, 204275 and 204333 .....
204280	12309	Thread Controller and Spring complete, Nos. 204276 and 205987 .....
202413	12310	Thread Guide .....
204281	12309	" Retainer Guide Wire .....
202091	12309	" " Sleeve .....
202092	12309	" " Spring .....
204058	12309	" " Stud .....
200368H	12309	" " " Set Screw .....
204059	12309	Thread Retainer complete, Nos. 202091, 202092 and 204058 .....
211077	12001	Throat Plate, 50 needle hole, for needle sizes 14 and 15 .....
202062	12308	Throat Plate Position Pin .....
200577H	12311	" " Screw (2) .....

## Parts for Machine No. 21w15

17

No.	Plate	Name
201522E	12310	Feed Driving Cam Fork Lever Connection Hinge Screw Nut .....
*204195	---	Feed Driving Cam Fork Lever Shaft .....
204197	12306	Feed Driving Cam Fork Lever Shaft Collar with 200113E .....
200113E	12308	Feed Driving Cam Fork Lever Shaft Collar Set Screw .....
204293	12308	Feed Driving Cam Fork Lever Shaft Position Pin .....
204196	12307	Feed Driving Cam Fork Lever Sleeve (split) .....
200043C	12311	Feed Driving Cam Fork Lever Shaft Sleeve Set Screw .....
201524C	12310	Feed Driving Cam Fork Lever Shaft Sleeve Set Screw Nut ....
204198	12304	Feed Driving Cam Fork Lever complete, Nos. 204192 and 204194 ..
200437C	12311	Feed Driving Cam Position Screw ..
200382C	13049	" " " " Set Screw .....
204199	12298	" " Rock Shaft .....
206554	---	" " " " 204199 with 206002E, 201522E and 204193 ....
202305	12307	Feed Driving Rock Shaft Center (2)
200043C	12311	" " " " " " Set Screw (2) .....
204200	12305	Feed Driving Rock Shaft Crank with 204189 (on left side) and two 200383C .....
200383C	12311	Feed Driving Rock Shaft Crank Set Screw .....
203235	12308	Feed Lifting Cam with 202126 ....
204202	12308	" " " Fork with 200027E
200027E	12310	" " " " Pinch Screw
202126	12308	" " " Position Pin ....
200045E	12310	" " " Screw .....
203236	12298	" " Rock Shaft .....
203316	12298	" " " " 203236 with 203238 .....
202305	12307	Feed Lifting Rock Shaft Center (2)
200043C	12311	" " " " " " Set Screw (2) .....
202276	12308	Feed Lifting Rock Shaft Slide Block .....
203238	12308	Feed Lifting Rock Shaft Slide Block 202276 with 200243E and 201531E .....
200243E	12310	Feed Lifting Rock Shaft Slide Block Hinge Screw .....

16

## Parts for Machine No. 21w15

No.	Plate	Name
204243	11004	Bobbin Case Lever Eccentric Position Pin .....
203506	12039	Bobbin Case Lever Fulcrum .....
200056E	12319	" " " " Screw ..
203478	11004	" " " Slide Stud ....
203214	12312	" " Tension Spring .....
200984C	12312	" " " " Regulat- ing Screw .....
200594C	12312	Bobbin Case Tension Spring Screw
203216	12312	" " Washer (cloth) .....
203500	12039	Bobbin Case complete, Nos. 200594C, 200984C, 202056, 203214, 203216, 203473, 203474, 203498 and 203648
200459D	12306	Cloth Guide Thumb Screw .....
204184	12298	Face Plate with 200355D, 200368D, 200688C, 202090, 204185, 204281 and two 200397D .....
200053C	12311	Face Plate Screw .....
204185	12310	" " Thread Guide .....
200397D	12309	" " " " Set Screw
204186	12298	Face Plate complete, Nos. 200135E, 200509E, 200319C, 200577D, 204059, 204184, 204267, 204272 and 204277 to 204280 .....
203218	10999	Feed Bar with 204189 .....
203761	---	" " 203218 with 200214E, 201525E and 204200 .....
200214E	12310	Feed Bar Hinge Screw .....
201525E	11143	" " " " Nut .....
204188	12310	" " Spring .....
204189	12306	" " " Hook .....
211079	12001	" Dog .....
200106E	12311	" " Screw (2) .....
203233	12305	" Driving Cam with 200382C and 200437C .....
204192	12304	Feed Driving Cam Fork Lever with 204195 and 204293 .....
204193	12041	Feed Driving Cam Fork Lever Connection with 200668C and 201525E
204194	12306	Feed Driving Cam Fork Lever Connection Clamp with 200031E ....
200031E	12311	Feed Driving Cam Fork Lever Connection Clamp Pinch Screw ....
200668C	12310	Feed Driving Cam Fork Lever Connection Clamp Screw Stud .....
201525E	11143	Feed Driving Cam Fork Lever Connection Clamp Screw Stud Nut ..
200062E	12310	Feed Driving Cam Fork Lever Connection Hinge Screw .....



## Parts for Machine No. 21w15

19

No.	Plate	Name
200393c	12308	Hook Counter Shaft Collar Set Screw .....
203245	-----	Hook Counter Shaft Driving Gear, 44 teeth, with 200362c and 200439c
213154	12305	Hook Counter Shaft Driving Gear 203245 with 200045e and 203235...
200439c	12311	Hook Counter Shaft Driving Gear Position Screw .....
200362c	12311	Hook Counter Shaft Driving Gear Set Screw .....
203246	12305	Hook Counter Shaft Gear, 22 teeth, with two 200383c .....
200383c	12311	Hook Counter Shaft Gear Set Screw
202299	-----	" " " Oil Packing (wick) .....
200840E	12223	Hook Counter Shaft Oil Packing (wick) Stop Screw .....
203247	12298	Hook Driving Shaft .....
203248	12304	" " " Bearing with 202299 .....
202299	-----	Hook Driving Shaft Bearing Oil Packing (wick) .....
202126	12308	Hook Driving Shaft Bearing Position Pin .....
200516E	12311	Hook Driving Shaft Bearing Screw
203249	12305	" " " Bushing (eccentric) .....
202299	-----	Hook Driving Shaft Bushing Oil Packing (wick) .....
200362c	12311	Hook Driving Shaft Bushing Set Screw .....
213141	13049	Hook Driving Shaft Collar with two 200393c .....
200393c	12308	Hook Driving Shaft Collar Set Screw .....
203513	11004	Hook Gib .....
201253E	12312	" " Screw .....
203504	12394	" Saddle with 200056E .....
200006E	12307	" " Screw (2) .....
202622	12306	" " " Washer (2) .....
213036	11004	" Washer with 203476 and two 204243 .....
203515	-----	Hook Saddle complete, Nos. 200555u, 203478, 203499, 203504, 203506, 203514, 213036 and 213810
208490	11000	Knee Lifter Connection Lever .....
227311	-----	" " " " 208490 with 227302, 227308 and two 200262u .....

18

## Parts for Machine No. 21w15

No.	Plate	Name
201531E	12308	Feed Lifting Rock Shaft Slide Block Hinge Screw Nut .....
204206	12306	Feed Regulating Handle .....
204207	12304	" " " 204206 with 200098E, 202622, 202408 to 204210, 204213 and 204925 .....
204208	12307	Feed Regulating Handle Adjustable Stop .....
200098E	11143	Feed Regulating Handle Adjustable Stop Screw .....
204925	12306	Feed Regulating Handle Adjustable Stop Screw Washer .....
204209	12307	Feed Regulating Handle Position Pin .....
204210	12306	Feed Regulating Handle Shaft .....
204211	12306	" " " " Crank with 200098E .....
204212	12307	Feed Regulating Handle Shaft Crank Link .....
200271E	12311	Feed Regulating Handle Shaft Crank Link Hinge Screw (lower)
200291E	12307	Feed Regulating Handle Shaft Crank Link Hinge Screw (upper)
200098E	11143	Feed Regulating Handle Shaft Crank Set Screw .....
204213	12307	Feed Regulating Handle Shaft Sleeve (split) .....
200362c	12311	Feed Regulating Handle Shaft Sleeve Set Screw .....
202622	12306	Feed Regulating Handle Shaft Sleeve Washer .....
202036	12310	Feed Regulating Handle Stop Pin
204214	-----	Feed Regulating Handle complete, Nos. 200291E, 204207, 204211 and 204212 .....
*203511	-----	Hook (sewing) .....
203512	11004	" 203511 with 203513 and two 201253E .....
203514	-----	Hook and Bobbin Case complete, Nos. 203500 and 203512 .....
213810	12393	Hook Bevel Gear Socket, 24 teeth...
200555u	12312	" " " " Screw .....
203242	12305	" " Pinion, 24 teeth, with two 200383c .....
200383c	12311	Hook Bevel Pinion Set Screw .....
203243	12041	" Counter Shaft .....
203244	12308	" " " Collar with two 200393c .....

## Parts for Machine No. 21w15

21

No.	Plate	Name
204296	12153	Spool Holder Wire .....
200079u	12311	" " " Hinge Screw ...
204297	12153	Spool Holder complete, Nos. 200079u, 202068 and 204296 .....
212920	-----	Take-up Cam with 200335c and 200430c .....
203268	12304	Take-up Cam 212920 with 200383c, 200658c and 201519e .....
203172	12307	Take-up Cam Friction Washer ....
200430c	12311	" " Position Screw .....
200383c	12311	" " " " Check Screw .....
200335c	12223	Take-up Cam Set Screw .....
203270	12310	" Lever .....
203291	-----	" " 203270 with 204263 ...
204263	12310	" " Bearing with 204264 ...
204264	12306	" " " Position Pin ...
200042F	12311	" " " Screw .....
201816	12307	" " Roller .....
203271	12310	Take-up Lever complete, Nos. 200042F, 201816 and 203291 .....
202402	12309	Tension Disc .....
202090	12309	" " Position Pin .....
204267	12310	" Release Lever .....
200688c	13049	" " " Position Screw
200309E	12309	" " " Screw .....
202075	12309	" " Plunger .....
208489	11004	" " Slide .....
206608	11004	" " " Spring .....
202407	12309	" Spring .....
200632B	12309	" Stud .....
200397H	12309	" " Set Screw .....
201572B	12309	" Thumb Nut .....
204271	12309	" Washer .....
204272	12309	Tension complete, Nos. 200632B, 201572B, 202075, 202407, 204271 and two 202402 .....
204273	12308	Thread Controller Adjusting Collar with 200684u (for Presser Bar) ..
200684u	12308	Thread Controller Adjusting Collar Screw .....
204274	12309	Thread Controller Plate .....
200577H	12311	" " " Screw ....
202098	12309	" " Roller .....
204275	12309	" " " Guard .....
202084	12309	" " " " Washer
200300c	12309	" " " Screw .....
204276	12309	" " Spring .....
204333	12309	" " " Guard .....
200581H	12309	" " " " Screw ..

20

## Parts for Machine No. 21w15

No.	Plate	Name
200262H	12306	Knee Lifter Connection Lever Hinge Screw .....
227308	11000	Knee Lifter Connection Lever Lift- ing Rod with 202302 .....
202302	12306	Knee Lifter Connection Lever Lift- ing Rod Cotter Pin .....
227302	11000	Knee Lifter Lifting Lever .....
200262H	12306	" " " " Hinge Screw .....
208163	----	Needle Bar (hollow) .....
204247	12304	" " 208163 with 200125F, 200175D and 204250 .....
204248	12307	Needle Bar Connecting Link ....
200658c	12307	" " " " Hinge Screw Stud .....
201519E	12307	Needle Bar Connecting Link Hinge Screw Stud Nut .....
204249	12308	Needle Bar Connecting Stud with 200072c and 202277 .....
202277	----	Needle Bar Connecting Stud Oil Packing (wick) .....
200072c	12308	Needle Bar Connecting Stud Pinch Screw .....
204326	----	Needle Bar Packing Cord (2) ....
200504E	12310	" " Screw Bushing (lower)
200503E	12310	" " " " (upper)
204250	12308	" " Thread Guide .....
200175D	12308	" " " " Screw ..
200125F	12308	" Set Screw .....
204251	12304	Presser Bar (hollow) with 200074F
204252	12308	" " Lifter .....
200550c	12311	" " " Hinge Screw ...
204253	12308	" " Lifting Bracket with 200086c .....
200086c	12308	Presser Bar Lifting Bracket Pinch Screw .....
204254	12307	Presser Bar Lifting Bracket Posi- tion Guide .....
200362c	12311	Presser Bar Lifting Bracket Posi- tion Guide Set Screw .....
201327	12306	Presser Bar Packing Washer (felt)
200504F	12310	" " Screw Bushing (lower)
204255	12310	" " Spring .....
200491B	12305	" " Thumb Screw (pres- sure regulating) .....
229854	11122	Presser Foot .....
200074F	12308	" " Screw .....
202068	12153	Spool Holder Base .....
200575H	12311	" " " Screw .....

## LIST OF PARTS COMPLETE

FOR

## MACHINE No. 21w25

DROP FEED. ALTERNATING PRESSERS

For Tailoring, etc.

No.	Plate	Name
*204471	—	Arm with 200439c, 202036 and 204705 .....
204163	12305	Arm Cap .....
200278H	12311	" " Screw .....
202248	12307	" " Washer .....
204235	13049	" Position Pin (2) .....
200963E	12311	" Screw (3) .....
202005	12308	" " Washer (3) .....
213001	11993	" Shaft .....
204705	12304	" " Bushing (front) .....
200439c	12311	" " Position Screw ..
204440	12041	" " Connection with four 200054E (2) .....
200054E	12307	Arm Shaft Connection Screw ....
202299	—	" " Oil Packing (wick) (2)
204805	11993	Balance Wheel, 5 $\frac{1}{4}$ in. diam. (belt groove 2 $\frac{3}{4}$ in. diam.), with 200328c and 200335c .....
200062H	12311	Balance Wheel Adjusting Screw ..
200328c	12311	" " Position Screw .....
200335c	12335	" " Set Screw .....
*203205	—	Bed with 202062, 203248, 203249, two each 200362c, 200516E, 200840E and 202299 .....
202258	12153	Bed Hinge Connection (2) .....
200570E	12311	" " " Screw (4) .....
203329	12041	" Slide (back) .....
203207	12041	" " (front) .....
203208	12312	Bobbin .....
203210	12312	" Case Base with 202056, 203211 to 203213 and 203216 .....
203211	12312	Bobbin Case Base Latch .....
*202056	—	" " " " Pin .....
203212	12312	" " " " Plunger ..
203213	12312	" " " " Spring ...
203209	12312	" " Cap with 200984c, 203214, 203215 and two 200594c..

No.	Plate	Name
204277	12309	Thread Controller Spring Stop ....
204278	12309	" " " " " Driv- ing Gear .....
200319c	12309	Thread Controller Spring Stop Driving Gear Hinge Screw .....
200135E	12309	Thread Controller Spring Stop Screw .....
204279	12309	Thread Controller Spring Stud with 204925 .....
200355H	12319	Thread Controller Spring Stud Set Screw .....
204925	12306	Thread Controller Spring Stud Washer .....
205987	12309	Thread Controller complete, Nos. 200300c, 200581H, 202084, 202098, 204274, 204275 and 204333 .....
204280	12309	Thread Controller and Spring com- plete, Nos. 204276 and 205987 ...
202413	12310	Thread Guide .....
204281	12309	" Retainer Guide Wire .....
202091	12309	" " Sleeve .....
202092	12309	" " Spring .....
204058	12309	" " Stud .....
200368H	12309	" " " Set Screw .....
204059	12309	Thread Retainer complete, Nos. 202091, 202092 and 204058 .....
211202	12018	Throat Plate, 50 needle hole, for needle sizes 14 and 15 .....
202062	12308	Throat Plate Position Pin .....
200577H	12311	" " Screw (2) .....

## Parts for Machine No. 21w25

25

No.	Plate	Name
200113F	12308	Feed Driving Cam Fork Lever Shaft Collar Set Screw .....
204293	12308	Feed Driving Cam Fork Lever Shaft Position Pin .....
204196	12307	Feed Driving Cam Fork Lever Shaft Sleeve (split) .....
200043c	12311	Feed Driving Cam Fork Lever Shaft Sleeve Set Screw .....
201524E	12310	Feed Driving Cam Fork Lever Shaft Sleeve Set Screw Nut ....
204198	12304	Feed Driving Cam Fork Lever complete, Nos. 204192 and 204194 ...
200437c	12311	Feed Driving Cam Position Screw
200382c	13049	" " " " Set Screw .....
204199	12298	" " Rock Shaft .....
206554	—	" " " " 204199 with 200002E, 201522E and 204193 ....
202305	12307	Feed Driving Rock Shaft Center (2)
200043c	12311	" " " " " " Set Screw (2) .....
204200	12305	Feed Driving Rock Shaft Crank with 204189 (on left side) and two 200383c .....
200383c	12311	Feed Driving Rock Shaft Crank Set Screw .....
203235	12308	Feed Lifting Cam with 202126 ....
204202	12308	" " " Fork with 200027E
200027E	12310	" " " " Pinch Screw
202126	12308	" " " Position Pin ....
200045E	12310	" " " Screw .....
203236	12298	" " Rock Shaft .....
203316	12298	" " " " 203236 with 203238 .....
202305	12307	Feed Lifting Rock Shaft Center (2)
200043c	12311	" " " " " " Set Screw (2) .....
202276	12308	Feed Lifting Rock Shaft Slide Block 202276 with 200243E and 201531E .....
200243E	12310	Feed Lifting Rock Shaft Slide Block Hinge Screw .....
201531E	12308	Feed Lifting Rock Shaft Slide Block Hinge Screw Nut .....
204206	12306	Feed Regulating Handle .....
204207	12304	" " " " 204206 with 200098E 202622, 204208 to 204210, 204213 and 204925 .....
204208	12307	Feed Regulating Handle Adjustable Stop .....

24

## Parts for Machine No. 21w25

No.	Plate	Name
203214	12312	Bobbin Case Tension Spring .....
200984c	12312	" " " " Regulat- ing Screw .....
200594c	12312	Bobbin Case Tension Spring Screw
203215	12312	" " Thread Guide .....
200594c	12312	" " " " " Screw ..
203216	12312	" " Washer (cloth) .....
203217	12312	Bobbin Case complete, Nos. 203209 and 203210 .....
200459D	12306	Cloth Guide Thumb Screw .....
204473	11993	Face Plate with 200366D, 200368D, 200685E, 202087, 202090, 204185, 204281 and two 200397D .....
200053c	12311	Face Plate Screw .....
204185	12310	" " Thread Guide .....
200397D	12309	" " " " Set Screw
204474	11993	Face Plate complete, Nos. 200309E, 200577D, 202088, 204059, 204272, 204280, 204473 and 204486 .....
203218	10999	Feed Bar with 204189 .....
203761	—	" " 203218 with 200214E, 201525E and 204200 .....
200214E	12310	Feed Bar Hinge Screw .....
201525E	12310	" " " " Nut .....
204188	12310	" " Spring .....
204189	12306	" " " Hook .....
211107	12005	" Dog .....
200106E	12311	" " Screw (2) .....
203233	12305	" Driving Cam with 200382c and 200437c .....
204192	12304	Feed Driving Cam Fork Lever with 204195 and 204293 .....
204193	12041	Feed Driving Cam Fork Lever Con- nection with 200668c and 201525E
204194	12306	Feed Driving Cam Fork Lever Con- nection Clamp with 200031E ....
200031E	12311	Feed Driving Cam Fork Lever Con- nection Clamp Pinch Screw ....
200668c	12310	Feed Driving Cam Fork Lever Con- nection Clamp Screw Stud .....
201525E	11143	Feed Driving Cam Fork Lever Con- nection Clamp Screw Stud Nut ..
200002E	12310	Feed Driving Cam Fork Lever Con- nection Hinge Screw .....
201522E	12310	Feed Driving Cam Fork Lever Con- nection Hinge Screw Nut .....
*204195	—	Feed Driving Cam Fork Lever Shaft .....
204197	12306	Feed Driving Cam Fork Lever Shaft Collar with 200113F .....

## Parts for Machine No. 21w25

27

No.	Plate	Name
203246	12305	Hook Counter Shaft Gear, 22 teeth, with two 200383c .....
200383c	12311	Hook Counter Shaft Gear Set Screw
202299	---	" " " Oil Packing (wick) .....
200840e	12311	Hook Counter Shaft Oil Packing (wick) Stop Screw .....
203247	12298	Hook Driving Shaft .....
203248	12304	" " " Bearing with 202299 .....
202299	---	Hook Driving Shaft Bearing Oil Packing (wick) .....
202126	12308	Hook Driving Shaft Bearing Position Pin .....
200516e	12311	Hook Driving Shaft Bearing Screw
203249	12305	" " " Bushing (eccentric) .....
202299	---	Hook Driving Shaft Bushing Oil Packing (wick) .....
200362c	12311	Hook Driving Shaft Bushing Set Screw .....
213141	13049	Hook Driving Shaft Collar with two 200393c .....
200393c	12308	Hook Driving Shaft Collar Set Screw .....
203251	12312	Hook Gib .....
201376f	13049	" " Hinge Screw .....
201253f	12312	" " Screw .....
203252	12312	" Saddle with 202299 .....
202299	---	" " Oil Packing (wick) .....
200006e	12307	" " Screw (2) .....
225585	12307	" " " Washer (2) .....
203254	12312	" Washer .....
203253	12312	Hook Saddle complete, Nos. 200555n, 203241, 203252, 203254 and 203290 .....
208490	11000	Knee Lifter Connection Lever .....
227311	---	" " " " 208490 with 227302, 227308 and two 200262n .....
200262n	12306	Knee Lifter Connection Lever Hinge Screw .....
227308	11000	Knee Lifter Connection Lever Lifting Rod with 202302 .....
202302	12306	Knee Lifter Connection Lever Lifting Rod Cotter Pin .....
227302	11000	Knee Lifter Lifting Lever .....
200262n	12306	" " " " Hinge Screw .....

26

## Parts for Machine No. 21w25

No.	Plate	Name
200098f	11143	Feed Regulating Handle Adjustable Stop Screw .....
204925	12305	Feed Regulating Handle Adjustable Stop Screw Washer .....
204209	12307	Feed Regulating Handle Position Pin .....
204210	12306	Feed Regulating Handle Shaft .....
204211	12306	" " " " Crank with 200098f .....
204212	12307	Feed Regulating Handle Shaft Crank Link .....
200271e	12311	Feed Regulating Handle Shaft Crank Link Hinge Screw (lower)
200291e	12307	Feed Regulating Handle Shaft Crank Link Hinge Screw (upper)
200098f	11143	Feed Regulating Handle Shaft Crank Set Screw .....
204213	12307	Feed Regulating Handle Shaft Sleeve (split) .....
200362c	12311	Feed Regulating Handle Shaft Sleeve Set Screw .....
202622	12306	Feed Regulating Handle Shaft Sleeve Washer .....
202036	12310	Feed Regulating Handle Stop Pin
204214	---	Feed Regulating Handle complete, Nos. 200291e, 204207, 204211 and 204212 .....
*203239	---	Hook (sewing) .....
203240	12312	" 203239 with 201253f, 201376f and 203251 .....
203290	12312	Hook and Bobbin Case complete, Nos. 203217 and 203240 .....
203241	12312	Hook Bevel Gear Socket, 24 teeth
200555n	12312	" " " " Screw .....
203242	12305	" " Pinion, 24 teeth, with two 200383c .....
200383c	12311	Hook Bevel Pinion Set Screw .....
203243	12041	" Counter Shaft .....
203244	12308	" " " Collar with two 200393c .....
200393c	12308	Hook Counter Shaft Collar Set Screw .....
203245	---	Hook Counter Shaft Driving Gear, 44 teeth, with 200362c and 200439c
213154	12305	Hook Counter Shaft Driving Gear 203245 with 200045e and 203235..
200439c	12311	Hook Counter Shaft Driving Gear Position Screw .....
200362c	12311	Hook Counter Shaft Driving Gear Set Screw .....

No.	Plate	Name
201506B	12376	Presser Bar Thumb Screw Check Nut .....
202068	12153	Spool Holder Base .....
200575H	12311	" " " Screw .....
204296	12153	" " Wire .....
200079H	12311	" " " Hinge Screw ....
204257	12153	Spool Holder complete, Nos. 200079H, 202068 and 204296 .....
213925	-----	Take-up Cam with 200347c, 200383c, 200387c, 200400c, 200430c and 204479 .....
213005	12031	Take-up Cam complete, Nos. 204418, 213004 and 213925 .....
203172	12307	Take-up Cam Friction Washer ....
200430c	12311	" " Position Screw ....
200383c	12311	" " " " Check Screw .....
200347c	12376	Take-up Cam Set Screw .....
204262	11004	" Lever .....
206556	-----	" " 204262 with 204263 ...
204263	12310	" " Bearing with 204264..
204264	12306	" " " Position Pin ...
200042r	12311	" " " Screw .....
201816	12307	" " Roller .....
204266	-----	Take-up Lever complete, Nos. 200042r, 201816 and 206556 .....
202402	12309	Tension Disc .....
202090	12309	" " Position Pin .....
204486	-----	" Release Lever .....
200685E	12376	" " " Position Screw .....
200309E	12309	" " " Screw .....
202075	12309	" " Plunger .....
206530	11116	" " Slide .....
206608	11004	" " " Spring .....
202407	12309	" Spring .....
200632B	12309	" Stud .....
200397H	12309	" " Set Screw .....
201572B	12309	" Thumb Nut .....
204271	12309	" Washer .....
204272	12309	Tension complete, Nos. 200632B, 201572B, 202075, 202407, 204271 and two 202402 .....
204274	12309	Thread Controller Plate .....
200577H	12311	" " " Screw ....
202098	12309	" " Roller .....
204275	12309	" " Guard .....
202084	12309	" " " Washer .....
200300c	12309	" " " Screw .....
204276	12309	" " Spring .....
204333	12309	" " " Guard .....

No.	Plate	Name
204475	12376	Lifting Lever with 200122H .....
208389	-----	" " 204475 with 200935E, 201534E, 204478 and 206659 .....
213004	11134	Lifting Lever Driving Crank .....
204178	12376	" " " " Link .....
200122H	12039	" " " " " Stop Screw .....
200400c	12039	Lifting Lever Driving Crank Position Screw .....
200387c	12376	Lifting Lever Driving Crank Position Screw Set Screw .....
204479	11004	Lifting Lever Driving Crank Position Screw Set Screw Packing (brass) .....
200181D	12376	Lifting Lever Stop Screw .....
204180	11004	" " Stud Lifting Bracket with 200086c and 200181D .....
208390	-----	Lifting Lever Stud Lifting Bracket 204480 with 208389 .....
200086c	12308	Lifting Lever Stud Lifting Bracket Pinch Screw .....
204595	10505	Lifting Presser Foot .....
200074F	12308	" " " Screw .....
204483	12031	Needle Bar (hollow) with 200125F, 200587D and 204487 .....
204418	11004	Needle Bar Connecting Link .....
204249	12308	" " " Stud with 200072c and 202277 .....
202277	-----	Needle Bar Connecting Stud Oil Packing (wick) .....
200072c	12308	Needle Bar Connecting Stud Pinch Screw .....
204326	-----	Needle Bar Packing Cord (2) .....
200504E	12310	" " Screw Bushing (lower)
200503B	12310	" " " " (upper)
204487	11004	" " Thread Guide .....
200587D	12039	" " " " Screw ..
200125F	12308	" Set Screw .....
204251	12304	Presser Bar (hollow) with 200074E .....
204252	12308	" " Lifter .....
200550c	12311	" " " Hinge Screw ...
204254	12307	" " Lifting Bracket Position Guide .....
200362c	12311	Presser Bar Lifting Bracket Position Guide Set Screw .....
204327	12306	Presser Bar Packing Washer (felt)
200504E	12310	" " Screw Bushing (lower)
204482	11136	" " Spring .....
200491B	12305	" " Thumb Screw (pressure regulating) .....

**LIST OF PARTS COMPLETE**  
FOR  
**MACHINE No. 21w30**

DROP FEED, ROLLER PRESSER

For Leather Work, Shoe Stitching, Glove Making, etc.

No.	Plate	Name
*204161	----	Arm with 200439c, 202036 and 204705 .....
204163	12305	Arm Cap .....
200278n	12311	" " Screw .....
202248	12307	" " " Washer .....
204235	13049	" Position Pin (2) .....
200963E	12311	" Screw (3) .....
202005	12308	" " Washer (3) .....
203202	12298	" Shaft .....
204705	12304	" " Bushing (front) .....
200439c	12311	" " " Position Screw ..
204440	12041	" " Connection with four 200054E (2) .....
200054E	12307	Arm Shaft Connection Screw ....
202299	----	" " Oil Packing (wick) (2)
203204	12298	Balance Wheel, 5½ in. diam. (belt groove 2 in. diam.) with 200328c and 200335c .....
200062n	12311	Balance Wheel Adjusting Screw ..
200328c	12311	" " Position Screw .....
200335c	12335	" " Set Screw .....
*203205	----	Bed with 202062, 203248, 203249, two each 200362c, 200516E, 200840E and 202299 .....
202258	12153	Bed Hinge Connection (2) .....
200570E	12311	" " " Screw (4) ....
203329	12041	" Slide (back) .....
203207	12041	" " (front) .....
203208	12312	Bobbin .....
203210	12312	" Case Base with 202056, 203211 to 203213 and 203216 .....
203211	12312	Bobbin Case Base Latch .....
*202056	----	" " " " Pin .....
203212	12312	" " " " Plunger ..
203213	12312	" " " " Spring ...

No.	Plate	Name
200581n	12309	Thread Controller Spring Guard Screw .....
202087	11116	Thread Controller Spring Stop ....
202088	11116	" " " Stud with 204925 .....
200366n	12039	Thread Controller Spring Stud Set Screw .....
204925	12306	Thread Controller Spring Stud Washer .....
205987	12309	Thread Controller complete, Nos. 200300c, 200581n, 202084, 202098, 204274, 204275 and 204333 .....
204280	12309	Thread Controller and Spring complete, Nos. 204276 and 205987 ...
202413	12310	Thread Guide .....
204281	12309	" Retainer Guide Wire .....
202091	12309	" " Sleeve .....
202092	12309	" " Spring .....
204058	12309	" " Stud .....
200368n	12309	" " " Set Screw .....
204059	12309	Thread Retainer complete, Nos. 202091, 202092 and 204058 .....
211166	12005	Throat Plate, 46 needle hole, for needle sizes 16 and 18 .....
202062	12308	Throat Plate Position Pin .....
200577n	12311	" " Screw (2) .....
206660	----	Vibrating Presser Bar .....
206659	12376	" " " 206660 with 204493 and two 200138b .....
200935F	12039	Vibrating Presser Bar Hinge Screw
201534E	11116	" " " " " " Nut .....
229838	12376	Vibrating Presser Bar Position Stop
200053c	12311	" " " " " " Screw .....
204493	12376	Vibrating Presser Bar Spring ....
200138b	12039	" " " " " Screw
204620	10505	" " " Foot .....
200098F	12307	" " " " " Screw .....
203357	11116	" " " " " Washer

## Parts for Machine No. 21w30

33

No.	Plate	Name
204197	12306	Feed Driving Cam Fork Lever Shaft Collar with 200113F .....
200113F	12308	Feed Driving Cam Fork Lever Shaft Collar Set Screw .....
204293	12308	Feed Driving Cam Fork Lever Shaft Position Pin .....
204196	12307	Feed Driving Cam Fork Lever Shaft Sleeve (split) .....
200043C	12311	Feed Driving Cam Fork Lever Shaft Sleeve Set Screw .....
201524E	12310	Feed Driving Cam Fork Lever Shaft Sleeve Set Screw Nut ....
204198	12304	Feed Driving Cam Fork Lever complete, Nos. 204192 and 204194 ..
200437C	12311	Feed Driving Cam Position Screw
200382C	13049	" " " Set Screw .....
204199	12298	" " Rock Shaft .....
206554	---	" " " " 204199 with 200002E, 201522E and 204193 .....
202305	12307	Feed Driving Rock Shaft Center (2)
200043C	12311	" " " " " Set Screw (2) .....
204290	12305	Feed Driving Rock Shaft Crank with 204189 (on left side) and two 200383C .....
200383C	12311	Feed Driving Rock Shaft Crank Set Screw .....
213007	11136	Feed Lifting Cam with 202126 ....
204202	12308	" " " Fork with 200027E
200027E	12310	" " " " Pinch Screw
202126	12308	" " " Position Pin ...
200045E	12310	" " " Screw .....
203236	12298	" " Rock Shaft .....
203316	12298	" " " " 203236 with 203238 .....
202305	12307	Feed Lifting Rock Shaft Center (2)
200043C	12311	" " " " " Set Screw (2) .....
202276	12308	Feed Lifting Rock Shaft Slide Block
203238	12308	" " " " " " 202276 with 200243E and 201531E
200243E	12310	Feed Lifting Rock Shaft Slide Block Hinge Screw .....
201531E	12308	Feed Lifting Rock Shaft Slide Block Hinge Screw Nut .....
204206	12306	Feed Regulating Handle .....
204207	12304	" " " 204206 with 200098F, 202622, 204208 to 204210, 204213 and 204925 .....

32

## Parts for Machine No. 21w30

No.	Plate	Name
203209	12312	Bobbin Case Cap with 200984C, 203214, 203215 and two 200594C ..
203214	12312	Bobbin Case Tension Spring .....
200984C	12312	" " " " Regulating Screw .....
200594C	12312	Bobbin Case Tension Spring Screw
203215	12312	" " Thread Guide .....
200594C	12312	" " " " Screw ..
203216	12312	" " Washer (cloth) .....
203217	12312	Bobbin Case complete, Nos. 203209 and 203210 .....
204184	12298	Face Plate with 200355N, 200368N, 200688C, 202090, 204185, 204281 and two 200397N .....
200053C	12311	Face Plate Screw .....
204185	12310	" " Thread Guide .....
200397N	12309	" " " " Set Screw
201300	12042	Face Plate complete, Nos. 200113E, 200135E, 200309E, 200319C, 200577N, 204059, 204184, 204267, 204272, 204277 to 204280 and 204330 ....
203218	10999	Feed Bar with 204189 .....
203761	---	" " 203218 with 200214E, 201525E and 204200 .....
200214E	12310	Feed Bar Hinge Screw .....
201525E	11143	" " " " Nut .....
204188	12310	" " Spring .....
204189	12306	" " " Hook .....
211255	12026	" Dog .....
200106E	12311	" " Screw (2) .....
203233	12305	" Driving Cam with 200382C and 200437C .....
204192	12304	Feed Driving Cam Fork Lever with 204195 and 204293 .....
204193	12041	Feed Driving Cam Fork Lever Connection with 200668C and 201525E
204194	12306	Feed Driving Cam Fork Lever Connection Clamp with 200031E ....
200031E	12311	Feed Driving Cam Fork Lever Connection Clamp Pinch Screw ....
200668C	12310	Feed Driving Cam Fork Lever Connection Clamp Screw Stud .....
201525E	11143	Feed Driving Cam Fork Lever Connection Clamp Screw Stud ..
200002E	12310	Feed Driving Cam Fork Lever Connection Hinge Screw .....
201522E	12310	Feed Driving Cam Fork Lever Connection Hinge Screw Nut .....
*204195	---	Feed Driving Cam Fork Lever Shaft .....



Parts for Machine No. 21w30

No.	Plate	Name
200562c	12311	Hook Counter Shaft Driving Gear Set Screw .....
203246	12305	Hook Counter Shaft Gear, 22 teeth, with two 200383c .....
200383c	12311	Hook Counter Shaft Gear Set Screw
202299	-----	" " " Oil Packing (wick) .....
200840e	12223	Hook Counter Shaft Oil Packing (wick) Stop Screw .....
203247	12298	Hook Driving Shaft .....
203248	12304	" " " Bearing with 202299 .....
202299	-----	Hook Driving Shaft Bearing Oil Packing (wick) .....
202126	12308	Hook Driving Shaft Bearing Position Pin .....
206516e	12311	Hook Driving Shaft Bearing Screw
203249	12305	" " " Bushing (eccentric) .....
202299	-----	Hook Driving Shaft Bushing Oil Packing (wick) .....
200362c	12311	Hook Driving Shaft Bushing Set Screw .....
213141	13049	Hook Driving Shaft Collar with two 200393c .....
200393c	12308	Hook Driving Shaft Collar Set Screw .....
203251	12312	Hook Gib .....
201376e	13049	" " Hinge Screw .....
201253e	12312	" " Screw .....
203252	12313	" Saddle with 202299 .....
202299	-----	" " Oil Packing (wick) .....
200006e	12307	" " Screw (2) .....
225585	12307	" " " Washer (2) .....
203718	11241	" Washer .....
203466	-----	Hook Saddle complete, Nos. 200555d, 203241, 203252, 203465 and 203718
208490	11000	Knee Lifter Connection Lever .....
227311	-----	" " " " 208490 with 227302, 227308 and two 200262d .....
200262d	12306	Knee Lifter Connection Lever Hinge Screw .....
227308	11000	Knee Lifter Connection Lever Lifting Rod with 202302 .....
202302	12306	Knee Lifter Connection Lever Lifting Rod Cotter Pin .....
227302	11000	Knee Lifter Lifting Lever .....
200262d	12306	" " " " Hinge Screw .....

Parts for Machine No. 21w30

No.	Plate	Name
204208	12307	Feed Regulating Handle Adjustable Stop .....
200098e	11143	Feed Regulating Handle Adjustable Stop Screw .....
204925	12306	Feed Regulating Handle Adjustable Stop Screw Washer .....
204209	12307	Feed Regulating Handle Position Pin .....
204210	12306	Feed Regulating Handle Shaft .....
204211	12306	" " " " Crank with 200098e .....
204212	12307	Feed Regulating Handle Shaft Crank Link .....
200271e	12311	Feed Regulating Handle Shaft Crank Link Hinge Screw (lower)
200291e	12307	Feed Regulating Handle Shaft Crank Link Hinge Screw (upper)
200098e	11143	Feed Regulating Handle Shaft Crank Set Screw .....
204213	12307	Feed Regulating Handle Shaft Sleeve (split) .....
200362c	12311	Feed Regulating Handle Shaft Sleeve Set Screw .....
202622	12306	Feed Regulating Handle Shaft Sleeve Washer .....
202026	12310	Feed Regulating Handle Stop Pin .....
204214	-----	Feed Regulating Handle complete, Nos. 200291e, 204207, 204211 and 204212 .....
*203463	-----	Hook (sewing) .....
203464	11241	" 203463 with 201253e, 201376e and 203251 .....
203465	11241	Hook and Bobbin Case complete, Nos. 203217 and 203464 .....
203241	12312	Hook Bevel Gear Socket, 24 teeth .....
200555d	12312	" " " " Screw .....
203242	12305	" " Pinion, 24 teeth, with two 200383c .....
200383c	12311	Hook Bevel Pinion Set Screw .....
203243	12041	" Counter Shaft .....
203244	12308	" " " Collar with two 200393c .....
200393c	12308	Hook Counter Shaft Collar Set Screw .....
203245	13049	Hook Counter Shaft Driving Gear, 44 teeth, with 200362c and 200439c
213157	-----	Hook Counter Shaft Driving Gear 203245 with 200045e and 213007 .....
200439c	12311	Hook Counter Shaft Driving Gear Position Screw .....

No.	Plate	Name
200141F	11124	Roller Presser Arm Bracket Spring Stop Screw .....
200096D	11124	Roller Presser Arm Screw .....
204495	10999	" " Bar .....
200551C	11124	" " Hinge Screw .....
201534H	11116	" " " " Nut .....
204576	-----	Roller Presser and Bar complete, Nos. 200675C, 202558, 202559, 204495, 208499 and two 200141F...
202068	12153	Spool Holder Base .....
200575H	12311	" " " Screw .....
204296	12153	" " Wire .....
200079H	12311	" " " Hinge Screw ...
204297	12153	Spool Holder complete, Nos. 200079H, 202068 and 204296 .....
213006	13049	Take-up Cam with 200335C, 200383C, 200430C, 200658C and 201519E ...
203172	12307	Take-up Cam Friction Washer ....
200430C	12311	" " Position Screw .....
200383C	12311	" " " " Check Screw .....
200335C	12311	Take-up Cam Set Screw .....
203270	12310	" Lever .....
203291	-----	" " 203270 with 204263 ...
204263	12310	" " Bearing with 204264 ...
204264	12306	" " " Position Pin ...
200042F	12311	" " " Screw .....
201816	12307	" " Roller .....
203271	12310	Take-up Lever complete, Nos. 200042F, 201816 and 203291 .....
202402	12309	Tension Disc .....
202090	12309	" " Position Pin .....
204267	12310	" Release Lever .....
200688C	13049	" " " Position Screw
200309E	12309	" " " Screw .....
202075	12309	" " Plunger .....
208489	11004	" " Slide .....
206608	11004	" " " Spring .....
202407	12309	" Spring .....
200632B	12309	" Stud .....
200397H	12309	" " Set Screw .....
201572B	12309	" Thumb Nut .....
204271	12309	" Washer .....
204272	12309	Tension complete, Nos. 200632B, 201572B, 202075, 202407, 204271 and two 202402 .....
204273	12308	Thread Controller Adjusting Collar with 200684H (for Presser Bar)
200684H	12308	Thread Controller Adjusting Collar Screw .....

No.	Plate	Name
208613	---	Needle Bar (hollow) .....
204247	12304	" " 208613 with 200125F, 200175D and 204250 .....
204248	12307	Needle Bar Connecting Link .....
200658C	12307	" " " " Hinge Screw Stud .....
201519E	12307	Needle Bar Connecting Link Hinge Screw Stud Nut .....
204249	12308	Needle Bar Connecting Stud with 200027C and 202277 .....
202277	-----	Needle Bar Connecting Stud Oil Packing (wick) .....
200072C	12308	Needle Bar Connecting Stud Pinch Screw .....
204326	---	Needle Bar Packing Cord (2) .....
200504E	12310	" " Screw Bushing (lower)
200503B	12310	" " " " (upper)
204250	12308	" " Thread Guide .....
200175D	12308	" " " " Screw ...
200125F	12308	" Set Screw .....
204252	12308	Presser Bar Lifter .....
200550C	12311	" " " Hinge Screw ...
204253	12308	" " Lifting Bracket with 200086C .....
200086C	12308	Presser Bar Lifting Bracket Pinch Screw .....
204254	12307	Presser Bar Lifting Bracket Posi- tion Guide .....
200362C	12311	Presser Bar Lifting Bracket Posi- tion Guide Set Screw .....
204327	12306	Presser Bar Packing Washer (felt)
200504E	12310	" " Screw Bushing (lower)
204258	13049	" " Spring .....
200491B	12305	" " Thumb Screw (pres- sure regulating) .....
201910	10169	Roller Presser, $\frac{3}{8}$ in. diam., $\frac{1}{4}$ in. face (coarse), with 200551C and 201534H .....
208497	-----	Roller Presser Arm .....
208498	11124	" " " 208497 with 201910 .....
202560	11124	Roller Presser Arm Bracket (swing)
208499	-----	" " " " 202560 with 200096D and 208498 .....
200675C	11124	Roller Presser Arm Bracket Posi- tion Screw Stud .....
202558	11124	Roller Presser Arm Bracket Spring
202559	11124	" " " " " " Stop .....

**LIST OF PARTS COMPLETE**  
**FOR**  
**MACHINE No. 21w50**

**DROP FEED. ROLLER PRESSER**

For Shoes, Gloves, etc.

No.	Plate	Name
*204161	----	Arm with 200439c, 202036 and 204705 .....
204163	12305	Arm Cap .....
200278u	12311	" " Screw .....
202248	12307	" " " Washer .....
204235	13049	" Position Pin (2) .....
200963E	12311	" Screw (3) .....
202005	12308	" " Washer (3) .....
203202	12298	" Shaft .....
204705	12304	" " Bushing (front) .....
200439c	12311	" " " Position Screw .....
204440	12041	" " Connection with four 200054E (2) .....
200054E	12307	Arm Shaft Connection Screw .....
202299	----	" " Oil Packing (wick) (2) .....
203204	12298	Balance Wheel, 5½ in. diam. (belt groove 2 in. diam.), with 200328c and 200335c .....
200062u	12311	Balance Wheel Adjusting Screw .....
200328c	12311	" " Position Screw .....
200335c	12311	" " Set Screw .....
*203205	----	Bed with 202062, 203248, 203249, two each 200362c, 200516E, 200840E and 202299 .....
202258	12153	Bed Hinge Connection (2) .....
200570E	12311	" " " Screw (4) .....
203329	12041	" Slide (back) .....
203207	12041	" " (front) .....
203470	12393	Bobbin .....
*203498	----	" Case .....
203648	12393	" " Latch .....
*202056	----	" " " Pin .....
203473	12393	" " " Plunger .....
203474	12393	" " " Spring .....
203499	12039	" " Lever .....
*203476	----	" " " Eccentric .....
204243	11004	" " " Position Pin .....
203506	12039	" " " Fulcrum .....

No.	Plate	Name
204274	12309	Thread Controller Plate .....
200577u	12311	" " " Screw .....
202098	12309	" " Roller .....
204275	12309	" " " Guard .....
202084	12309	" " " Washer .....
200300c	12309	" " " Screw .....
204276	12309	" " Spring .....
204333	12309	" " " Guard .....
200581u	12309	" " " " Screw .....
204277	12309	" " " Stop .....
204278	12309	" " " " Driving Gear .....
200319c	12309	Thread Controller Spring Stop Driving Gear Hinge Screw .....
200135c	12309	Thread Controller Spring Stop Screw .....
204279	12309	Thread Controller Spring Stud with 204925 .....
200355u	12319	Thread Controller Spring Stud Set Screw .....
204925	12306	Thread Controller Spring Stud Washer .....
205987	12309	Thread Controller complete, Nos. 200300c, 200581u, 202084, 202098, 204274, 204275 and 204333 .....
204280	12309	Thread Controller and Spring complete, Nos. 204276 and 205987 .....
202413	12310	Thread Guide .....
204329	----	" Oiler (felt) .....
204330	11116	" " Bracket with 204329 .....
200113E	12308	" " " Screw .....
204281	12309	" Retainer Guide Wire .....
202091	12309	" " Sleeve .....
202092	12309	" " Spring .....
204058	12309	" " Stud .....
200368u	12309	" " " Set Screw .....
204059	12309	Thread Retainer complete, Nos. 202091, 202092 and 204058 .....
211253	12026	Throat Plate, 50 needle hole, for needle sizes 14 and 15 .....
202062	12308	Throat Plate Position Pin .....
200577u	12311	" " Screw (2) .....

No.	Plate	Name
200113F	12308	Feed Driving Cam Fork Lever Shaft Collar Set Screw .....
204293	12308	Feed Driving Cam Fork Lever Shaft Position Pin .....
204196	12307	Feed Driving Cam Fork Lever Shaft Sleeve (split) .....
200043c	12311	Feed Driving Cam Fork Lever Shaft Sleeve Set Screw .....
201524E	12310	Feed Driving Cam Fork Lever Shaft Sleeve Set Screw Nut .....
204198	12304	Feed Driving Cam Fork Lever complete, Nos. 204192 and 204194 ...
200437c	12311	Feed Driving Cam Position Screw
200382c	13049	" " " Set Screw .....
204199	12298	" " Rock Shaft .....
206554	---	" " " " 204199 with 200002E, 201522E and 204193 ....
202305	12307	Feed Driving Rock Shaft Center (2)
200043c	12311	" " " " " Set Screw (2) .....
204200	12305	Feed Driving Rock Shaft Crank with 204189 (on left side) and two 200383c .....
200383c	12311	Feed Driving Rock Shaft Crank Set Screw .....
213007	11136	Feed Lifting Cam with 202126 ....
204202	12308	" " " Fork with 200027E
200027E	12310	" " " " Pinch Screw
202126	12308	" " " Position Pin ....
200045E	12310	" " " Screw .....
203236	12298	" " Rock Shaft .....
203316	12298	" " " " 203236 with 203238 .....
202305	12307	Feed Lifting Rock Shaft Center (2)
200043c	12311	" " " " " Set Screw (2) .....
202276	12308	Feed Lifting Rock Shaft Slide Block
203238	12308	" " " " " " " 202276 with 200243E and 201531E
200243E	12310	Feed Lifting Rock Shaft Slide Block Hinge Screw .....
201531E	12308	Feed Lifting Rock Shaft Slide Block Hinge Screw Nut .....
204206	12306	Feed Regulating Handle .....
204207	12304	" " " 204206 with 200098E, 202622, 204208 to 204210, 204213 and 204925 .....
204208	12307	Feed Regulating Handle Adjustable Stop .....

No.	Plate	Name
200056E	12319	Robbin Case Lever Fulcrum Screw
203478	11004	" " " Slide Stud ....
203214	12312	" " Tension Spring .....
200984c	12312	" " " " Regulating Screw .....
200594c	12312	Bobbin Case Tension Spring Screw
203216	12312	" " Washer (cloth) .....
203500	12039	Robbin Case complete, Nos. 200594c, 200984c, 202056, 203214, 203216, 203473, 203474, 203498 and 203648
204184	12298	Face Plate with 200355u, 200368u, 200688c, 202690, 204185, 204281 and two 200397u .....
200053c	12311	Face Plate Screw .....
204185	12310	" " Thread Guide .....
200397u	12309	" " " " Set Screw
204300	12042	Face Plate complete, Nos. 200113E, 200135E, 200309E, 200319c, 200577u, 204059, 204184, 204267, 204272, 204277 to 204280 and 204330 .....
203218	10999	Feed Bar with 204189 .....
203761	---	" " 203218 with 200214E, 201525E and 204200 .....
200214E	12310	Feed Bar Hinge Screw .....
201525E	11143	" " " " Nut .....
204188	12310	" " Spring .....
204189	12306	" " " Hook .....
211263	12026	" Dog .....
200406E	12311	" " Screw (2) .....
203233	12305	" Driving Cam with 200382c and 200437c .....
204192	12304	Feed Driving Cam Fork Lever with 204195 and 204293 .....
204193	12041	Feed Driving Cam Fork Lever Connection with 200668c and 201525E
204194	12306	Feed Driving Cam Fork Lever Connection Clamp with 200031E ....
200031E	12311	Feed Driving Cam Fork Lever Connection Clamp Pinch Screw ....
200668c	12310	Feed Driving Cam Fork Lever Connection Clamp Screw Stud .....
201525E	11143	Feed Driving Cam Fork Lever Connection Clamp Screw Stud Nut...
200002E	12310	Feed Driving Cam Fork Lever Connection Hinge Screw .....
201522E	12310	Feed Driving Cam Fork Lever Connection Hinge Screw Nut .....
*204195	---	Feed Driving Cam Fork Lever Shaft
204197	12306	" " " " " " " Collar with 200113E .....

## Parts for Machine No. 21w50

43

No.	Plate	Name
203246	12305	Hook Counter Shaft Gear, 22 teeth, with two 200383c .....
200383c	12311	Hook Counter Shaft Gear Set Screw
202299	----	" " " Oil Packing (wick) .....
200840E	12223	Hook Counter Shaft Oil Packing (wick) Stop Screw .....
203247	12298	Hook Driving Shaft .....
203248	12304	" " " Bearing with 202299 .....
202299	----	Hook Driving Shaft Bearing Oil Packing (wick) .....
202126	12308	Hook Driving Shaft Bearing Position Pin .....
200516E	12311	Hook Driving Shaft Bearing Screw
203249	12305	" " " Bushing (eccentric) .....
202299	----	Hook Driving Shaft Bushing Oil Packing (wick) .....
200362c	12311	Hook Driving Shaft Bushing Set Screw .....
213141	13049	Hook Driving Shaft Collar with two 200393c .....
200393c	12308	Hook Driving Shaft Collar Set Screw .....
203251	12312	Hook Gib .....
201376F	13049	" " Hinge Screw .....
201253F	12312	" " Screw .....
203504	12394	" Saddle with 200056E .....
200006E	12307	" " Screw (2) .....
202622	12306	" " " Washer (2) .....
213018	12393	" Washer with 203476 and two 204243 .....
203505	12394	Hook Saddle complete, Nos. 200555H, 203478, 203499, 203503, 203504, 203506, 213018 and 213810
208490	11000	Knee Lifter Connection Lever .....
227311	----	" " " " 208490 with 227302, 227308 and two 200262H .....
200262H	12306	Knee Lifter Connection Lever Hinge Screw .....
227308	11000	Knee Lifter Connection Lever Lifting Rod with 202302 .....
202302	12306	Knee Lifter Connection Lever Lifting Rod Cotter Pin .....
227302	11000	Knee Lifter Lifting Lever .....
200262H	12306	" " " " Hinge Screw .....

42

## Parts for Machine No. 21w50

No.	Plate	Name
200098F	11143	Feed Regulating Handle Adjustable Stop Screw .....
204925	12306	Feed Regulating Handle Adjustable Stop Screw Washer .....
204209	12307	Feed Regulating Handle Position Pin .....
204210	12306	Feed Regulating Handle Shaft .....
204211	12306	" " " " Crank with 200098F .....
204212	12307	Feed Regulating Handle Shaft Crank Link .....
200271E	12311	Feed Regulating Handle Shaft Crank Link Hinge Screw (lower)
200291E	12307	Feed Regulating Handle Shaft Crank Link Hinge Screw (upper)
200098F	12307	Feed Regulating Handle Shaft Crank Set Screw .....
204213	12307	Feed Regulating Handle Shaft Sleeve (split) .....
200362c	12311	Feed Regulating Handle Shaft Sleeve Set Screw .....
202622	12306	Feed Regulating Handle Shaft Sleeve Washer .....
202036	12310	Feed Regulating Handle Stop Pin..
204214		Feed Regulating Handle complete, Nos. 200291E, 204207, 204211 and 204212 .....
*203482	----	Hook (sewing) .....
203483	12393	" 203482 with 201253F, 201376F and 203251 .....
203503	12393	Hook and Bobbin Case complete, Nos. 203483 and 203500 .....
213810	12393	Hook Bevel Gear Socket, 24 teeth..
200555H	12312	" " " " Screw .....
203242	12305	" " Pinion, 24 teeth, with two 200383c .....
200383c	12311	Hook Bevel Pinion Set Screw .....
203243	12041	" Counter Shaft .....
203244	12308	" " " Collar with two 200393c .....
200393c	12308	Hook Counter Shaft Collar Set Screw .....
203245	13049	Hook Counter Shaft Driving Gear, 44 teeth, with 200362c and 200439c
213157	--	Hook Counter Shaft Driving Gear 203245 with 200045E and 213007..
200439c	12311	Hook Counter Shaft Driving Gear Position Screw .....
200362c	12311	Hook Counter Shaft Driving Gear Set Screw .....

Parts for Machine No. 21w50

15

No.	Plate	Name
200141r	11124	Roller Presser Arm Bracket Spring Stop Screw .....
200096b	11124	Roller Presser Arm Screw .....
204495	10999	" " Bar .....
200551c	11124	" " Hinge Screw .....
201534n	11116	" " " " Nut ....
204576	----	Roller Presser and Bar complete, Nos. 200675c, 202558, 202559, 204495, 208499 and two 200141r ..
202068	12153	Spool Holder Base .....
200575n	12311	" " " Screw .....
204296	12153	" " Wire .....
200079n	12311	" " " Hinge Screw ....
204297	12153	Spool Holder complete, Nos. 200079n, 202068 and 204296 .....
213006	13049	Take-up Cam with 200335c, 200383c, 200430c, 200658c and 201519r ....
203172	12307	Take-up Cam Friction Washer ...
200430c	12311	" " Position Screw .....
200383c	12311	" " " " Check Screw .....
200335c	12311	Take-up Cam Set Screw .....
203270	12310	" Lever .....
203291	----	" " 203270 with 204263 ...
204263	12310	" " Bearing with 204264..
204264	12306	" " " Position Pin ...
200042r	12311	" " " Screw .....
201816	12307	" " Roller .....
203271	12310	Take-up Lever complete, Nos. 200042r, 201816 and 203291 .....
202402	12309	Tension Disc .....
202090	12309	" " Position Pin .....
204267	12310	" Release Lever .....
200688c	13049	" " " Position Screw .....
200309e	12309	" " " Screw .....
202075	12309	" " Plunger .....
208489	11004	" " Slide .....
206608	11004	" " " Spring .....
202407	12309	" Spring .....
200632n	12309	" Stud .....
200397n	12309	" " Set Screw .....
201572b	12309	" Thumb Nut .....
204271	12309	" Washer .....
204272	12309	Tension complete, Nos. 200632n, 201572n, 202075, 202407, 204271 and two 202402 .....
204273	12308	Thread Controller Adjusting Collar with 200684n (for Presser Bar)..
200684n	12308	Thread Controller Adjusting Collar Screw .....

11

Parts for Machine No. 21w50

No.	Plate	Name
208613	----	Needle Bar (hollow) .....
204247	12304	" " 208613 with 200125r, 200175b and 204250 .....
204248	12307	Needle Bar Connecting Link .....
200658c	12307	" " " " Hinge Screw Stud .....
201519e	12307	Needle Bar Connecting Link Hinge Screw Stud Nut .....
204249	12308	Needle Bar Connecting Stud with 200072c and 202277 .....
202277	----	Needle Bar Connecting Stud Oil Packing (wick) .....
200072c	12308	Needle Bar Connecting Stud Pinch Screw .....
204326	----	Needle Bar Packing Cord (2) .....
200504e	12310	" " Screw Bushing (lower)
200503n	12310	" " " " (upper)
204250	12308	" " Thread Guide .....
200175b	12308	" " " " Screw ...
200125e	12308	" Set Screw .....
204252	12308	Presser Bar Lifter .....
200550c	12311	" " " Hinge Screw ...
204253	12308	" " Lifting Bracket with 200086c .....
200086c	12308	Presser Bar Lifting Bracket Pinch Screw .....
204254	12307	Presser Bar Lifting Bracket Position Guide .....
200362c	12311	Presser Bar Lifting Bracket Position Guide Set Screw .....
204327	12306	Presser Bar Packing Washer (felt)
209504e	12310	" " Screw Bushing (lower)
204258	13049	" " Spring .....
200491b	12305	" " Thumb Screw (pressure regulating) .....
201910	10169	Roller Presser, $\frac{11}{16}$ in. diam., $\frac{1}{4}$ in. face (coarse), with 200551c and 201534n .....
208497	----	Roller Presser Arm .....
208498	11124	" " " 208497 with 201910 .....
202560	11124	Roller Presser Arm Bracket (swing)
208499	----	" " " " 202560 with 200096b and 208498 .....
200675c	11124	Roller Presser Arm Bracket Position Screw Stud .....
202558	11124	Roller Presser Arm Bracket Spring
202559	11124	" " " " " " Stop .....

**LIST OF PARTS COMPLETE**  
**FOR**  
**MACHINE No. 21w54**  
**DROP FEED. ALTERNATING PRESSER**

For General Leather Work

No.	Plate	Name
*204471	—	Arm with 200439c, 202036 and 204705 .....
204163	12305	Arm Cap .....
200278H	12311	" " Screw .....
202248	12307	" " Washer .....
204235	13049	" Position Pin (2) .....
200963E	12311	" Screw (3) .....
202005	12308	" " Washer (3) .....
213001	11993	" Shaft .....
204705	12304	" " Bushing (front) .....
200439c	12311	" " " Position Screw ..
204440	12041	" " Connection with four 200054c (2) .....
200054E	12307	Arm Shaft Connection Screw .....
202299	—	" " Oil Packing (wick) (2)
204805	11993	Balance Wheel, 5½ in. diam. (belt groove 2¾ in. diam.), with 200328c and 200335c .....
200062H	12311	Balance Wheel Adjusting Screw ..
200328c	12311	" " Position Screw .....
200335c	12335	" " Set Screw .....
*203205	—	Bed with 202062, 203248, 203249, two each 200362c, 200516E, 200840E and 202299 .....
202258	12153	Bed Hinge Connection (2) .....
200570E	12311	" " " Screw (4) .....
203329	12041	" Slide (back) .....
203207	12041	" " (front) .....
203470	12393	Bobbin .....
*203498	—	" Case .....
203648	12393	" " Latch .....
*202056	—	" " " Pin .....
203473	12393	" " " Plunger .....
203474	12393	" " " Spring .....
203499	12039	" " Lever .....
*203476	—	" " " Eccentric .....

No.	Plate	Name
204274	12309	Thread Controller Plate .....
200577H	12311	" " " Screw .....
202098	12309	" " Roller .....
204275	12309	" " " Guard .....
202084	12309	" " " Washer .....
200300c	12309	" " " Screw .....
204276	12309	" " Spring .....
204333	12309	" " " Guard .....
200581H	12309	" " " " Screw ..
204277	12309	" " " Stop .....
204278	12309	" " " " Driving Gear .....
200319c	12309	Thread Controller Spring Stop Driving Gear Hinge Screw .....
200135E	12309	Thread Controller Spring Stop Screw .....
204279	12309	Thread Controller Spring Stud with 204925 .....
200355H	12319	Thread Controller Spring Stud Set Screw .....
204925	12306	Thread Controller Spring Stud Washer .....
205987	12309	Thread Controller complete, Nos. 200300c, 200581H, 202084, 202098, 204274, 204275 and 204333 .....
204280	12309	Thread Controller and Spring complete, Nos. 204276 and 205987 ..
202413	12310	Thread Guide .....
204329	—	" Oiler (felt) .....
204330	11116	" " Bracket with 204329 ..
200113F	12308	" " " Screw .....
204281	12309	" Retainer Guide Wire .....
202091	12309	" " Sleeve .....
202092	12309	" " Spring .....
204058	12309	" " Stud .....
200368H	12309	" " " Set Screw .....
204059	12309	Thread Retainer complete, Nos. 202091, 202092 and 204058 .....
211329	12037	Throat Plate, 50 needle hole, for needle sizes 14 and 15 .....
202062	12308	Throat Plate Position Pin .....
200577H	12311	" " " Screw (2) .....

## Parts for Machine No. 21w54

49

No.	Plate	Name
*204195	----	Feed Driving Cam Fork Lever Shaft
204197	12306	" " " " " "
		Collar with 200113F .....
200113F	12308	Feed Driving Cam Fork Lever Shaft
		Collar Set Screw .....
204293	12308	Feed Driving Cam Fork Lever Shaft
		Position Pin .....
204196	12307	Feed Driving Cam Fork Lever Shaft
		Sleeve (split) .....
200043c	12311	Feed Driving Cam Fork Lever Shaft
		Sleeve Set Screw .....
201524E	12310	Feed Driving Cam Fork Lever Shaft
		Sleeve Set Screw Nut .....
204198	12304	Feed Driving Cam Fork Lever complete, Nos. 204192 and 204194 ...
200437c	12311	Feed Driving Cam Position Screw
200382c	13049	" " " Set Screw .....
204199	12298	" " Rock Shaft .....
206554	----	" " " " 204199 with 200002E, 201522E and 204193 ...
202305	12307	Feed Driving Rock Shaft Center (2)
200043c	12311	" " " " " Set Screw (2) .....
204200	12305	Feed Driving Rock Shaft Crank with 204189 (on left side) and two 200383c .....
200383c	12311	Feed Driving Rock Shaft Crank Set Screw .....
213007	11136	Feed Lifting Cam with 202126 ....
204202	12308	" " " Fork with 200027E
200027E	12310	" " " " Pinch Screw
202126	12308	" " " Position Pin ....
200045E	12310	" " " Screw .....
203236	12298	" " Rock Shaft .....
203316	12298	" " " " 203236 with 203238 .....
202305	12307	Feed Lifting Rock Shaft Center (2)
200043c	12311	" " " " " Set Screw (2) .....
202276	12308	Feed Lifting Rock Shaft Slide Block
203238	12308	" " " " " " 202276 with 200243E and 201531E
200243E	12310	Feed Lifting Rock Shaft Slide Block
		Hinge Screw .....
201531c	12308	Feed Lifting Rock Shaft Slide Block
		Hinge Screw Nut .....
204206	12306	Feed Regulating Handle .....
204207	12304	" " " 204206 with 200098E, 202622, 204208 to 204210, 204213 and 204925 .....

48

## Parts for Machine No. 21w54

No.	Plate	Name
204243	11004	Bobbin Case Lever Eccentric Position Pin .....
203506	12039	Bobbin Case Lever Fulcrum .....
200056E	12319	" " " " Screw .....
203478	11004	" " " Slide Stud ....
203214	12312	" " Tension Spring ....
200984c	12312	" " " " Regulating Screw .....
200594c	12312	Bobbin Case Tension Spring Screw
203216	12312	" " Washer (cloth) .....
203500	12039	Bobbin Case complete, Nos. 200594c, 203984c, 202056, 203214, 203216, 203473, 203474, 203498 and 203648
204473	11993	Face Plate with 200366u, 200368u, 200685E, 202087, 202090, 204185, 204281 and two 200397H .....
200053c	12311	Face Plate Screw .....
204185	12310	" " Thread Guide .....
200397H	12309	" " " " Set Screw
203773	12042	Face Plate complete, Nos. 200113E, 200309E, 200577H, 202088, 203357, 204059, 204272, 204280, 204473, 204486 and 204644 .....
203218	10999	Feed Bar with 204189 .....
203761	----	" " 203218 with 200214E, 201525E and 204200 .....
200214E	12310	Feed Bar Hinge Screw .....
201525E	12310	" " " " Nut .....
204188	12310	" " Spring .....
204189	12306	" " " Hook .....
211107	12005	" Dog .....
200106E	12311	" " Screw .....
203233	12305	" Driving Cam with 200382c and 200437c .....
204192	12304	Feed Driving Cam Fork Lever with 204195 and 204293 .....
204193	12041	Feed Driving Cam Fork Lever Connection with 200668c and 201525E
204194	12306	Feed Driving Cam Fork Lever Connection Clamp with 200031F ....
200031F	12311	Feed Driving Cam Fork Lever Connection Clamp Pinch Screw ....
200668c	12310	Feed Driving Cam Fork Lever Connection Clamp Screw Stud .....
201525E	11143	Feed Driving Cam Fork Lever Connection Clamp Screw Stud Nut..
200002E	12310	Feed Driving Cam Fork Lever Connection Hinge Screw .....
201522E	12310	Feed Driving Cam Fork Lever Connection Hinge Screw Nut .....



## Parts for Machine No. 21w54

51

No.	Plate	Name
200362c	12311	Hook Counter Shaft Driving Gear Set Screw .....
203246	12305	Hook Counter Shaft Gear, 22 teeth, with two 200383c .....
200383c	12311	Hook Counter Shaft Gear Set Screw
202299	—	" " " Oil Packing (wick) .....
200840E	12223	Hook Counter Shaft Oil Packing (wick) Stop Screw .....
203247	12298	Hook Driving Shaft .....
203248	12304	" " " Bearing with 202299 .....
202299	—	Hook Driving Shaft Bearing Oil Packing (wick) .....
202126	12308	Hook Driving Shaft Bearing Position Pin .....
200516E	12311	Hook Driving Shaft Bearing Screw
203249	12305	" " " Bushing (eccentric) .....
202299	—	Hook Driving Shaft Bushing Oil Packing (wick) .....
200362c	12311	Hook Driving Shaft Bushing Set Screw .....
213141	13049	Hook Driving Shaft Collar with two 200393c .....
200393c	12308	Hook Driving Shaft Collar Set Screw .....
203251	12312	Hook Gib .....
201376F	13049	" " Hinge Screw .....
201253F	12312	" " Screw .....
203504	12394	" Saddle with 200056E .....
200006E	12307	" " Screw (2) .....
202622	12306	" " Washer (2) .....
213018	12393	" Washer with 203476 and two 204243 .....
203505	12394	Hook Saddle complete, Nos. 200555H, 203478, 203499, 203503, 203504, 203506, 213018 and 213810
208490	11000	Knee Lifter Connection Lever .....
227311	—	" " " " 208490 with 227302, 227308 and two 200262H .....
200262H	12306	Knee Lifter Connection Lever Hinge Screw .....
227308	11000	Knee Lifter Connection Lever Lifting Rod with 202302 .....
202302	12306	Knee Lifter Connection Lever Lifting Rod Cotter Pin .....
227302	11000	Knee Lifter Lifting Lever .....
200262H	12306	" " " " Hinge Screw .....

50

## Parts for Machine No. 21w54

No.	Plate	Name
204208	12307	Feed Regulating Handle Adjustable Stop .....
200098E	11143	Feed Regulating Handle Adjustable Stop Screw .....
204925	12306	Feed Regulating Handle Adjustable Stop Screw Washer .....
204209	12307	Feed Regulating Handle Position Pin .....
204210	12306	Feed Regulating Handle Shaft .....
204211	12306	" " " " Crank with 200098E .....
204212	12307	Feed Regulating Handle Shaft Crank Link .....
200271E	12311	Feed Regulating Handle Shaft Crank Link Hinge Screw (lower)
200291E	12307	Feed Regulating Handle Shaft Crank Link Hinge Screw (upper)
200098E	11143	Feed Regulating Handle Shaft Crank Set Screw .....
204213	12307	Feed Regulating Handle Shaft Sleeve (split) .....
200362c	12311	Feed Regulating Handle Shaft Sleeve Set Screw .....
202622	12306	Feed Regulating Handle Shaft Sleeve Washer .....
202036	12310	Feed Regulating Handle Stop Pin
204214	—	Feed Regulating Handle complete, Nos. 200291E, 204207, 204211 and 204212 .....
*203482	—	Hook (sewing) .....
203483	12393	" 203482 with 201253E, 201376F and 203251 .....
203503	12393	Hook and Bobbin Case complete, Nos. 203483 and 203500 .....
213810	12393	Hook Bevel Gear Socket, 24 teeth
200555H	12312	" " " " Screw .....
203242	12305	" " Pinion, 24 teeth, with two 200383c .....
200383c	12311	Hook Bevel Pinion Set Screw .....
203243	12041	" Counter Shaft .....
203244	12308	" " " Collar with two 200393c .....
200393c	12308	Hook Counter Shaft Collar Set Screw .....
203245	—	Hook Counter Shaft Driving Gear, 44 teeth, with 200362c and 200439c
213157	—	Hook Counter Shaft Driving Gear 203245 with 200045E and 213007..
200439c	12311	Hook Counter Shaft Driving Gear Position Screw .....

## Parts for Machine No. 21w54

53

No.	Plate	Name
201506B	12376	Presser Bar Thumb Screw Check Nut .....
202068	12153	Spool Holder Base .....
200575H	12311	" " Screw .....
204296	12153	" " Wire .....
200079H	12311	" " Hinge Screw .....
204297	12153	Spool Holder complete, Nos. 200079H, 202068 and 204296 .....
213008	12041	Take-up Cam with 200347c, 200383c, 200387c, 200400c, 200430c and 204479 .....
203172	12307	Take-up Cam Friction Washer .....
200430c	12311	" " Position Screw .....
200383c	12311	" " " " Check Screw .....
200347c	12376	Take-up Cam Set Screw .....
213923	---	Take-up Cam complete, Nos. 204418, 213004 and 213008 .....
203270	12310	Take-up Lever .....
203291	---	" " 203270 with 204263 ..
204263	12310	" " Bearing with 204261 ..
204264	12306	" " " Position Pin ..
200042F	12311	" " " Screw .....
201816	12307	" " Roller .....
203271	12310	Take-up Lever complete, Nos. 200042F, 201816 and 203291 .....
202402	12309	Tension Disc .....
202090	12309	" " Position Pin .....
204486	---	" Release Lever .....
200685E	12376	" " " Position Screw .....
200309E	12309	" " " Screw .....
202075	12309	" " Plunger .....
206530	11116	" " Slide .....
206608	11004	" " " Spring .....
202407	12309	" Spring .....
200632B	12309	" Stud .....
200397H	12309	" " Set Screw .....
201572B	12309	" Thumb Nut .....
204271	12309	" Washer .....
204272	12309	Tension complete, Nos. 200632B, 201572B, 202075, 202407, 204271 and two 202402 .....
204274	12309	Thread Controller Plate .....
200577H	12311	" " " Screw .....
202098	12309	" " Roller .....
204275	12309	" " " Guard .....
202084	12309	" " " Washer .....
200300c	12309	" " " Screw .....
204276	12309	" " Spring .....
204333	12309	" " " Guard .....

52

## Parts for Machine No. 21w54

No.	Plate	Name
204475	12376	Lifting Lever with 200122H .....
208389	---	" " 204475 with 200935E, 201534E, 204478 and 206659 .....
213004	11134	Lifting Lever Driving Crank .....
204478	12376	" " " " Link .....
200122H	12039	" " " " Stop Screw .....
200400c	12039	Lifting Lever Driving Crank Position Screw .....
200387c	12376	Lifting Lever Driving Crank Position Screw Set Screw .....
204479	11004	Lifting Lever Driving Crank Position Screw Set Screw Packing (brass) .....
200181D	12376	Lifting Lever Stop Screw .....
204480	11004	" " Stud Lifting Bracket with 200086c and 200181D .....
208390	---	Lifting Lever Stud Lifting Bracket 204480 with 208389 .....
200086c	12308	Lifting Lever Stud Lifting Bracket Pinch Screw .....
204603	13034	Lifting Presser Foot .....
200074F	12308	" " " Screw .....
204483	12031	Needle Bar (hollow) with 200125F, 200587D and 204487 .....
204418	11004	Needle Bar Connecting Link .....
204249	12308	" " " Stud with 200072c and 202277 .....
202277	---	Needle Bar Connecting Stud Oil Packing (wick) .....
200072c	12308	Needle Bar Connecting Stud Pinch Screw .....
204326	---	Needle Bar Packing Cord (2) .....
200504E	12310	" " Screw Bushing (lower) .....
200503B	12310	" " " " (upper) .....
204487	11004	" " Thread Guide .....
200587D	12039	" " " " Screw ..
200125F	12308	" Set Screw .....
204251	12304	Presser Bar (hollow) with 200074F .....
204252	12308	" " Lifter .....
200550c	12311	" " " Hinge Screw .....
204254	12307	" " Lifting Bracket Position Guide .....
200362c	12311	Presser Bar Lifting Bracket Position Guide Set Screw .....
204327	12306	Presser Bar Packing Washer (felt) .....
200504E	12310	" " Screw Bushing (lower) .....
204482	11136	" " Spring .....
200491B	12305	" " Thumb Screw (pressure regulating) .....

**LIST OF PARTS COMPLETE**  
**FOR**  
**MACHINE No. 21w115**

**DROP FEED**

For Shirts, Underwear, Shirt Waists, Wrappers,  
Corsets, etc.

No.	Plate	Name
*204290	---	Arm with 200439c, 202036 and 204705 .....
204163	12305	Arm Cap .....
200278H	12311	" " Screw .....
202248	12307	" " " Washer .....
204235	13049	" Position Pin (2) .....
200963E	12311	" Screw (3) .....
202005	12308	" " Washer (3) .....
213622	12298	" Shaft .....
204705	12304	" " Bushing (front) .....
200439c	12311	" " " Position Screw ..
204440	12041	" " Connection with four 200054E (2) .....
200054E	12307	Arm Shaft Connection Screw .....
202299	---	" " Oil Packing (wick) (2)
203204	12298	Balance Wheel, 5½ in. diam. (belt groove 2 in. diam.), with 200328c 200335c .....
200062H	12311	Balance Wheel Adjusting Screw ..
200328c	12311	" " Position Screw .....
200335c	12335	" " Set Screw .....
*213623	---	Bed with 202062, 203248, 203249, two each 200362c, 200516E, 200840E and 202299 .....
202258	12153	Bed Hinge Connection (2) .....
200570E	12311	" " " Screw, (4) .....
203329	12041	" Slide (back) .....
203207	12041	" " (front) .....
203470	12393	Bobbin .....
*203498	---	" Case .....
203648	12393	" " Latch .....
*202056	---	" " " Pin .....
203473	12393	" " " Plunger .....
203474	12393	" " " Spring .....
203499	12039	" " Lever .....

No.	Plate	Name
200581H	12309	Thread Controller Spring Guard Screw .....
202087	11116	Thread Controller Spring Stop .....
202088	11116	" " " Stud with 204925 .....
200366H	12039	Thread Controller Spring Stud Set Screw .....
204925	12306	Thread Controller Spring Stud Washer .....
205987	12309	Thread Controller complete, Nos. 200300c, 200581H, 202084, 202098, 204274, 204275 and 204333 .....
204280	12309	Thread Controller and Spring complete, Nos. 204276 and 205987 .....
202413	12310	Thread Guide .....
204329	---	" Oiler (felt) .....
204644	11116	" " Bracket with 204329 ..
200113F	12308	" " " Screw .....
203357	11116	" " " " Washer .....
204281	12309	" Retainer Guide Wire .....
202091	12309	" " Sleeve .....
202092	12309	" " Spring .....
204058	12309	" " Stud .....
200368H	12309	" " " Set Screw .....
204059	12309	Thread Retainer complete, Nos. 202091, 202092 and 204058 .....
211215	12019	Throat Plate, 50 needle hole, for needle sizes 14 and 15 .....
202062	12308	Throat Plate Position Pin .....
200577H	12311	" " Screw (2) .....
206660	---	Vibrating Presser Bar .....
206659	12376	" " " 206660 with 204493 and two 200138D .....
200935F	12039	Vibrating Presser Bar Hinge Screw
201534E	11116	" " " " " Nut .....
229838	12376	Vibrating Presser Bar Position Stop
200053c	12311	" " " " " Screw .....
204493	12376	Vibrating Presser Bar Spring .....
200138D	12039	" " " " Screw
206672	13036	" " Foot .....
200098F	12307	" " " Screw .....
203357	11116	" " " " Washer

## Parts for Machine No. 21w115

57

No.	Plate	Name
201522E	12310	Feed Driving Cam Fork Lever Connection Hinge Screw Nut .....
*204195	---	Feed Driving Cam Fork Lever Shaft
204197	12306	" " " " "
		Collar with 200113E .....
200113E	12308	Feed Driving Cam Fork Lever Shaft Collar Set Screw .....
204293	12308	Feed Driving Cam Fork Lever Shaft Position Pin .....
204196	12307	Feed Driving Cam Fork Lever Shaft Sleeve (split) .....
200043C	12311	Feed Driving Cam Fork Lever Shaft Sleeve Set Screw .....
201524E	12310	Feed Driving Cam Fork Lever Shaft Sleeve Set Screw Nut .....
204198	12304	Feed Driving Cam Fork Lever complete, Nos. 204192 and 204194 ..
200437C	12311	Feed Driving Cam Position Screw
200382C	13049	" " " Set Screw .....
204294	12298	" " Rock Shaft .....
206555	---	" " " " 204294 with 200002E, 201522E and 204193 .....
202305	12307	Feed Driving Rock Shaft Center (2)
200043C	12311	" " " " " Set Screw (2) .....
204200	12305	Feed Driving Rock Shaft Crank with 204189 (on left side) and two 200383C .....
200383C	12311	Feed Driving Rock Shaft Crank Set Screw .....
203235	12308	Feed Lifting Cam with 202126 .....
204202	12303	" " " Fork with 200027E
200027E	12310	" " " Pinch Screw
202126	12308	" " " Position Pin .....
200045E	12310	" " " Screw .....
203236	12298	" " Rock Shaft .....
203316	12298	" " " " 203236 with 203238 .....
202305	12307	Feed Lifting Rock Shaft Center (2)
200043C	12311	" " " " " Set Screw (2) .....
202276	12308	Feed Lifting Rock Shaft Slide Block
203238	12310	" " " " " "
		202276 with 200243E and 201531E
200243E	12310	Feed Lifting Rock Shaft Slide Block Hinge Screw .....
201531E	12308	Feed Lifting Rock Shaft Slide Block Hinge Screw Nut .....
204206	12306	Feed Regulating Handle .....

56

## Parts for Machine No. 21w115

No.	Plate	Name
*203476	---	Bobbin Case Lever Eccentric .....
204243	11004	" " " " Position Pin .....
203506	12039	Bobbin Case Lever Fulcrum .....
200056E	12319	" " " " Screw ..
203478	11004	" " " Slide Stud .....
203214	12312	" " Tension Spring .....
200984C	12312	" " " " Regulating Screw .....
200594C	12312	Bobbin Case Tension Spring Screw
203216	12312	" " Washer (cloth) .....
203500	12039	Bobbin Case complete, Nos. 200594C, 200984C, 202056, 203214, 203216, 203473, 203474, 203498 and 203648
200459D	12306	Cloth Guide Thumb Screw .....
204184	12298	Face Plate with 200355D, 200368D, 200688C, 202090, 204185, 204281 and two 200397D .....
200053C	12311	Face Plate Screw .....
204185	12310	" " Thread Guide .....
200397D	12309	" " " " Set Screw
204186	12298	Face Plate complete, Nos. 200135E, 200309E, 200319C, 200577D, 204059, 204184, 204267, 204272 and 204277 to 204280 .....
203218	10999	Feed Bar with 204189 .....
203761	---	" " 203218 with 200214E, 201525E and 204200 .....
200214E	12310	Feed Bar Hinge Screw .....
201525E	12310	" " " " Nut .....
204188	12310	" " Spring .....
204189	12306	" " Hook .....
211079	12001	" Dog .....
200106E	12311	" " Screw (2) .....
203233	12305	" Driving Cam with 200382C and 200437C .....
204192	12304	Feed Driving Cam Fork Lever with 204195 and 204293 .....
204193	12041	Feed Driving Cam Fork Lever Connection with 200668C and 201525E
204194	12306	Feed Driving Cam Fork Lever Connection Clamp with 200031E .....
200031E	12311	Feed Driving Cam Fork Lever Connection Clamp Pinch Screw .....
206668C	12310	Feed Driving Cam Fork Lever Connection Clamp Screw Stud .....
201525E	11143	Feed Driving Cam Fork Lever Connection Clamp Screw Stud Nut ..
200002E	12310	Feed Driving Cam Fork Lever Connection Hinge Screw .....

## Parts for Machine No. 21w115

59

No.	Plate	Name
213154	12305	Hook Counter Shaft Driving Gear 203245 with 200045E and 203235...
200439C	12311	Hook Counter Shaft Driving Gear Position Screw .....
200362C	12311	Hook Counter Shaft Driving Gear Set Screw .....
203246	12305	Hook Counter Shaft Gear, 22 teeth, with two 200383C .....
200383C	12311	Hook Counter Shaft Gear Set Screw
202299	—	" " " Oil Packing (wick) .....
200840E	12223	Hook Counter Shaft Oil Packing (wick) Stop Screw .....
213624	12298	Hook Driving Shaft .....
203248	12304	" " " Bearing with 202299 .....
202299	—	Hook Driving Shaft Bearing Oil Packing (wick) .....
202126	12308	Hook Driving Shaft Bearing Position Pin .....
200516E	12311	Hook Driving Shaft Bearing Screw
203249	12305	" " " Bushing (eccentric) .....
202299	—	Hook Driving Shaft Bushing Oil Packing (wick) .....
200362C	12311	Hook Driving Shaft Bushing Set Screw .....
213141	13049	Hook Driving Shaft Collar with two 200393C .....
200393C	12308	Hook Driving Shaft Collar Set Screw .....
203513	11004	Hook Gib .....
201253F	12312	" " Screw .....
203504	12394	" Saddle with 200056E .....
200006E	12307	" " Screw (2) .....
202622	12306	" " Washer (2) .....
213036	11004	" Washer with 203476 and two 204243 .....
203515	—	Hook Saddle complete, Nos. 200555H, 203478, 203499, 203504, 203506, 203514, 213036 and 213810
208490	11000	Knee Lifter Connection Lever ....
227312	—	" " " " 208490 with 227303, 227308 and two 200262H .....
200262H	12306	Knee Lifter Connection Lever Hinge Screw .....
227308	11000	Knee Lifter Connection Lever Lifting Rod with 202302 .....

58

## Parts for Machine No. 21w115

No.	Plate	Name
204207	12304	Feed Regulating Handle 204206 with 200098F, 202622, 204208 to 204210, 204213 and 204925 .....
204208	12307	Feed Regulating Handle Adjustable Stop .....
200098F	11143	Feed Regulating Handle Adjustable Stop Screw .....
204925	12306	Feed Regulating Handle Adjustable Stop Screw Washer .....
204209	12307	Feed Regulating Handle Position Pin .....
204210	12306	Feed Regulating Handle Shaft ....
204211	12306	" " " " Crank with 200098F .....
204212	12307	Feed Regulating Handle Shaft Crank Link .....
200271E	12311	Feed Regulating Handle Shaft Crank Link Hinge Screw (lower)
200291E	12307	Feed Regulating Handle Shaft Crank Link Hinge Screw (upper)
200098F	11143	Feed Regulating Handle Shaft Crank Set Screw .....
204213	12307	Feed Regulating Handle Shaft Sleeve (split) .....
200362C	12311	Feed Regulating Handle Shaft Sleeve Set Screw .....
202622	12306	Feed Regulating Handle Shaft Sleeve Washer .....
202036	12310	Feed Regulating Handle Stop Pin
204214	—	Feed Regulating Handle complete, Nos. 200291E, 204207, 204211 and 204212 .....
*203511	—	Hook (sewing) .....
203512	11004	" 203511 with 203513 and two 201253F .....
203514	—	Hook and Bobbin Case complete, Nos. 203500 and 203512 .....
213810	12393	Hook Bevel Gear Socket, 24 teeth...
200555H	12312	" " " " Screw ....
203242	12305	" " Pinion, 24 teeth, with two 200383C .....
200383C	12311	Hook Bevel Pinion Set Screw ....
203243	12041	" Counter Shaft .....
203244	12308	" " " Collar with two 200393C .....
200393C	12308	Hook Counter Shaft Collar Set Screw .....
203245	13049	Hook Counter Shaft Driving Gear, 44 teeth, with 200362C and 200439C

## Parts for Machine No. 21w115

61

No.	Plate	Name
212920	---	Take-up Cam with 200335c and 200430c .....
203268	12304	Take-up Cam 212920 with 200383c, 200658c and 201519E .....
203172	12307	Take-up Cam Friction Washer .....
200430c	12311	" " Position Screw .....
200383c	12311	" " " Check Screw .....
200335c	12223	Take-up Cam Set Screw .....
203270	12310	" Lever .....
203291	---	" " 203270 with 204263 .....
204263	12310	" " Bearing with 204264 .....
204264	12306	" " " Position Pin .....
200042F	12311	" " " Screw .....
201816	12307	" " Roller .....
203271	12310	Take-up Lever complete, Nos. 200042F, 201816 and 203291 .....
202402	12309	Tension Disc .....
202090	12309	" " Position Pin .....
204267	12310	" Release Lever .....
200688c	13049	" " " Position Screw .....
200309E	12309	" " " Screw .....
202075	12309	" " Plunger .....
208489	11004	" " Slide .....
206608	11004	" " Spring .....
202407	12309	" Spring .....
200632B	12309	" Stud .....
200397H	12309	" " Set Screw .....
201572B	12309	" Thumb Nut .....
204271	12309	" Washer .....
204272	12309	Tension complete, Nos. 200632B, 201572B, 202075, 202407, 204271 and two 202402 .....
204273	12308	Thread Controller Adjusting Collar with 200684H (for Presser Bar) .....
200684H	12308	Thread Controller Adjusting Collar Screw .....
204274	12309	Thread Controller Plate .....
200577H	12311	" " " Screw .....
202098	12309	" " Roller .....
204275	12309	" " Guard .....
202084	12309	" " " Washer .....
200300c	12309	" " " Screw .....
204276	12309	" " Spring .....
204333	12309	" " " Guard .....
200581H	12309	" " " Screw .....
204277	12309	" " " Stop .....
204278	12309	" " " Driving Gear .....

60

## Parts for Machine No. 21w115

No.	Plate	Name
202302	12306	Knee Lifter Connection Lever Lifting Rod Cotter Pin .....
227303	11006	Knee Lifter Lifting Lever .....
200262H	12306	" " " Hinge Screw .....
208613	---	Needle Bar (hollow) .....
204247	12304	" " 208613 with 200125F, 200175D and 204250 .....
204248	12307	Needle Bar Connecting Link .....
200658c	12307	" " " " Hinge Screw Stud .....
201519E	12307	Needle Bar Connecting Link Hinge Screw Stud Nut .....
204249	12308	Needle Bar Connecting Stud with 200072c and 202277 .....
202277	---	Needle Bar Connecting Stud Oil Packing (wick) .....
200072c	12308	Needle Bar Connecting Stud Pinch Screw .....
204326	---	Needle Bar Packing Cord (2) .....
200504E	12310	" " Screw Bushing (lower) .....
200503B	12310	" " " " (upper) .....
204250	12308	" " Thread Guide .....
200175D	12308	" " " " Screw .....
200125F	12308	" Set Screw .....
204251	12304	Presser Bar (hollow) with 200074F .....
204252	12308	" " Lifter .....
200550c	12311	" " " Hinge Screw .....
204253	12308	" " Lifting Bracket with 200086c .....
200086c	12308	Presser Bar Lifting Bracket Pinch Screw .....
204254	12307	Presser Bar Lifting Bracket Position Guide .....
200362c	12311	Presser Bar Lifting Bracket Position Guide Set Screw .....
204327	12306	Presser Bar Packing Washer (felt) .....
200504E	12310	" " Screw Bushing (lower) .....
204255	12310	" " Spring .....
200491B	12305	" " Thumb Screw (pressure regulating) .....
229854	11122	Presser Foot .....
200074F	12308	" " Screw .....
202068	12153	Spool Holder Base .....
200575H	12311	" " " Screw .....
204296	12153	" " Wire .....
200079H	12311	" " " Hinge Screw .....
204297	12153	Spool Holder complete, Nos. 200079H, 202068 and 204296 .....

**LIST OF PARTS COMPLETE**  
FOR  
**MACHINE No. 21w118**  
DROP FEED

For Overalls, Duck Coats, Canvas, etc.

No.	Plate	Name
*204290	----	Arm with 200439c, 202036 and 204705 .....
204163	12305	Arm Cap .....
200278H	12311	" " Screw .....
202248	12307	" " Washer .....
204235	13049	" Position Pin (2) .....
200963E	12311	" Screw (3) .....
202005	12308	" " Washer (3) .....
213622	12298	" Shaft .....
204705	12304	" " Bushing (front) .....
200439c	12311	" " " Position Screw ..
204440	12041	" " Connection with four 200054E (2) .....
200054E	12307	Arm Shaft Connection Screw .....
202299	----	" " Oil Packing (wick) ..
203204	12258	Balance Wheel, 5½ in. diam. (belt groove 2 in. diam.), with 200328c and 200335c .....
200062H	12311	Balance Wheel Adjusting Screw ..
200328c	12311	" " Position Screw .....
200335c	12335	" " Set Screw .....
*213623	----	Bed with 202062, 203248, 203249, two each 200362c, 200516E, 200840E and 202299 .....
202258	12153	Bed Hinge Connection (2) .....
200570E	12311	" " " Screw (4) .....
203329	12041	" Slide (back) .....
203207	12041	" " (front) .....
203470	12393	Bobbin .....
*203498	----	" Case .....
203648	12393	" " Latch .....
*202056	----	" " " Pin .....
203473	12393	" " " Plunger .....
203474	12393	" " " Spring .....
203499	12039	" " Lever .....
*203476	----	" " " Eccentric .....
204243	11004	" " " " Position Pin .....

No.	Plate	Name
206319c	12309	Thread Controller Spring Stop Driving Gear Hinge Screw .....
200135E	12309	Thread Controller Spring Stop Screw .....
204279	12309	Thread Controller Spring Stud with 204925 .....
200355H	12319	Thread Controller Spring Stud Set Screw .....
204925	12306	Thread Controller Spring Stud Washer .....
205987	12309	Thread Controller complete, Nos. 200300c, 200581H, 202084, 202098, 204274, 204275 and 204333 .....
204280	12309	Thread Controller and Spring complete, Nos. 204276 and 205987 ..
202413	12310	Thread Guide .....
204281	12309	" Retainer Guide Wire .....
202091	12309	" " Sleeve .....
202092	12309	" " Spring .....
204058	12309	" " Stud .....
200368H	12309	" " " Set Screw .....
204059	12309	Thread Retainer complete, Nos. 202091, 202092 and 204058 .....
211202	12018	Throat Plate, 50 needle hole, for needle sizes 14 and 15 .....
202062	12308	Throat Plate Position Pin .....
200577H	12311	" " Screw (2) .....

No.	Plate	Name
*204195	—	Feed Driving Cam Fork Lever Shaft
204197	12306	“ “ “ “ “ “ Collar with 200113F .....
200113F	12308	Feed Driving Cam Fork Lever Shaft Collar Set Screw .....
204293	12308	Feed Driving Cam Fork Lever Shaft Position Pin .....
204196	12307	Feed Driving Cam Fork Lever Shaft Sleeve (split) .....
200043C	12311	Feed Driving Cam Fork Lever Shaft Sleeve Set Screw .....
201524E	12310	Feed Driving Cam Fork Lever Shaft Sleeve Set Screw Nut .....
204198	12304	Feed Driving Cam Fork Lever com- plete, Nos. 204192 and 204194 ...
200437C	12311	Feed Driving Cam Position Screw
200382C	13049	“ “ “ Set Screw .....
204294	12298	“ “ Rock Shaft .....
206555	—	“ “ “ “ 204294 with 200002E, 201522E and 204193 ....
202305	12307	Feed Driving Rock Shaft Center (2)
200043C	12311	“ “ “ “ “ Set Screw (2) .....
204200	12305	Feed Driving Rock Shaft Crank with 204189 (on left side) and two 200383C .....
200383C	12311	Feed Driving Rock Shaft Crank Set Screw .....
203235	12308	Feed Lifting Cam with 202126 ....
204202	12308	“ “ “ Fork with 200027E
200027E	12310	“ “ “ “ Pinch Screw
202126	12308	“ “ “ Position Pin ...
200045E	12310	“ “ “ Screw .....
203236	12298	“ “ Rock Shaft .....
203316	12298	“ “ “ “ 203236 with 203238 .....
202305	12307	Feed Lifting Rock Shaft Center (2)
200043C	12311	“ “ “ “ “ Set Screw (2) .....
202276	12308	Feed Lifting Rock Shaft Slide Block
203238	12308	“ “ “ “ “ “ 202276 with 200243E and 201531E
200243E	12310	Feed Lifting Rock Shaft Slide Block Hinge Screw .....
201531E	12308	Feed Lifting Rock Shaft Slide Block Hinge Screw Nut .....
204206	12306	Feed Regulating Handle .....
204207	12304	“ “ “ 204206 with 200098F, 202622, 204208 to 204210, 204213 and 204925 .....

No.	Plate	Name
203506	12039	Bobbin Case Lever Fulcrum .....
200056F	12319	“ “ “ “ Screw ..
203478	11004	“ “ “ Slide Stud .....
203214	12312	“ “ Tension Spring .....
200984C	12312	“ “ “ “ Regulat- ing Screw .....
200594C	12312	Bobbin Case Tension Spring Screw
203216	12312	“ “ Washer (cloth) .....
203500	12039	Bobbin Case complete, Nos. 200594C, 200984C, 202056, 203214, 203216, 203473, 203474, 203498 and 203648
200459D	12306	Cloth Guide Thumb Screw .....
204184	12298	Face Plate with 200355U, 200368U, 200688C, 202090, 204185, 204281 and two 200397U .....
200053C	12311	Face Plate Screw .....
204185	12310	“ “ Thread Guide .....
200397H	12309	“ “ “ “ Set Screw
204186	12298	Face Plate complete, Nos. 200135E, 200309E, 200319C, 200577U, 204059, 204184, 204267, 204272 and 204277 to 204280 .....
203218	10999	Feed Bar with 204189 .....
203761	—	“ “ 203218 with 200214E, 201525E and 204200 .....
200214E	12310	Feed Bar Hinge Screw .....
201525E	12310	“ “ “ “ Nut .....
204188	12310	“ “ Spring .....
204189	12306	“ “ “ Hook .....
207605	12004	“ Dog .....
200106E	12311	“ “ Screw (2) .....
203233	12305	“ Driving Cam with 200382C and 200437C .....
204192	12304	Feed Driving Cam Fork Lever with 204195 and 204293 .....
204193	12041	Feed Driving Cam Fork Lever Con- nection with 200668C and 201525E
204194	12306	Feed Driving Cam Fork Lever Con- nection Clamp with 200031F ....
200031F	12311	Feed Driving Cam Fork Lever Con- nection Clamp Pinch Screw ....
200668C	12310	Feed Driving Cam Fork Lever Con- nection Clamp Screw Stud .....
201525E	12310	Feed Driving Cam Fork Lever Con- nection Clamp Screw Stud Nut..
200002E	12310	Feed Driving Cam Fork Lever Con- nection Hinge Screw .....
201522E	12310	Feed Driving Cam Fork Lever Con- nection Hinge Screw Nut .....



## Parts for Machine No. 21w118

67

No.	Plate	Name
200362c	12311	Hook Counter Shaft Driving Gear Set Screw .....
203246	12305	Hook Counter Shaft Gear, 22 teeth, with two 200383c .....
200383c	12311	Hook Counter Shaft Gear Set Screw
202299	—	" " " Oil Packing (wick) .....
200840E	12223	Hook Counter Shaft Oil Packing (wick) Stop Screw .....
213624	12298	Hook Driving Shaft .....
203248	12304	" " " Bearing with 202299 .....
202299	—	Hook Driving Shaft Bearing Oil Packing (wick) .....
202126	12308	Hook Driving Shaft Bearing Position Pin .....
200516E	12311	Hook Driving Shaft Bearing Screw
203249	12305	" " " Bushing (eccentric) .....
202299	—	Hook Driving Shaft Bushing Oil Packing (wick) .....
200362c	12311	Hook Driving Shaft Bushing Set Screw .....
213141	13049	Hook Driving Shaft Collar with two 200393c .....
200393c	12308	Hook Driving Shaft Collar Set Screw .....
203513	11004	Hook Gib .....
201253E	12312	" " Screw .....
203504	12394	" Saddle with 200056E .....
200006E	12307	" " Screw (2) .....
202622	12306	" " " Washer (2) .....
213036	11004	" Washer with 203476 and two 204243 .....
203515	—	Hook Saddle complete, Nos. 200555n, 203478, 203499, 203504, 203506, 203514, 213036 and 213810
208490	11000	Knee Lifter Connection Lever .....
227312	—	" " " " 208490 with 227303, 227308 and two 200262H .....
200262H	12306	Knee Lifter Connection Lever Hinge Screw .....
227308	11000	Knee Lifter Connection Lever Lifting Rod with 202302 .....
202302	12306	Knee Lifter Connection Lever Lifting Rod Cotter Pin .....
227303	11000	Knee Lifter Lifting Lever .....
200262H	12306	" " " " Hinge Screw .....

66

## Parts for Machine No. 21w118

No.	Plate	Name
204208	12307	Feed Regulating Handle Adjustable Stop .....
200098E	11143	Feed Regulating Handle Adjustable Stop Screw .....
204925	12306	Feed Regulating Handle Adjustable Stop Screw Washer .....
204209	12307	Feed Regulating Handle Position Pin .....
204210	12306	Feed Regulating Handle Shaft .....
204211	12306	" " " " Crank with 200098E .....
204212	12307	Feed Regulating Handle Shaft Crank Link .....
200271E	12311	Feed Regulating Handle Shaft Crank Link Hinge Screw (lower)
200291E	12307	Feed Regulating Handle Shaft Crank Link Hinge Screw (upper)
200098E	12307	Feed Regulating Handle Shaft Crank Set Screw .....
204213	12307	Feed Regulating Handle Shaft Sleeve (split) .....
200362c	12311	Feed Regulating Handle Shaft Sleeve Set Screw .....
202622	12306	Feed Regulating Handle Shaft Sleeve Washer .....
202036	12310	Feed Regulating Handle Stop Pin
204214	—	Feed Regulating Handle complete, Nos. 200291E, 204207, 204211 and 204212 .....
*203511	—	Hook (sewing) .....
203512	11004	" 203511 with 203513 and two 201253E .....
203514	—	Hook and Bobbin Case complete, Nos. 203500 and 203512 .....
213810	12393	Hook Bevel Gear Socket, 24 teeth
200555H	12312	" " " " Screw .....
203242	12305	" " Pinion, 24 teeth, with two 200383c .....
200383c	12311	Hook Bevel Pinion Set Screw .....
203243	12041	" Counter Shaft .....
203244	12308	" " " Collar with two 200393c .....
200393c	12308	Hook Counter Shaft Collar Set Screw .....
203245	—	Hook Counter Shaft Driving Gear, 44 teeth, with 200362c and 200439c
213154	12305	Hook Counter Shaft Driving Gear 203245 with 200045E and 203235
200439c	12311	Hook Counter Shaft Driving Gear Position Screw .....

## Parts for Machine No. 21w118

69

No.	Plate	Name
203268	12304	Take-up Cam 212920 with 200383c, 200658c and 201519E .....
203172	12367	Take-up Cam Friction Washer .....
200430c	12311	" " Position Screw .....
200383c	12311	" " " " Check Screw .....
200335c	12311	Take-up Cam Set Screw .....
204262	11004	" Lever .....
206556	---	" " 204262 with 204263 ..
204263	12310	" " Bearing with 204264 ..
204264	12306	" " " Position Pin ...
200042F	12311	" " " Screw .....
201816	12307	" " Roller .....
204266	---	Take-up Lever complete, Nos. 200042F, 201816 and 206556 .....
202402	12309	Tension Disc .....
202090	12309	" " Position Pin .....
204267	12310	" Release Lever .....
200688c	13049	" " " Position Screw
200309E	12309	" " " Screw .....
202075	12309	" " Plunger .....
208489	11004	" " Slide .....
206608	11004	" " " Spring .....
202407	12309	" Spring .....
200632B	12309	" Stud .....
200397H	12309	" " Set Screw .....
201572B	12309	" Thumb Nut .....
204271	12309	" Washer .....
204272	12309	Tension complete, Nos. 200632B, 201572B, 202075, 202407, 204271 and two 202402 .....
204273	12308	Thread Controller Adjusting Collar with 200684H (for Presser Bar)..
200684H	12308	Thread Controller Adjusting Collar Screw .....
204274	12309	Thread Controller Plate .....
200577H	12311	" " " Screw .....
202098	12309	" " Roller .....
204275	12309	" " " Guard .....
202084	12309	" " " Washer .....
200300c	12309	" " " Screw .....
204276	12309	" " Spring .....
204333	12309	" " " Guard .....
200581H	12309	" " " Screw .....
204277	12309	" " " Stop .....
204278	12309	" " " Driving Gear .....
200319c	12309	Thread Controller Spring Stop Driving Gear Hinge Screw .....

68

## Parts for Machine No. 21w118

No.	Plate	Name
208613	---	Needle Bar (hollow) .....
204247	12304	" " 208613 with 200125F, 200175D and 204250 .....
204248	12307	Needle Bar Connecting Link .....
200658c	12307	" " " " Hinge Screw Stud .....
201519E	12307	Needle Bar Connecting Link Hinge Screw Stud Nut .....
204249	12308	Needle Bar Connecting Stud with 200072c and 202277 .....
202277	---	Needle Bar Connection Stud Oil Oil Packing (wick) .....
200072c	12308	Needle Bar Connecting Stud Pinch Screw .....
204326	---	Needle Bar Packing Cord (2) ....
200504E	12316	" " Screw Bushing (lower)
200503B	12310	" " " " (upper)
204250	12308	" " Thread Guide .....
200175D	12308	" " " " Screw ..
200125F	12308	" Set Screw .....
204251	12304	Presser Bar (hollow) with 200074F
204252	12308	" " Lifter .....
200550c	12311	" " " Hinge Screw ...
204253	12308	" " Lifting Bracket with 200086c .....
200086c	12308	Presser Bar Lifting Bracket Pinch Screw .....
204254	12307	Presser Bar Lifting Bracket Posi- tion Guide .....
200362c	12311	Presser Bar Lifting Bracket Posi- tion Guide Set Screw .....
204327	12306	Presser Bar Packing Washer (felt)
200504E	12310	" " Screw Bushing (lower)
204258	13049	" " Spring .....
200491B	12305	" " Thumb Screw (pres- sure regulating) .....
202090	12309	Presser Foot Hinge Pin .....
203011	---	" " Plate .....
202924	---	" " Shank .....
229867	10927	Presser Foot (hinged) complete, Nos. 202090, 202924 and 203011..
200074F	12308	Presser Foot Screw .....
202068	12153	Spool Holder Base .....
200575H	12311	" " " Screw .....
204296	12153	" " Wire .....
200079H	12311	" " " Hinge Screw ...
204297	12153	Spool Holder complete, Nos. 200079H, 202068 and 204296 .....
212920	---	Take-up Cam with 200335c and 200430c .....

## LIST OF PARTS COMPLETE

FOR

## MACHINE No. 21w122

For Flossing or Fanning Corsets, Suspenders,  
Draperies, Infants' Clothing, etc., also  
for Basting Lace on Corsets

No.	Plate	Name
*213022	—	Arm with 200383c, 200439c, 204705 and 204736 .....
204163	12305	Arm Cap .....
200278H	12311	" " Screw .....
202248	12307	" " Washer .....
204235	13049	" Position (2) .....
200963E	12311	" Screw (3) .....
202005	12308	" Washer (3) .....
213405	11993	" Shaft .....
204736	11136	" Bushing (back) .....
200383c	12311	" " " " Set Screw
204705	12304	" " " (front) .....
200439c	12311	" " " " Position Screw .....
204440	12041	Arm Shaft Connection with four 200054E (2) .....
200054E	12307	Arm Shaft Connection Screw .....
202299	—	" " Oil Packing (wick) .....
207833	11000	Balance Wheel (belt groove 2 7/8 diam.) .....
200776D	11143	Balance Wheel Adjusting Screw ..
207834	—	Balance Wheel complete, Nos. 204741, 207833, 223002, 235328, 235396, three each 200233c, 204744 and four 200567H .....
*213623	—	Bed with 202062, 203248, 203249, two each 200362c, 200516E, 200840E and 202299 .....
202258	12153	Bed Hinge Connection (2) .....
200570E	12311	" " " Screw (4) .....
203329	12041	" Slide (back) .....
203207	12041	" " (front) .....
203470	12393	Bobbin .....
*203498	—	" Case .....
203648	12393	" " Latch .....
*202056	—	" " " Pin .....

No.	Plate	Name
200135E	12309	Thread Controller Spring Stop Screw .....
201279	12309	Thread Controller Spring Stud with 204925 .....
200355H	12319	Thread Controller Spring Stud Set Screw .....
204925	12306	Thread Controller Spring Stud Washer .....
205987	12309	Thread Controller complete, Nos. 200300c, 200581H, 202084, 202098, 204274, 204275 and 204333 .....
201280	12309	Thread Controller and Spring com- plete, Nos. 204276 and 205987 .....
202413	12310	Thread Guide .....
201281	12309	" Retainer Guide Wire .....
202091	12309	" " Sleeve .....
202092	12309	" " Spring .....
204058	12309	" " Stud .....
200368H	12309	" " Set Screw .....
204059	12309	Thread Retainer complete, Nos. 202091, 202092 and 204058 .....
211214	12019	Throat Plate, 40 needle hole, for needle sizes 20 and 22 .....
202062	12308	Throat Plate Position Pin .....
200577H	12311	" " Screw (2) .....

No.	Plate	Name
200393c	12311	Hook Counter Shaft Gear Set Screw .....
202299	---	Hook Counter Shaft Oil Packing (wick) .....
200840E	12223	Hook Counter Shaft Oil Packing (wick) Stop Screw .....
213624	12298	Hook Driving Shaft .....
203248	12304	" " " Bearing with 202299 .....
202299	---	Hook Driving Shaft Bearing Oil Packing (wick) .....
202126	12308	Hook Driving Shaft Bearing Position Pin .....
200516E	12311	Hook Driving Shaft Bearing Screw .....
203249	12305	" " " Bushing (eccentric) .....
202299	---	Hook Driving Shaft Bushing Oil Packing (wick) .....
200362c	12311	Hook Driving Shaft Bushing Set Screw .....
213141	13049	Hook Driving Shaft Collar with two 200393c .....
200393c	12308	Hook Driving Shaft Collar Set Screw .....
203513	11004	Hook Gib .....
201253F	12312	" " Screw .....
203504	12394	" Saddle with 200056E .....
200006E	12307	" " Screw (2) .....
202622	12306	" " " Washer (2) .....
213036	11004	" Washer with 203476 and two 204243 .....
203515	---	Hook Saddle complete, Nos. 200555u, 203478, 203499, 203504, 203506, 203514, 213036 and 213810 .....
235328	11000	Machine Driving Friction (leather) .....
204741	10496	" " " Clamp .....
204742	11143	" " " " Operating Washer .....
204743	10496	Machine Driving Friction Clamp Operating Washer Incline Lever .....
200233c	11143	Machine Driving Friction Clamp Screw .....
204744	11143	Machine Driving Friction Clamp Spring .....
235396	11000	Machine Driving Friction Position Plate .....
200567u	11116	Machine Driving Friction Position Plate Screw .....
204745	10496	Machine Incline Lever with 201230E and 201537E .....

No.	Plate	Name
203473	12393	Bobbin Case Latch Plunger .....
203474	12393	" " " Spring .....
203499	12039	" " Lever .....
*203476	---	" " " Eccentric .....
204243	11004	" " " " Position Pin .....
203506	12039	Bobbin Case Lever Fulcrum .....
200056E	12319	" " " " Screw .....
203478	11004	" " " Slide Stud .....
203214	12312	" " Tension Spring .....
200984c	12312	" " " " Regulating Screw .....
200594c	12312	Bobbin Case Tension Spring Screw .....
203216	12312	" " Washer (cloth) .....
203500	12039	Bobbin Case complete Nos. 200594c, 200984c, 202056, 203214, 203216, 203473, 203474, 203498 and 203648 .....
204660	11993	Face Plate with 200366u, 200368u, 200688c, 202087, 202090, 204185, 204281 and two 200397u .....
200053c	12311	Face Plate Screw .....
204185	12310	" " Thread Guide .....
200397u	12309	" " " " Set Screw .....
204662	11993	Face Plate complete, Nos. 200309E, 200577u, 202088, 204059, 204267, 204280, 204660 and 213872 .....
*203511	---	Hook (sewing) .....
203512	11004	" 203511 with 203513 and two 201253F .....
203514	---	Hook and Bobbin Case complete, Nos. 203500 and 203512 .....
213810	12393	Hook Bevel Gear Socket, 24 teeth .....
200555u	12312	" " " " Screw .....
203242	12305	" " Pinion, 24 teeth, with two 200383c .....
200383c	12311	Hook Bevel Pinion Set Screw .....
203243	12041	" Counter Shaft .....
203244	12308	" " " Collar with two 200393c .....
200393c	12308	Hook Counter Shaft Collar Set Screw .....
203245	---	Hook Counter Shaft Driving Gear, 44 teeth, with 200362c and 200439c .....
200439c	12311	Hook Counter Shaft Driving Gear Position Screw .....
200362c	12311	Hook Counter Shaft Driving Gear Set Screw .....
203246	12305	Hook Counter Shaft Gear, 22 teeth, with two 200393c .....

No.	Plate	Name
204483	12031	Needle Bar (hollow) with 200125F, 200587D and 204487 .....
204248	12307	Needle Bar Connecting Link .....
200658C	12307	" " " " Hinge Screw Stud .....
201519E	12307	Needle Bar Connecting Link Hinge Screw Stud Nut .....
204249	12308	Needle Bar Connecting Stud with 200072C and 202277 .....
202277	-----	Needle Bar Connecting Stud Oil Packing (wick) .....
200072C	12308	Needle Bar Connecting Stud Pinch Screw .....
204326	-----	Needle Bar Packing Cord (2) ....
200504E	12310	" " Screw Bushing (lower)
200503E	12310	" " " " (upper)
204487	11004	" " Thread Guide .....
200587D	12039	" " " " Screw ..
200125F	12308	" Set Screw .....
215898	12031	Presser Bar with 200074E .....
204252	12308	" " Lifter .....
200550C	12311	" " " Hinge Screw ...
204253	12308	" " Lifting Bracket with 200086C .....
200086C	12308	Presser Bar Lifting Bracket Pinch Screw .....
213024	11136	Presser Bar Lifting Bracket Position Guide .....
200362C	12311	Presser Bar Lifting Bracket Position Guide Set Screw .....
213026	11143	Presser Bar Lifting Cam .....
203370	11116	" " " " Position Pin .....
200098E	11143	Presser Bar Lifting Cam Screw ...
215896	11116	" " " Plunger with 213028 and 213662 .....
213030	11136	Presser Bar Lifting Plunger Connection with two 200070C .....
200070C	11116	Presser Bar Lifting Plunger Connection Pinch Screw .....
213028	11116	Presser Bar Lifting Plunger Roller
213662	11116	" " " " " Pin .....
204327	12306	Presser Bar Packing Washer (felt)
200504E	12310	" " Screw Bushing (lower)
200070C	11116	" " Set Screw .....
215897	11116	" " Spring .....
200491B	12305	" " Thumb Screw (pressure regulating) .....

No.	Plate	Name
201230E	11116	Machine Incline Lever Position Screw .....
201537E	12319	Machine Incline Lever Position Screw Check Nut .....
201072D	11116	Machine Incline Lever Screw .....
202622	12306	" " " " Washer
223001	10999	" Starting Lever .....
200219D	11143	" " " Hinge Screw
200335C	12311	" " " " " Set Screw .....
223002	11993	Machine Stop Cam with 200328C, 200335C, 200370C, 204747 and 206427 .....
204747	10496	Machine Stop Cam Friction Ring (leather) .....
206427	11143	Machine Stop Cam Friction Ring Position Pin .....
200328C	12311	Machine Stop Cam Position Screw
200370C	11143	" " " " " Check Screw .....
200335C	12223	Machine Stop Cam Set Screw ....
223013	11116	" " " Slide .....
200249E	11143	" " " " Hinge Screw .....
201525E	12310	Machine Stop Cam Slide Hinge Screw Nut .....
223015	10999	Machine Stop Cam Slide Lever ....
223016	12031	" " " " " 223015 with 200122H, 200249E, 200991E, 201822, 223013, 223014 and two 201525E .....
200258D	11143	Machine Stop Cam Slide Lever Hinge Screw .....
201523E	11116	Machine Stop Cam Slide Lever Hinge Screw Nut .....
201822	11143	Machine Stop Cam Slide Lever Roller .....
200991E	11136	Machine Stop Cam Slide Lever Roller Screw Stud .....
201525E	11143	Machine Stop Cam Slide Lever Roller Screw Stud Nut .....
223014	11116	Machine Stop Cam Slide Spring
200122H	12039	" " " " " Screw .....
223017	-----	Machine Stop Motion complete, Nos. 200219D, 200258D, 200776D, 201072D, 201523E, 202622, 204742, 204743, 204745, 207834, 223001 and 223016 .....

No.	Plate	Name
204274	12309	Thread Controller Plate .....
200577H	12311	" " " Screw ....
202098	12309	" " Roller .....
204275	12309	" " " Guard .....
202084	12309	" " " Washer .....
200300C	12309	" " " Screw .....
204276	12309	" " Spring .....
204333	12309	" " " Guard .....
200581H	12309	" " " " Screw .....
202087	11116	" " " Stud .....
202088	11116	" " " Stud with 204925 .....
200366H	12039	Thread Controller Spring Stud Set Screw .....
204925	12306	Thread Controller Spring Stud Washer .....
205987	12309	Thread Controller complete, Nos. 200300C, 200581H, 202084, 202098, 204274, 204275 and 204333 .....
204280	12309	Thread Controller and Spring com- plete, Nos. 204276 and 205987 ...
204281	12309	Thread Retainer Guide Wire .....
202091	12309	" " Sleeve .....
202092	12309	" " Spring .....
204058	12309	" " Stud .....
200368H	12309	" " " Set Screw ...
204059	12309	Thread Retainer complete, Nos. 202091, 202092 and 204058 .....
211923	12036	Throat Plate, 46 needle hole, for needle sizes 16 and 18 .....
202062	12308	Throat Plate Position Pin .....
200577H	12311	" " Screw (2) .....

No.	Plate	Name
201506B	12376	Presser Bar Thumb Screw Check Nut .....
213406	11116	Presser Bar Washer (fibre) .....
229079	13014	" Foot .....
200074F	12308	" " Screw .....
202068	12153	Spool Holder Base .....
200575H	12311	" " " Screw .....
204296	12153	" " Wire .....
200079H	12311	" " " Hinge Screw ...
204297	12153	Spool Holder complete, Nos. 200079H, 202068 and 204296 .....
213025	11134	Take-up Cam with 200335C, 200383C, 200430C, 200658C, 201519E, 203370, 213026 and two 200098F .....
203172	12307	Take-up Cam Friction Washer ...
200430C	12311	" " Position Screw ....
200383C	12311	" " " " Check Screw .....
200335C	12311	Take-up Cam Set Screw .....
213023	11134	" Lever with 202199 .....
215901	-----	" " 213023 with 204263 ...
204263	12310	" " Bearing with 204264 ...
204264	12306	" " " Position Pin ..
200042F	12311	" " " Screw .....
201816	12307	" " Roller .....
202199	11116	" " " Stud .....
213659	11134	Take-up Lever complete, Nos. 200042F, 201816 and 215901 .....
202402	12309	Tension Disc .....
202090	12309	" " Position Pin .....
204267	12310	" Release Lever .....
200688C	13049	" " " Position Screw
200309E	12309	" " " Screw .....
202075	12309	" " Plunger .....
208489	11004	" " Slide .....
213639	11116	" " " Position Collar with 200380C .....
200380C	11143	Tension Release Slide Position Col- lar Screw .....
204270	11116	Tension Spring .....
200632B	12309	" Stud .....
200397H	12309	" " Set Screw .....
201572B	12309	" Thumb Nut .....
204271	12309	" Washer .....
213872	11136	Tension complete, Nos. 200632B, 201572B, 202075, 204270, 204271 and two 202402 .....

## ACCESSORIES

FOR MACHINE No. 21w4

No.	Plate	Name
200157B	13008	Attachment Screw .....
203208	12312	Bobbin (5) .....
*225482	----	" Case Screw Driver Blade ...
*225483	----	" " " " Handle ..
225497	12153	Bobbin Case Screw Driver complete, Nos. 225482 and 225483 ...
231337	11124	Cloth Guide .....
200798E	12306	" " Screw Stud .....
201556D	11124	" " " " Thumb Nut
226998	10999	Bed Slide (back) with 200798E ...
227000	----	Bed Slide (back) complete, Nos. 201556D, 226998 and 231337 ...
128 x 3	----	Needles, three each, sizes 12 and 14
228213	----	Drip Pan with four wood screws $\frac{1}{2}$ in., No. 5 .....
41400	12153	Machine Rest Pin (wood) .....
120342	12153	Oiler (copper plated) with 120343 ..
120343	12153	" Spout, 3 $\frac{1}{2}$ in. long .....
*225484	----	Screw Driver Blade .....
*225485	----	" " Handle .....
225498	12153	Screw Driver complete (7 $\frac{1}{2}$ in. long), Nos. 225484 and 225485 ..
225554	12153	Wrench .....

### BOBBIN WINDER

Swing Automatic, Right Hand

202470	12320	Bobbin Winder Base .....
202471	12320	" " Frame .....
200221D	12319	" " " Hinge Screw ..
202472	12319	" " " Spring .....
200161D	12319	" " " " Screw ..
202473	12320	" " Pulley with 200380C
200380C	11143	" " " Set Screw ...
202474	12320	" " Spindle .....
227522	12309	" " Stop Latch .....
200056E	12319	" " " " Screw ..
202477	12319	" " " " Thumb Lever .....
200299H	12319	Bobbin Winder Stop Latch Thumb Lever Hinge Screw .....

## MACHINE No. 21w160

DROP FEED. ROLLER PRESSER

For Shoes and Gloves

The same as Machine No. 21w50 with the following exceptions:

No.	Plate	Name
*204290	----	Arm with 200439C, 202036 and 204705, in place of 204161 .....
213622	12298	Arm Shaft, in place of 202302 ...
*213623	----	Bed with 202062, 203248, 203249, two each 200362C, 200516E, 200840E and 202299, in place of 203205 ..
204294	12298	Feed Driving Rock Shaft, in place of 204199 .....
206555	----	Feed Driving Rock Shaft 204294 with 200002E, 201522E and 204193, in place of 206554 .....
213624	12298	Hook Driving Shaft, in place of 203247 .....
227312	----	Knee Lifter Connection Lever 208490 with 227303, 227308 and two 200262H, in place of 227311 ..
227303	11000	Knee Lifter Lifting Lever, in place of 227302 .....

## Accessories

81

No.	Plate	Name
202455	11000	Knee Lifter Rock Lever Knee Plate Arm (short) .....
200522c	12319	Knee Lifter Rock Lever Knee Plate Arm Set Screw .....
200526c	12319	Knee Lifter Rock Lever Knee Plate Set Screw .....
202451	14384	Knee Lifter Rock Lever Lug with two wood screws $\frac{7}{8}$ in., No. 12u
202452	12319	Knee Lifter Rock Lever Lug Hinge Pin .....
227728	14384	Knee Lifter Rock Lever Rod, 3 in. long, with 227729 .....
227729	---	Knee Lifter Rock Lever Rod Cap or Oil Guard .....
200529c	12319	Knee Lifter Rock Lever Rod Set Screw .....

(Other Knee Lifter parts are listed with parts of machine head.)

**FOR MACHINE No. 21w15**

Same as for No. 21w4 with the following exception:

203470	12393	Bobbin (5), in place of 203208 ....
--------	-------	-------------------------------------

**FOR MACHINE No. 21w25**

Same as for No. 21w4 with the following exception:

126 x3	---	Needles, two each, sizes 16, 18 and 20, in place of 128 x3 .....
--------	-----	--

**FOR MACHINE No. 21w30**

Same as for No. 21w4 with the following exceptions:

225487	13049	Roller Presser Hinge Screw Nut Wrench .....
128 x4	---	Needles, two each, sizes 11, 12 and 13, in place of 128 x3 .....
(227000 Bed Slide complete, not used)		

**FOR MACHINE No. 21w50**

Same as for No. 21w4 with the following exceptions:

203470	12393	Bobbin (5), in place of 203208 ....
225487	13049	Roller Presser Hinge Screw Nut Wrench .....
128 x4	---	Needles, two each, sizes 11, 12 and 13, in place of 128 x3 .....
(227000 Bed Slide complete, not used)		

80

## Accessories

No.	Plate	Name
200299u	12319	Bobbin Winder Stop Latch Thumb Lever Joint Screw .....
201537u	12319	Bobbin Winder Stop Latch Thumb Lever Joint Screw Nut .....
202478	12319	Bobbin Winder Stop Latch Trip Lever .....
200299u	12319	Bobbin Winder Stop Latch Trip Lever Hinge Screw .....
227523	12320	Bobbin Winder complete, Nos. 200056E, 200161D, 200221D, 201537u, 202470 to 202474, 202477, 202478, 227522, three 200299u and two round head wood screws $\frac{3}{4}$ in., No. 12 .....
202480	12320	Bobbin Winder Spool Holder Base with 200355u and 202484 .....
202481	12320	Bobbin Winder Spool Holder Base Spool Pin .....
202482	12319	Bobbin Winder Spool Holder Tension Disc (lower or upper) ....
200011E	12319	Bobbin Winder Spool Holder Tension Disc Screw .....
200355u	12319	Bobbin Winder Spool Holder Tension Disc Screw Set Screw ....
202483	12319	Bobbin Winder Spool Holder Tension Disc Spring (brass) .....
202484	12319	Bobbin Winder Spool Holder Tension Disc Thread Guide .....
202485	12320	Bobbin Winder Spool Holder complete, Nos. 200011E, 202480, 202481, 202483, two 202482 and one wood screw 1 in., No. 13 ...
227524	---	Bobbin Winder and Spool Holder complete, Nos. 202485 and 227523

**KNEE LIFTER**

227781	14384	Knee Lifter Rock Lever with 200522c and 200529c .....
227782	---	Knee Lifter Rock Lever 227781 with two each 202451 and 202452 ....
227783	---	Knee Lifter Rock Lever 227782 with 202985 and 227728 .....
202453	14384	Knee Lifter Rock Lever Knee Plate with 200526c .....
202985	---	Knee Lifter Rock Lever Knee Plate 202453 with 202455 .....



## FOR MACHINE No. 21w118

Same as for No. 21w4 with the following exceptions:

No.	Plate	Name
203470	12393	Bobbin (5), in place of 203208 ....
227787	14384	Knee Lifter Rock Lever (see page 82), in place of 227783 .....
126 x3	---	Needles, three each, sizes 20 and 22, in place of 128 x 3 .....

## FOR MACHINE No. 21w122

Same as for No. 21w4 with the following exceptions:

203470	12393	Bobbin (5), in place of 203208 ....
126 x3	---	Needles, six, size 16, in place of 128 x 3 .....
		(200157 Attachment Screw, 237000 Bed Slide complete and 227783 Knee Lifter Rock Lever, not used)

## STARTING TREADLE

126036	12017	Treadle .....
126037	---	" 126036 with 2718R, 50581R and 126038 .....
126038	12017	Treadle Extension .....
50581R	11124	" " Screw .....
2718R	11124	" " Washer .....
204696	12223	" Lifting Spring .....
204697	12223	" " Hook (bench) ..
227956	12017	" Pitman Rod (lower) .....
204698	11993	" " (upper) with 202302 .....
204126	12223	Treadle Pitman Rod Clamp with two 200530c .....
200530c	12223	Treadle Pitman Rod Clamp Set Screw .....
202302	12306	Treadle Pitman Rod Cotter Pin ..
206386	11993	" Stand (left or right) with two wood screws 1 in., No. 13 ..
228189	---	Treadle complete, Nos. 126037 and two 206386 .....
227957	---	Treadle Pitman complete, Nos. 204696 to 204698, 227956 and two 204126 .....
228190	---	Treadle and Pitman complete, Nos. 227957 and 228189 .....

## FOR MACHINE No. 21w54

Same as for No. 21w4 with the following exceptions:

No.	Plate	Name
203470	12393	Bobbin (5), in place of 203208 ....
128 x4	---	Needles, two each, sizes 11, 12 and 13, in place of 128 x 3 .....
		(227000 Bed Slide complete, not used)

## FOR MACHINE No. 21w115

Same as for No. 21w4 with the following exceptions:

203470	12393	Bobbin (5), in place of 203208 ....
--------	-------	-------------------------------------

## KNEE LIFTER

227781	14384	Knee Lifter Rock Lever with 200522c and 200529c .....
227782	---	Knee Lifter Rock Lever 227781 with two each 202451 and 202452 .....
227787	14384	Knee Lifter Rock Lever 227782 with 202203 and 227728, in place of 227783 .....
202453	14384	Knee Lifter Rock Lever Knee Plate with 200526c .....
202203	---	Knee Lifter Rock Lever Knee Plate 202453 with 202454 .....
202454	14384	Knee Lifter Rock Lever Knee Plate Arm (long) .....
200522c	12319	Knee Lifter Rock Lever Knee Plate Arm Set Screw .....
200526c	12319	Knee Lifter Rock Lever Knee Plate Set Screw .....
202451	14384	Knee Lifter Rock Lever Lug with two wood screws 3/4 in., No. 12u ..
202452	12319	Knee Lifter Rock Lever Lug Hinge Pin .....
227728	14384	Knee Lifter Rock Lever Rod, 3 in. long, with 227729 .....
227729	---	Knee Lifter Rock Lever Rod Cap or Oil Guard .....
200529c	12319	Knee Lifter Rock Lever Rod Set Screw .....

(Other Knee Lifter parts are listed with parts of machine head.)

Feed Dogs

No.	Plate	Name
211108	12005	Feed Dog, for 211105, 211106, 211112, 211113, 211183, 211189, 211198, 211215 and 211216 .....
211109	12005	Feed Dog, for 211105, 211106, 211112, 211113, 211215 and 211216 .....
211110	12005	Feed Dog, for 211105, 211106, 211112, 211113, 211215 and 211216 .....
211111	12005	Feed Dog, for 211112 and 211113 ..
211116	12005	" " " 211114, 211115, 211219 and 211220 .....
211118	12006	Feed Dog, for 211075, 211117, 211221 and 212269 .....
211120	12006	Feed Dog, for 211119 .....
211124	12007	" " " 211123 .....
211126	12007	" " " 211127 .....
211128	12007	" " " 211127, 211222, 212268 and 212270 .....
211131	12007	Feed Dog, for 211129, 211223 and 211224 .....
211135	12016	Feed Dog, for 211134 .....
211138	12009	" " " 211136, 211137, 211142 to 211147 and 211225 to 211228 ..
211139	12009	Feed Dog, for 211136, 211137, 211142 to 211147 and 211225 to 211228 ..
211140	12009	Feed Dog, for 211136, 211137, 211142 to 211147 and 211225 to 211228 ..
211141	12009	Feed Dog, for 211136, 211137, 211142 to 211147 and 211225 to 211228 ..
211150	12010	Feed Dog, for 203801, 211148, 211149, 211151 and 211152 .....
211154	12010	Feed Dog, for 211153 .....
211156	12010	" " " 211155 .....
211158	12011	" " " 211157 .....
211161	12011	" " " 211160 .....
211168	12012	" " " 211167 .....
211255	12026	" " " 211248, 211251 to 211254, 211257 to 211259, 211324, 211326, 211327, 211339 and 215900 ..
211256	12026	Feed Dog, for 211248, 211251 to 211254, 211257 to 211259, 211324, 211326, 211327, 211339 and 215900 ..
211263	12026	Feed Dog, for 211244, 211260 to 211262, 211283, 211325 and 211328 to 211331 .....
211264	12026	Feed Dog, for 211244, 211260 to 211262, 211283, 211325 and 211328 to 211331 .....
211268	12016	Feed Dog, for 211265 to 211267, 211332 and 211333 .....

Accessories

FOR MACHINE No. 21w160

Same as for No. 21w4 with the following exceptions:

No.	Plate	Name
203470	12393	Bobbin (5), in place of 203208 ....
227787	---	Knee Lifter Rock Lever (see page 82), in place of 227783 .....
225487	13049	Roller Presser Hinge Screw Nut Wrench .....
128 x 4	---	Needles, two each, sizes 11, 12 and 13, in place of 128 x 3 .....
(227000)		Bed Slide complete, not used)

FEED DOGS

207665	12004	Feed Dog, for 211213 and 211214 ..
207606	12003	" " " 211097, 211098 and 211212 .....
207630	12036	Feed Dog, for 203372 .....
207635	12036	" " " 203361 .....
211079	12001	" " " 211076 to 211078, 211122, 211159 and 211201 to 211203 .....
211080	12001	Feed Dog, for 211076 to 211078 and 211201 to 211203 .....
211081	12001	Feed Dog, for 211076 to 211078 and 211201 to 211203 .....
211082	12001	Feed Dog, for 211076 to 211078 and 211201 to 211203 .....
211083	12001	Feed Dog, for 211076 to 211078 and 211201 to 211203 .....
211087	12002	Feed Dog, for 211084 to 211086 and 211204 to 211206 .....
211089	12002	Feed Dog, for 211088 and 211207 ..
211091	12002	" " " 211090 .....
211095	12003	" " " 211092 to 211094 and 211208 to 211210 .....
211096	12003	Feed Dog, for 211092 to 211094 and 211208 to 211210 .....
211099	12003	Feed Dog, for 211097 and 211098 ..
211104	12004	" " " 210994, 211102, 211103 and 211218 .....
211107	12005	Feed Dog, for 211105, 211106, 211112, 211113, 211183, 211189, 211198, 211215 and 211216 .....

No.	Plate	Name
225621	12035	Presser Foot, for Machine No. 21w4 only .....
229594	13029	Presser Foot, for handkerchief hemming .....
207171	13021	Presser Foot, for hosiery, has long heel to prevent puckering .....
229077	13007	Presser Foot, for knit goods .....
206832	10925	" " " " " .....
207188	11122	" " " long stitch .....
229078	13007	" " " " " .....
202376	10926	" " " mattress binding .....
229878	13029	" " " " " .....
202375	10926	" " " " " .....
229073	13007	" " " seaming umbrellas .....
207180	11123	" " " sleeve facing .....
229877	13029	" " " stitching ladies' belts .....
206785	10926	Presser Foot .....
225723	10926	" " .....
206791	10925	" " .....
203180	10926	" " for $\frac{1}{4}$ in. stitching margin .....
206528	10925	Presser Foot, for stitching margins $\frac{1}{8}$ , $\frac{1}{4}$ and $\frac{3}{8}$ inch .....
229597	10925	Presser Foot, for stitching margins from $\frac{1}{8}$ to $\frac{3}{8}$ in., in steps of $\frac{1}{16}$ in., for open bosom shirts .....
202354	10926	Presser Foot, for $\frac{1}{16}$ , $\frac{1}{8}$ and $\frac{3}{8}$ in. stitching margins, for collar and cuff work .....
206792	10925	Presser Foot, for stitching margins from $\frac{1}{16}$ to $\frac{1}{4}$ in., in steps of $\frac{1}{32}$ in., for collar and cuff work .....
225862	13031	Presser Foot, for stitching margins from $\frac{1}{16}$ to $\frac{1}{4}$ in., in steps of $\frac{1}{32}$ in., for collar and cuff work .....
203179	10926	Presser Foot, for $\frac{1}{16}$ in. stitching margin, for collar and cuff work .....
225859	---	Presser Foot, has rigid guide, for stitching margins from $\frac{1}{16}$ to $\frac{1}{4}$ in., in steps of $\frac{1}{32}$ in., for collar and cuff work. Order gauge required .....
225690	12035	Presser Foot, from 4 to 16 cords to the inch, as ordered, for top and bottom cording .....
202368	10259	Presser Foot (deep grooved) (grooved to left of needle hole), from 4 to 16 cords to the inch, as ordered, for top cording .....

## PRESSER FEET

FOR MACHINES NOS. 21w4, 21w15 AND 21w115

No.	Plate	Name
229852	11123	Presser Foot .....
229853	11123	" " .....
229854	11123	" " .....
202413	10929	" " .....
229075	13007	" " .....
229074	13007	" " .....
229076	13007	" " .....
206788	10929	" " .....
207023	13031	" " for close gauge work .....
229063	13021	" " .....
208422	13029	" " .....
206781	11123	" " .....
206786	10929	" " .....
206849	13029	" " .....
207182	11122	" " has short groove on bottom, back of needle hole, for long stitch .....
Nos. 203981 to 203985, for 202762		
203981	13014	Presser Foot (glass) .....
203982	13014	" " " for braiding ..
203983	13014	" " " " cording ...
203984	13014	" " " " edge stitching .....
203985	13014	Presser Foot (glass), for gathering .....
206842	12035	" " Cleft Holder, for interchangeable Pressers .....
206841	11123	Presser Foot, for binding .....
202356	13029	" " " " .....
206779	11123	" " " " .....
202361	10926	" " " " .....
229880	13029	" " " " suspenders .....
229571	13029	" " " " " .....
229595	12035	" " " counterpane hemming .....
229598	12035	Presser Foot, for felling .....
202373	13014	" " " gathering .....
202529	10926	" " (split), for gathering .....
206789	13029	" " for guiding and stitching shoe stays .....

No.	Plate	Name
202090	12309	Presser Foot Hinge Pin .....
202572	11124	" " " " .....
205979	11124	" " " " .....
203003	---	" " Plate, for 202966 ....
203009	---	" " " " 229864 ....
203015	---	" " " " 203039 ....
203022	---	" " " " 229054 ....
203024	---	" " " " 229865 ....
203033	---	" " " " 203153 ....
203034	---	" " " " 202372 ....
203035	---	" " " " 202371 ....
203322	---	" " " " 203323 ....
215903	---	" " " " 215904 ....
229051	---	" " " " 229052 ....
229055	---	" " " " 202351 ....
229058	---	" " " " 229942 ....
229599	---	" " " " 229944 ....
229601	---	" " " " 229943 ....
229622	---	" " " " 229603 ....
*231006	---	" " " and Folder, for 225961 .....
203038	---	Presser Foot Shank, for 203039 ...
202935	---	" " " " 203153 ...
202924	---	" " " " .....
202923	---	" " " for 229944 .....
215911	---	" " " " 229054 .....
202933	---	" " " " 229052 .....
229941	---	" " " " 229942 .....
202936	---	" " " " 202966 .....
202966	13030	Presser Foot (hinged) complete, Nos. 202572, 202936 and 203003, for shoe linings .....
229864	10927	Presser Foot (hinged) complete, Nos. 202090, 202924 and 203009 ...
203039	13030	Presser Foot (hinged) complete, Nos. 203015, 203038 and 205979 ...
229054	13030	Presser Foot (hinged) complete, Nos. 202090, 203022 and 215911. Hinge pin set back $\frac{1}{8}$ in. from regular to prevent puckering ...
229865	10927	Presser Foot (hinged) complete, Nos. 202090, 202924 and 203024...
203153	10927	Presser Foot (hinged) complete, Nos. 202090, 202935 and 203033...
202372	13030	Presser Foot (hinged) complete, Nos. 202090, 202921 and 203034, for handkerchief hemming .....
202371	13030	Presser Foot (hinged) complete, Nos. 202090, 202921 and 203035, for umbrella hemming .....

No.	Plate	Name
229564	13031	Presser Foot (deep grooved) (grooved to left of needle hole), for 8, 9, 10, 12 or 14 cords to the inch, as ordered, for skirt cording
229565	13031	Presser Foot (deep grooved) (grooved to right of needle hole), for 7, 8, 9, 10, 12 or 14 cords to the inch, as ordered, for skirt cording .....
229566	13031	Presser Foot (single grooved) (grooved to left of needle hole), for 6, 7, 8, 9 or 10 cords to the inch, as ordered .....
202369	10259	Presser Foot (deep grooved) (grooved to left of needle hole), from 4 to 16 cords to the inch, as ordered, for top cording ....
202370	10259	Presser Foot (deep grooved) (grooved to right of needle hole), from 4 to 16 cords to the inch, as ordered, for top cording ....
229087	13031	Presser Foot Needle Guide .....
202807	10925	" " Spring Guide .....
202810	10926	" " " " .....
229067	13039	" " " " .....
229069	13039	" " " " .....
200126b	11124	" " Needle Guide Screw...
200175b	12308	" " Spring Guide Screw...
229086	13031	" " with 200126b and 229087, for staying shoes .....
229871	10925	Presser Foot (right hand spring guide), stitching margins from $\frac{1}{8}$ to $\frac{1}{4}$ in., in steps of $\frac{1}{16}$ in., with 200175b and 202807. Order mar- gin required .....
202366	10926	Presser Foot (right hand spring guide), stitching margins from $\frac{1}{8}$ to $\frac{1}{4}$ in., in steps of $\frac{1}{16}$ in., with 200175b and 202810. Order mar- gin required .....
229872	13039	Presser Foot (right hand spring guide), stitching margins $\frac{1}{8}$ , $\frac{1}{4}$ , $\frac{3}{8}$ and $\frac{1}{2}$ in., with 200175b and 202810. Order margin required ...
229068	13039	Presser Foot (left hand spring guide), stitching margins $\frac{1}{8}$ , $\frac{1}{4}$ , $\frac{3}{8}$ , $\frac{1}{2}$ or $\frac{3}{4}$ in., with 200175b and 229069. Order margin required...

## FOR MACHINES NOS. 21w25 AND 21w54

No.	Plate	Name
204594	10505	Lifting Presser Foot, for 204620, 204634, 206698 and 229620 .....
204595	10505	Lifting Presser Foot, for 204620, 204634, 206698 and 229620 .....
204596	10505	Lifting Presser Foot, for 204620, 204634, 206698 and 229620 .....
204597	10505	Lifting Presser Foot, for 204622
204598	10505	" " " " 204621, 206692 and 206693 .....
204599	10505	Lifting Presser Foot, for 204620, 204634, 206698 and 229620 .....
204600	10505	Lifting Presser Foot, for 204620, 204634, 206698 and 229620 .....
204601	13034	Lifting Presser Foot, for 206707 and 206716 .....
204602	13034	Lifting Presser Foot, for 206672, 206673, 206707 and 206715 to 206717 .....
204603	13034	Lifting Presser Foot, for 206672, 206673, 206707 and 206715 to 206717 .....
204604	13034	Lifting Presser Foot, for 206668, 206675, 206678, 206714 and 206719
204605	13034	Lifting Presser Foot, for 206668, 206675, 206678, 206714 and 206719
204606	13034	Lifting Presser Foot, for 206676, 206699 and 206700 .....
204607	13034	Lifting Presser Foot, for 206707 and 206716 .....
204608	10505	Lifting Presser Foot, for 204620, 204634, 206698 and 229620 .....
204609	13034	Lifting Presser Foot, for 206672, 206673, 206681, 206707 and 206715 to 206717 .....
204610	13035	Lifting Presser Foot, for 206676, 206699 and 206700 .....
204611	13035	Lifting Presser Foot, for 204620, 204634, 206698, 206705, 206706 and 229620 .....
204612	13035	Lifting Presser Foot, for 204620, 204634, 206698, 206705, 206706 and 229620 .....
204640	13037	Lifting Presser Foot, for 204620, 204634, 206698 and 229620 .....
206662	13037	Lifting Presser Foot, for 206663 ..
206664	13037	" " " (grooved), for heavy cord covering, for 206665..

No.	Plate	Name
203323	13030	Presser Foot (hinged) complete, Nos. 202090, 202924 and 203322..
215904	13030	Presser Foot (hinged) complete, Nos. 202090, 202924 and 215903..
229052	13030	Presser Foot (hinged) complete, Nos. 202090, 202933 and 229051. Hinge pin set back $\frac{1}{4}$ in. from regular to prevent puckering ....
202351	10927	Presser Foot (hinged) complete, Nos. 202090, 202924 and 229055, for knit goods .....
229942	13030	Presser Foot (hinged) complete, Nos. 202090, 229058 and 229941 ..
229944	13030	Presser Foot (hinged) complete, Nos. 202090, 202923 and 229599, for felling .....
229943	13030	Presser Foot (hinged) complete, Nos. 202090, 202924 and 229601, for knit goods .....
229603	13039	Presser Foot (hinged) complete, Nos. 202090, 202924 and 229622, for closing heel seams on shoe linings .....
225961	13039	Presser Foot (hinged) complete, Nos. 202090, 202924 and 231006, for closing heel seams on shoe linings .....
231235	---	Presser Foot Strip Guide with 200488c .....
231236	---	Presser Foot Strip Guide Bar .....
231237	11122	" " " " " Plate
200175H	12308	" " " " " "
		Screw .....
200488c	11124	Presser Foot Strip Guide Thumb Screw .....
203037	---	Presser Foot Plate with 231235 to 231237 and six 200175H .....
231238	11122	Presser Foot (hinged) (adjustable) complete, for strips from $\frac{3}{8}$ to $1\frac{1}{4}$ in., Nos. 202572, 202924 and 203037, for stitching shoe facings

## FOR MACHINE No. 21w118

229856	10929	Presser Foot .....
229857	10929	" " .....
229858	10929	" " .....
229859	---	" " .....
202418	10929	" " .....

No.	Plate	Name
206674	13035	Lifting Presser Foot, for 206668, 206675, 206678, 206714 and 206719
206694	13037	Lifting Presser Foot, for 204621, 206692 and 206693
206695	13037	Lifting Presser Foot, for 204620, 204634, 206698 and 229620
206696	13037	Lifting Presser Foot, for 204620, 204634, 206698 and 229620
206697	13035	Lifting Presser Foot, for 204620, 204634, 206698, 206701 and 229620
206762	13035	Lifting Presser Foot, for 206703 and 206704
229625	13035	Lifting Presser Foot, for 204620, 204634, 206698, 206705, 206706 and 229620
229626	13037	Lifting Presser Foot, for 204620, 204634, 206698 and 229620
229628	13037	Lifting Presser Foot, for 204621, 206692 and 206693
229629	13037	Lifting Presser Foot, for 206691 and 229630
229633	13035	Lifting Presser Foot, for 206672, 206673, 206707 and 206715 to 206717
204620	10505	Vibrating Presser Foot, for 204594 to 204596, 204599, 204600, 204608, 204611, 204612, 204640, 206695 to 206697, 229625 and 229626
204621	13038	Vibrating Presser Foot, for 204598, 206694 and 229628
204622	10505	Vibrating Presser Foot, for 204597
204634	13036	" " " " 204594 to 204596, 204599, 204600, 204608, 204611, 204612, 204640, 206695 to 206697, 229625 and 229626
206663	13036	Vibrating Presser Foot, for 206662
206665	13038	" " " " 206664
206668	13038	" " " " 204604, 204605 and 206674
206672	13036	Vibrating Presser Foot, for 204602, 204603, 204609 and 229633
206673	13036	Vibrating Presser Foot, for 204602, 204603, 204609 and 229633
206675	13036	Vibrating Presser Foot, for 204604, 204605 and 206674
206676	13038	Vibrating Presser Foot, for 204606 and 204610

## FOR MACHINES NOS. 21w25 AND 21w54

No.	Plate	Name
204594	10505	Lifting Presser Foot, for 204620, 204634, 206698 and 229620
204595	10505	Lifting Presser Foot, for 204620, 204634, 206698 and 229620
204596	10505	Lifting Presser Foot, for 204620, 204634, 206698 and 229620
204597	10505	Lifting Presser Foot, for 204622
204598	10505	" " " " 204621, 206692 and 206693
204599	10505	Lifting Presser Foot, for 204620, 204634, 206698 and 229620
204600	10505	Lifting Presser Foot, for 204620, 204634, 206698 and 229620
204601	13034	Lifting Presser Foot, for 206707 and 206716
204602	13034	Lifting Presser Foot, for 206672, 206673, 206707 and 206715 to 206717
204603	13034	Lifting Presser Foot, for 206672, 206673, 206707 and 206715 to 206717
204604	13034	Lifting Presser Foot, for 206668, 206675, 206678, 206714 and 206719
204605	13034	Lifting Presser Foot, for 206668, 206675, 206678, 206714 and 206719
204606	13034	Lifting Presser Foot, for 206676, 206699 and 206700
204607	13034	Lifting Presser Foot, for 206707 and 206716
204608	10505	Lifting Presser Foot, for 204620, 204634, 206698 and 229620
204609	13034	Lifting Presser Foot, for 206672, 206673, 206681, 206707 and 206715 to 206717
204610	13035	Lifting Presser Foot, for 206676, 206699 and 206700
204611	13035	Lifting Presser Foot, for 204620, 204634, 206698, 206705, 206706 and 229620
204612	13035	Lifting Presser Foot, for 204620, 204634, 206698, 206705, 206706 and 229620
204640	13037	Lifting Presser Foot, for 204620, 204634, 206698 and 229620
206662	13037	Lifting Presser Foot, for 206663
206664	13037	" " " (grooved), for heavy cord covering, for 206665..

## ROLLER PRESSERS

No.	Plate	Name
201900	10169	Roller Presser, $1\frac{1}{4}$ in. diam., $\frac{1}{4}$ in. face (fine), with 200551c and 201534u .....
201901	10169	Roller Presser, $1\frac{1}{4}$ in. diam., $\frac{3}{32}$ in. face (fine), with 200551c and 201534u .....
201902	10169	Roller Presser, $1\frac{1}{2}$ in. diam., $\frac{1}{4}$ in. face (fine), with 200548c and 201534u .....
201903	10169	Roller Presser, $1\frac{1}{2}$ in. diam., $\frac{3}{32}$ in. face (fine), with 200548c and 201534u .....
201904	10169	Roller Presser, $1\frac{1}{4}$ in. diam., $\frac{5}{16}$ in. face (fine), with 200548c and 201534u .....
201905	10169	Roller Presser, $1\frac{1}{4}$ in. diam., $\frac{1}{4}$ in. face (fine), with 200548c and 201534u .....
201906	10169	Roller Presser, $1\frac{1}{4}$ in. diam., $\frac{3}{16}$ in. face (fine), with 200548c and 201534u .....
201907	10169	Roller Presser, $1\frac{1}{4}$ in. diam., $\frac{3}{32}$ in. face (fine), with 200548c and 201534u .....
201908	10169	Roller Presser, $1\frac{1}{4}$ in. diam., $\frac{1}{8}$ in. face (fine), with 200548c and 201534u .....
201909	10169	Roller Presser, $\frac{1}{2}$ in. diam., $\frac{3}{16}$ in. face (coarse), with 200551c and 201534u .....
201910	10169	Roller Presser, $\frac{1}{2}$ in. diam., $\frac{1}{4}$ in. face (coarse), with 200551c and 201534u .....
201911	10169	Roller Presser, 1 in. diam., $\frac{1}{4}$ in. face (coarse), with 200551c and 201534u .....
201912	10170	Roller Presser, $1\frac{1}{4}$ in. diam., $\frac{3}{32}$ in. face (fine), with 200548c and 201534u .....
201913	10170	Roller Presser, $1\frac{1}{4}$ in. diam., $\frac{1}{16}$ in. face (fine), with 200548c and 201534u .....
201914	10170	Roller Presser, $\frac{3}{4}$ in. diam., $\frac{1}{4}$ in. face (coarse), with 200551c and 201534u .....

No.	Plate	Name
206681	13038	Vibrating Presser Foot, for 204609
206691	13036	" " " " 229629
206692	13036	" " " " 204598, 206694 and 229628 .....
206693	13038	Vibrating Presser Foot, for 204598, 206694 and 229628 .....
206698	13036	Vibrating Presser Foot, for 204594 to 204596, 204599, 204600, 204608, 204611, 204612, 204640, 206695 to 206697, 229625 and 229626 .....
206699	13038	Vibrating Presser Foot, for 204606 and 204610 .....
206700	13036	Vibrating Presser Foot, for 204606 and 204610 .....
206701	13038	Vibrating Presser Foot, for binding slippers, for 206697 .....
206703	13036	Vibrating Presser Foot, for 206702
206704	13038	" " " " 206702
206705	13036	" " " " 204611, 204612 and 229625 .....
206706	13036	Vibrating Presser Foot, for 204611, 204612 and 229625 .....
206707	13038	Vibrating Presser Foot, for 204601 to 204603, 204607, 204609 and 229633 .....
206714	13036	Vibrating Presser Foot, for 204604, 204605 and 206674 .....
206715	13038	Vibrating Presser Foot, for 204602, 204603, 204609 and 229633 .....
206716	13038	Vibrating Presser Foot, for 204601 to 204603, 204607, 204609 and 229633 .....
206717	13038	Vibrating Presser Foot, for 204602, 204603, 204609 and 229633 .....
206719	13036	Vibrating Presser Foot, for 204604, 204605 and 206674 .....
229620	13038	Vibrating Presser Foot, for 204594 to 204596, 204599, 204600, 204608, 204611, 204612, 204640, 206695 to 206697, 229625 and 229626 .....
229630	13036	Vibrating Presser Foot, for 229629
206678	13036	" " " " 204604, 204605 and 206674 .....

No.	Plate	Name
229359	----	Roller Presser Arm 202839 with 201912 .....
206910	----	Roller Presser Arm 202839 with 201905 .....
202560	11124	Roller Presser Arm Bracket (swing)
202838	----	" " " " 202560 with 200096d and 204567 .....
208499	----	Roller Presser Arm Bracket 202560 with 200096d and 208498 .....
200675c	11124	Roller Presser Arm Bracket Position Screw Stud .....
202558	11124	Roller Presser Arm Bracket Spring
202559	11124	" " " " " " Stop .....
200141f	11124	Roller Presser Arm Bracket Spring Stop Screw .....
200096d	11124	Roller Presser Arm Screw .....
204495	10999	" " Bar .....
200548c	12039	" " Hinge Screw .....
200552c	11124	" " " " .....
200554c	12039	" " " " .....
200551c	11124	" " " " .....
201534u	11116	" " " " Nut .....
204496	-----	Roller Presser and Bar complete, Nos. 200675c, 202558, 202559, 202838, 204495 and two 200141f ..
204576	-----	Roller Presser and Bar complete, Nos. 200675c, 202558, 202559, 204495, 208499 and two 200141f ..

No.	Plate	Name
201915	10170	Roller Presser, $\frac{15}{16}$ in. diam., $\frac{5}{8}$ in. face (coarse), with 200554c .....
201916	10170	Roller Presser, $\frac{1}{2}$ in. diam., $\frac{1}{8}$ in. face (fine), with 200554c .....
201917	10170	Roller Presser, $\frac{3}{8}$ in. and $\frac{1}{2}$ in. diam., $\frac{1}{4}$ in. face (concave), with 200552c .....
201918	10170	Roller Presser, $\frac{3}{8}$ in. and $\frac{1}{2}$ in. diam., $\frac{1}{4}$ in. face (concave), with 200552c .....
201919	10170	Roller Presser, $1\frac{1}{4}$ in. diam., $\frac{1}{4}$ in. face (fine), with 200548c and 201534u .....
201920	10170	Roller Presser, $1\frac{1}{8}$ in. and $1\frac{3}{8}$ in. diam., $\frac{1}{4}$ in. face (concave), with 200551c and 201534u .....
201921	10170	Roller Presser, $1\frac{1}{4}$ in. diam., $\frac{3}{4}$ in. face (fine), with 200551c and 201534u .....
208497	---	Roller Presser Arm .....
202839	---	" " " .....
204571	---	" " " .....
204573	-----	" " " .....
213817	---	" " " .....
204577	---	" " " .....
204579	---	" " " .....
204583	---	" " " .....
204587	---	" " " .....
204578	10492	" " " 204577 with 201097 .....
204580	10492	Roller Presser Arm 204579 with 201909 .....
204582	10492	Roller Presser Arm 204579 with 201910 .....
204584	10492	Roller Presser Arm 204583 with 201914 .....
204586	10492	Roller Presser Arm 204587 with 201915 .....
204588	10942	Roller Presser Arm 204587 with 201916 .....
204567	14305	Roller Presser Arm 202839 with 201906 .....
208498	11124	Roller Presser Arm 208497 with 201910 .....
229798	14305	Roller Presser Arm 213817 with 201900 .....
204572	14305	Roller Presser Arm 204571 with 201914 .....
204574	14305	Roller Presser Arm 204573 with 201916 .....



No.	Plate	Name
212270	12007	Throat Plate, 46 needle hole, for needle sizes 16 and 18, for suspender binding, for 211128 .....
203372	12036	Throat Plate, 50 needle hole, for needle sizes 14 and 15, for corset work, for 207630 .....
211129	12007	Throat Plate, 46 needle hole, for needle sizes 16 and 18, for buff wheels, for 211131 .....
211134	12016	Throat Plate, 50 needle hole, for needle sizes 14 and 15, for 211135
211136	12009	Throat Plate, 50 needle hole, for needle sizes 14 and 15, for binding, for 211138 to 211141 .....
211137	12009	Throat Plate, 46 needle hole, for needle sizes 16 and 18, for binding, for 211138 to 211141 .....
		Nos. 211142 to 211153, for binding
211142	12009	Throat Plate, 50 needle hole, for needle sizes 14 and 15, for 211138 to 211141 .....
211143	12009	Throat Plate, 46 needle hole, for needle sizes 16 and 18, for 211138 to 211141 .....
211144	12009	Throat Plate, 50 needle hole, for needle sizes 14 and 15, for 211138 to 211141 .....
211145	12009	Throat Plate, 46 needle hole, for needle sizes 16 and 18, for 211138 to 211141 .....
211146	12009	Throat Plate, 50 needle hole, for needle sizes 14 and 15, for 211138 to 211141 .....
211147	12009	Throat Plate, 46 needle hole, for needle sizes 16 and 18, for 211138 to 211141 .....
211148	12010	Throat Plate, 50 needle hole, for needle sizes 14 and 15, for 211150
211149	12010	Throat Plate, 46 needle hole, for needle sizes 16 and 18, for 211150
211151	12010	Throat Plate, 50 needle hole, for needle sizes 14 and 15, for 211150
211152	12010	Throat Plate, 46 needle hole, for needle sizes 16 and 18, for 211150
211153	12010	Throat Plate, 50 needle hole, for needle sizes 14 and 15, for 211154
211155	12010	Throat Plate, 50 needle hole, for needle sizes 14 and 15, for top cording, for 211156 .....

## THROAT PLATES

FOR MACHINE No. 21w4

No.	Plate	Name
211076	12001	Throat Plate, 53 needle hole, for needle sizes 12 and 13, for 211079 to 211083 .....
211077	12001	Throat Plate, 50 needle hole, for needle sizes 14 and 15, for 211079 to 211083 .....
211084	12002	Throat Plate, 50 needle hole, for needle sizes 14 and 15, for 211087
211088	12002	Throat Plate, 50 needle hole, for needle sizes 14 and 15, for 211089
211090	12002	Throat Plate, 50 needle hole, for needle sizes 14 and 15, for 211091
211092	12003	Throat Plate, 50 needle hole, for needle sizes 14 and 15, for 211095 and 211096 .....
211105	12005	Throat Plate, 50 needle hole, for needle sizes 14 and 15, for 211107 to 211110 .....
211106	12005	Throat Plate, 46 needle hole, for needle sizes 16 and 18, for 211107 and 211110 .....
211112	12005	Throat Plate, 50 needle hole, for needle sizes 14 and 15, for 211107 to 211111 .....
211113	12005	Throat Plate, 46 needle hole, for needle sizes 16 and 18, for 211107 to 211111 .....
211114	12005	Throat Plate, 50 needle hole, for needle sizes 14 and 15, for 211116
211115	12005	Throat Plate, 46 needle hole, for needle sizes 16 and 18, for 211116
211117	12006	Throat Plate, 50 needle hole, for needle sizes 14 and 15, for 211118
211119	12006	Throat Plate, 50 needle hole, for needle sizes 14 and 15, for 211120
211122	12006	Throat Plate, 50 needle hole, for needle sizes 14 and 15, for 211079
211123	12007	Throat Plate, 50 needle hole, for needle sizes 14 and 15, for 211124
211125	12007	Throat Plate, 50 needle hole, for needle sizes 14 and 15, for 211126
211127	12007	Throat Plate, 50 needle hole, for needle sizes 14 and 15, for suspender binding, for 211128 .....

No.	Plate	Name
211157	12011	Throat Plate, 50 needle hole, for needle sizes 14 and 15, for top cording, for 211158 .....
211159	12011	Throat Plate, 50 needle hole, for needle sizes 14 and 15, for bottom cording, for 211079 .....
211160	12011	Throat Plate, 50 needle hole, for needle sizes 14 and 15, for covering buckles, for 211161 .....
211167	12012	Throat Plate, 50 needle hole, for needle sizes 14 and 15, for 211168
211183	12005	Throat Plate, 53 needle hole, for needle sizes 12 and 13, for 211107 and 211108 .....
203361	12036	Throat Plate, 46 needle hole, for needle sizes 16 and 18, for 207635

**FOR MACHINES NOS. 21w15 AND 21w115**

211201	12018	Throat Plate, 53 needle hole, for needle sizes 12 and 13, for 211079 to 211083 .....
211202	12018	Throat Plate, 50 needle hole, for needle sizes 14 and 15, for 211079 to 211083 .....
211203	12018	Throat Plate, 46 needle hole, for needle sizes 16 and 18, for 211079 to 211083 .....
211204	12018	Throat Plate, 50 needle hole, thick plate for heavy work, for needle sizes 14 and 15, for 211087 .....
211205	12018	Throat Plate, 46 needle hole, thick plate for heavy work, for needle sizes 16 and 18, for 211087 .....
211207	12018	Throat Plate, 50 needle hole, for needle sizes 14 and 15, for 211189
211208	12018	Throat Plate, 50 needle hole, for needle sizes 14 and 15, for 211095 and 211096 .....
211209	12018	Throat Plate, 46 needle hole, for needle sizes 16 and 18, for 211095 and 211096 .....
211215	12019	Throat Plate, 50 needle hole, for needle sizes 14 and 15, for 211107 to 211110 .....
211216	12019	Throat Plate, 46 needle hole, for needle sizes 16 and 18, for 211107 to 211110 .....
211219	12019	Throat Plate, 50 needle hole, for needle sizes 14 and 15, for 211116

No.	Plate	Name
211220	12019	Throat Plate, 46 needle hole, for needle sizes 14 and 15, for 211116
211221	12019	Throat Plate, 50 needle hole, for needle sizes 14 and 15, for 211118
212269	12019	Throat Plate, 46 needle hole, for needle sizes 16 and 18, for 211118
211222	12019	Throat Plate, 50 needle hole, for needle sizes 14 and 15, for 211128
212268	12019	Throat Plate, 46 needle hole, for needle sizes 16 and 18, for 211128
211223	12020	Throat Plate, 46 needle hole, for needle sizes 16 and 18, for buff wheels, for 211131 .....

Nos. 211225 to 211228, for binding

211225	12020	Throat Plate, 50 needle hole, for needle sizes 14 and 15, for 211138 to 211141 .....
211226	12020	Throat Plate, 46 needle hole, for needle sizes 16 and 18, for 211138 to 211141 .....
211227	12020	Throat Plate, 50 needle hole, for needle sizes 14 and 15, for 211138 to 211141 .....
211228	12020	Throat Plate, 46 needle hole, for needle sizes 16 and 18, for 211138 to 211141 .....

**FOR MACHINE No. 21w25**

210991		Throat Plate, 46 elongated needle hole, for needle sizes 20 and 22, for 211104 .....
211075	12006	Throat Plate, 46 needle hole, for needle sizes 16 and 18, for 211118
211078	12001	Throat Plate, 46 needle hole, for needle sizes 16 and 18, for 211083
211085	12002	Throat Plate, 46 needle hole, for needle sizes 16 and 18, for 211087
211086	12002	Throat Plate, 40 needle hole, for needle sizes 20 and 22, for 211087
211093	12003	Throat Plate, 46 needle hole, for needle sizes 16 and 18, for 211095 and 211096 .....
211094	12003	Throat Plate, 40 needle hole, for needle sizes 20 and 22, for 211095 and 211096 .....

## Throat Plates

No.	Plate	Name
211097	12003	Throat Plate, 46 needle hole, for needle sizes 16 and 18, for 207606 and 211099 .....
211098	12003	Throat Plate, 40 needle hole, for needle sizes 20 and 22, for 207606 and 211099 .....
211100	12004	Throat Plate, 46 needle hole, for needle sizes 16 and 18, for 207605
211101	12004	Throat Plate, 40 needle hole, for needle sizes 20 and 22, for 207605
211102	12004	Throat Plate, 46 needle hole, for needle sizes 16 and 18, for 211104
211103	12004	Throat Plate, 40 needle hole, for needle sizes 20 and 22, for 211104
211106	12005	Throat Plate, 46 needle hole, for needle sizes 16 and 18, for 211107 to 211110 .....
211113	12005	Throat Plate, 46 needle hole, for needle sizes 16 and 18, for 211107 to 211111 .....
211115	12005	Throat Plate, 46 needle hole, for needle sizes 16 and 18, for 211116
212270	12007	Throat Plate, 46 needle hole, for needle sizes 16 and 18, for suspender binding, for 211128 .....
211129	12007	Throat Plate, 46 needle hole, for needle sizes 16 and 18, for buff wheels, for 211131 .....
211137	12009	Throat Plate, 46 needle hole, for needle sizes 16 and 18, for 211138 to 211141 .....
		Nos. 211142 to 211160, for binding
211142	12009	Throat Plate, 50 needle hole, for needle sizes 14 and 15, for 211138 to 211141 .....
211143	12009	Throat Plate, 46 needle hole, for needle sizes 16 and 18, for 211138 to 211141 .....
211144	12009	Throat Plate, 50 needle hole, for needle sizes 14 and 15, for 211138 to 211141 .....
211145	12009	Throat Plate, 46 needle hole, for needle sizes 16 and 18, for 211138 to 211141 .....
211146	12009	Throat Plate, 50 needle hole, for needle sizes 14 and 15, for 211138 to 211141 .....

## Throat Plates

No.	Plate	Name
211147	12009	Throat Plate, 46 needle hole, for needle sizes 16 and 18, for 211138 to 211141 .....
211148	12010	Throat Plate, 50 needle hole, for needle sizes 14 and 15, for 211150
211149	12010	Throat Plate, 46 needle hole, for needle sizes 16 and 18, for 211150
211151	12010	Throat Plate, 50 needle hole, for needle sizes 14 and 15, for 211150
211152	12010	Throat Plate, 46 needle hole, for needle sizes 16 and 18, for 211150
211153	12010	Throat Plate, 50 needle hole, for needle sizes 14 and 15, for 211154
211155	12010	Throat Plate, 50 needle hole, for needle sizes 14 and 15, for 211156
211157	12011	Throat Plate, 50 needle hole, for needle sizes 14 and 15, for 211158
211159	12011	Throat Plate, 50 needle hole, for needle sizes 14 and 15, for 211079
211160	12011	Throat Plate, 50 needle hole, for needle sizes 14 and 15, for 211161
		<b>FOR MACHINE No. 21w30</b>
211189	12016	Throat Plate, 50 needle hole, for needle sizes 14 and 15, for 211107 and 211108 .....
211198	12016	Throat Plate, 46 needle hole, for needle sizes 16 and 18, for 211107 and 211108 .....
211251	12026	Throat Plate, 56 needle hole, for needle sizes 10 and 11, for 211255 and 211256 .....
211252	12026	Throat Plate, 53 needle hole, for needle sizes 12 and 13, for 211255 and 211256 .....
211253	12026	Throat Plate, 50 needle hole, for needle sizes 14 and 15, for 211255 and 211256 .....
211254	12026	Throat Plate, 46 needle hole, for needle sizes 16 and 18, for 211255 and 211256 .....
211257	12026	Throat Plate, 53 needle hole, for needle sizes 12 and 13, for 211255 and 211256 .....
211258	12026	Throat Plate, 50 needle hole, for needle sizes 14 and 15, for 211255 and 211256 .....
211259	12026	Throat Plate, 46 needle hole, for needle sizes 16 and 18, for 211255 and 211256 .....

Throat Plates

105

No.	Plate	Name
211332	12037	Throat Plate, 50 needle hole, for needle sizes 14 and 15, for 211268
211333	12037	Throat Plate, 46 needle hole, for needle sizes 16 and 18, for 211268
211339	12016	Throat Plate, 50 elongated needle hole, for needle sizes 16 and 18, for 211255 and 211256 .....
215900	12016	Throat Plate, 46 elongated needle hole, for needle sizes 20 and 22, for 211255 and 211256 .....

FOR MACHINE No. 21w54

203801	12016	Throat Plate, 50 needle hole, for needle sizes 14 and 15, for 211150
211215	12019	Throat Plate, 50 needle hole, for needle sizes 14 and 15, for 211107 to 211110 .....
211216	12019	Throat Plate, 46 needle hole, for needle sizes 16 and 18, for 211107 to 211110 .....

FOR MACHINE No. 21w118

211206	12018	Throat Plate, 40 needle hole, thick plate, for heavy work, for needle sizes 20 and 22, for 211087 .....
211210	12018	Throat Plate, 40 needle hole, for needle sizes 20 and 22, for 211095 and 211096 .....
211212	12018	Throat Plate, 40 needle hole, for needle sizes 20 and 22, for 207606 and 211099 .....
211214	12019	Throat Plate, 40 needle hole, for needle sizes 20 and 22, for 207605
211213	12019	Throat Plate, 46 needle hole, for needle sizes 16 and 18, for 207605
211217	12019	Throat Plate, 46 needle hole, for needle sizes 16 and 18, for 211104
211218	12019	Throat Plate, 40 needle hole, for needle sizes 20 and 22, for 211104
211224	12020	Throat Plate, 40 needle hole, for needle sizes 20 and 22, for buff wheels, for 211131 .....

FOR MACHINE No. 21w122

211923	12036	Throat Plate, 46 needle hole, for needle sizes 16 and 18 .....
211924	12036	Throat Plate, 50 needle hole, for needle sizes 14 and 15 .....

101

Throat Plates

No.	Plate	Name
211260	12026	Throat Plate, 53 needle hole, for needle sizes 12 and 13, for 211263 and 211264 .....
211261	12026	Throat Plate, 50 needle hole, for needle sizes 14 and 15, for 211263 and 211264 .....
211262	12026	Throat Plate, 46 needle hole, for needle sizes 16 and 18, for 211263 and 211264 .....
211265	12016	Throat Plate, 50 needle hole, for needle sizes 14 and 15, for 211268
211266	12016	Throat Plate, 46 needle hole, for needle sizes 16 and 18, for 211268
211267	12016	Throat Plate, 40 needle hole, for needle sizes 20 and 22, for 211268
211283	12026	Throat Plate, 40 needle hole, for needle sizes 20 and 22, for 211263 and 211264 .....

FOR MACHINES NOS. 21w50 AND 21w160

211324	12016	Throat Plate, 53 elongated needle hole, for needle sizes 14 and 15, for 211255 and 211256 .....
211325	12037	Throat Plate, 46 needle hole, for needle sizes 16 and 18, for 211263 and 211264 .....
211326	12037	Throat Plate, 53 needle hole, for needle sizes 12 and 13, for 211255 and 211256 .....
211327	12037	Throat Plate, 50 needle hole, for needle sizes 14 and 15, for 211255 and 211256 .....
211328	12037	Throat Plate, 53 needle hole, for needle sizes 12 and 13, for 211263 and 211264 .....
211329	12037	Throat Plate, 50 needle hole, for needle sizes 14 and 15, for 211263 and 211264 .....
211248	12037	Throat Plate, 46 needle hole, for needle sizes 16 and 18, for 211255 and 211256 .....
211330	12037	Throat Plate, 53 elongated needle hole, for needle sizes 14 and 15, for 211263 and 211264 .....
211331	12037	Throat Plate, 50 elongated needle hole, for needle sizes 16 and 18, for 211263 and 211264 .....
211244	12037	Throat Plate, 46 elongated needle hole, for needle sizes 20 and 22, for 211263 and 211264 .....

**Binders**

107

No.	Plate	Name
211189	12016	Throat Plate, 50 needle hole, for needle sizes 14 and 15, for Machine No. 21w30 .....
211215	12019	Throat Plate, 50 needle hole, for needle sizes 14 and 15, for Machines Nos. 21w15, 21w54 and 21w115 .....

**BINDER (Bias)**

For Dressmaking, etc.

230196	14222	Binder on Shank, for strips $\frac{3}{4}$ in. wide .....
--------	-------	--

**BINDER (Bias)**

For Skirt Work

230202	14226	Binder on Shank, for strips $\frac{3}{4}$ in. wide .....
--------	-------	--

**BINDER (Bias)**

For Skirts

225636	14225	Binder on Shank, folds binding of the following widths: $\frac{3}{8}$ , $\frac{1}{2}$ , $\frac{3}{4}$ , $\frac{7}{8}$ , $\frac{1}{2}$ , $\frac{3}{4}$ and 1 inch .....
211108	12005	Feed Dog .....
206779	11123	Presser Foot .....
211105	12005	Throat Plate, 50 needle hole, for needle sizes 14 and 15, for Machine No. 21w4 .....
211189	12016	Throat Plate, 50 needle hole, for needle sizes 14 and 15, for Machine No. 21w30 .....
211215	12019	Throat Plate, 50 needle hole, for needle sizes 14 and 15, for Machines Nos. 21w15, 21w54 and 21w115 .....

**BINDER (Bias)**

225627	10311	Binder on Shank, for strips $\frac{3}{8}$ , $\frac{1}{2}$ , $\frac{3}{4}$ and 1 inch .....
211108	12005	Feed Dog .....
206779	11123	Presser Foot .....
211105	12005	Throat Plate, 50 needle hole, for needle sizes 14 and 15, for Machine No. 21w4 .....

06

**Throat Plates**

No.	Plate	Name
211925	12036	Throat Plate, 40 needle hole, for needle sizes 20 and 22 .....
211926	12036	Throat Plate, 38 needle hole, for needle sizes 23 and 24 .....

**PRESSER BAR**

(SWING BRACKET)

204589	10491	Presser Bar (swing) with 200675c, for Presser Foot or Roller Pressers with solid hangers ....
204590	10491	Presser Bar Bushing .....
204591	10491	" " Position Clamp with 200074c and 200613c .....
200074c	12308	Presser Bar Position Clamp Pinch Screw .....
200613c	10491	Presser Bar Position Clamp Position Screw .....
200675c	11124	Presser Bar Position Clamp Screw Stud .....
204592	10491	Presser Bar Spring .....
200162b	10491	" " " Stop Screw ....
204593	10491	Presser Bar (swing) complete, Nos. 200162b and 204589 to 204592 ...

**BINDERS**

When Ordering Binders, State Size Required. Send Sample of Binding and Material to be Bound

**BINDER (Bias)**

Folds the Top Edge of Bias Binding

225626	10311	Binder on Shank, for binding from $\frac{3}{8}$ to 1 in., in steps of $\frac{1}{16}$ inch ..
211108	12005	Feed Dog, for 211105, 211189 and 211215 .....
206779	11123	Presser Foot .....
211105	12005	Throat Plate, 50 needle hole, for needle sizes 14 and 15, for Machine No. 21w4 .....

## Binders

109

No.	Plate	Name
211215	12019	Throat Plate, 50 needle hole, for needle sizes 14 and 15, for Machines Nos. 21w15, 21w54 and 21w115 .....

## BINDER

## For Dress Shields

225628	10311	Binder on Shank, for $\frac{7}{16}$ in. tape binding .....
211108	12005	Feed Dog .....
206841	11123	Presser Foot .....
211105	12005	Throat Plate, 50 needle hole, for needle sizes 14 and 15, for Machine No. 21w4 .....
211189	12016	Throat Plate, 50 needle hole, for needle sizes 14 and 15, for Machine No. 21w30 .....
211215	12019	Throat Plate, 50 needle hole, for needle sizes 14 and 15, for Machines Nos. 21w15, 21w54 and 21w115 .....

## BINDER

## For Corset Work, etc.

230105	11124	Binder Head, for tapes or folded strips of various widths .....
230110	14534	Binder Swing Bracket with nine 225648 .....
226074	11000	Binder Swing Bracket Base .....
200922b	11124	" " " " Hinge Screw .....
201527c	11124	Binder Swing Bracket Base Hinge Screw Nut .....
225648	12015	Binder Tape Tension Pin .....
200463b	11124	" Thumb Screw .....
230256	—	Binder complete, for $\frac{1}{4}$ to $\frac{3}{4}$ in. tapes, Nos. 200922b, 201527c, 226074, 230105, 230110 and two 200463b .....
211150	12010	Feed Dog .....
206779	11123	Presser Foot .....
211148	12010	Throat Plate, 50 needle hole, for needle sizes 14 and 15, for Machines Nos. 21w4 and 21w25 .....

## BINDER

230115	11124	Binder Head, for tapes or folded strips of various widths .....
--------	-------	---

108

## Binders

No.	Plate	Name
211189	12016	Throat Plate, 50 needle hole, for needle sizes 14 and 15, for Machine No. 21w30 .....
211215	12019	Throat Plate, 50 needle hole, for needle sizes 14 and 15, for Machines Nos. 21w15, 21w54 and 21w115 .....

## BINDER (Bias)

225659	10316	Binder on Shank, for binding from $\frac{3}{8}$ to 1 in., in steps of $\frac{1}{16}$ inch ..
--------	-------	--

## BOSTON BINDER

## For Shoes and Slippers

225630	14226	Binder on Shank, for tapes from $\frac{1}{4}$ to 1 in., in steps of $\frac{1}{16}$ inch
225631	14226	Binder on Shank, with shank extending beyond Binder, for tapes of the following widths: $\frac{3}{16}$ , $\frac{1}{4}$ , $\frac{5}{16}$ , $\frac{3}{8}$ , $\frac{11}{16}$ , $\frac{1}{2}$ , $\frac{13}{16}$ , $\frac{7}{8}$ , $\frac{15}{16}$ and 1 inch
211107	12005	Feed Dog .....
202356	13029	Presser Foot .....
211105	12005	Throat Plate, 50 needle hole, for needle sizes 14 and 15, for Machine No. 21w4 .....
211189	12016	Throat Plate, 50 needle hole, for needle sizes 14 and 15, for Machine No. 21w30 .....
211215	12019	Throat Plate, 50 needle hole, for needle sizes 14 and 15, for Machines Nos. 21w15, 21w54 and 21w115 .....

## BINDER

## For Tapes or Folded Strips Without Seams

225624	10311	Binder on Shank, for tapes $\frac{3}{16}$ , $\frac{1}{4}$ , $\frac{5}{16}$ , $\frac{3}{8}$ , $\frac{11}{16}$ , $\frac{1}{2}$ , $\frac{13}{16}$ , $\frac{7}{8}$ , $\frac{15}{16}$ and 1 inch ..
211108	12005	Feed Dog .....
206779	11123	Presser Foot .....
211105	12005	Throat Plate, 50 needle hole, for needle sizes 14 and 15, for Machine No. 21w4 .....
211189	12016	Throat Plate, 50 needle hole, for needle sizes 14 and 15, for Machine No. 21w30 .....

## HEMMERS

No.	Plate	Name
230186	14222	Hemmer on Shank, for umbrella work .....
230193	14223	Hemmer on Shank, for hems of various widths .....
Note. Specify width wanted on order.		
230285	14228	Hemmer on Shank, for hems from $\frac{1}{2}$ to 1 in., in steps of $\frac{1}{16}$ in., for hemming folded seams .....
230741	14222	Hemmer on Shank, for hems $\frac{1}{4}$ , $\frac{3}{8}$ , $\frac{1}{2}$ , $\frac{5}{8}$ and $\frac{3}{4}$ inch .....
Note. Specify width wanted on order.		

### HEMMER (Brass)

#### Bent Up from One Piece and Formed into U Shape

230210	14222	Hemmer, for hems $\frac{1}{4}$ , $\frac{3}{8}$ and $\frac{1}{2}$ in. wide .....
Note. Specify width wanted on order.		

### HEMMER

230170	14228	Hemmer on Shank, for hems of the following widths: 1, 1 $\frac{1}{4}$ , 1 $\frac{1}{2}$ , 1 $\frac{3}{4}$ , 1 $\frac{7}{8}$ , 1 $\frac{3}{4}$ , 2, 2 $\frac{1}{4}$ , 2 $\frac{1}{2}$ , 2 $\frac{3}{4}$ and 3 inches .....
Note. Specify width wanted on order.		
203075	14228	Hemmer Base Plate with 225706 ..
225706	12015	" " " Position Pin ..
200246B	12015	" " " Screw .....
201525E	11143	" " " " Nut .....
225708	12015	" " " Spring .....
226663	14225	" Clamp Washer .....
200093B	12015	" Screw .....
200469B	12015	" Thumb Screw .....
230171	14230	Hemmer complete, Nos. 200093B, 200246B, 200469B, 201525E, 203075, 225708, 226663 and 230170 .....

### HEMMER ON SWING BRACKET

225970	14226	Hemmer on Shank, made for hems of the following widths: $\frac{1}{4}$ , $\frac{3}{8}$ , $\frac{1}{2}$ , $\frac{5}{8}$ , $\frac{3}{4}$ , $\frac{7}{8}$ and $\frac{1}{2}$ inch .....
Note. Specify width wanted on order.		

No.	Plate	Name
230117	14534	Binder Swing Bracket with nine 225648 .....
226074	11000	Binder Swing Bracket Base .....
200922D	11124	" " " " Hinge Screw .....
201527C	11124	Binder Swing Bracket Base Hinge Screw Nut .....
225648	12015	Binder Tape Tension Pin .....
200463D	11124	" Thumb Screw .....
230119	-----	Binder complete, for $\frac{1}{4}$ to $\frac{3}{4}$ in. tapes, Nos. 200922D, 201527C, 226074, 230115, 230117 and two 200463D .....
211138	12009	Feed Dog .....
206779	11123	Presser Foot .....
211142	12009	Throat Plate, 50 needle hole, for needle sizes 14 and 15, for Machines Nos. 21w4 and 21w25 .....
211227	12020	Throat Plate, 50 needle hole, for needle sizes 14 and 15, for Machines Nos. 21w15 and 21w115 ..

## GUIDE

### For Shoe Lining Work

225960	13039	Guide .....
200157B	13008	" Screw .....
211107	12005	Feed Dog .....
202090	12309	Presser Foot Hinge Pin .....
*231006	-	" " Plate and Folder ..
202924	-----	" " Shank .....
225961	13039	Presser Folder (hinged) complete, Nos. 202090, 202924 and 231006, for closing heel seams on shoe linings .....
211189	12016	Throat Plate, 50 needle hole, for needle sizes 14 and 15, for Machine No. 21w30 .....

### GUIDE ON SWING BRACKET

#### For Tailoring

226039	14226	Guide .....
226292	-----	Guide on Swing Bracket complete, Nos. 226039 and 226977 .....

Hemmers

113

No.	Plate	Name
225781	10347	Hemmer (reverse) complete, Nos. 225779, 225780, two each 200142B and 202603 .....

HEMMER

For Hemming Pillow Cases or Other Tubular Work

For Hems 1/2 in. to 4 inches

Note. Specify width wanted on order

203075	14228	Base Plate with 225706 .....
230000	-----	" " 203075 with 200246B, 201525E, 225708, 226663 and two 200160B .....
225706	12015	Base Plate Position Pin .....
200246B	12015	" " Screw .....
201525E	11143	" " Nut .....
225708	12015	" " Spring .....
*225764	-----	Hemmer on Shank .....
*225767	-----	" Plate with 200857E and 225586 .....
226663	14225	Hemmer Plate Clamp Washer ....
200160B	12015	" " " " Screw .....
225586	12015	" Position Pin .....
200857E	12015	" Screw Stud .....
225765	12015	" Switch Handle with 200397C and 201609 .....
*201609	-----	Hemmer Switch Handle Stud ....
200397C	12309	" " " " Set Screw .....
204004	12015	Hemmer Switch Handle Washer ..
225769	14230	Hemmer complete, for hems 1/2 to 4 in., Nos. 204004, 225764, 225767 and 230000 .....

HEMMER

For Sheets, etc. Sizes from 1/2 to 3 1/4 inches

Note. Specify width wanted on order

225794	14225	Hemmer on Shank .....
200160B	12015	" Adjusting Screw .....
226663	14225	" " " Washer ...
203075	14228	" Base Plate with 225706 ....
230000	-----	" " " 203075 with 200246B, 201525E, 225708, 226663 and two 200160B .....

112

Hemmers

No.	Plate	Name
226110	13008	Hemmer Swing Bracket with 200369D and 200862E .....
226977	14230	Hemmer Swing Bracket 226110 with 200157D, 201526E, 201563B, 225734, 225735 and 226071 .....
200369D	13008	Hemmer Swing Bracket Adjusting Screw .....
225735	13008	Hemmer Swing Bracket Base ....
200157D	13008	" " " " Hinge Screw .....
201526E	13008	Hemmer Swing Bracket Base Hinge Screw Nut .....
226071	13008	Hemmer Swing Bracket Base Hinge Screw Spring Washer .....
200862E	12015	Hemmer Swing Bracket Screw Stud .....
201563B	13008	" " " " " " Thumb Nut .....
225734	13008	Hemmer Swing Bracket Screw Stud Washer .....
225973	-----	Hemmer on Swing Bracket complete, Nos. 225970 and 226977 ..

HEMMER

For Handkerchief Hemming

230187	14223	Hemmer on Shank .....
211091	12002	Feed Dog .....
202372	13030	Presser Foot (hinged) complete, Nos. 202090, 202924 and 203034 ..
211090	12002	Throat Plate, 50 needle hole, for needle sizes 14 and 15, for Machine No. 21w4 .....

HEMMER

For Counterpane Hemming

230321	14223	Hemmer on Shank .....
211107	12005	Feed Dog .....
229595	14223	Presser Foot .....
211105	12005	Throat Plate, 46 needle hole, for needle sizes 16 and 18, for Machine No. 21w4 .....

HEMMER (Reverse)

For Hemming and Stitching on Lace

225779	10347	Hemmer on Shank, for 3/8 in. hem .....
225780	10347	" Lace Guide .....
200142B	10347	" Shank Screw .....
202603	10347	" " " Washer .....



## DRIVING ATTACHMENT

No.	Plate	Name
203652	12042	Balance Wheel with 200328c and 200335c .....
200013E	12223	Balance Wheel Adjusting Screw ..
200328c	12311	" " Position Screw ....
200335c	12223	" " Set Screw .....
203172	12307	" " Washer .....
204686	12042	Driving Arm with 204687, 204856 and two 200374c .....
204856	12223	Driving Arm Brake (leather) .....
204687	—	" " Bushing .....
200374c	12223	" " " Set Screw ....
200211E	12223	" " Hinge Screw .....
200335c	12223	" " " " Set Screw .....
204689	12042	" " Friction Pulley, for round belt (grooved), 2½ in. diam., with 200387c, 200840E, 202330, 204105, 204688 and 204693 .....
204690	—	Driving Friction Pulley, for round belt (grooved), 3 in. diam., with 200387c, 200840E, 202330, 204105, 204688 and 204693 .....
204691	—	Driving Friction Pulley, 1½ in. face, 2 in. diam., with 200387c, 204105, 204688 and 204693 .....
204692	—	Driving Friction Pulley, 1½ in. face, 2½ in. diam., with 200387c, 204105, 204688 and 204693 .....
204693	12223	Driving Friction Pulley Center Bearing (wood) .....
200387c	12223	Driving Friction Pulley Center Bearing Set Screw .....
204688	12042	Driving Friction Pulley Friction Ring (leather) .....
204105	12223	Driving Friction Pulley Friction Ring Stop Pin .....
204694	12042	Driving Friction Pulley Oil Cover with 202126 .....
202126	12308	Driving Friction Pulley Oil Cover Position Pin .....
200036E	12223	Driving Friction Pulley Oil Cover Screw .....
202330	—	Driving Friction Pulley Oil Packing (wick) .....
200840E	12311	Driving Friction Pulley Oil Packing (wick) Stop Screw .....

No.	Plate	Name
225706	12015	Hemmer Base Plate Position Pin ..
200246B	12015	" " " Screw .....
201525E	11143	" " " " Nut .....
225708	12015	" " " Spring .....
225796	—	Hemmer complete, for hems ½ to ¾ in., Nos. 225794 and 230000 .....

## HEMMER FEET

225740	10393	Hemmer Foot, for ½ in. hem .....
225801	10393	" " " ¾ in. hem, for thick soft wollens and felling corner seams .....
225802	10393	Hemmer Foot, for ⅝ and ¾ in. hems, for cord guiding, sews a cord within the hem .....

## ROLLER WELT GAUGE

226261	11145	Roller Welt Gauge with 201849 ...
226259	11145	" " " Frame with 226264
226273	11145	" " " " 226259 with 200297B, 226261 to 226263, two each 200056B and 202603 .....
230736	11145	Roller Welt Gauge Frame Base Plate .....
200056B	12319	Roller Welt Gauge Frame Screw
202603	11145	" " " " " Washer .....
226262	11145	Roller Welt Gauge Handle .....
226264	11145	" " " " Cushion (leather) .....
200297B	11145	Roller Welt Gauge Handle Hinge Screw .....
201836	—	Roller Welt Gauge Roller .....
201849	11145	" " " " 201836 with 206521 .....
206521	11145	Roller Welt Gauge Roller Stud ....
226263	11145	" " " Spring .....
230737	11145	Roller Welt Gauge complete, Nos. 226273 and 230736 .....

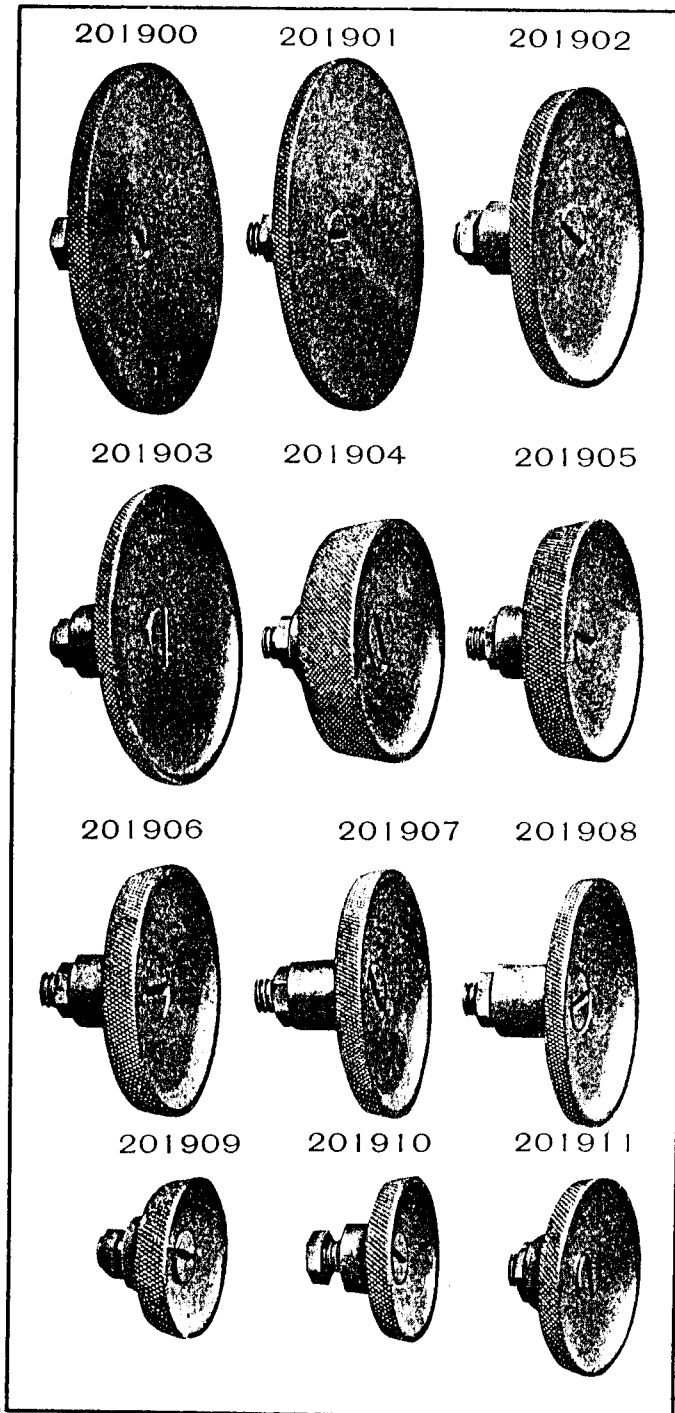
No.	Plate	Name
204128	12017	Treadle Stand (right) with two wood screws 1 in., No. 13 .....
228191	---	Treadle and Pitman complete, Nos. 126037, 204127, 204128 and 227934
227936	---	Driving Attachment with Treadle and Pitman complete, Nos. 27070, 206610 and 228191 .....
227937	---	Driving Attachment with Treadle and Pitman complete, Nos. 206612, 227579 and 228191 .....

## OBSOLETE PARTS

204737	11000	Balance Wheel (belt groove 2 $\frac{1}{2}$ in. diam.), for Machine No. 21w122
*213605	---	Feed Driving Cam Fork Lever Slide Block .....
*213604	---	Feed Driving Cam Fork Lever Slide Block with 200116c .....
213606	13041	Feed Driving Cam Fork Lever Slide Block 213604 with 213605 .....
200116c	13041	Feed Driving Cam Fork Lever Slide Block Hinge Screw .....
203250	12308	Hook Driving Shaft Collar with two 200393c .....
204740	10496	Machine Driving Friction (leather)
223007	12015	" Stop Cam Slide .....
223005	12031	" " " " Lever with 223006 .....
223008	12031	Machine Stop Cam Slide Lever 223005 with 200249e, 200994e, 201822, 223007 and two 201525e ..
223006	12015	Machine Stop Cam Slide Position Pin .....
204042	13014	Presser Foot (steel), for Machines Nos. 21w4, 21w15 and 21w115 ..
225580	13014	Presser Foot (steel), for Machines Nos. 21w4, 21w15 and 21w115 ..
Nos. 211162 to 211166, for Machine No. 21w122		
211162	12012	Throat Plate, 50 needle hole, for needle sizes 14 and 15 .....
211163	12012	Throat Plate, 46 needle hole, for needle sizes 16 and 18 .....
211164	12012	Throat Plate, 40 needle hole, for needle sizes 20 and 22 .....

No.	Plate	Name
206610	---	Driving Attachment complete (driving friction pulley) (grooved), 2 $\frac{1}{2}$ in. diam., Nos. 200013e, 200036e, 200211e, 200335c, 203172, 203652, 204686, 204689 and 204694 .....
206611	---	Driving Attachment complete (driving friction pulley) (grooved), 3 in. diam., Nos. 200013e, 200036e, 200211e, 200335c, 203172, 203652, 204686, 204690 and 204694 .....
206612	---	Driving Attachment complete (driving friction pulley), 1 $\frac{1}{2}$ in. face, 2 in. diam., Nos. 200013e, 200036e, 200211e, 200335c, 203172, 203652, 204686, 204691 and 204694 .....
206613	---	Driving Attachment complete (driving friction pulley), 1 $\frac{1}{2}$ in. face, 2 $\frac{1}{2}$ in. diam., Nos. 200013e, 200036e, 200211e, 200335c, 203172, 203652, 204686, 204692 and 204694 .....
27070	12017	Shaft Pulley (sectional, grooved), 10 in. diam., 1 $\frac{3}{8}$ in. bore, with two 597c .....
227579	---	Shaft Pulley (flanged) (sectional, flat face), 8 in. diam., 1 $\frac{1}{4}$ in. face, 1 $\frac{3}{8}$ in. bore, with two 200008c ..
597c	12039	Shaft Pulley Clamping Screw ....
200008c	12223	" " " " .....
126036	12017	Treadle .....
126037	---	" 126036 with 2718r, 50581r and 126038 .....
126038	12017	Treadle Extension .....
50581r	11124	" " Screw .....
2718r	11124	" " " Washer .....
204696	12223	" Lifting Spring .....
204697	12223	" " " Hook (bench)
227933	12017	" Pitman Rod (lower) .....
204698	11993	" " " (upper) with 202302 .....
204126	12223	Treadle Pitman Rod Clamp with two 200530c .....
200530c	12223	Treadle Pitman Rod Clamp Set Screw .....
202302	12306	Treadle Pitman Rod Cotter Pin ..
227934	---	Treadle Pitman complete, Nos. 204696 to 204698, 227933 and two 204126 .....
204127	12017	Treadle Stand (left) with two wood screws 1 in., No. 13 .....

PLATE 10169—FULL SIZE



No.	Plate	Name
211165	12012	Throat Plate, 38 needle hole, for needle sizes 23 and 24 .....
211166	12012	Throat Plate, 50 elongated needle hole, for needle sizes 16 and 18..
215612	-----	Vibrating Presser Bar .....
204489	13041	" " " 215612 with 204493 and two 200138b, for Machines Nos. 21w25 and 21w54 ..
215628	-----	Vibrating Presser Bar .....
204488	13041	" " " 215628 with 204493 and two 200138b, for Machines Nos. 21w25 and 21w54 ..
204492	13041	Vibrating Presser Bar Position Guide, for Machines Nos. 21w25 and 21w54 .....
200582c	13041	Vibrating Presser Bar Position Guide Screw .....
204623	13041	Vibrating Presser Foot, for 204488, 204602 and 204603, for Machines Nos. 21w25 and 21w54 .....
204624	13041	Vibrating Presser Foot, for 204488, 204601 and 204607, for Machines Nos. 21w25 and 21w54 .....
204625	13041	Vibrating Presser Foot, for 204489 and 204604, for Machines Nos. 21w25 and 21w54 .....
204627	13041	Vibrating Presser Foot, for 204488 and 204609, for Machines Nos. 21w25 and 21w54 .....
204630	13041	Vibrating Presser Foot, for 204488, 204602 and 204603, for Machines Nos. 21w25 and 21w54 .....
204631	13041	Vibrating Presser Foot, for 204489 and 204604, for Machines Nos. 21w25 and 21w54 .....
229632	13041	Vibrating Presser Foot, for 204488 and 204603, for Machines Nos. 21w25 and 21w54 .....

PLATE 10259—FULL SIZE

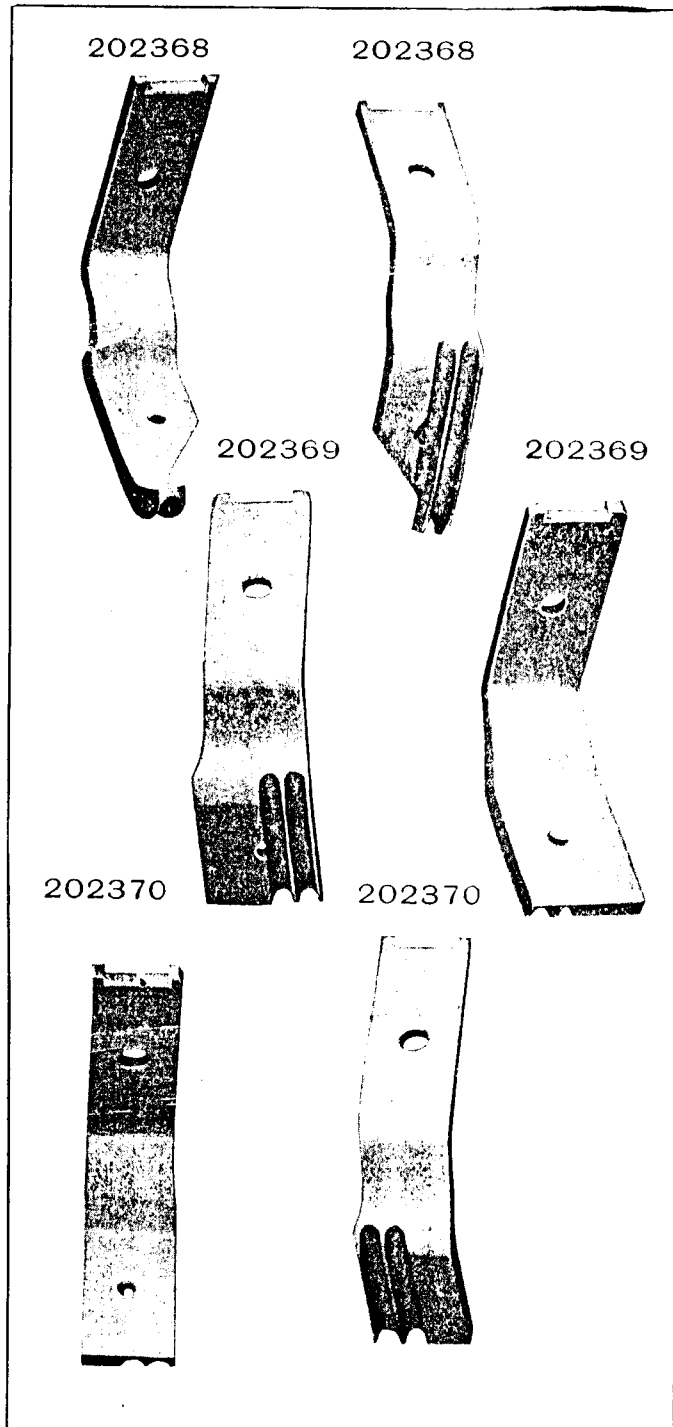


PLATE 10170—FULL SIZE

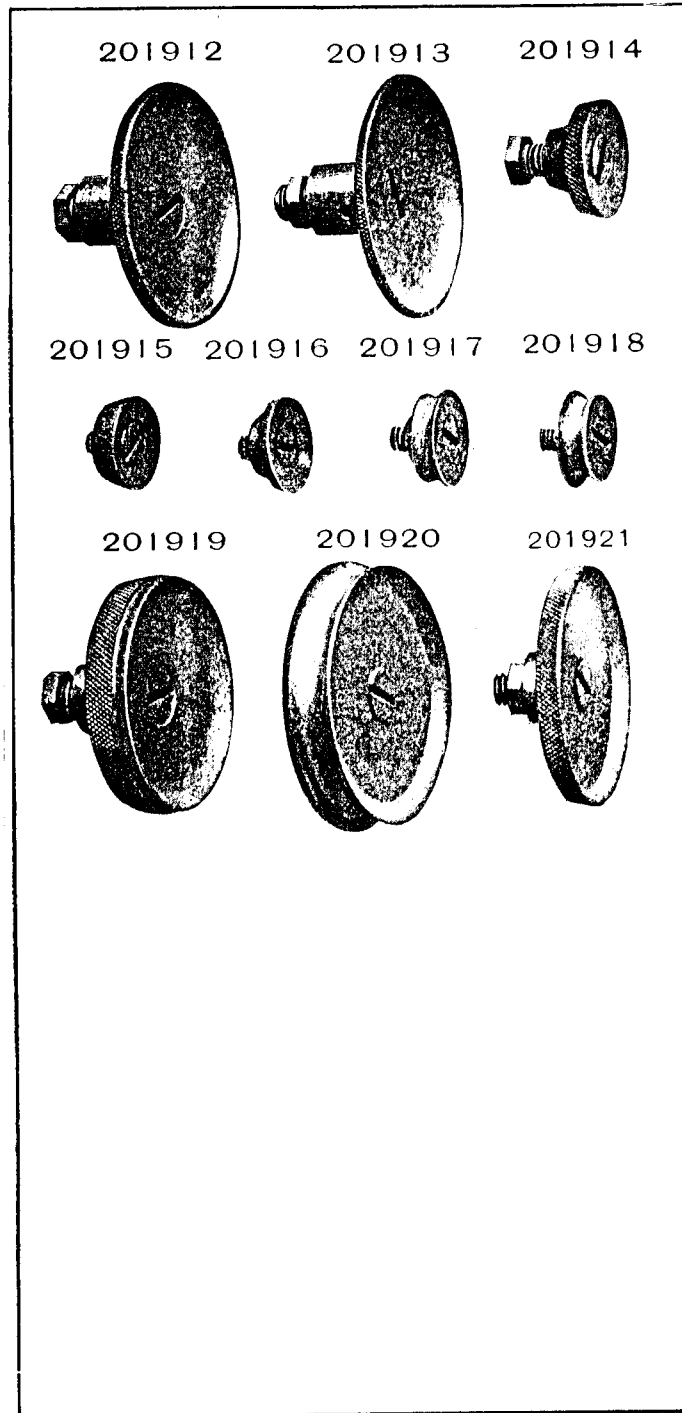


PLATE 10316—FULL SIZE

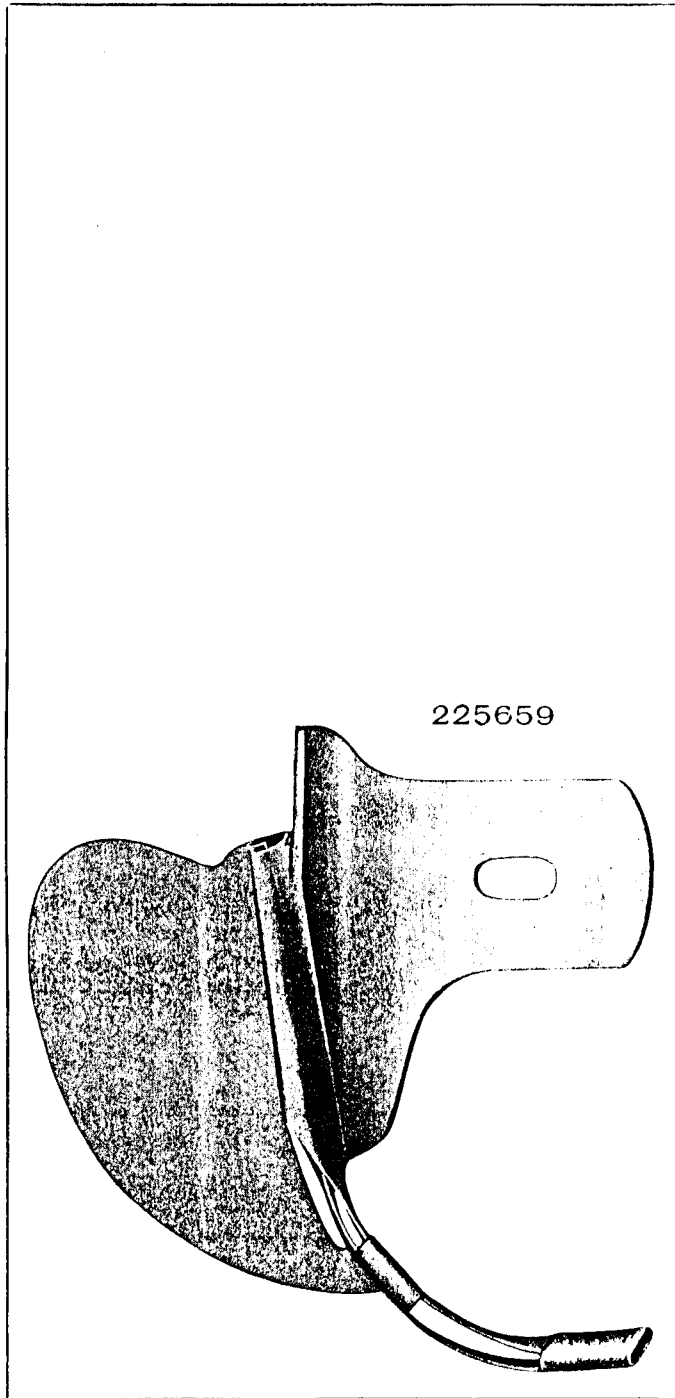


PLATE 10311—FULL SIZE

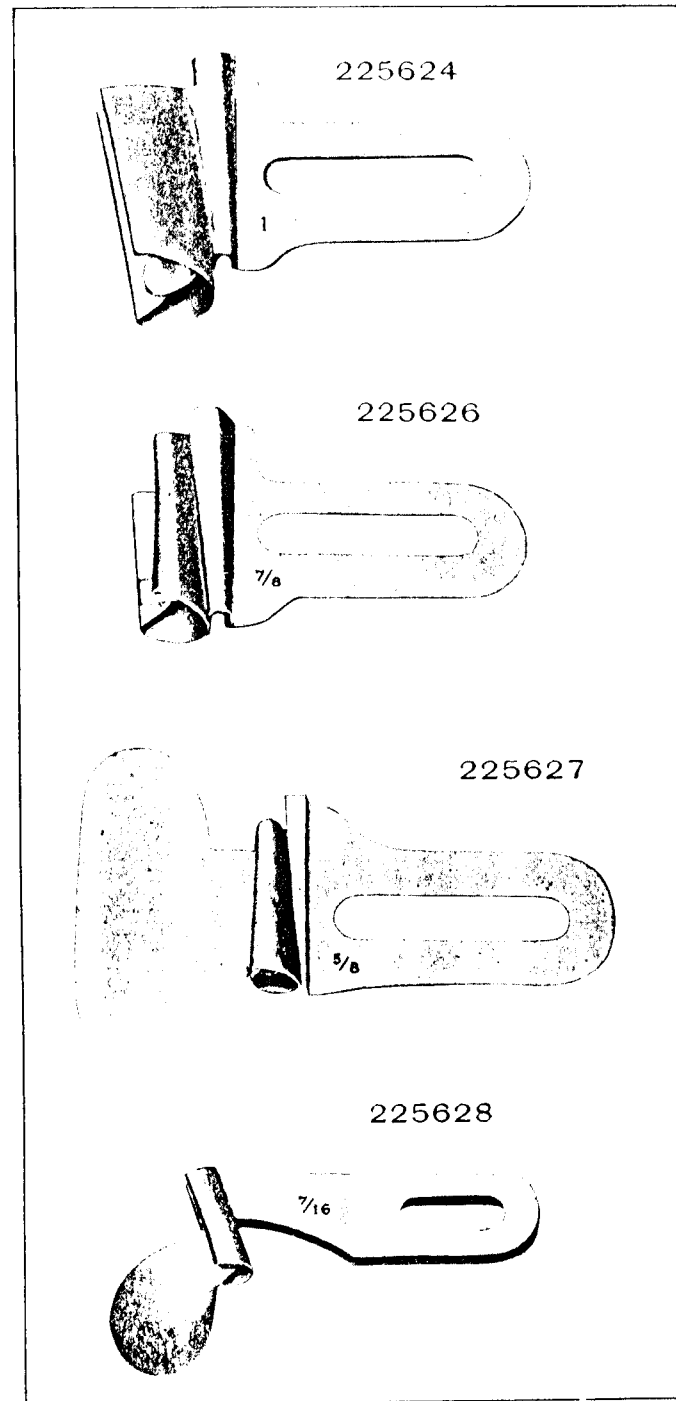


PLATE 10393—FULL SIZE

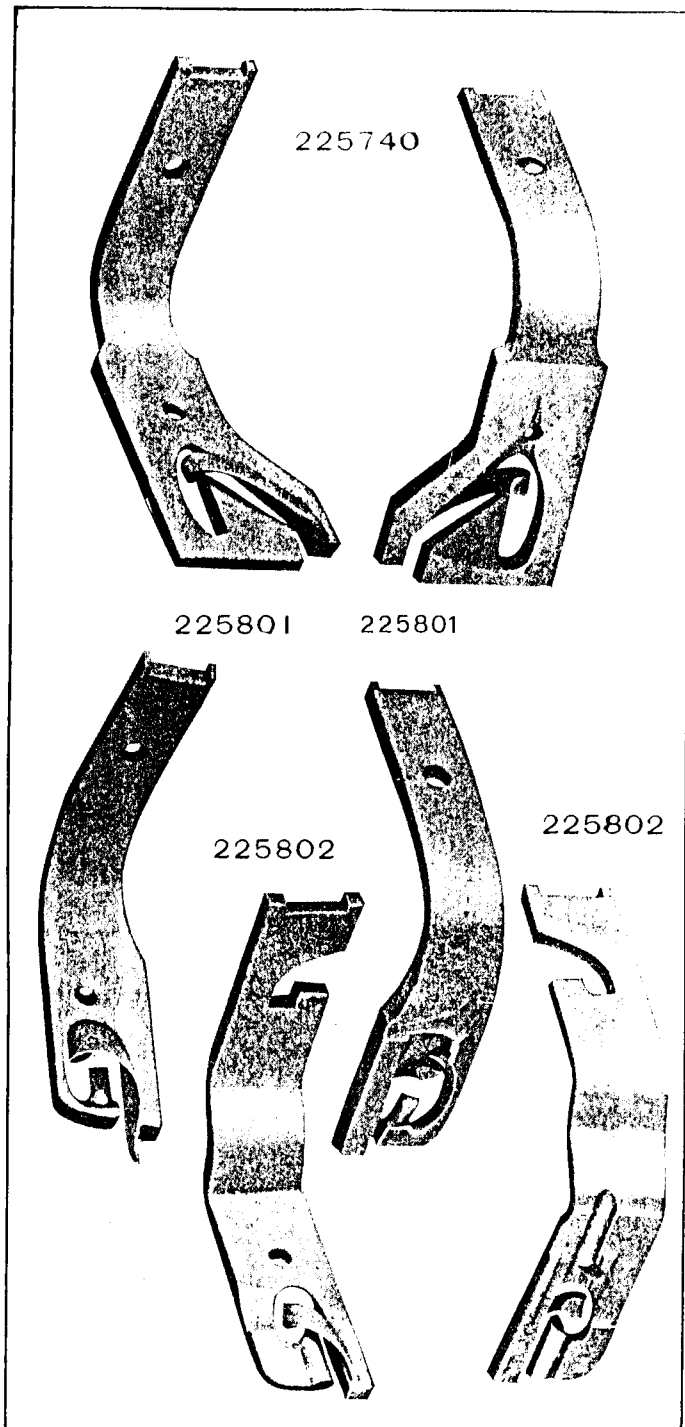


PLATE 10347—FULL SIZE

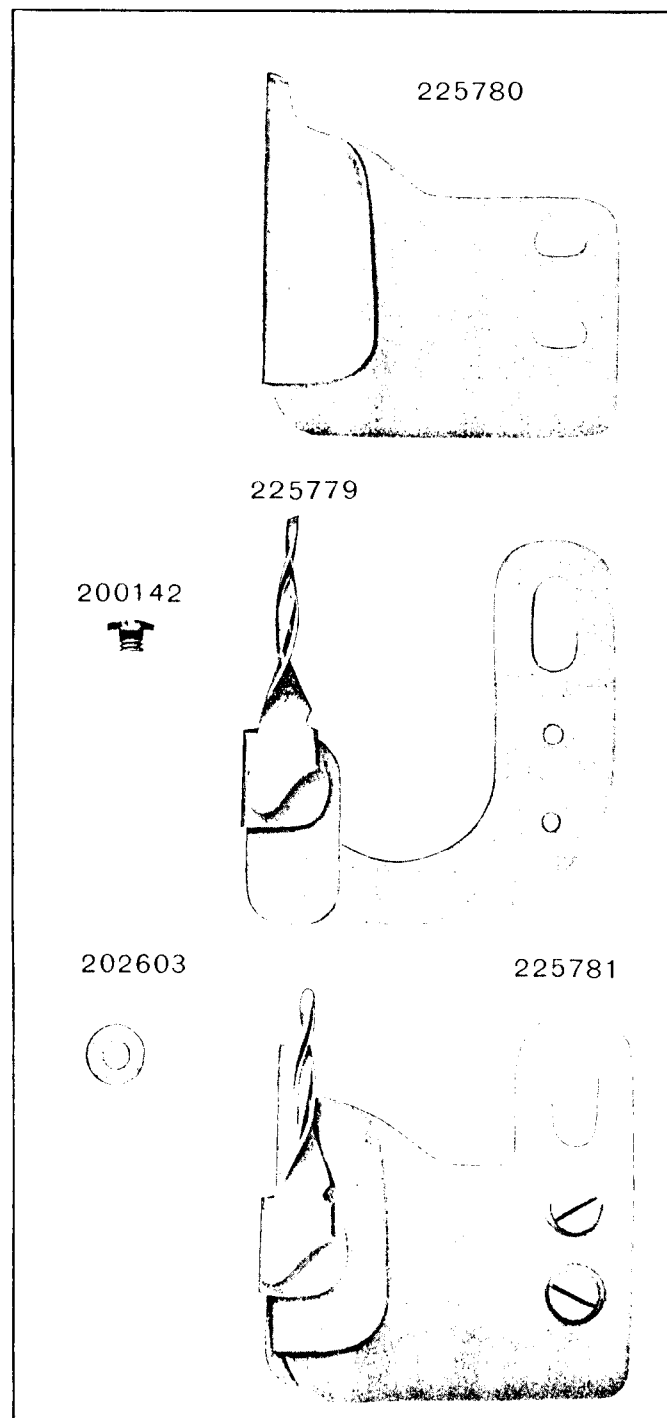


PLATE 10492—FULL SIZE

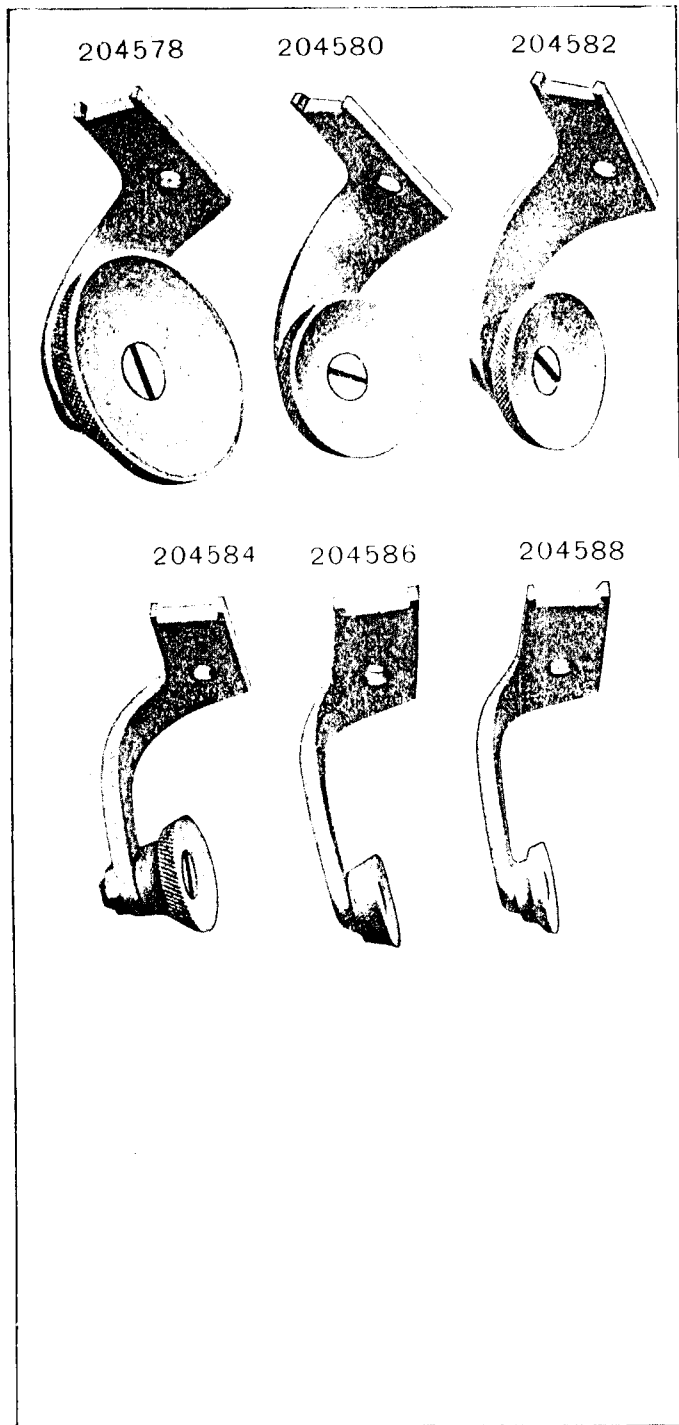


PLATE 10491—FULL SIZE

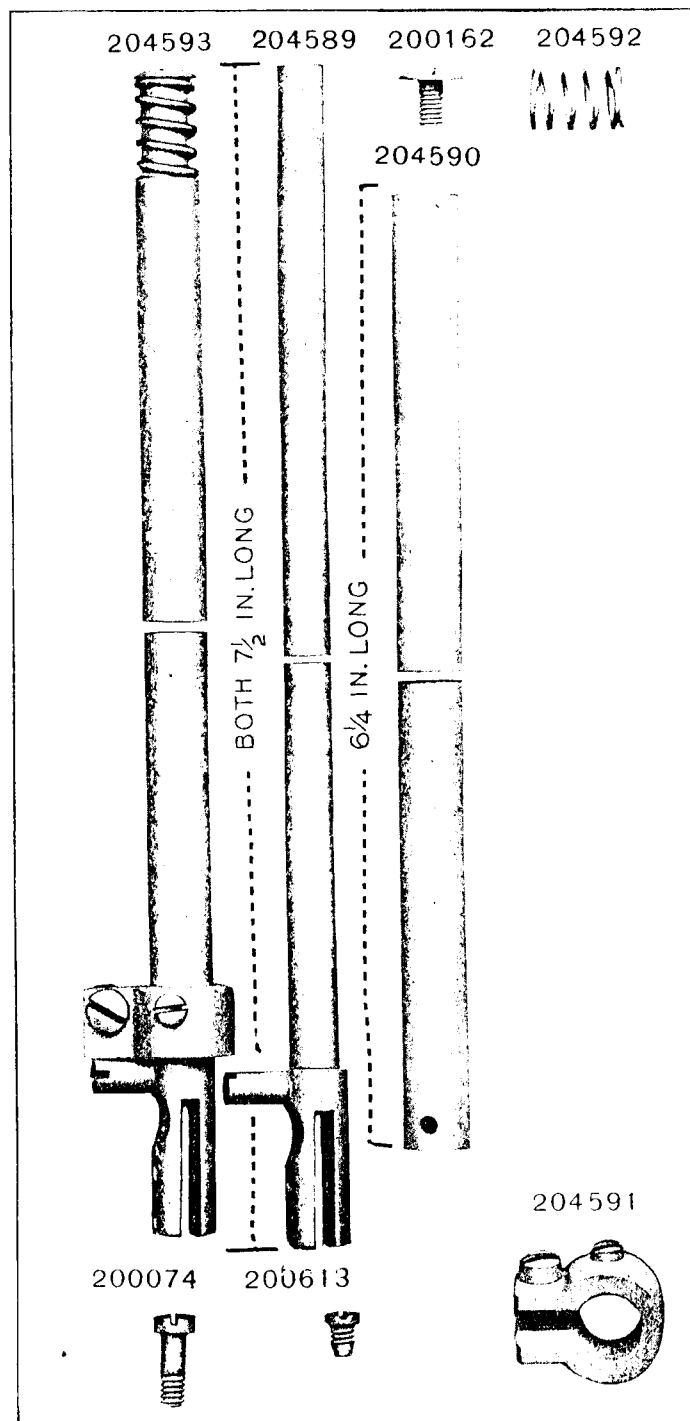


PLATE 10505—FULL SIZE

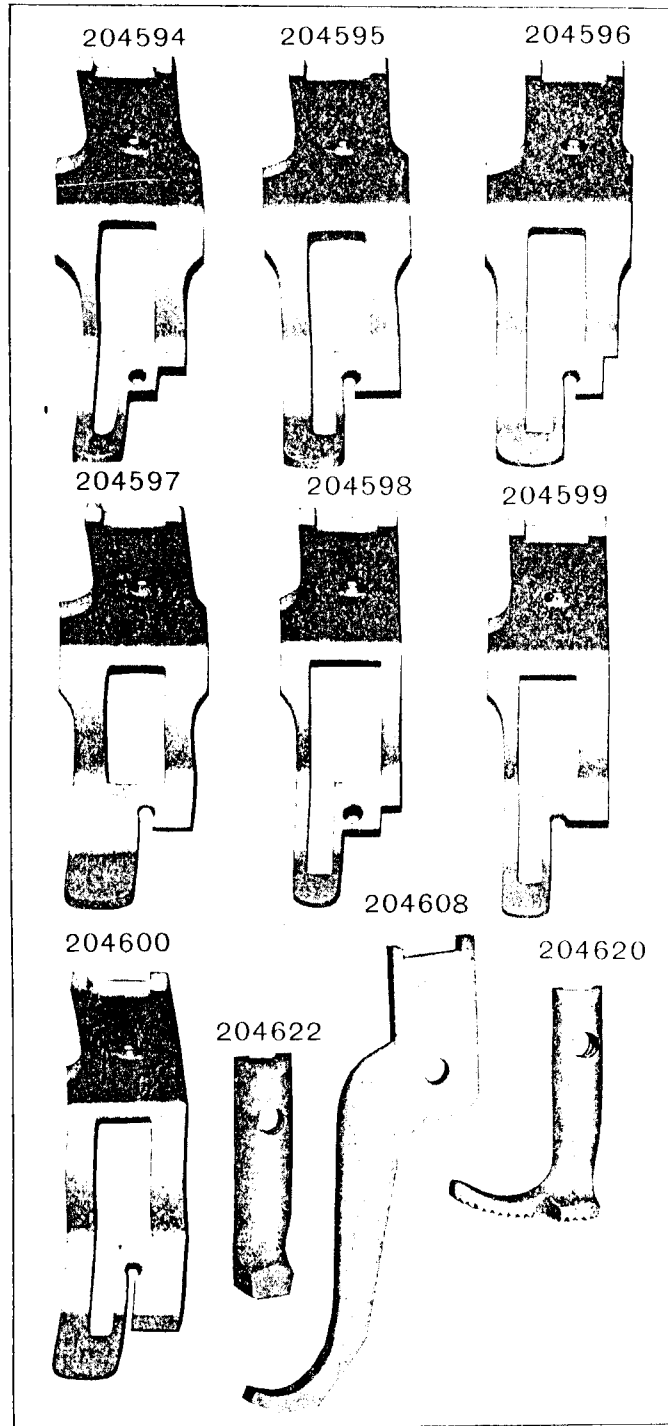


PLATE 10496—ONE-HALF SIZE

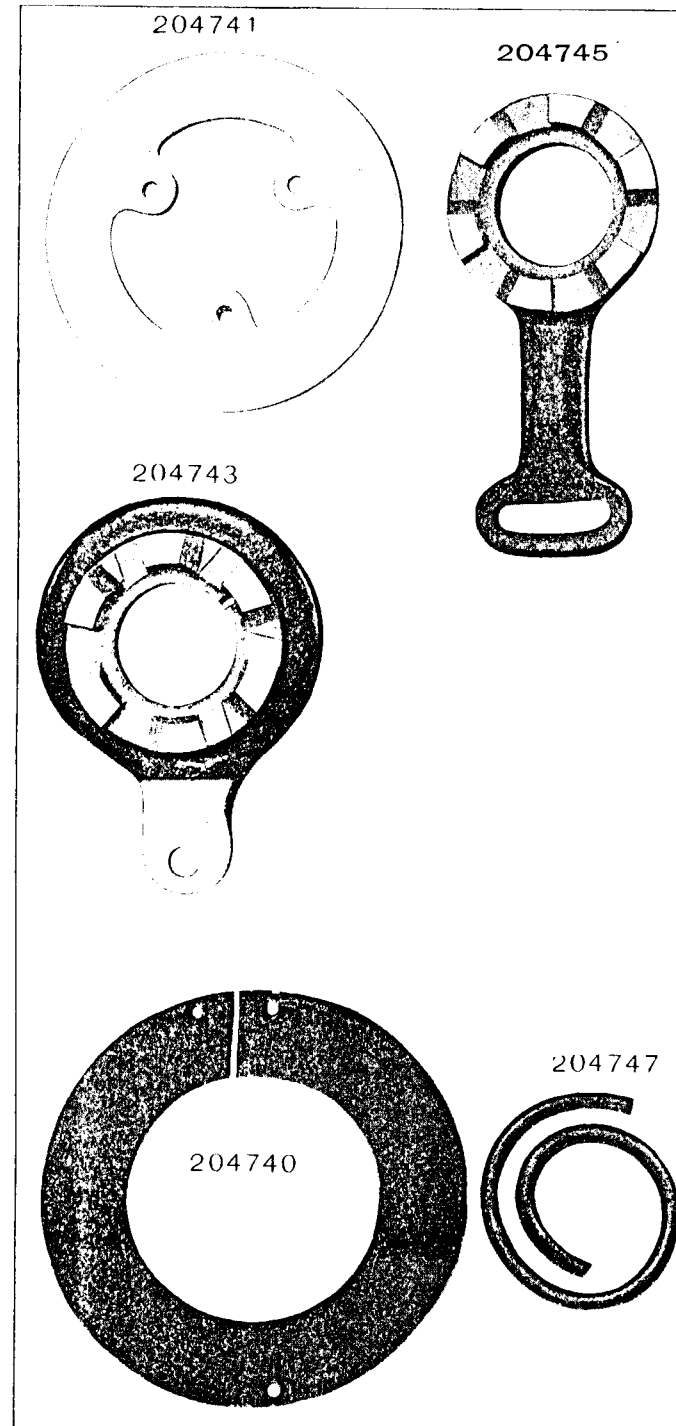




PLATE 10926 -FULL SIZE

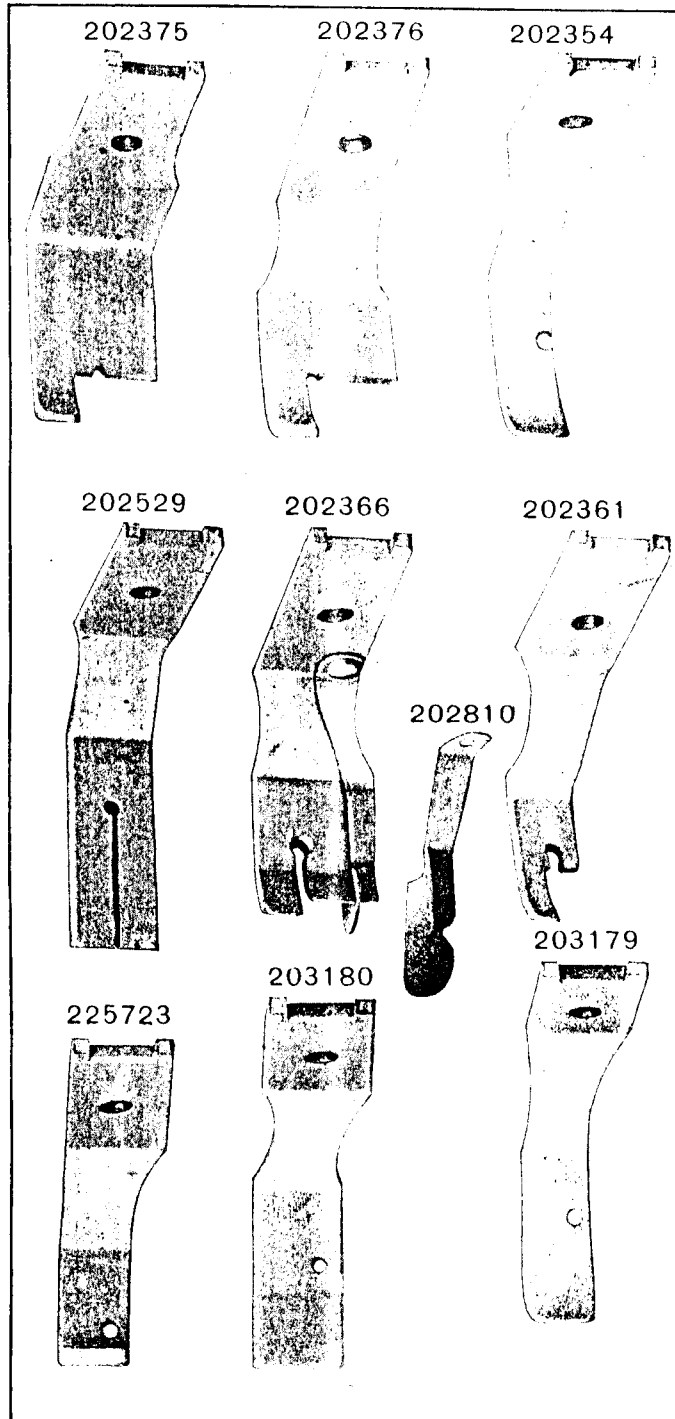


PLATE 10925 -FULL SIZE

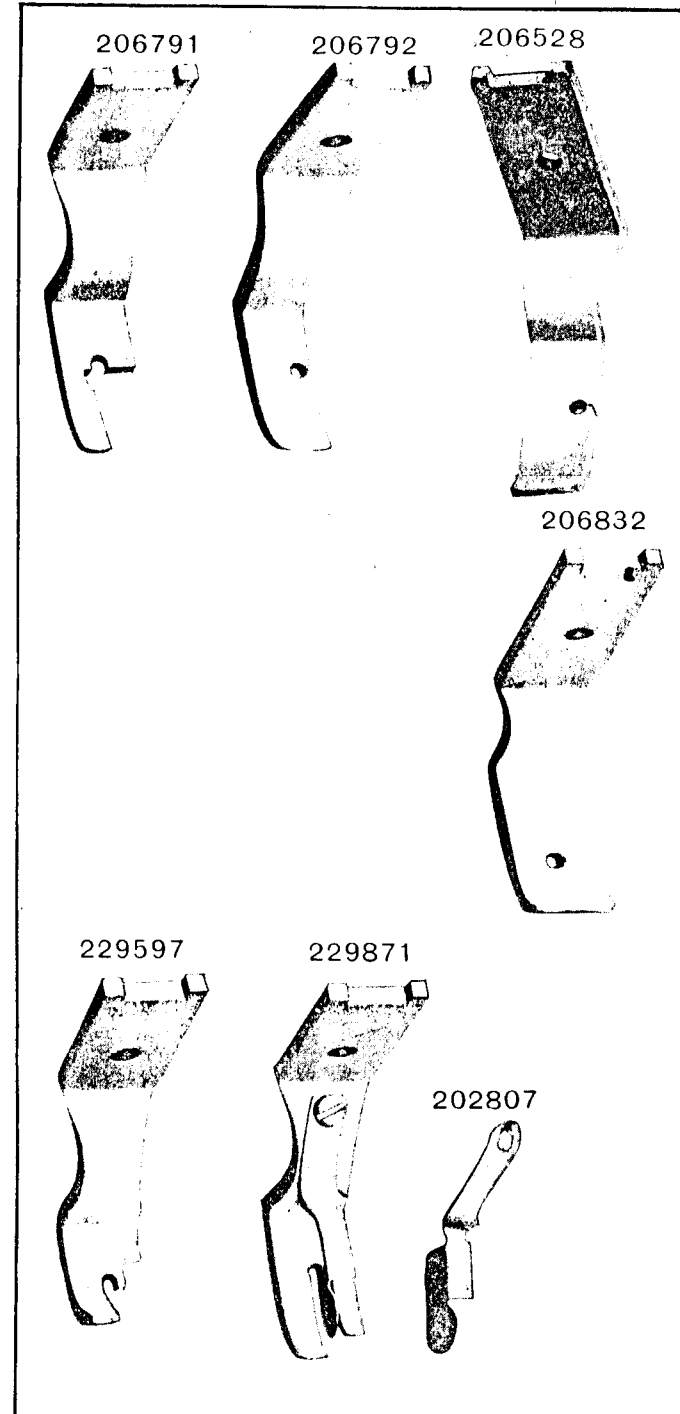


PLATE 10929 -FULL SIZE

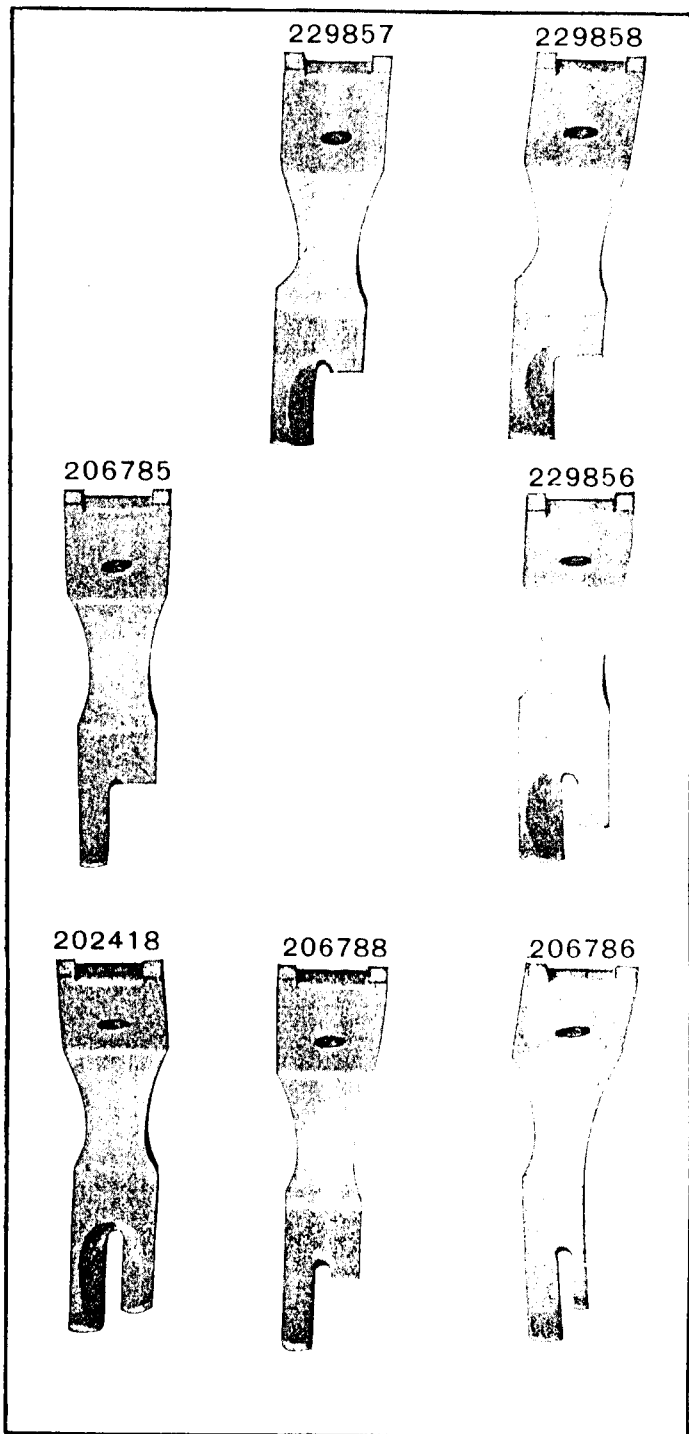


PLATE 10927 -FULL SIZE

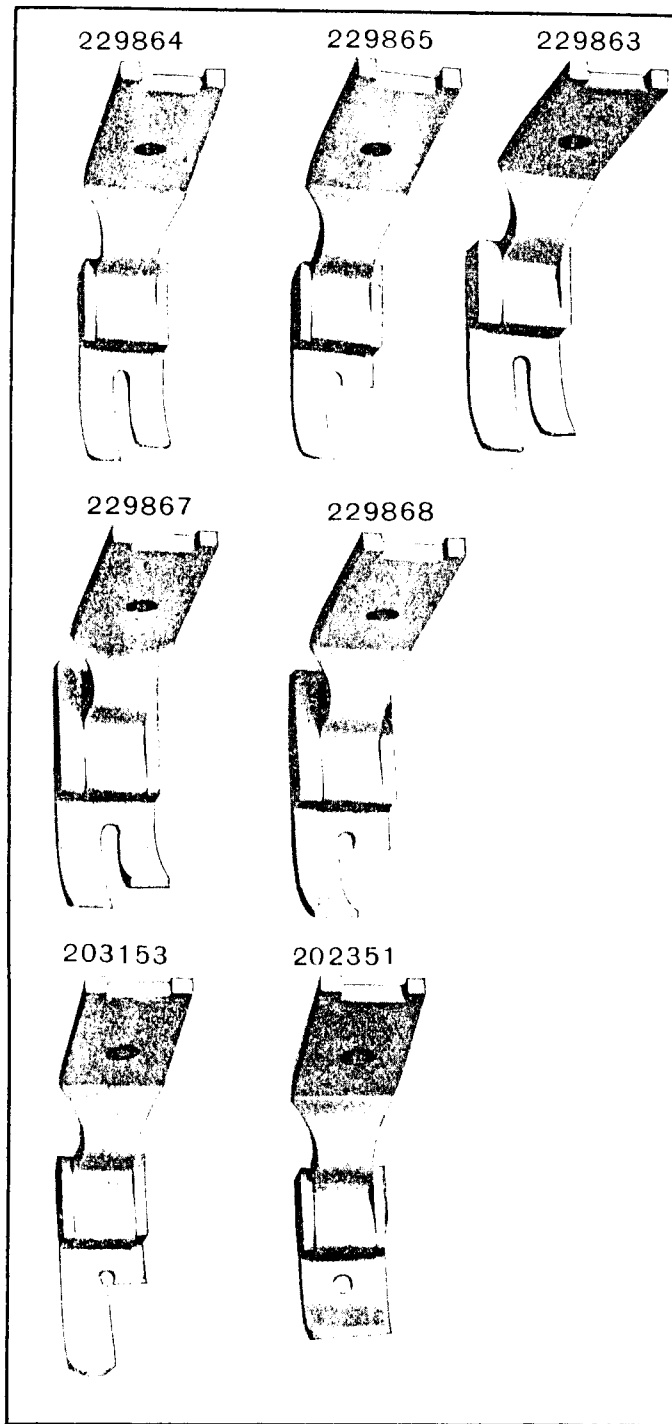
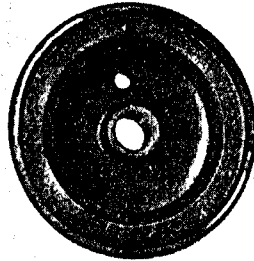
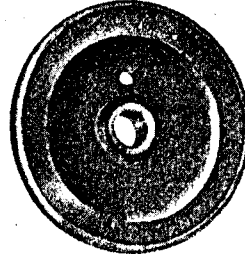


PLATE 11000—ONE-FOURTH SIZE

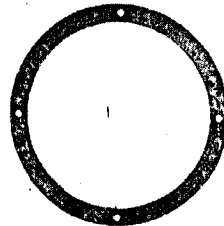
207833



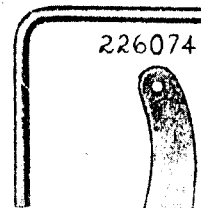
204737



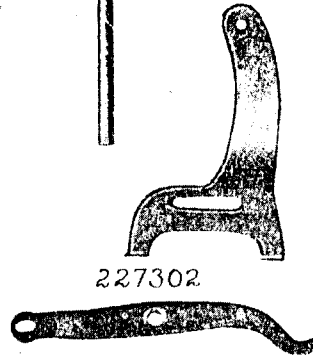
235396



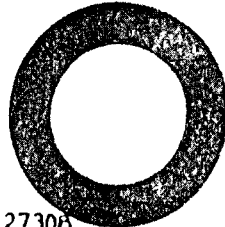
202455



226074



235328



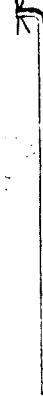
227302



227303



227308



208490



PLATE 10999—ONE-HALF SIZE

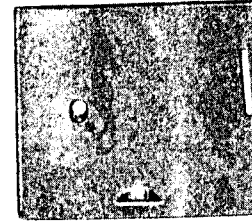
204495



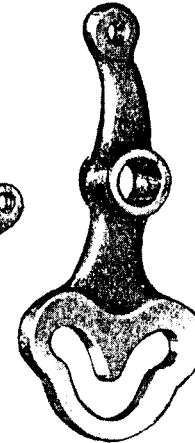
203218



226998



223001



223015

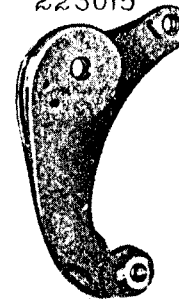


PLATE 11116—FULL SIZE

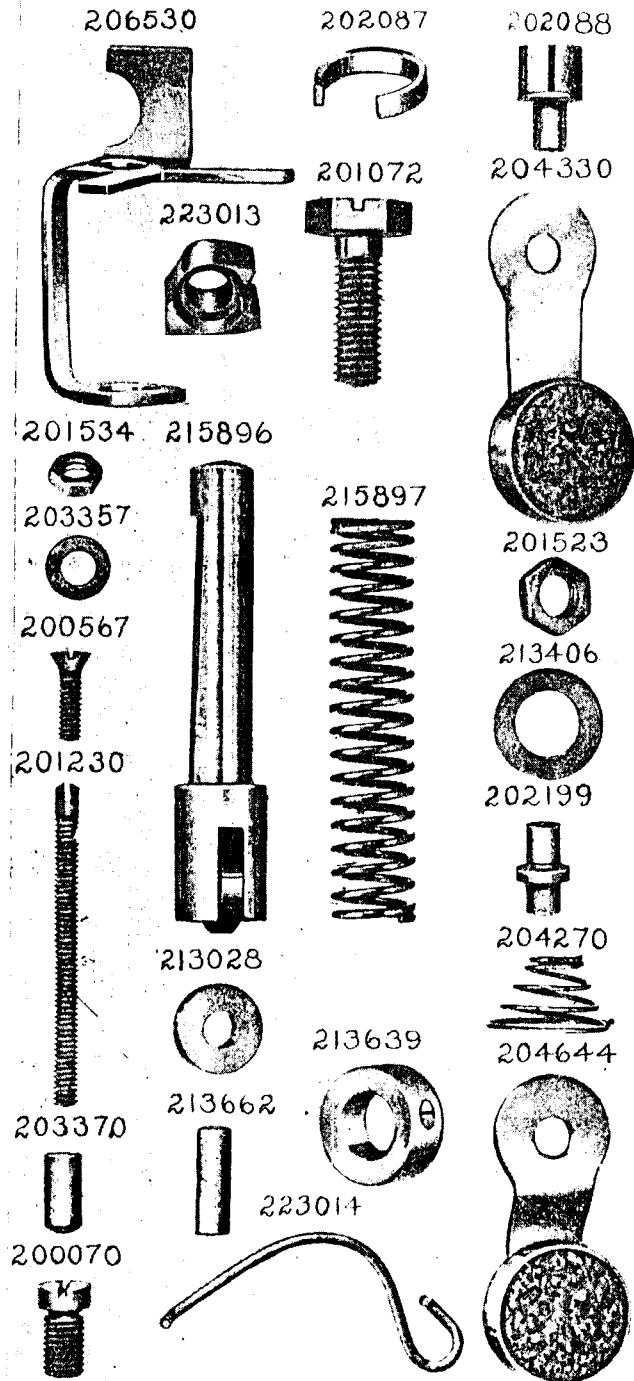


PLATE 11004—FULL SIZE

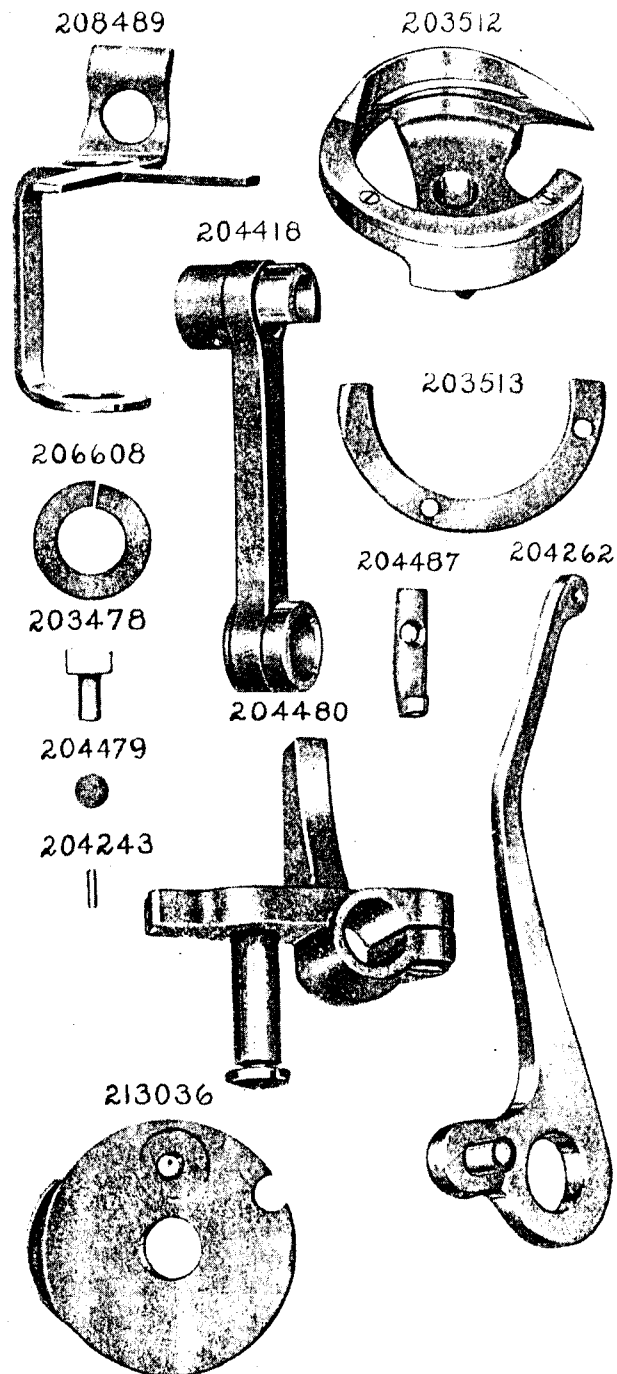
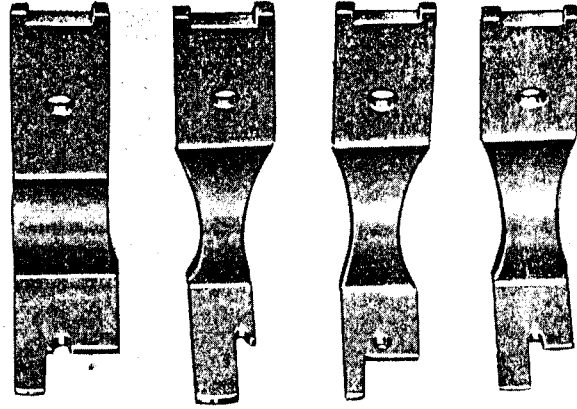


PLATE 11123—FULL SIZE

206779 206781 206841 207180



229852 229853 229860

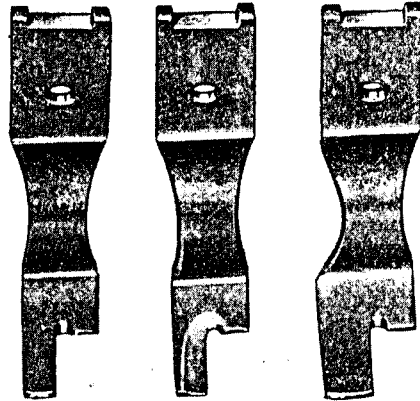
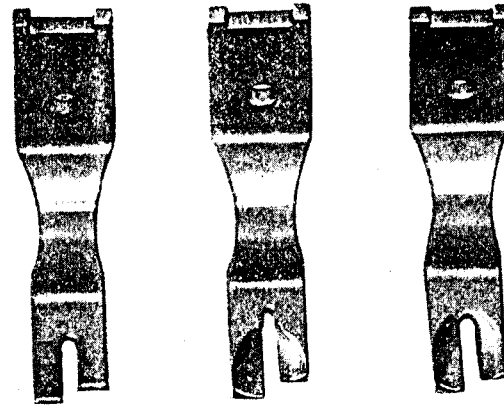
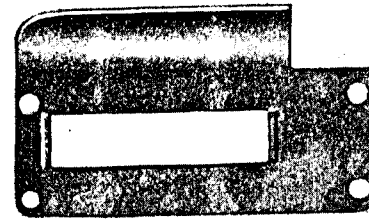


PLATE 11122—FULL SIZE

207182 207188 229854



231237



231238

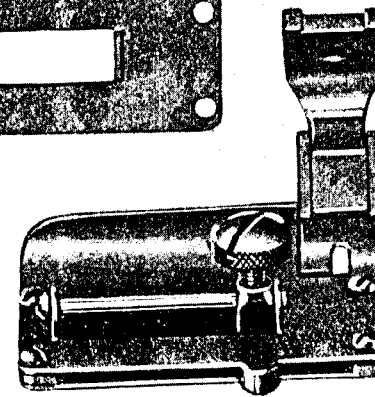


PLATE 11134-FULL SIZE

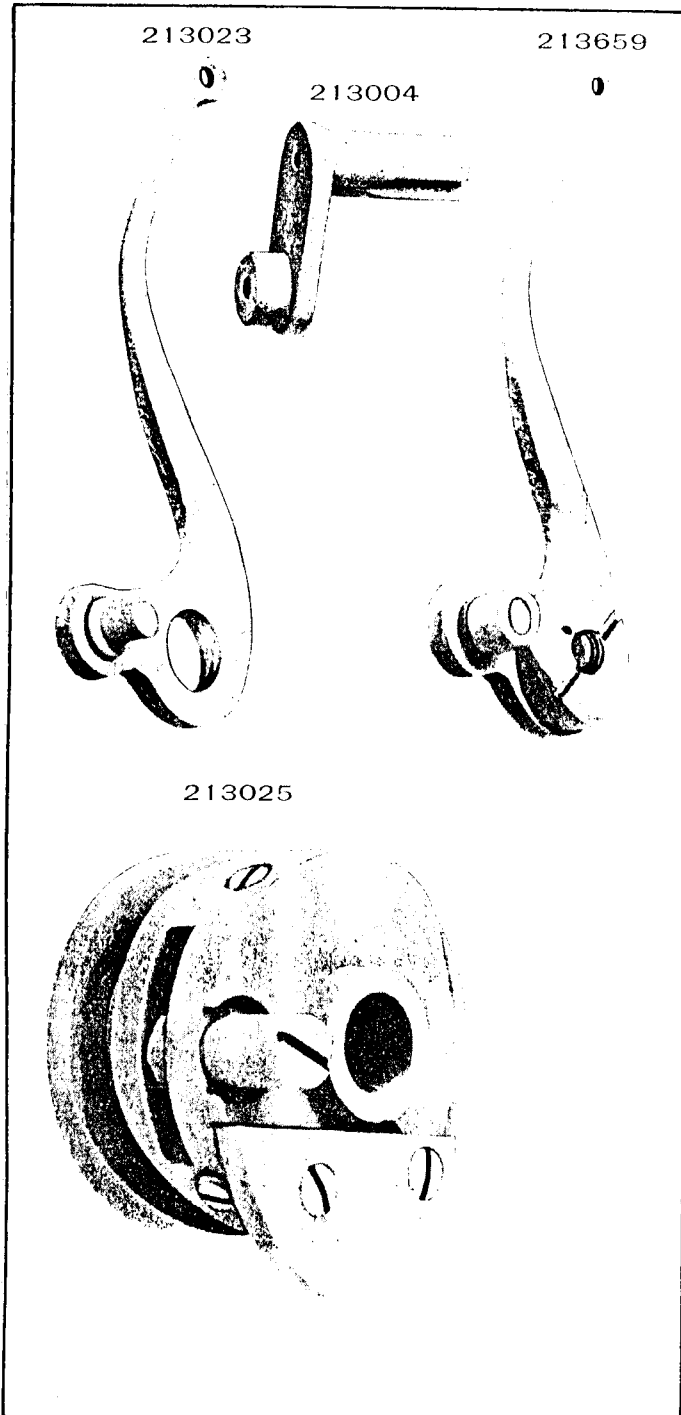


PLATE 11124-FULL SIZE

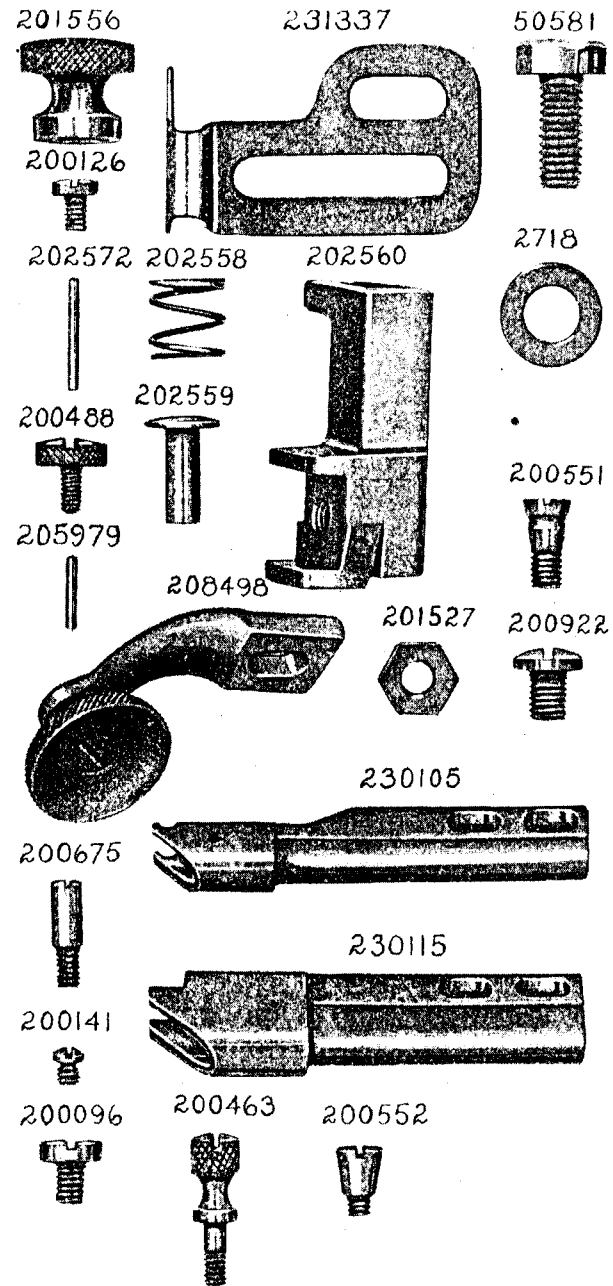


PLATE 11143-FULL SIZE

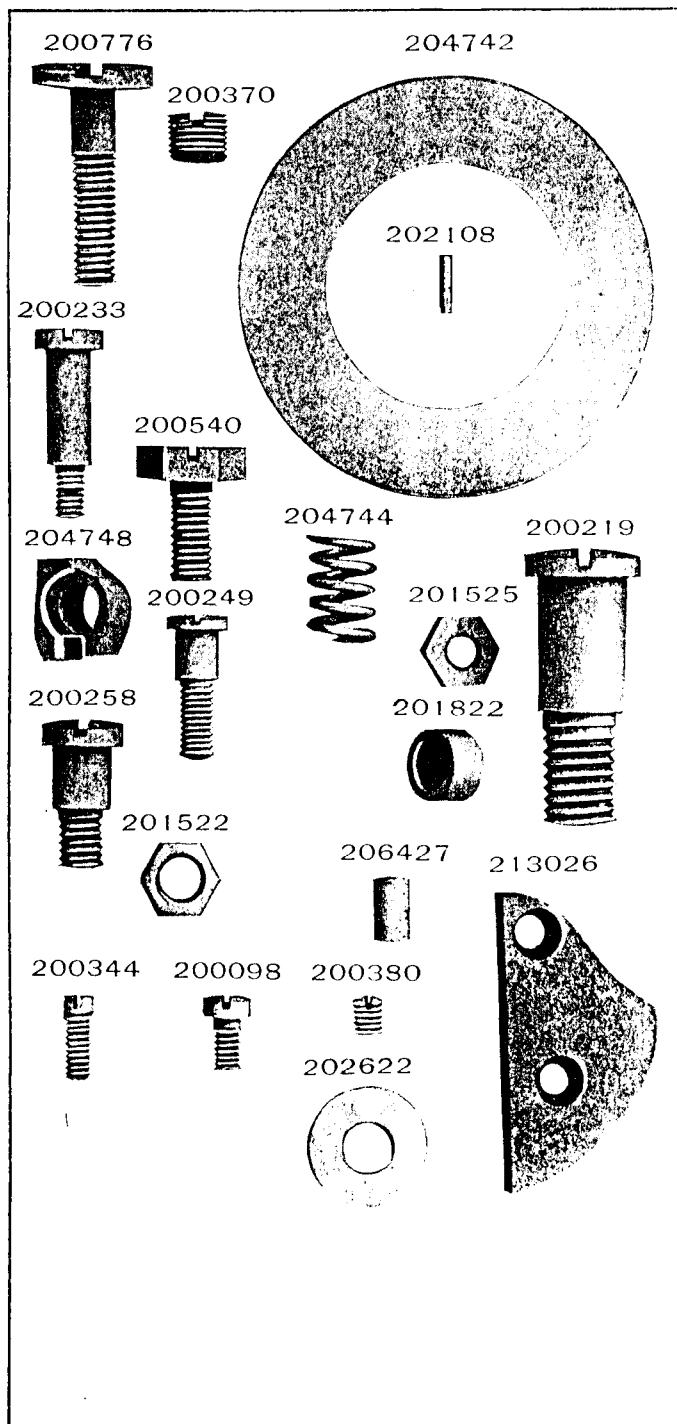


PLATE 11136-FULL SIZE

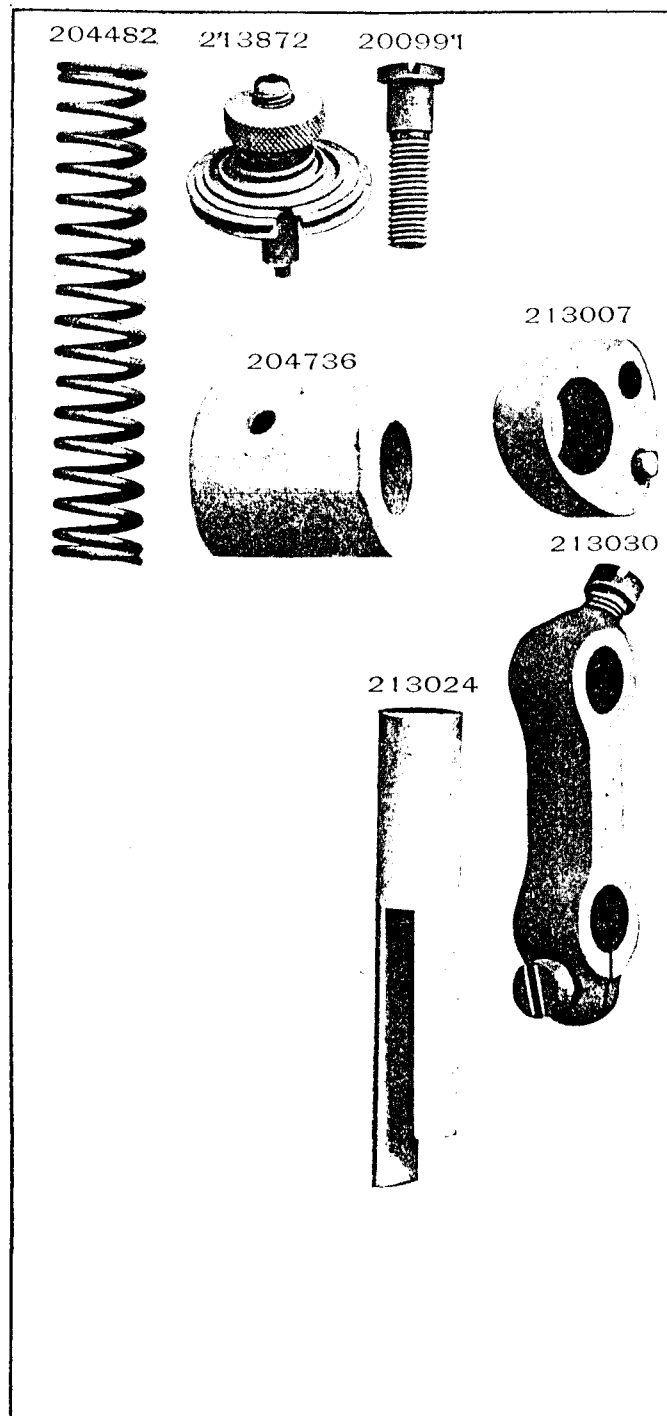


PLATE 11241—FULL SIZE

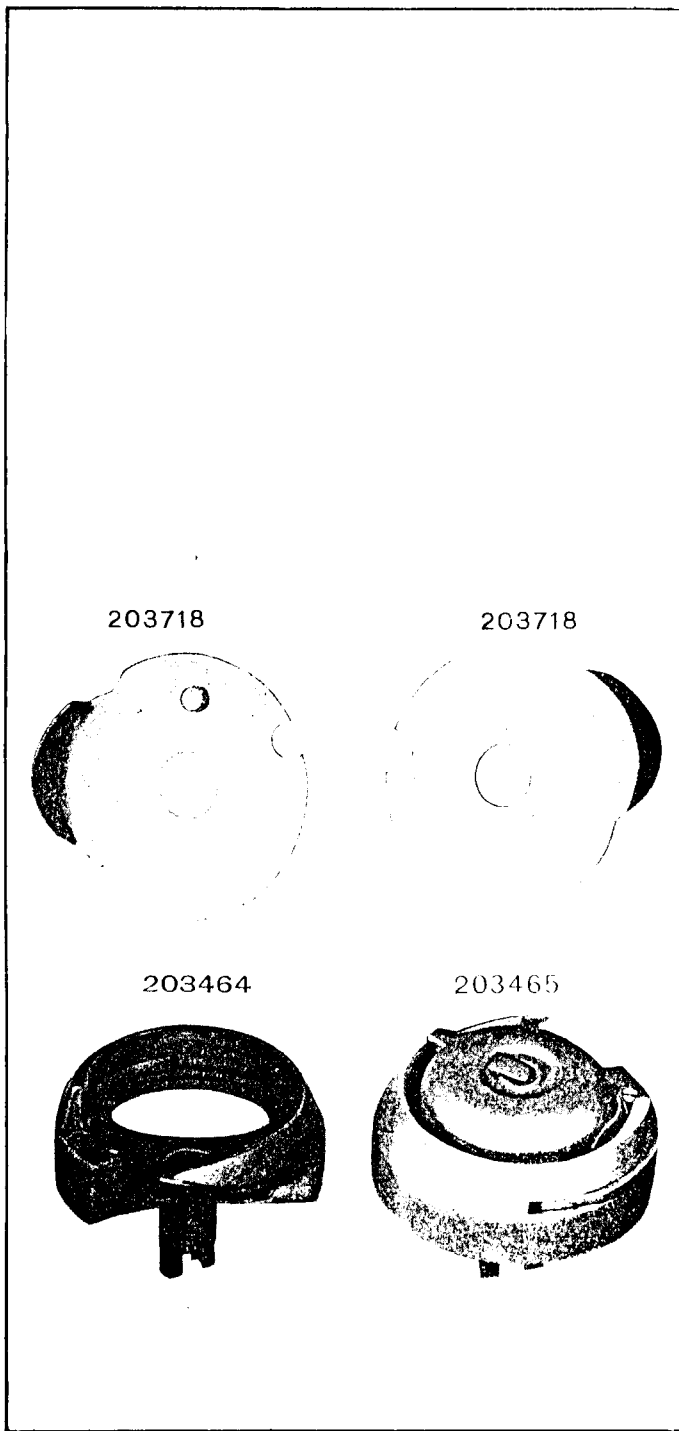


PLATE 11145 —ONE-HALF SIZE

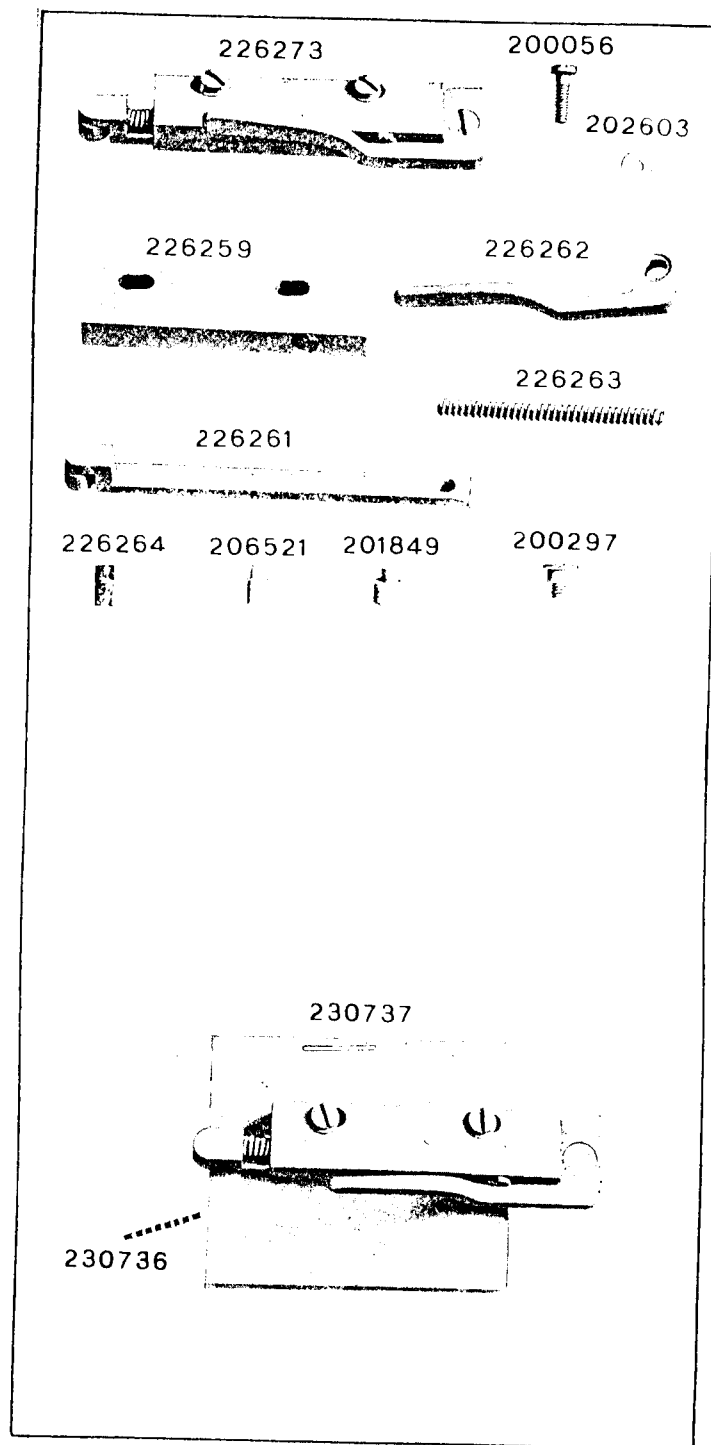




PLATE 12001—FULL SIZE

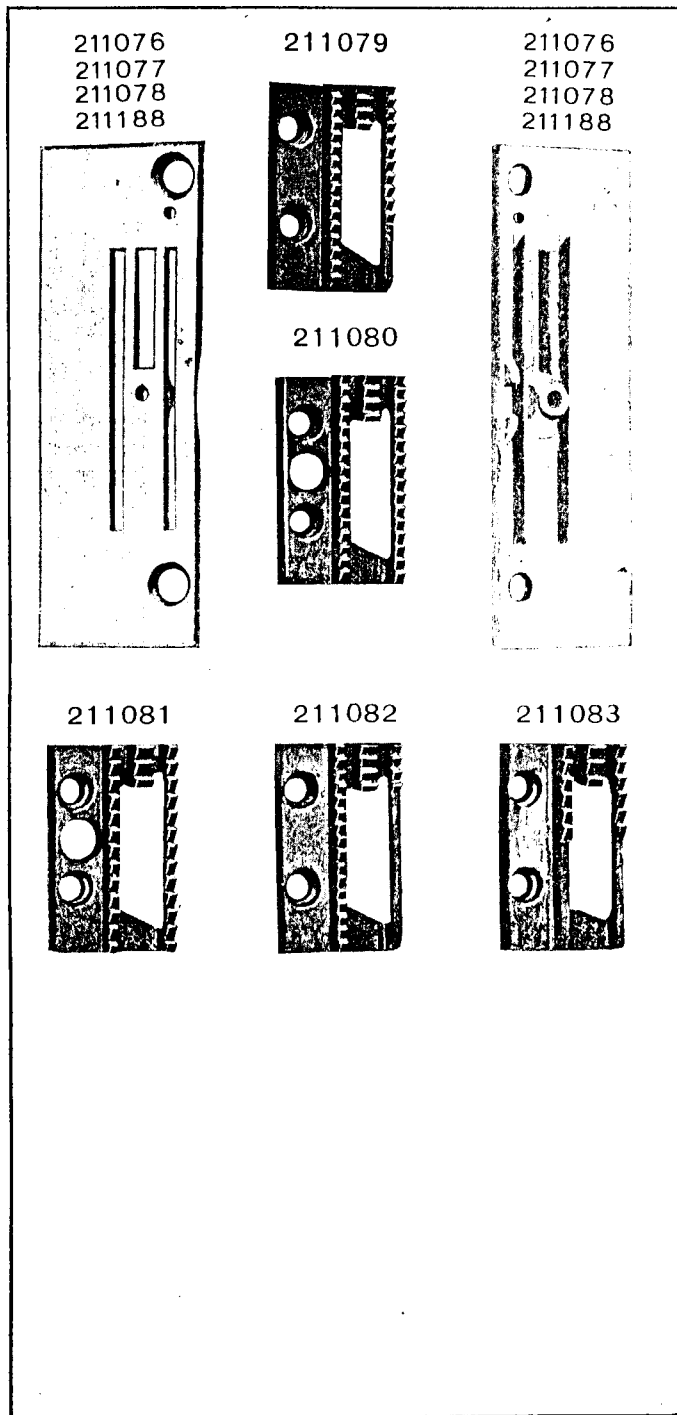


PLATE 11993—ONE-FOURTH SIZE

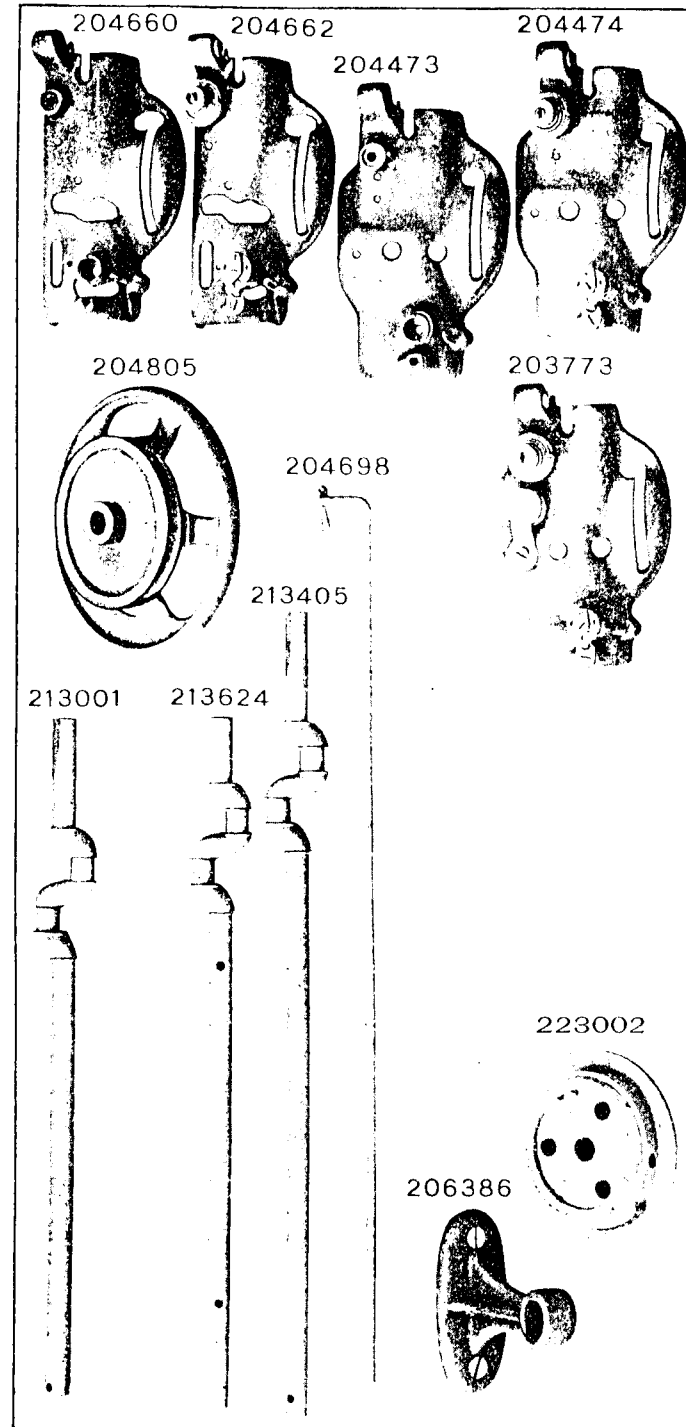


PLATE 12003—FULL SIZE

211092

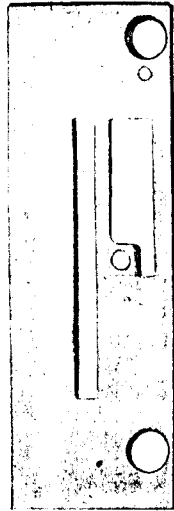
211095

211096

211093

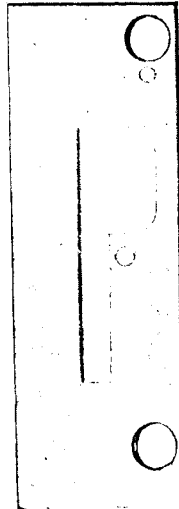


211094



211097

211098



207606



211099

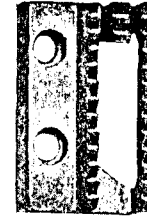


PLATE 12002—FULL SIZE

211084

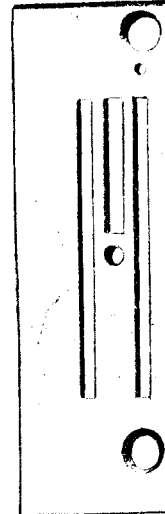
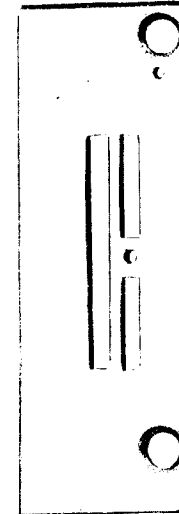
211087

211085



211086

211088



211089



211090

211091

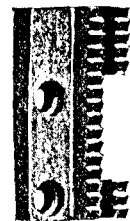
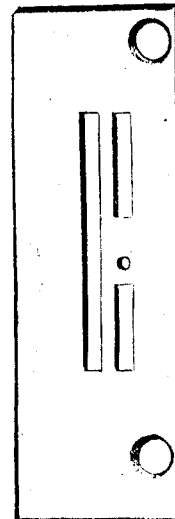


PLATE 12005—FULL SIZE

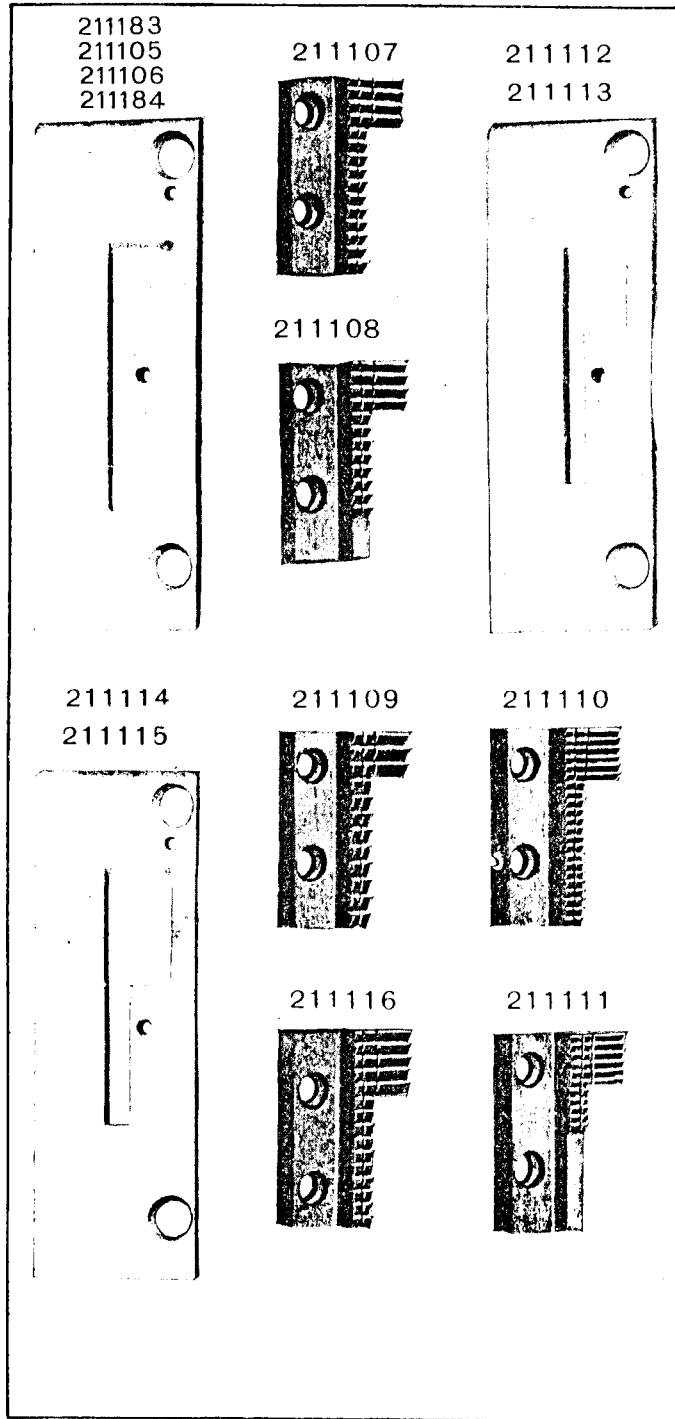


PLATE 12004—FULL SIZE

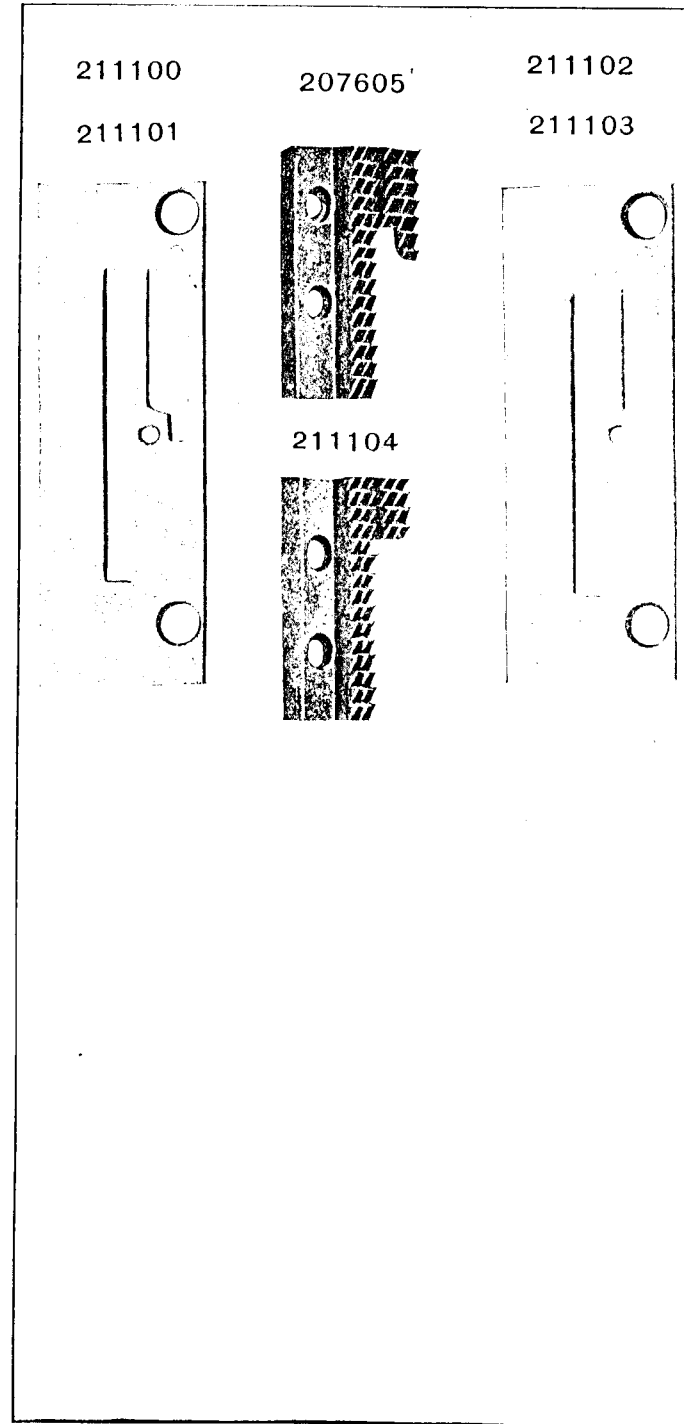
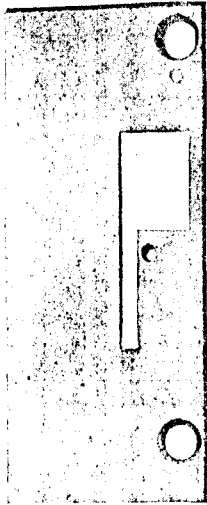


PLATE 12007—FULL SIZE

211123



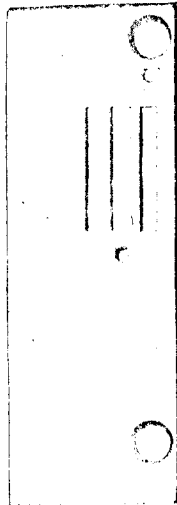
211124



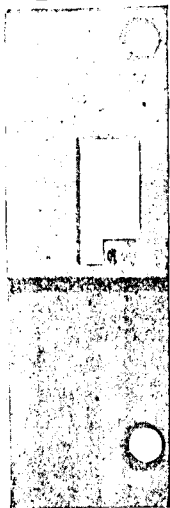
211126



211125



211127  
212270



211128



211131



211129  
211130

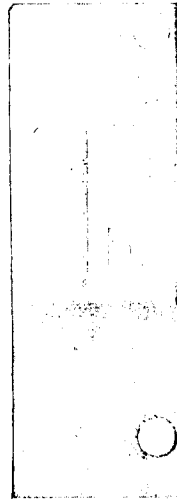
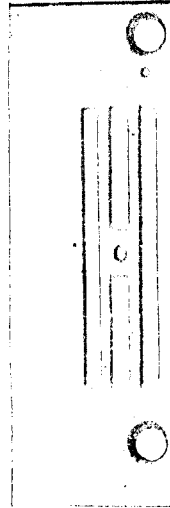


PLATE 12006—FULL SIZE

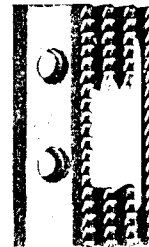
211075  
211117



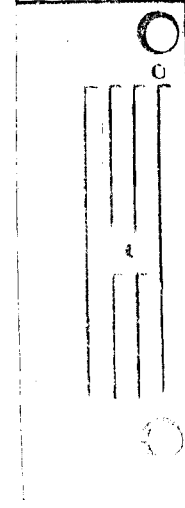
211118



211120



211119



211122

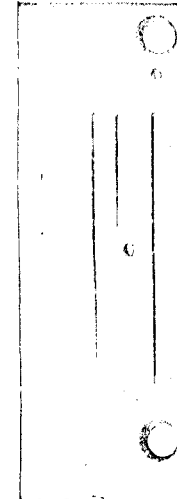
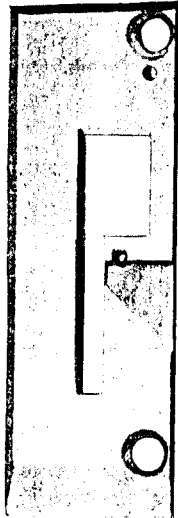
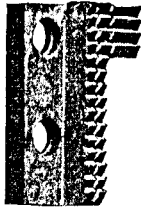


PLATE 12010—FULL SIZE

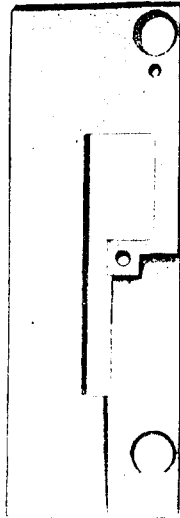
211148  
211149



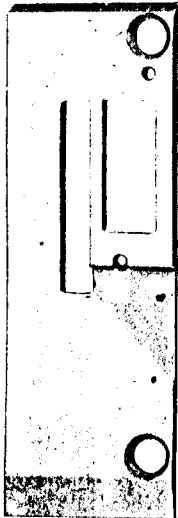
211150



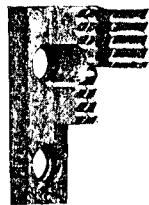
211151  
211152



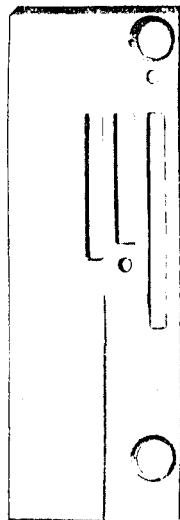
211153



211154



211155



211156

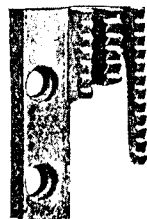


PLATE 12009—FULL SIZE

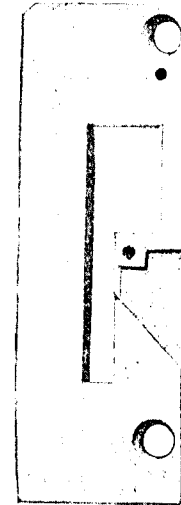
211136  
211137



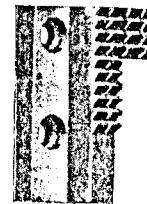
211138



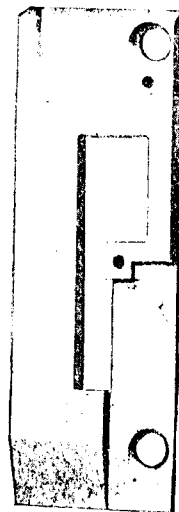
211142  
211143



211139



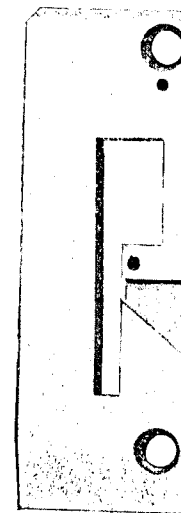
211144  
211145



211140



211146  
211147



211141

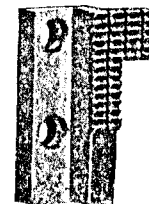
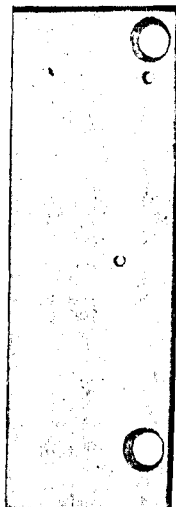
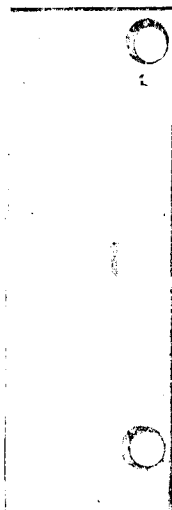


PLATE 12012—FULL SIZE

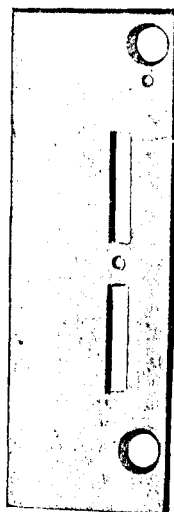
211162  
211163  
211164  
211165



211166



211167

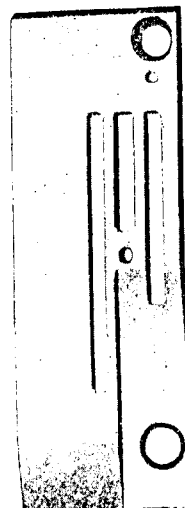


211168



PLATE 12011—FULL SIZE

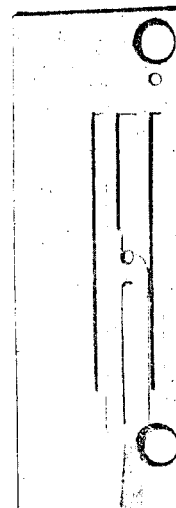
211157



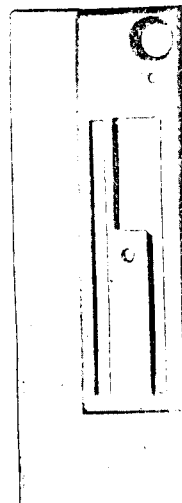
211158



211159



211160

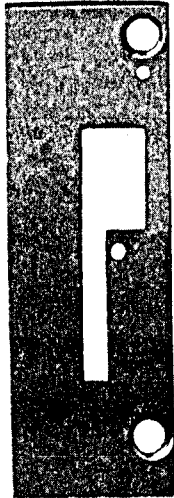


211161

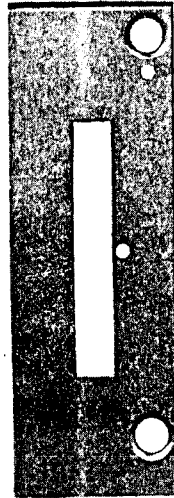


PLATE 12016—FULL SIZE

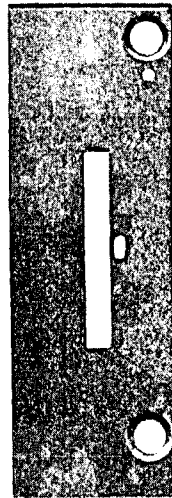
211189  
211198



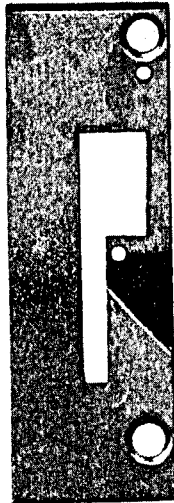
211265  
211266  
211267



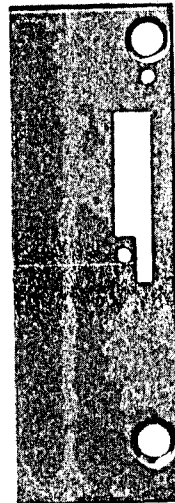
211324  
211339  
215900



203801



211134



211268



211135



PLATE 12015—FULL SIZE

225648



225706



225586



200246



200862



200857



225708



200160



204004



200093



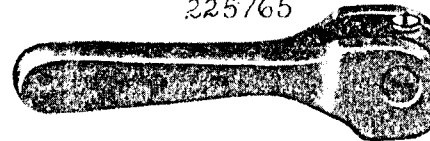
200469



223006



225765



223007



PLATE 12018—FULL SIZE

211201

211201

211204

211202

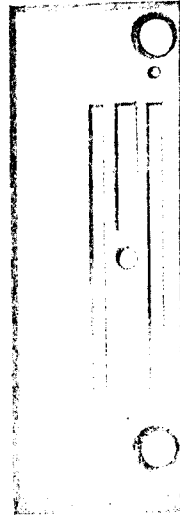
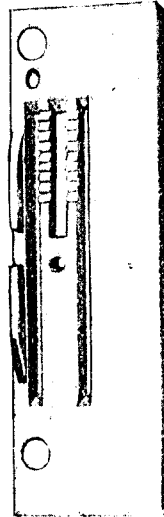
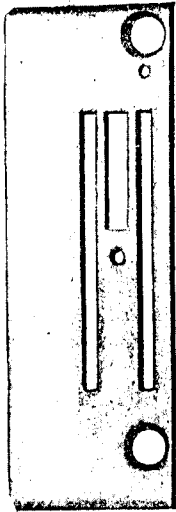
211202

211205

211203

211203

211206



211208

211209

211211

211207

211210

211212

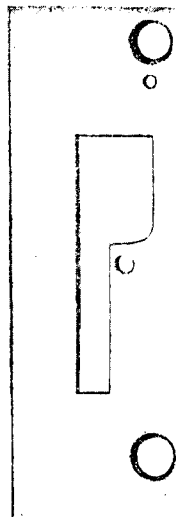
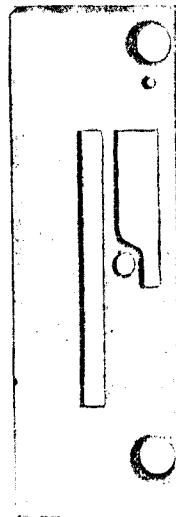
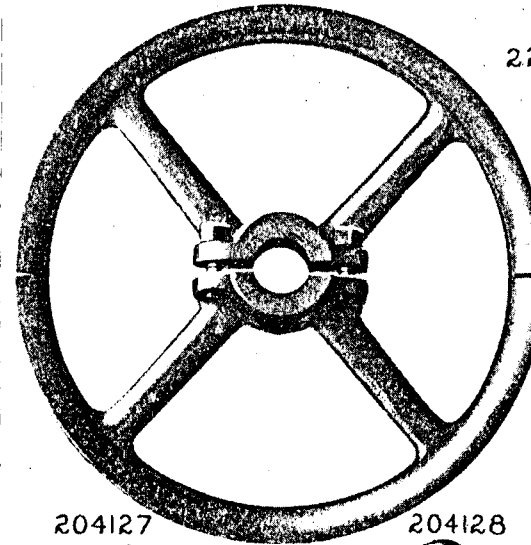


PLATE 12017—ONE-FOURTH SIZE

27070

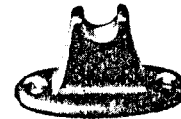
227933



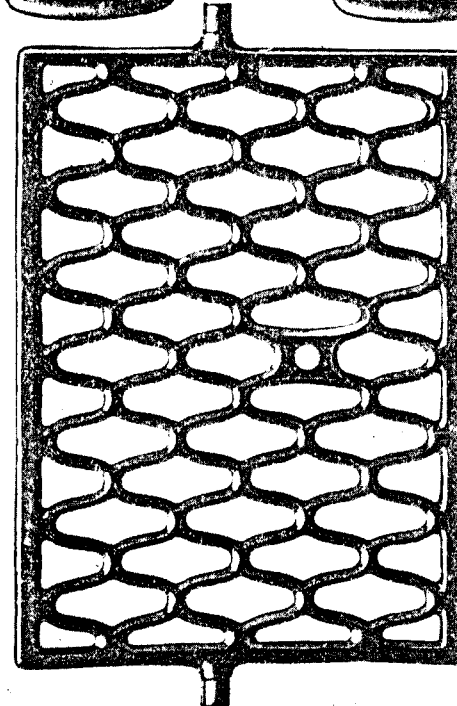
227956

204127

204128



126036



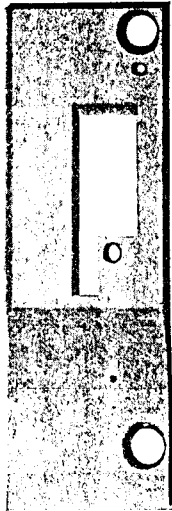
126038



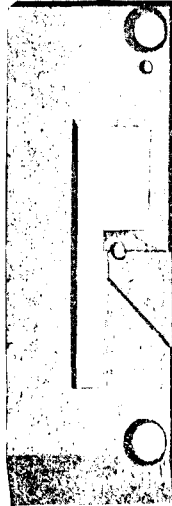


PLATE 12020—FULL SIZE

211223  
211224



211225  
211226



211227  
211228

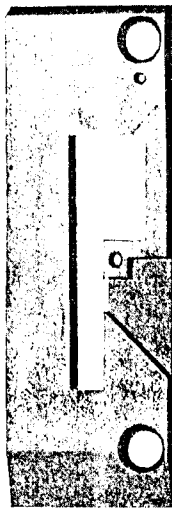
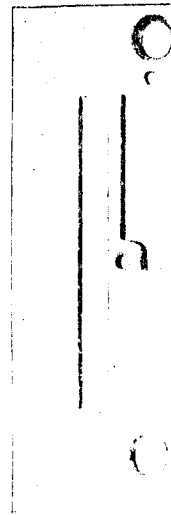


PLATE 12019—FULL SIZE

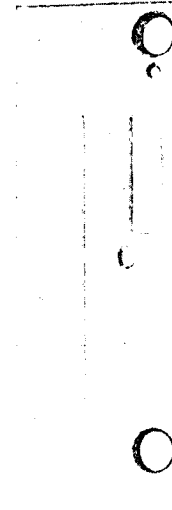
211213  
211214



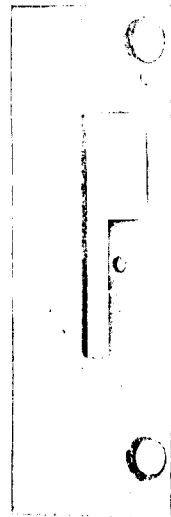
211215  
211216



211217  
211218



211219  
211220



211221  
212269



211222  
212268

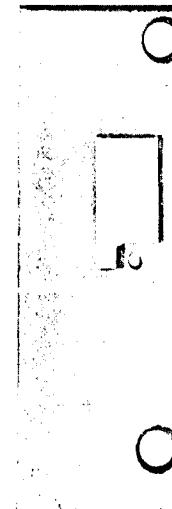
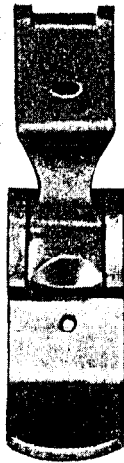


PLATE 12035—FULL SIZE

207100



225621



225690



229598



229595



206842



PLATE 12026—FULL SIZE

211251

211252

211253

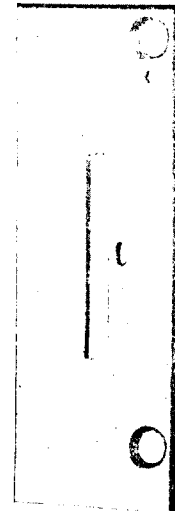
211254



211257

211258

211259

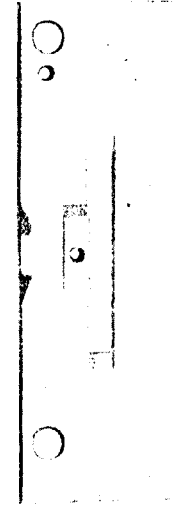


211251

211252

211253

211254

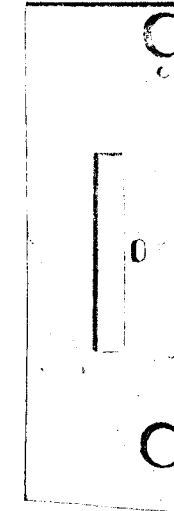


211283

211260

211261

211262



211255



211256



211263



211264



PLATE 12037—FULL SIZE

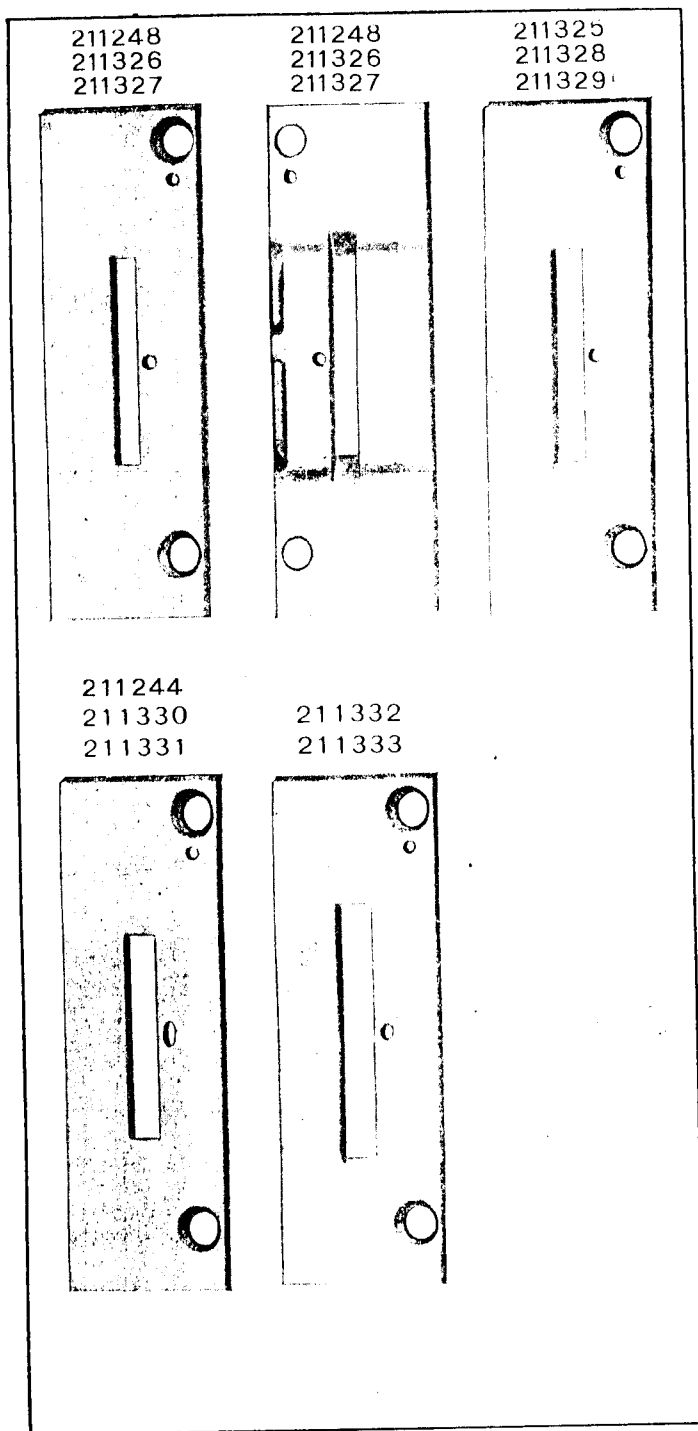


PLATE 12031—ONE-HALF SIZE

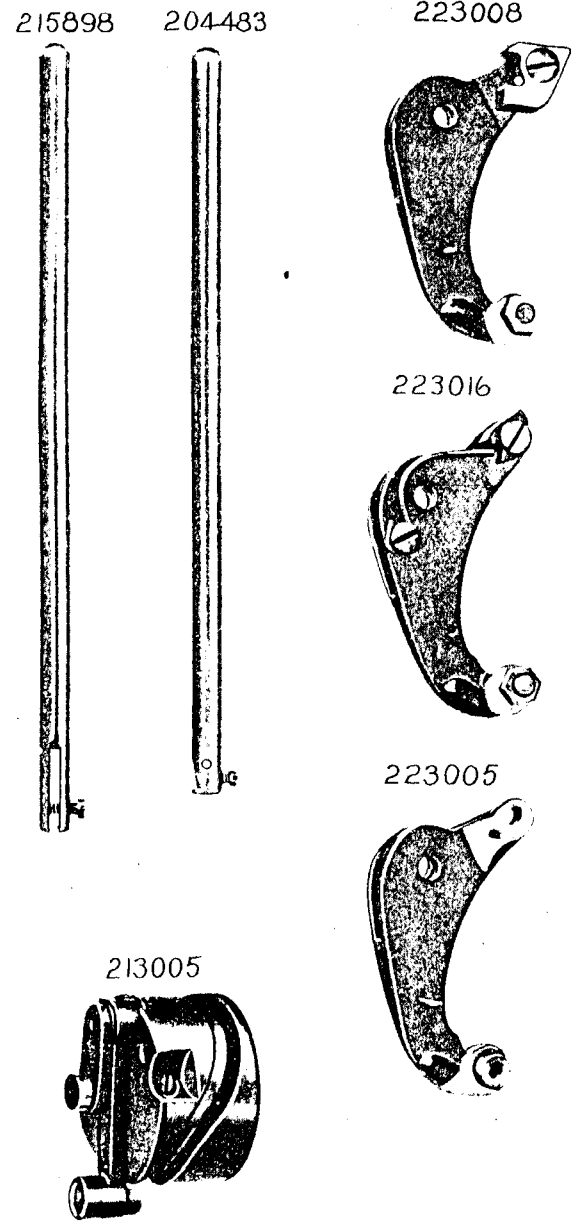
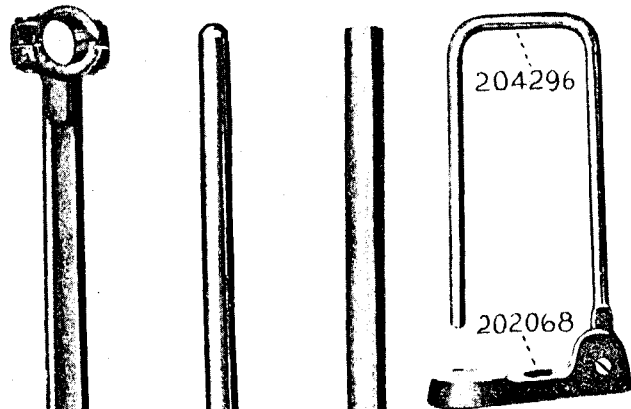


PLATE 12041—ONE-HALF SIZE

204440 204483 203243 204297



213008



204193



203207

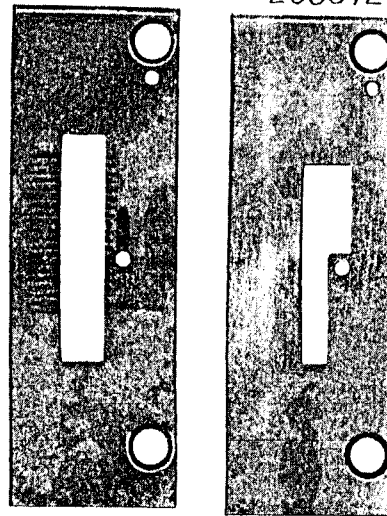


203329

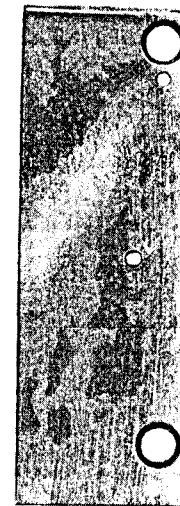


PLATE 12036—FULL SIZE

203361 203372 211923



211924  
211925  
211926



207635



207630



PLATE 12153—ONE HALF SIZE

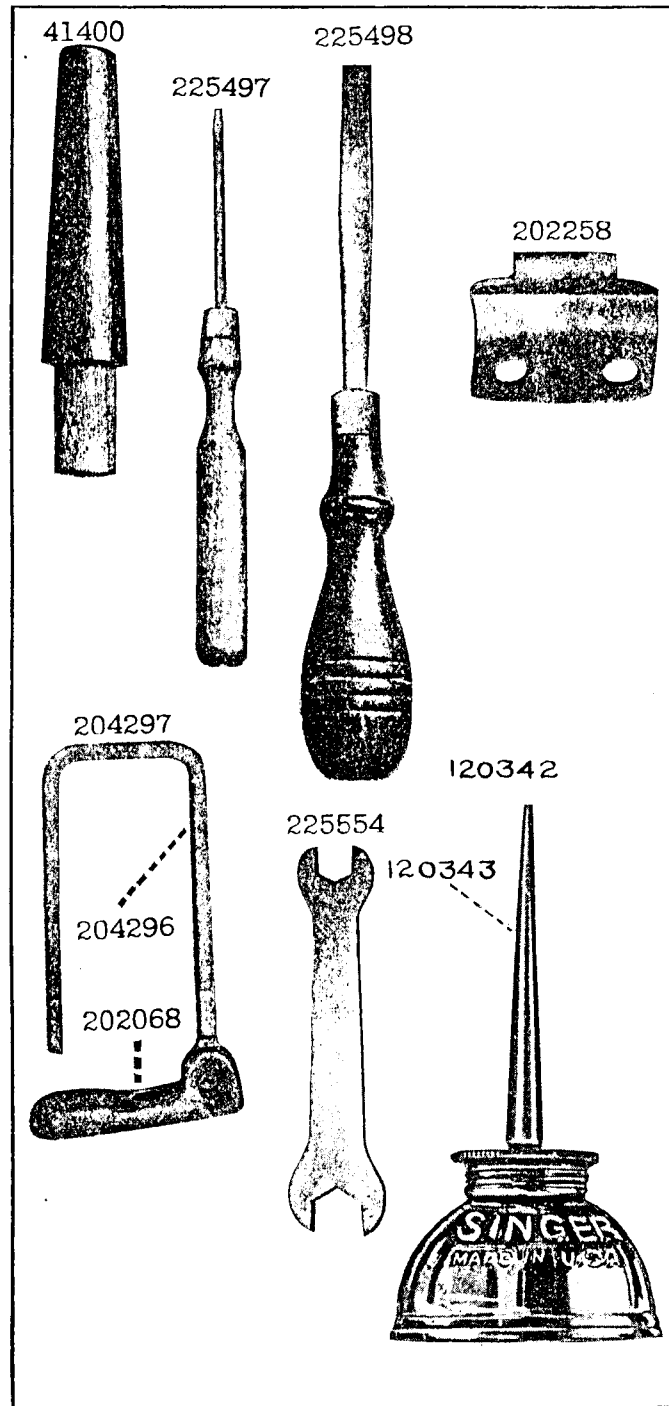


PLATE 12039—FULL SIZE

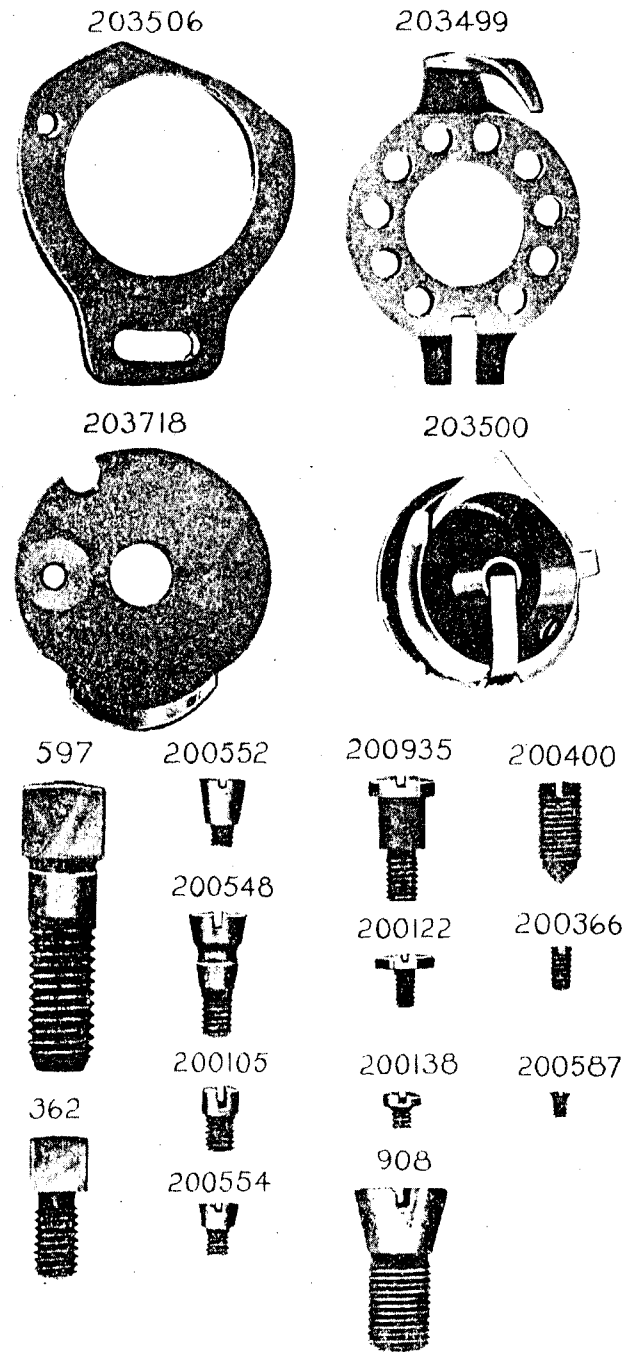


PLATE 12298—ONE-FOURTH SIZE

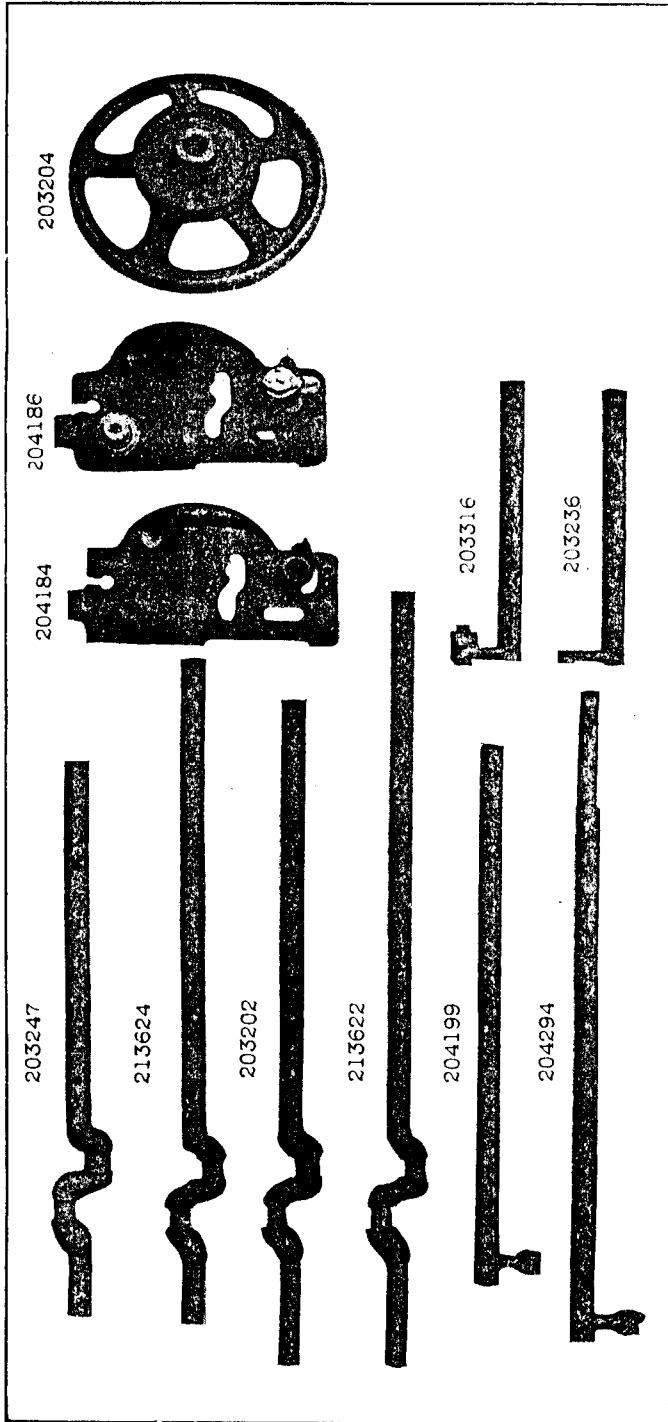


PLATE 12042—ONE-FOURTH SIZE

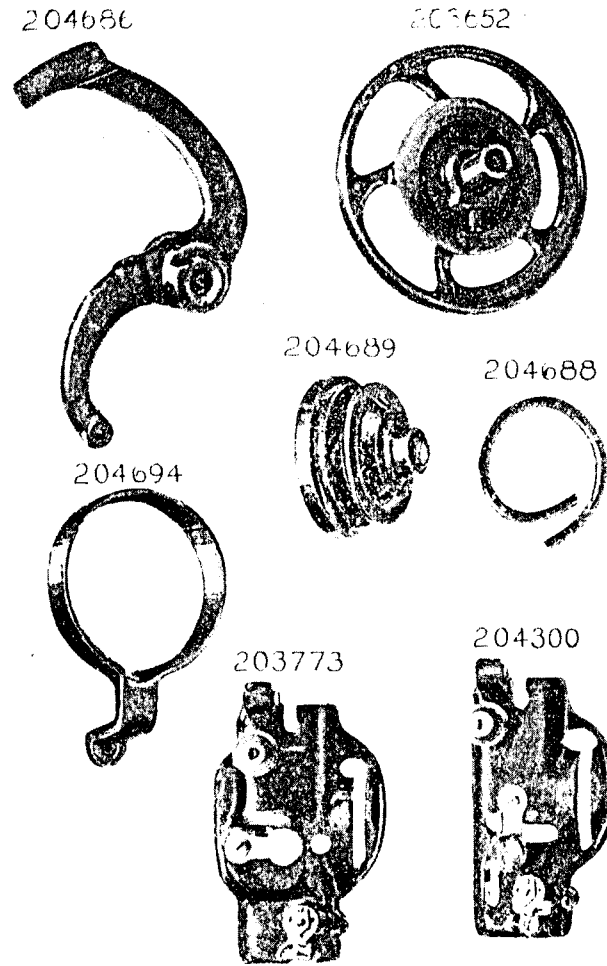


PLATE 12305-FULL SIZE

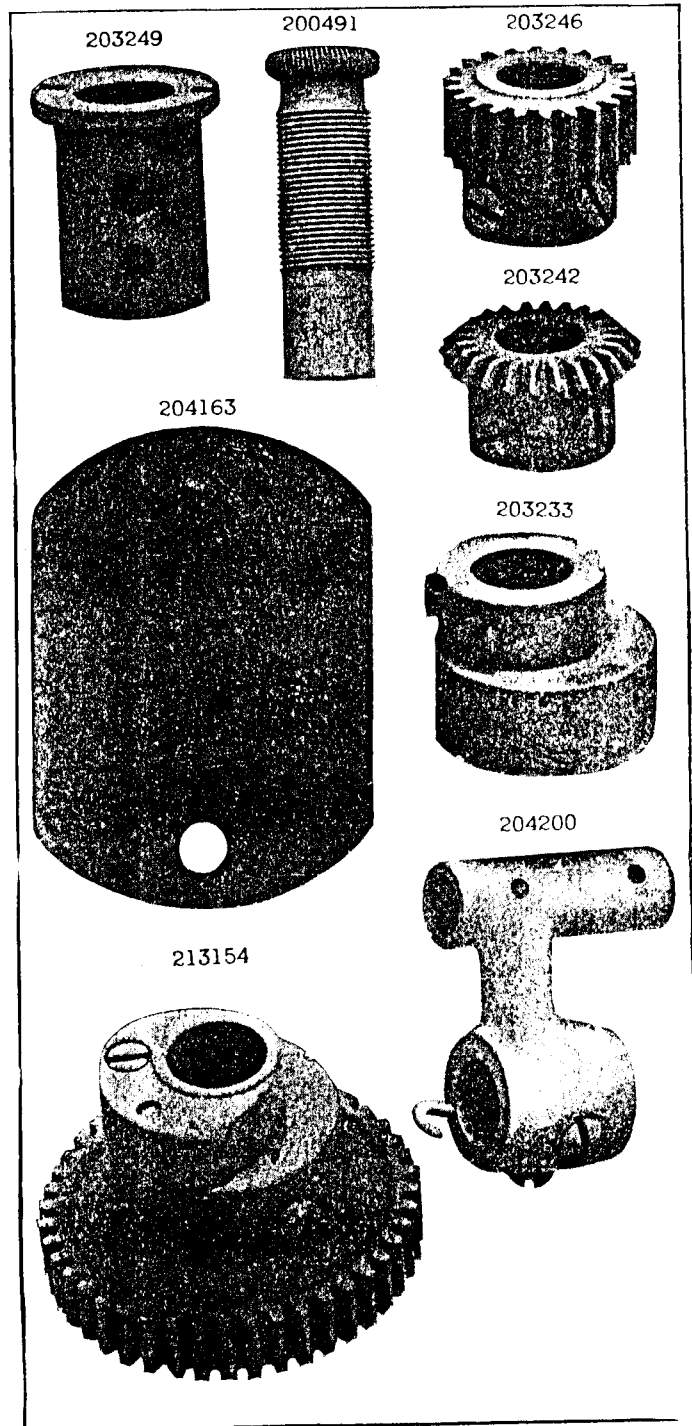


PLATE 12223-FULL SIZE

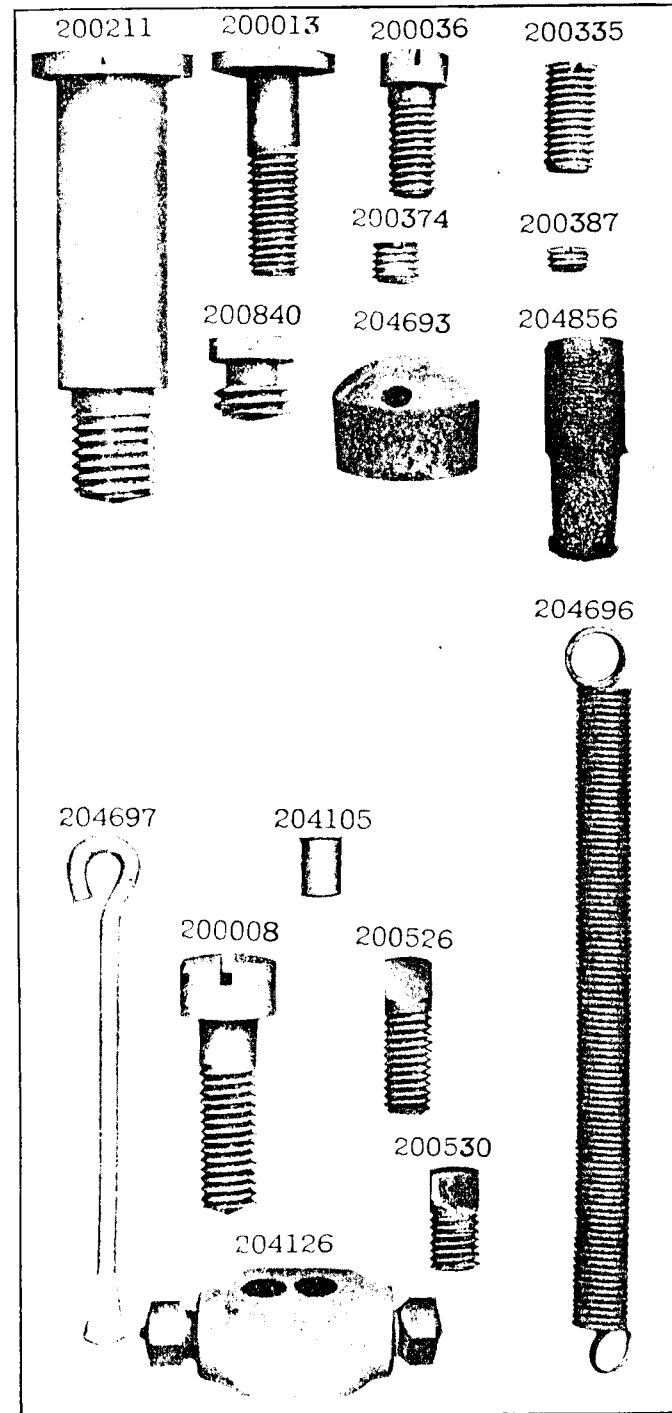


PLATE 12307—FULL SIZE

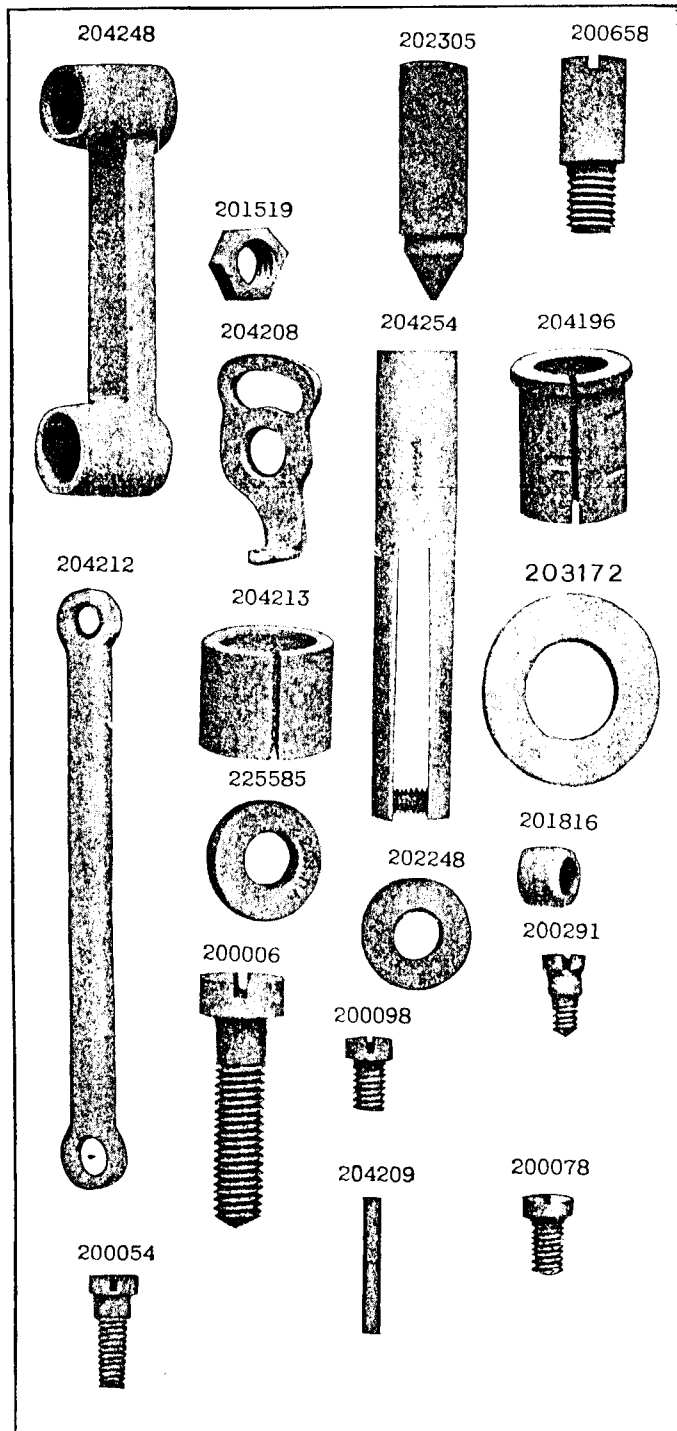


PLATE 12304—ONE-HALF SIZE

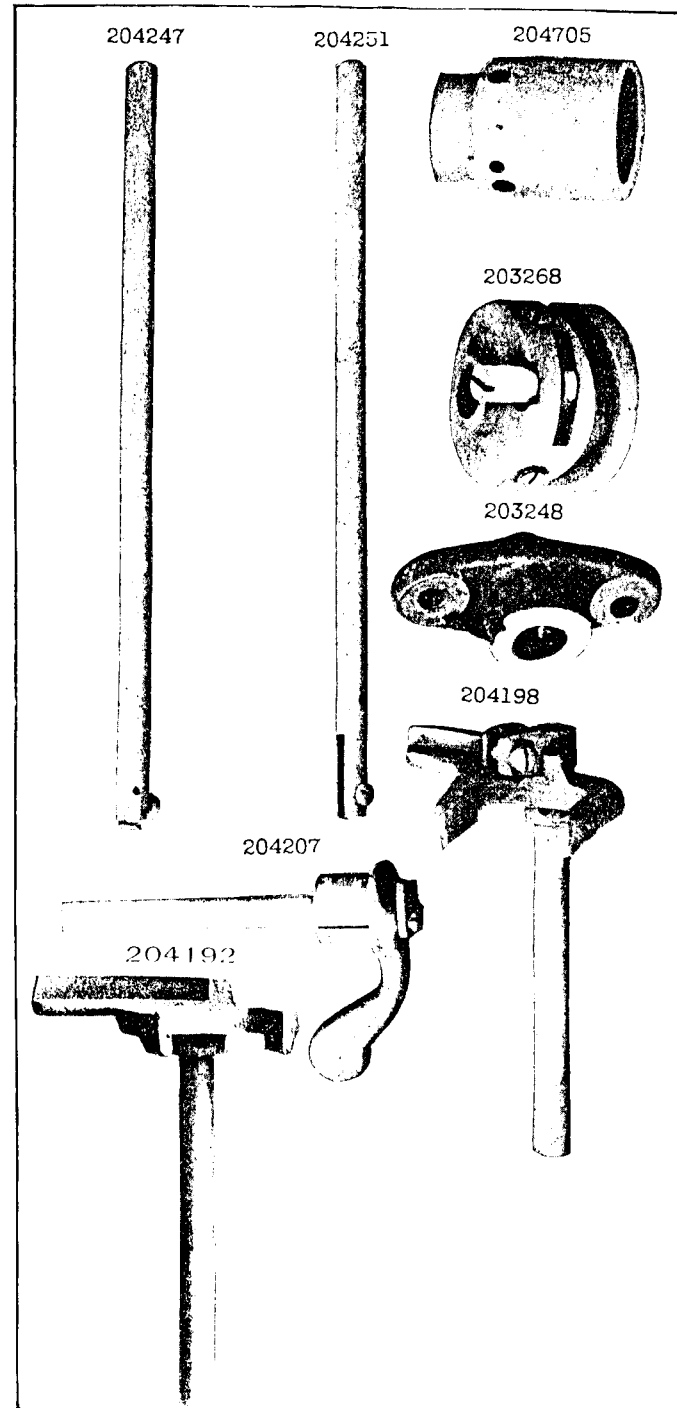




PLATE 12309 -FULL SIZE

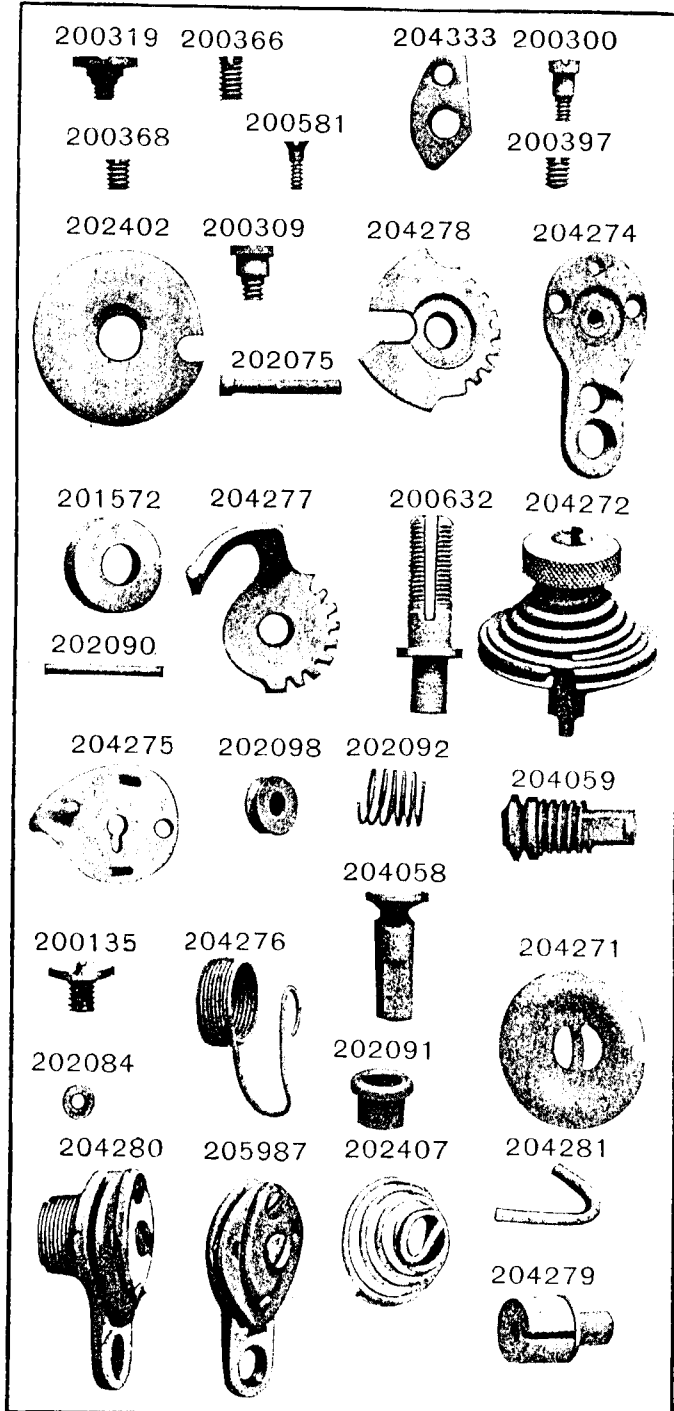


PLATE 12306 -FULL SIZE

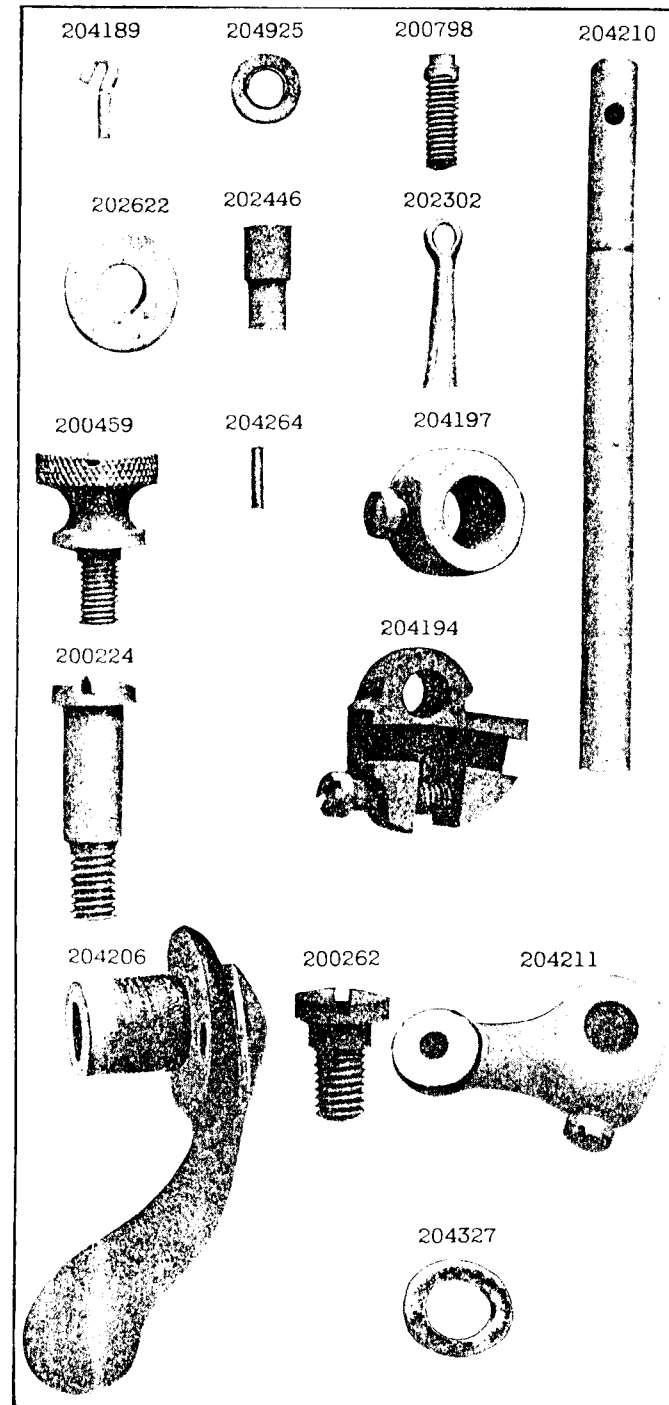


PLATE 12311—FULL SIZE

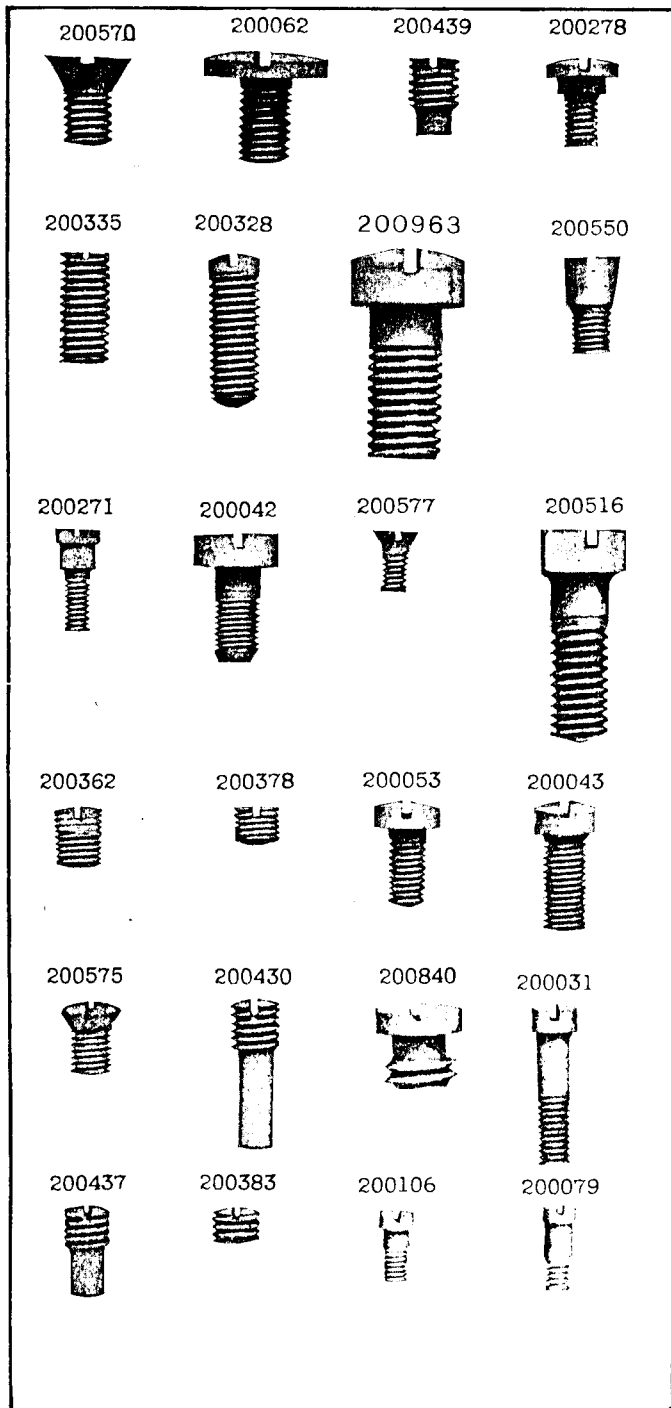


PLATE 12308—FULL SIZE

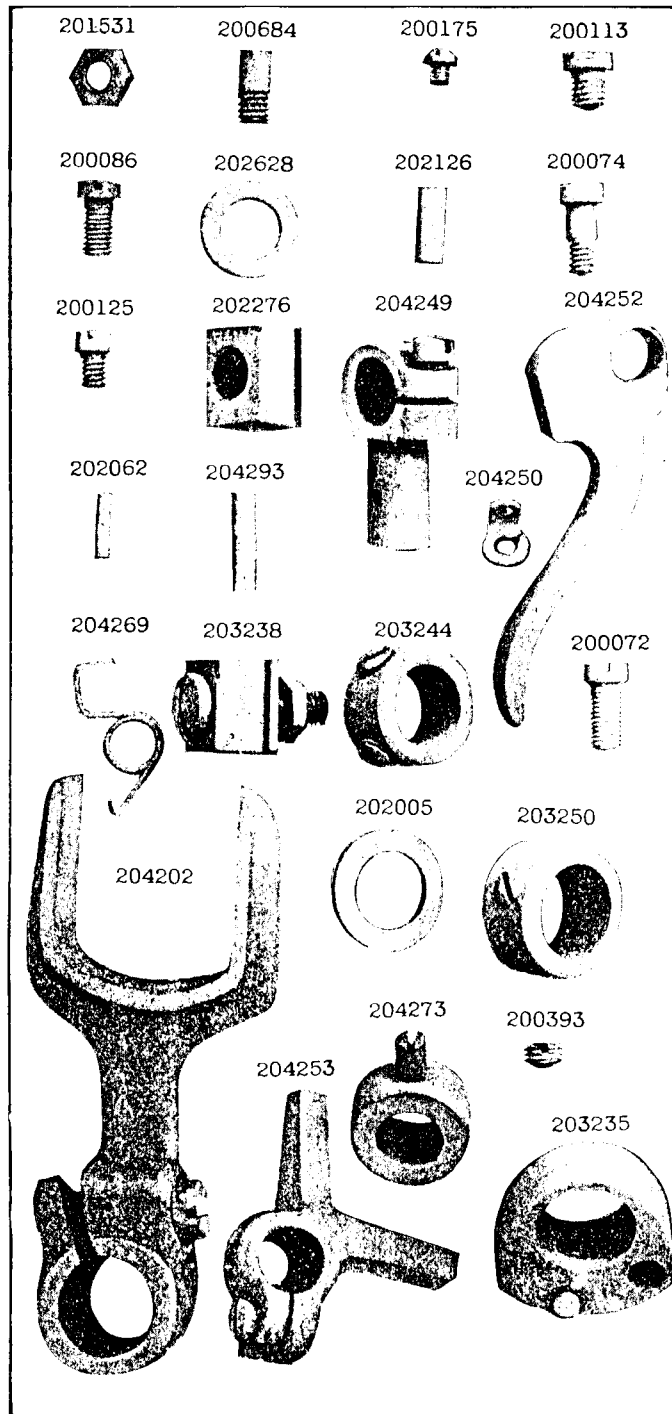


PLATE 12313—FULL SIZE

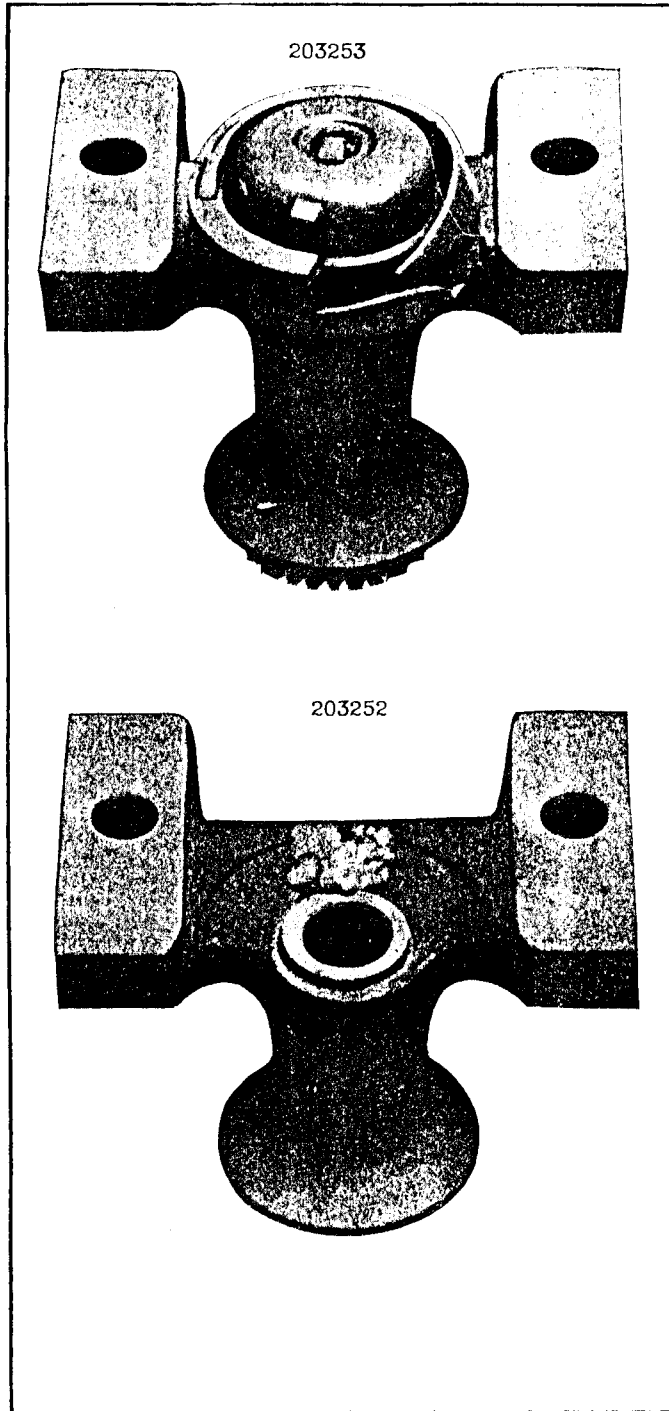


PLATE 12310—FULL SIZE

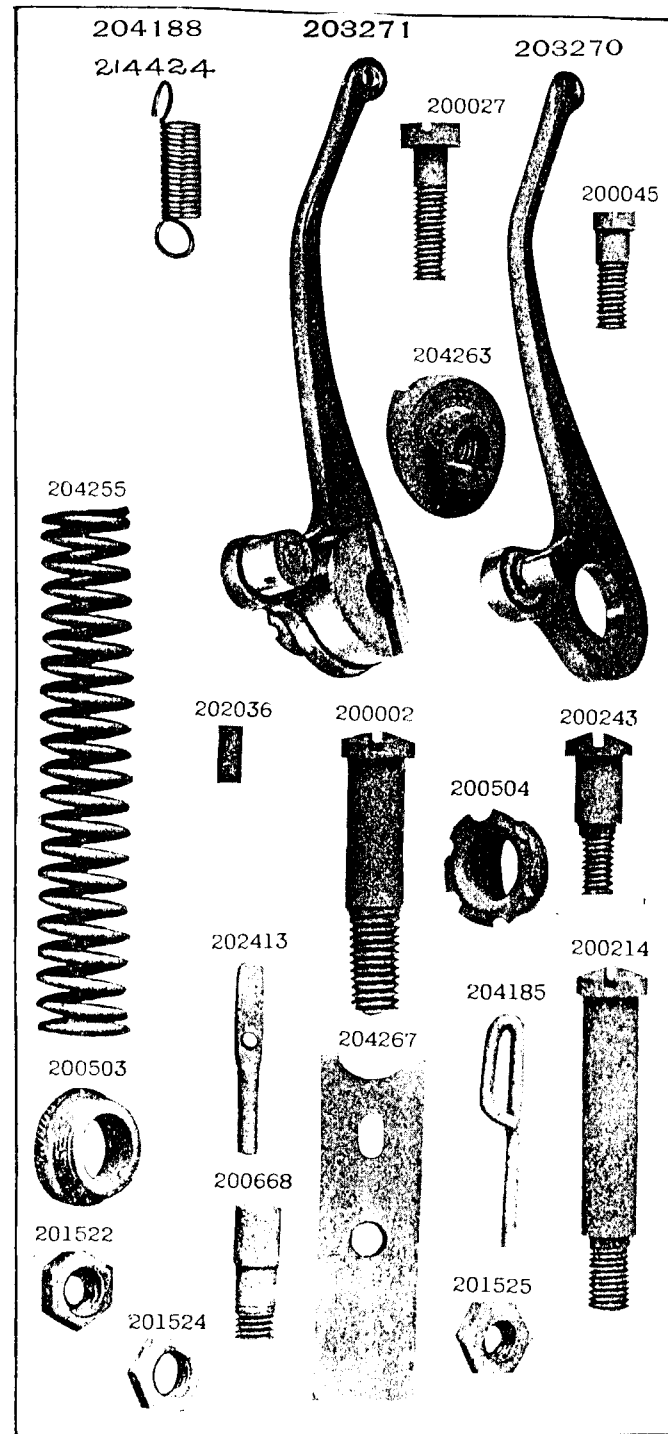


PLATE 12320—ONE-HALF SIZE

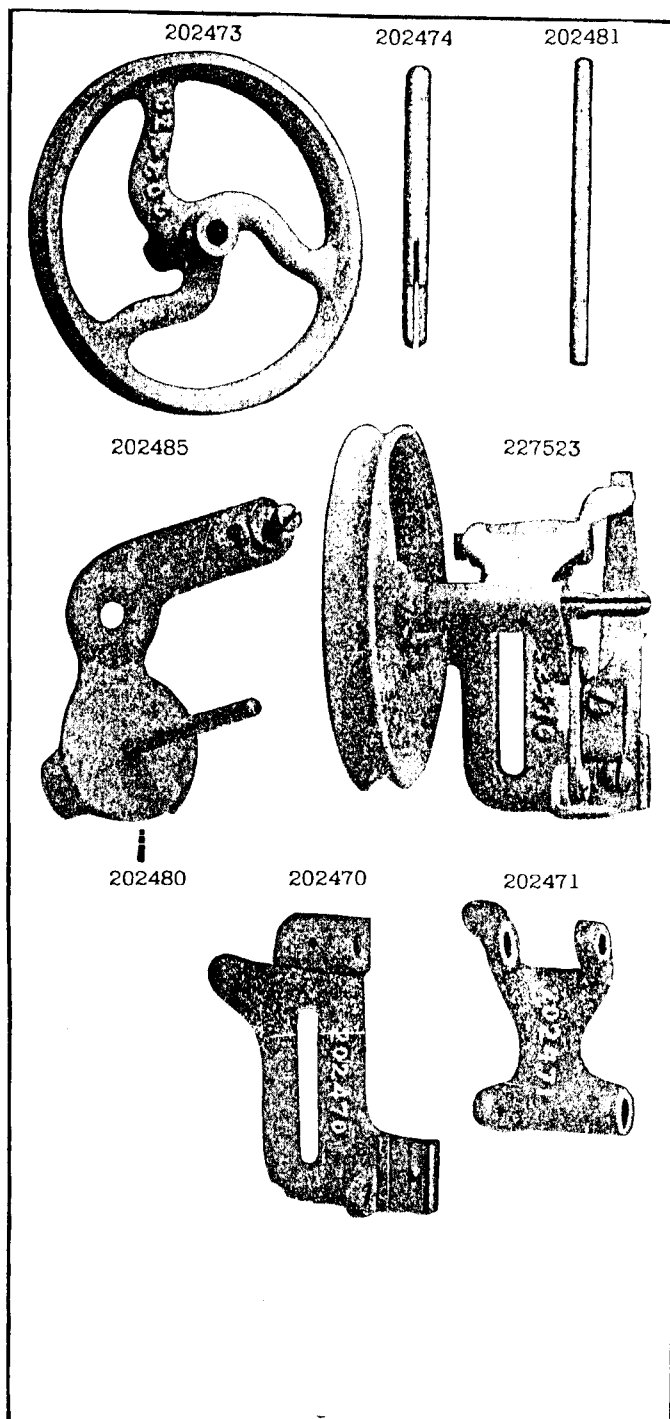


PLATE 12312—FULL SIZE

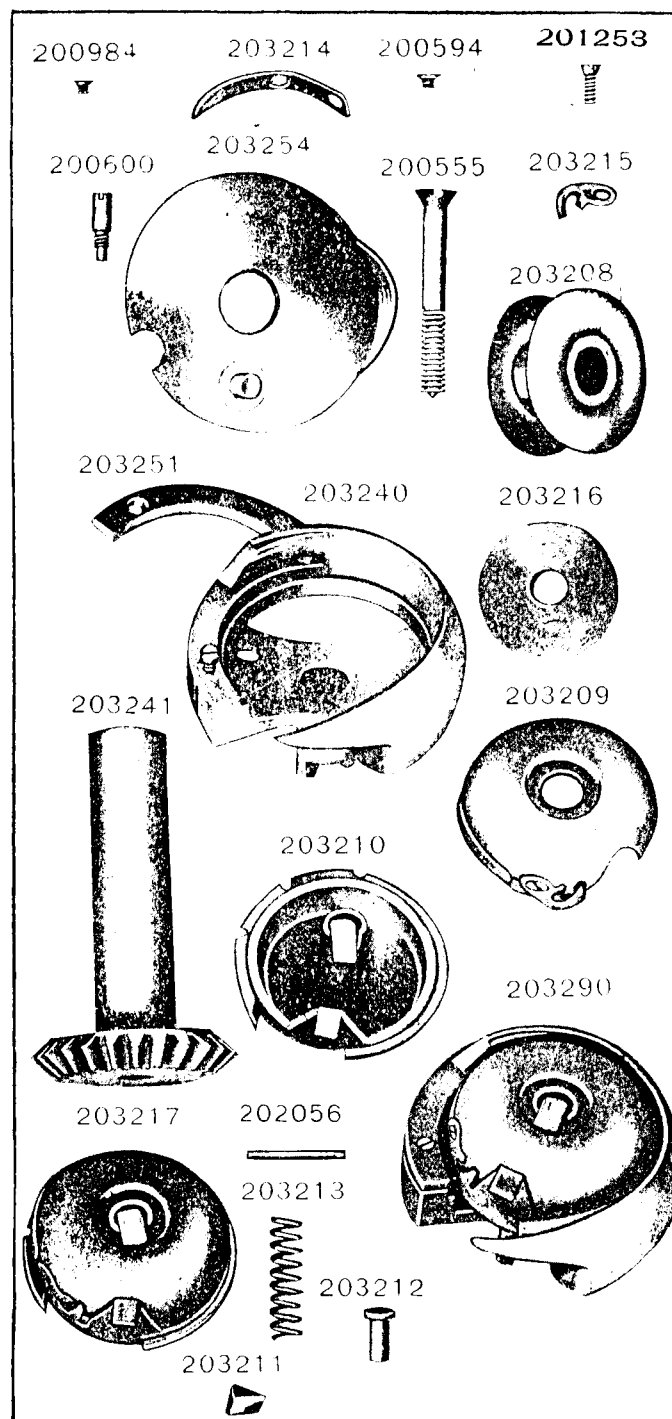


PLATE 12393—FULL SIZE

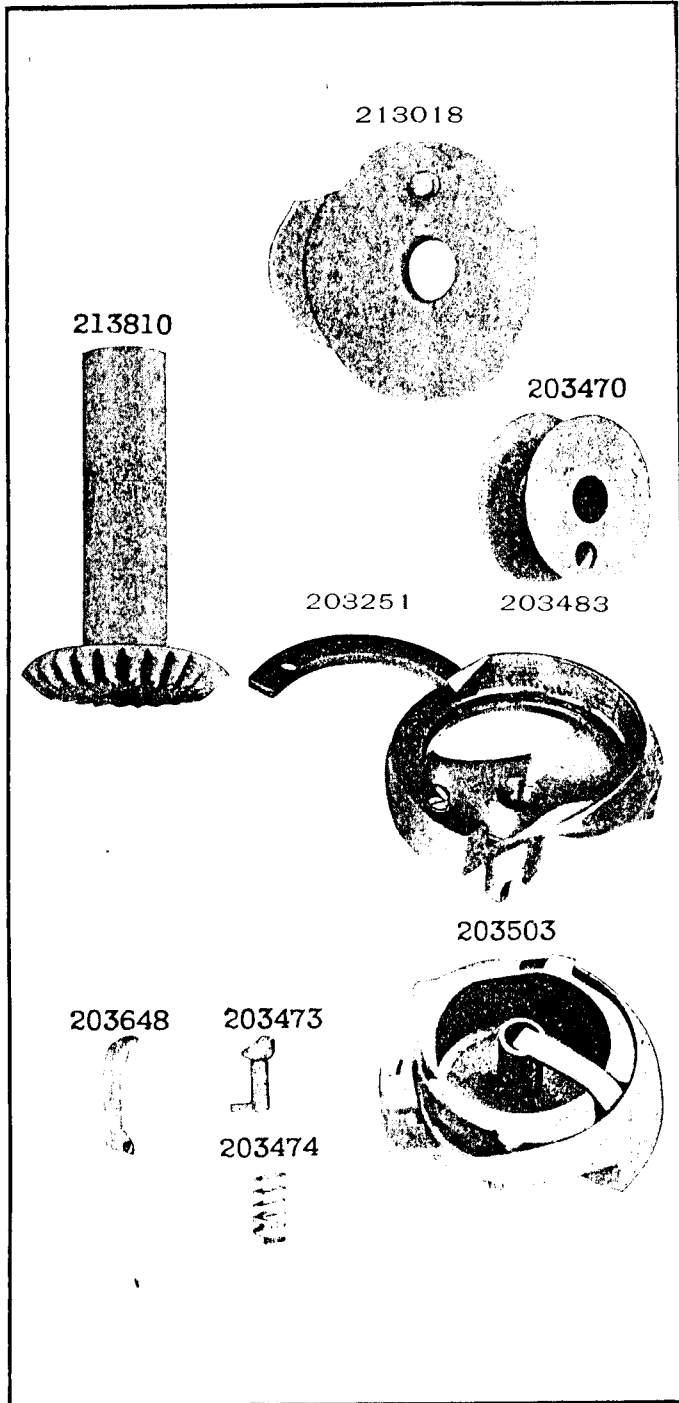


PLATE 12319 -FULL SIZE

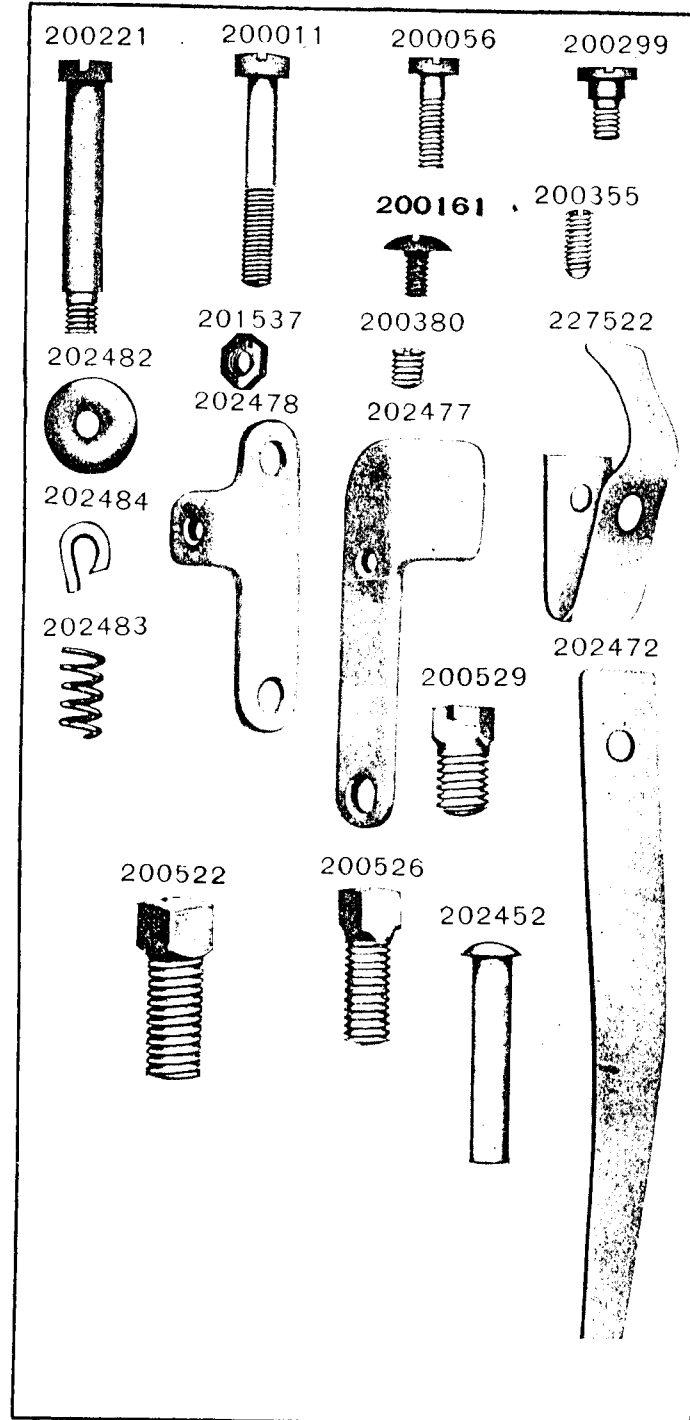


PLATE 13007—FULL SIZE

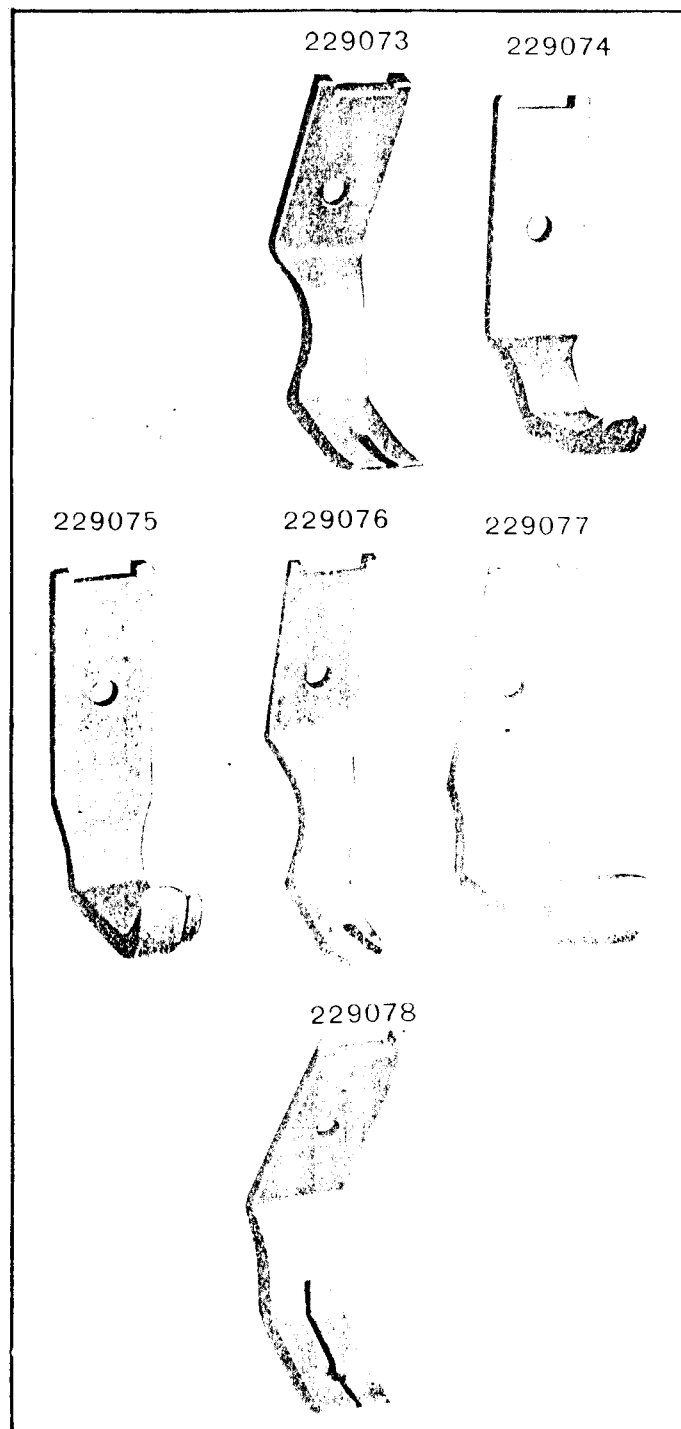


PLATE 12376—FULL SIZE

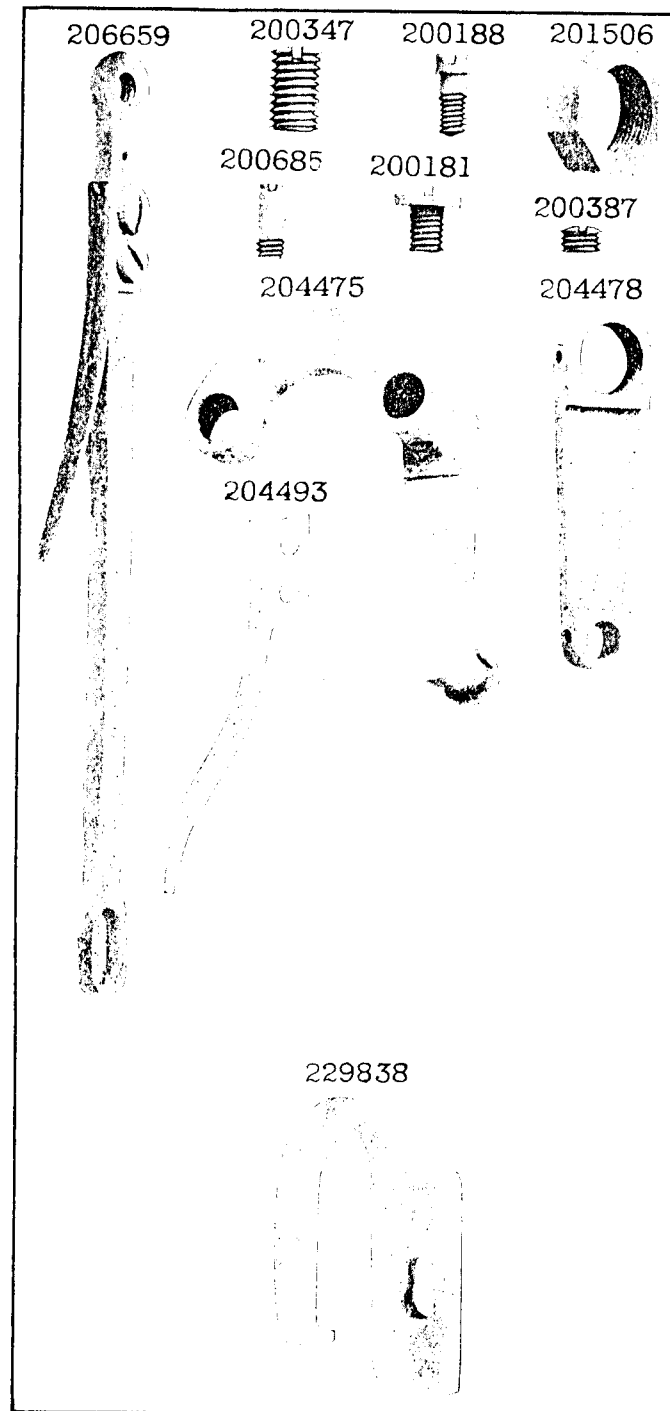


PLATE 13014—FULL SIZE

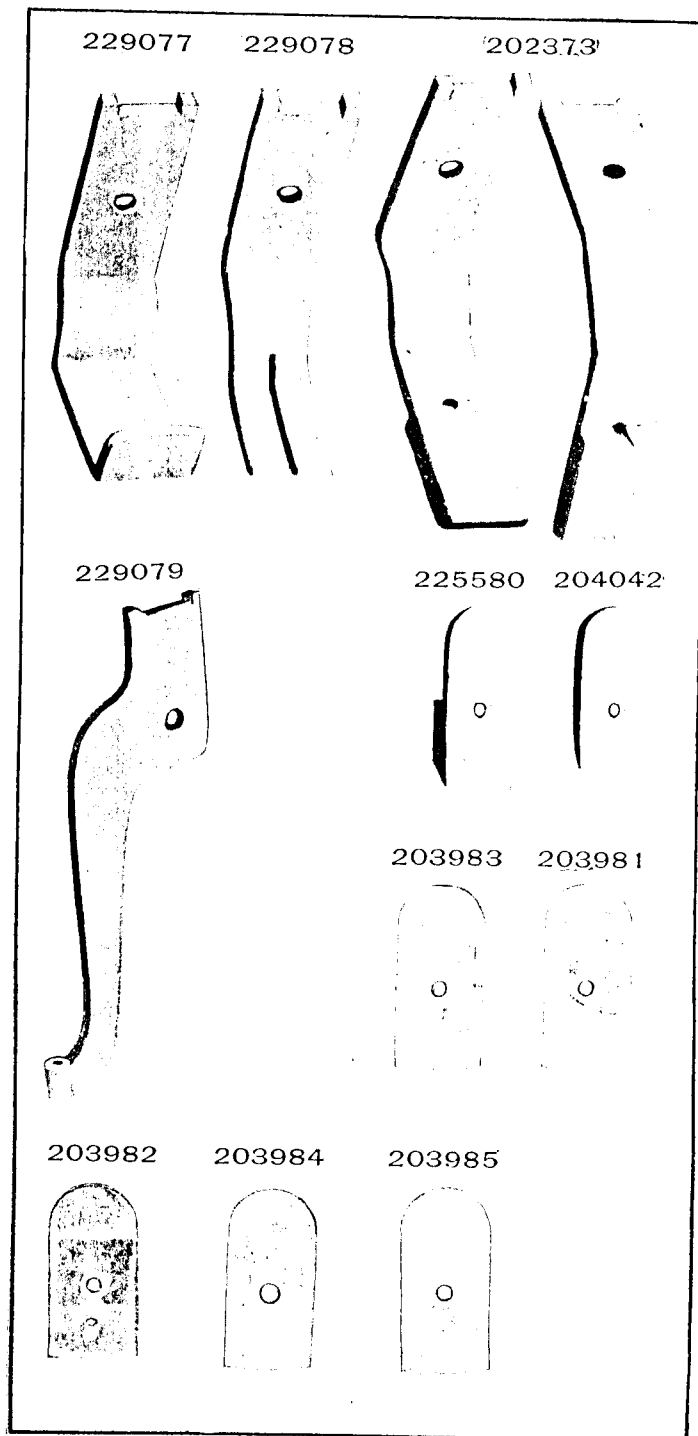


PLATE 12394—FULL SIZE

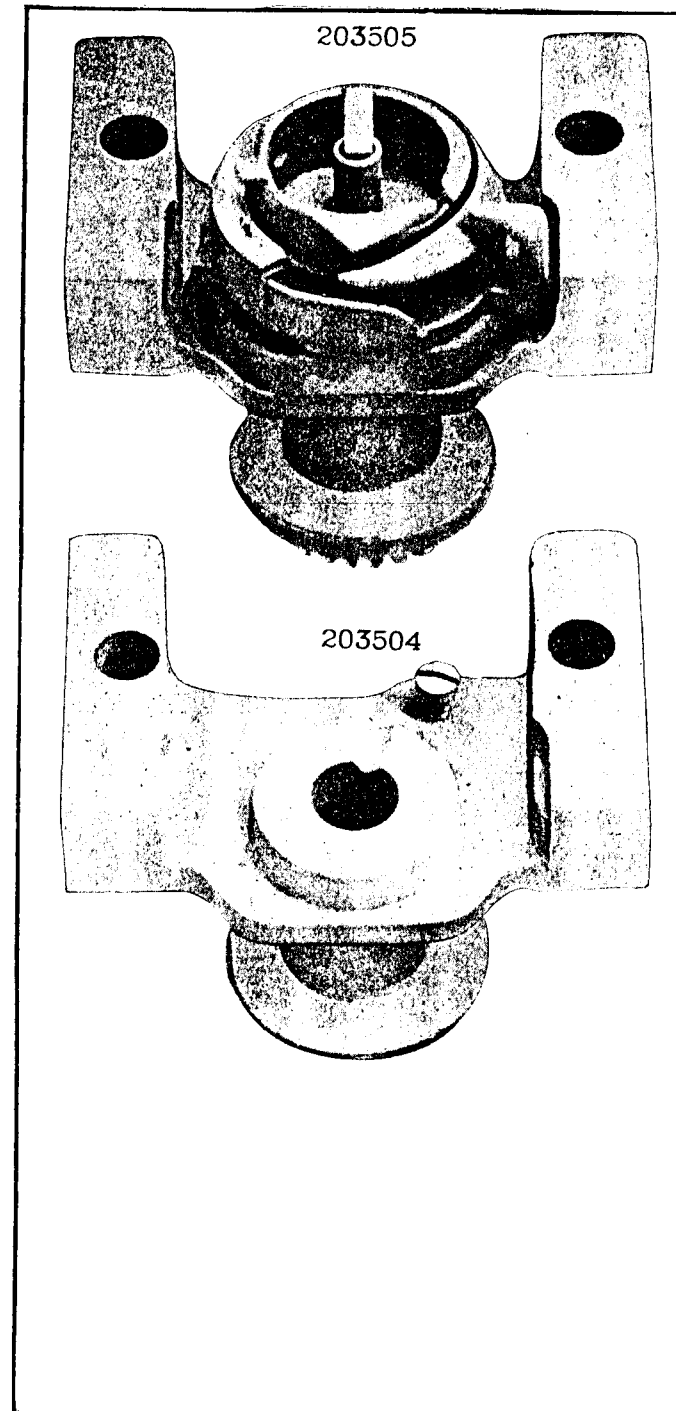


PLATE 13030-FULL SIZE

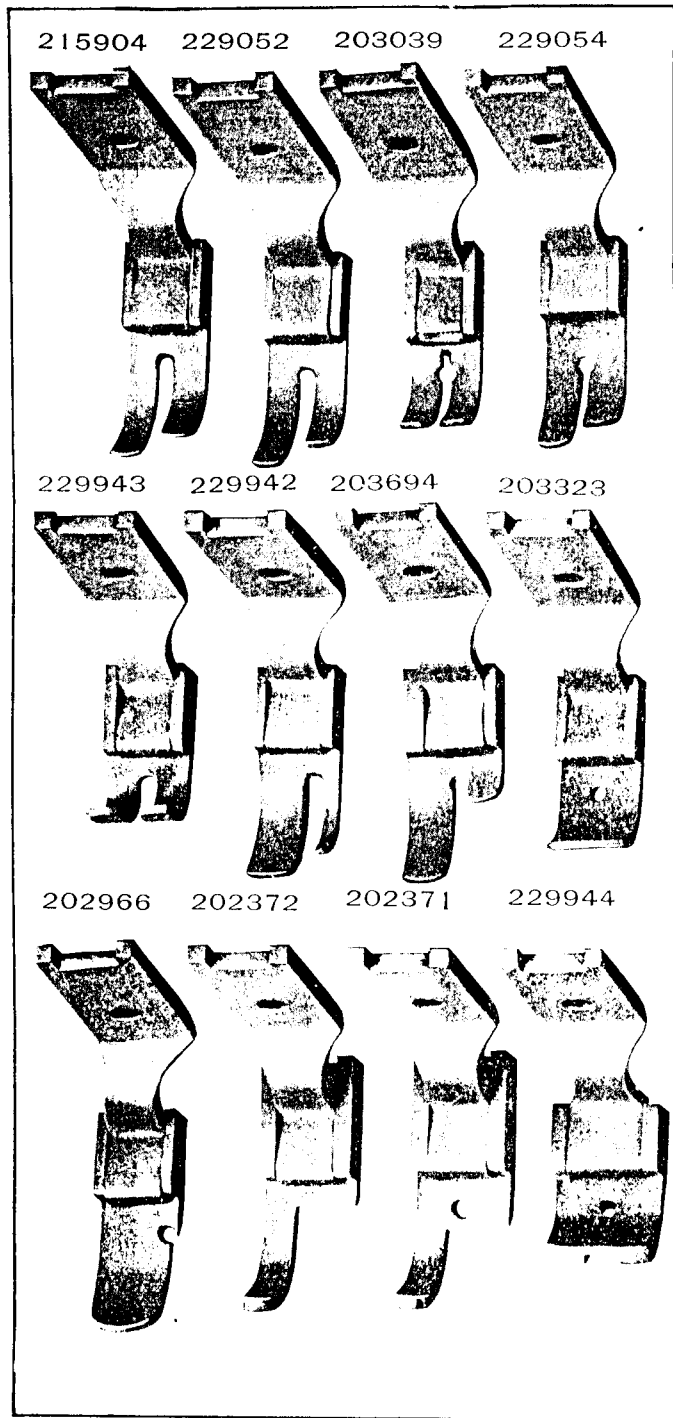


PLATE 13008-FULL SIZE

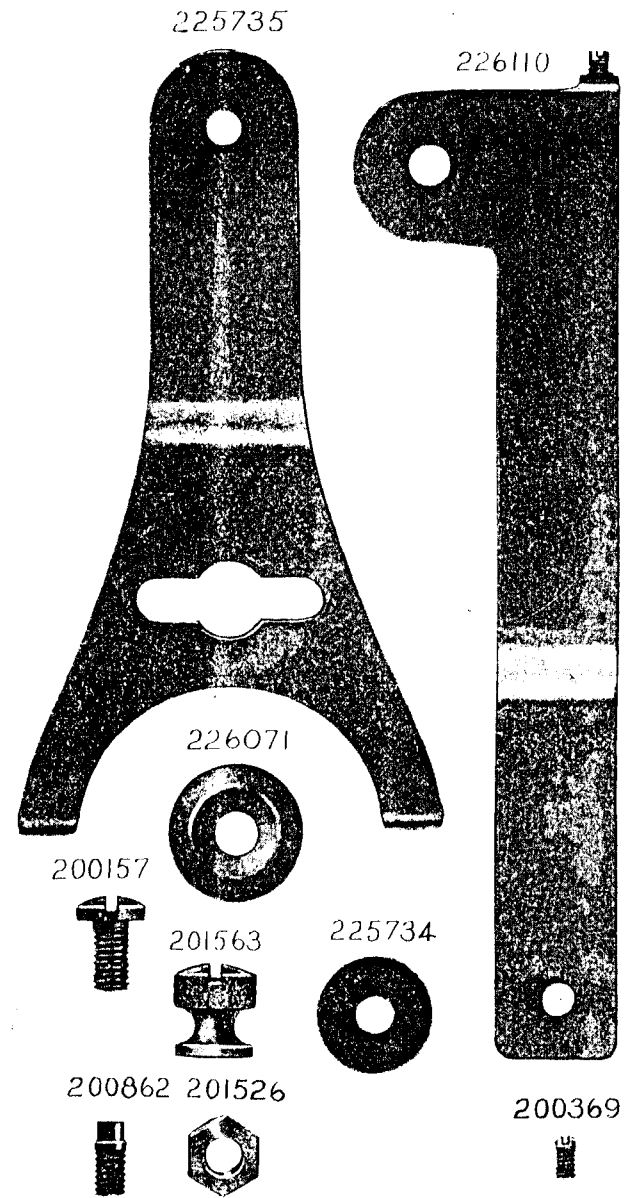




PLATE 13032--FULL SIZE

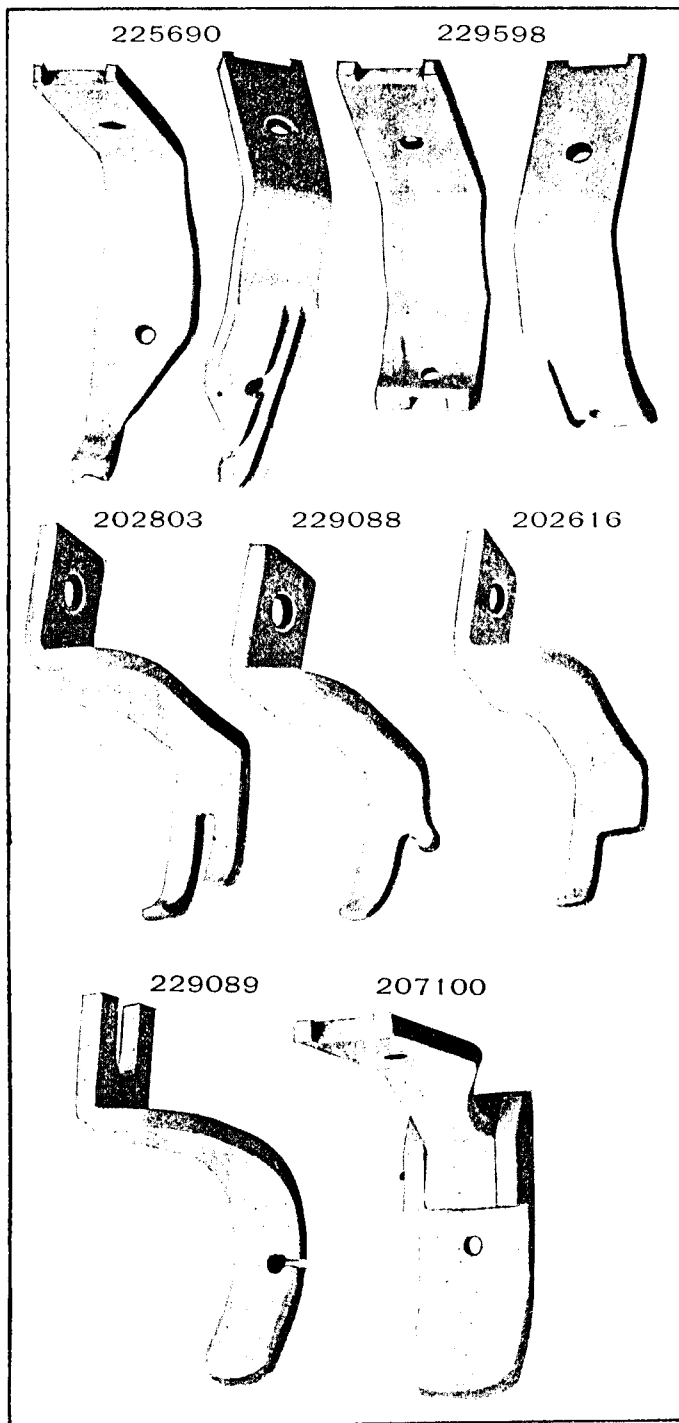


PLATE 13029--FULL SIZE

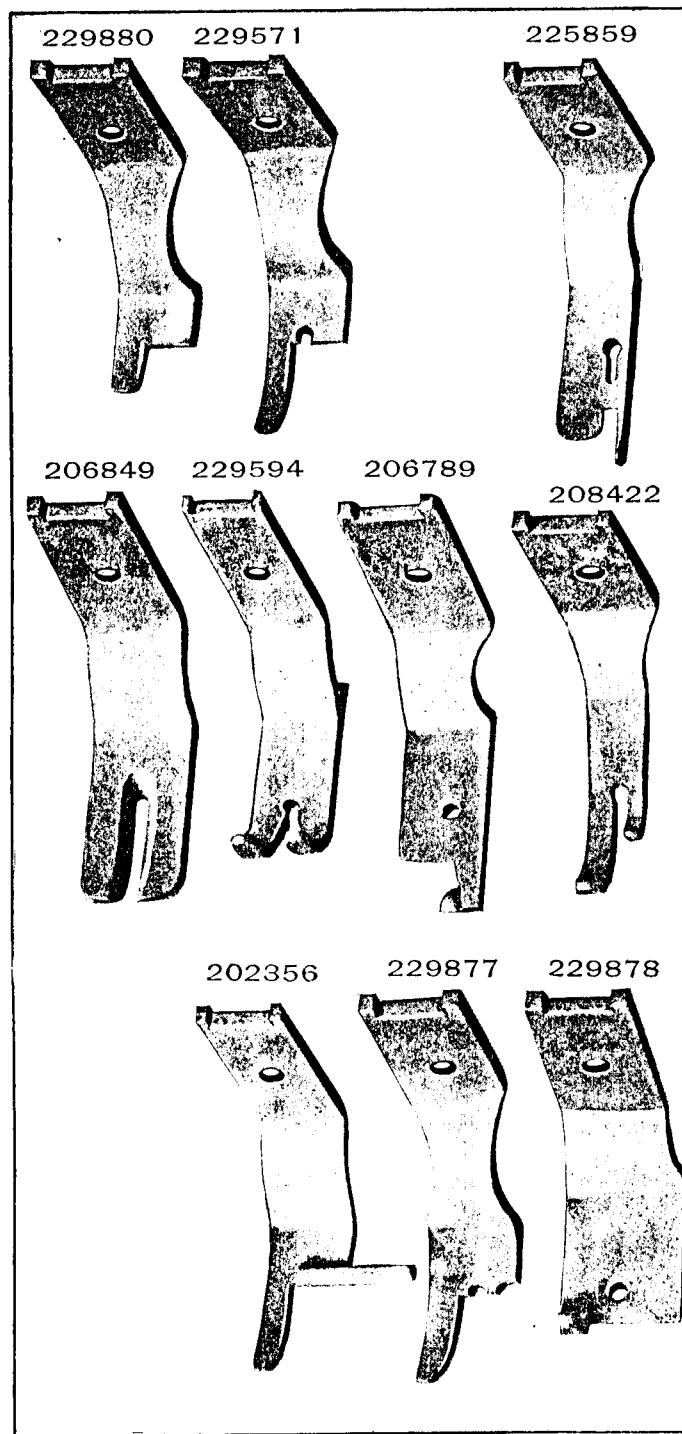


PLATE 13035-FULL SIZE

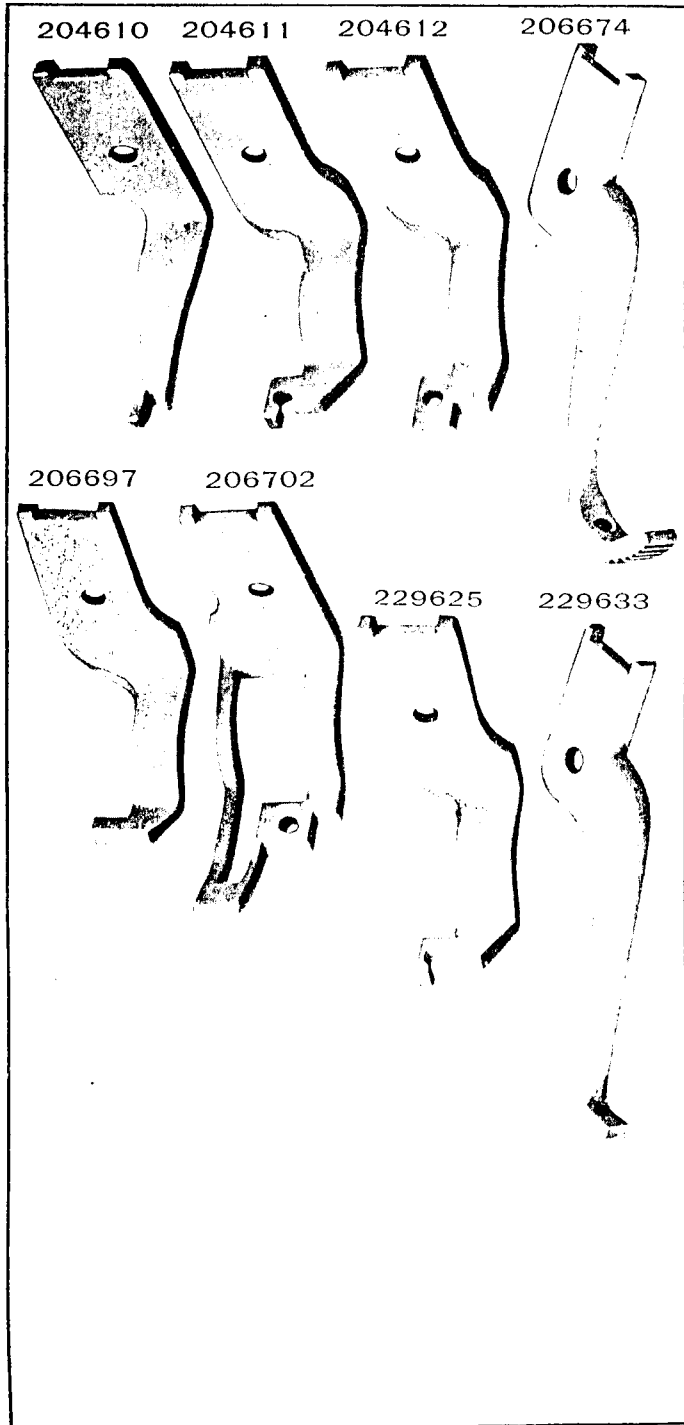


PLATE 13031-FULL SIZE

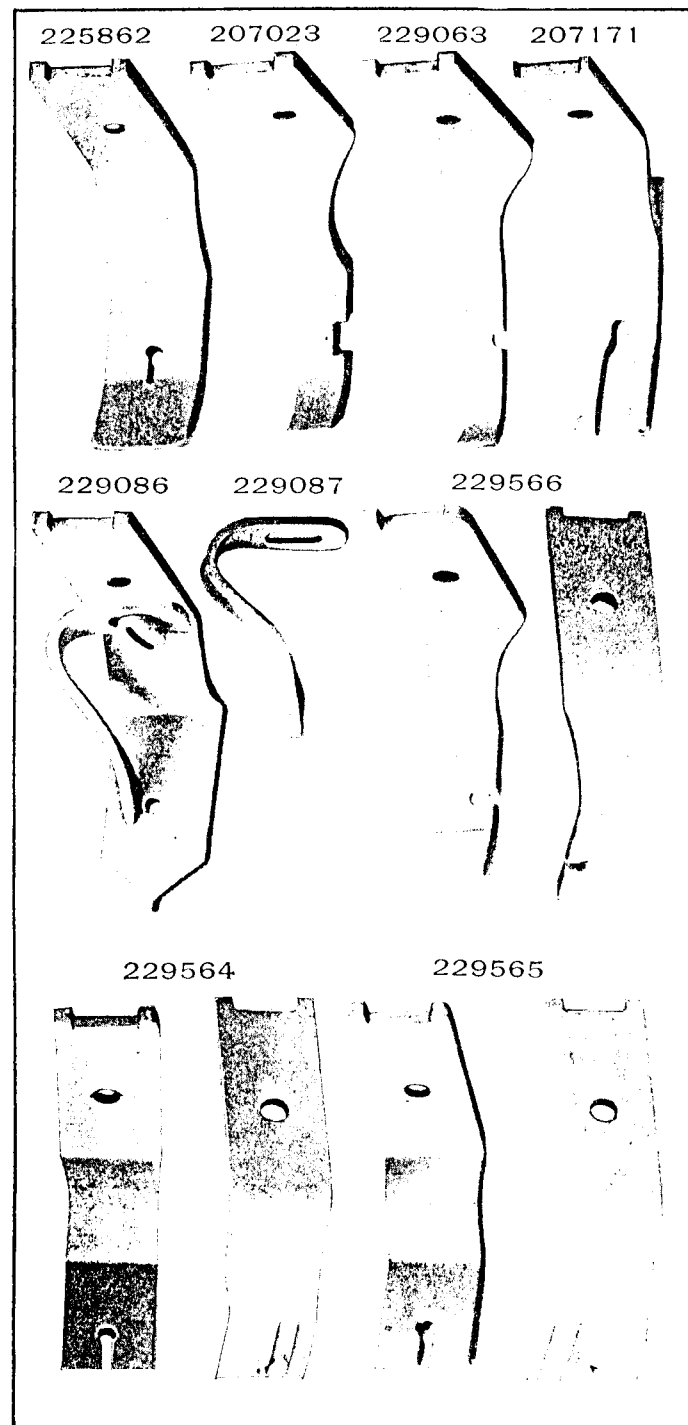


PLATE 13037-FULL SIZE

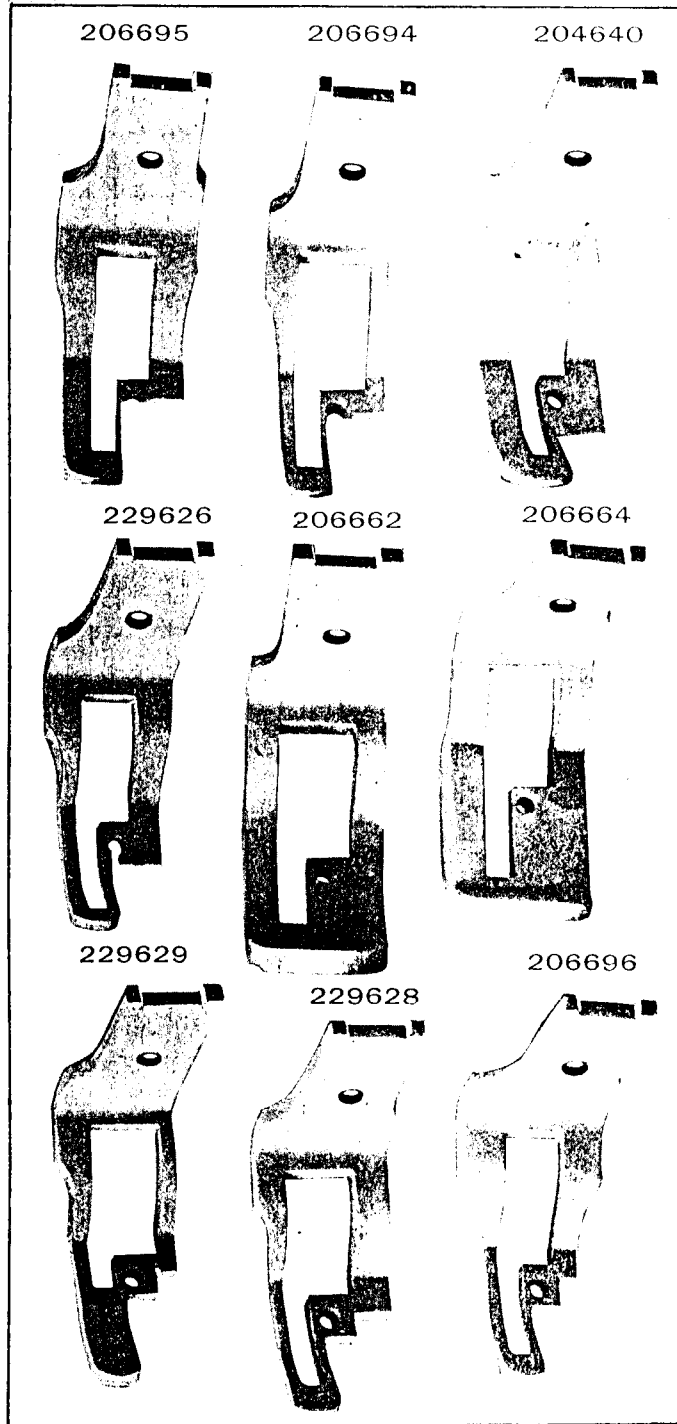


PLATE 13034-FULL SIZE

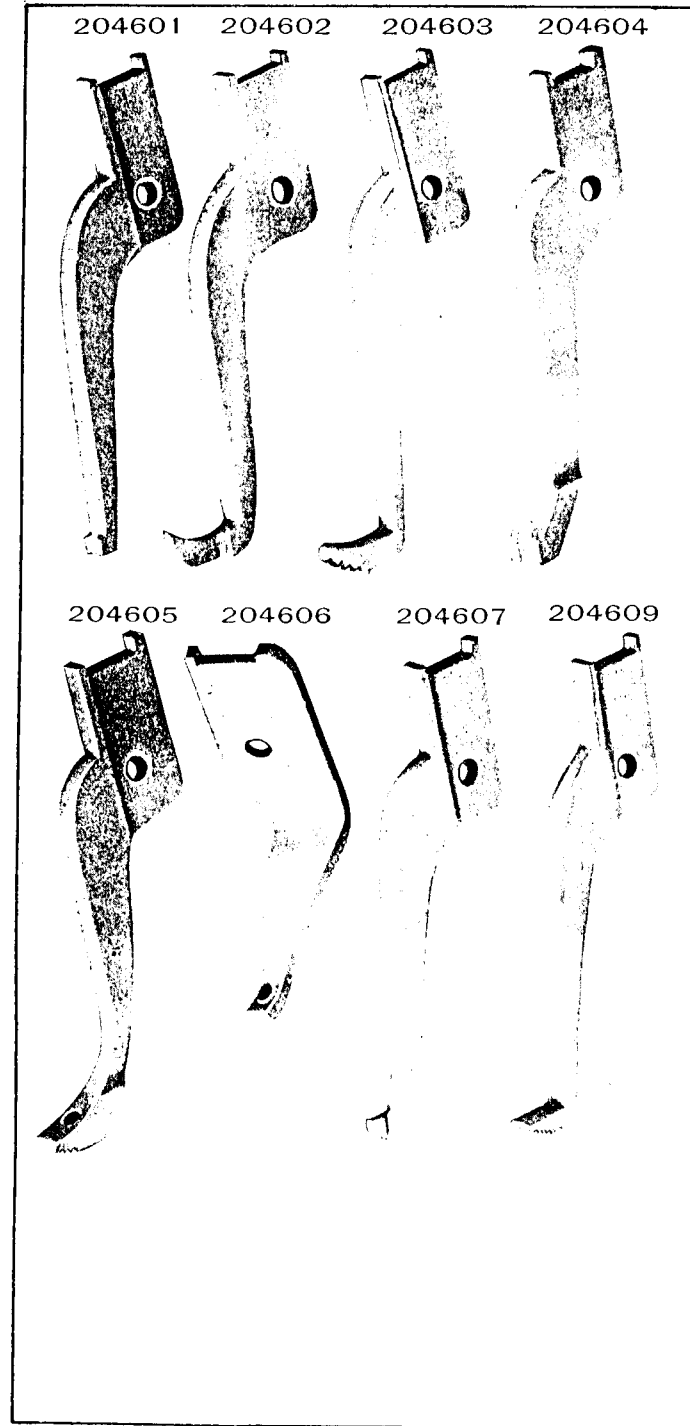


PLATE 13039—FULL SIZE

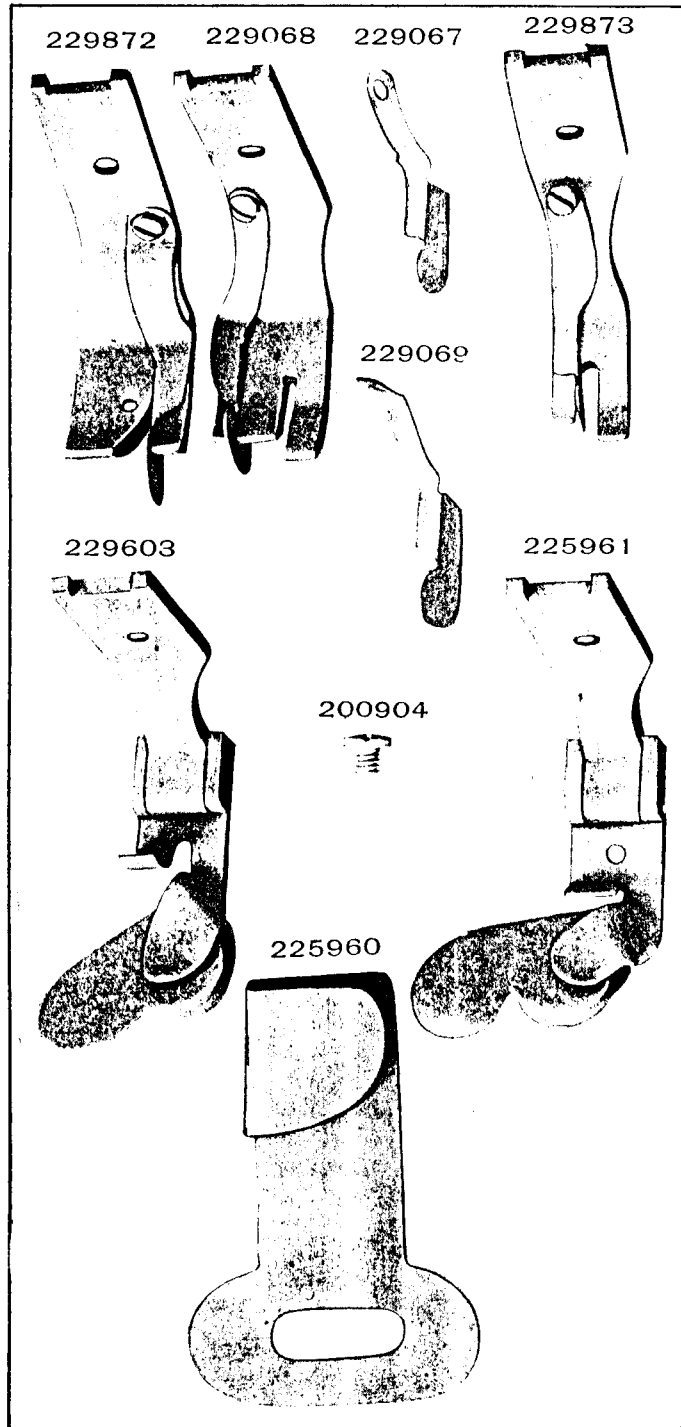


PLATE 13036—FULL SIZE

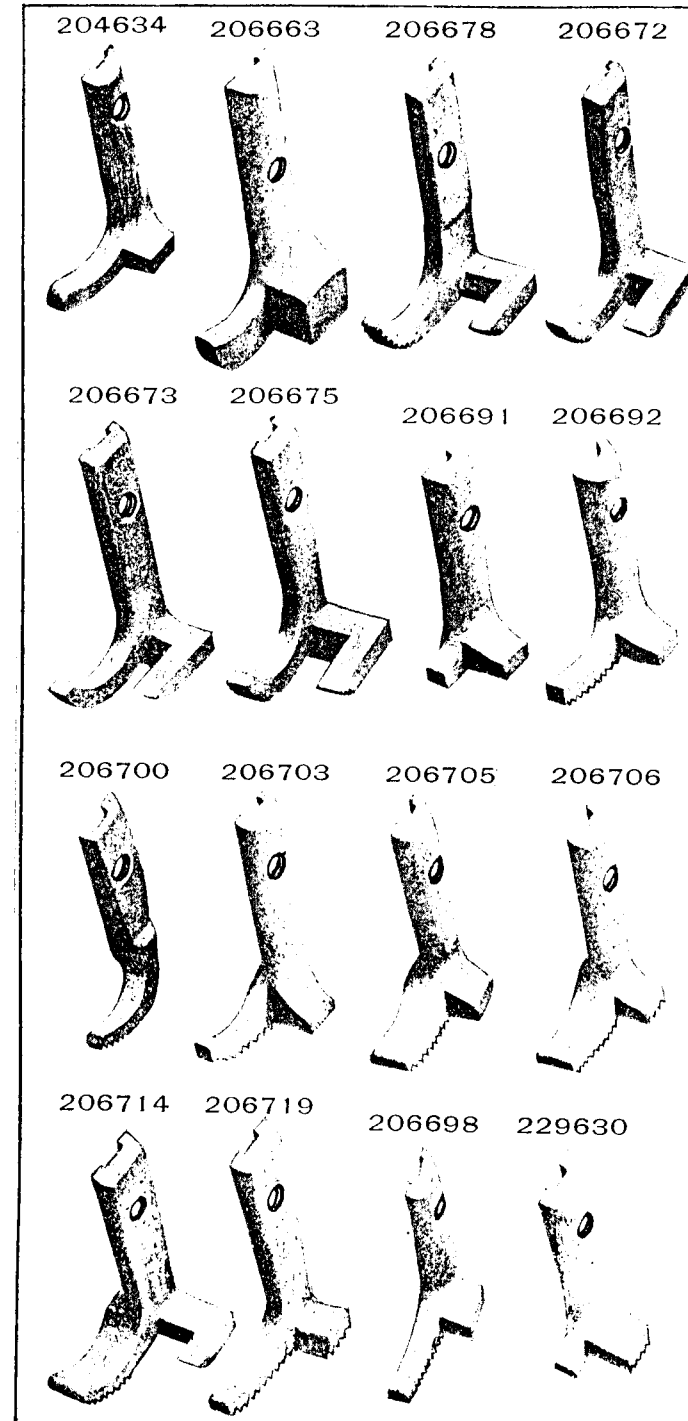


PLATE 13049—FULL SIZE

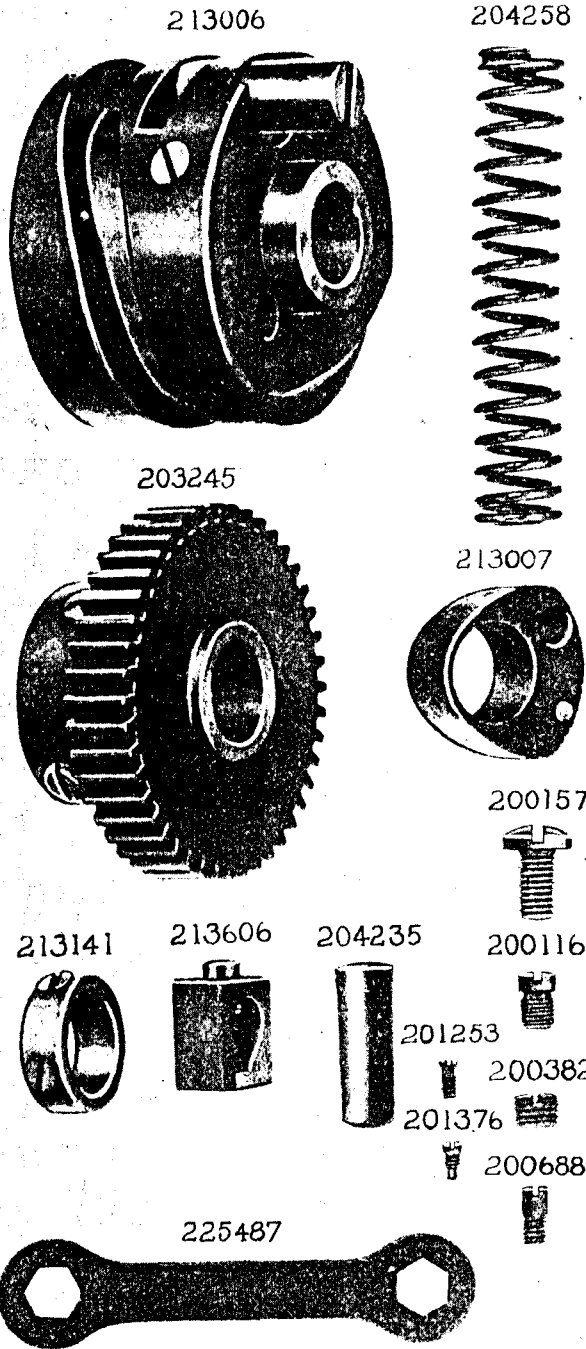


PLATE 13038—FULL SIZE

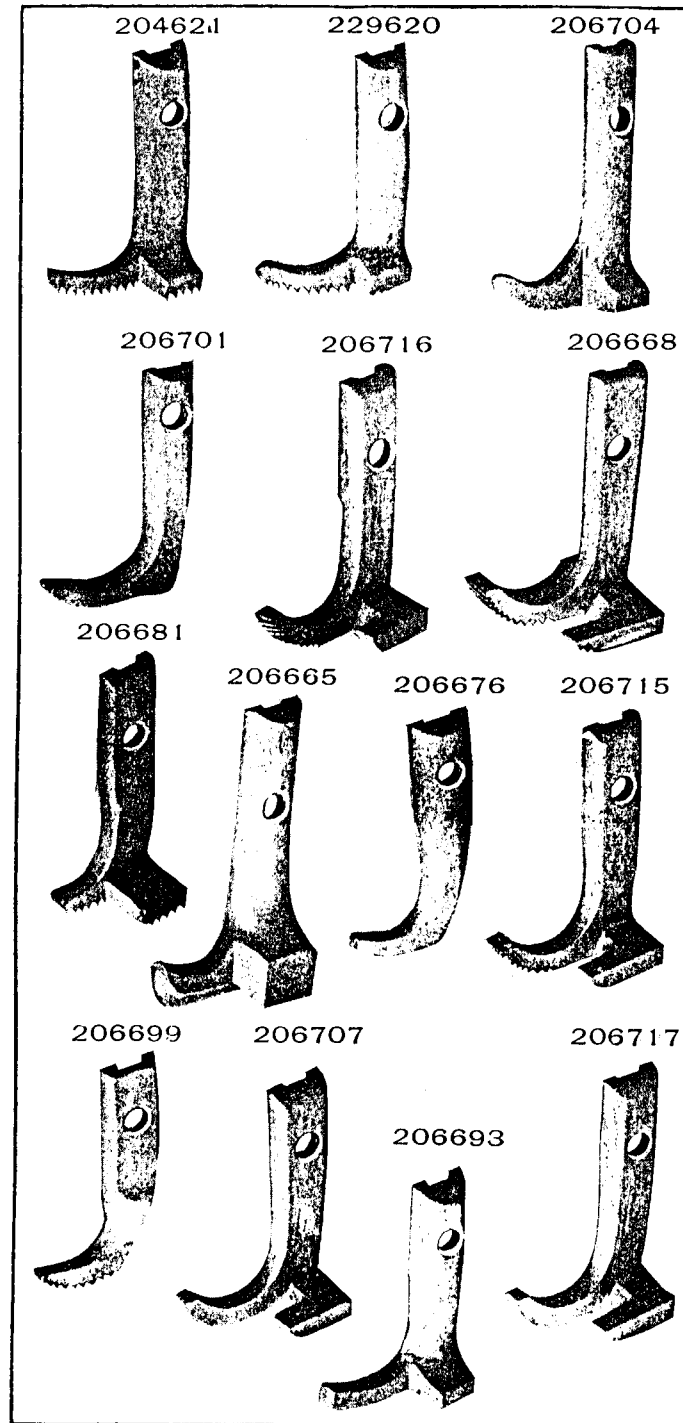


PLATE 14223-FULL SIZE

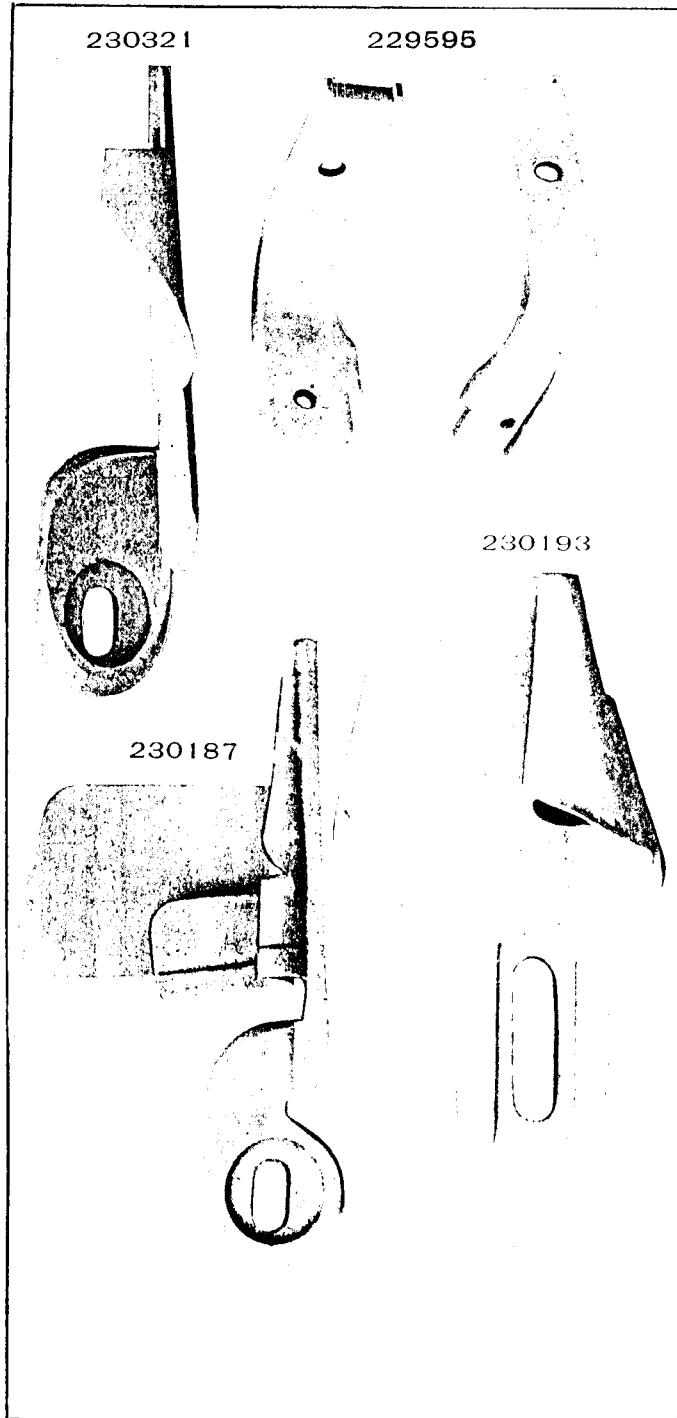


PLATE 13041-FULL SIZE

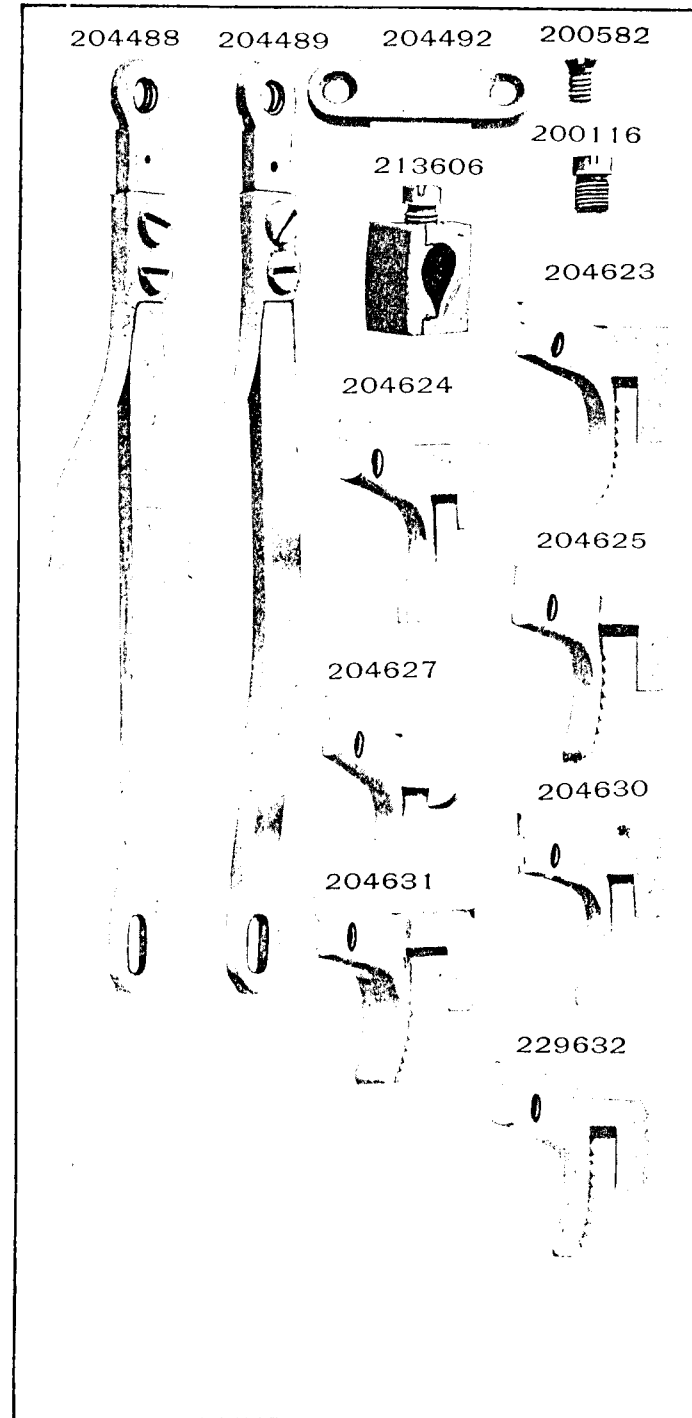


PLATE 14226-FULL SIZE

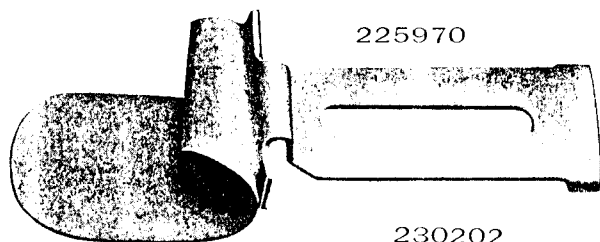
225630



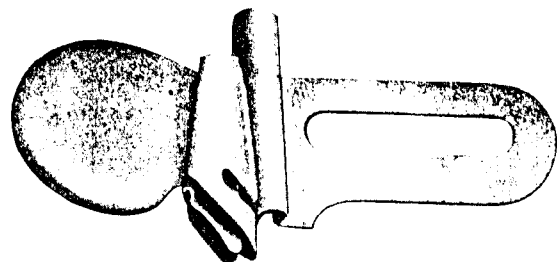
225631



225970



230202



226039

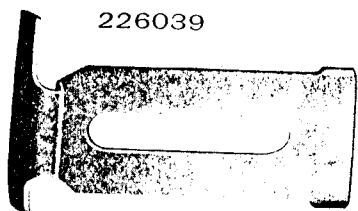
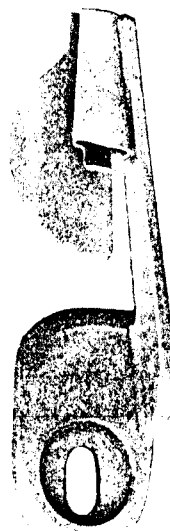


PLATE 14222-FULL SIZE

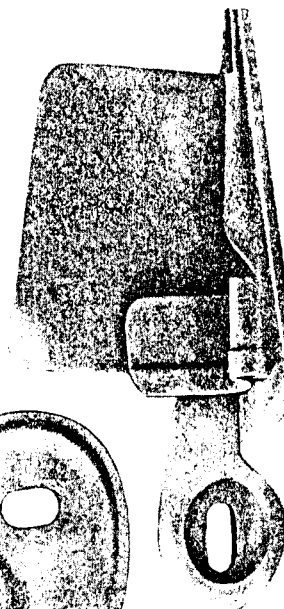
230741



230196



230186



230210

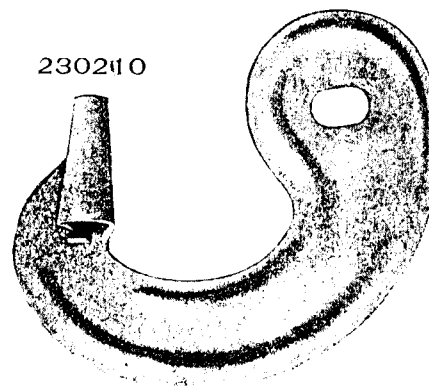


PLATE 14230—ONE-HALF SIZE

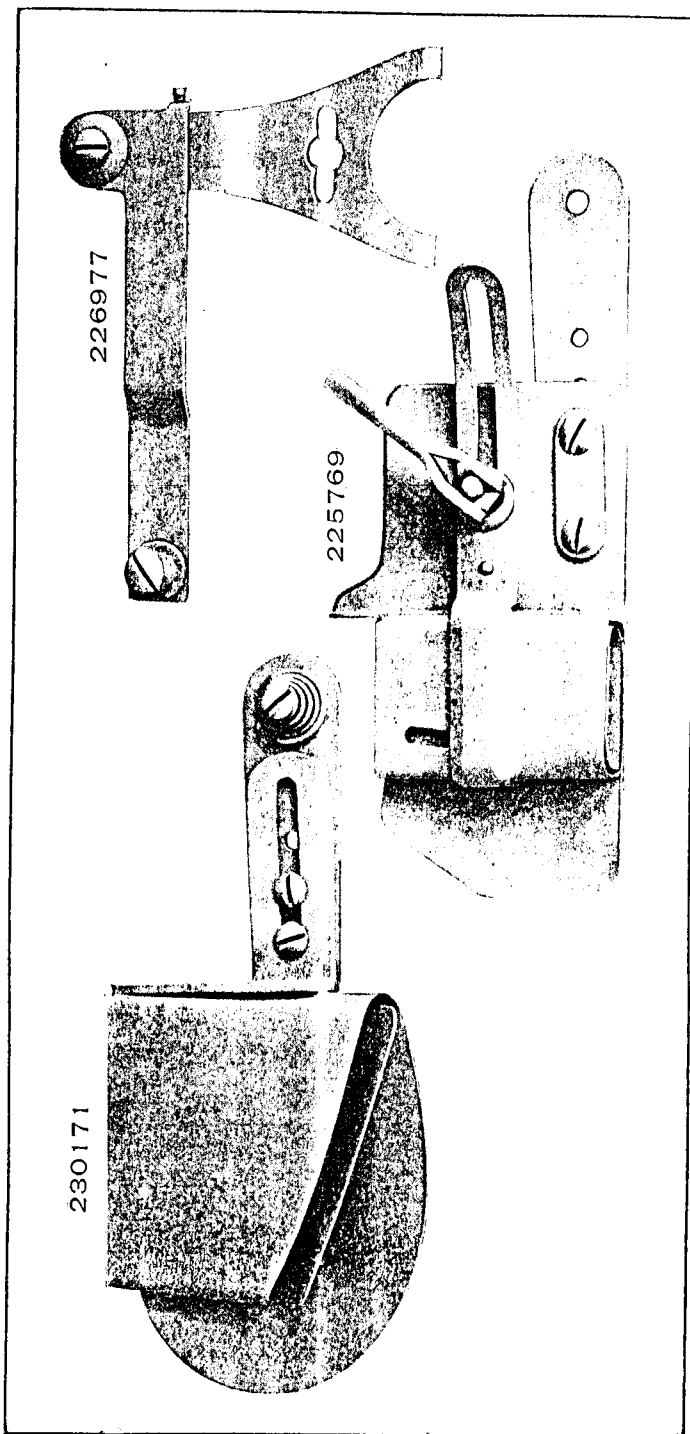


PLATE 14225—FULL SIZE

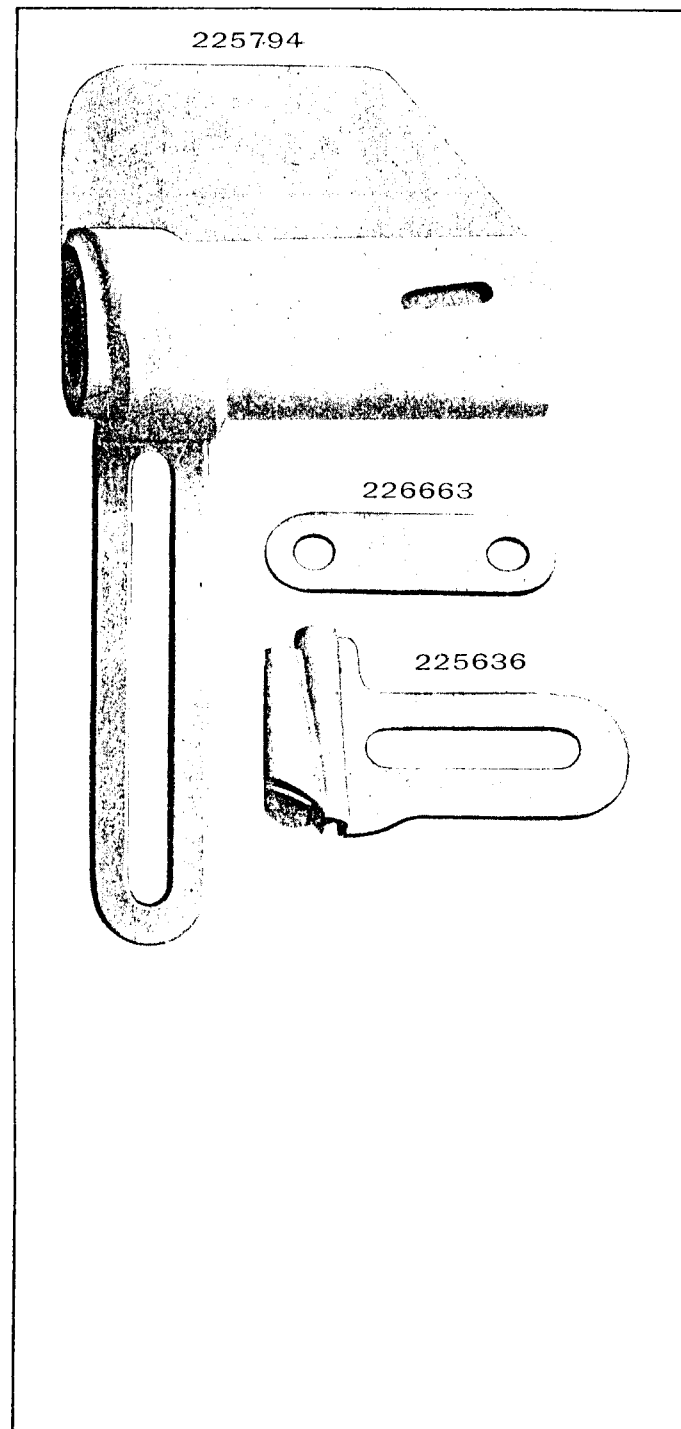




PLATE 14384—ONE-FOURTH SIZE

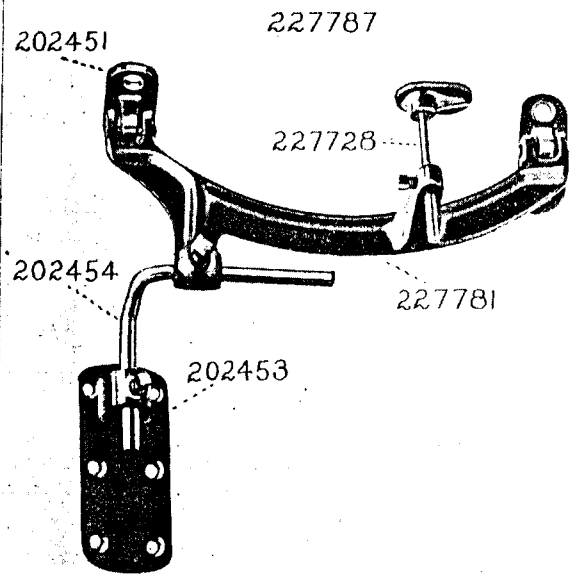


PLATE 14228 — ONE-HALF SIZE

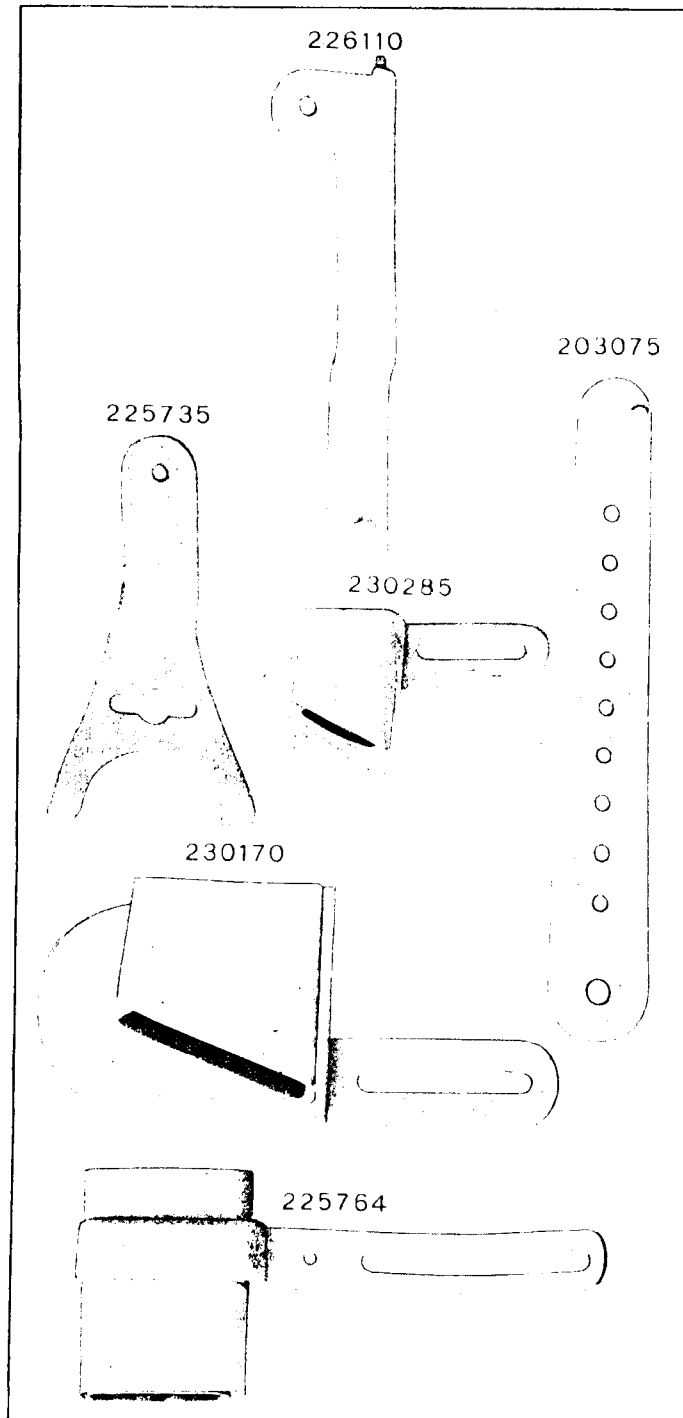
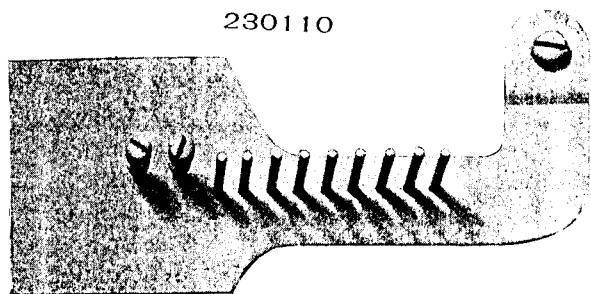


PLATE 14534—ONE-HALF SIZE

230110



230117

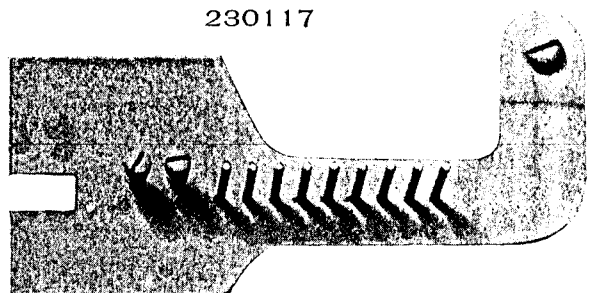
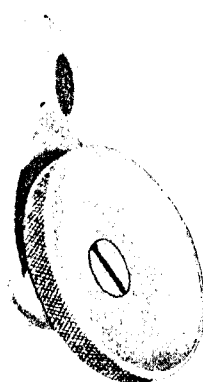


PLATE 14305—FULL SIZE

204567



204572



204574



229798

