

LIST OF PARTS

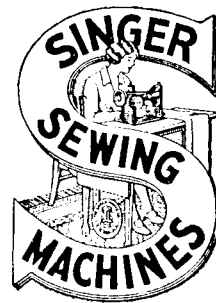

MACHINES Nos. 148-4 and 148-7

THE SINGER MANUFACTURING COMPANY

COPYRIGHT, U. S. A., 1922, 1926, 1928, 1929 and 1930
BY THE SINGER MANUFACTURING COMPANY
ALL RIGHTS RESERVED FOR ALL COUNTRIES

INDEX

	PAGE
ACCESSORIES	37
BELT GUARD	37
FOOT LIFTER PARTS	37
IRON BASE	36
LAP SEAM FELLER PARTS	38
MACHINE NO. 148-4	7
“ “ 148-7	22
NUMERICAL LIST OF PARTS	41
OBSOLETE PARTS	39
THREAD UNWINDER	38

INSTRUCTIONS FOR ORDERING

In ordering from this list, use **ONLY** the part **NUMBER** in the **FIRST** column.

The number stamped on a Sewing Machine part is in every case the number of the single part only.

Every combination of parts sent out as such has its specific number, which, although not stamped on the parts, must be used when ordering the combination.

Each number always indicates the **SAME PART** in whatever list it appears, or for whatever machine.

The letters after some of the numbers indicate the style of finish only, as follows:

- A—Hardened, Polished, Nickel Plated and Buffed
- B—Polished, Nickel Plated and Buffed
- C—Hardened Only
- D—Polished Only
- E—Soft, Not Polished
- F—Hardened and Polished
- H—Blued
- J—Nickel Plated Only
- K—Hardened and Nickel Plated
- L—Brass Plated
- M—Oxidized
- N—Japanned, Dull
- P—Japanned, Bright
- R—Merlized
- T—Copper Plated
- T. A.—Hardened, Polished, Copper and Nickel Plated and Buffed
- T. B.—Copper and Nickel Plated and Polished
- T. J.—Copper and Nickel Plated Only
- T. K.—Hardened, Copper and Nickel Plated
- T. M.—Copper Plated and Oxidized
- T. L.—Copper and Brass Plated
- U—Zinc Plated
- V—Silver Plated
- W—Polished and Nickel Plated
- Z—Chromium Plated
- Z. B.—Polished, Nickel Plated, Buffed and Chromium Plated
- Z. J.—Nickel and Chromium Plated

These letters **MUST BE USED** when they appear in the list; and **AFTER** the number **as** in the list.

In this series:
1 to 1500 and 50001 to 51500 are Screw Numbers
1501 to 1800 and 51501 to 51800 are Nut Numbers
1801 to 2000 and 51801 to 52000 are Roller Numbers
2001 to 50000 and 52001 and upward are numbers of Machine Parts

The figures in the second column refer only to the plates, illustrating the parts, and are **NOT TO BE USED** in ordering.

Parts marked with an asterisk (*) are furnished only when repairs are made at factory.

When ordering parts which differ as to **Gauge** (the distance between seams) the Gauge, as well as the **Number must be given** on order.

LIST OF PARTS COMPLETE

FOR

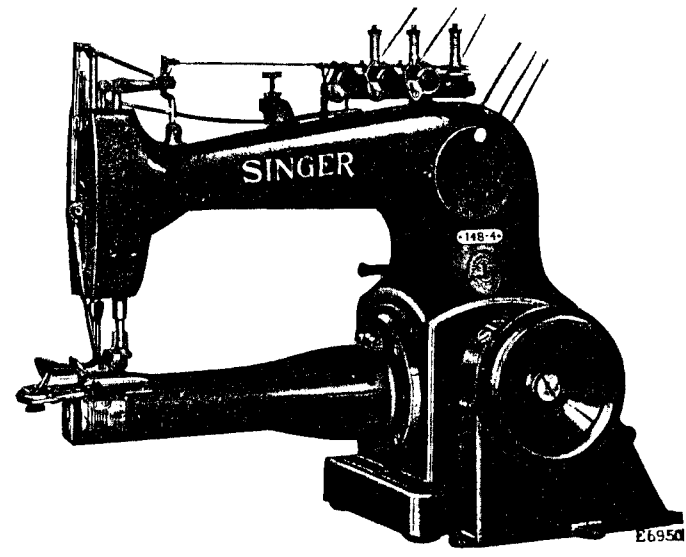

MACHINE No. 148-4

FOR THREE LINE STITCHING ON HEAVY OVERALLS AND WORK OF A SIMILAR NATURE. THREE NEEDLES, THREE LOOPERS, DOUBLE CHAIN STITCH. GAUGES 3/2 IN., 7/4 IN., 1/8 IN., 9/64 IN. AND 5/32 IN. BETWEEN EACH NEEDLE. DROP FEED, FOOT LIFTER.

FORMERLY 148SV2 MACHINE

NO.	PLATE	NAME
*128196	---	Arm.....
54913	9119	" Back Cover.....
54914	---	Arm Back Cover complete, Nos. 1538D, 50223D, 54913, 54915, 54916 and two 1443D.....
54915	9101	Arm Back Cover Latch with 911E.....
50223D	9117	" " " " Hinge Screw....
	911E	9101 " " " " Screw Stud
1538D	9101	" " " " " "
		Thumb Nut.....
54916	9101	Arm Back Cover Spring.....
1443D	9101	" " " " Screw.....

NO.	PLATE	NAME
54897	9101	Arm Oil Cup.....
128002	9119	" Rock Shaft.....
128003	9101	" " " Bushing (back).....
437c	9118	" " " " " Set Screw
128004	9101	" " " " (front).....
888c	9118	" " " " " Set Screw
54919	9101	" " " " (intermediate)
50224c	9118	" " " " " " Set Screw.....
54921	9101	Arm Rock Shaft Collar with two 456c..
456c	9101	" " " " " Set Screw.....
128262	9122	" " " Crank (back) with two 50083c, for 128264.....
128006	9122	Arm Rock Shaft Crank (back) with two 50083c, for 128021.....
50083c	9104	Arm Rock Shaft Crank (back) Set Screw
128007	9109	" " " " (front) with two 50135c.....
50135c	9104	Arm Rock Shaft Crank (front) Set Screw
56016	9123	" Side Cover.....
286d	9118	" " " Thumb Screw.....
128264	9124	Crank Connecting Rod complete, Nos. 217d, 1722e, 1723e, 54616, 54925, 55034 and 128267.....
*54925	—	Crank Connecting Rod (rod only).....
51043c	9122	" " " Ball Screw Stud
1597e	9118	" " " " " " Nut.....
67425	9122	Crank Connecting Rod Ball Screw Stud Nut Lock Washer.....
*54612	—	Crank Connecting Rod Cap (lower)....
896e	9117	" " " " " Screw
*28265	—	" " " " (upper)....
171e	9117	" " " " " Screw
*54614	—	" " " End Bearing (lower).....
*128266	—	Crank Connecting Rod End Bearing (upper).....
*54616	—	Crank Connecting Rod End Head (lower) Nos. 54612, 54614 and two 896e.....
*128267	—	Crank Connecting Rod Head (upper) Nos. 51043c, 128265, 128266 and two 171e.....
1722e	9122	Crank Connecting Rod Nut (lower)....
1723e	9122	" " " " (upper)....
55034	9101	" " " Position Plate...
217d	9117	" " " " " Screw

NO.	PLATE	NAME
*128197	—	Cylinder with 447c, 452c, 460c, 50150c, 54664, 128032, 128033 and two 391d..
54620	9101	Cylinder Dowel Pin.....
128306	9124	" End Cover.....
128270	—	Cylinder End Cover complete, Nos. 128128, 128306, two 128271, three 1231w and four 405d.....
128305	—	Cylinder End Cover complete, 128270 with 1174w, 36586, 36598 and two 211w, for 1/8 in. to 3/4 in. gauges.....
128271	9122	Cylinder End Cover Lock Spring.....
405d	9118	" " " " " Screw
*54625	—	" " " Slide (back).....
128128	9102	" " " " " 54625 with 54627 and 55165.....
50999f	9117	Cylinder End Cover Slide (back) Stop Screw.....
*55165	—	Cylinder End Cover Slide (front).....
54627	9102	" " " " " Hinge Pin.....
1231w	9118	Cylinder End Cover Slide (front) Screw
128198	9124	" Rock Shaft.....
128015	9102	" " " Bushing (back)....
1125c	9118	" " " " " Set Screw.....
128016	9102	Cylinder Rock Shaft Bushing (front)...
220b	9117	" " " " " Set Screw.....
128017	9102	Cylinder Rock Shaft Crank with two 1253c.....
1253c	9102	Cylinder Rock Shaft Crank Set Screw..
128018	9102	" " " Connection with 128019, 128020 and two each 152e and 175e.....
128272	—	Cylinder Rock Shaft Connection 128018 with 128038, 128041 and 128198.....
*128019	—	Cylinder Rock Shaft Connection Cap (large).....
152e	9102	Cylinder Rock Shaft Connection Cap (large) Screw.....
*128020	—	Cylinder Rock Shaft Connection Cap (small).....
175e	9102	Cylinder Rock Shaft Connection Cap (small) Screw.....
128021	9124	Cylinder Rock Shaft Connecting Rod complete, Nos. 1722e, 1723e, 128022, 128025 and 128026.....

NO.	PLATE	NAME
128022	---	Cylinder Rock Shaft Connecting Rod (rod only).....
50730c	9102	Cylinder Rock Shaft Connecting Rod Ball Screw Stud (lower).....
1664E	9118	Cylinder Rock Shaft Connecting Rod Ball Screw Stud (lower) Nut.....
50731c	9102	Cylinder Rock Shaft Connecting Rod Ball Screw Stud (upper).....
1597E	9118	Cylinder Rock Shaft Connecting Rod Ball Screw Stud (upper) Nut.....
*128023	---	Cylinder Rock Shaft Connecting Rod Cap (lower).....
171E	9117	Cylinder Rock Shaft Connecting Rod Cap (lower) Screw.....
*54613	---	Cylinder Rock Shaft Connecting Rod Cap (upper).....
171E	9117	Cylinder Rock Shaft Connecting Rod Cap (upper) Screw.....
*128024	---	Cylinder Rock Shaft Connecting Rod End Bearing (lower).....
*55032	---	Cylinder Rock Shaft Connecting Rod End Bearing (upper).....
125601	---	Cylinder Rock Shaft Connecting Rod End Bearing (upper) 55032 with 54613 and two 171E.....
128025	---	Cylinder Rock Shaft Connecting Rod Head (lower), Nos. 50730c, 128023, 128024 and two 171E.....
128026	---	Cylinder Rock Shaft Connecting Rod Head (upper), Nos. 217D, 50731c, 55034 and 125601.....
1722E	9122	Cylinder Rock Shaft Connecting Rod Nut (lower).....
1723E	9122	Cylinder Rock Shaft Connecting Rod Nut (upper).....
55034	9101	Cylinder Rock Shaft Connecting Rod Position Plate.....
217D	9117	Cylinder Rock Shaft Connecting Rod Position Plate Screw.....
128027	---	Cylinder Rock Shaft Eccentric.....
50589c	9109	" " " " Regulating Screw.....
198D	9109	Cylinder Rock Shaft Eccentric Set Screw
134D	9117	" Screw.....
128199	9122	" Thread Eyelet.....
128268	---	" " " 128199 with 662D, 128200 and 128241.....

NO.	PLATE	NAME
128200	9122	Cylinder Thread Eyelet Thread Guard
662D	9122	" " " " "
		Screw.....
1402D	9117	Cylinder Thread Eyelet Screw.....
128030	9102	" " Guard.....
1302D	9118	" " " Screw.....
128031	9124	" " Tube.....
128032	9124	" Top Cover (back).....
54664	9109	" " " " Hinge Pin..
460c	9118	" " " " " " "Set Screw.....
128033	9123	Cylinder Top Cover (front) with 233D and 128034.....
391D	9118	Cylinder Top Cover (front) Screw.....
128034	9109	" " " " Spring.....
233D	9117	" " " " " Screw
128201	9123	Face Plate.....
46111	9102	" " Pin.....
286D	9118	" " Thumb Screw.....
50732c	9117	Feed Adjusting Screw (eccentric).....
1735D	9118	" " " Nut.....
128202	9125	" Dog, 10 teeth (8 teeth to the inch) for $\frac{1}{8}$ in., $\frac{3}{64}$ in. and $\frac{5}{32}$ in. gauges between needles.....
128348	9126	Feed Dog, 18 teeth (16 teeth to the inch) for $\frac{3}{32}$ in. and $\frac{1}{8}$ in. gauges between needles
128369	9125	Feed Dog, 18 teeth (16 teeth to the inch) for $\frac{1}{8}$ in. and $\frac{3}{64}$ in. gauges between needles
128412	9703	Feed Dog, 12 teeth (8 teeth to the inch) for $\frac{1}{8}$ in., $\frac{3}{64}$ in. and $\frac{5}{32}$ in. gauges between needles, for heavy work.....
NOTE: When ordering Nos. 128202, 128348, 128369 and 128412, state gauge.		
50128c	9117	Feed Dog Screw.....
128038	9112	" Connecting Rod with 128039 and two 896E.....
*128039	---	Feed Connecting Rod Cap.....
896E	9117	" " " " Screw.....
*128040	---	" Eccentric.....
128041	9109	Feed Eccentric (adjustable) complete, Nos. 198D, 50589c, 128027, 128040 and 128174.....
*128174	---	Feed Eccentric Body with two 1143c...
1143c	9109	" " " " Set Screw.....
128203	9122	" Lifting Eccentric with two 462c...
128273	---	" " " 128203 with 54953

NO.	PLATE	NAME
462c	9118	Feed Lifting Eccentric Set Screw.....
128043	9112	“ “ Lever.....
54953	9109	“ “ “ Connecting Rod with 54940 and two 896E.....
*54940	—	Feed Lifting Lever Connecting Rod Cap
896E	9117	“ “ “ “ “ “ Screw.....
50997c	9117	Feed Lifting Lever Connecting Rod Hinge Screw (eccentric).....
1722E	9122	Feed Lifting Lever Connecting Rod Hinge Screw Nut.....
128044	9102	Feed Lifting Lever Hinge Pin.....
452c	9122	“ “ “ “ “ Set Screw
128045	9109	“ Regulator.....
54958	9102	“ “ Friction Spring.....
128046	9109	“ “ Pawl with two 453c....
128047	9123	“ “ “ Lever with 448c....
448c	9116	“ “ “ “ Set Screw..
128048	9102	“ “ “ “ Stud.....
42833	9102	“ “ “ “ “ Spring
453c	9116	“ “ “ Set Screw.....
128049	9102	“ “ Pawl Shaft.....
128050	9112	“ Rod.....
128051	9102	“ “ Connecting Link (left).....
128052	9102	“ “ “ “ (right).....
50733c	9117	“ “ “ “ Hinge Screw
1735J	9118	“ “ “ “ “ “ Nut.....
128053	9122	Feed Rod Hinge Bracket with 50150c.,
128054	9127	“ “ “ “ Hinge Pin....
50150c	9116	“ “ “ “ “ “ Set Screw.....
128055	9102	Feed Rod Hinge Pin.....
50150c	9116	“ “ “ “ “ Set Screw.....
*128334	—	Hand Wheel.....
128335	9137	“ “ and pulley, Nos. 128334, 128337 and two 50084c.....
50084c	9122	Hand Wheel and Pulley Set Screw.....
128336	9128	“ “ “ “ Shaft.....
128340	—	“ “ “ “ “ 128336 with 541616.....
128275	—	Hand Wheel and Pulley Shaft 128340 with 128045, 128272 and 128273.....
54968	9112	Hand Wheel and Pulley Shaft Bushing (right).....
41128	9127	Hand Wheel and Pulley Shaft Bushing (right) Oil Pad (braided cotton).....

NO.	PLATE	NAME
888c	9118	Hand Wheel and Pulley Shaft Bushing (right) Set Screw.....
128388	9127	Hand Wheel and Pulley Shaft Flanged Bushings (left).....
42365	9127	Hand Wheel and Pulley Shaft Flanged Bushings (left) Oil Pad (braided cotton)
445c	9122	Hand Wheel and Pulley Shaft Flanged Bushings (left) Set Screw.....
150D	9127	Hand Wheel and Pulley Shaft Screw....
54970	9101	“ “ “ “ “ Washer...
128413	9127	Looper (back).....
128414	9127	“ (centre).....
128415	9127	“ (front).....
128349	9127	“ Carrier with 1454c, for 128351 and 128413.....
128350	9127	Looper Carrier for 128351 and 128414..
128351	—	“ “ (double adjustable), Nos. 128349 and 128350.....
128208	9127	Looper Carrier (single) with 1454c, for 128415.....
1454c	9127	Looper Carrier Clamping Screw.....
223D	9127	“ Screw.....
54708	9112	Needle Bar (hollow).....
128209	—	Needle Bar complete, Nos. 54708 and 128215.....
54710	9129	Needle Bar Bushing (lower).....
563c	9118	“ “ “ “ Set Screw..
54710	9129	“ “ “ (upper).....
563c	9118	“ “ “ “ Set Screw.
*54711	9129	“ “ Connecting Link.....
128274	—	“ “ “ “ 54711 with 54712 and 128210.....
54712	9129	Needle Bar Connecting Link Hinge Stud
1520J	9118	“ “ “ “ “ “ Nut.....
128117	9129	Needle Bar Connecting Stud with 207E.
207E	9129	“ “ “ “ Clamping Screw.....
128210	—	Needle Bar Connecting Stud complete, Nos. 220D, 10107, 128117, 128211, 128213, 128214 and two each 42348 and 128212.....
128211	9129	Needle Bar Thread Retainer Bracket with two 238D.....
220D	9117	Needle Bar Thread Retainer Bracket Screw.....

NO.	PLATE	NAME
42348	9129	Needle Bar Thread Retainer Disc.....
128212	9129	“ “ “ “ Separating Disc.....
10107	9129	Needle Bar Thread Retainer Spring....
128213	9129	“ “ “ “ Stud.....
238d	9129	“ “ “ “ “ Set Screw.....
128214	9129	Needle Bar Thread Retainer Thread Guide.....
238d	9129	Needle Bar Thread Retainer Thread Guide Set Screw.....
128215	9129	Needle Clamp with three 1498F.....
NOTE: When ordering No. 128215, state gauge.		
128352	9129	Needle Guard for $\frac{3}{32}$ in. and $\frac{7}{64}$ in. gauges
128216	9129	“ “ “ $\frac{1}{8}$ in., $\frac{9}{64}$ in. and $\frac{5}{32}$ in. gauges.....
NOTE: When ordering Nos. 128216 and 128352 state gauge.		
447c	9118	Needle Guard Set Screw.....
1498F	9129	“ Set Screw.....
55084	9130	Presser Bar (lower).....
128064	9130	“ “ “ Bushing.....
563c	9118	“ “ “ “ Set Screw..
128065	9128	“ “ (upper).....
128066	9130	“ “ “ Guide Bracket with 440c.....
440c	9104	Presser Bar (upper) Guide Bracket Set Screw.....
128067	9116	Presser Bar Connecting Bracket with 448c and 453c.....
448c	9116	Presser Bar Connecting Bracket Set Screw (long).....
453c	9116	Presser Bar Connecting Bracket Set Screw (short).....
128068	9130	Presser Bar Lifter.....
128069	9130	“ “ “ Connecting Link
50116F	9117	“ “ “ “ “ Hinge Screw (lower).....
108F	9117	Presser Bar Lifter Connecting Link Hinge Screw (upper).....
50115c	9117	Presser Bar Lifter Hinge Screw.....
2269	9130	“ “ “ Stop Pin (lower)....
2049	9130	“ “ “ “ “ (upper)....
128070	9128	“ “ Lifting Lever.....
128071	9112	“ “ “ “ Extension

NO.	PLATE	NAME
161c	9117	Presser Bar Lifting Lever Extension Screw.....
866d	9117	Presser Bar Lifting Lever Hinge Screw..
184d	9130	“ “ “ “ Stop Screw...
128186	9128	“ “ Spring (flat).....
54722	9130	“ “ “ Stud.....
128188	—	“ Foot Leveling Plate.....
NOTE: When ordering No. 128188, state gauge.		
11184	9129	Presser Foot Leveling Plate Hinge Pin..
128367	9129	“ “ “ “ Spring.....
128217	—	“ “ Needle Plate.....
NOTE: When ordering No. 128217, state gauge.		
128191	9129	Presser Foot Needle Plate Spring.....
655c	9139	“ “ “ “ “ Screw.
128368	9129	“ “ “ “ “ St o p
1368J	9129	“ “ “ “ “ “ Screw.....
128192	—	Presser Foot Plate.....
NOTE: When ordering No. 128192, state gauge.		
128193	—	Presser Foot Shank.....
50594c	9118	“ “ “ Screw.....
128219	9126	Presser Foot (hinged) complete, for $\frac{1}{8}$ in., $\frac{9}{64}$ in. and $\frac{5}{32}$ in. gauges, Nos. 1368J, 11184, 128188, 128192, 128193, 128217, 128367, 128368 and two each 665c, 50594c and 128191.....
NOTE: When ordering No. 128219, state gauge.		
128353	—	Presser Foot Leveling Plate.....
NOTE: When ordering No. 128353, state gauge.		
11184	9129	Presser Foot Leveling Plate Hinge Pin..
128416	9127	“ “ “ “ Spring.....
128354	—	“ “ Needle Plate.....
NOTE: When ordering No. 128354, state gauge.		
128191	9129	Presser Foot Needle Plate Spring.....
665c	9139	“ “ “ “ “ Screw.
128368	9129	“ “ “ “ “ St o p
1368J	9129	“ “ “ “ “ “ Screw.....
128355	—	Presser Foot Plate.....
NOTE: When ordering No. 128355, state gauge.		

NO.	PLATE	NAME
128356	---	Presser Foot Shank.....
50594c	9118	" " " Screw.....
128357	9126	Presser Foot (hinged) complete for $\frac{3}{32}$ in. and $\frac{1}{8}$ in. gauges, Nos. 13681, 11184, 128353 to 128356, 128368, 128416 and two each 665c, 50594 and 128191.....

NOTE: When ordering No. 128357, state gauge.

128370	---	Presser Foot Leveling Plate.....
--------	-----	----------------------------------

NOTE: When ordering No. 128370, state gauge.

11184	9129	Presser Foot Leveling Plate Hinge Pin..
128417	9127	" " " " Spring.....
128371	---	" " Needle Plate.....

NOTE: When ordering No. 128371, state gauge.

128372	9129	Presser Foot Needle Plate Spring (left)
665c	9139	" " " " " " Screw.....
128368	9129	Presser Foot Needle Plate Spring (left) Stop.....
13681	9129	Presser Foot Needle Plate Spring (left) Stop Screw.....
128373	9129	Presser Foot Needle Plate Spring (right)
665c	9129	" " " " " " Screw.....

128374	---	Presser Foot Plate.....
--------	-----	-------------------------

NOTE: When ordering No. 128374, state gauge.

128356	---	Presser Foot Shank.....
50594c	9118	" " " Screw.....
128375	9126	Presser Foot (hinged) complete for $\frac{1}{8}$ in. and $\frac{3}{16}$ in. gauges, Nos. 13681, 11184, 128356, 128368, 128370 to 128374, 128417 and two each 665c and 50594c

NOTE: When ordering No. 128375, state gauge.

190b	9117	Presser Foot Screw.....
50132w	9118	Pressure Regulating Thumb Screw.....
1543w	9118	" " " " Lock Nut.....
*128337	---	Pulley, 27 $\frac{1}{8}$ in. diam.....
128220	9128	Tension (under thread) Bracket.....
128269	---	" " " " 128220 with 233b, 1144b, 50076b, 63824, 128077, 128221, 128222 and two 337b.
176b	9117	Tension (under thread) Bracket Screw..
2102	9131	" " " Disc.....

NO.	PLATE	NAME
51570c	9131	Tension (under thread) Regulating Thumb Nut.....
128221	9131	Tension (under thread) Releaser (lower)
233b	9117	" " " " " Adjusting Screw.....
50076b	9117	Tension (under thread) Releaser (lower) Hinge Screw.....
128222	9131	Tension (under thread) Releaser (upper)
337b	9131	" " " " " Screw.....
32572	9131	Tension (under thread) Releasing Disc
128077	9128	" " " " " Lever
63824	9131	" " " " " Spring.....
1144b	9117	Tension (under thread) Releasing Lever Spring Screw.....
128078	9131	Tension (under thread) Releasing Pin...
50326c	9131	" " " " " Screw Stud....
59539	---	" " " " " 50326c with 51570c.....
59534	9131	Tension (under thread) Spring.....
59537	9131	" " " " " Bushing (large).....
59538	9131	Tension (under thread) Spring Bushing (small).....
17547	9131	Tension (under thread) Thread Guide
128223	9135	" (upper thread) Bracket with three 447c.....
376b	9118	Tension (upper thread) Bracket Screw..
128224	9131	" " " " " Thread Eyelet (double).....
330b	9118	Tension (upper thread) Bracket Thread Eyelet Screw.....
128081	9131	Tension (upper thread) Bracket Thread Eyelet Screw Washer.....
2102	9131	Tension (upper thread) Disc.....
51570c	9131	" " " " " Regulating Thumb Nut.....
32572	9131	Tension (upper thread) Releasing Disc...
128225	9131	" " " " " Pin....
128226	9135	" " " " " Shaft
128227	9131	" " " " " Collar with two 735c.....
735c	9131	Tension (upper thread) Releasing Shaft Collar Set Screw.....
128228	9132	Tension (upper thread) Releasing Shaft Crank with 457c.....

NO.	PLATE	NAME
54873	9132	Tension (upper thread) Releasing Shaft Crank Link.....
128229	9132	Tension (upper thread) Releasing Shaft Crank Link Bracket.....
330b	9118	Tension (upper thread) Releasing Shaft Crank Link Bracket Screw.....
51034c	9131	Tension (upper thread) Releasing Shaft Crank Link Hinge Screw (lower).....
110c	9117	Tension (upper thread) Releasing Shaft Crank Link Hinge Screw (upper).....
457c	9132	Tension (upper thread) Releasing Shaft Crank Set Screw.....
39302	9132	Tension (upper thread) Releasing Shaft Crank Spring.....
170e	9131	Tension (upper thread) Releasing Shaft Crank Spring Screw Stud.....
50326c	9131	Tension (upper thread) Screw Stud.....
59539	---	" " " " " 50326c with 51570c.....
59536	9131	Tension (upper thread) Spring.....
59537	9131	" " " " Bushing (large).....
59538	9131	Tension (upper thread) Spring Bushing (small).....
17547	9131	Tension (upper thread) Thread Guide..
128083	9135	" Releasing Arm with 51818.....
128084	9135	" " " " Connecting Rod
1521E	9118	" " " " " " Nut.....
1131c	9117	Tension Releasing Arm Hinge Screw....
51818	9132	" " " " Roller and Screw Stud.....
128230	9132	Thread (under) Eyelet.....
620c	9118	" " " " Set Screw.....
128387	9132	" " " " Guide.....
335d	9118	" " " " Screw.....
128235	9132	" " " " Nipper Cam with 61121 and two 465c.....
128087	---	Thread (under) Nipper Cam Oil Pad (felt).....
128088	---	Thread (under) Nipper Cam Oil Pad Holder.....
128089	9132	Thread (under) Nipper Cam Oil Pad Holder 128088 with 128087.....
465c	9133	Thread (under) Nipper Cam Set Screw..
128236	9134	" " " " Spring (lower)..
128237	9134	" " " " " (upper)..

NO.	PLATE	NAME
334d	9118	Thread (under) Nipper Spig Screw...
128238	9134	" " " Protector.....
228d	9134	" " " " Screw.....
128239	9134	" " " Pull-off.....
226d	9117	" " " " Adjusting Screw
61121	9132	" " " " Position Pin....
128240	9134	" " " " Stripper.....
329d	9132	" " " " " Screw
128081	9131	" " " " " " Washer.....
128241	9134	Thread (under) Separator.....
128242	9134	" " " Take-up with two 465c.
128243	9135	" " " " Frame.....
128298	---	Thread (under) Take-up Frame complete, Nos. 128105, 128243 and 128299.....
*128299	9135	Thread (under) Take-up Frame Cover with 50150c.....
128105	9134	Thread (under) Take-up Frame Cover Hinge Pin.....
50150c	9116	Thread (under) Take-up Frame Cover Hinge Pin Set Screw.....
1149d	9134	Thread (under) Take-up Frame Screw..
128246	9133	" " " " Knife.....
128247	9133	" " " " " Holder with 465c.....
185d	9117	Thread (under) Take-up Knife Holder Screw.....
465c	9133	Thread (under) Take-up Knife Set Screw
465c	9133	" " " " Set Screw.....
128248	9133	" " " " Stripper.....
128098	9133	" " " " " Bracket
1364c	9117	" " " " " " Screw.....
330d	9118	Thread (under) Take-up Stripper Screw
128081	9131	" " " " " " Washer.....
128249	9133	Thread (under) Take-up Thread Guard with 220d.....
128100	9133	Thread (under) Take-up Thread Guard Bracket.....
1364c	9117	Thread (under) Take-up Thread Guard Bracket Screw.....
1137E	9118	Thread (under) Take-up Thread Guard Hinge Screw.....
128101	9133	Thread (under) Take-up Thread Guard Spring.....

NO.	PLATE	NAME
335D	9118	Thread (under) Take-up Thread Guard Spring Screw.....
220D	9117	Thread (under) Take-up Thread Guard Stop Screw.....
128250	9133	Thread (upper) Controller.....
125564	9133	" " " Lever with 50138E.....
54879	9135	Thread (upper) Controller Lever Connection.....
999F	9117	Thread (upper) Controller Lever Connection Hinge Screw (lower).....
999F	9117	Thread (upper) Controller Lever Connection Hinge Screw (upper).....
1700E	9118	Thread (upper) Controller Lever Connection Hinge Screw (upper) Nut....
125566	9133	Thread (upper) Controller Lever Hinge Stud.....
465c	9133	Thread (upper) Controller Lever Hinge Stud Set Screw.....
125567	9133	Thread (upper) Controller Lever Post with 465c.....
443c	9118	Thread (upper) Controller Lever Post Set Screw.....
50138F	9133	Thread (upper) Controller Set Screw...
128250	9133	" " " Thread Guide
128251	9136	" " " " " Post with 50138D.....
175F	9133	Thread (upper) Controller Thread Guide Post Screw.....
50138D	9133	Thread (upper) Controller Thread Guide Set Screw.....
128110	9136	Thread (upper) Check Spring.....
128111	9136	" " " " Adjusting Plate.....
226D	9117	Thread (upper) Check Spring Adjusting Plate Screw.....
128112	9101	Thread (upper) Check Spring Regulating Stud.....
447c	9118	Thread (upper) Check Spring Regulating Stud Set Screw.....
128252	9136	Thread (upper) Take-up.....
217D	9117	" " " Screw.....
128253	9136	" " " Stripper.....
128254	9136	" " " " Bracket
1492D	9117	" " " " " Screw.....
226D	9117	Thread (upper) Take-up Stripper Screw

NO.	PLATE	NAME
128255	9125	Throat Plate for 128202.....
128358	9126	" " " 128348.....
128376	9125	" " " 128369.....
128418	9703	" " " 128412.....
1319F	9118	" " " Screw.....

NOTE: When ordering Nos. 128255, 128358, 128376 and 128412, state gauge.

Genuine Singer Needles and their Containers are marked with the Company's Trade Mark "SIMANCO." 1

Needles in Containers marked "For Singer Machines" are not Singer made needles. 2

LIST OF PARTS COMPLETE

FOR

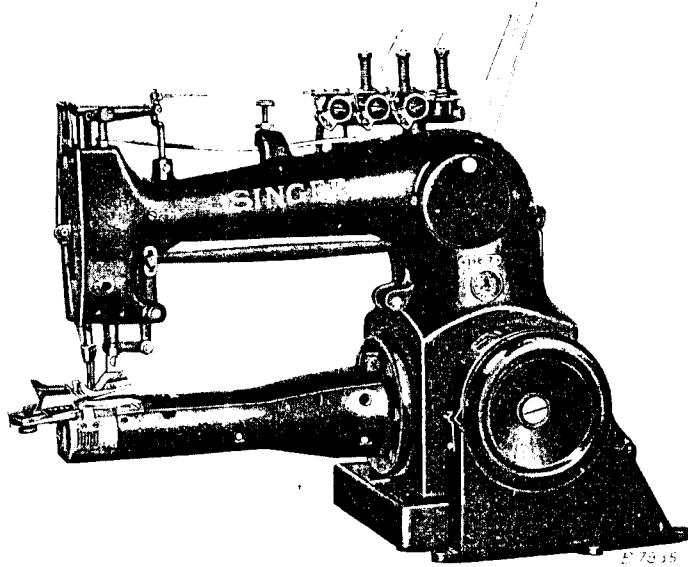

MACHINE No. 148-7

FOR THREE LINE STITCHING ON OVERALLS. THREE NEEDLES, THREE LOOPERS, DOUBLE CHAIN STITCH, GAUGES $\frac{1}{8}$, $\frac{3}{16}$ AND $\frac{1}{2}$ INCH BETWEEN EACH NEEDLE. UPPER AND UNDER FEED, LENGTH OF STITCH UP TO 6 TO THE INCH.

FORMERLY 148 SV 9 MACHINE

NO.	PLATE	NAME
*128389	---	Arm.....
54913	9119	" Back Cover.....
54914	---	Arm Back Cover complete, Nos. 1538d, 50223d, 54913, 54915, 54916 and two 1443d.....
54915	9101	Arm Back Cover Latch with 911E.....
50223d	9117	" " " " Hinge Screw..
	911E	" " " " Screw Stud
1538d	9101	" " " " " "
		Thumb Nut.....

NO.	PLATE	NAME
54916	9101	Arm Back Cover Spring.....
1443d	9101	" " " " Screw.....
54897	9101	" Oil Cup.....
128136	9119	" Rock Shaft.....
128003	9101	" " " Bushing (back).....
437c	9118	" " " " " Set Screw.....
128004	9101	Arm Rock Shaft Bushing (front).....
888c	9118	" " " " " Set Screw.....
54919	9101	Arm Rock Shaft Bushing (intermediate)
50224c	9118	" " " " " Set Screw.....
54921	9101	Arm Rock Shaft Collar with two 456c..
456c	9101	" " " " Set Screw.....
128262	9122	" " " Crank (back) with two 50083c, for 128264.....
128006	9122	Arm Rock Shaft Crank (back) with two 50083c, for 128021.....
50083c	9104	Arm Rock Shaft Crank (back) Set Screw
128138	9104	" " " " (front) with 128145 and two 50135c.....
50135c	9104	Arm Rock Shaft Crank (front) Set Screw
56016	9123	" Side Cover.....
286d	9118	" " " Thumb Screw.....
128264	9124	Crank Connecting Rod complete, Nos. 217d, 1722e, 1723e, 54616, 54925, 55034 and 128267.....
*54925	---	Crank Connecting Rod (rod only).....
51043c	9122	" " " Ball Screw Stud
1597e	9118	" " " " " " " "
		Nut.....
67425	9122	Crank Connecting Rod Ball Screw Stud Nut Lock Washer.....
*54612	---	Crank Connecting Rod Cap (lower).....
896e	9117	" " " " " Screw
*128265	---	" " " " " (upper).....
171e	9117	" " " " " Screw
*54614	---	" " " End Bearing (lower).....
128266	---	Crank Connecting Rod End Bearing (upper).....
*54616	---	Crank Connecting Rod Head (lower), Nos. 54612, 54614 and two 896e.....
*128267	---	Crank Connecting Rod Head (upper), Nos. 51043c, 128265, 128266 and two 171e.....

NO.	PLATE	NAME
1722E	9122	Crank Connecting Rod Nut (lower)....
1723E	9122	" " " " (upper)....
55034	9101	" " " " Position Plate
217D	9117	" " " " " "
		Screw.....
*128197	—	Cylinder with 447c, 452c, 460c, 50150c, 54664, 128032, 128033 and two 391d...
54620	9101	Cylinder Dowel Pin.....
128011	9124	" End Cover.....
128012	—	Cylinder End Cover complete, Nos. 128011, 128128, two 128013 three 1231w and four 405d.....
128127	—	Cylinder End Cover complete 128012 with 1174w, 36586, 36598 and two 211w.....
128013	9101	Cylinder End Cover Lock Spring.....
405D	9118	" " " " " " Screw
*54625	—	" " " " Slide (back).....
128128	9102	" " " " " " 54625 with 54627 and 55165.....
50999F	9117	Cylinder End Cover Slide (back) Stop Screw.....
*55165	—	Cylinder End Cover Slide (front).....
54627	9102	" " " " " " Hinge Pin.....
1231W	9118	Cylinder End Cover Slide (front) Screw
128198	9124	" Rock Shaft.....
128015	9102	" " " " Bushing (back)....
1125C	9118	" " " " " " Set Screw.....
128016	9102	Cylinder Rock Shaft Bushing (front)....
220D	9117	" " " " " " Set Screw.....
128017	9102	Cylinder Rock Shaft Crank with two 1253c.....
1253C	9102	Cylinder Rock Shaft Crank Set Screw..
128018	9102	" " " " Connection with 128019, 128020 and two each 152E and 175E.....
128403	—	Cylinder Rock Shaft Connection 128018 with 128041, 128140 and 128198.....
*128019	—	Cylinder Rock Shaft Connection Cap (large).....
152E	9102	Cylinder Rock Shaft Connection Cap (large) Screw.....
*128020	—	Cylinder Rock Shaft Connection Cap (small).....

NO.	PLATE	NAME
175E	9102	Cylinder Rock Shaft Connection Cap (small) Screw.....
128021	9124	Cylinder Rock Shaft Connecting Rod complete, Nos. 1722E, 1723E, 128022 128025 and 128026.....
128022	—	Cylinder Rock Shaft Connecting Rod (rod only).....
50730C	9102	Cylinder Rock Shaft Connecting Rod Ball Screw Stud (lower).....
1664E	9118	Cylinder Rock Shaft Connecting Rod Ball Screw Stud (lower) Nut.....
50731C	9102	Cylinder Rock Shaft Connecting Rod Ball Screw Stud (upper).....
1597E	9118	Cylinder Rock Shaft Connecting Rod Ball Screw Stud (upper) Nut.....
*128023	—	Cylinder Rock Shaft Connecting Rod Cap (lower).....
171E	9117	Cylinder Rock Shaft Connecting Rod Cap (lower) Screw.....
*54613	—	Cylinder Rock Shaft Connecting Rod Cap (upper).....
171E	9117	Cylinder Rock Shaft Connecting Rod Cap (upper) Screw.....
*128024	—	Cylinder Rock Shaft Connecting Rod End Bearing (lower).....
*55032	—	Cylinder Rock Shaft Connecting Rod End Bearing (upper).....
125601	—	Cylinder Rock Shaft Connecting Rod End Bearing (upper) 55032 with 54613 and two 171E.....
128025	—	Cylinder Rock Shaft Connecting Rod Head (lower), Nos. 50730c, 128023, 128024 and two 171E.....
128026	—	Cylinder Rock Shaft Connecting Rod Head(upper), Nos. 217D, 50731c, 55034 and 125601.....
1722E	9122	Cylinder Rock Shaft Connecting Rod Nut (lower).....
1723E	9122	Cylinder Rock Shaft Connecting Rod Nut (upper).....
55034	9101	Cylinder Rock Shaft Connecting Rod Position Plate.....
217D	9117	Cylinder Rock Shaft Connecting Rod Position Plate Screw.....
128027	—	Cylinder Rock Shaft Eccentric.....
50589C	9109	" " " " " " Regulating Screw.....

NO.	PLATE	NAME
198D	9109	Cylinder Rock Shaft Eccentric Set Screw
134D	9117	" " Screw.....
128199	9122	" " Thread Eyelet.....
128268	-----	" " " " 128199 with 662D, 128200 and 128241.....
128200	9122	Cylinder Thread Eyelet Thread Guard
662D	9122	" " " " " "
		Screw.....
1402D	9117	Cylinder Thread Eyelet Screw.....
128030	9102	" " " Guard.....
1302D	9118	" " " " Screw.....
128031	9124	" " " Tube.....
128032	9124	" " Top Cover (back).....
54664	9109	" " " " " Hinge Pin
460C	9118	" " " " " " "
		Set Screw.....
128033	9123	Cylinder Top Cover (front) with 233D and 128034.....
391D	9118	Cylinder Top Cover (front) Screw.....
128034	9109	" " " " " Spring.....
233D	9117	" " " " " " Screw
128201	9123	Face Plate.....
46111	9102	" " " Pin.....
286D	9118	" " " Thumb Screw.....
50732C	9117	Feed (lower) Adjusting Screw (eccentric)
1735J	9118	" " " " " Nut.....
128140	9123	" " " Connection with 128039 and two 896E.....
128039	-----	Feed (lower) Connection Cap.....
896E	9117	" " " " " Screw....
128202	9125	" " " Dog, 10 teeth (8 teeth to the inch) for $\frac{1}{8}$ in., $\frac{3}{16}$ in. and $\frac{5}{32}$ in. gauges between needles
128412	9703	Feed (lower) Dog, 12 teeth (8 teeth to the inch) for $\frac{1}{8}$ in., $\frac{3}{16}$ in. and $\frac{5}{32}$ in. gauges between needles, for heavy work.....
NOTE: When ordering Nos. 128202 and 128412, state gauge.		
50128C	9117	Feed (lower) Dog Screw.....
128040	-----	" " " Eccentric.....
*128174	-----	" " " " Body with two 1143C.....
1143C	9109	Feed (lower) Eccentric Body Set Screw
128011	9109	Feed (lower) Eccentric (adjustable) complete, Nos. 198D, 50589C, 128027, 128040 and 128174.....

NO.	PLATE	NAME
128042	9109	Feed (lower) Lifting Eccentric with two 462C.....
128122	-----	Feed (lower) Lifting Eccentric 128042 with 54953.....
462C	9118	Feed (lower) Lifting Eccentric Set Screw
128043	9112	" " " " Lever.....
54953	9109	" " " " " Connecting Rod with 54940 and two 896E.....
*54940	-----	Feed (lower) Lifting Lever Connecting Rod Cap.....
896E	9117	Feed (lower) Lifting Lever Connecting Rod Cap Screw.....
50997C	9117	Feed (lower) Lifting Lever Connecting Rod Hinge Screw (eccentric).....
1722E	9122	Feed (lower) Lifting Lever Connecting Rod Hinge Screw Nut.....
128044	9102	Feed (lower) Lifting Lever Hinge Pin
452C	9122	" " " " " " "
		Set Screw.....
128045	9109	Feed (lower) Regulator.....
54958	9102	" " " " Friction Spring
128046	9109	" " " " Pawl with two 453C.....
128047	9123	Feed (lower) Regulator Pawl Lever with 448C.....
448C	9116	Feed (lower) Regulator Pawl Lever Set Screw.....
128048	9102	Feed (lower) Regulator Pawl Lever Stud
42833	9102	" " " " " " "
		Spring.....
453C	9116	Feed (lower) Regulator Pawl Set Screw
128049	9102	" " " " " Shaft.....
128050	9112	" " " Rod.....
128051	9102	" " " " Connecting Link (left).....
128052	9102	Feed (lower) Rod Connecting Link (right).....
50733C	9117	Feed (lower) Rod Connecting Link Hinge Screw.....
1735J	9118	Feed (lower) Rod Connecting Link Hinge Screw Nut.....
128053	9122	Feed (lower) Rod Hinge Bracket with 50150C.....
128054	9127	Feed (lower) Rod Hinge Bracket Hinge Pin.....
50150C	9116	Feed (lower) Rod Hinge Bracket Hinge Pin Set Screw.....

NO.	PLATE	NAME
128055	9102	Feed (lower) Rod Hinge Pin.....
50150c	9116	" " " " " Set Screw
128141	9116	" (upper) Bar.....
128142	9116	" " " Bell Crank (forked) ..
1467d	9116	" " " " " Cap Screw
128143	9116	" " " " " Connecting Link.....
128144	9116	Feed (upper) Bar Bell Crank Connecting Link Hinge Stud (left).....
1520E	9118	Feed (upper) Bar Bell Crank Connecting Link Hinge Stud (left Nut).....
128145	9104	Feed (upper) Bar Bell Crank Connecting Link Hinge Stud (right).....
125504	9116	Feed (upper) Bar Bell Crank Slide Block
128146	9116	" " " Hinge Bracket with two 50150c.....
50150c	9116	Feed (upper) Bar Hinge Bracket Set Screw.....
51021c	9117	Feed (upper) Bar Hinge Screw.....
1700E	9118	" " " " " Nut.....
128148	9104	" " Regulator.....
125510	9104	" " " Connecting Link.....
51004c	9117	Feed (upper) Regulator Connecting Link Hinge Screw (back).....
1651E	9118	Feed (upper) Regulator Connecting Link Hinge Screw (back) Nut.....
907d	9117	Feed (upper) Regulator Connecting Link Hinge Screw (front).....
128149	9101	Feed (upper) Regulator Hinge Stud....
50150c	9116	" " " " " Set Screw.....
128150	9123	Feed (upper) Regulator Pitman.....
128151	9123	" " " " " Connection with 193F.....
125514	9104	Feed (upper) Regulator Pitman Connection Bracket.....
125515	9104	Feed (upper) Regulator Pitman Connection Bracket Hinge Pin.....
452c	9122	Feed (upper) Regulator Pitman Connection Bracket Hinge Pin Set Screw....
125516	9104	Feed (upper) Regulator Pitman Connection Hinge Pin.....
193F	9117	Feed (upper) Regulator Pitman Connection Hinge Pin Set Screw.....
128152	9116	Feed (upper) Regulator Pitman Connection Hinge Stud.....

NO.	PLATE	NAME
1520E	9118	Feed (upper) Regulator Pitman Connection Hinge Stud Nut.....
829c	9118	Feed (upper) Regulator Pitman Connection Hinge Screw.....
1520E	9118	Feed (upper) Regulator Pitman Connection Hinge Screw Nut.....
51005c	9117	Feed (upper) Regulator Screw Stud....
1669c	9118	" " " " " Nut
39541	9116	" " " " " Washer.....
128390	9122	Feeding Foot Hinge Stud.....
664w	9122	" " " " Stop Screw...
128391	—	" " Plate.....
NOTE: When ordering No. 128391, state gauge.		
128392	—	Feeding Foot Shank.....
128393	9126	Feeding Foot (hinged) complete, Nos. 128391, 128392 and two each 664w and 128390.....
NOTE: When ordering No. 128393, state gauge.		
203d	9117	Feeding Foot Screw.....
*128334	—	Hand Wheel.....
128335	9137	" " and Pulley, Nos. 128334, 128337 and two 50084c.....
50084c	9122	Hand Wheel and Pulley Set Screw.....
128336	9128	" " " " Shaft.....
128340	—	" " " " " 128336 with 54616.....
128404	—	Hand Wheel and Pulley Shaft 128340 with 128045, 128122 and 128403.....
54968	9112	Hand Wheel and Pulley Shaft Bushing (right).....
41128	9127	Hand Wheel and Pulley Shaft Bushing (right) Oil Pad (braided cotton).....
888c	9118	Hand Wheel and Pulley Shaft Bushing (right) Set Screw.....
128388	9127	Hand Wheel and Pulley Shaft Flanged Bushing (left).....
42365	9127	Hand Wheel and Pulley Shaft Flanged Bushing (left) Oil Pad (braided cotton)
445c	9122	Hand Wheel and Pulley Shaft Flanged Bushing (left) Set Screw.....
150d	9127	Hand Wheel and Pulley Shaft Screw....
54970	9101	" " " " " Washer..
128158	9130	Lifting Presser Bar (lower).....
128159	9130	" " " " Bushing....

NO.	PLATE	NAME
563c	9118	Lifting Presser Bar (lower) Bushing Set Screw.....
128160	9130	Lifting Presser Bar (lower) Guide Bracket with 1454E.....
1454E	9127	Lifting Presser Bar (lower) Guide Bracket Clamping Screw.....
128161	9116	Lifting Presser Bar (lower) Guide Bracket Guide.....
171D	9117	Lifting Presser Bar (lower) Guide Bracket Guide Screw.....
128065	9128	Lifting Presser Bar (upper).....
128401	9130	" " " " Guide Bracket with 410c.....
410c	9104	Lifting Presser Bar (upper) Guide Bracket Set Screw.....
128068	9130	Lifting Presser Bar Lifter.....
128069	9130	" " " " Connecting Link.....
50116F	9117	Lifter Presser Bar Lifter Connecting Link Hinge Screw (lower).....
108F	9117	Lifter Presser Bar Lifter Connecting Link Hinge Screw (upper).....
50415c	9117	Lifter Presser Bar Lifter Hinge Screw.....
2269	9130	" " " " Stop Pin (lower).....
2049	9130	Lifter Presser Bar Lifter Stop Pin (upper).....
128070	9128	Lifter Presser Bar Lifting Lever.....
128071	9112	" " " " " Extension.....
161c	9117	Lifter Presser Bar Lifting Lever Extension Screw.....
866D	9117	Lifter Presser Bar Lifting Lever Hinge Screw.....
50603D	9130	Lifter Presser Bar Lifting Lever Stop Screw.....
128186	9128	Lifter Presser Bar Spring (flat).....
54722	9130	" " " " Stud.....
128382	9122	" " Foot Hinge Pin.....
128394	----	" " " Plate.....

NOTE: When ordering No. 128394, state gauge.

128384	----	Lifter Presser Foot Shank.....
128396	9126	Lifting Presser Foot (hinged) complete, Nos. 128382, 128384 and 128394.....

NOTE: When ordering No. 128396, state gauge.

NO.	PLATE	NAME
190D	9117	Lifting Presser Foot Screw.....
128413	9127	Looper (back).....
128414	9127	" (centre).....
128415	9127	" (front).....
128349	9127	" Carrier with 1454c, for 128413..
128397	9127	" " " 735c, for 128414...
128398	----	Looper Carrier (adjustable), Nos. 128349 and 128397.....
128208	9127	Looper Carrier (single with 1454c, for 128415).....
1454c	9127	Looper Carrier Clamping Screw.....
735c	9127	" " Set Screw.....
128399	9128	Needle Bar (hollow).....
128400	----	Needle Bar complete, Nos. 128215 and 128399.....
54974	9129	Needle Bar Bushing (lower).....
563c	9118	" " " " Set Screw..
54710	9129	" " " (upper).....
563c	9118	" " " " Set Screw..
*54711	9129	" " Connecting Link.....
128274	----	" " " " 54711 with 54712 and 128210.....
54712	9129	Needle Bar Connecting Link Hinge Stud
1520	9118	" " " " " " " Nut.....
128117	9129	Needle Bar Connecting Stud with 207E.
207E	9129	" " " " Clamping Screw.....
128210	----	Needle Bar Connecting Stud complete, Nos. 220D, 10107, 128117, 128211, 128213, 128214 and two each 42348 and 128212.....
128211	9129	Needle Bar Thread Retainer Bracket with two 238D.....
220D	9117	Needle Bar Thread Retainer Bracket Screw.....
42348	9129	Needle Bar Thread Retainer Disc.....
128212	9129	" " " " Separating Disc.....
10107	9129	Needle Bar Thread Retainer Spring....
128213	9129	" " " " Stud.....
238D	9129	" " " " " Set Screw.....
128214	9129	Needle Bar Thread Retainer Thread Guide.....
238D	9129	Needle Bar Thread Retainer Thread Guide Set Screw.....

NO.	PLATE	NAME
128215	9129	Needle Clamp with three 1498F.....
NOTE: When ordering No. 128215, state gauge.		
128216	9129	Needle Guard for $\frac{1}{8}$ in., $\frac{5}{16}$ in. and $\frac{5}{32}$ in. gauges.....
NOTE: When ordering No. 128216, state gauge.		
447c	9118	Needle Guard Set Screw.....
1498F	9129	" Set Screw.....
50132w	9118	Pressure Regulating Thumb Screw.....
1543w	9118	" " " " Lock Nut.....
*128337	—	Pulley, $2\frac{7}{8}$ in. diam.,.....
128220	9128	Tension (under thread) Bracket.....
128269	—	" " " " 128220, with 233b, 1144b, 50076b, 63824, 128077, 128221, 128222 and two 337d
176b	9117	Tension (under thread) Bracket Screw..
2102	9131	" " " Disc.....
51570c	9131	" " " Regulating Thumb Nut.....
128221	9131	Tension (under thread) Releaser (lower)
233d	9117	" " " " " " Adjusting Screw.....
50076b	9117	Tension (under thread) Releaser (lower) Hinge Screw.....
128222	9131	Tension (under thread) Releaser (upper)
337d	9131	" " " " " " Screw.....
32572	9131	Tension (under thread) Releasing Disc..
128077	9128	" " " " Lever
63824	9131	" " " " " Spring.....
1144b	9117	Tension (under thread) Releasing Lever Spring Screw.....
128078	9131	Tension (under thread) Releasing Pin..
50326c	9131	" " " Screw Stud
59539	—	" " " " " 50326c with 51570c.....
59534	9131	Tension (under thread) Spring.....
59537	9131	" " " " Bushing (large).....
59538	9131	Tension (under thread) Spring Bushing (small).....
17547	9131	Tension (under thread) Thread Guide..
128223	9135	" (upper thread) Bracket with three 447c.....

NO.	PLATE	NAME
376b	9118	Tension (upper thread) Bracket Screw
128224	9131	" " " " Thread Eyelet (double).....
330b	9118	Tension (upper thread) Bracket Thread Eyelet Screw.....
128081	9131	Tension (upper thread) Bracket Thread Eyelet Screw Washer.....
2102	9131	Tension (upper thread) Disc.....
51570c	9131	" " " Regulating Thumb Nut.....
32572	9131	Tension (upper thread) Releasing Disc..
128225	9131	" " " " Pin..
128226	9135	" " " " Shaft
128227	9131	" " " " Collar with two 735c.....
735c	9131	Tension (upper thread) Releasing Shaft Collar Set Screw.....
128228	9132	Tension (upper thread) Releasing Shaft Crank with 457c.....
54873	9132	Tension (upper thread) Releasing Shaft Crank Link.....
128229	9132	Tension (upper thread) Releasing Shaft Crank Link Bracket.....
330b	9118	Tension (upper thread) Releasing Shaft Crank Link Bracket Screw.....
51034c	9131	Tension (upper thread) Releasing Shaft Crank Link Hinge Screw (lower).....
110c	9117	Tension (upper thread) Releasing Shaft Crank Link Hinge Screw (upper).....
457c	9132	Tension (upper thread) Releasing Shaft Crank Set Screw.....
39302	9132	Tension (upper thread) Releasing Shaft Crank Spring.....
170E	9131	Tension (upper thread) Releasing Shaft Crank Spring Screw Stud.....
50326c	9131	Tension (upper thread) Screw Stud
59539	—	" " " " " 50326c with 51570c.....
59536	9131	Tension (upper thread) Spring.....
59537	9131	" " " " Bushing (large).....
59538	9131	Tension (upper thread) Spring Bushing (small).....
17547	9131	Tension (upper thread) Thread Guide..
128083	9135	" Releasing Arm with 51818.....
128084	9135	" " " Connecting Rod

NO.	PLATE	NAME
1521e	9118	Tension Releasing Arm Connecting Rod Nut.....
1131c	9117	Tension Releasing Arm Hinge Screw....
51818	9132	“ “ “ Roller and Screw Stud.....
128230	9132	Thread (under) Eyelet.....
620c	9118	“ “ “ Set Screw.....
128387	9132	“ “ “ Guide.....
335c	9118	“ “ “ Screw.....
128235	9132	“ “ “ Nipper Cam with 61121 and two 465c.....
128087	—	Thread (under) Nipper Cam Oil Pad (felt).....
128088	—	Thread (under) Nipper Cam Oil Pad Holder.....
128089	9132	Thread (under) Nipper Cam Oil Pad Holder 128088 with 128087.....
465c	9133	Thread (under) Nipper Cam Set Screw..
128236	9134	“ “ “ Spring (lower)..
128402	9134	“ “ “ “ (upper)..
334d	9118	“ “ “ “ Screw....
128238	9134	“ “ “ Protector.....
228d	9134	“ “ “ “ Screw.....
128239	9134	“ “ “ Pull-off.....
226d	9117	“ “ “ “ Adjusting Screw
61121	9132	“ “ “ “ Position Pin....
128240	9134	“ “ “ “ Stripper.....
329d	9132	“ “ “ “ “ Screw
128081	9131	“ “ “ “ “ “ Washer.....
128241	9134	Thread (under) Separator.....
128242	9134	“ “ “ Take-up with two 465c.....
128243	9135	“ “ “ “ Frame.....
128298	—	Thread (under) Take-up Frame complete, Nos. 128105, 128243 and 128299.....
*128299	9135	Thread (under) Take-up Frame Cover with 50150c.....
128105	9134	Thread (under) Take-up Frame Cover Hinge Pin.....
50150c	9116	Thread (under) Take-up Frame Cover Hinge Pin Set Screw.....
1149d	9134	Thread (under) Take-up Frame Screw..
128246	9133	“ “ “ “ Knife.....
128247	9133	“ “ “ “ “ Holder with 465c.....
185d	9117	Thread (under) Take-up Knife Holder Screw.....

NO.	PLATE	NAME
465c	9133	Thread (under) Take-up Knife Set Screw
465c	9133	“ “ “ “ Set Screw.....
128248	9133	“ “ “ “ Stripper.....
128098	9133	“ “ “ “ “ Bracket
1364c	9117	“ “ “ “ “ “ Screw.....
330d	9118	Thread (under) Take-up Stripper Screw
128081	9131	“ “ “ “ “ “ Washer.....
128249	9133	Thread (under) Take-up Thread Guard with 220d.....
128100	9133	Thread (under) Take-up Thread Guard Bracket.....
1364c	9117	Thread (under) Take-up Thread Guard Bracket Screw.....
1137e	9118	Thread (under) Take-up Thread Guard Hinge Screw.....
128101	9133	Thread (under) Take-up Thread Guard Spring.....
335d	9118	Thread (under) Take-up Thread Guard Spring Screw.....
220d	9117	Thread (under) Take-up Thread Guard Stop Screw.....
128250	9133	Thread (upper) Controller.....
125564	9133	“ “ “ “ Lever with 50138f.....
54879	9135	Thread (upper) Controller Lever Connection.....
128168	9133	Thread (upper) Controller Lever Connection Bracket.....
203f	9117	Thread (upper) Controller Lever Connection Bracket Screw.....
999f	9117	Thread (upper) Controller Lever Connection Hinge Screw (lower).....
999f	9117	Thread (upper) Controller Lever Connection Hinge Screw (upper).....
1700e	9118	Thread (upper) Controller Lever Connection Hinge Screw (upper) Nut....
125566	9133	Thread (upper) Controller Lever Hinge Stud.....
465c	9133	Thread (upper) Controller Lever Hinge Stud Set Screw.....
125567	9133	Thread (upper) Controller Lever Post with 465c.....
443c	9118	Thread (upper) Controller Lever Post Set Screw.....

NO.	PLATE	NAME
50138F	9133	Thread (upper) Controller Set Screw...
128250	9133	“ “ “ Thread Guide
128251	9136	“ “ “ “ “
		Post with 50138d.....
175F	9102	Thread (upper) Controller Thread Guide Post Screw.....
50138	9133	Thread (upper) Controller Thread Guide Set Screw.....
128110	9136	Thread (upper) Check Spring.....
128111	9136	“ “ “ “ Adjusting Plate.....
226D	9117	Thread (upper) Check Spring Adjusting Plate Screw.....
128112	9101	Thread (upper) Check Spring Regulating Stud.....
447C	9118	Thread (upper) Check Spring Regulating Stud Set Screw.....
128252	9136	Thread (upper) Take-up.....
217D	9117	“ “ “ Screw.....
128253	9136	“ “ “ Stripper.....
128254	9136	“ “ “ “ Bracket
1492D	9117	“ “ “ “ “ Screw.....
226D	9117	Thread (upper) Take-up Stripper Screw
128255	9125	Throat Plate for 128202.....
128418	9703	“ “ “ 128412.....

NOTE: When ordering Nos. 128255 and 128418,
state gauge.

1319F 9118 Throat Plate Screw.....

IRON BASE

NO.	PLATE	NAME
128116	9119	Machine Base with 304c, 307c, 448c, 1513J, 27795, two each 935D, 42088, 66707 and three wood screws 1½ in. No. 12.....
42088	9121	Machine Cushion (felt).....
935D	9121	“ “ Screw.....
66707	9121	“ “ “ Washer.....
304c	9121	“ Screw Centre (left).....
1513J	9121	“ “ “ “ Nut.....
307c	9140	“ “ “ (right).....
448c	9116	“ “ “ “ Set Screw
27795	9140	“ “ “ “ “ “ Washer.....

ACCESSORIES

NO.	PLATE	NAME
1407W	5563	Machine Thumb Screw, for 3 in. table..
1408W	5563	“ “ “ “ 2 in. table..
14063	9140	“ “ “ Spring.....
9842	9121	“ “ “ “ Washer..
120344	6375	Oiler (copper plated) with 120345.....
120345	6375	“ Spout 5 in. long.....
26026	6375	Screw Driver (large).....
26485	6375	“ “ (small).....
120341	6375	Tweezers (curved).....
4822	6375	Wrench for 1521 and 1547.....
8908	6375	“ “ 1664, 1722 and 1723.....
8909	9140	“ “ 1513.....

BELT GUARD

NO.	PLATE	NAME
128171	9119	Belt Guard (lower).....
128172	9119	“ “ (upper).....
63505	9121	“ “ “ Hinge Pin.....
743382	9121	“ “ “ Lock Spring.....
2273	9121	“ “ “ “ “ Position Pin.....
331D	9118	Belt Guard (upper) Lock Spring Screw.
128173	—	Belt Guard complete, Nos. 331D, 2273, 63505, 128171, 128172, 743382, and three wood screws 1 in. No. 10.....

FOOT LIFTER PARTS

NO.	PLATE	NAME
6439	—	Chain, 36 in. to 45 in., with 56864 and 56865.....
NOTE: When ordering No. 6439, give length required.		
4879	9121	Chain Connecting Link.....
56864	9121	“ Hook (large).....
56865	9121	“ “ (small).....
126249	9137	Treadle.....
4882	9121	“ Shaft.....
126250	9140	“ Spring.....
126251	9137	“ Stand.....
126252	9137	Treadle complete, Nos. 4882, 126249 to 126251 and two wood screws 1 in. No. 16.....

LAP SEAM FELLER PARTS

NO.	PLATE	NAME
120525	9138	Lap Seam Feller on Slide 120645, for 128358, for 148-4 Machine.....
120503	9138	Lap Seam Feller on Slide 128255, for 148-4 Machine.....
120646	9138	Lap Seam Feller on Slide 120645, for 148-7 Machine.....
120777	9703	Lap Seam Feller on Slide 120780, for heavy work.....
50169F	9139	Lap Seam Feller Adjusting Screw.....
1443W	9139	" " " Screw.....
120644	9139	Holder with 665w and 50169F for 120503, 120525 and 120646.....
120778	9703	Holder with 665w and 50169F for 120777
36586	9139	" Plate for 120503 and 120646....
120526	9139	" " " 120525.....
120779	9703	" " " 120777.....
624K	9139	" " Adjusting Screw.....
36598	9139	" Plate Bracket with 624k.....
1174W	9139	" " " Screw.....
211W	9139	" " " Screw.....
922D	9139	" Thumb Screw.....
120645	9139	Slide with 10165 for 120503, 120525 and 120647.....
120780	—	Slide with 10165, for 120777.....
10165	9139	" Steady Pin.....
665W	9139	" Stop Screw.....
19294	9139	Spring.....
405D	9118	" Screw.....

THREAD UNWINDER

FOR SIX SPOOLS

NO.	PLATE	NAME
225395	8997	Spool Rest (for two spools) with 201018c
225388	8997	" " Rod.....
200383c	9140	" " " Set Screw.....
201018c	9140	" " " Set Screw.....
202490	8997	" Stand with 200383c.....
225391	8997	Thread Guide.....
201696j	9140	" " Lock Nut.....
225392	8997	" " Rod with 208E and 225393
208E	9140	" " " Screw.....
225393	9140	" " " Washer.....

THREAD UNWINDER

NO.	PLATE	NAME
225378	8997	Thread Unwinder complete, Nos. 201696j, 202490, 225388, 225392, three 225395, six, 225391 and three wood screws 1/8 in. No. 12.....
27739	7234	Thread Cone (wood) for large cones....
225390	7234	" " Holder, for inverted cones.

NOTE: Nos. 27739 and 225390 are used with, but not included in 225378

OBSOLETE PARTS

NO.	PLATE	NAME
1664E	9118	Cylinder Rock Shaft Connecting Rod Ball Screw Stud (upper) Nut, use 1597E
*125522	—	Hand Wheel for 125523.....
125523	9119	" " and Pulley, Nos. 443c, 1285c, 125522 and 125539, use 128335
1285c	9118	Hand Wheel and Pulley Position Screw for 125523.....
443c	9118	Hand Wheel and Pulley Set Screw for 125523.....
128056	9112	Hand Wheel and Pulley Shaft.....
128057	9140	" " " " Bushing (left).....
888c	9118	Hand Wheel and Pulley Shaft Bushing (left) Set Screw.....
128207	9140	Looper Carrier (double) with 1454c, for 128204 and 128205, use 128351.....
128189	9129	Presser Foot Leveling Plate Spring for 128357 and 128375.....
19445	9129	Presser Foot Leveling Plate Spring Position Pin for 128356.....
50470j	9129	Presser Foot Leveling Plate Spring Screw for 128357 and 128375.....
50470i	9129	Presser Foot Needle Plate Spring Screw (left) for 128375.....
50470j	9129	Presser Foot Needle Plate Spring Screw (right) for 128375.....
50470i	9129	Presser Foot Needle Plate Spring Screw for 128357.....
*125539	—	Pulley, 2 7/8 in. diam., for 125523.....
128231	9132	Thread (under) Guide (back).....
906c	9132	" " " " Set Screw for 128234.....
128232	9132	Thread (under) Guide (centre).....

OBSOLETE PARTS

NO.	PLATE	NAME
906c	9132	Thread (under) Guide (centre) Set Screw for 128234.....
128233	9132	Thread (under) Guide (front).....
906c	9132	“ “ “ “ Set Screw for 128234.....
128234	9132	Thread (under) Guide Bracket with three 906c.....
335d	9118	Thread (under) Guide Bracket Screw...
128244	—	Thread (under) Take-up Frame complete, Nos. 128105, 128243 and 128245.....
*128245	9135	Thread (under) Take-up Frame Cover with 50150c, for 128244.....
177c	9117	Thread (under) Take-up Frame Screw..

Genuine Singer Needles and their Containers are marked with the Company's Trade Mark "SIMANCO." 1

Needles in Containers marked "For Singer Machines" are not Singer made needles. 2

NUMERICAL LIST OF PARTS
FOR
MACHINES
Nos. 148-4 and 148-7

NUMERICAL LIST OF PARTS

NO.	PLATE	NAME
108F	9117	Lifting Presser Bar Lifter Connecting Link Hinge Screw (upper) for 148-7 Machine.....
108F	9117	Presser Bar Lifter Connecting Link Hinge Screw (upper) for 148-4 Machine.....
110c	9117	Tension (upper thread) Releasing Shaft Crank Link Hinge Screw (upper).....
134d	9117	Cylinder Screw.....
150d	9127	Hand Wheel and Pulley Shaft Screw....
152E	9102	Cylinder Rock Shaft Connection Cap (large) Screw for 128018.....
161c	9117	Lifting Presser Bar Lifting Lever Extension Screw for 148-7 Machine.....
161c	9117	Presser Bar Lifting Lever Extension Screw for 148-4 Machine.....
170E	9131	Tension (upper thread) Releasing Shaft Crank Spring Screw Stud.....
171E	9117	Crank Connecting Rod Cap (upper) Screw, for 128267.....
171E	9117	Cylinder Rock Shaft Connecting Rod Cap (lower) Screw for 128025.....
171E	9117	Cylinder Rock Shaft Connecting Rod Cap (upper) Screw for 125601.....
171d	9117	Lifting Presser Bar (lower) Guide Bracket Guide Screw for 148-7 Machine.....
175E	9102	Cylinder Rock Shaft Connection Cap (small) Screw for 128018.....
175F	9102	Thread (upper) Controller Thread Guide Post Screw.....
176d	9117	Tension (under thread) Bracket Screw..
177c	9117	Thread (under) Take-up Frame Screw, obsolete.....
184d	9130	Presser Bar Lifting Lever Stop Screw for 148-4 Machine.....
185d	9117	Thread (under) Take-up Knife Holder Screw.....
190d	9117	Lifting Presser Foot for 148-7 Machine
190d	9117	Presser Foot Screw for 148-4 Machine..
193F	9117	Feed (upper) Regulator Pitman Connection Hinge Pin Set Screw for 128151.
198d	9109	Cylinder Rock Shaft Eccentric Set Screw for 128011.....
203d	9117	Feeding Foot Screw for 148-7 Machine..

NO. PLATE	NAME
203F 9117	Thread (upper) Controller Lever Connection Bracket Screw for 148-7 Machine.....
207E 9129	Needle Bar Connecting Stud Clamping Screw for 128117.....
208E 9140	Thread Unwinder Thread Guide Rod Screw for 225392.....
211W 9139	Lap Seam Feller Holder Plate Screw for 128127 and 128305.....
217D 9117	Crank Connecting Rod Position Plate Screw for 128264.....
217D 9117	Cylinder Rock Shaft Connecting Rod Position Plate Screw for 128026.....
217D 9117	Thread (upper) Take-up Screw.....
220D 9117	Cylinder Rock Shaft Bushing (front) Set Screw.....
220D 9117	Needle Bar Thread Retainer Bracket Screw for 128210.....
220D 9117	Thread (under) Take-up Thread Guard Stop Screw for 128249.....
223D 9127	Looper Screw for 148-4 Machine.....
226D 9117	Thread (under) Pull-off Adjusting Screw
226D 9117	“ (upper) Check Spring Adjusting Plate Screw.....
226D 9117	Thread (upper) Take-up Stripper Screw
228D 9134	“ (under) Protector Screw.....
233D 9117	Cylinder Top Cover (front) Spring Screw for 128033.....
233D 9117	Tension (under thread) Releasing (lower) Adjusting Screw for 128269.....
238D 9129	Needle Bar Thread Retainer Stud Set Screw for 128211.....
238D 9129	Needle Bar Thread Retainer Thread Guide Set Screw for 128211.....
286D 9118	Arm Side Cover Thumb Screw.....
286D 9118	Face Plate Thumb Screw.....
304C 9121	Machine Screw Centre (left) for 128116.
307C 9140	“ “ “ (right) for 128116
329D 9132	Thread (under) Pull-off Stripper Screw.
330D 9118	“ “ Take-up Stripper Screw
330D 9118	Tension (upper thread) Bracket Thread Eyelet Screw.....
330D 9118	Tension (upper thread) Releasing Shaft Crank Link Bracket Screw.....
331D 9118	Belt Guard (upper) Lock Spring Screw for 128173.....
334D 9118	Thread (under) Nipper Spring Screw...

NO. PLATE	NAME
335C 9118	Thread (under) Guide Screw.....
335D 9118	“ “ “ Bracket Screw, obsolete.....
335D 9118	Thread (under) Take-up Thread Guard Spring Screw.....
337D 9131	Tension (under thread) Releaser (upper) Screw for 128269.....
376D 9118	Tension (upper thread) Bracket Screw..
391D 9118	Cylinder Top Cover (front) Screw for 128197.....
405D 9118	Cylinder End Cover Lock Spring Screw for 128012 and 128270.....
405D 9118	Lap Seam Feller Spring Screw.....
437C 9118	Arm Rock Shaft Bushing (back) Set Screw.....
440C 9104	Lifting Presser Bar (upper) Guide Bracket Set Screw for 128401.....
440C 9104	Presser Bar (upper) Guide Bracket Set Screw for 128066.....
443C 9118	Hand Wheel and Pulley Set Screw for 125523, obsolete.....
443C 9118	Thread (upper) Controller Lever Post Set Screw.....
445C 9122	Hand Wheel and Pulley Shaft Flanged Bushing (left) Set Screw.....
447C 9118	Needle Guard Set Screw for 128197.....
447C 9118	Thread (upper) Check Spring Regulating Stud Set Screw for 128223.....
448C 9116	Feed Regulator Pawl Lever Set Screw for 128047.....
448C 9116	Feed (lower) Regulator Pawl Lever Set Screw, for 128047.....
448C 9116	Machine Screw Centre (right) Set Screw for 128116.....
448C 9116	Presser Bar Connecting Bracket Set Screw (long) for 128067.....
452C 9122	Feed Lifting Lever Hinge Pin Set Screw for 128197.....
452C 9122	Feed (lower) Lifting Lever Hinge Pin Set Screw for 128197.....
452C 9122	Feed (upper) Regulator Pitman Connection Bracket Hinge Pin Set Screw for 148-7 Machine.....
453C 9116	Feed Regulator Pawl Set Screw, for 128046.....
453C 9116	Feed (lower) Regulator Pawl Set Screw for 128046.....

NO. PLATE	NAME
453c 9116	Presser Bar Connecting Bracket Set Screw (short) for 128067.....
456c 9101	Arm Rock Shaft Collar Set Screw for 54921.....
457c 9132	Tension (upper thread) Releasing Shaft Crank Set Screw for 128228.....
460c 9118	Cylinder Top Cover (back) Hinge Pin Set Screw for 128197.....
462c 9118	Feed Lifting Eccentric Set Screw, for 128203.....
462c 9118	Feed (lower) Lifting Eccentric Set Screw for 128042.....
465c 9133	Thread (under) Nipper Cam Set Screw for 128235.....
465c 9133	Thread (under) Take-up Knife Set Screw for 128247.....
465c 9133	Thread (under) Take-up Set Screw for 128242.....
465c 9133	Thread (upper) Controller Lever Hinge Stud Set Screw for 125567.....
563c 9118	Needle Bar Bushing (lower) Set Screw..
563c 9118	“ “ “ (upper) Set Screw..
563c 9118	Lifting Presser Bar (lower) Bushing Set Screw, for 148-7 Machine.....
563c 9118	Presser Bar (lower) Bushing Set Screw, for 148-4 Machine.....
620c 9118	Thread (under) Eyelet Set Screw.....
624k 9139	Lap Seam Feller Holder Plate Adjusting Screw for 36598.....
662d 9122	Cylinder Thread Eyelet Thread Guard Screw, for 128268.....
664w 9122	Feeding Foot Hinge Stud Stop Screw for 128393.....
665w 9139	Lap Seam Feller Slide Stop Screw for 120644 and 120779.....
665c 9139	Presser Foot Needle Plate Spring Screw for 128219, 128357 and 128375.....
735c 9131	Looper Carrier Set Screw for 128397...
735c 9131	Tension (upper thread) Releasing Shaft Collar Set Screw for 128227.....
829c 9118	Feed (upper) Regulator Pitman Connection Hinge Screw, for 148-7 Machine.
866d 9117	Lifting Presser Bar Lifting Lever Hinge Screw for 148-7 Machine.....
866d 9117	Presser Bar Lifting Lever Hinge Screw, for 148-4 Machine.....

NO. PLATE	NAME
888c 9118	Arm Rock Shaft Bushing (front) Set Screw.....
888c 9118	Hand Wheel and Pulley Shaft Bushing (left) Set Screw, obsolete.....
888c 9118	Hand Wheel and Pulley Shaft Bushing (right) Set Screw.....
896E 9117	Crank Connecting Rod Cap (lower) Screw for 54616.....
896E 9117	Feed Connecting Rod Cap Screw for 128038.....
896E 9117	Feed (lower) Connection Cap Screw for 128140.....
896E 9117	Feed Lifting Lever Connecting Rod Cap Screw for 54953.....
896E 9117	Feed (lower) Lifting Lever Connecting Rod Cap Screw for 54953.....
906c 9132	Thread (under) Guide (back) Set Screw for 128234, obsolete.....
906c 9132	Thread (under) Guide (centre) Set Screw for 128234, obsolete.....
906c 9132	Feed (under) Guide (front) Set Screw for 128234, obsolete.....
907D 9117	Feed (upper) Regulator Connecting Link Hinge Screw (front) for 148-7 Machine
911E 9101	Arm Back Cover Latch Screw Stud for 54915.....
922D 9139	Lap Seam Feller Holder Thumb Screw..
935D 9121	Machine Cushion Screw for 128116.....
999F 9117	Thread (upper) Controller Lever Connection Hinge Screw (lower).....
999F 9117	Thread (upper) Controller Lever Connection Hinge Screw (upper).....
1125c 9118	Cylinder Rock Shaft Bushing (back) Set Screw.....
1131c 9117	Tension Releasing Arm Hinge Screw....
1137E 9118	Thread (under) Take-up Thread Guard Hinge Screw.....
1143c 9109	Feed Eccentric Body Set Screw for 128174.....
1143c 9109	Feed (lower) Eccentric Body Set Screw for 128174.....
1144D 9117	Tension (under thread) Releasing Lever Spring Screw for 128269.....
1149D 9134	Thread (under) Take-up Frame Screw..
1174w 9139	Lap Seam Feller Holder Plate Bracket Screw for 128127 and 128305.....

NO.	PLATE	NAME
1231w	9118	Cylinder End Cover Slide (front) Screw for 128012 and 128270.....
1253c	9102	Cylinder Rock Shaft Crank Set Screw for 128017.....
1285c	9118	Hand Wheel and Pulley Position Screw for 125523.....
1302d	9118	Cylinder Thread Guard Screw.....
1319f	9118	Throat Plate Screw.....
1364c	9117	Thread (under) Take-up Stripper Bracket Screw.....
1364c	9117	Thread (under) Take-up Thread Guard Bracket Screw.....
1368j	9129	Presser Foot Needle Plate Spring Stop Screw for 128219, 128357 and 128375.
1402d	9117	Cylinder Thread Eyelet Screw.....
1407w	5563	Machine Thumb Screw, for 3 in. table (Accessories).....
1408w	5563	Machine Thumb Screw, for 2 in. table (Accessories).....
1443d	9101	Arm Back Cover Spring Screw, for 54914
1443w	9139	Lap Seam Feller Screw.....
1454c	9127	Looper Carrier Clamping Screw, for 128208 and 128349.....
1454e	9127	Lifting Presser Bar (lower) Guide Bracket Clamping Screw for 128160.....
1467d	9116	Feed (upper) Bar Bell Crank Cap Screw, for 148-7 Machine.....
1492d	9117	Thread (upper) Take-up Stripper Bracket Screw.....
1498f	9129	Needle Set Screw for 128215.....
1513j	9121	Machine Screw Centre (left) Nut for 128116.....
1520e	9118	Feed (upper) Bar Bell Crank Connecting Link Hinge Stud (left) Nut for 148-7 Machine.....
1520e	9118	Feed (upper) Regulator Pitman Connection Hinge Stud Nut, for 148-7 Machine
1520e	9118	Feed (upper) Regulator Pitman Connection Hinge Screw Nut, for 148-7 Machine.....
1520j	9118	Needle Bar Connecting Link Hinge Stud Nut.....
1521e	9118	Tension Releasing Arm Connecting Rod Nut.....
1538d	9101	Arm Back Cover Latch Screw Stud Thumb Nut for 54914.....

NO.	PLATE	NAME
1543w	9118	Pressure Regulating Thumb Screw Lock Nut.....
1597e	9118	Crank Connecting Rod Ball Screw Stud Nut.....
1597e	9118	Cylinder Rock Shaft Connecting Rod Ball Screw Stud (upper) Nut.....
1651e	9118	Feed (upper) Regulator Connecting Link Hinge Screw (back) Nut, for 148-7 Machine.....
1664e	9118	Cylinder Rock Shaft Connecting Rod Ball Screw Stud (lower) Nut.....
1664e	9118	Cylinder Rock Shaft Connecting Rod Ball Screw Stud (upper) Nut, obsolete, use 1597e.....
1669c	9118	Feed (upper) Regulator Screw Stud Nut, for 148-7 Machine.....
1700e	9118	Feed (upper) Bar Hinge Screw Nut, for 148-7 Machine.....
1700e	9118	Thread (upper) Controller Lever Connection Hinge Screw (upper) Nut....
1722e	9122	Crank Connecting Rod Nut (lower) for 128264.....
1722e	9122	Cylinder Rock Shaft Connecting Rod Nut (lower) for 128021.....
1722e	9122	Feed Lifting Lever Connecting Rod Hinge Screw Nut, for 148-4 Machine.
1722e	9122	Feed (lower) Lifting Lever Connecting Rod Hinge Screw Nut, for 148-7 Machine.....
1723e	9122	Crank Connecting Rod Nut (upper) for 128264.....
1723e	9122	Cylinder Rock Shaft Connecting Rod Nut (upper) for 128021.....
1735j	9118	Feed Adjusting Screw Nut, for 148-4 Machine.....
1735j	9118	Feed (lower) Adjusting Screw Nut, for 148-7 Machine.....
1735j	9118	Feed Rod Connecting Link Hinge Screw Nut, for 148-4 Machine.....
1735j	9118	Feed (lower) Rod Connecting Link Hinge Screw Nut, for 148-7 Machine.....
2049	9130	Lifting Presser Bar Lifter Stop Pin (upper) for 148-7 Machine.....
2049	9130	Presser Bar Lifter Stop Pin (upper) for 148-4 Machine.....
2102	9131	Tension (under thread) Disc.....
2102	9131	" (upper thread) Disc.....

NO.	PLATE	NAME
2269	9130	Lifting Presser Bar Lifter Stop Pin (lower) for 148-7 Machine.....
2269	9130	Presser Bar Lifter Stop Pin (lower) for 148-4 Machine.....
2273	9121	Belt Guard (upper) Lock Spring Position Pin for 128173.....
4822	6375	Wrench for 1521 and 1547 (Accessories).....
4879	9121	Chain Connecting Link.....
4882	9121	Treadle Shaft for 126252.....
6439	—	Chain, 36 in. to 45 in., with 56864 and 56865.....
8908	6375	Wrench for 1664, 1722 and 1723 (Accessories).....
9842	9121	Machine Thumb Screw Spring Washer (Accessories).....
10107	9129	Needle Bar Thread Retainer Spring for 128210.....
10165	9139	Lap Seam Feller Slide Steady Pin for 120645.....
11184	9129	Presser Foot Leveling Plate Hinge Pin for 128219, 128357 and 128375.....
14063	9140	Machine Thumb Screw Spring (Accessories).....
17547	9131	Tension (under thread) Thread Guide.....
17547	9131	“ (upper thread) Thread Guide.....
19294	9139	Lap Seam Feller Spring.....
19445	9129	Presser Foot Leveling Plate Spring Position Pin, for 128356, obsolete.....
26026	6375	Screw Driver, large (Accessories).....
26485	6375	“ “ small (Accessories).....
27739	7234	Thread Unwinder Thread Cone Holder (wood) for large cones, for 225378.....
27795	9140	Machine Screw Centre (right) Set Screw Washer for 128116.....
32572	9131	Tension (under thread) Releasing Disc.....
32572	9131	“ (upper thread) Releasing Disc.....
36586	9139	Lap Seam Feller Holder Plate for 120503, for 128127, 128305 and 120646.....
36598	9139	Lap Seam Feller Holder Plate Bracket with 624κ, for 128127 and 128305.....
39302	9132	Tension (upper thread) Releasing Shaft Crank Spring.....
39541	9116	Feed (upper) Regulator Screw Stud Nut Washer for 148-7 Machine.....
41128	9127	Hand Wheel and Pulley Shaft Bushing (right) Oil Pad (braided cotton).....
42088	9121	Machine Cushion (felt) for 128116.....

NO.	PLATE	NAME
42348	9129	Needle Bar Thread Retainer Disc for 128210.....
42365	9127	Hand Wheel and Pulley Shaft Flanged Bushing (left) Oil Pad (braided cotton).....
42833	9102	Feed Regulator Pawl Lever Stud Spring, for 148-4 Machine.....
42833	9102	Feed (lower) Regulator Pawl Lever Stud Spring, for 148-7 Machine.....
46111	9102	Face Plate Pin.....
50076D	9117	Tension (under thread) Releaser (lower) Hinge Screw for 128269.....
50083c	9104	Arm Rock Shaft Crank (back) Set Screw for 128006 and 128262.....
50084c	9122	Hand Wheel and Pulley Set Screw for 128335.....
50116F	9117	Lifting Presser Bar Lifter Connecting Link Hinge Screw (lower) for 148-7 Machine.....
50116F	9117	Presser Bar Lifter Connecting Link Hinge Screw (lower) for 148-4 Machine.....
50128c	9117	Feed Dog Screw, for 148-4 Machine.....
50128c	9117	“ (lower) Dog Screw, for 148-7 Machine.....
50132w	9118	Pressure Regulating Thumb Screw.....
50135c	9104	Arm Rock Shaft Crank (front) Set Screw for 128007 and 128138.....
50138F	9133	Thread (upper) Controller Set Screw for 125564.....
50138D	9133	Thread (upper) Controller Thread Guide Set Screw for 128251.....
50150c	9116	Feed Rod Hinge Bracket Hinge Pin Set Screw for 128197.....
50150c	9116	Feed (lower) Rod Hinge Bracket Hinge Pin Set Screw for 128197.....
50150c	9116	Feed Rod Hinge Pin Set Screw for 128053.....
50150c	9116	“ (lower) Rod Hinge Pin Set Screw for 128053.....
50150c	9116	Feed (upper) Bar Hinge Bracket Set Screw for 128146.....
50150c	9116	Feed (upper) Regulator Hinge Stud Set Screw, for 148-7 Machine.....
50150c	9116	Thread (under) Take-up Frame Cover Hinge Pin Set Screw for 128245 and 128299.....
50169F	9139	Lap Seam Feller Adjusting Screw for 120644 and 120778.....

NO.	PLATE	NAME
50223d	9117	Arm Back Cover Latch Hinge Screw for 54914.....
50224c	9118	Arm Rock Shaft Bushing (intermediate) Set Screw.....
50326c	9131	Tension (under thread) Screw Stud for 59539.....
50326c	9131	Tension (upper thread) Screw Stud for 59539.....
50415c	9117	Lifting Presser Bar Lifter Hinge Screw, for 148-7 Machine.....
50415c	9117	Presser Bar Lifter Hinge Screw, for 148-4 Machine.....
50470j	9129	Presser Foot Leveling Plate Spring Screw for 128357 and 128375, obsolete.....
50470j	9129	Presser Foot Needle Plate Spring Screw (left) for 128375, obsolete.....
50470j	9129	Presser Foot Needle Plate Spring Screw (right) for 128375, obsolete.....
50470j	9129	Presser Foot Needle Plate Spring Screw for 128357, obsolete.....
50589c	9109	Cylinder Rock Shaft Eccentric Regulating Screw for 128041.....
50594c	9118	Presser Foot Shank Screw for 128219, 128357 and 128375.....
50603d	9130	Lifting Presser Bar Lifting Lever Stop Screw, for 148-7 Machine.....
50730c	9102	Cylinder Rock Shaft Connecting Rod Ball Screw Stud (lower) for 128025.....
50731c	9102	Cylinder Rock Shaft Connecting Rod Ball Screw Stud (upper) for 128026.....
50732c	9117	Feed Adjusting Screw (eccentric) for 148-4 Machine.....
50732c	9117	Feed (lower) Adjusting Screw (eccentric) for 148-7 Machine.....
50733c	9117	Feed Rod Connecting Link Hinge Screw, for 148-4 Machine.....
50733c	9117	Feed (lower) Rod Connecting Link Hinge Screw, for 148-7 Machine.....
50997c	9117	Feed Lifting Lever Connecting Rod Hinge Screw (eccentric) for 148-4 Machine.....
50997c	9117	Feed (lower) Lifting Lever Connecting Rod Hinge Screw (eccentric) for 148-7 Machine.....
50999f	9117	Cylinder End Cover Slide (back) Stop Screw.....

NO.	PLATE	NAME
51004c	9117	Feed (upper) Regulator Connecting Link Hinge Screw (back) for 148-7 Machine
51005c	9117	Feed (upper) Regulator Screw Stud, for 148-7 Machine.....
51021c	9117	Feed (upper) Bar Hinge Screw, for 148-7 Machine.....
51034c	9131	Tension (upper thread) Releasing Shaft Crank Link Hinge Screw (lower).....
51043c	9122	Crank Connecting Rod Ball Screw Stud for 128267.....
51570c	9131	Tension (underthread) Regulating Thumb Nut for 59539.....
51570c	9131	Tension (upper thread) Regulating Thumb Nut for 59539.....
51818	9132	Tension Releasing Arm Roller and Screw Stud for 128083.....
*54612	---	Crank Connecting Rod Cap (lower) for 54616.....
*54613	---	Cylinder Rock Shaft Connecting Rod Cap (upper) for 125601.....
*54614	---	Crank Connecting Rod End Bearing (lower) for 54616.....
54616	---	Crank Connecting Rod Head (lower), Nos. 54612, 54614 and two 896e, for 128264 and 128340.....
54620	9101	Cylinder Dowel Pin.....
*54625	---	" End Cover Slide (back) for 128128.....
54627	9102	Cylinder End Cover Slide (front) Hinge Pin for 128128.....
54664	9109	Cylinder Top Cover (back) Hinge Pin for 128197.....
54708	9112	Needle Bar (hollow) for 128209.....
54710	9129	" " Bushing (lower) for 148-4 Machine.....
54710	9129	Needle Bar Bushing (upper).....
*54711	9129	" " Connecting Link for 128274
54712	9129	Needle Bar Connecting Link Hinge Stud for 128274.....
54722	9130	Lifting Presser Bar Spring Stud, for 148-7 Machine.....
54722	9130	Presser Bar Spring Stud, for 148-4 Machine.....
54873	9132	Tension (upper thread) Releasing Shaft Crank Link.....
54879	9135	Thread (upper) Controller Lever Connection.....

NO.	PLATE	NAME
54897	9101	Arm Oil Cup.....
54913	9119	" Back Cover for 54914.....
54914	—	Arm Back Cover complete, Nos. 1538D, 50223D, 54913, 54915, 54916 and two 1443D.....
54915	9101	Arm Back Cover Latch with 911E, for 54914.....
54916	9101	Arm Back Cover Spring for 54914.....
54919	9101	" Rock Shaft Bushing (intermediate)
54921	9101	" " " Collar with two 456C..
54925	—	Crank Connecting Rod (rod only) for 128264.....
*54940	—	Feed Lifting Lever Connecting Rod Cap for 54953.....
*54940	—	Feed (lower) Lifting Lever Connecting Rod Cap for 54953.....
54953	9109	Feed Lifting Lever Connecting Rod with 54940 and two 896E, for 128273.....
54953	9109	Feed (lower) Lifting Lever Connecting Rod with 54940 and two 896E, for 128122.....
54958	9102	Feed Regulator Friction Spring, for 148-4 Machine.....
54958	9102	Feed (lower) Regulator Friction Spring, for 148-7 Machine.....
54968	9112	Hand Wheel and Pulley Shaft Bushing (right).....
54970	9101	Hand Wheel and Pulley Shaft Washer..
54974	9129	Needle Bar Bushing (lower) for 148-7 Machine.....
*55032	—	Cylinder Rock Shaft Connecting Rod End Bearing (upper) for 125601.....
55034	9101	Crank Connecting Rod Position Plate for 128264.....
55034	9101	Cylinder Rock Shaft Connecting Rod Position Plate for 128026.....
55084	9130	Presser Bar (lower) for 148-4 Machine..
*55165	—	Cylinder End Cover Slide (front) for 128128.....
56016	9123	Arm Side Cover.....
56864	9121	Chain Hook (large) for 6439.....
56865	9121	" " (small) for 6439.....
59534	9131	Tension (under thread) Spring.....
59536	9131	" (upper thread) Spring.....
59537	9131	" (under thread) Spring Bushing (large).....

NO.	PLATE	NAME
59537	9131	Tension (upper thread) Spring Bushing (large).....
59538	9131	Tension (under thread) Spring Bushing (small).....
59538	9131	Tension (upper thread) Spring Bushing (small).....
59539	—	Tension (under thread) Screw Stud 50326C with 51570C.....
59539	—	Tension (upper thread) Screw Stud 50326C with 51570C.....
61121	9132	Thread (under) Pull-off Position Pin for 128235.....
63505	9121	Belt Guard (upper) Hinge Pin for 128173
63824	9131	Tension (under thread) Releasing Lever Spring for 128269.....
66707	9121	Machine Cushion Screw Washer for 128116.....
67425	9122	Crank Connecting Rod Ball Screw Stud Nut Lock Washer.....
120341	6375	Tweezers (curved) Accessories.....
120344	6375	Oiler (copper plated) with 120345 (Acces- sories).....
120345	6375	Oiler Spout, 5 in. long, for 120344.....
120503	9138	Lap Seam Feller on Slide 120645, for 128255, for 148-4 Machine.....
120525	9138	Lap Seam Feller on Slide 120645, for 128358, for 148-4 Machine.....
120526	9139	Lap Seam Feller Holder Plate for 120525
120644	9139	" " " " with 665W and 50169F.....
120645	9139	Lap Seam Feller Slide with 10165.....
120646	9138	" " " " on Slide 120645, for 148-7 Machine.....
120777	9703	Lap Seam Feller on Slide 120780, for heavy work, for 128412.....
120778	9703	Lap Seam Feller Holder with 665J and 50169F.....
120779	9703	Lap Seam Feller Holder Plate for 120777
120780	—	" " " " Slide for 120777.....
125504	9116	Feed (upper) Bar Bell Crank Slide Block, for 148-7 Machine.....
125510	9104	Feed (upper) Regulator Connecting Link, for 148-7 Machine.....
Nos. 125514 to 125516 for 148-7 Machine		
125514	9104	Feed (upper) Regulator Pitman Connec- tion Bracket.....

NO.	PLATE	NAME
125515	9104	Feed (upper) Regulator Pitman Connection Bracket Hinge Pin.....
125516	9104	Feed (upper) Regulator Pitman Connection Hinge Pin.....
*125522	---	Hand Wheel for 125523, obsolete.....
125523	9119	" " and Pulley, Nos. 443c, 1285c, 125522 and 125539, obsolete use 128335.....
*125539	---	Pulley, 2 $\frac{3}{8}$ in. diam., for 125523, obsolete
125564	9133	Thread (upper) Controller Lever with 50138E.....
125566	9133	Thread (upper) Controller Lever Hinge Stud.....
125567	9133	Thread (upper) Controller Lever Post with 465c.....
125601	---	Cylinder Rock Shaft Connecting Rod End Bearing (upper) 55032 with 54613 and two 171E, for 128026.....
Nos. 126249 TO 126251 FOR 126252		
126249	9137	Treadle.....
126250	9140	" Spring.....
126251	9137	" Stand.....
126252	9137	Treadle complete, Nos. 4882, 126249 to 126251 and two wood screws 1 in. No. 16.....
128002	9119	Arm Rock Shaft for 148-4 Machine....
128003	9101	" " " Bushing (back).....
128004	9101	" " " " (front).....
128006	9122	" " " Crank (back) with two 50083c, for 128021.....
128007	9109	Arm Rock Shaft Crank (front) with two 50135c, for 148-4 Machine.....
128011	9124	Cylinder End Cover for 128012.....
128012	---	Cylinder End Cover complete for 128127, Nos. 128011, 128128, two 128013, three 1231w and four 405b.....
128013	9101	Cylinder End Cover Lock Spring for 128012.....
128015	9102	Cylinder Rock Shaft Bushing (back)....
128016	9102	" " " " (front)....
128017	9102	" " " Crank with two 1253c.....
128018	9102	Cylinder Rock Shaft Connection with 128019, 128020 and two each 152E and 175E, for 128272 and 128403.....

NO.	PLATE	NAME
*128019	---	Cylinder Rock Shaft Connection Cap (large) for 128018.....
*128020	---	Cylinder Rock Shaft Connection Cap (small) for 128018.....
128021	9124	Cylinder Rock Shaft Connecting Rod complete, Nos. 1722E, 1723E, 128022, 128025 and 128026.....
128022	---	Cylinder Rock Shaft Connecting Rod (rod only) for 128021.....
*128023	---	Cylinder Rock Shaft Connecting Rod Cap (lower) for 128025.....
*128024	---	Cylinder Rock Shaft Connecting Rod End Bearing (lower) for 128025.....
128025	---	Cylinder Rock Shaft Connecting Rod Head (lower) Nos. 50730c, 128023, 128024 and two 171E, for 128021.....
128026	---	Cylinder Rock Shaft Connecting Rod Head (upper) Nos. 217D, 50731c, 55034 and 125601, for 128021.....
128027	---	Cylinder Rock Shaft Eccentric for 128041
128030	9102	" Thread Guard.....
128031	9124	" " Tube.....
128032	9124	" Top Cover (back) for 128197..
128033	9123	" " " (front) with 233b and 128034, for 128197.....
128034	9109	Cylinder Top Cover (front) Spring for 128033.....
128038	9112	Feed Connecting Rod with 128039 and two 896E, for 128272.....
*128039	---	Feed Connecting Rod Cap for 128038..
*128039	---	" (lower) Connection Cap for 128140
*128040	---	" Eccentric for 128041.....
*128040	---	" (lower) Eccentric for 128041.....
128041	9109	Feed Eccentric (adjustable) complete for 128272, Nos. 198b, 50589c, 128027, 128040 and 128174.....
128041	9109	Feed (lower) Eccentric (adjustable) complete for 128403, Nos. 198b, 50589c, 128027, 128040 and 128174.....
128042	9109	Feed (lower) Lifting Eccentric with two 462c, for 128122.....
128043	9112	Feed Lifting Lever, for 148-4 Machine..
128043	9112	" (lower) Lifting Lever, for 148-7 Machine.....
128044	9102	Feed Lifting Lever Hinge Pin, for 148-4 Machine.....

NO.	PLATE	NAME
128044	9102	Feed (lower) Lifting Lever Hinge Pin, for 148-7 Machine.....
128045	9109	Feed Regulator for 128275.....
128045	9109	" (lower) Regulator for 128404.....
128046	9109	Feed Regulator Pawl with two 453c, for 148-4 Machine.....
128046	9109	Feed (lower) Regulator Pawl with two 453c, for 148-7 Machine.....
128047	9123	Feed Regulator Pawl Lever with 448c, for 148-4 Machine.....
128047	9123	Feed (lower) Regulator Pawl Lever with 448c, for 148-7 Machine.....
128048	9102	Feed Regulator Pawl Lever Stud, for 148-4 Machine.....
128048	9102	Feed (lower) Regulator Pawl Lever Stud for 148-7 Machine.....
128049	9102	Feed Regulator Pawl Shaft, for 148-4 Machine.....
128049	9102	Feed (lower) Regulator Pawl Shaft, for 148-7 Machine.....
128050	9112	Feed Rod for 148-4 Machine.....
128050	9112	" (lower) Rod for 148-7 Machine...
128051	9102	" Rod Connecting Link (left) for 148-4 Machine.....
128051	9102	Feed (lower) Rod Connecting Link (left) for 148-7 Machine.....
128052	9102	Feed Rod Connecting Link (right) for 148-4 Machine.....
128052	9102	Feed (lower) Rod Connecting Link (right) for 148-7 Machine.....
128053	9122	Feed Rod Hinge Bracket with 50150c for 148-4 Machine.....
128053	9122	Feed (lower) Rod Hinge Bracket with 50150c for 148-7 Machine.....
128054	9127	Feed Rod Hinge Bracket Hinge Pin for 148-4 Machine.....
128054	9127	Feed (lower) Rod Hinge Bracket Hinge Pin for 148-7 Machine.....
128055	9102	Feed Rod Hinge Pin for 148-4 Machine
128055	9102	" (lower) Rod Hinge Pin for 148-7 Machine.....
128056	9112	Hand Wheel and Pulley Shaft, obsolete.
128057	9140	" " " " " Bushing (left) obsolete.....
128064	9130	Presser Bar (lower) Bushing, for 148-4 Machine.....

NO.	PLATE	NAME
128065	9128	Lifting Presser Bar (upper) for 148-7 Machine.....
128065	9128	Presser Bar (upper) for 148-4 Machine..
128066	9130	" " " Guide Bracket with 440c, for 148-4 Machine.....
128067	9116	Presser Bar Connecting Bracket with 448c and 453c, for 148-4 Machine....
128068	9130	Lifting Presser Lifter, for 148-7 Machine
128068	9130	Presser Bar Lifter, for 148-4 Machine ..
128069	9130	Lifting Presser Bar Lifter Connecting Link, for 148-7 Machine
128069	9130	Presser Bar Lifter Connecting Link for 148-4 Machine.....
128070	9128	Lifting Presser Bar Lifting Lever, for 148-7 Machine.....
128070	9128	Presser Bar Lifting Lever, for 148-4 Machine
128071	9112	Lifting Presser Bar Lifting Lever Extension, for 148-7 Machine.....
128071	9112	Presser Bar Lifting Lever Extension for 148-4 Machine.....
128077	9128	Tension (under thread) Releasing Lever for 128269.....
128078	9131	Tension (under thread) Releasing Pin...
128081	9131	" (upper thread) Bracket Thread Eyelet Screw Washer
128081	9131	Thread (under) Pull-off Stripper Screw Washer.....
128081	9131	Thread (under) Take-up Stripper Screw Washer.....
128083	9135	Tension Releasing Arm with 51818.....
128084	9135	" " " Connecting Rod
128087	—	Thread (under) Nipper Cam Oil Pad (felt) for 128089.....
128088	—	Thread (under) Nipper Cam Oil Pad Holder for 128089.....
128089	9132	Thread (under) Nipper Cam Oil Pad Holder 128088 with 128087.....
128098	9133	Thread (under) Take-up Stripper Bracket
128100	9133	" " " Thread Guard Bracket.....
128101	9133	Thread (under) Take-up Thread Guard Spring
128105	9134	Thread (under) Frame Cover Hinge Pin for 128244 and 128298.....

NO	PLATE	NAME
128110	9136	Thread (upper) Check Spring.....
128111	9136	“ “ “ “ Adjusting Plate.....
128112	9101	Thread (upper) Check Spring Regulating Stud.....
128116	9119	Machine Base with 304c, 307c, 448c, 1513b, 27795, two each 935b, 42088, 66707 and three wood screws 1½ in. No. 12.....
128117	9129	Needle Bar Connecting Stud with 207e, for 128210.....
128122	----	Feed (lower) Lifting Eccentric 128042 with 54953, for 128404.....
128127	----	Cylinder End Cover complete 128012 with 1174w, 36586, 36598 and two 211w, for 148-7 Machine.....
128128	9102	Cylinder End Cover Slide (back) 54625 with 54627 and 55165, for 128012 and 128270.....
128136	9119	Arm Rock Shaft for 148-7 Machine
128138	9104	“ “ “ Crank (front) with 128145 and two 50135c, for 148-7 Ma- chine.....
128140	9123	Feed (lower) Connection with 128039 and two 896e, for 128103.....

Nos. 128141 TO 128146 FOR 148-7 MACHINE

128141	9116	Feed (upper) Bar.....
128142	9116	“ “ “ Bell Crank (forked)...
128143	9116	“ “ “ “ Connecting Link.....
128144	9116	Feed (upper) Bar Bell Crank Connecting Link Hinge Stud (left).....
128145	9104	Feed (upper) Bar Bell Crank Connecting Link Hinge Stud (right) for 128138...
128146	9116	Feed (upper) Bar Hinge Bracket with two 50150c.....

Nos. 128148 TO 128152 FOR 148-7 MACHINE

128148	9104	Feed (upper) Regulator.....
128149	9101	“ “ “ Hinge Stud.....
128150	9123	“ “ “ Pitman.....
128151	9123	“ “ “ “ Conne- tion with 193F.....
128152	9116	Feed (upper) Regulator Pitman Conne- tion Hinge Stud.....

NO. PLATE NAME

Nos. 128158 TO 128161 FOR 148-7 MACHINE

128158	9130	Lifting Presser Bar (lower).....
128159	9130	“ “ “ “ Bushing.....
128160	9130	“ “ “ “ Guide Bracket with 1454E.....
128161	9116	Lifting Presser Bar (lower) Guide Bracket Guide.....
128168	9133	Thread (upper) Controller Lever Con- nection Bracket for 148-7 Machine...
128171	9119	Belt Guard (lower) for 128173.....
128172	9119	“ “ (upper) for 128173.....
128173	----	Belt Guard complete, Nos. 331b, 2273, 63505, 128171, 128172, 743382 and three wood screws 1 in. No. 10.....
*128174	----	Feed Eccentric Body with two 1143c, for 128041.....
*128174	----	Feed (lower) Eccentric Body with two 1143c, for 128041.....
128186	9128	Lifting Presser Bar Spring (flat) for 148-7 Machine.....
128186	9128	Presser Bar Spring (flat) for 148-4 Ma- chine.....
128188	----	Presser Foot Leveling Plate for 128219..
128189	9129	“ “ “ “ Spring for 128357, obsolete.....
128191	9129	Presser Foot Needle Plate Spring, for 128219 and 128357.....
128192	----	Presser Foot Plate for 128219.....
128193	----	“ “ Shank for 128219.....
*128196	----	Arm for 148-4 Machine.....
*128197	----	Cylinder with 447c, 452c, 460c, 50150c, 54664, 128032, 128033 and two 391b.
128198	9124	Cylinder Rock Shaft for 128272 and 128403.....
128199	9122	Cylinder Thread Eyelet for 128268.....
128200	9122	“ “ “ “ Thread Guard, for 128268.....
128201	9123	Face Plate.....
128202	9125	Feed Dog, 10 teeth (8 teeth to the inch) for ⅛ in., ⅜ in. and ½ in. gauges be- tween each needle, for 148-4 Machine
128202	9125	Feed (lower) Dog, 10 teeth (8 teeth to the inch) for ⅛ in., ⅜ in. and ½ in. gauges between each needle for 148-7 Machine.....

NO.	PLATE	NAME
128203	9122	Feed Lifting Eccentric with two 462c, for 128273.....
128207	9140	Looper Carrier (double) with 1454c, for 128204 and 128205, obsolete use 128351
128208	9127	Looper Carrier (single) with 1454c, for 128415.....
128209	—	Needle Bar complete, for 148-4 Machine, Nos. 54708 and 128215.....
128210	—	Needle Bar Connecting Stud complete, for 128274, Nos. 220d, 10107, 128117, 128211, 128213, 128214 and two each 42348 and 128212.....
Nos. 128211 TO 128214 FOR 128210		
128211	9129	Needle Bar Thread Retainer Bracket with two 238d.....
128212	9129	Needle Bar Thread Retainer Separating Disc.....
128213	9129	Needle Bar Thread Retainer Stud.....
128214	9129	“ “ “ “ Thread Guide.....
128215	9129	Needle Clamp with three 1498f, for 128209 and 128400.....
128216	9129	Needle Guard, for $\frac{1}{8}$ in., $\frac{9}{32}$ in. and $\frac{5}{32}$ in. gauges, for 148-4 and 148-7 Machines
128217	—	Presser Foot Needle Plate for 128219....
128219	9126	Presser Foot (hinged) complete, for $\frac{1}{8}$ in., $\frac{9}{32}$ in. and $\frac{5}{32}$ in. gauges, for 148-4 Machine, Nos. 1368j, 11184, 128188, 128192, 128193, 128217, 128367, 128368, and two each 665c, 50594c and 128191
128220	9128	Tension (under thread) Bracket, for 128269.....
128221	9131	Tension (under thread) Releaser (lower) for 128269.....
128222	9131	Tension (under thread) Releaser (upper) for 128269.....
128223	9135	Tension (upper thread) Bracket with three 447c.....
128224	9131	Tension (upper thread) Bracket Thread Eyelet (double).....
128225	9131	Tension (upper thread) Releasing Pin...
128226	9135	“ “ “ “ Shaft
128227	9131	“ “ “ “ “
		Collar with two 735c.....
128228	9132	Tension (upper thread) Releasing Shaft Crank with 457c.....

NO.	PLATE	NAME
128229	9132	Tension (upper thread) Releasing Shaft Crank Link Bracket.....
128230	9132	Thread (under) Eyelet.....
Nos. 128231 TO 128234, OBSOLETE		
128231	9132	Thread (under) Guide (back).....
128232	9132	“ “ “ (centre).....
128233	9132	“ “ “ (front).....
128234	9132	Thread (under) Guide Bracket with three 906c.....
128235	9132	Thread (under) Nipper Cam with 61121 and two 465c.....
128236	9134	Thread (under) Nipper Spring (lower)...
128237	9134	“ “ “ “ (upper) for 148-4 Machine.....
128238	9134	Thread (under) Protector.....
128239	9134	“ “ Pull-off.....
128240	9134	“ “ “ Stripper.....
128241	9134	“ “ Separator for 128268....
128242	9134	“ “ Take-up with two 465c
128243	9135	“ “ Frame for 128244 and 128298.....
128244	—	Thread (under) Take-up Frame complete, Nos. 128103, 128243 and 128245....
128245	9135	Thread (under) Take-up Frame Cover with 50150c, for 128244, obsolete.....
128246	9133	Thread (under) Take-up Knife.....
128247	9133	“ “ “ “ Holder with 465c.....
128248	9133	Thread (under) Take-up Stripper.....
128249	9133	“ “ “ Thread Guard with 220d.....
128250	9133	Thread (upper) Controller.....
128250	9133	“ “ “ Thread Guide
128251	9136	“ “ “ “ “ Post with 50138d.....
128252	9136	Thread (upper) Take-up.....
128253	9136	“ “ “ Stripper.....
128254	9136	“ “ “ “ Bracket
128255	9125	Throat Plate for 128202.....
128262	9122	Arm Rock Shaft Crank (back) with two 50083c, for 128264.....
128264	9124	Crank Connecting Rod complete, Nos. 217d, 1722E, 1723E, 54616, 54925, 55034 and 128267.....
*128265	—	Crank Connecting Rod Cap (upper) for 128267.....

NO.	PLATE	NAME
*128266	----	Crank Connecting Rod End Bearing (upper) for 128267.....
*128267	----	Crank Connecting Rod Head (upper) Nos. 51043c, 128265, 128266 and two 171e, for 128264.....
128268	----	Cylinder Thread Eyelet 128199 with 662d, 128200 and 128241.....
128269	----	Tension (under thread) Bracket 128220 with 233b, 1144b, 50076b, 63821, 128077, 128221, 128222 and two 337b.
128270	----	Cylinder End Cover complete, for 128305, Nos. 128128, 128306, two 128271, three 1231w and four 405b.....
128271	9122	Cylinder End Cover Lock Spring for 128270.....
128272	----	Cylinder Rock Shaft Connection 128018 with 128038, 128041 and 128198, for 128275.....
128273	----	Feed Lifting Eccentric 128203 with 54953, for 128275.....
128274	----	Needle Bar Connecting Link 54711 with 54712 and 128210.....
128275	----	Hand Wheel and Pulley Shaft 128340 with 128045, 128272, and 128273, for 148-4 Machine.....
128298	----	Thread (under) Take-up Frame complete, Nos. 128105, 128243 and 128299.....
*128299	9135	Thread (under) Take-up Frame Cover with 50150c, for 128298.....
128305	----	Cylinder End Cover complete 128270 with 1174w, 36586, 36598 and two 211w, for 148-4 Machine.....
128306	9124	Cylinder End Cover for 128270.....
*128334	----	Hand Wheel for 128335.....
128335	9137	" " and Pulley, Nos. 128334, 128337 and two 50084c.....
128336	9128	Hand Wheel and Pulley Shaft for 128340
*128337	----	Pulley, 2 $\frac{7}{8}$ in. diam., for 128335.....
128340	----	Hand Wheel and Pulley Shaft 128336 with 54616, for 128275 and 128404...
128348	9126	Feed Dog 18 teeth (16 teeth to the inch) for $\frac{3}{8}$ in. and $\frac{7}{4}$ in. gauges between needles, for 148-4 Machine.....
128349	9127	Looper Carrier with 1454c, for 128351 and 128398.....

NO.	PLATE	NAME
128350	9127	Looper Carrier for 128351 and 128414...
128351	----	" " (double, adjustable), Nos. 128349 and 128350, for 148-4 Machine
128352	9129	Needle Guard, for $\frac{3}{8}$ in. and $\frac{7}{4}$ in. gauges, for 148-4 Machine.....
Nos. 128353 to 128355 FOR 128357		
128353	----	Presser Foot Leveling Plate.....
128354	----	" " Needle Plate.....
128355	----	" " Plate.....
128356	----	" " Shank for 128357 and 128375
128357	9126	Presser Foot (hinged) complete, for $\frac{3}{8}$ in. and $\frac{7}{4}$ in. gauges, for 148-4 Machine, Nos. 13681, 11184, 128353 to 128356, 128368, 128416 and two each 665c, 50594c and 128191.....
128358	9126	Throat Plate for 128348.....
128367	9129	Presser Foot Leveling Plate Spring for 128219 and 128375.....
128368	9129	Presser Foot Needle Plate Spring Stop for 128219.....
128369	9125	Feed Dog 18 teeth (16 teeth to the inch) for $\frac{1}{8}$ in. and $\frac{9}{4}$ in. gauges between needles, for 148-4 Machine.....
Nos. 128370 to 128374 FOR 128375		
128370	----	Presser Foot Leveling Plate.....
128371	----	" " Needle Plate.....
128372	9129	" " " " Spring (left).
128373	9129	" " " " " (right)
128374	----	" " Plate.....
128375	9126	Presser Foot (hinged) complete, for $\frac{1}{8}$ in. and $\frac{3}{2}$ in. gauges, for 148-4 Machine, Nos. 13681, 11184, 128356, 128368, 128370 to 128374, 128417 and two each 6651 and 50594c.....
128376	9125	Throat Plate for 128369.....
128382	9122	Lifting Presser Foot Hinge Pin for 128396
128384	----	" " " Shank for 128396...
128387	9132	Thread (under) Guide.....
128388	9127	Hand Wheel and Pulley Shaft Flanged Bushing (left).....
*128389	----	Arm for 148-7 Machine.....
Nos. 128390 to 128392 FOR 128393		
128390	9122	Feeding Foot Hinge Stud.....
128391	----	" " Plate.....
128392	----	" " Shank.....

NO.	PLATE	NAME
128393	9126	Feeding Foot (hinged) complete for 148-7 Machine, Nos. 128391, 128392 and two each 664w and 128390.....
128394	—	Lifting Presser Foot Plate for 128396....
128396	9126	Lifting Presser Foot (hinged) complete for 148-7 Machine, Nos. 128382, 128384 and 128394.....
128397	9127	Looper Carrier with 735c, for 128205 and 128398.....
128398	—	Looper Carrier (adjustable) Nos. 128349 and 128397, for 148-7 Machine.....
128399	9128	Needle Bar (hollow) for 128400.....
128400	—	Needle Bar complete, for 148-7 Machine, Nos. 128215 and 128399.....
128401	9130	Lifting Presser Bar (upper) Guide Bracket with 440c, for 148-7 Machine.....
128402	—	Thread (under) Nipper Spring (upper) for 148-7 Machine.....
128403	—	Cylinder Rock Shaft Connection 128018 with 128041, 128140 and 128198, for 128404.....
128404	—	Hand Wheel and Pulley Shaft 128340 with 128045, 128122 and 128403, for 148-7 Machine.....
128412	9703	Feed Dog, 12 teeth (8 teeth to the inch) for $\frac{1}{8}$ in., $\frac{3}{4}$ in. and $\frac{3}{2}$ in. gauges, for heavy work.....
128413	9127	Looper (back).....
128414	9127	“ (centre).....
128415	9127	“ (front).....
128416	9127	Presser Foot Leveling Plate Spring for 128357.....
128417	9127	Presser Foot Leveling Plate Spring for 128375.....
128418	9703	Throat Plate for 128412.....
200383c	9140	Thread Unwinder Spool Rest Rod Set Screw for 202490.....
201018c	9140	Thread Unwinder Spool Rest Set Screw for 225395.....
201696j	9140	Thread Unwinder Thread Guide Lock Nut for 225378.....
202490	8997	Thread Unwinder Spool Stand with 200383c, for 225378.....
225378	8997	Thread Unwinder complete for six spools, Nos. 201696j, 202490, 225388, 225392, three 225395, six 225391 and three wood screws $\frac{1}{8}$ in. No. 12.....

NO.	PLATE	NAME
225388	8997	Thread Unwinder Spool Rest Rod for 225378.....
Nos. 225390 TO 225392 FOR 225378		
225390	7234	Thread Unwinder Thread Cone Holder, for inverted cones.....
225391	8997	Thread Unwinder Thread Guide.....
225392	8997	“ “ “ “ R o d with 208E and 225393.....
225393	9140	Thread Unwinder Thread Guide Rod Washer for 225392.....
225395	8997	Thread Unwinder Spool Rest (for two spools) with 201018c, for 225378.....
743382	9121	Belt Guard (upper) Lock Spring for 128173.....

Genuine Singer Needles and their Containers are marked with the Company's Trade Mark "SIMANCO." 1

Needles in Containers marked "For Singer Machines" are not Singer made needles. 2

**ILLUSTRATIONS OF PARTS
FOR
MACHINES
Nos. 148-4 and 148-7**

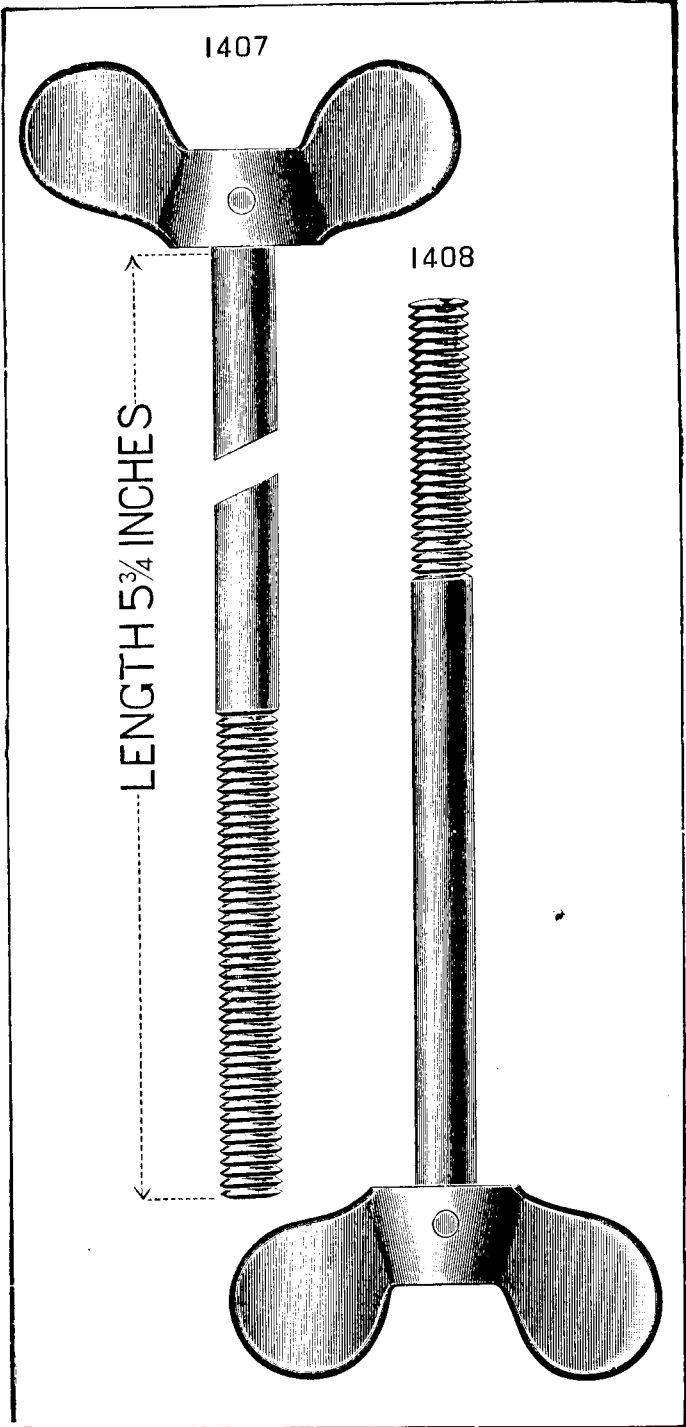

PLATE 6375—ONE-HALF SIZE

120344

26485

26026

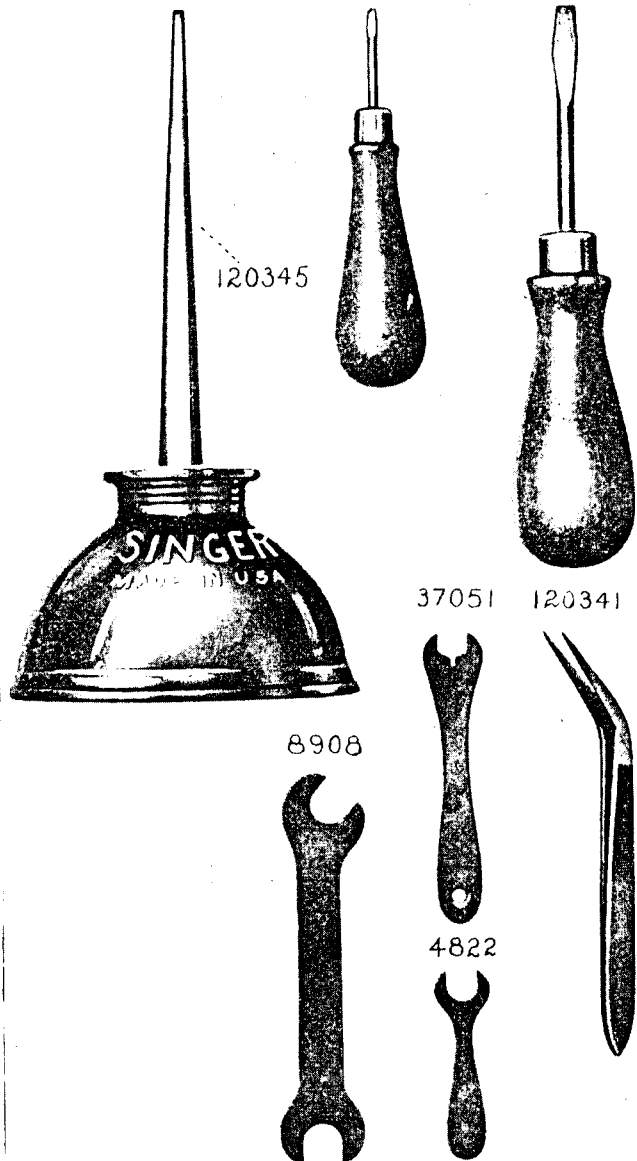

PLATE 7234—ONE-HALF SIZE

27739

225390

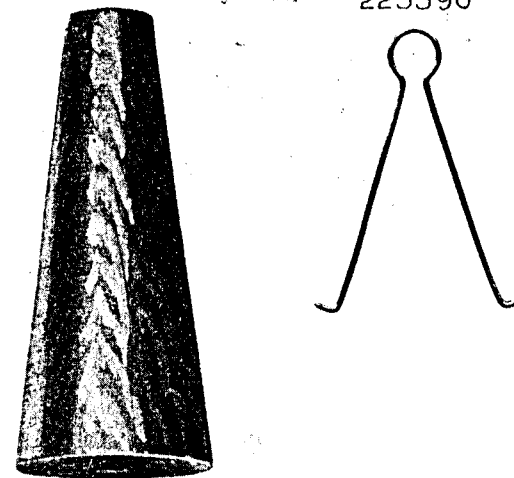

PLATE 8997—ONE-SIXTH SIZE

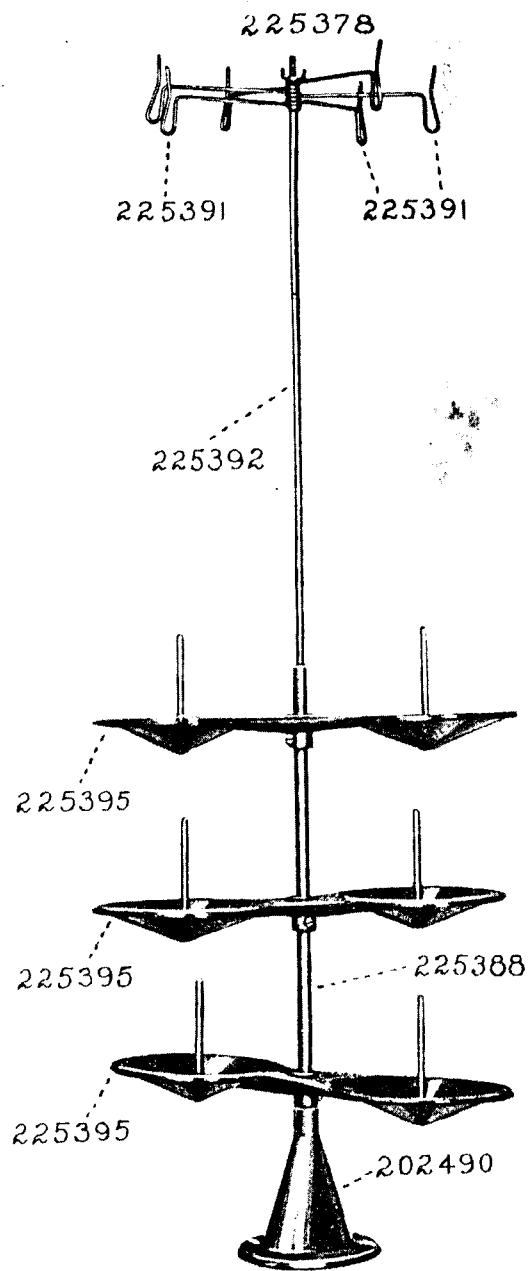

PLATE 9101—FULL SIZE

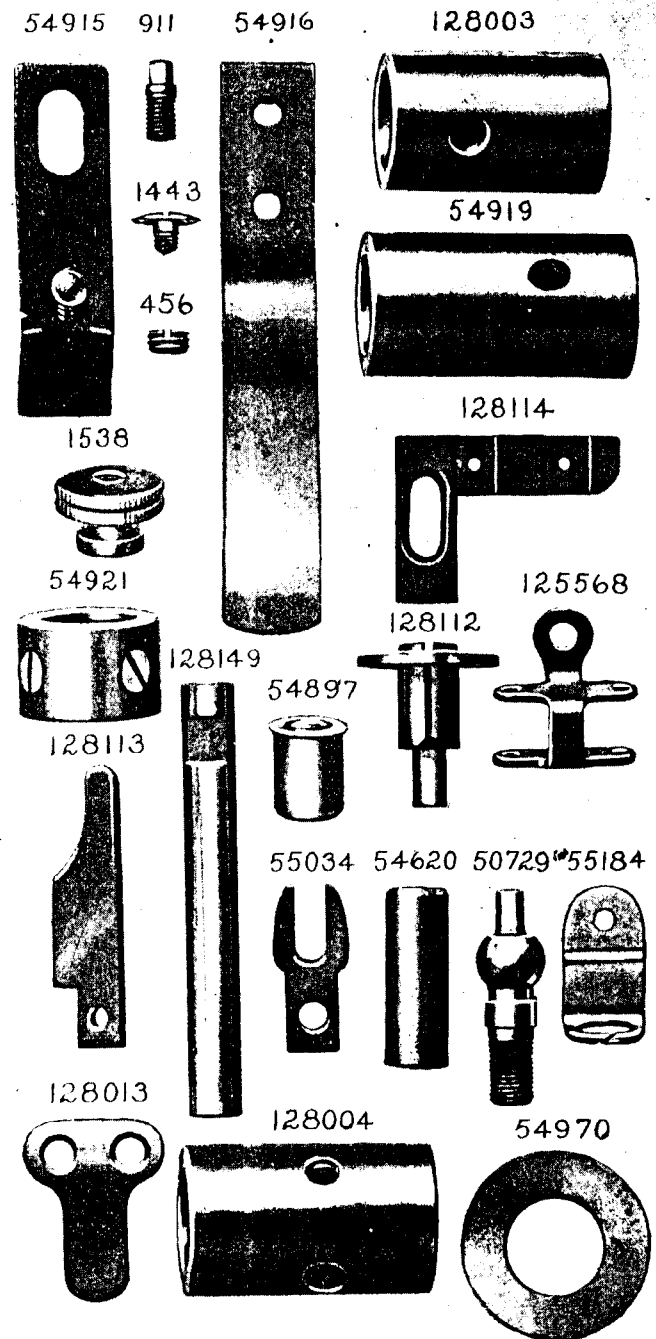

PLATE 9102—FULL SIZE

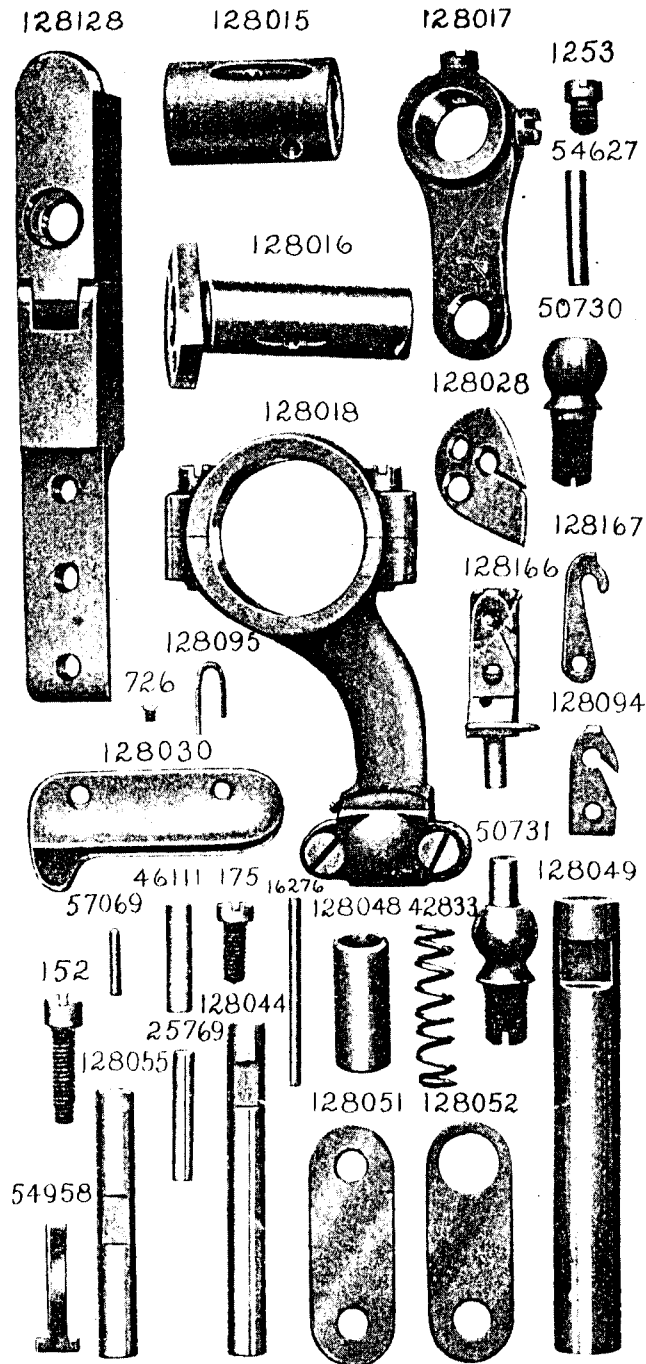

PLATE 9104—FULL SIZE

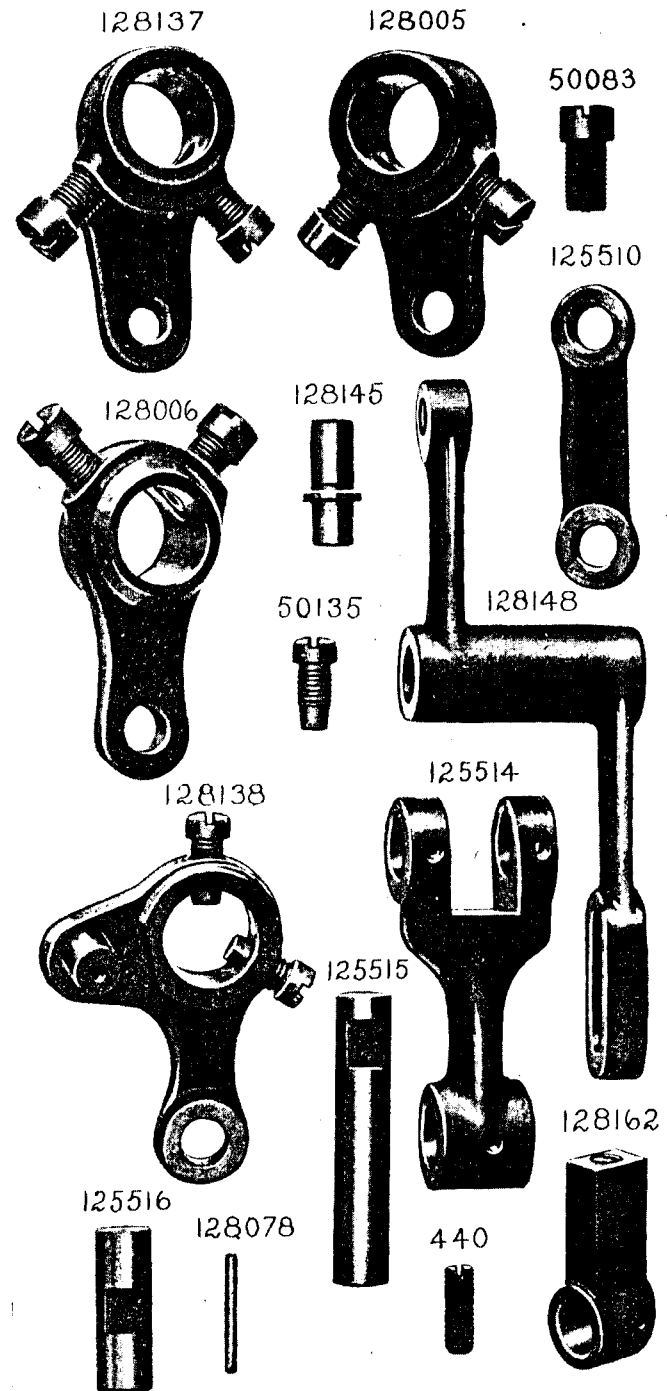
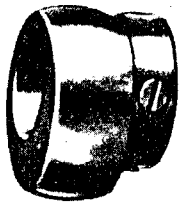
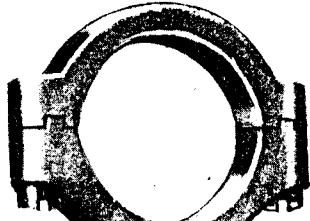

PLATE 9109—FULL SIZE

128042



54953



128041

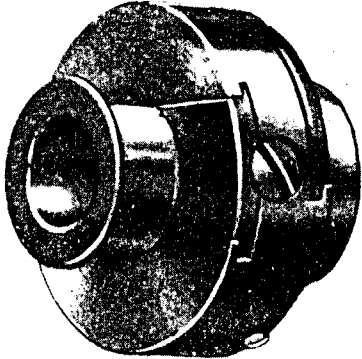

128034



128045

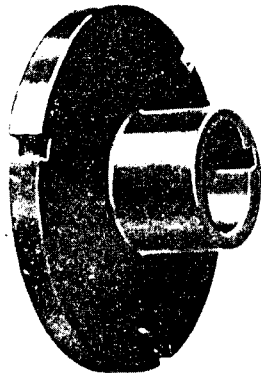

128007

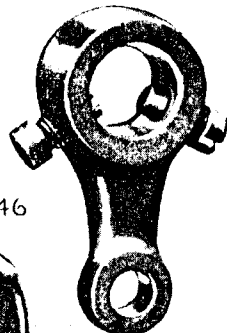

128046

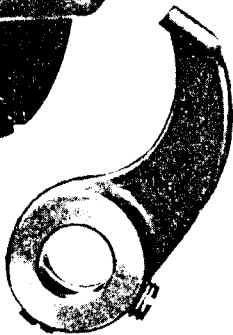

54664



198



1143



50589



PLATE 9112—ONE-HALF SIZE

128043

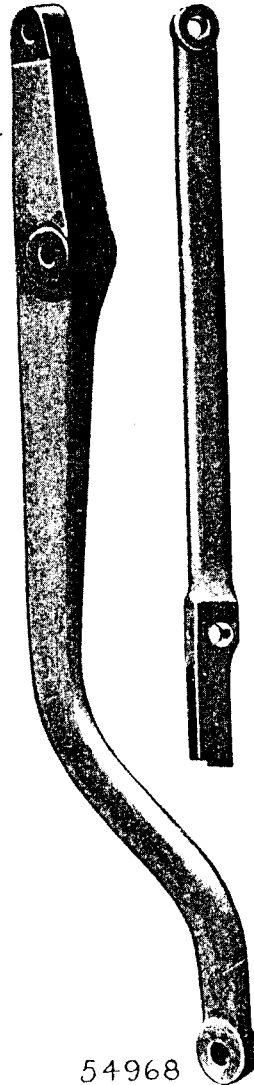

128050



128056



54708



128071



128038

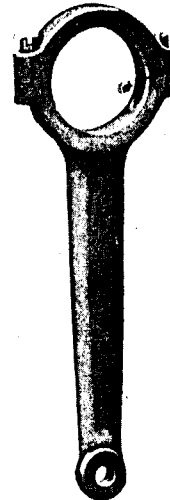

54968

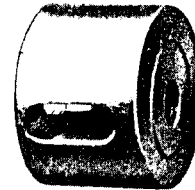

PLATE 9116—FULL SIZE

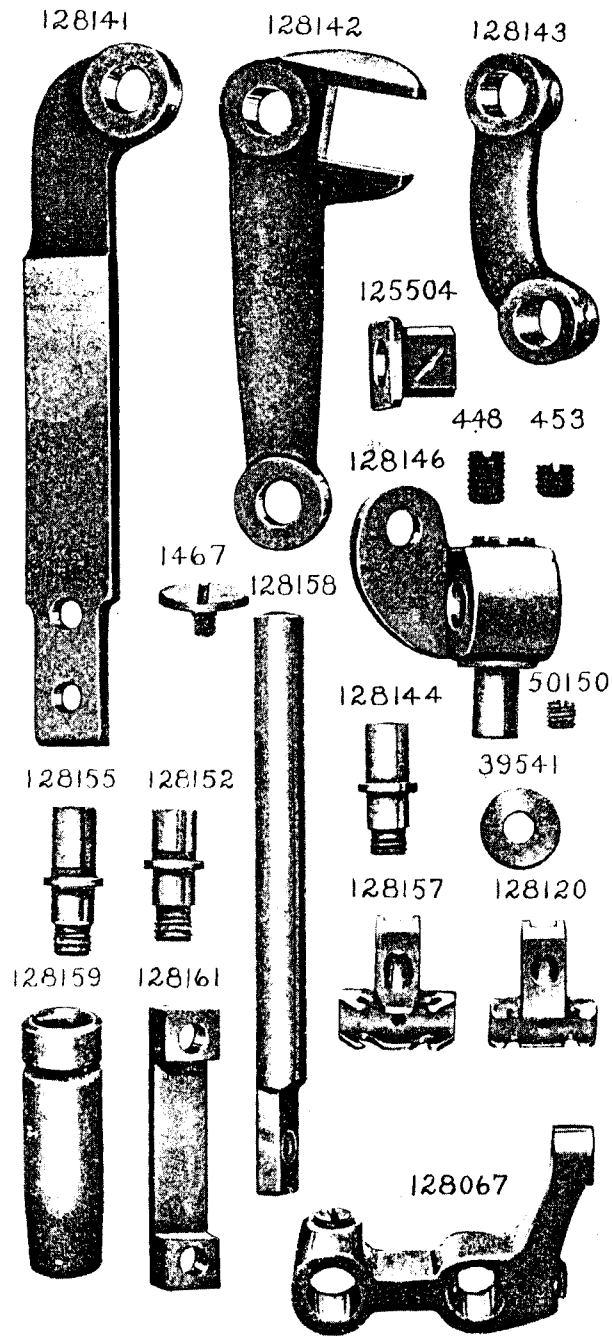

PLATE 9117—FULL SIZE

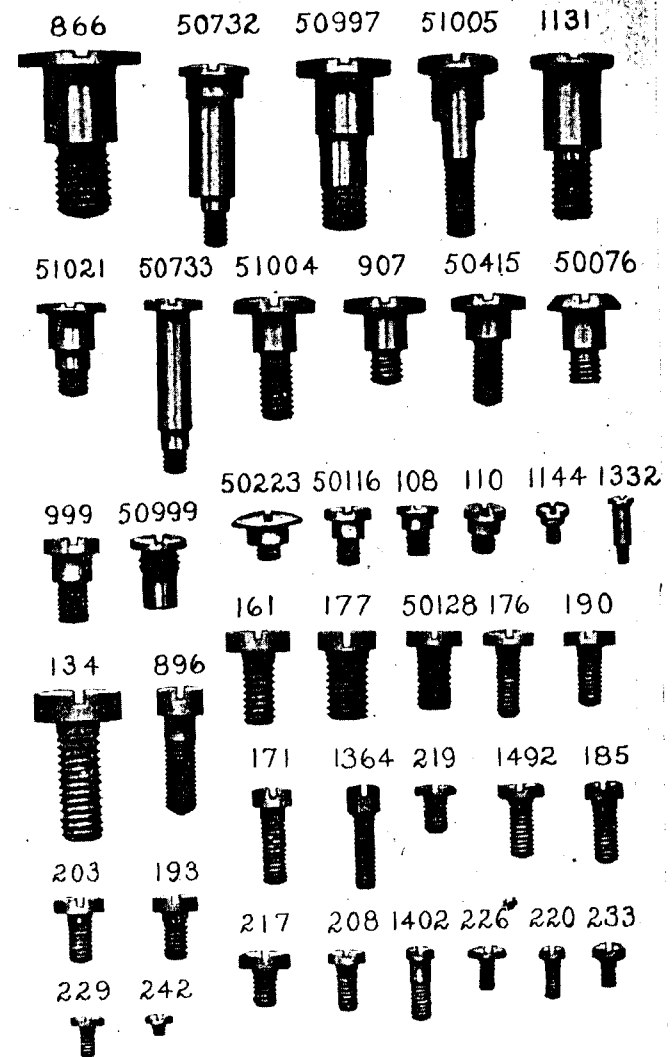

PLATE 9118—FULL SIZE

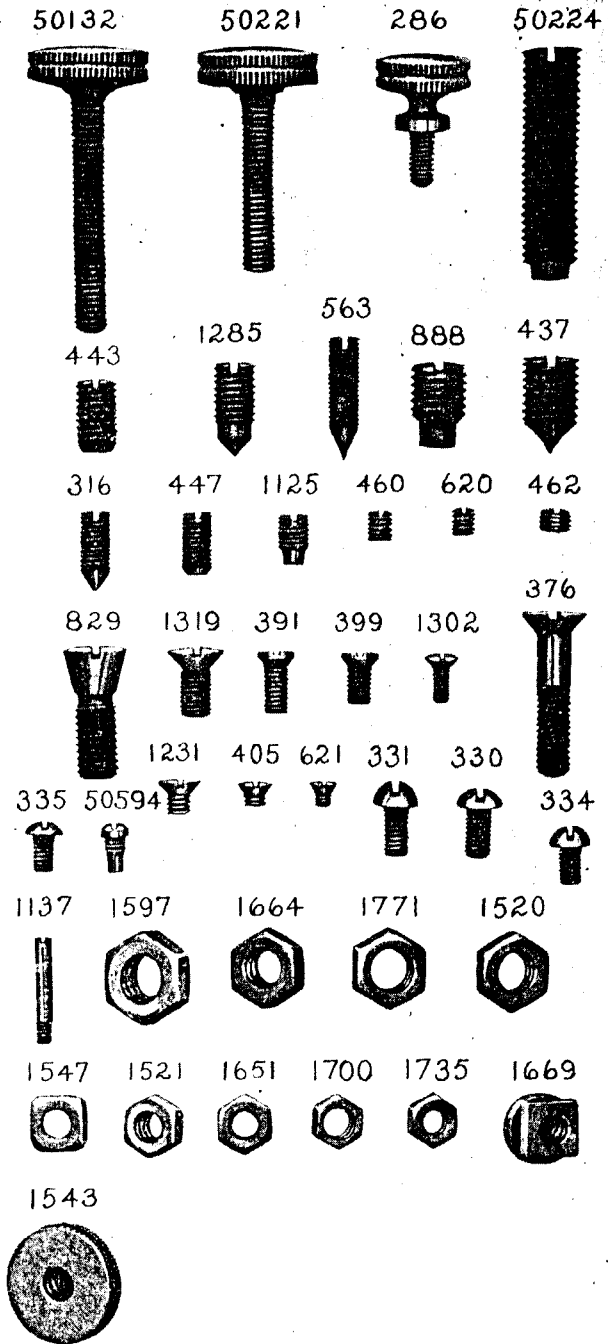

PLATE 9119—ONE-FOURTH SIZE

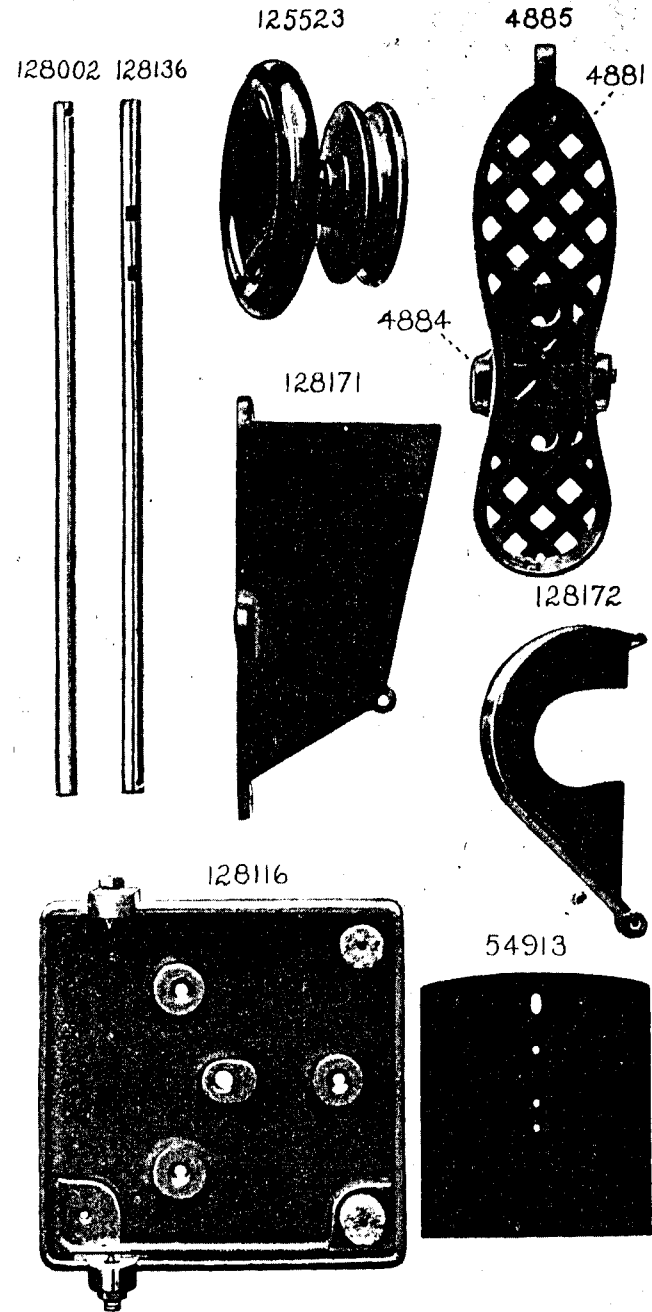

PLATE 9121—FULL SIZE

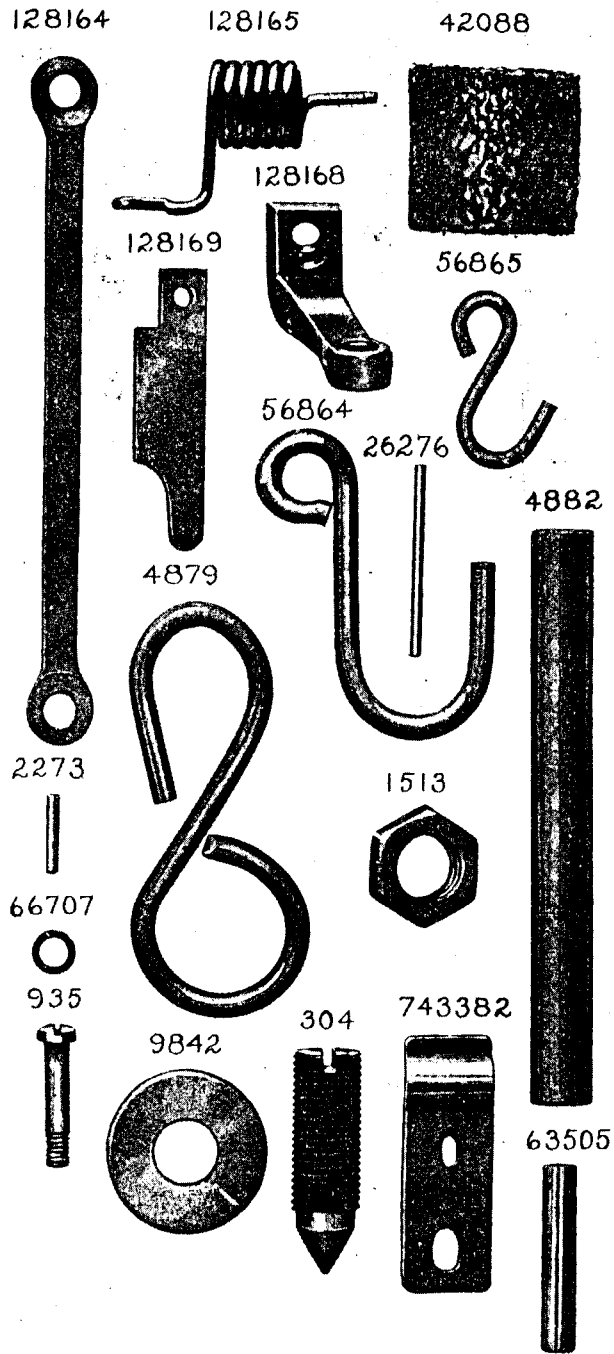

PLATE 9122—FULL SIZE

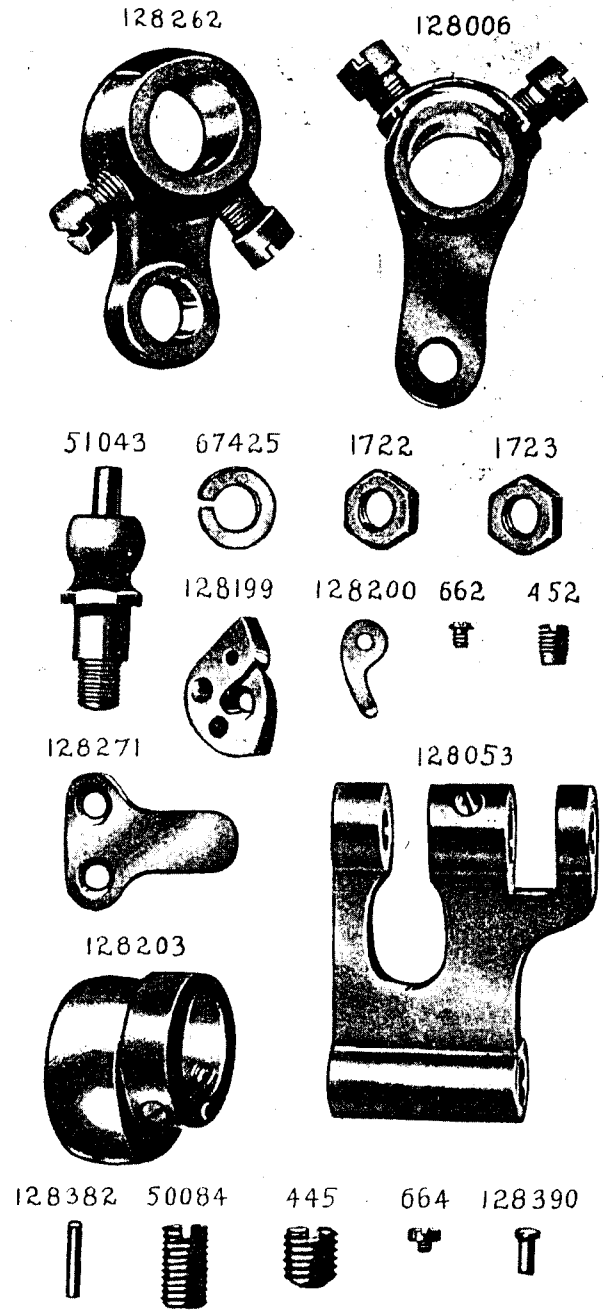
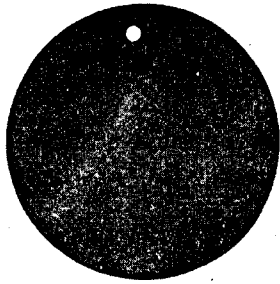
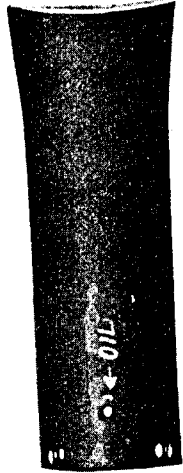

PLATE 9123—ONE-HALF SIZE

56016



128033



128151



128140



128201

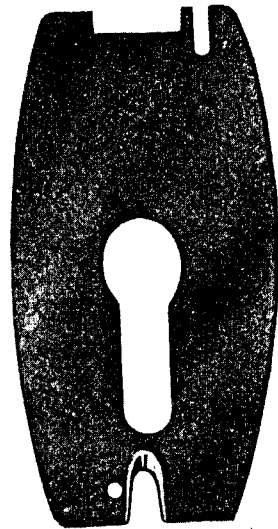

128047



128150

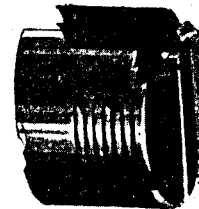

PLATE 9124—ONE-HALF SIZE

128021



128306



128011

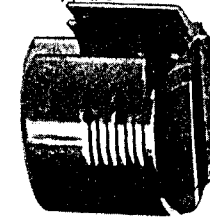

128264



128031

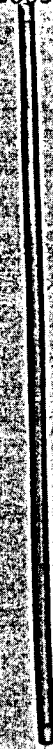

128032



128138



PLATE 9125—FULL SIZE

128255

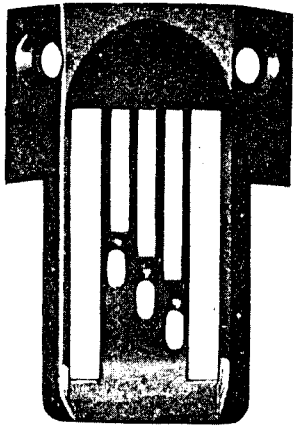

128202



128369

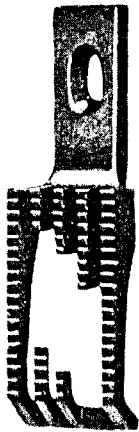

128376

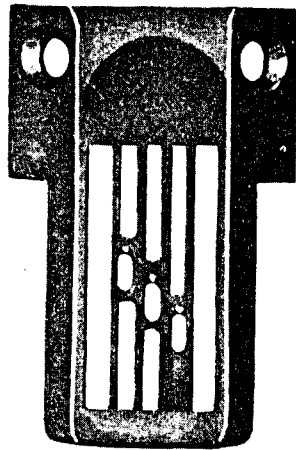
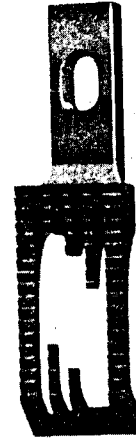

PLATE 9126—FULL SIZE

128348



128358



128357

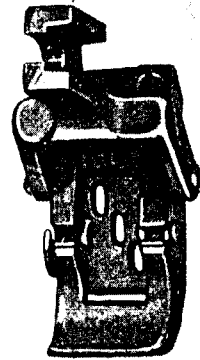

128393

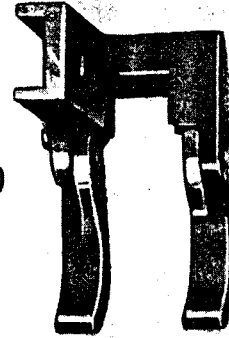

128396



128375

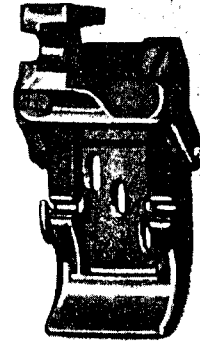

128219

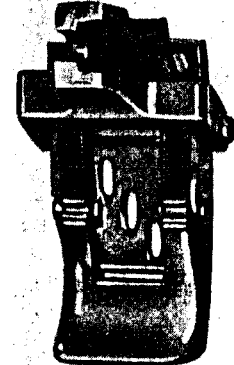

PLATE 8127-FULL SIZE

128854 41128



42365



150

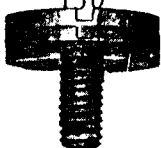

128388

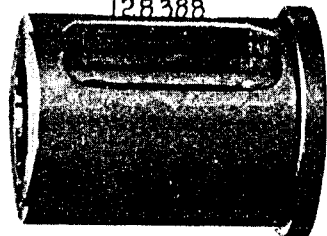

128413

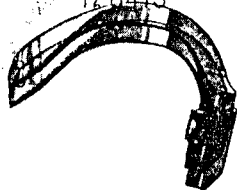

128414

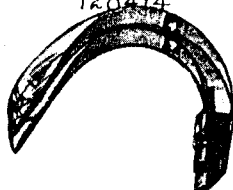

128415

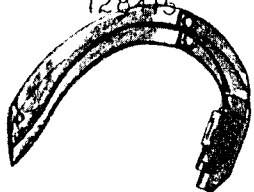

128349



128350

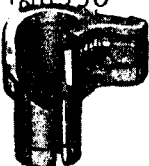

128397

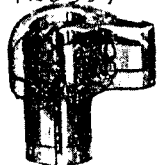

128208



1454



283



735



128416

128417



PLATE 8128-ONE-HALF SIZE

128336



128399



128065



128186



128878



128877

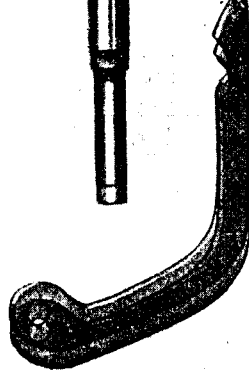

128228



PLATE 9129—FULL SIZE

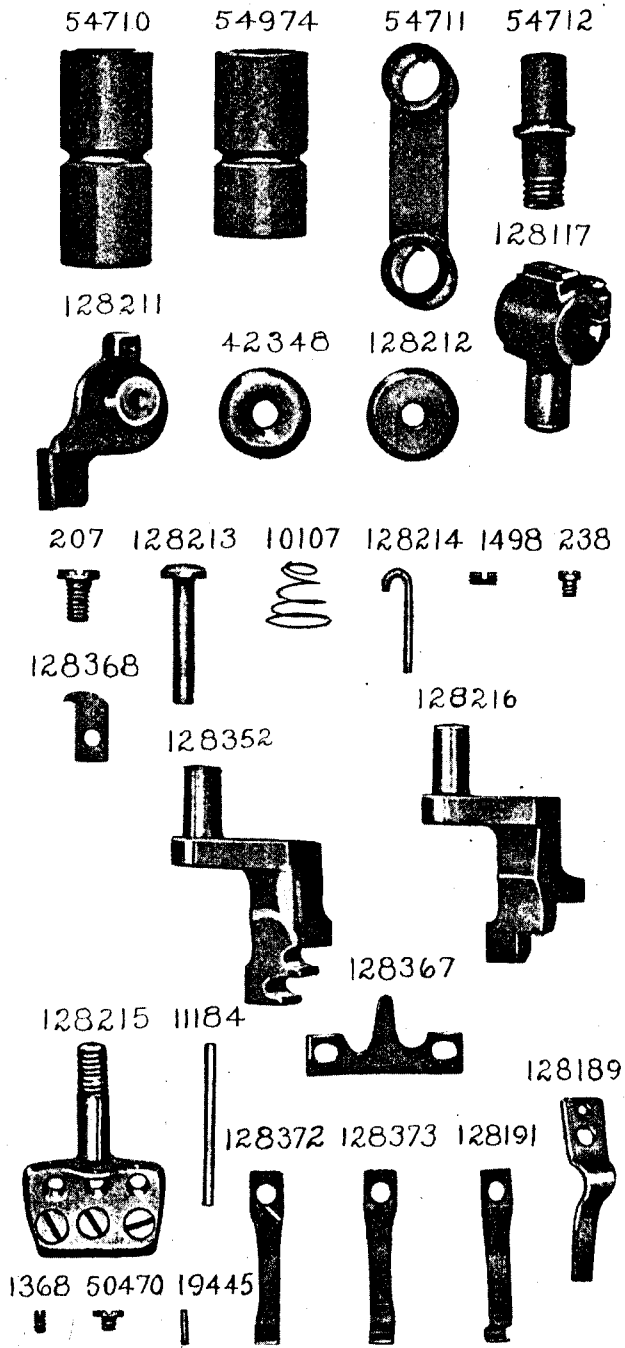

PLATE 9130—FULL SIZE

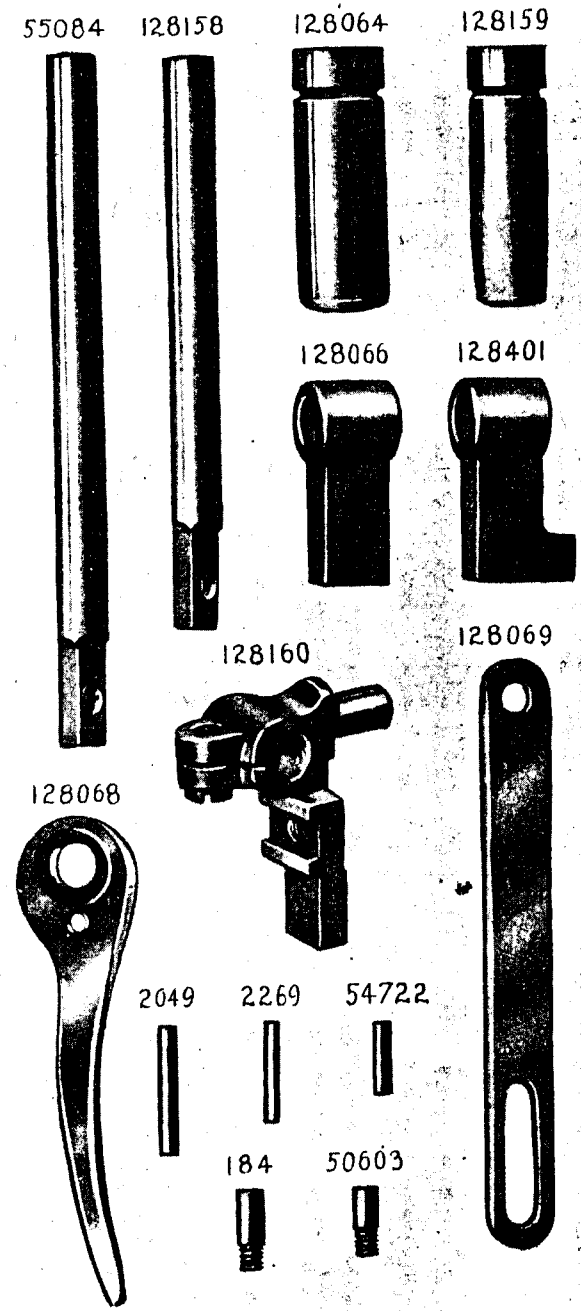

PLATE 8131-FULL SIZE

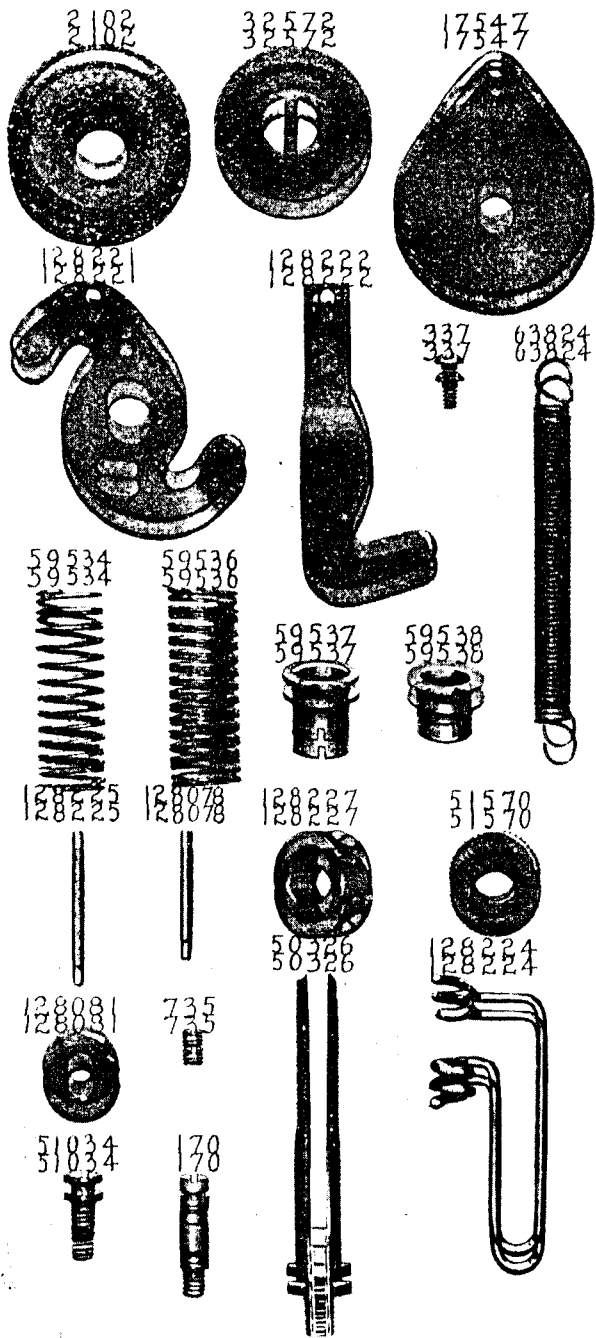

PLATE 8132-FULL SIZE

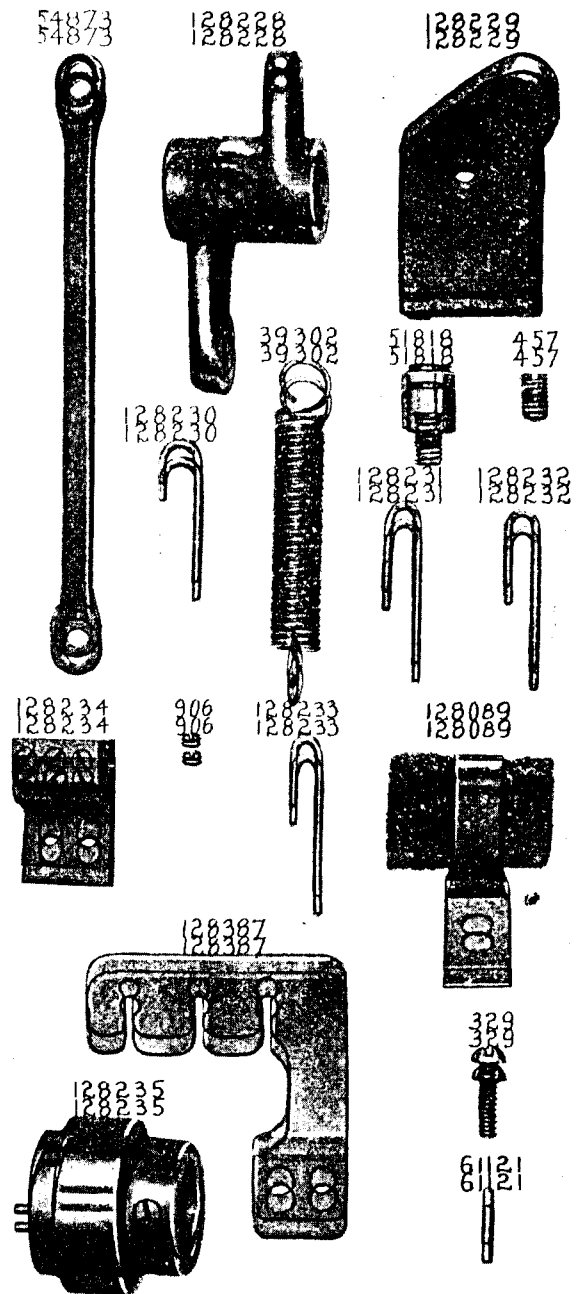
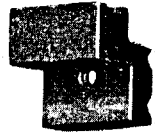

PLATE 9133—FULL SIZE

128246



128098



128249

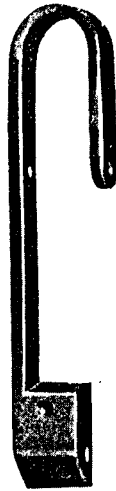

128248

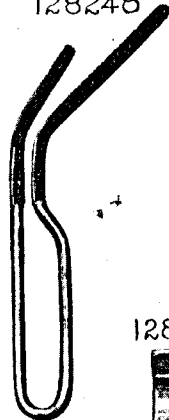

128100

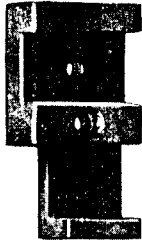

128101



128247



128250



125564



128168

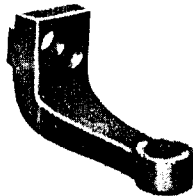

125567



209



50138



465



125566



PLATE 9134—FULL SIZE

128236



128237



128402



128240



128239

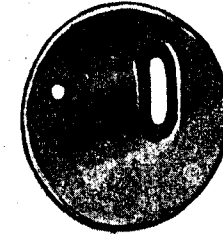

128238

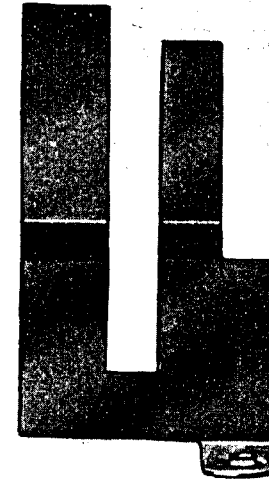

228



128241



128105



128242

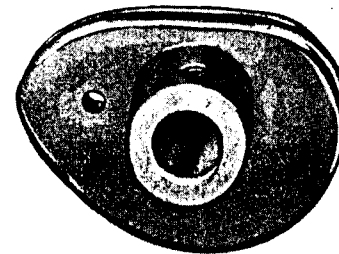

1149



PLATE 8135-ONE-HALF SIZE

128233

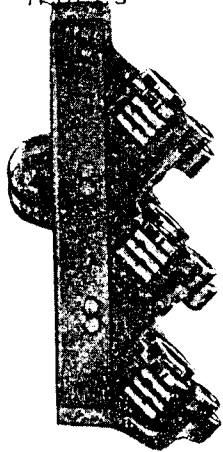

128228



128084



128083



54879
54879



128299

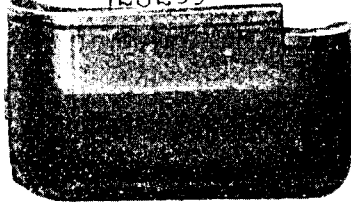

128245

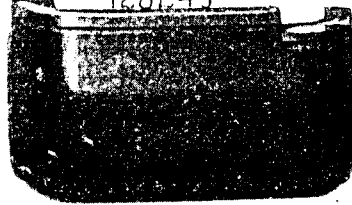

128243

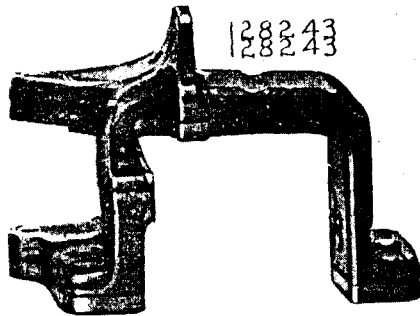

PLATE 8136-FULL SIZE

128251



128111



128118



128254



128253



128252

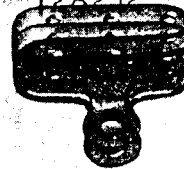

PLATE 9137—ONE-FOURTH SIZE

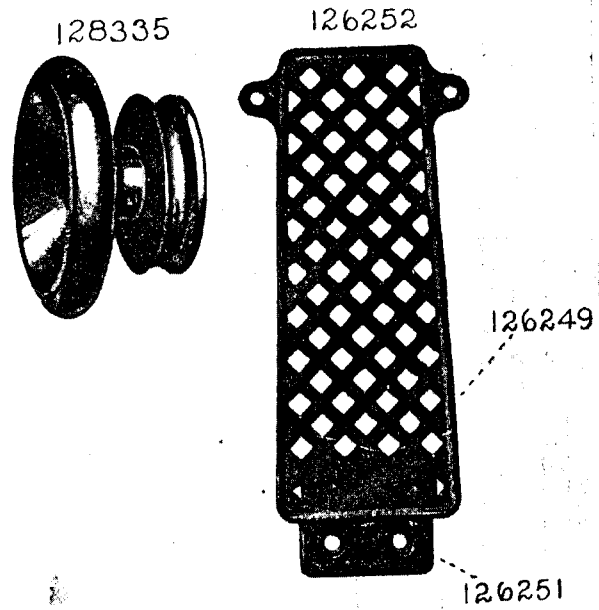

PLATE 9138—FULL SIZE

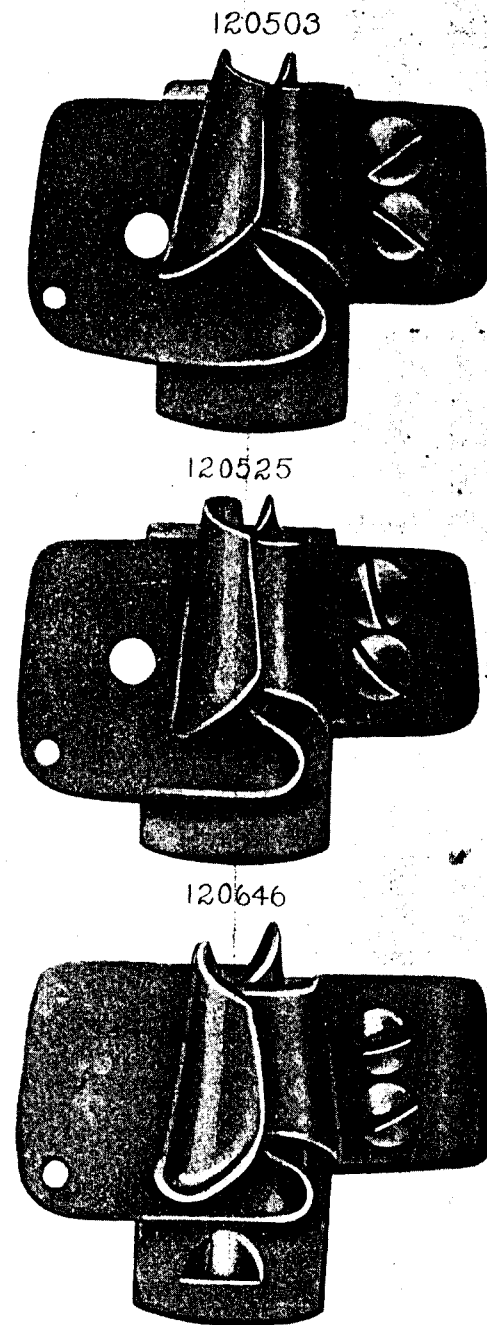
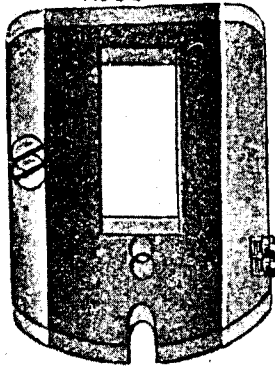
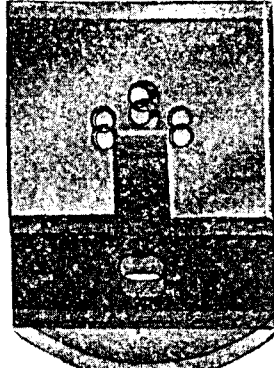

PLATE 9138-FULL SIZE

120644



36586



120526



30845



36598



1174



211



50169



665



10165



19294



1443



624



923



PLATE 9140-FULL SIZE

14063

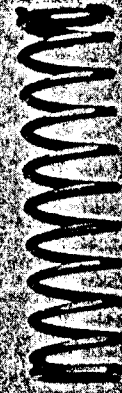

126250



307



27795

208



2909

20108



200363



225392



201696



128207

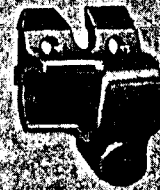

128057

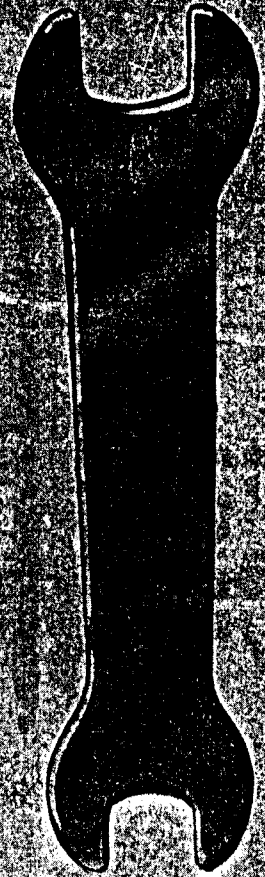

PLATE 9703—FULL SIZE

128412



128418



120777

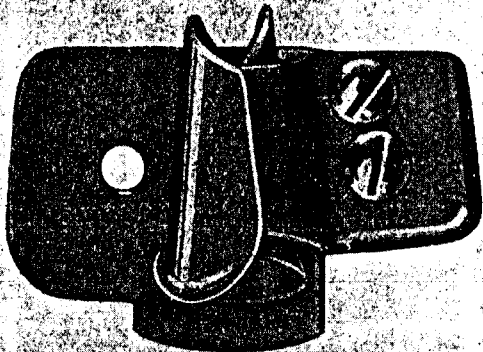

120778

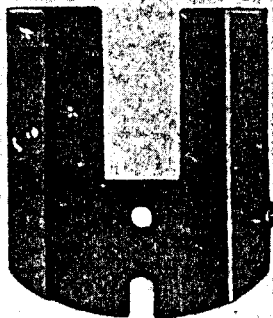

120779

