

SINGER

PARTS LIST

MODELS 153B8BV

CYLINDRICAL BED MACHINES

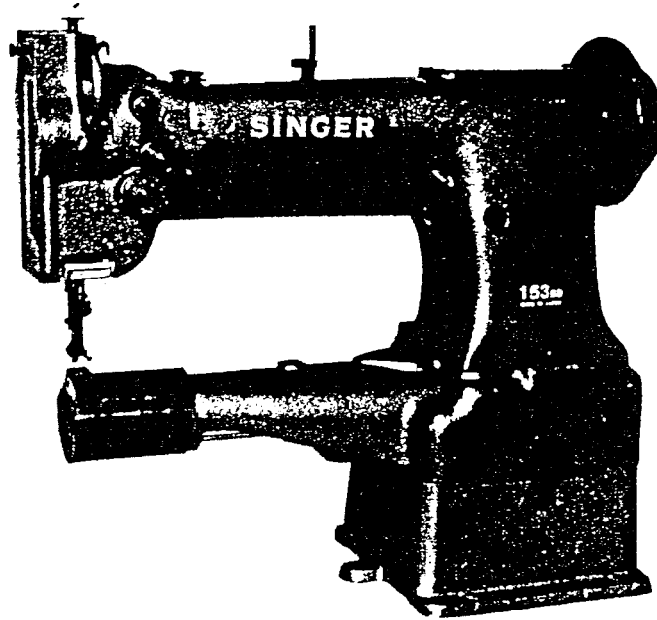

1

THREAD TAKE UP LEVER, NEEDLE BAR,

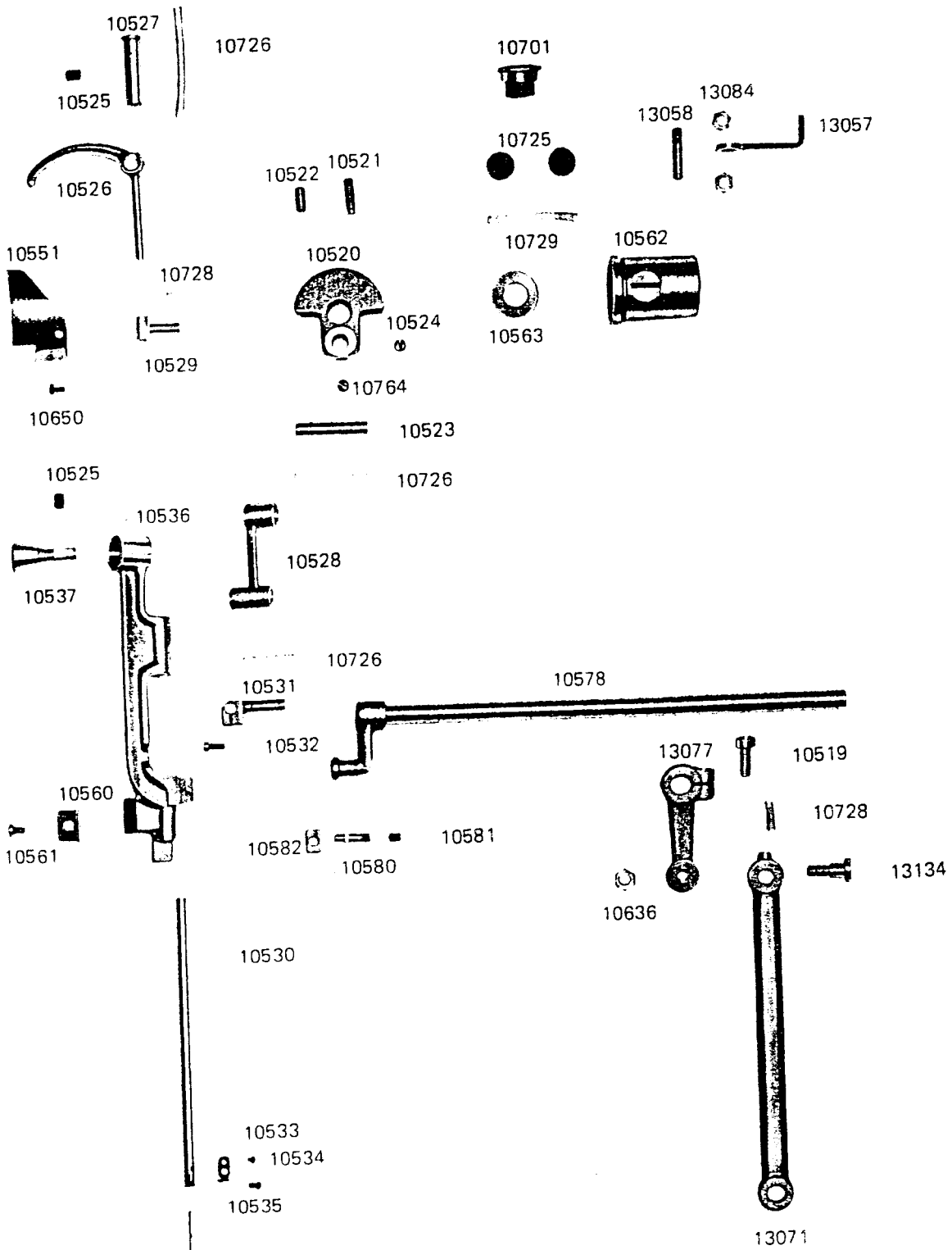

NOTE! WHEN ORDERING PARTS PREFIX ALL NUMBERS BY CS, EXAMPLE CS—

ARM SHAFT, FEEDING MECHANISM

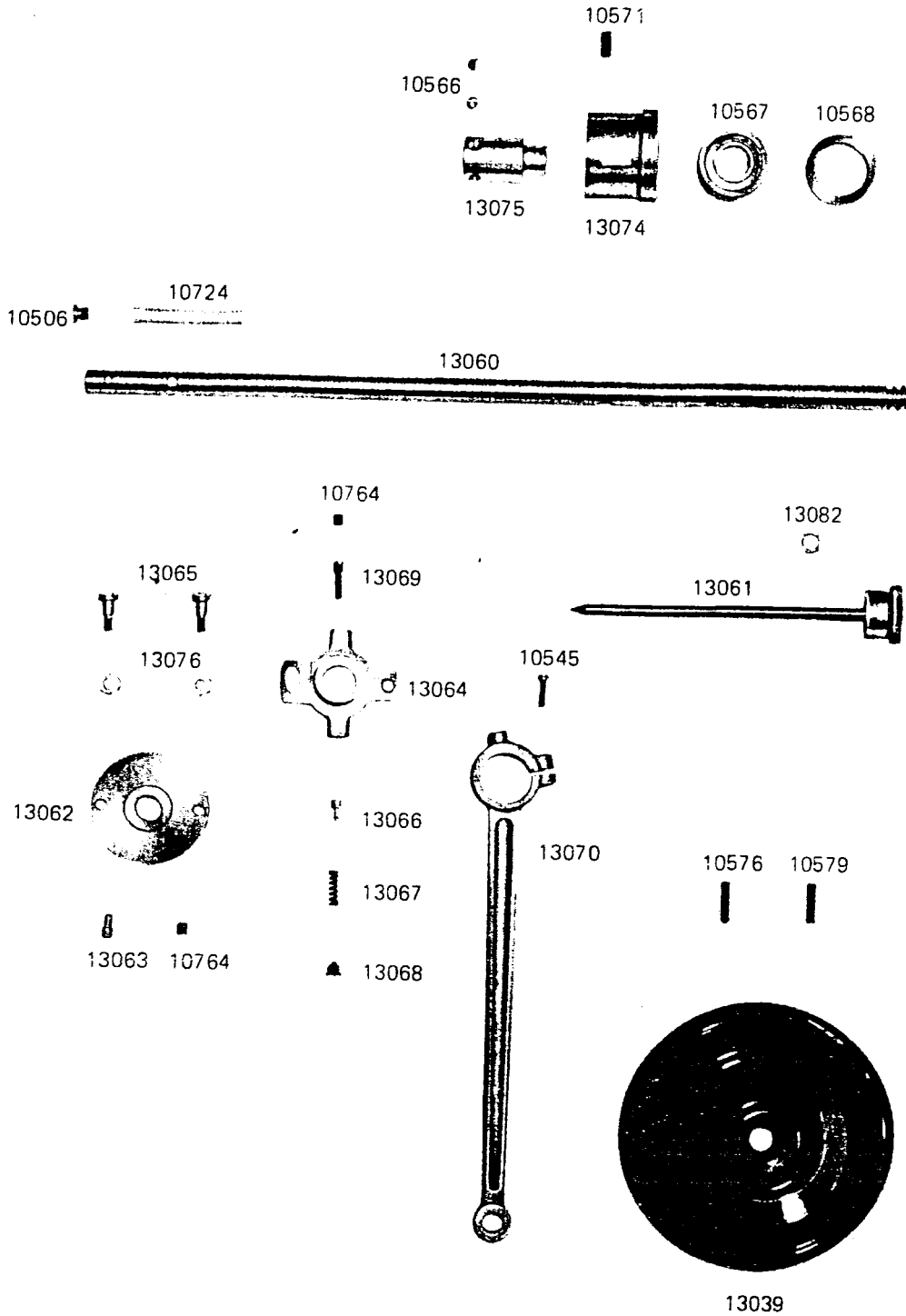

NOTE! WHEN ORDERING PARTS PREFIX ALL NUMBERS BY CS, EXAMPLE CS_

3

LIFTING LEVER, FACE PLATE, SLIDE PLATE

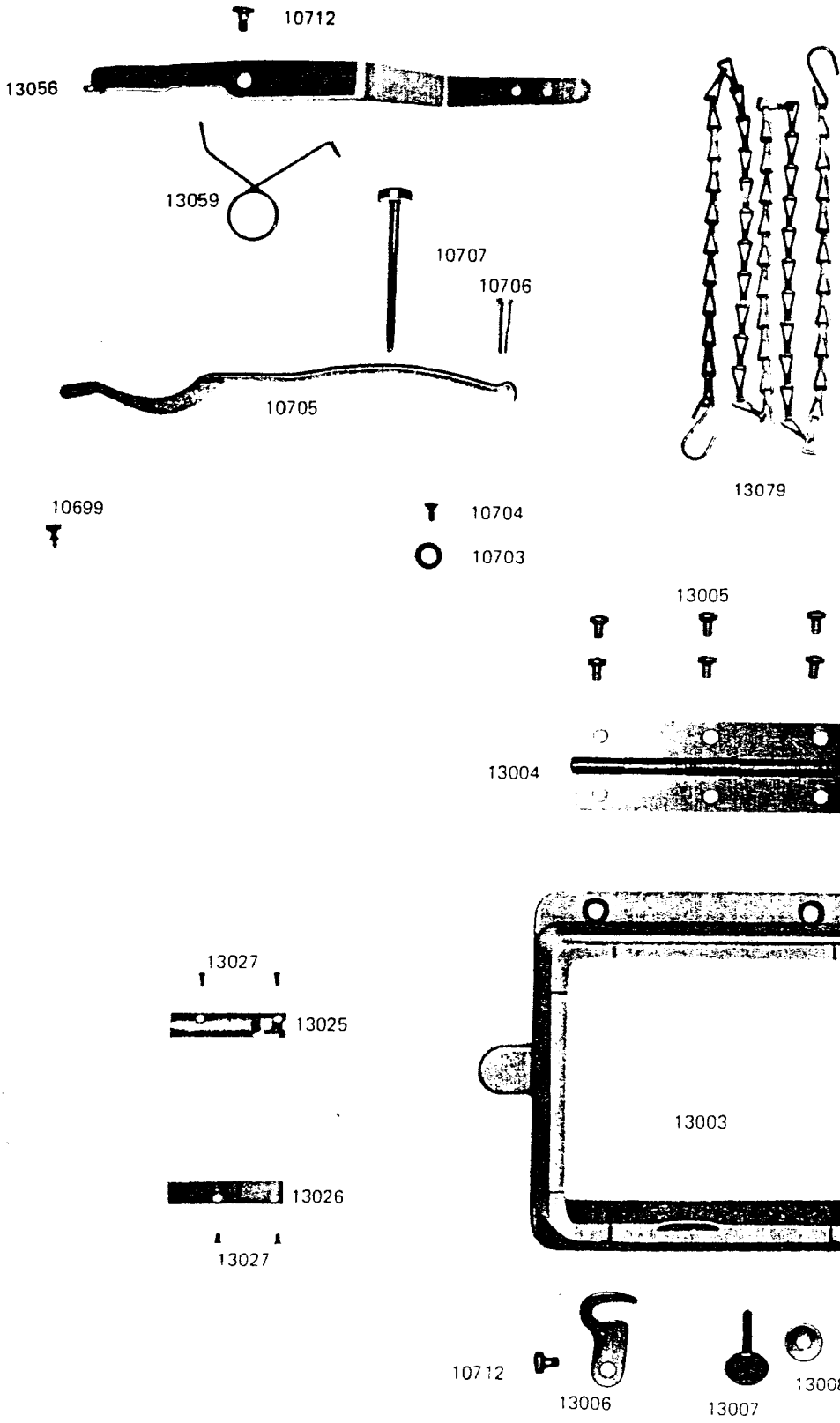

NOTE! WHEN ORDERING PARTS PREFIX ALL NUMBERS BY CS, EXAMPLE CS_

PRESSER BAR, LIFTING ROCK SHAFT, VIBRATING PRESSER

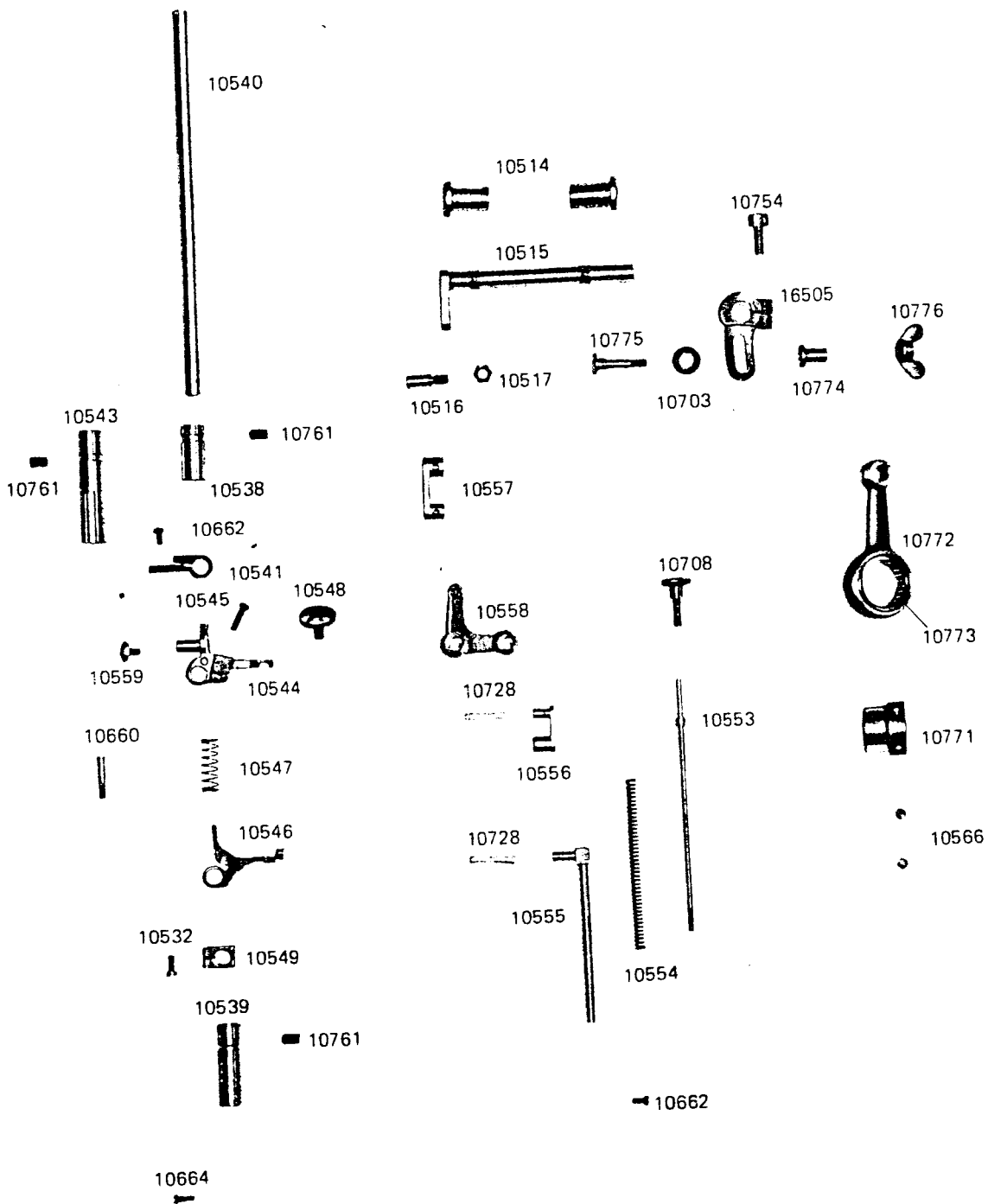

NOTE! WHEN ORDERING PARTS PREFIX ALL NUMBERS BY CS, EXAMPLE CS_

5

HOOK DRIVING SHAFT, ROTATING HOOK, TIMING BELT

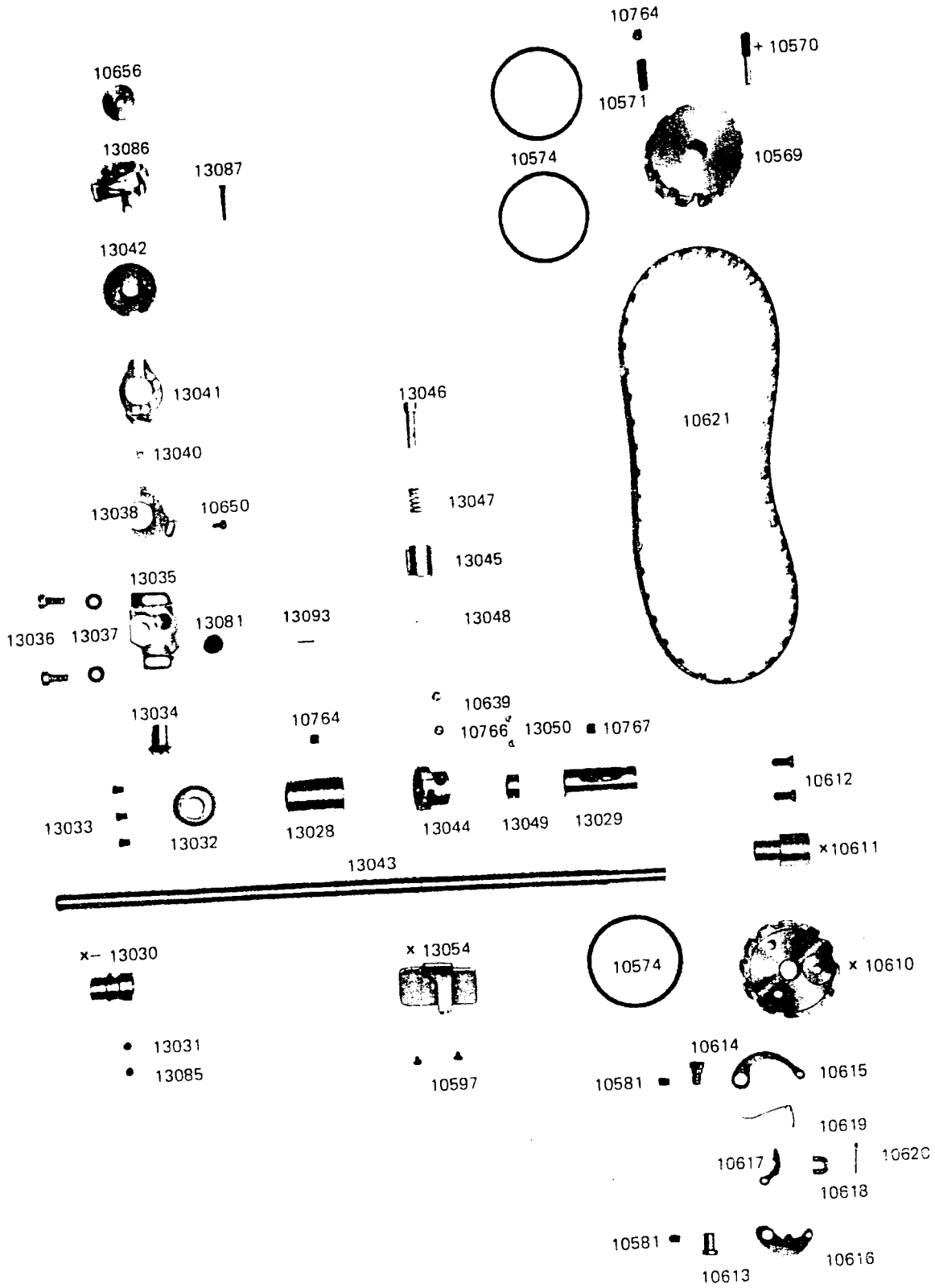

NOTE! WHEN ORDERING PARTS PREFIX ALL NUMBERS BY CS, EXAMPLE CS—

THREAD TENSION, FEED DRIVING ROCK SHAFT, FEEDER, NEEDLE PLATE

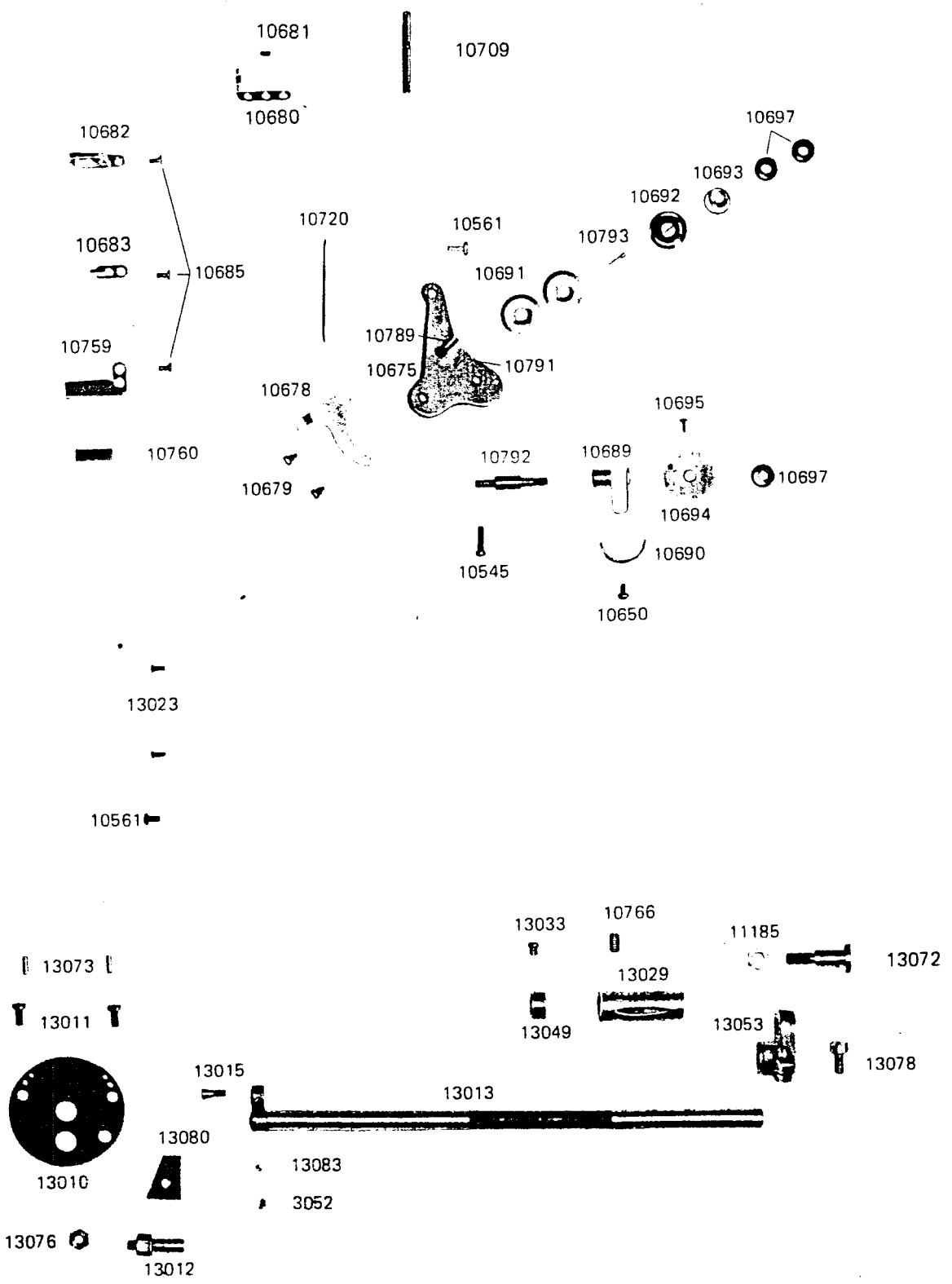

NOTE! WHEN ORDERING PARTS PREFIX ALL NUMBERS BY CS, EXAMPLE CS_

ACCESSORIES



8132

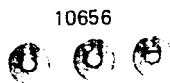

10656



6332



10748

10780

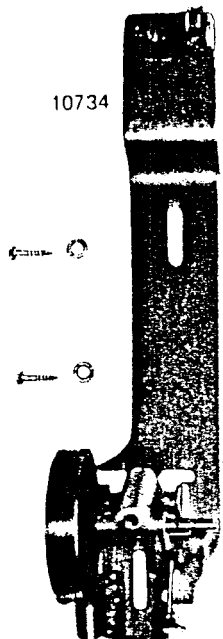
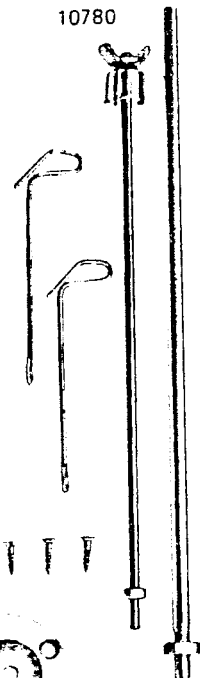

10734



8118



8120



8121



11969



8123

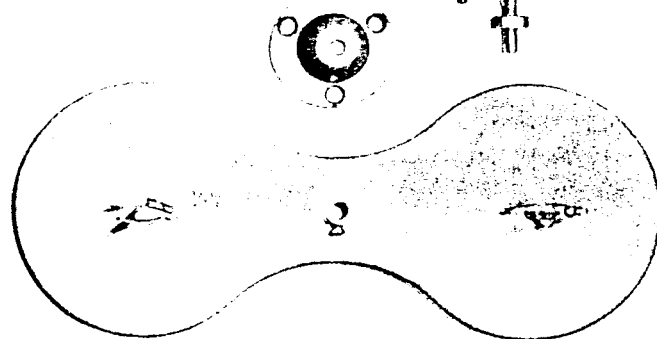

13094

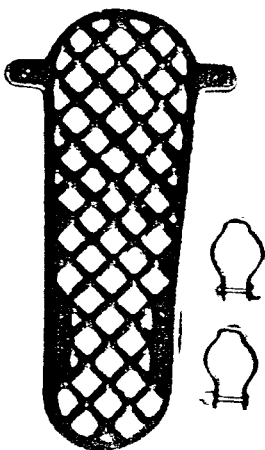

8125

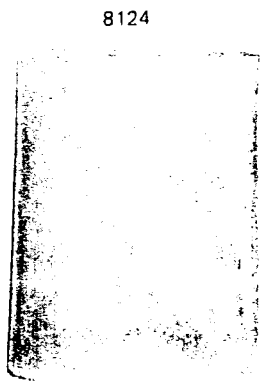

8124

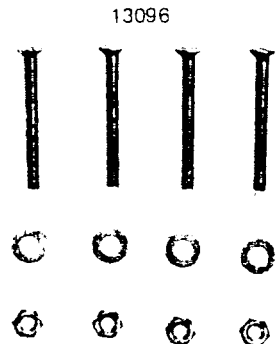

13096

NOTE! WHEN ORDERING PARTS PREFIX ALL NUMBERS BY CS, EXAMPLE CS_

105

10

1340

10

NOT

REVERSE STITCH MECHANISM

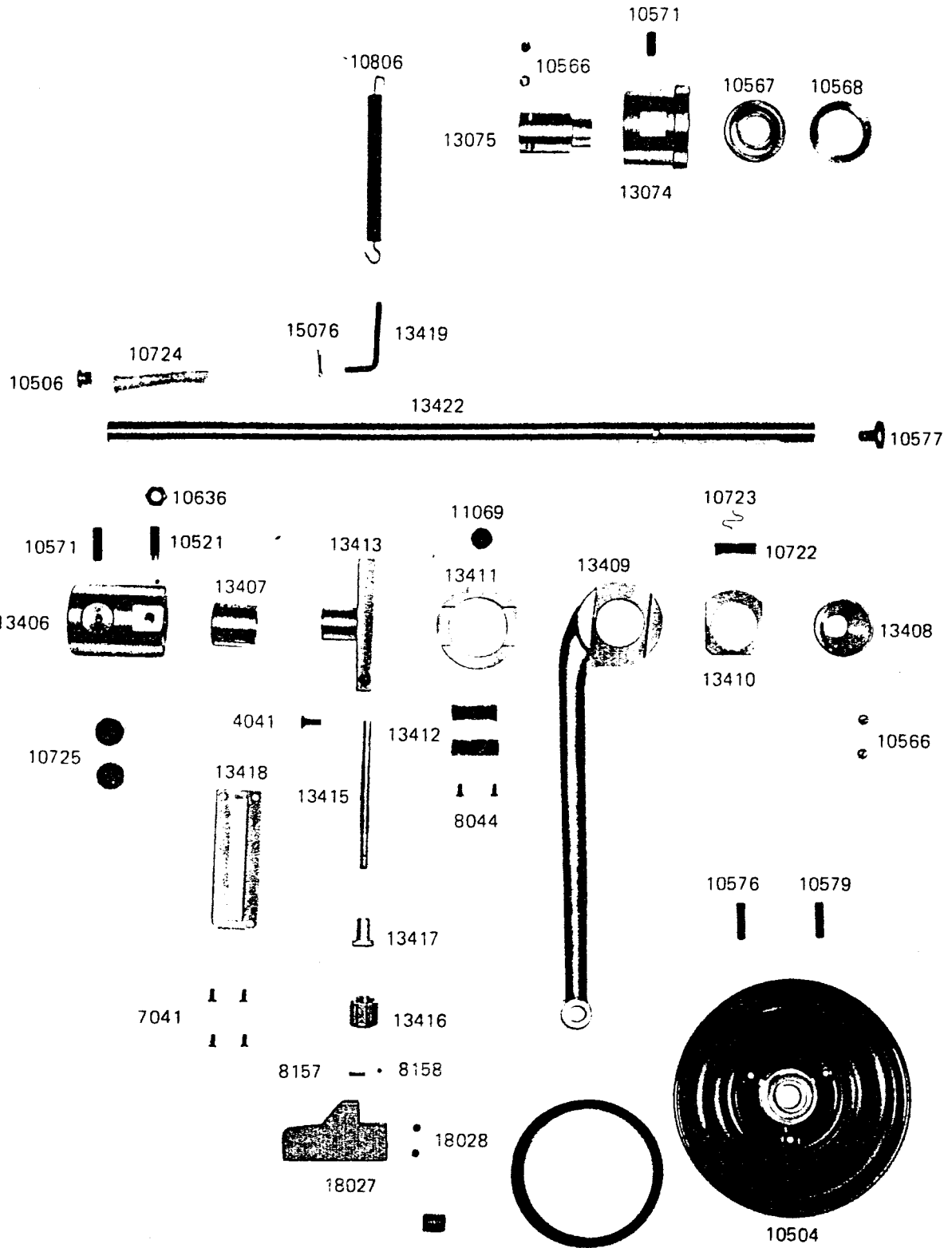
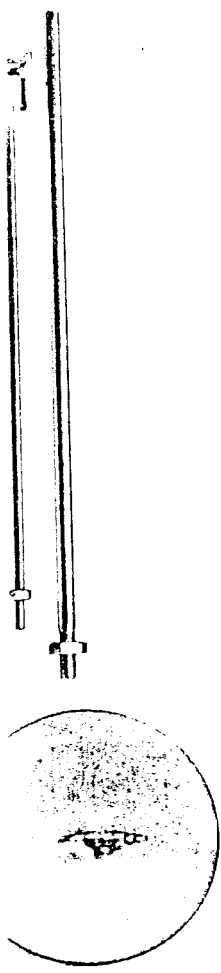

NOTE! WHEN ORDERING PARTS PREFIX ALL NUMBERS BY CS, EXAMPLE CS_

13423 A ... Use with guard
B ... Use without guard

SPECIAL PARTS

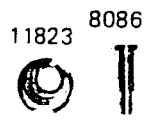
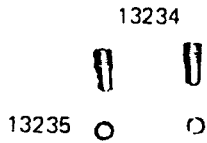
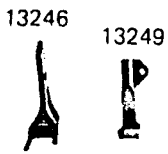

10561



13235

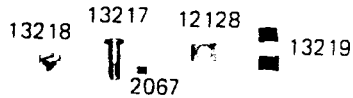

13256

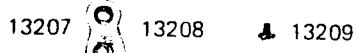
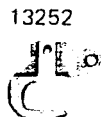
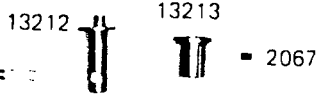

10659

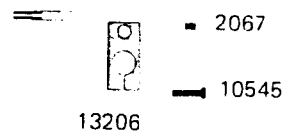

13204

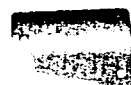

8111

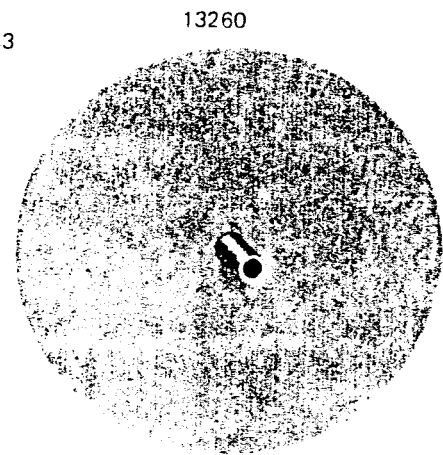
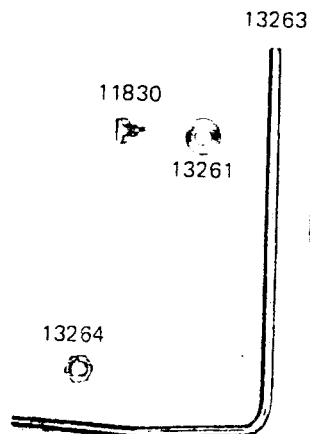
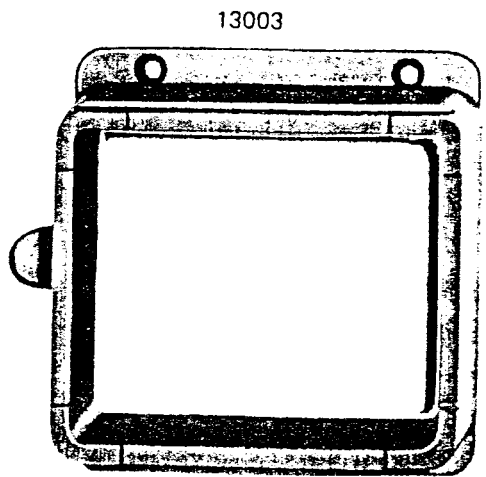

NOTE! WHEN ORDERING PARTS PREFIX ALL NUMBERS BY CS, EXAMPLE CS_

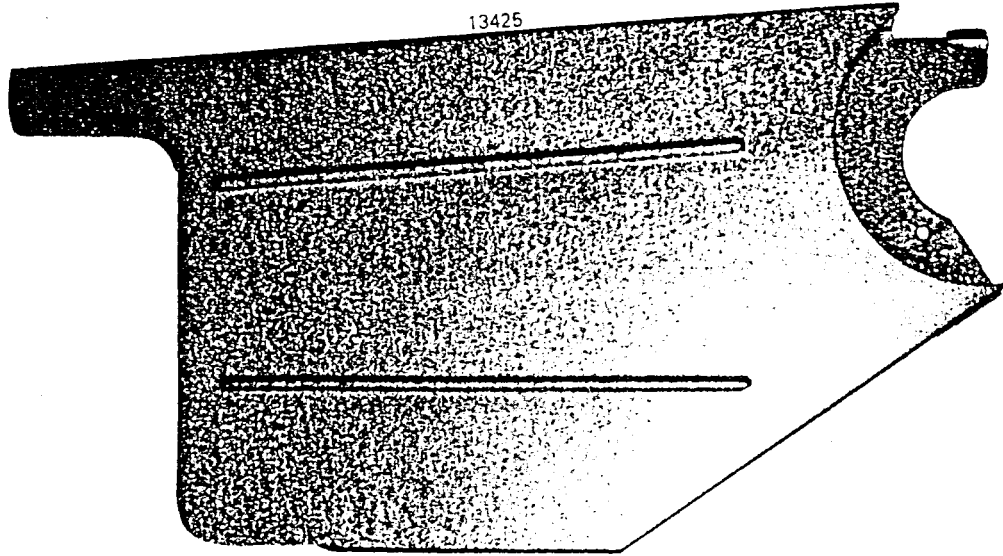

10659



50103 50099 14024

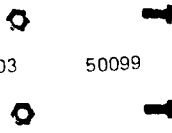

13427

11142 10561

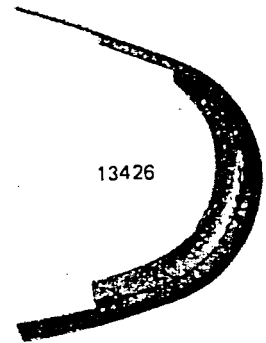

NOTE! WHEN ORDERING PARTS PREFIX ALL NUMBERS BY CS, EXAMPLE CS_