

Form 19061  
(337)  
Printed in U. S. A.

# LIST OF PARTS



## MACHINES

Nos. 147-84 and 147-85

\*\* A TRADE MARK OF  
**THE SINGER MANUFACTURING COMPANY**

## INSTRUCTIONS FOR ORDERING

In ordering from this list, use ONLY the part NUMBER in the FIRST column.

The number stamped on a Sewing Machine Part is in every case the number of the single part only.

Every combination of parts sent out as such has its specific number, which, although not stamped on the parts, must be used when ordering the combination.

Each number always indicates the SAME PART in whatever list it appears, or for whatever machine.

The letters after some of the numbers indicate the style of finish only, as follows:

- A-Hardened, Polished, Nickel Plated and Buffed
- B-Polished, Nickel Plated and Buffed
- C-Hardened Only
- D-Polished Only
- E-Soft, Not Polished
- F-Hardened and Polished
- F.J-Hardened, Polished and Nickel Plated
- G-Bright Rumbled and Nickel Plated
- H-Blued
- J-Nickel Plated Only
- K-Hardened and Nickel Plated
- L-Brass Plated
- M-Oxidized
- N-Japanned, Dull
- P-Japanned, Bright
- R-Merlized
- S-Cadmium Plating
- T-Copper Plated
- T.A-Hardened, Polished, Copper and Nickel Plated and Buffed
- T.B-Copper and Nickel Plated and Polished
- T.J-Copper and Nickel Plated Only
- T.K-Hardened, Copper and Nickel Plated
- T.M-Copper Plated and Oxidized
- T.L-Copper and Brass Plated
- U-Zinc Plated
- V-Silver Plated
- W-Polished and Nickel Plated
- Y-Black Nickel Plated Only
- Z-Chromium Plated
- Z.B-Polished, Nickel Plated, Buffed and Chromium Plated
- Z.J-Nickel and Chromium Plated

These letters MUST BE USED when they appear in the list; and AFTER the number as in the list.

In this series:

1 to 1500, 50001 to 51500 and 140001 to 142000 are Screw Numbers

1501 to 1800 and 51501 to 51800 are Nut Numbers

1801 to 2000 and 51801 to 52000 are Roller Numbers

2001 to 50000 and 52001 to 140000 and 142001 to

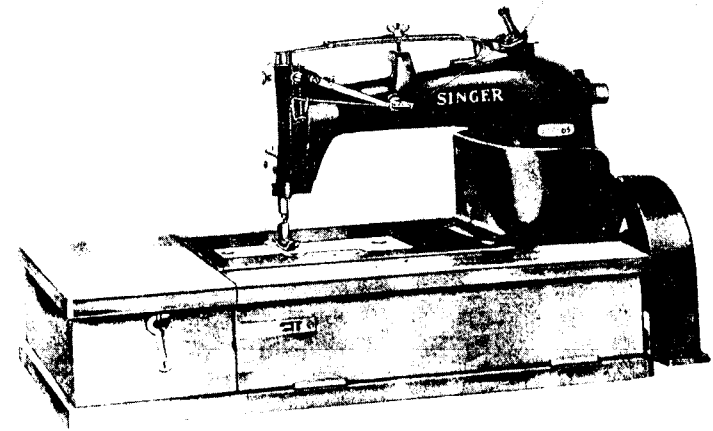
190000 are Sewing Machine Parts, 190001 and upward

are numbers of Electrical Parts.

The figures in the second column refer only to the plates, illustrating the parts, and are NOT TO BE USED in ordering.

Parts marked with an asterisk (\*) are furnished only when repairs are made at factory.

## LIST OF PARTS COMPLETE FOR



### MACHINE No. 147-84

For Plain Stitching on Mattresses and Studio Couch Work.  
One needle, one looper. Ball bearing. Needle bar stroke 1 3/8 inches. The looper is arranged so that it may be thrown out of position for convenience in threading. An improved oiling system automatically oils all of the principal bearings of the machine.  
Speed 3800 R. P. M.

No.	Plate	Name
*131446	-----	Arm, upper and lower (solid) with 948J, 15404, 68483, two 15405 and four 131022.....
131446		
68428	20529	Arm Bottom Cover.....
68429	20529	" " " Gasket (cork).....
1057C	20530	" " " Screw.....
50608R	20530	" Hole Plug Screw, for access to Crank Connecting Rod (upper bearing).....
139017	20530	Arm Hole Plug Screw Washer.....
68350	20530	" Oil Cup, for oiling Arm Rock Shaft Front Bearing.....
*68430	-----	Arm Oil Cup, for 131309.....
131309	20529	" " " 68430 with 131310, for filling oil reservoir.....

No.	Plate	Name
131394	20558	Cloth Plate Thread Guard.....
389F	20533	" " " " Screw (lower)..
50473F	20533	" " " " " (upper)..
*131471	20550	Crank Connecting Rod with two each 896C and 1057C.....
68459	-----	Crank Connecting Rod 131471 with 131072
896C	20533	" " " " Cap (lower) Screw.
1057C	20530	" " " " " (upper) Screw.
68460	20532	Face Plate (lower half).....
68461	20532	" " " " Gasket (cork)..
330D	20533	" " " " Screw.....
131395	20532	" " (upper half).....
29234	20533	" " " " Position Plate..
1053E	20533	" " " " " " "
		Screw.....
51224W	20530	Face Plate (upper half) Thumb Screw....
131396	20551	Feed Bar.....
131397	20551	Feed Bar complete, Nos. 50429C, 68467, 131396 and two 207E.....
131197	20551	Feed Bar Hinge Pin (eccentric).....
59343	20533	" " " " Collar with 735C....
735C	20533	" " " " " Set Screw....
134258	20533	" " Slide Block.....
134259	20533	" " " " 134258 with 68495 and 134260.....
68495	20533	Feed Bar Slide Block Oil Pad (wick)....
134260	20533	" " " " " Retainer..
68467	20551	" " Wearing Plate.....
207E	20533	" " " " Screw.....
131500	20551	" Connecting Rod with 1057C, 68497, 134260 and two 896C.....
131502	-----	Feed Connecting Rod 131500 with 54025..
896C	20533	" " " " Cap Screw.....
1057C	20530	" " " " Clamping Screw....
68497	20533	" " " " Oil Pad (wick)....
134260	20533	" " " " " Retainer...
131503	20554	" Dog, 17 teeth (12 teeth to the inch) for 131509.....
157J	20533	Feed Dog Screw, when stationary Needle Guard is used.....
50073J	20533	Feed Dog Screw, when movable Needle Guard is used.....
50429C	20533	Feed Dog Stop Screw.....
*54024	-----	" Eccentric with 138306.....
*23729	-----	" " Body.....
51061C	20533	" " " " Set Screw.....
7071	20533	" " Clamping Washer.....
217J	20533	" " " " Screw....
138306	20533	" " Lubricating Pad (wood)..

No.	Plate	Name
54025	20551	Feed Eccentric (adjustable) complete, Nos. 217J, 1103C, 7071, 23729, 54024 and two 51061C.....
1103C	20533	Feed Regulating Screw.....
131240	20551	" Rocking Frame with two 453C.....
131398	-----	" " " " 131240 with 59343, 131197 and 131397.....
57234	20551	Feed Rocking Frame Hinge Pin.....
57235	20533	" " " " " Bushing....
453C	20556	" " " " " " Set Screw.....
453C	20556	Feed Rocking Frame Hinge Pin Set Screw..
131133	20535	Looper.....
131134	-----	" 131133 with 229J and 131135.....
54027	20535	" Carrier with two 175E.....
175E	20535	" " Adjusting Screw.....
54227	20535	" " Connection.....
54228	20535	" " " Shaft.....
128419	20546	" " " " Oil Pad (braided cotton).....
68478	20551	Looper Carrier Connection Shaft Sleeve (eccentric).....
51263D	20546	Looper Carrier Connection Shaft Sleeve Cap Screw.....
68479	20535	Looper Carrier Driver with four 175E....
175E	20535	" " " Cap Screw.....
*131110	20551	" Driving Shaft and Feed Lifting Eccentric with two 64315.....
Note: When No. 131110 is required for repairs, the Arm Rotary Shaft must be returned to the fac- tory to be adjusted to the new part.		
*131111	-----	Looper Driving Shaft and Feed Lifting Eccentric 131110 with 54027, 54227, 54228 and 68479.....
*68483	-----	Looper Driving Shaft and Feed Lifting Eccentric Bracket with 761E.....
948J	20546	Looper Driving Shaft and Feed Lifting Eccentric Bracket Screw.....
68484	20551	Looper Driving Shaft and Feed Lifting Eccentric Bushing.....
131028	20546	Looper Driving Shaft and Feed Lifting Eccentric Bushing Oil Plug.....
761E	20530	Looper Driving Shaft and Feed Lifting Eccentric Bushing Position Screw....
68497	20533	Looper Driving Shaft and Feed Lifting Eccentric Front Bearing Oil Pad (wick).....
64315	20546	Looper Driving Shaft and Feed Lifting Eccentric Oil Hole Plug.....
640E	20546	Looper Driving Shaft and Feed Lifting Eccentric Screw.....

No.	Plate	Name
68497	20533	Oil Pipe (front of arm) Oil Pad (wick) for 131112 and 131113.....
*49191	-----	Oil Pipe (front of arm) Sleeve.....
64330	20542	Presser Bar with 25303.....
25303	20546	" " Ball, size 1/4 in.....
131292	20556	" " Bushing (lower).....
1133E	20552	" " " " Set Screw....
38456	20556	" " " " (upper).....
1133E	20552	" " " " Set Screw....
131401	20556	" " Lifting Bracket with 453C...
11173	20556	" " " " Guide.....
453C	20556	" " " " Set Screw
453C	20556	" " " " Set Screw...
131402	20542	" " " Lever.....
68184	20542	" " " " Extension.....
161J	20546	" " " " " Screw.
802D	20546	" " " " Hinge Screw...
38467	20542	" " Spring (flat).....
38468	20556	" " Stud.....
*131231	-----	" " " (auxiliary).....
*131232	-----	" " " " Guide.....
4604	20556	" " " " Rivet
131198	20557	Presser Bar Spring (auxiliary) complete, Nos. 4604, 131231 and 131232.....
26276	20546	Presser Foot Hinge Pin.....
131506	-----	" " Plate.....
131507	-----	" " Shank.....
131508	20554	Presser Foot (hinged) complete, Nos. 26276 131506 and 131507.....
190J	20530	Presser Foot Screw.....
574W	20556	Pressure Regulating Thumb Screw.....
1539W	20556	" " " " Lock Nut.
131025	20553	Slack Thread Controller.....
54242	20553	" " " " Clamp.....
190J	20530	" " " " Screw.....
131419	20540	" " Regulator.....
131404	20540	" " " Holder.....
131405	20540	" " " Crank with 171E.....
1423J	20540	Slack Thread Regulator Holder Crank Cap Screw.....
171E	20540	Slack Thread Regulator Holder Crank Clamping Screw.....
131406	20540	Slack Thread Regulator Holder Crank Connecting Link.....
217J	20533	Slack Thread Regulator Screw.....
131012	20542	Tension (under thread) Bracket.....
691F	20540	" " " " Screw.....
2102	20540	" " " Disc.....
51570C	20540	" " " Regulating Thumb Nut.....

No.	Plate	Name
50326C	20540	Tension (under thread) Screw Stud.....
59539	-----	" " " " " 50326C with 51570C.....
59534	20540	Tension (under thread) Spring.....
59537	20540	" " " " Bushing (large).....
59538	20540	Tension (under thread) Spring Bushing (small).....
57076	20540	Tension (under thread) Thread Guide.....
54045	20557	" (upper thread) Bracket.....
376J	20540	" " " " Screw.....
2102	20540	" " " Disc.....
51570C	20540	" " " Regulating Thumb Nut.....
32572	20540	Tension (upper thread) Releasing Disc...
54988	20540	" " " " Pin....
54046	20557	" " " " Shaft..
54047	20539	" " " " "
		Crank with 624C.....
54048	20539	Tension (upper thread) Releasing Shaft Crank Link.....
624C	20539	Tension (upper thread) Releasing Shaft Crank Set Screw.....
68261	20539	Tension (upper thread) Releasing Shaft Spring.....
131011	20539	Tension (upper thread) Releasing Shaft Spring Position Plate.....
316C	20539	Tension (upper thread) Releasing Shaft Stop Screw.....
1547J	20539	Tension (upper thread) Releasing Shaft Stop Screw Nut.....
50326C	20540	Tension (upper thread) Screw Stud.....
59539	-----	" " " " " 50326C with 51570C.....
59535	20540	Tension (upper thread) Spring.....
59537	20540	" " " " Bushing (large).....
59538	20540	Tension (upper thread) Spring Bushing (small).....
57076	20540	Tension (upper thread) Thread Guide (double).....
53225	20539	Thread (under) Eyelet (back).....
190J	20530	" " " " Screw.....
131407	20539	" " Take-up with 1258C.....
131408	20553	" " " Oil Guard.....
50438J	20553	" " " " Screw..
1258C	20539	" " " Set Screw.....
131409	20553	" " " Stripper.....
54242	20553	" " " " Clamp....
190J	20530	" " " " Screw
131410	20542	" " " " Plate....

## ACCESSORIES

No.	Plate	Name
120344	20545	Oiler (copper plated) with 120345.....
120345	20545	" Spout, 4 1/2 in. long.....
120440	20545	Screw Driver (large).....
121108	20545	" " (small).....
120341	20545	Tweezers (curved).....
4822	20545	Wrench for 1547.....
8908	20545	" " 1520.....

## BELT GUARD

No.	Plate	Name
68222	20549	Belt Guard with two wood screws 1 in.No. 12.....

## BENCH STAND

79772	-----	Bench Stand with 27998,two each 41538, 126849,three wood screws 1 1/4 in. No.12, four each 60656,wood screws 1 1/4 in.No.10 and sixteen wood screws 5/8 in.No.7.....
126849	9520	Flap Hinge with four wood screws 3/4 in. No.7.....
27998	9520	Flap Hook and Eye (brass) with wood screw 1/2 in.No.5.....
126247	9520	Flush Bolt.....
126248	9520	" " Plate.....
41538	-----	Flush Bolt with Plate complete, Nos. 126247,126248 and four brass wood screws 5/8 in. No. 4.....
60656	9520	Hinge.....

## FOOT LIFTER PARTS

No.	Plate	Name
6439	-----	Chain,36 in.to 45 in.,with 56864 and 56865.....
Note: When ordering No.6439,state length required.		
4879	20545	Chain Connecting Link.....
56864	20545	" Hook (large).....
56865	20545	" " (small).....
126249	20549	Treadle.....

No.	Plate	Name
4882	20547	Treadle Shaft.....
126250	20547	" Spring.....
150451	20549	" Stand.....
150452	20549	Treadle complete,Nos.4879,4882,126249, 126250,150451 and two wood screws 1 in.No.16 F.H.....

## KNEE LIFTER PARTS

No.	Plate	Name
37563	-----	Chain,length15 in.,with 56864 and 56865.
56864	20545	" Hook (large).....
56865	20545	" " (small).....
2763	20559	Rock Shaft.....
12242	20559	" " Hanger with two wood screws 1 in. No. 10.....
6335	20559	Rock Shaft Knee Arm.....
6336	-----	Rock Shaft Knee Arm complete,Nos.2766, 2767 and 6335.....
2766	20559	Rock Shaft Knee Arm Hub with 356C.....
356C	20546	" " " " " Set Screw.....
2767	20559	" " " Plate with 356C.....
356C	20546	" " " " " Set Screw.....
6337	20559	" " Lifting Bracket with two 356C
7125	20559	" " " " Hook.....
356C	20546	" " " " " Set Screw
356C	20546	" " " " " Set Screw....
2770	20559	" " Stop Dog with 356C.....
356C	20546	" " " " " Set Screw.....
23767	20559	Rock Shaft complete,Nos.2763,2770,6336, 6337,7125 and two 12242.....

## MACHINE BASE

No.	Plate	Name
131263	20549	Machine Base.....
54477	20547	" " Screw Stud, to fasten base to table.....
131205	20547	Machine Base Screw Stud, to position machine on base.....
51576E	20547	Machine Base Screw Stud Nut.....
9842	20547	" " " " " Washer.....
131022	20547	" " " " " Bushing (rubber)
131279	20547	" Cushion (felt).....
131264	-----	Machine Base complete,Nos. 131263,three each 9842,51576E,54477 and four each 131205 and 131279.....

MACHINE BASE

No.	Plate	Name
131328	-----	Machine Base and Oil Drain Jar (swinging type) complete, Nos. 131264 and 131268

MACHINE BASE OIL DRAIN JAR

(SWINGING TYPE)

No.	Plate	Name
131185	20526	Jar (glass).....
131191	20526	" Cap.....
131188	20526	" Clamp.....
131217	-----	" " 131188 with 131189.....
131189	20526	" " Lever.....
1247C	20546	" " Hinge Screw.....
131265	20526	Nipple (long).....
131266	20526	" (short).....
131267	20526	" Elbow.....
131268	-----	Machine Base Oil Drain Jar (swinging type) complete, Nos. 131185, 131191, 131217, 131266 and two each 1247C, 131265 and 131267.....

THREAD UNWINDER

FOR TWO SPOOLS

No.	Plate	Name
225257	20787	Spool Rest (for two spools) with 201018C
150203	20787	" " Cushion (felt).....
225388	20787	" " Rod.....
200383C	20546	" " Set Screw.....
201018C	20546	" " Set Screw.....
202490	20787	" Stand with 200383C.....
225391	20787	Thread Guide.....
201696J	20546	" " Lock Nut.....
225326	20546	" " Position Cup.....
225324	20787	" " Rod with 208E and 225322...
208E	20546	" " Screw.....
225322	20546	" " Washer.....
*150085	-----	" Spreader.....
150086	20787	" " 150085 with 150059.....
*150059	-----	" Bracket.....
150060	20787	" " Arm with 164J and 9525.....
164J	20546	Thread Separator Bracket Arm Clamping Screw.....

THREAD UNWINDER

No.	Plate	Name
9525	20546	Thread Separator Bracket Arm Clamping Screw Washer.....
164J	20546	Thread Separator Bracket Arm Screw.....
9525	20546	" " " " Washer
150087	-----	Thread Separator complete, Nos. 164J, 9525, 150060 and 150086.....
150088	20787	Thread Unwinder complete, Nos. 150087, 201696J, 202490, 225257, 225324, 225326, 225388, two each 150203, 225391 and three wood screws 7/8 in. No. 12.....
27739	20557	Thread Cone (wood) for large cones.....
225390	20557	" " Holder, for inverted cones..

Note: Nos. 27739 and 225390 are used with, but not included in 150088.

SINGER Needles should be used in SINGER Machines. These Needles and their Containers are marked with the Company's Trade Mark "SIMANCO.\*\*\*" 1

Needles in Containers marked "FOR SINGER MACHINES" are NOT **SINGER** made needles. 2

## NUMERICAL LIST OF PARTS

NUMERICAL  
LIST  
OF PARTS

No.	Plate	Name
144D	20530	Arm Rotary Shaft Screw.....
157J	20533	Feed Dog Screw, when stationary Needle Guard is used.....
161J	20546	Presser Bar Lifting Lever Extension Screw.....
164J	20546	Thread Unwinder Thread Separator Bracket Arm Clamping Screw, for 150060.....
164J	20546	Thread Unwinder Thread Separator Bracket Arm Screw, for 150087.....
171E	20540	Slack Thread Regulator Holder Crank Clamping Screw, for 131405.....
175E	20535	Looper Carrier Adjusting Screw, for 54027
175E	20535	" " Driver Cap Screw, for 68479
176J	20552	Needle Guard (stationary) Holder Screw..
176F	20552	Oil Pipe (back of arm) Clamp Screw.....
190J	20530	Presser Foot Screw.....
190J	20530	Slack Thread Controller Clamp Screw.....
190J	20530	Thread (under) Eyelet (back) Screw.....
190J	20530	" " Take-up Stripper Clamp Screw, for 131420.....
190J	20530	Thread (under) Take-up Stripper Plate Screw, for 131420.....
190J	20530	Thread (upper) Eyelet Screw.....
198E	20546	Oil Pipe (back of arm) Connection Cap Screw, for 68494.....
198E	20546	Oil Pipe (front of arm) Connection Cap Screw, for 131002, 131003 and 131084.
205C	20530	Arm Rotary Shaft Ball Bearing (back) Case Cap Screw, for 131479.....
207E	20533	Feed Bar Wearing Plate Screw, for 131397.
207J	20533	Thread (under) Take-up Thread Guide (left) Screw, for 131420.....
207J	20533	Thread (under) Take-up Thread Guide (right) Screw, for 131420.....
208E	20546	Thread Unwinder Thread Guide Rod Screw, for 225324.....
211F	20552	Thread (upper) Take-up Set Screw, for 131400.....
217J	20533	Feed Eccentric Clamping Washer Screw, for 54025.....
217C	20533	Needle Guard Screw.....
217J	20533	Slack Thread Regulator Screw.....
229J	20535	Looper Needle Guard Screw, for 131134...
316C	20539	Tension (upper thread) Releasing Shaft Stop Screw.....
330D	20533	Face Plate (lower half) Screw.....
356C	20546	Rock Shaft Knee Arm Hub Set Screw, for 2766.....

No.	Plate	Name
356C	20546	Rock Shaft Knee Plate Set Screw, for 2767
356C	20546	" " Lifting Bracket Hook Set Screw, for 6337.....
356C	20546	Rock Shaft Lifting Bracket Set Screw, for 6337.....
356C	20546	Rock Shaft Stop Dog Set Screw, for 2770.
376J	20540	Tension (upper thread) Bracket Screw....
389F	20533	Cloth Plate Thread Guard Screw (lower)..
423C	20530	Arm Rock Shaft Bushing (intermediate) Set Screw.....
429C	20530	Arm Rotary Shaft Ball Bearing (back) Case Set Screw.....
443C	20546	Looper Throw-out Handle Set Screw, for 68485.....
446C	20530	Arm Rock Shaft Bushing (back) Set Screw.
453C	20556	" " " Flanged Bushing (front) Set Screw.....
453C	20556	Feed Rocking Frame Hinge Pin Bushing Set Screw.....
453C	20556	Feed Rocking Frame Hinge Pin Set Screw, for 131240.....
453C	20556	Presser Bar Lifting Bracket Guide Set Screw.....
453C	20556	Presser Bar Lifting Bracket Set Screw, for 131401.....
457C	20539	Arm Rotary Shaft Ball Bearing (intermed- iate) Collar Set Screw, for 131482...
563C	20530	Arm Oil Cup Drip Pan Position Screw, for 131305.....
574W	20556	Pressure Regulating Thumb Screw.....
624C	20539	Tension (upper thread) Releasing Shaft Crank Set Screw, for 54047.....
640E	20546	Looper Driving Shaft and Feed Lifting Eccentric Screw, for 131510.....
691F	20540	Tension (under thread) Bracket Screw....
725J	20533	Cloth Plate Slide (left) Spring Screw, for 131051.....
725J	20533	Cloth Plate Slide (right) Spring Screw, for 131382 and 131517.....
735C	20533	Feed Bar Hinge Pin Collar Set Screw, for 59343.....
742F	20554	Throat Plate Screw.....
761E	20530	Arm Rotary Shaft Bushing (front) Set Screw.....
761E	20530	Looper Driving Shaft and Feed Lifting Eccentric Bushing Position Screw, for 68483.....
802D	20546	Presser Bar Lifting Lever Hinge Screw...
853C	20552	Needle Bar Connecting Link Hinge Stud Set Screw, for 131475.....
857C	20556	Needle Set Screw, for 54208.....

No.	Plate	Name
861C	20552	Needle Bar Connecting Link Hinge Stud Oil Plug Screw.....
896C	20533	Crank Connecting Rod Cap (lower) Screw, for 131471.....
896C	20533	Feed Connecting Rod Cap Screw, for 131500
948J	20546	Looper Driving Shaft and Feed Lifting Eccentric Bracket Screw, for 131446..
965D	20553	Thread (under) Take-up Stripper Plate Bracket Screw.....
1011F	20533	Cloth Plate Screw (left) for 131374, for 147-84 Machine.....
1053E	20533	Face Plate (upper half) Position Plate Screw.....
1057C	20530	Arm Bottom Cover Screw.....
1057K	20530	" Side Cover Screw.....
1057C	20530	Crank Connecting Rod Cap (upper) Screw, for 131471.....
1057C	20530	Feed Connecting Rod Clamping Screw, for 131500.....
1103C	20533	Feed Regulating Screw, for 54025.....
1120C	20535	Looper Set Screw, for 54035 and 131522..
1133E	20552	Needle Bar Bushing (lower) Set Screw....
1133E	20552	" " " (upper) Set Screw....
1133E	20552	Presser Bar Bushing (lower) Set Screw...
1133E	20552	" " " (upper) Set Screw...
1235F	20530	Arm Rock Shaft Oil Plug Screw, for 131474
1247C	20546	Machine Base Oil Drain Jar Clamp Lever Hinge Screw, for 131268.....
1258C	20539	Thread (under) Take-up Set Screw, for 131407.....
1304C	20530	Arm Rotary Shaft Ball Bearing (intermed- iate) Case Set Screw.....
1309C	20530	Arm Rock Shaft Adjusting Screw.....
1423J	20540	Slack Thread Regulator Holder Crank Cap Screw.....
1443W	20555	Throat Plate Filling-in Piece Screw, for 147-85 Machine.....
1449J	20553	Thread (upper) Take-up Plate Spring Screw, for 131333.....
1492E	20552	Needle Bar Connecting Stud Clamping Screw, for 131400.....
1520J	20552	Needle Bar Connecting Link Hinge Stud, Nut.....
1539W	20556	Pressure Regulating Thumb Screw Lock Nut
1547J	20539	Tension (upper thread) Releasing Shaft Stop Screw Nut.....
1733	20546	Oil Pipe (back of arm) Coupling Nut (brass).....
1733	20546	Oil Pipe (front of arm) Coupling Nut (brass) for 68498 and 68500.....



## NUMERICAL LIST OF PARTS

No.	Plate	Name
2102	20540	Tension (under thread) Disc.....
2102	20540	" (upper thread) Disc.....
2763	20559	Rock Shaft, for 23767.....
2766	20559	" " Knee Arm Hub with 356C, for 6336.....
2767	20559	Rock Shaft Knee Plate with 356C, for 6336
2770	20559	" " Stop Dog with 356C, for 23767.
4604	20556	Presser Bar Spring (auxiliary) Guide Rivet, for 131198.....
4822	20545	Wrench for 1547 (Accessories).....
4879	20545	Chain Connecting Link, for 150452.....
4882	20547	Treadle Shaft, for 150452.....
6335	20559	Rock Shaft Knee Arm, for 6336.....
6336	-----	Rock Shaft Knee Arm complete for 23767, Nos. 2766, 2767 and 6335.....
6337	20559	Rock Shaft Lifting Bracket with two 356C for 23767.....
6439	-----	Chain, 36 in. to 45 in., with 56864 and 56865.....
7071	20533	Feed Eccentric Clamping Washer, for 54025
7071	20533	Thread (under) Take-up Thread Guide (left) Screw Washer, for 131420.....
7071	20533	Thread (under) Take-up Thread Guide (right) Screw Washer, for 131420.....
7125	20559	Rock Shaft Lifting Bracket Hook, for 23767.....
8908	20545	Wrench for 1520 (Accessories).....
9525	20546	Thread Unwinder Thread Separator Bracket Arm Clamping Screw Washer, for 150060
9525	20546	Thread Unwinder Thread Separator Bracket Arm Screw Washer, for 150087.....
9842	20547	Machine Base Screw Stud Nut Washer, for 131264.....
11173	20556	Presser Bar Lifting Bracket Guide.....
12242	20559	Rock Shaft Hanger with two wood screws 1 in. No. 10, for 23767.....
*15404	-----	Trade Mark, for 131446.....
15405	-----	" " Rivet, for 131446.....
*23729	-----	Feed Eccentric Body, for 54025.....
23767	20559	Rock Shaft complete, Nos. 2763, 2770, 6336, 6337, 7125 and two 12242.....
25303	20546	Presser Bar Ball, size 1/4 in., for 64330
26276	20546	" Foot Hinge Pin, for 131508.....
27739	20557	Thread Unwinder Thread Cone (wood) for large cones.....
27998	9520	Bench Stand Flap Hook and Eye (brass) with wood screw 1/2 in. No. 5, for 79772.....
29234	20533	Face Plate (upper half) Position Plate..
32062	20553	Thread (under) Take-up Stripper Washer, for 131420.....

## NUMERICAL LIST OF PARTS

No.	Plate	Name
32572	20540	Tension (upper thread) Releasing Disc...
37563	-----	Chain, length 15 in., with 56864 and 56865
38456	20556	Presser Bar Bushing (upper).....
38467	20542	" " Spring (flat).....
38468	20556	" " Stud.....
38484	20553	Thread (upper) Eyelet.....
41538	-----	Bench Stand Flush Bolt with Plate com- plete for 79772, Nos. 126247, 126248 and four brass wood screws 5/8 in. No. 4.....
42365	20530	Arm Rock Shaft Oil Pad (braided cotton) for oiling Back Bearing.....
42367	20530	Arm Rotary Shaft Front Bearing Oil Pad, lower (braided cotton).....
43503	20546	Looper Throw-out Handle Plunger Spring..
46105	20535	" Needle Guard Pin, for 131135.....
*49189	-----	Oil Pipe (back of arm) Connection Cap, for 68494.....
*49189	-----	Oil Pipe (front of arm) Connection Cap, for 131003.....
*49191	-----	Oil Pipe (back of arm) Sleeve, for 68492
*49191	-----	" " (front of arm) Sleeve, for 68498 and 68500.....
50073J	20533	Feed Dog Screw, when movable Needle Guard is used.....
50083C	20530	Arm Rock Shaft Crank (back) Set Screw, for 131072.....
50326C	20540	Tension (under thread) Screw Stud, for 59539.....
50326C	20540	Tension (upper thread) Screw Stud, for 59539.....
50376F	20556	Cloth Plate Screw (left) for 147-85 Ma- chine.....
50396F	20533	Cloth Plate Screw (right).....
50429C	20533	Feed Dog Stop Screw, for 131397.....
50438J	20553	Thread (under) Take-up Oil Guard Screw, for 131420.....
50470J	20553	Thread (under) Take-up Thread Guard Screw, for 131420.....
50473F	20533	Cloth Plate Thread Guard Screw (upper)..
50608R	20530	Arm Hole Plug Screw, for access to Crank Connecting Rod (upper bearing).....
51061C	20533	Feed Eccentric Body Set Screw, for 54025.
51119J	20546	Looper Holder Screw.....
51224W	20530	Arm Side Cover Cap Thumb Screw, for 131278.....
51224W	20530	Face Plate (upper half) Thumb Screw....
51263D	20546	Looper Carrier Connection Shaft Sleeve Cap Screw.....
51283C	20533	Balance Wheel Set Screw, for 131483.....

## NUMERICAL LIST OF PARTS

No.	Plate	Name
515700	20540	Tension (under thread) Regulating Thumb Nut, for 59539.....
515700	20540	Tension (upper thread) Regulating Thumb Nut, for 59539.....
51576E	20547	Machine Base Screw Stud Nut, for 131264..
53225	20539	Thread (under) Eyelet (back).....
*54024	-----	Feed Eccentric with 138306, for 54025....
54025	20551	Feed Eccentric (adjustable) complete for 131502, Nos. 217J, 1103C, 7071, 23729, 54024 and two 51061C.....
54027	20535	Looper Carrier with two 175E, for 131111.
54035	20535	" Holder with 1120C, for 147-84 Machine.....
54038	20552	Needle Guard (stationary) Holder.....
54045	20557	Tension (upper thread) Bracket.....
54046	20557	" " " Releasing Shaft..
54047	20532	" " " " "
		Crank with 624C.....
54048	20539	Tension (upper thread) Releasing Shaft Crank Link.....
54194	20553	Thread (upper) Take-up Plate, for 131333.
54208	20557	Needle Bar (hollow) with 857C.....
54218	20530	Arm Rotary Shaft Front Bearing Oil Pad, upper (braided cotton).....
54227	20535	Looper Carrier Connection, for 131111...
54229	20535	" " " Shaft, for 131111.....
54242	20553	Slack Thread Controller Clamp.....
54242	20553	Thread (under) Take-up Stripper Clamp, for 131420.....
54477	20547	Machine Base Screw Stud, to fasten base to table, for 131264.....
54969	20530	Arm Rock Shaft Oil Pad (braided cotton) for oiling Intermediate Bearing.....
54988	20540	Tension (upper thread) Releasing Pin....
56864	20545	Chain Hook (large) for 6439 and 37563...
56865	20545	" " (small) for 6439 and 37563...
57078	20540	Tension (under thread) Thread Guide....
57078	20540	" (upper thread) Thread Guide (double).....
57234	20551	Feed Rocking Frame Hinge Pin.....
57235	20533	" " " " " Bushing....
59343	20533	" Bar Hinge Pin Collar with 735C, for 131398.....
59534	20540	Tension (under thread) Spring.....
59535	20540	" (upper thread) Spring.....
59537	20540	" (under thread) Spring Bushing (large).....
59537	20540	Tension (upper thread) Spring Bushing (large).....

## NUMERICAL LIST OF PARTS

No.	Plate	Name
59538	20540	Tension (under thread) Spring Bushing (small).....
59538	20540	Tension (upper thread) Spring Bushing (small).....
59539	-----	Tension (under thread) Screw Stud 50326C with 51570C.....
59539	-----	Tension (upper thread) Screw Stud 50326C with 51570C.....
60656	9520	Bench Stand Hinge, for 79772.....
64315	20546	Looper Driving Shaft and Feed Lifting Eccentric Oil Hole Plug, for 131110..
64320	20552	Needle Bar Bushing (upper).....
64330	20542	Presser Bar with 25303.....
68123	20552	Needle Guard (movable) Clamp.....
68164	20553	Thread (upper) Take-up Plate Spring, for 131333.....
68184	20542	Presser Bar Lifting Lever Extension....
68222	20549	Belt Guard with two wood screws 1 in. No. 12.....
68261	20539	Tension (upper thread) Releasing Shaft Spring.....
68350	20530	Arm Oil Cup, for oiling Arm Rock Shaft Front Bearing.....
68368	20532	Cloth Plate Slide (left) for 131051.....
68428	20529	Arm Bottom Cover.....
68429	20529	" " " Gasket (cork).....
*68430	-----	" Oil Cup, for 131309.....
68433	20550	" Rock Shaft Bushing (back).....
68435	20550	" " " " " Cap.....
68436	20550	" " " " (intermediate)...
68448	20529	" Side Cover Gasket (cork).....
68459	-----	Crank Connecting Rod 131471 with 131072, for 131510.....
68460	20532	Face Plate (lower half).....
68461	20532	" " " " Gasket (cork)....
68467	20551	Feed Bar Wearing Plate, for 131397.....
68478	20551	Looper Carrier Connection Shaft Sleeve Eccentric.....
68479	20535	Looper Carrier Driver with four 175E, for 131111.....
*68483	-----	Looper Driving Shaft and Feed Lifting Eccentric Bracket with 761E, for 131446.....
68484	20551	Looper Driving Shaft and Feed Lifting Eccentric Bushing.....
68485	20551	Looper Throw-out Handle with two 443C...
68486	20546	" " " Plunger.....
68488	20552	Needle Bar Connecting Link and Thread (upper) Controller, for 131399.....
68489	20552	Needle Bar Connecting Link Hinge Stud (hollow) for 131399.....

## NUMERICAL LIST OF PARTS

No.	Plate	Name
68492	20538	Oil Pipe (back of arm) with 49191 and 68497, for oiling Feed Rocking Frame Hinge Pin Front Bearing.....
68493	20538	Oil Pipe (back of arm) Clamp.....
68494	20538	" " " " Connection with 49189, 68495 and two 198E, for oiling Feed Rocking Frame Hinge Pin Back Bearing.....
68495	20533	Feed Bar Slide Block Oil Pad (wick) for 134259.....
68495	20533	Oil Pipe (back of arm) Connection Oil Pad (wick) for 68494.....
68496	20538	Oil Pipe (back of arm) Coupling.....
68497	20533	Feed Connecting Rod Oil Pad (wick) for 131500.....
68497	20533	Looper Driving Shaft and Feed Lifting Eccentric Front Bearing Oil Pad (wick).....
68497	20533	Oil Pipe (back of arm) Oil Pad (wick) for 68492.....
68497	20533	Oil Pipe (front of arm) Oil Pad (wick) for 131112 and 131113.....
68498	20538	Oil Pipe (front of arm) with 131089 and two each 1733 and 49191, for oiling Looper Driving Shaft and Feed Lifting Eccentric Front Bearing, for 131258.....
68500	20538	Oil Pipe (front of arm) with 1733, 49191, 131084 and 131089, for oiling Arm Rotary Shaft Front Bearing, for 131258.....
79772	----	Bench Stand with 27998, two each 41538, 126849, three wood screws 1 1/4 in. No. 12, four each 60656, wood screws 1 1/4 in. No. 10 and sixteen wood screws 5/8 in. No. 7.....
120344	20545	Tweezers (curved) Accessories.....
120344	20545	Oiler (copper plated) with 120345 (Accessories).....
120345	20545	Oiler Spout, 4 1/2 in. long, for 120344 (Accessories).....
120440	20545	Screw Driver (large) Accessories.....
121108	20545	" " (small) Accessories.....
126247	9520	Bench Stand Flush Bolt, for 41538.....
126248	9520	" " " " Plate, for 41538..
126249	20549	Treadle, for 150452.....
126250	20547	" Spring, for 150452.....
126849	9520	Bench Stand Flap Hinge with four wood screws 3/4 in. No. 7, for 79772.....
127838	20530	Arm Rock Shaft Crank (front) Pin for 131474.....

## NUMERICAL LIST OF PARTS

No.	Plate	Name
128419	20546	Looper Carrier Connection Shaft Oil Pad (braided cotton).....
128510	20532	Balance Wheel Cover.....
131002	20538	Oil Pipe (front of arm) Connection with 131049 and two 198E, for oiling Looper Throw-out Device.....
131003	20538	Oil Pipe (front of arm) Connection with 49189 and two 198E, for 131112 and 131113.....
131004	20538	Oil Pipe (front of arm) Coupling (center)
131004	20538	" " " " " " (left).
131011	20539	Tension (upper thread) Releasing Shaft Spring Position Plate.....
131012	20542	Tension (under thread) Bracket.....
131022	20547	Machine Base Screw Stud Bushing (rubber) for 131446.....
131025	20553	Slack Thread Controller.....
131028	20546	Looper Driving Shaft and Feed Lifting Eccentric Bushing Oil Plug.....
*131049	----	Oil Pipe (front of arm) Connection Cap, for 131002.....
131050	20532	Cloth Plate Slide (left) Spring, for 131051.....
131051	----	Cloth Plate Slide (left) complete for 131388 and 131518, Nos. 68368, 131050 and two 725J.....
131056	20530	Arm Rock Shaft Adjusting Screw Washer...
131072	20550	" " " Crank, back (ball bearing solid) with two 50083C, for 68459....
131084	20538	Oil Pipe (front of arm) Connection with 131085 and two 198E, for 68500.....
*131085	----	Oil Pipe (front of arm) Connection Cap, for 131084.....
*131086	----	Oil Pipe (front of arm) Coupling (right) for 131087.....
131087	20538	Oil Pipe (front of arm) Coupling (right) 131086 with 131088.....
*131088	----	Oil Pipe (front of arm) Coupling (right) Oil Lead, for 131087.....
131089	20546	Oil Pipe (front of arm) Oil Pad (wick) for 68498 and 68500.....
131095	20550	Arm Rock Shaft Bushing (back) Cap Washer (fibre).....
*131110	20551	Looper Driving Shaft and Feed Lifting Eccentric with two 64315, for 131111.
*131111	----	Looper Driving Shaft and Feed Lifting Eccentric 131110 with 54027, 54227, 54228 and 68479, for 131510.....
131112	20538	Oil Pipe (front of arm) with 68497 with 131003, for oiling Feed Bar Slide Block, for 131258.....

## NUMERICAL LIST OF PARTS

No.	Plate	Name
131113	20538	Oil Pipe (front of arm) with 68497 and 131003, for oiling Feed Connecting Rod, for 131258.....
131133	20535	Looper, for 131134.....
131134	-----	" 131133 with 229J and 131135.....
131135	20535	" Needle Guard with 46105, for 131134.....
131185	20526	Machine Base Oil Drain Jar (glass) for 131268.....
131188	20526	Machine Base Oil Drain Jar Clamp, for 131217.....
131189	20526	Machine Base Oil Drain Jar Clamp Lever, for 131217.....
131191	20526	Machine Base Oil Drain Jar Cap, for 131268.....
131197	20551	Feed Bar Hinge Pin (eccentric) for 131398.....
131198	20557	Presser Bar Spring (auxiliary) complete, Nos. 4604, 131231 and 131232.....
131205	20547	Machine Base Screw Stud, to position machine on base, for 131264.....
131217	-----	Machine Base Oil Drain Jar Clamp 131188 with 131189, for 131268.....
*131231	-----	Presser Bar Spring (auxiliary) for 131198.....
*131232	-----	Presser Bar Spring (auxiliary) Guide, for 131198.....
131240	20551	Feed Rocking Frame with two 453C, for 131398.....
131258	-----	Oil Pipe (front of arm) complete, Nos. 68498, 68500, 131112 and 131113.....
131263	20549	Machine Base, for 131264.....
131264	-----	Machine Base complete for 131328, Nos. 131263, three each 9842, 51576E, 54477 and four each 131205 and 131279.....
131265	20526	Machine Base Oil Drain Jar Nipple (long) for 131268.....
131266	20526	Machine Base Oil Drain Jar Nipple (short) for 131268.....
131267	20526	Machine Base Oil Drain Jar Nipple Elbow, for 131268.....
131268	-----	Machine Base Oil Drain Jar (swinging type) complete for 131328, Nos. 131185 131191, 131217, 131266 and two each 1247C, 131265 and 131267.....
131270	20552	Needle Bar Connecting Link Hinge Stud Oil Pad (wick).....
131276	20526	Arm Side Cover (oil vent) for 131278....
131277	20526	" " " Cap, for 131278.....
131278	-----	Arm Side Cover (oil vent) complete, Nos. 51224W, 131276, 131277 and 131280.....

## NUMERICAL LIST OF PARTS

No.	Plate	Name
131279	20547	Machine Cushion (felt) for 131264.....
131280	20530	Arm Side Cover Cap Position Pin, for 131278.....
131291	20552	Needle Bar Bushing (lower).....
131292	20558	Presser Bar Bushing (lower).....
131293	20550	Arm Rock Shaft, for 131474.....
131305	20529	" Oil Cup Drip Pan with two 583C.....
131309	20529	" " " 68430 with 131310, for filling oil reservoir.....
131310	20529	Arm Oil Cup Oil Tube, for 131309.....
131316	20552	Needle Guard (movable).....
131319	20530	Arm Oil Cup Oil Pad (braided cotton) for 68350.....
131328	-----	Machine Base and Oil Drain Jar (swinging type) complete, Nos. 131264 and 131268.....
131332	20553	Thread (upper) Take-up, for 131333.....
131333	-----	Thread (upper) Take-up complete, Nos. 1449J, 54194, 68164 and 131332.....
131366	20550	Arm Rotary Shaft Ball Bearing (back) for 131526.....
131366	20550	Arm Rotary Shaft Ball Bearing (intermediate).....
131369	20529	Arm Rotary Shaft Ball Bearing (back) Case Cap, for 131479.....
131370	20530	Arm Rotary Shaft Ball Bearing (back) Case Position Stud.....
131374	20559	Cloth Plate, for 131388, for 147-84 Machine.....
131375	20532	Cloth Plate Slide (right) for 131382, for 147-84 Machine.....
131381	20532	Cloth Plate Slide (right) Spring, for 131382 and 131517.....
131382	-----	Cloth Plate Slide (right) complete for 131388, for 147-84 Machine, Nos. 131375, 131381 and two 725J.....
131388	-----	Cloth Plate complete, for 147-84 Machine, Nos. 131051, 131374 and 131382.....
131394	20558	Cloth Plate Thread Guard.....
131395	20532	Face Plate (upper half).....
131396	20551	Feed Bar, for 131397.....
131397	20551	Feed Bar complete for 131398, Nos. 50429C, 68467, 131396 and two 207E.....
131398	-----	Feed Rocking Frame 131240 with 59343, 131197 and 131397.....
131399	-----	Needle Bar Connecting Link and Thread (upper) Controller 68488 with 68489 and 131400.....
131400	20552	Needle Bar Connecting Stud with 211F and 1492E, for 131399.....
131401	20556	Presser Bar Lifting Bracket with 453C...

No.	Plate	Name
131402	20542	Presser Bar Lifting Lever.....
131404	20540	Slack Thread Regulator Holder.....
131405	20540	" " " " Crank with 171E.....
131406	20540	Slack Thread Regulator Holder Crank Con- necting Link.....
131407	20539	Thread (under) Take-up with 1258C.....
131408	20553	" " " Oil Guard, for 131420.....
131409	20553	Thread (under) Take-up Stripper, for 131420.....
131410	20542	Thread (under) Take-up Stripper Plate, for 131420.....
131411	20542	Thread (under) Take-up Stripper Plate Bracket, for 131420.....
131413	20553	Thread (under) Take-up Thread Guard (fibre) for 131420.....
131417	20558	Cloth Plate, for 131518, for 147-85 Ma- chine.....
131419	20540	Slack Thread Regulator.....
131420	-----	Thread (under) Take-up Stripper Plate Bracket 131411 with 32062, 50438J, 54242, 131408 to 131410, 131413, 131421 131422, two each 207J, 7071, 50470J and four 190J.....
131421	20553	Thread (under) Take-up Thread Guide (left) for 131420.....
131422	20553	Thread (under) Take-up Thread Guide (right) for 131420.....
*131446	-----	Arm, upper and lower (solid) with 948J, 15404, 68483, two 15405 and four 131022.....
131456	20550	Arm Rock Shaft Flanged Bushing (front)..
131457	20539	" Rotary Shaft Bushing (front).....
*131471	20550	Crank Connecting Rod with two each 896C and 1057C, for 68459.....
131474	-----	Arm Rock Shaft 131293 with 1235F, 127838 and 131475.....
131475	20550	Arm Rock Shaft Crank (front) with 853C, for 131474.....
131478	20529	Arm Rotary Shaft Ball Bearing (back) Case, for 131479.....
131479	-----	Arm Rotary Shaft Ball Bearing (back) Case 131478 with 131369 and three 205C, for 131526.....
131480	20539	Arm Rotary Shaft Ball Bearing (back) Spacing Collar, for 131526.....
131481	20550	Arm Rotary Shaft Ball Bearing (intermed- iate) Case.....
131482	20539	Arm Rotary Shaft Ball Bearing (intermed- iate) Collar with two 457C.....

No.	Plate	Name
131483	20532	Balance Wheel, 2 in. pulley, with two 51283C.....
131487	20558	Arm Rotary Shaft, for 131510.....
131500	20551	Feed Connecting Rod with 1057C, 68497, 134260 and two 896C, for 131502.....
131502	-----	Feed Connecting Rod 131500 with 54025, for 131510.....
131503	20554	Feed Dog, 17 teeth (12 teeth to the inch) for 131509, for 147-84 Machine.....
131505	20552	Needle Guard (stationary).....
131506	-----	Presser Foot Plate, for 131508.....
131507	-----	" " Shank, for 131508.....
131508	20554	Presser Foot (hinged) complete, Nos. 26278 131506 and 131507.....
131509	20554	Throat Plate, for 131503, for 147-84 Ma- chine.....
131510	-----	Arm Rotary Shaft 131487 with 640E, 68459, 131111 and 131502.....
131516	20557	Cloth Plate Slide (right) for 131517, for 147-85 Machine.....
131517	-----	Cloth Plate Slide (right) complete for 131518, for 147-85 Machine, Nos. 131381 131516 and two 725J.....
131518	-----	Cloth Plate complete, for 147-85 Machine, Nos. 131051, 131417 and 131517.....
131519	20555	Feed Dog, 17 teeth (12 teeth to the inch) for 131520, for 147-85 Machine.....
131520	20555	Throat Plate, for 131519, for 147-85 Ma- chine.....
131521	20555	Throat Plate Filling-in Piece, for plain stitching, for 147-85 Machine.....
131522	20556	Looper Holder with 1120C, for 147-85 Ma- chine.....
131526	-----	Arm Rotary Shaft Ball Bearing (back) Case with Ball Bearings complete, Nos. 131479, 131480 and two 131366....
134258	20533	Feed Bar Slide Block, for 134259.....
134259	20533	" " " " 134259 with 68495 and 134260.....
134260	20533	Feed Bar Slide Block Oil Pad Retainer, for 134259.....
134260	20533	Feed Connecting Rod Oil Pad Retainer, for 131500.....
138306	20533	Feed Eccentric Lubricating Pad (wood) for 54024.....
139017	20530	Arm Hole Plug Screw Washer.....
*150059	-----	Thread Unwinder Thread Separator Bracket for 150086.....
150060	20787	Thread Unwinder Thread Separator Bracket Arm with 164J and 9525, for 150087..

## NUMERICAL LIST OF PARTS

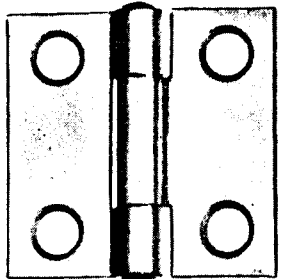
No.	Plate	Name
*150085	-----	Thread Unwinder Thread Separator, for 150086.....
150086	20787	Thread Unwinder Thread Separator 150085 with 150059, for 150087.....
150087	-----	Thread Unwinder Thread Separator com- plete, for 150088, Nos. 164J, 9525, 150080 and 150086.....
150088	20787	Thread Unwinder complete, for two spools, Nos. 150087, 201696J, 202490, 225257, 225324, 225326, 225388, two each 150203 225391 and three wood screws 7/8 in. No. 12.....
150203	20787	Thread Unwinder Spool Rest Cushion (felt) for 150088.....
150451	20549	Treadle Stand, for 150452.....
150452	20549	Treadle complete, Nos. 4879, 4882, 126249, 126250, 150451 and two wood screws 1 in. No. 16 F.H.....
200383C	20546	Thread Unwinder Spool Rest Rod Set Screw for 202490.....
201018C	20546	Thread Unwinder Spool Rest Set Screw, for 225257.....
201696J	20546	Thread Unwinder Thread Guide Lock Nut, for 150088.....
202490	20787	Thread Unwinder Spool Stand with 200383C for 150088.....
225257	20787	Thread Unwinder Spool Rest (for two spools) with 201018C, for 150088....
225322	20546	Thread Unwinder Thread Guide Rod Washer, for 225324.....
225324	20787	Thread Unwinder Thread Guide Rod with 208E and 225322, for 150088.....
225326	20546	Thread Unwinder Thread Guide Position Cup, for 150088.....
225388	20787	Thread Unwinder Spool Rest Rod, for 150088.....
225390	20557	Thread Unwinder Thread Cone Holder, for inverted cones.....
225391	20787	Thread Unwinder Thread Guide, for 150088.

ILLUSTRATIONS  
OF  
PARTS

126217



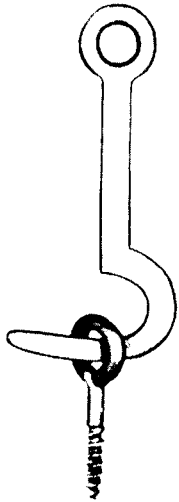
126819



126218



27998



60656

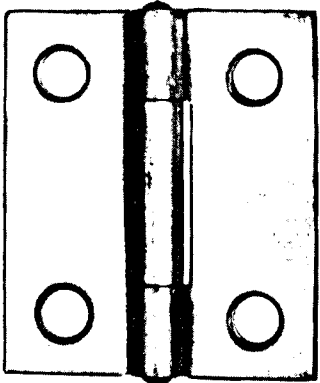


PLATE 20526—ONE-HALF SIZE

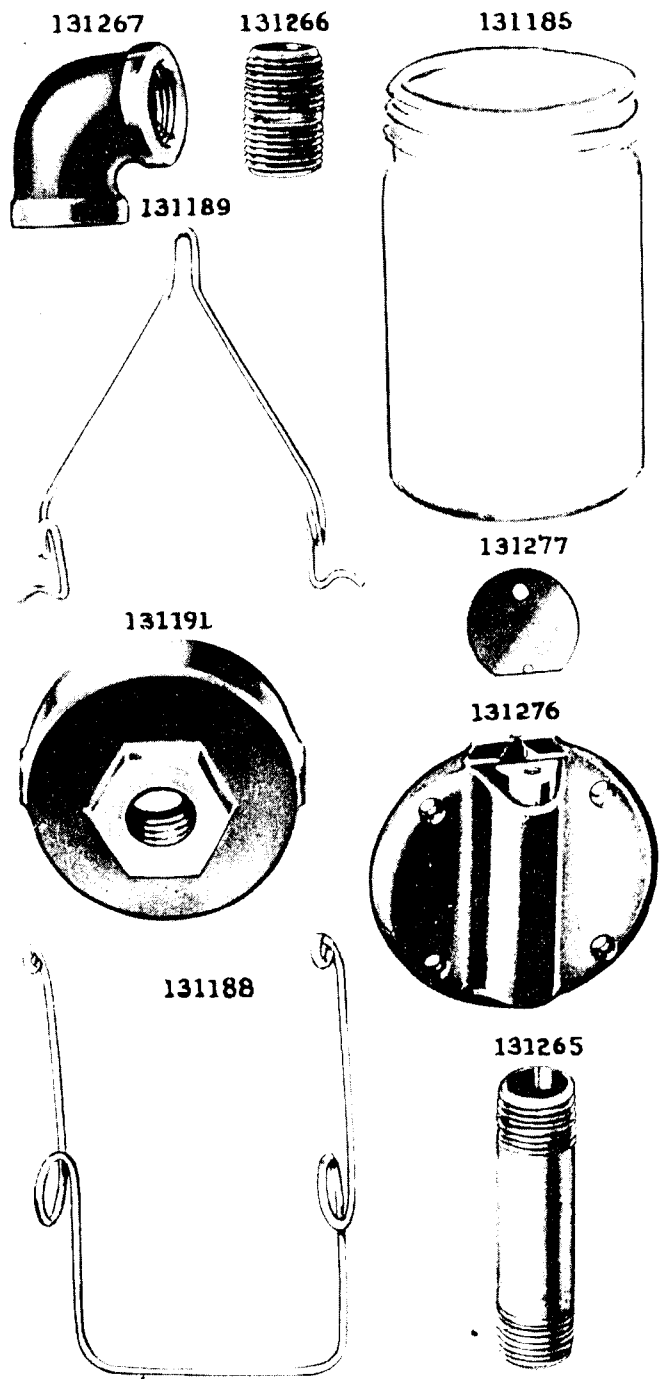


PLATE 20529 - ONE-HALF SIZE

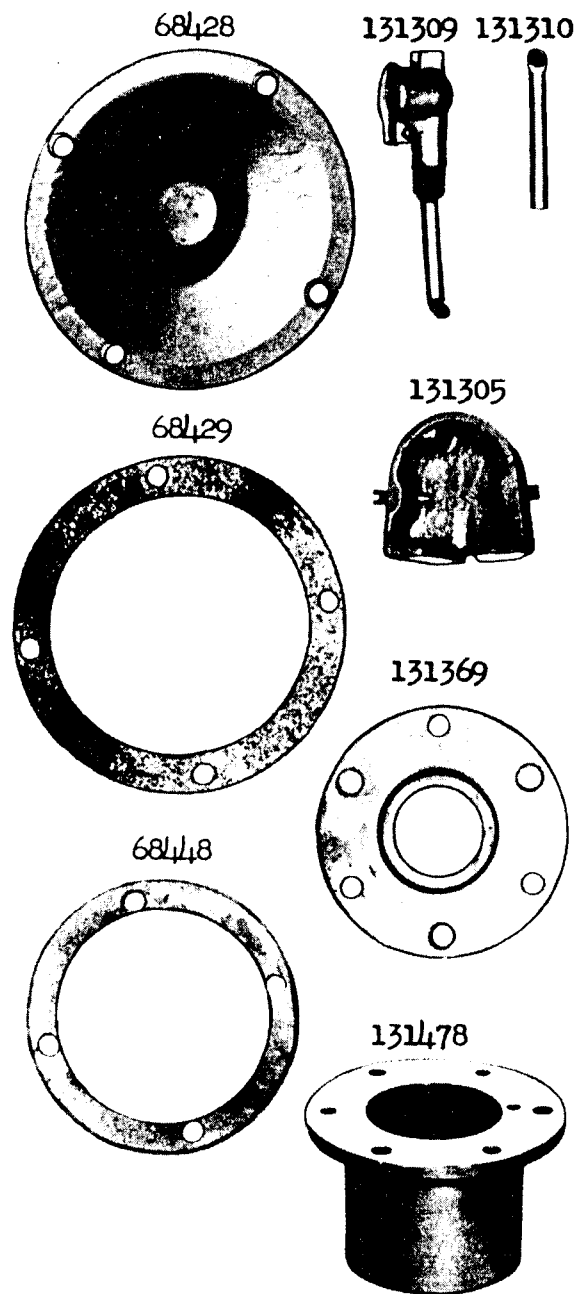




PLATE 20530 - FULL SIZE

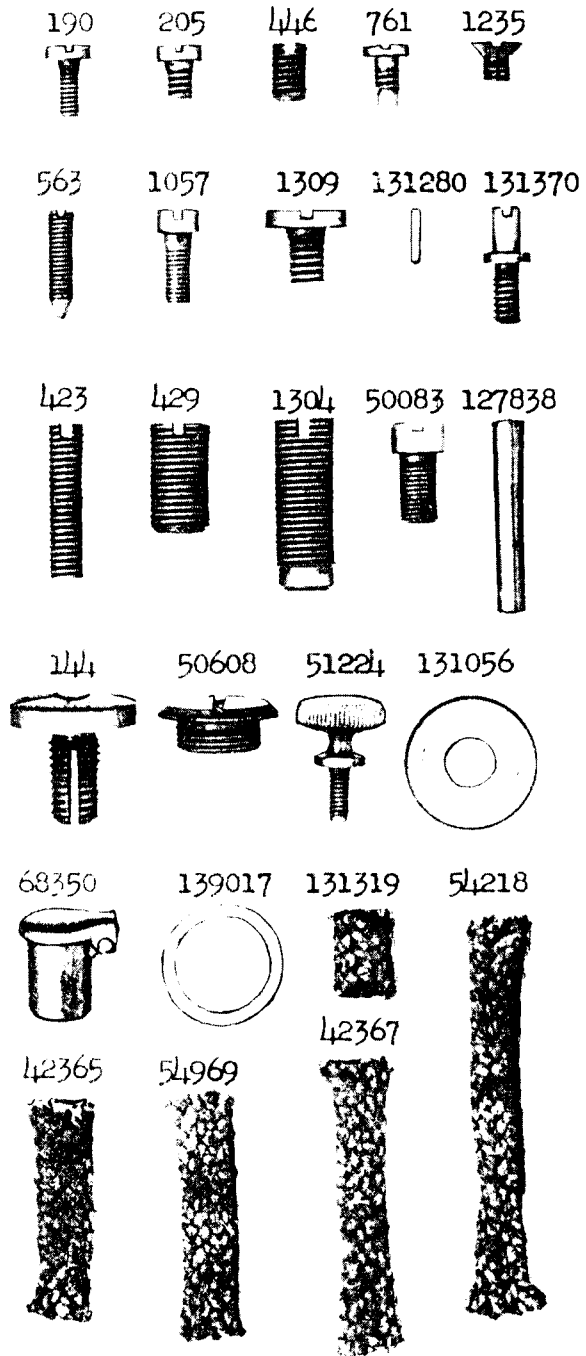


PLATE 20532 - ONE-HALF SIZE

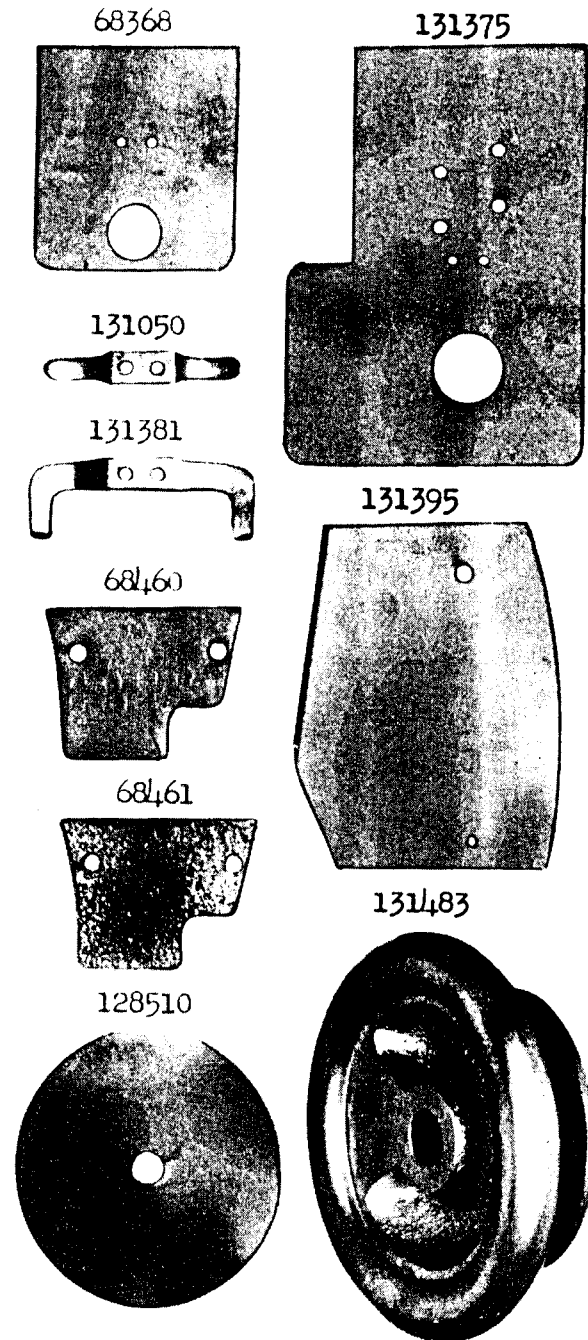


PLATE 20533 - FULL SIZE

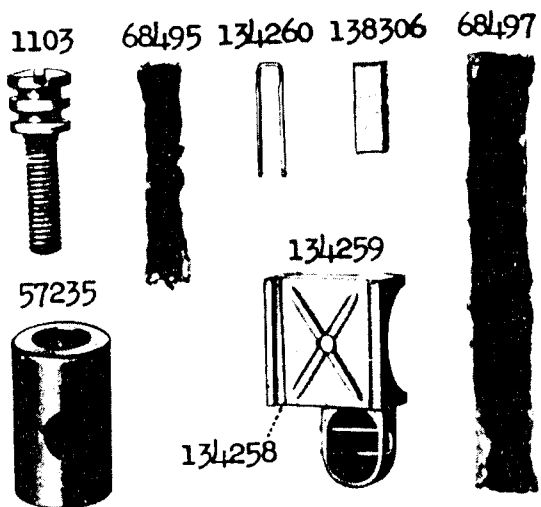
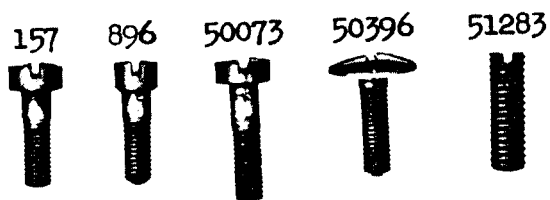
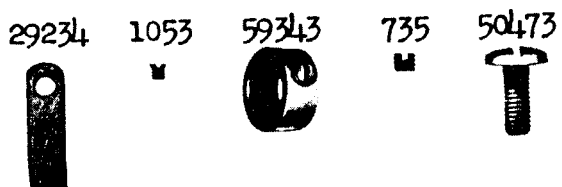


PLATE 20535 - FULL SIZE

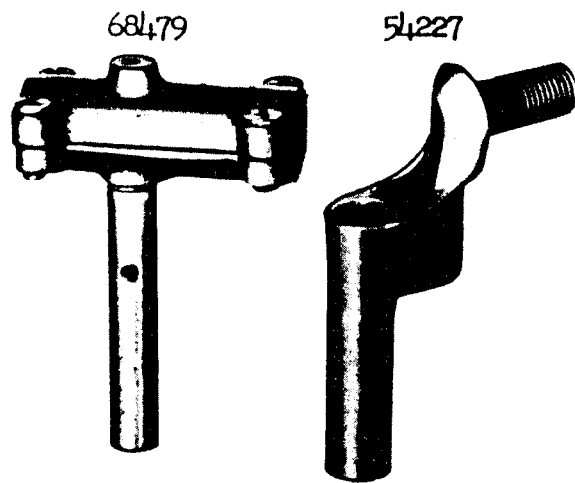
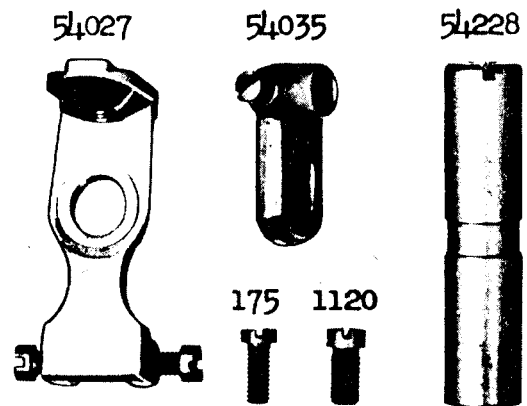
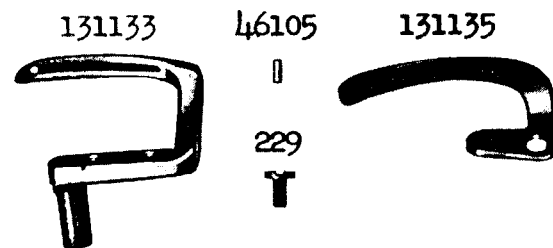


PLATE 20538 - ONE-HALF SIZE

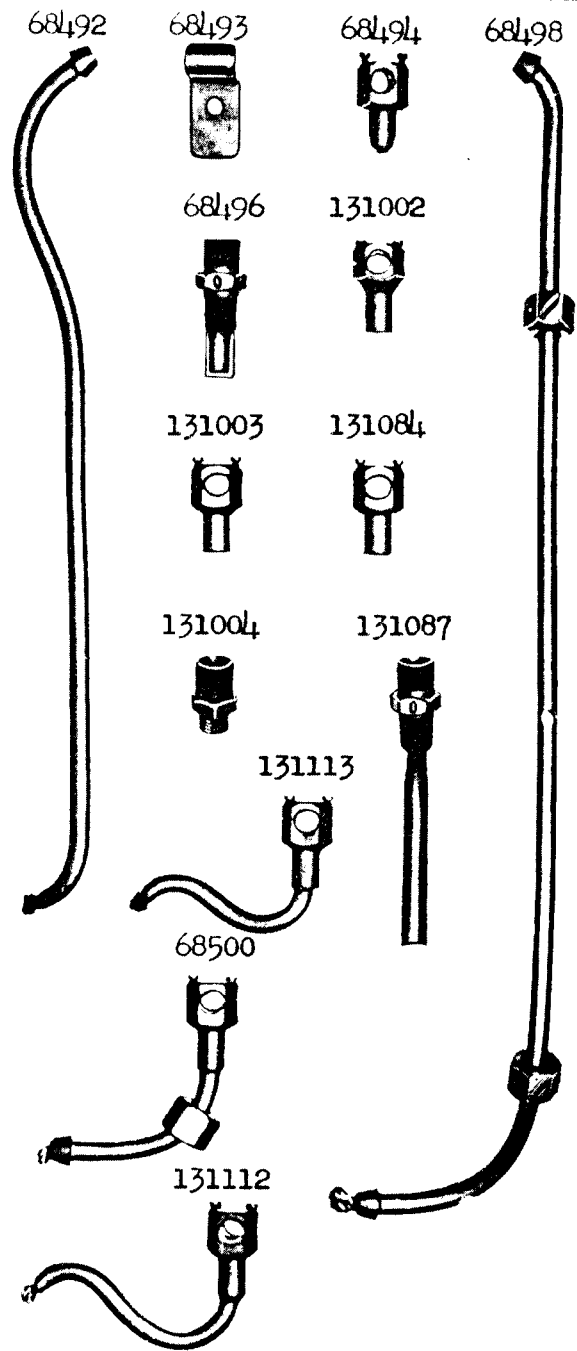


PLATE 20539 - FULL SIZE

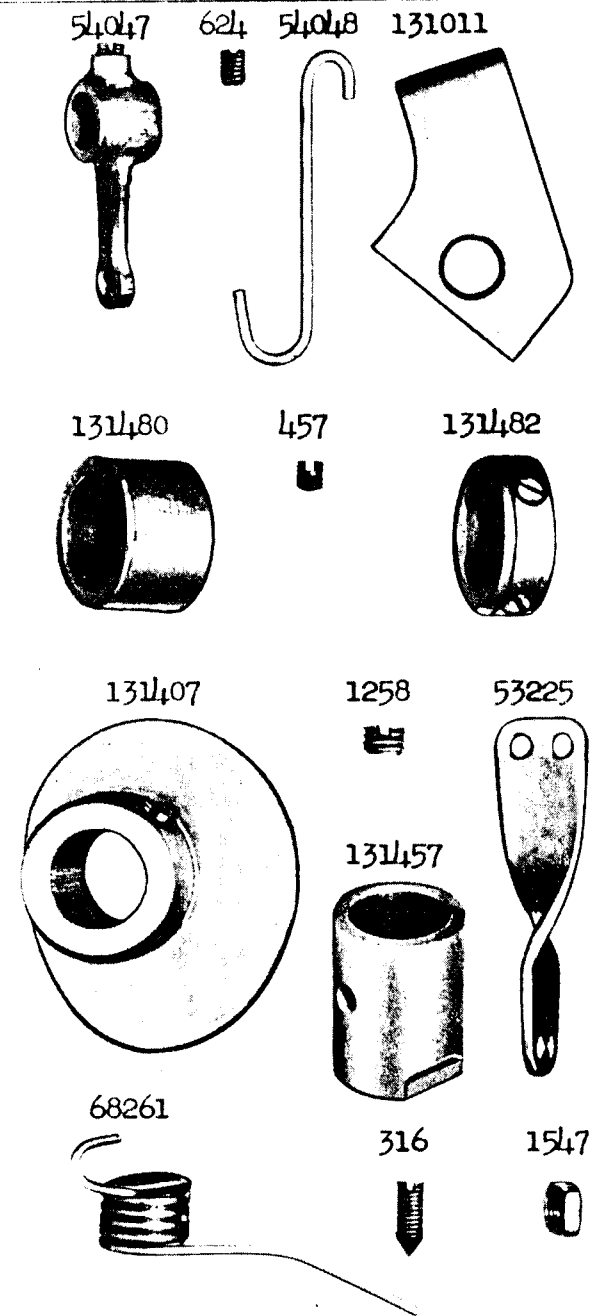


PLATE 20540 - FULL SIZE

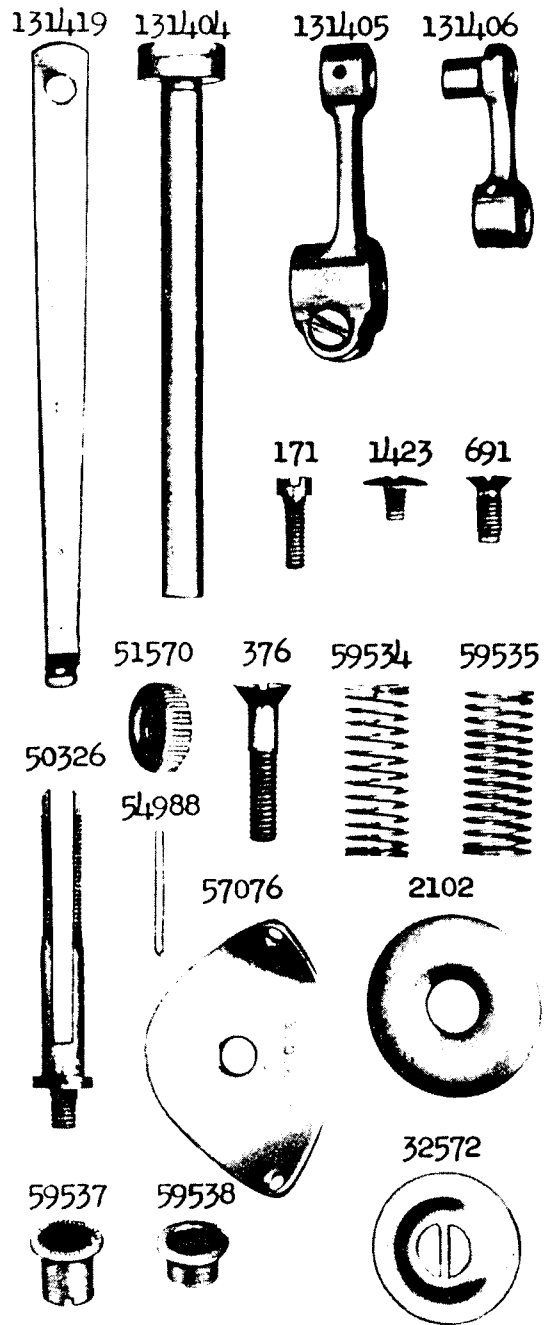


PLATE 20542 - ONE-HALF SIZE

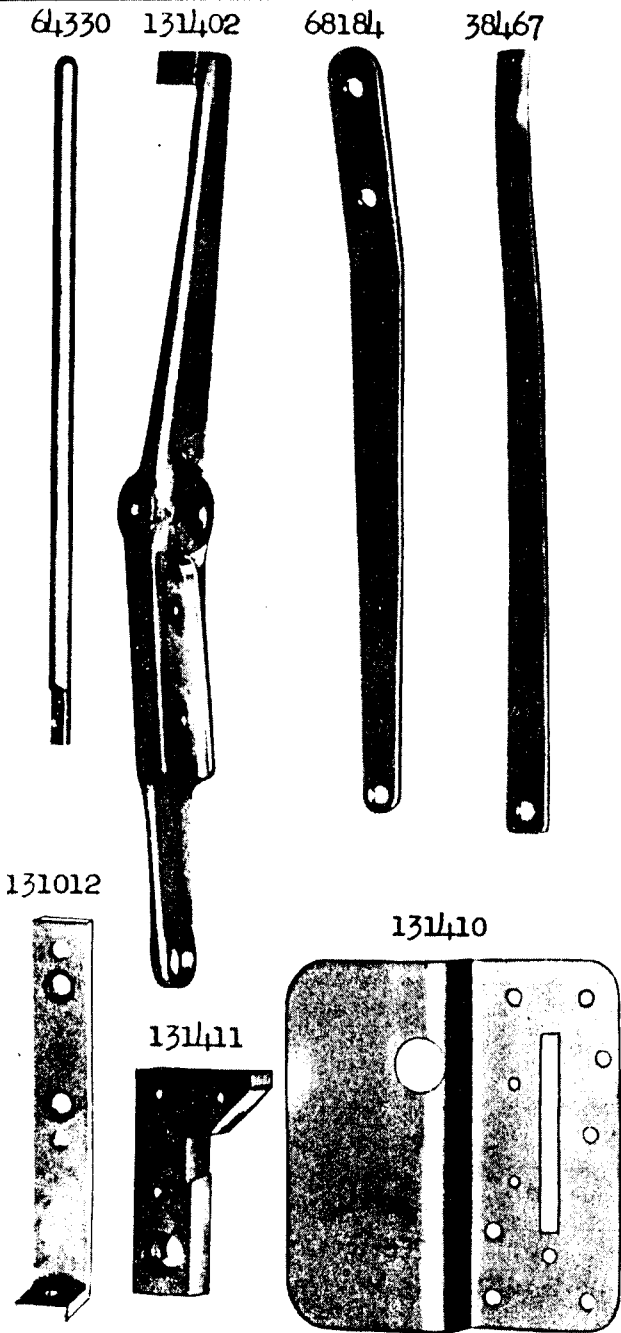


PLATE 20545 - ONE-HALF SIZE

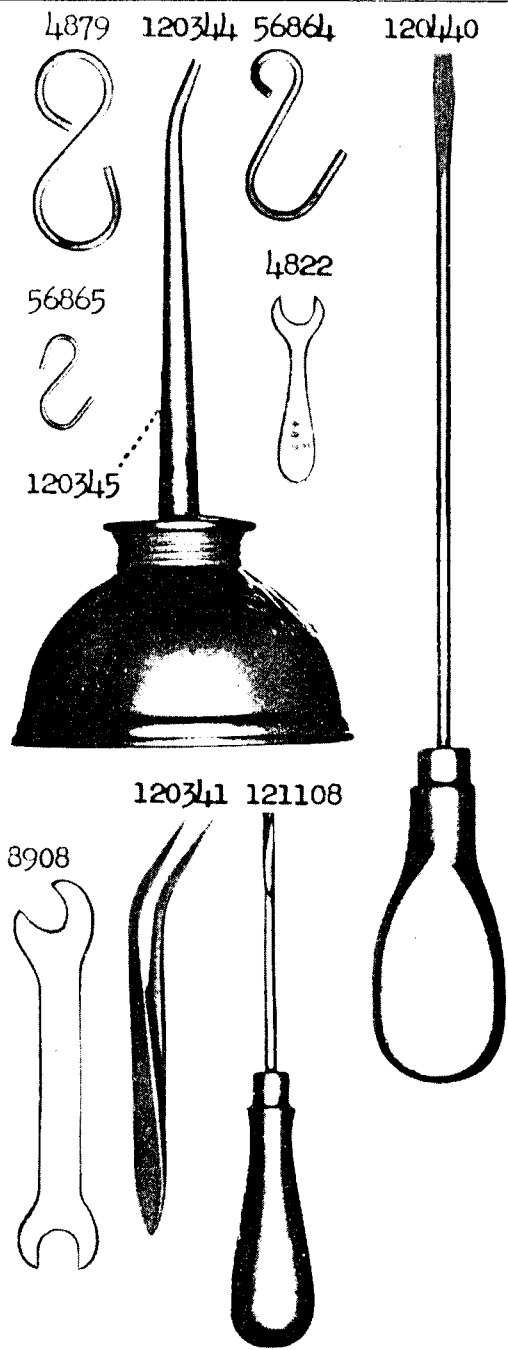


PLATE 20546 - FULL SIZE

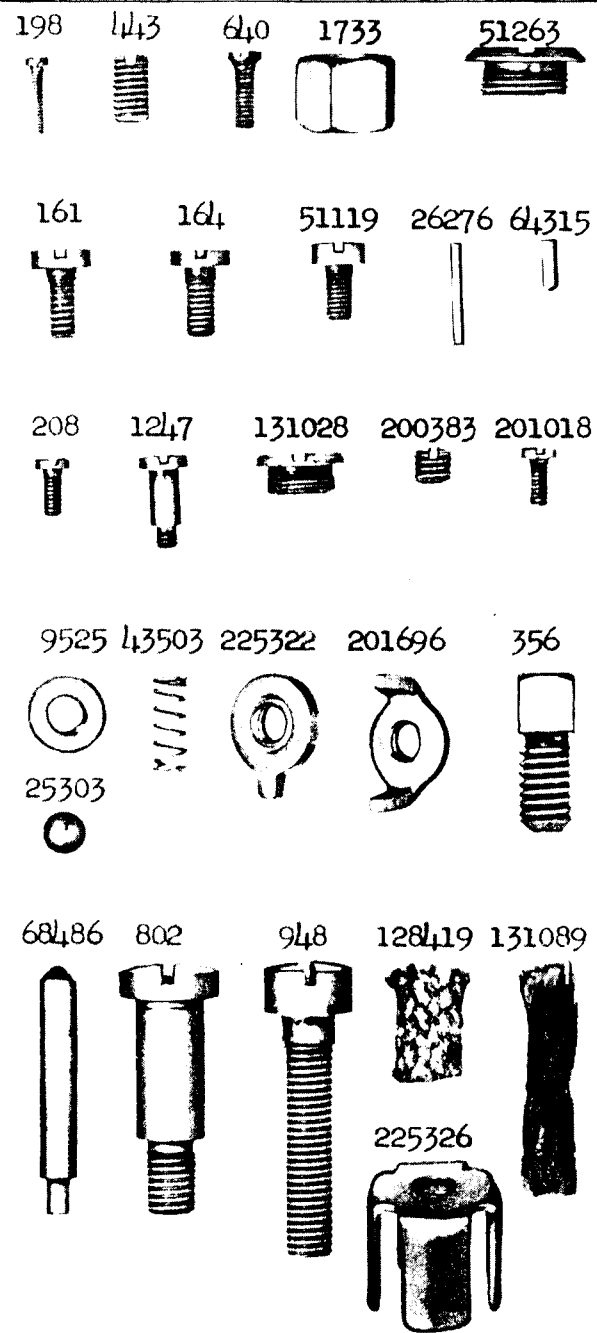
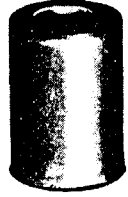


PLATE 20547 - FULL SIZE

4882



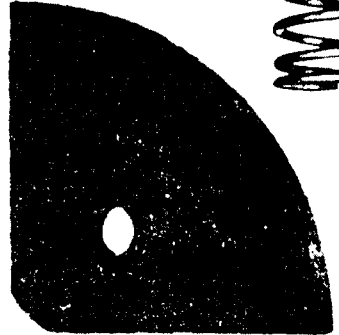
131022



126250



131279



54477



9842



131205

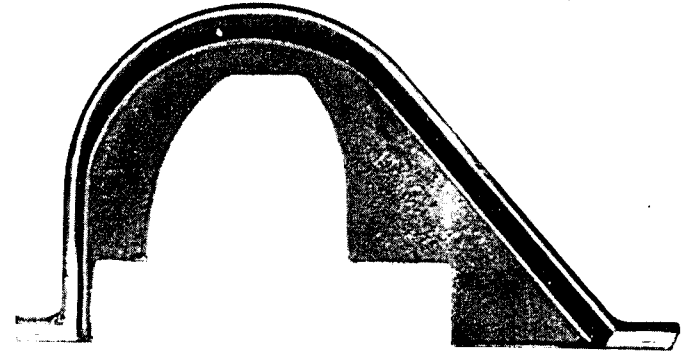


51576



PLATE 20549 - ONE-FOURTH SIZE

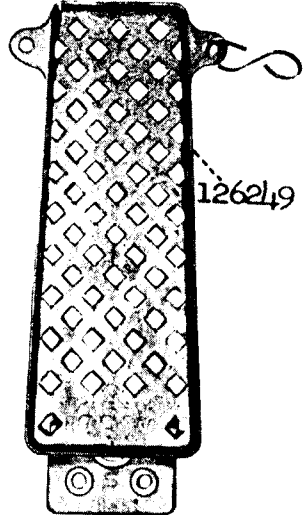
68222



131263



150452



126249

150451

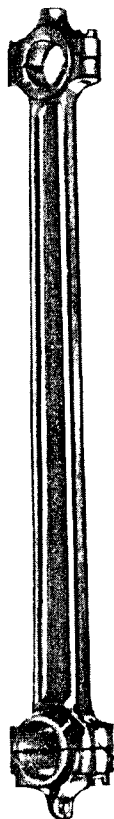


PLATE 20550 - ONE-HALF SIZE

131293



131471



131072



68435



131095



131456



68433



131366



68436



131475

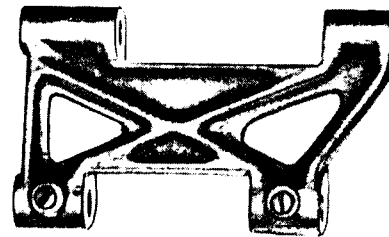


131481



PLATE 20551 - ONE-HALF SIZE

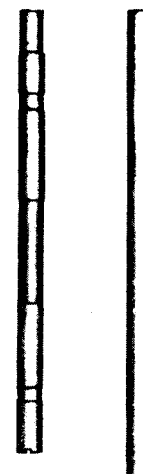
131240



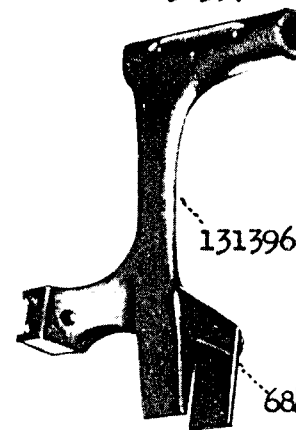
54025



131197 57234



131397



68484



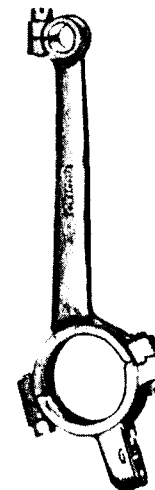
131396

68467

131110



131500



68478



68485



PLATE 20552 - FULL SIZE

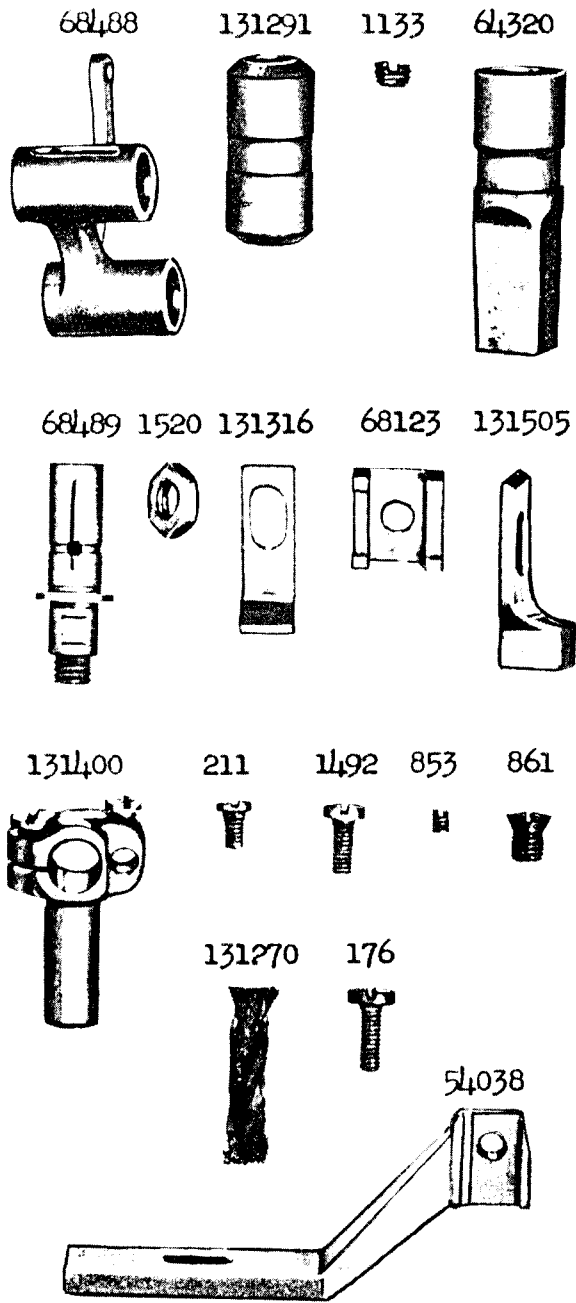


PLATE 20553 - FULL SIZE

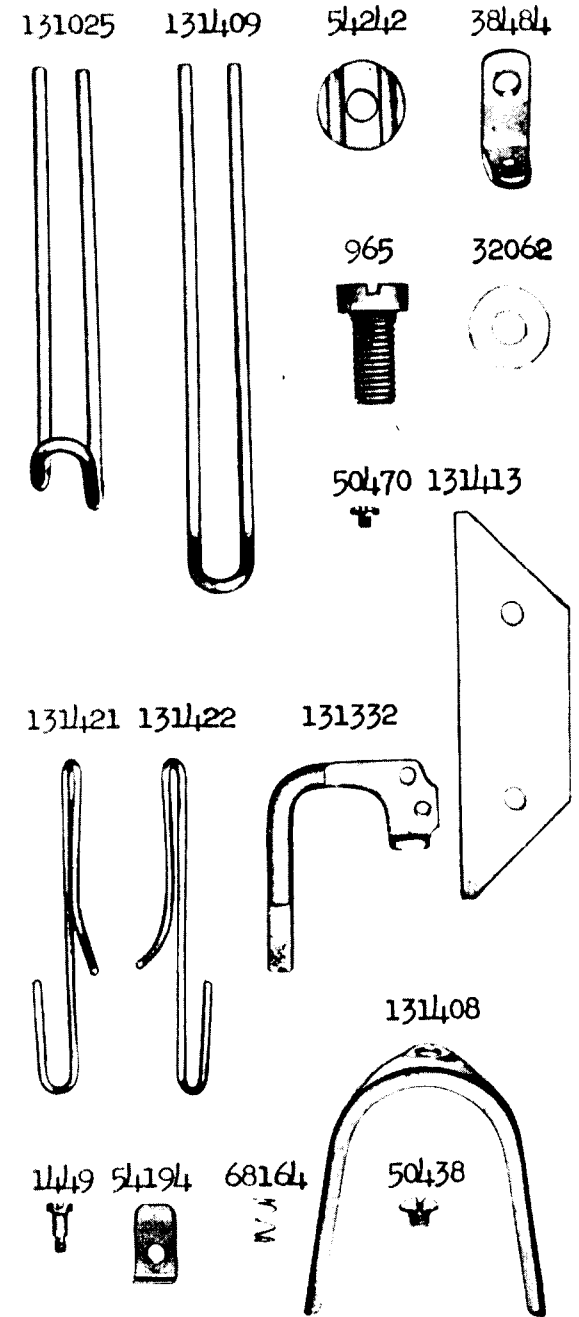
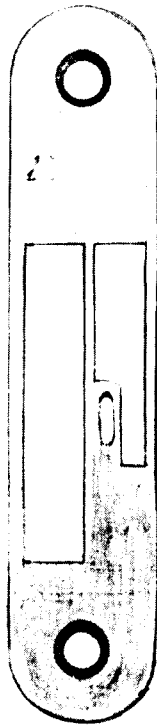


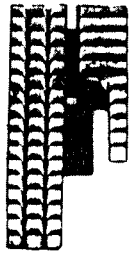


PLATE 20554 - FULL SIZE

131509



131503



12 teeth = 1 inch

131508

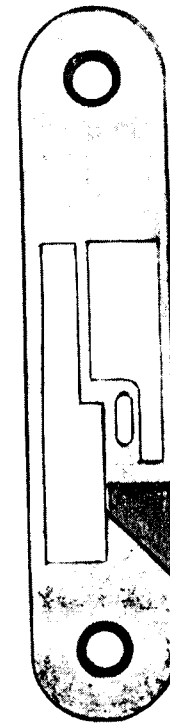


742

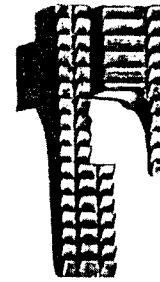


PLATE 20555 - FULL SIZE

131520

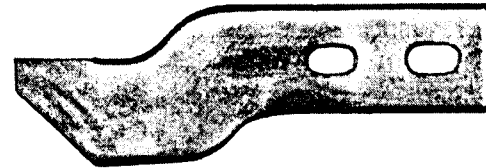


131519



12 teeth = 1 inch

131521



1143



PLATE 20556 - FULL SIZE

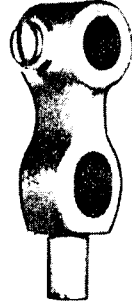
131292



38456



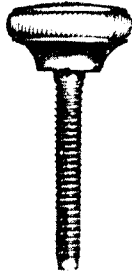
131401



453



574



1539



857



4604



50376



38468



11173



131522

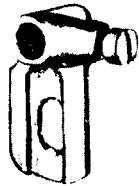


PLATE 20557 - ONE-HALF SIZE

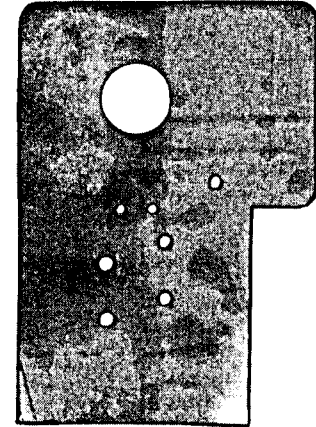
54208



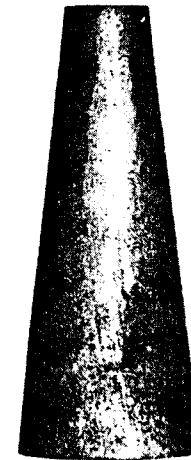
131198



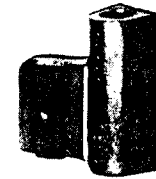
131516



27739



54045



225390

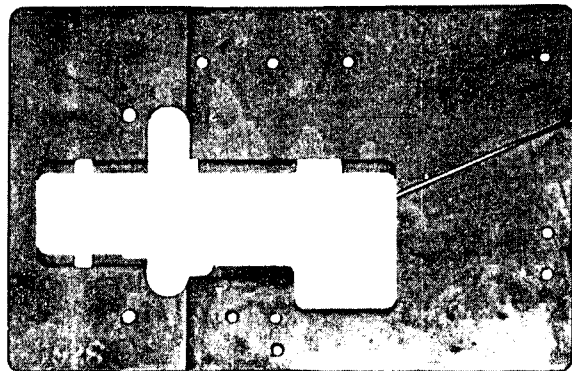


54046



PLATE 20558 - ONE-FOURTH SIZE

131417



131487



131394

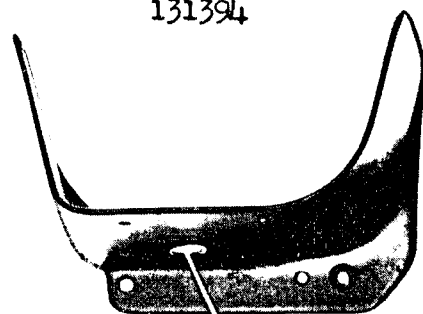


PLATE 20559 - ONE-FOURTH SIZE

131374

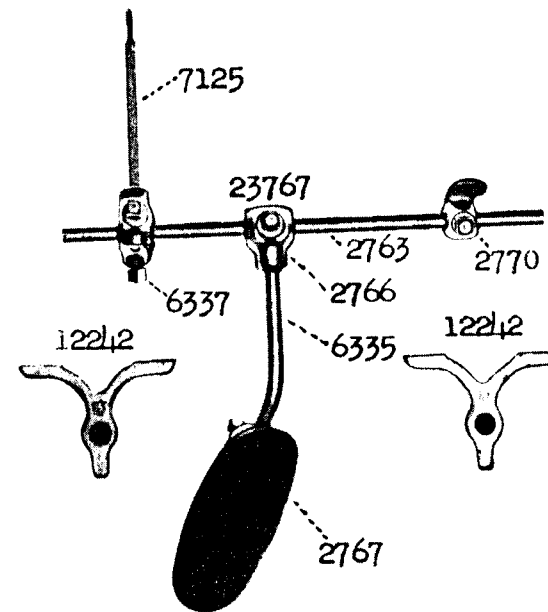
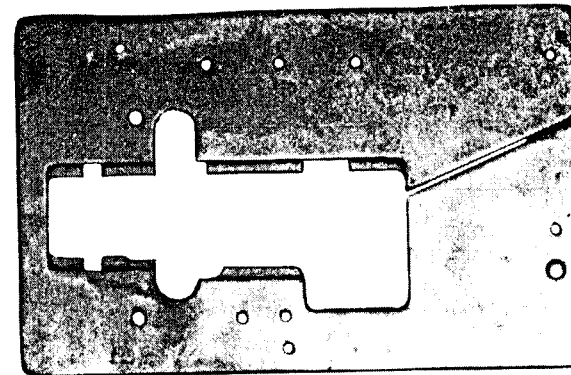


PLATE 20787—ONE-SIXTH SIZE

