

**SINGER**  
**21W52 & 21W162**

# LIST OF PARTS



## MACHINES Nos. 21w52 and 21w162

THE SINGER MANUFACTURING COMPANY

## INDEX

---

|                               | PAGE   |
|-------------------------------|--------|
| ACCESSORIES .....             | 17     |
| BOBBIN WINDER .....           | 17     |
| KNEE LIFTER .....             | 18, 19 |
| MACHINE NO. 21w52 .....       | 7      |
| "    "    21w162 .....        | 16     |
| NUMERICAL LIST OF PARTS ..... | 25     |
| OBSOLETE PARTS .....          | 24     |
| PRESSER FEET .....            | 20     |
| ROLLER PRESSERS .....         | 21     |
| THROAT PLATES .....           | 24     |

# Instructions for Ordering

In ordering from this list, use **ONLY** the **PART** number in the **FIRST** column.

The number stamped on a Sewing Machine Part is the number of the Single Part only, except when the part includes Set Screws, Clamping Screws, Studs and Rollers Spun on, Small Wires riveted, or Parts soldered together, etc., which it is necessary to furnish in combination.

Every combination of parts sent out has its specific number which, although not stamped on Parts (except in above cases) must be used when ordering the combination.

Each number always indicates the **SAME PART** in whatever list it appears, or for whatever Machine.

The letters after some of the numbers indicate the style of finish only, as follows:

- A. Hardened, Polished and Plated.
- B. Polished and Plated.
- C. Hardened only.
- D. Polished only.
- E. Soft, not polished.
- F. Hardened and Polished.
- H. Blued.

These letters **MUST BE USED** when they appear in the list and **AFTER** the number, as in the list.

In this series

200001 to 201500 are Screw Numbers.

201501 to 201800 are Nut Numbers.

201801 to 202000 are Roller Numbers.

202001 and upward are numbers of Machine Parts.

The figures in the second column refer only to the plate in which the illustration of the part is shown and are **NOT TO BE USED** in ordering.

Two or more numbers over a cut indicate that the difference between such parts is not visible in an illustration.

Parts marked with an asterisk (\*) are furnished only when repairs are made at the factory.

## LIST OF PARTS COMPLETE

FOR

## MACHINE No. 21w52

WHEEL FEED. ROLLER PRESSER

For Gloves and Shoes.

| No.     | Plate | Name  |
|---------|-------|---|
| *204161 | —     | Arm with 200439c, 202036 and 204705 .....   |
| 204163  | 12305 | Arm Cap .....   |
| 200278H | 12311 | " " Screw .....   |
| 202248  | 12307 | " " Washer .....  |
| 204235  | 13045 | " Position Pin (2) .....  |
| 200963E | 12311 | " Screw (3) .....   |
| 202005  | 12308 | " " Washer (3) .....  |
| 203202  | 12298 | " Shaft .....   |
| 204705  | 12304 | " " Bushing (front) .....   |
| 200439C | 12311 | " " Position Screw ....   |
| 204440  | 12299 | " " Connection with four 200054E (2) .....  |
| 200054E | 12307 | Arm Shaft Connection Screw ....   |
| 202299  | —     | " " Oil Packing (wick) (2)  |
| 203204  | 12298 | Balance Wheel, 5½ in. diam. (belt groove 2 in. diam.), with 200328c and 200335c ..... |
| 200062H | 12311 | Balance Wheel Adjusting Screw ...   |
| 200328c | 12311 | " " Position Screw ....   |
| 200335c | 12311 | " " Set Screw .....   |
| *203205 | —     | Bed with 202062, 203248, 203249, two each 200362c, 200516E, 200840E and 202299 ...    |
| 202258  | 12315 | Bed Hinge Connection (2) .....  |
| 200570E | 12311 | " " " Screw (4) ....  |
| 203329  | 12302 | " Slide (back) .....  |
| 203207  | 12299 | " " (front) .....   |
| 203470  | 12393 | Bobbin .....  |
| *203498 | —     | " Case .....  |
| 203648  | 12393 | " " Latch .....   |
| *202056 | —     | " " " Pin .....   |
| 203473  | 12393 | " " " Plunger .....   |
| 203474  | 12393 | " " " Spring .....  |
| 203499  | 13048 | " " Lever .....   |
| 203476  | —     | " " " Eccentric .....   |

| No.     | Plate | Name  |
|---------|-------|---|
| 204243  | —     | Bobbin Case Lever Eccentric Position Pin .....  |
| 203506  | 13048 | Bobbin Case Lever Fulcrum .....   |
| 200056D | 12319 | " " " " Screw ..  |
| 203478  | 13048 | " " " Slide Stud ....   |
| 203214  | 13045 | " " Tension Spring .....  |
| 200984C | 13045 | " " " " Regulating Screw .....  |
| 200594C | 13045 | Bobbin Case Tension Spring Screw  |
| 203216  | —     | " " Washer (cloth) .....  |
| 203500  | 13048 | Bobbin Case complete, Nos. 200594C, 200984C, 202056, 203214, 203216, 203473, 203474, 203498 and 203648                                  |
| 204184  | 12298 | Face Plate with 200335H, 200368C, 200688C, 202090, 204185, 204281 and two 200297H .....   |
| 200053C | 12311 | Face Plate Screw .....  |
| 204185  | 12310 | " " Thread Guide .....  |
| 200397H | 12309 | " " " " Set Screw   |
| 204300  | 13046 | Face Plate complete, Nos. 200113F, 200135C, 200309E, 200319C, 200577H, 204059, 204184, 204267, 204272, 204277 to 204280 and 204330 .... |
| 204338  | 12232 | Feed Driving Cam with 200382C and 200437C .....   |
| 204192  | 12304 | Feed Driving Cam Fork Lever with 204195 and 204293 .....  |
| 204193  | 12299 | Feed Driving Cam Fork Lever Connection with 200688C and 201525E   |
| 204194  | 12306 | Feed Driving Cam Fork Lever Connection Clamp with 200031E ....  |
| 200031F | 12311 | Feed Driving Cam Fork Lever Connection Clamp Pinch Screw ....   |
| 200668C | 12310 | Feed Driving Cam Fork Lever Connection Clamp Screw Stud ....  |
| 201525E | 12310 | Feed Driving Cam Fork Lever Connection Clamp Screw Stud Nut   |
| 200002E | 12310 | Feed Driving Cam Fork Lever Connection Hinge Screw .....  |
| 201522  | 12310 | Feed Driving Cam Fork Lever Connection Hinge Screw Nut .....  |
| *204195 | —     | Feed Driving Cam Fork Lever Shaft   |
| 204197  | 12306 | " " " " " "   |
|         |       | Collar with 200113F .....   |
| 200113F | 12308 | Feed Driving Cam Fork Lever Shaft Collar Set Screw .....  |
| 204293  | 12308 | Feed Driving Cam Fork Lever Shaft Position Pin .....  |
| 204196  | 12307 | Feed Driving Cam Fork Lever Shaft Sleeve (split) .....  |

| No.     | Plate | Name   |
|---------|-------|--|
| 200043C | 12311 | Feed Driving Cam Fork Lever Shaft Sleeve Set Screw .....                       |
| 201524E | 12310 | Feed Driving Cam Fork Lever Shaft Sleeve Set Screw Nut .....                   |
| 204198  | 12304 | Feed Driving Cam Fork Lever complete, Nos. 204192 and 204194.....              |
| 200437C | 12311 | Feed Driving Cam Position Screw  |
| 200382C | 13045 | " " " Set Screw ....   |
| 204199  | 12298 | " " Rock Shaft .....   |
| 206554  | —     | " " " " 204199 with 200002E, 201522E and 204193 .....                          |
| 202305  | 12307 | Feed Driving Rock Shaft Center (2)   |
| 200043C | 12311 | " " " " " Set Screw (2) .....  |
| 204206  | 12306 | Feed Regulating Handle .....   |
| 204207  | 12304 | " " " " 204206 with 200098D, 202622, 204208 to 204210, 204213 and 204925 ..... |
| 204208  | 12307 | Feed Regulating Handle Adjustable Stop .....                                   |
| 200098F | 12307 | Feed Regulating Handle Adjustable Stop Screw .....                             |
| 204925  | 12306 | Feed Regulating Handle Adjustable Stop Screw Washer .....                      |
| 204209  | 12307 | Feed Regulating Handle Position Pin .....                                      |
| 204210  | 12306 | Feed Regulating Handle Shaft ....  |
| 204211  | 12306 | " " " " Crank with 200098F .....   |
| 204212  | 12307 | Feed Regulating Handle Shaft Crank Link .....                                  |
| 200271E | 12311 | Feed Regulating Handle Shaft Crank Link Hinge Screw (lower)                    |
| 200291E | 12307 | Feed Regulating Handle Shaft Crank Link Hinge Screw (upper)                    |
| 200098F | 12307 | Feed Regulating Handle Shaft Crank Set Screw .....                             |
| 204213  | 12307 | Feed Regulating Handle Shaft Sleeve (split) .....                              |
| 200362C | 12311 | Feed Regulating Handle Shaft Sleeve Set Screw .....                            |
| 202622  | 12306 | Feed Regulating Handle Shaft Sleeve Washer .....                               |
| 202036  | 12310 | Feed Regulating Handle Stop Pin  |
| 204214  | —     | Feed Regulating Handle complete, Nos. 200291E, 204207, 204211 and 204212 ..... |
| 204302  | 12237 | Feed Wheel .....   |

| No.     | Plate | Name   |
|---------|-------|--|
| 223010  | 13046 | Feed Wheel Driver with 204189, 204311, two each 201209F and 201515E .....                        |
| 201209F | 13048 | Feed Wheel Driver Clutch Stud  |
| 201515E | 13048 | " " " " " " Nut .....  |
| 204308  | 12232 | Feed Wheel Driver Crank with two 200383c .....   |
| 200266D | 12232 | Feed Wheel Driver Crank Hinge Screw .....  |
| 200383c | 12311 | Feed Wheel Driver Crank Set Screw .....  |
| 204335  | 12232 | Feed Wheel Driver Guide .....  |
| 200162D | 12232 | " " " " Screw ...  |
| 204310  | 12232 | " " " Link .....   |
| 200263F | 12232 | " " " " Hinge Screw .....  |
| 201528E | 12232 | Feed Wheel Driver Link Hinge Screw Nut .....   |
| 204311  | 12232 | Feed Wheel Driver Position Pin ...   |
| 204312  | 12232 | " " " Spring (spiral)  |
| 204189  | 12306 | " " " " Hook (lower) .....   |
| 204190  | 12232 | Feed Wheel Driver Spring Hook (upper) .....  |
| 223011  | —     | Feed Wheel Driver and Clutch complete, Nos. 200263F, 200266D, 201528E, 204308, 204310 and 223310 |
| 204336  | 12237 | Feed Wheel Frame with 200383c, 204190 and 204321 .....   |
| 204315  | 12232 | Feed Wheel Frame Adjusting Eccentric .....   |
| 200347c | 12232 | Feed Wheel Frame Adjusting Eccentric Set Screw .....   |
| 200383c | 12311 | Feed Wheel Frame Set Screw ....  |
| 204337  | 12237 | " " " Shaft .....  |
| 202305  | 12307 | " " " " Center (2)   |
| 200043c | 12311 | " " " " " Set Screw (2) .....  |
| 204317  | 12232 | Feed Wheel Friction Spring .....   |
| 200162D | 12232 | " " " " Screw  |
| 213649  | 14514 | Feed Wheel Frame complete, Nos. 204302, 204317, 204320, 204335, 204336, 206047 and four 200162D  |
| 206047  | 12232 | Feed Wheel Retaining Clutch with 204189 .....  |
| 204320  | 12232 | Feed Wheel Retaining Clutch Spring .....   |
| 204189  | 12306 | Feed Wheel Retaining Clutch Spring Hook .....  |

| No.     | Plate | Name   |
|---------|-------|--|
| 204321  | 12232 | Feed Wheel Retaining Clutch Spring Pin .....                                       |
| 200162D | 12232 | Feed Wheel Retaining Screw ....  |
| 223012  | —     | Feed Wheel complete, Nos. 200347c, 204315, 204337, 204338, 213649 and 223011 ..... |
| *203482 | —     | Hook (sewing) .....  |
| 203483  | 12393 | " 203482 with 201253E, 201376F and 203251 .....                                    |
| 203503  | 12393 | Hook and Bobbin Case complete, Nos. 203483 and 203500 .....                        |
| 213810  | 12393 | Hook Bevel Gear Socket, 24 teeth   |
| 200555H | 13048 | " " " " Screw ...  |
| 203242  | 12305 | " " Pinion, 24 teeth, with two 200383c .....                                       |
| 200383c | 12311 | Hook Bevel Pinion Set Screw ....   |
| 203243  | 12299 | " Counter Shaft .....  |
| 203244  | 12308 | " " " Collar with two 200393c .....  |
| 200393c | 12308 | Hook Counter Shaft Collar Set Screw .....  |
| 203245  | —     | Hook Counter Shaft Driving Gear, 44 teeth, with 200362c and 200439c                |
| 200439c | 12311 | Hook Counter Shaft Driving Gear Position Screw .....                               |
| 200362c | 12311 | Hook Counter Shaft Driving Gear Set Screw .....                                    |
| 203246  | 12305 | Hook Counter Shaft Gear, 22 teeth, with two 200383c .....                          |
| 200383c | 12311 | Hook Counter Shaft Gear Set Screw  |
| 202299  | —     | " " " Oil Packing (wick) .....   |
| 200840E | 12311 | Hook Counter Shaft Oil Packing (wick) Stop Screw .....                             |
| 203247  | 12298 | Hook Driving Shaft .....   |
| 203248  | 12304 | " " " Bearing with 202299 .....  |
| 202299  | —     | Hook Driving Shaft Bearing Oil Packing (wick) .....                                |
| 202126  | 12308 | Hook Driving Shaft Bearing Position Pin .....                                      |
| 200516E | 12311 | Hook Driving Shaft Bearing Screw   |
| 203249  | 12305 | " " " Bushing (eccentric) .....  |
| 202299  | —     | Hook Driving Shaft Bushing Oil Packing (wick) .....                                |
| 200362c | 12311 | Hook Driving Shaft Bushing Set Screw .....   |
| 213141  | 13045 | Hook Driving Shaft Collar with two 200393c .....                                   |

| No.                 | Plate | Name  |
|---------------------|-------|---|
| 200393c             | 12308 | Hook Driving Shaft Collar Set<br>Screw .....  |
| 203 <sup>a</sup> 51 | 12393 | Hook Gib .....  |
| 201376F             | 13045 | " " Hinge Screw .....   |
| 201253F             | 13045 | " " Screw .....   |
| 203504              | 12394 | " Saddle with 200056D .....   |
| 200006E             | 12307 | " " Screw (2) .....   |
| 202622              | 12306 | " " " Washer (2) .....  |
| 213018              | —     | " Washer .....  |
| 203507              | 12393 | " " 213018 with 203476 and<br>two 204243 .....  |
| 203505              | 12394 | Hook Saddle complete, Nos.<br>200555H, 203478, 203499, 203503,<br>203504, 203506, 203507 and 213810 |
| 202445              | 11125 | Knee Lifter Connection Lever with<br>202446 .....   |
| 227311              | —     | Knee Lifter Connection Lever 202445<br>with 200224H, 200262H, 227302 and<br>227308 .....            |
| 200224H             | 12306 | Knee Lifter Connection Lever<br>Hinge Screw .....   |
| 227308              | 11125 | Knee Lifter Connection Lever<br>Lifting Rod with 202302 .....                                       |
| 202302              | 12306 | Knee Lifter Connection Lever<br>Lifting Rod Cotter Pin .....  |
| 202446              | 12306 | Knee Lifter Connection Lever Pin  |
| 227302              | 11125 | " " Lifting Lever .....   |
| 200262H             | 12306 | " " " " Hinge<br>Screw .....  |
| 208613              | 13046 | Needle Bar (hollow) .....   |
| 204247              | 12304 | " " 208613 with 200125F,<br>200175D and 204250 .....  |
| 204248              | 12307 | Needle Bar Connecting Link .....  |
| 200658c             | 12307 | " " " " Hinge<br>Screw Stud .....   |
| 201519c             | 12307 | Needle Bar Connecting Link Hinge<br>Screw Stud Nut .....  |
| 204249              | 12308 | Needle Bar Connecting Stud with<br>200072c and 202277 .....   |
| 202277              | —     | Needle Bar Connecting Stud Oil<br>Packing (wick) .....  |
| 200072c             | 12308 | Needle Bar Connecting Stud Pinch<br>Screw .....   |
| 204326              | —     | Needle Bar Packing Cord (2) ....  |
| 200504E             | 12310 | " " Screw Bushing (lower)   |
| 200503B             | 12310 | " " " " (upper)   |
| 204250              | 12308 | " " Thread Guide .....  |
| 200175D             | 12308 | " " " " Screw ...   |
| 200125F             | 12308 | " Set Screw .....   |

| No.     | Plate | Name   |
|---------|-------|--|
| 204252  | 12308 | Presser Bar Lifter .....   |
| 200550c | 12311 | " " " Hinge Screw ....   |
| 204253  | 12308 | " " Lifting Bracket with<br>200086c .....  |
| 200086c | 12308 | Presser Bar Lifting Bracket Pinch<br>Screw .....   |
| 204254  | 12307 | Presser Bar Lifting Bracket Posi-<br>tion Guide .....  |
| 200362c | 12311 | Presser Bar Lifting Bracket Posi-<br>tion Guide Set Screw .....  |
| 204327  | 12306 | Presser Bar Packing Washer (felt)  |
| 200504E | 12310 | " " Screw Bushing (lower)  |
| 204258  | 13045 | " " Spring .....   |
| 200491B | 12305 | " " Thumb Screw (pres-<br>sure regulating) .....   |
| 201910  | 10169 | Roller Presser, $\frac{1}{8}$ in. diam., $\frac{1}{8}$ in.<br>face (coarse), with 200551F and<br>201534H ..... |
| 204328  | —     | Roller Presser Arm .....   |
| 204570  | 12225 | " " " 204328 with<br>201910 .....  |
| 202560  | 12225 | Roller Presser Arm Bracket<br>(swing) .....  |
| 204575  | —     | Roller Presser Arm Bracket 202560<br>with 200096D and 204570 .....   |
| 200675  | 12225 | Roller Presser Arm Bracket Posi-<br>tion Screw Stud .....  |
| 202558  | 12225 | Roller Presser Arm Bracket Spring  |
| 202559  | 12225 | " " " " " "  |
|         |       | Stop .....   |
| 200141F | 12225 | Roller Presser Arm Bracket Spring<br>Stop Screw .....  |
| 200096D | 12225 | Roller Presser Arm Screw .....   |
| 204495  | 12225 | " " Bar .....  |
| 200551F | 12225 | " " Hinge Screw .....  |
| 201534H | 12225 | " " " " Nut .....  |
| 204576  | —     | Roller Presser and Bar complete,<br>Nos. 200675c, 202558, 202559,<br>204495, 204575 and two 200141F            |
| 202068  | 12315 | Spool Holder Base .....  |
| 200575H | 12311 | " " " Screw .....  |
| 204296  | 12315 | " " Wire .....   |
| 200079H | 12311 | " " " Hinge Screw ....   |
| 204297  | 12315 | Spool Holder complete, Nos.<br>200079H, 202068 and 204296 .....  |
| 213006  | 13045 | Take-up Cam with 200335c, 200383c,<br>200430c, 200658c and 201519c ....  |
| 203172  | 12307 | Take-up Cam Friction Washer ....   |
| 200430c | 12311 | " " Position Screw .....   |

| No.     | Plate | Name   |
|---------|-------|--|
| 200383c | 12311 | Take-up Cam Position Screw Check Screw .....   |
| 200335c | 12311 | Take-up Cam Set Screw .....  |
| 203270  | 12310 | " Lever .....  |
| 203291  | —     | " " 203270 with 204263 ...   |
| 204263  | 12310 | " " Bearing with 204264 ..   |
| 204264  | 12306 | " " " Position Pin ...   |
| 200042F | 12311 | " " " Screw .....  |
| 201816  | 12307 | " " Roller .....   |
| 203271  | 12310 | Take-up Lever complete, Nos. 200042F, 201816 and 203291 .....                        |
| 202402  | 12309 | Tension Disc .....   |
| 202090  | 12309 | " " Position Pin .....   |
| 204267  | 12310 | " Release Lever .....  |
| 200688c | 13048 | " " " Position Screw .....   |
| 200309E | 12309 | " " " Screw .....  |
| 202075  | 12309 | " " Plunger .....  |
| 215609  | —     | " " Slide .....  |
| 204268  | 12310 | " " 215609 with 204269 .....   |
| 204269  | 12308 | Tension Release Slide Spring .....   |
| 202407  | 12309 | " Spring .....   |
| 200632B | 12309 | " Stud .....   |
| 200397H | 12309 | " " Set Screw .....  |
| 201572B | 12309 | " Thumb Nut .....  |
| 204271  | 12309 | " Washer .....   |
| 204272  | 12309 | Tension complete, Nos. 200632B, 201572B, 202075, 202407, 204271 and two 202402 ..... |
| 204273  | 12308 | Thread Controller Adjusting Collar with 200684H (for Presser Bar)                    |
| 200684H | 12308 | Thread Controller Adjusting Collar Screw .....                                       |
| 204274  | 12309 | Thread Controller Plate .....  |
| 200577H | 12311 | " " " Screw ...  |
| 202098  | 12309 | " " Roller .....   |
| 204275  | 12309 | " " " Guard .....  |
| 202084  | 12309 | " " " " Washer .....   |
| 200300c | 12309 | " " " Screw .....  |
| 204276  | 12309 | " " Spring .....   |
| 204333  | 12309 | " " " Guard .....  |
| 200581H | 12309 | " " " " Screw .....  |
| 204277  | 12309 | " " " Stop .....   |
| 204278  | 12309 | " " " " Driving Gear .....   |
| 200319c | 12309 | Thread Controller Spring Stop Driving Gear Hinge Screw .....                         |
| 200135c | 12309 | Thread Controller Spring Stop Screw .....  |

| No.     | Plate | Name   |
|---------|-------|--|
| 204279  | 12309 | Thread Controller Spring Stud with 204925 .....  |
| 200355H | 12319 | Thread Controller Spring Stud Set Screw .....  |
| 204925  | 12306 | Thread Controller Spring Stud Washer .....   |
| 205987  | 12309 | Thread Controller complete, Nos. 200300c, 200581H, 202084, 202098, 204274, 204275 and 204333 ..... |
| 204280  | 12309 | Thread Controller and Spring complete, Nos. 204276 and 205987 .....                                |
| 202413  | 12310 | Thread Guide .....   |
| 204329  | —     | " Oiler (felt) .....   |
| 204330  | 12225 | " " Bracket with 204329 ...  |
| 200113F | 12308 | " " " Screw .....  |
| 204281  | 12309 | " Retainer Guide Wire .....  |
| 202091  | 12309 | " " Sleeve .....   |
| 202092  | 12309 | " " Spring .....   |
| 204058  | 12309 | " " Stud .....   |
| 200368H | 12309 | " " " Set Screw .....  |
| 204059  | 12309 | Thread Retainer complete, Nos. 202091, 202092 and 204058 .....                                     |
| 211335  | 13047 | Throat Plate, 50 needle hole, for needle sizes 14 and 15 .....                                     |
| 202062  | 12308 | Throat Plate Position Pin .....  |
| 200577H | 12311 | " " Screw (2) .....  |

## MACHINE No. 21w162

WHEEL FEED, ROLLER PRESSER

For Shoes and Gloves

The same as Machine No. 21w52 with the following exceptions:

| No.     | Plate | Name   |
|---------|-------|--|
| *204290 | —     | Arm with 200439c, 202036 and 204705, in place of 204161 .....  |
| 213622  | 12298 | Arm Shaft, in place of 203202 .....  |
| *213623 | —     | Bed with 202062, 203248, 203249, two each 200362c, 200516E, 200840E and 202299, in place of 203205 ... |
| 204294  | 12298 | Feed Driving Rock Shaft, in place of 204199 .....  |
| 206555  | —     | Feed Driving Rock Shaft 204294 with 200002E, 201522E and 204193, in place of 206554 .....              |
| 213624  | 12298 | Hook Driving Shaft, in place of 203247 .....   |
| 227312  | —     | Knee Lifter Connection Lever 202445 with 200224H, 200262H, 227303 and 227308, in place of 227311 ..... |
| 227303  | 11125 | Knee Lifter Lifting Lever, in place of 227302 .....  |

## ACCESSORIES

FOR MACHINE No. 21w52

| No.     | Plate | Name  |
|---------|-------|---|
| 200157B | 10348 | Attachment Screw .....  |
| 203470  | 12393 | Bobbin (5) .....  |
| *225482 | —     | “ Case Screw Driver Blade ...                                   |
| *225483 | —     | “ “ “ “ Handle ..   |
| 225497  | 13046 | Bobbin Case Screw Driver complete, Nos. 225482 and 225483 ...   |
| 225487  | 13048 | Roller Presser Hinge Screw Nut Wrench .....                     |
| 128 x 2 | —     | Needles, two each, sizes 11, 12 and 13 .....                    |
| 225191  | —     | Drip Pan with four wood screws ½ in., No. 5 .....               |
| 41400   | 12315 | Machine Rest Pin (wood) .....                                   |
| 36578   | 12315 | Oiler with 36579 .....  |
| 36579   | 12315 | “ Spout, 3½ in. long, with 120117                               |
| 120117  | —     | “ “ Washer .....  |
| *225484 | —     | Screw Driver Blade .....  |
| *225485 | —     | “ “ Handle .....  |
| 225498  | 12315 | Screw Driver complete (7¼ in. long), Nos. 225484 and 225485 ... |
| 225554  | 12315 | Wrench (steel) .....  |

### BOBBIN WINDER

Swing Automatic, Right Hand

|         |       |  |
|---------|-------|--|
| 202470  | 12320 | Bobbin Winder Base .....                               |
| 202471  | 12320 | “ “ Frame .....  |
| 200221D | 12319 | “ “ “ Hinge Screw ...                                  |
| 202472  | 12319 | “ “ “ Spring .....                                     |
| 200161D | 12319 | “ “ “ “ Screw ...                                      |
| 202473  | 12320 | “ “ Pulley with 200105c..                              |
| 200105c | —     | “ “ “ Set Screw ....                                   |
| 202474  | 12320 | “ “ Spindle .....                                      |
| 227522  | 12319 | “ “ Stop Latch .....                                   |
| 200056E | 12319 | “ “ “ “ Screw ...                                      |
| 202477  | 12319 | “ “ “ “ Thumb Lever .....                              |
| 200299H | 12319 | Bobbin Winder Stop Latch Thumb Lever Hinge Screw ..... |
| 200299H | 12319 | Bobbin Winder Stop Latch Thumb Lever Joint Screw ..... |



| No.     | Plate | Name  |
|---------|-------|---|
| 201537H | 12319 | Bobbin Winder Stop Latch Thumb Lever Joint Screw Nut .....  |
| 202478  | 12319 | Bobbin Winder Stop Latch Trip Lever .....   |
| 200299H | 12319 | Bobbin Winder Stop Latch Trip Lever Hinge Screw .....   |
| 227523  | 12320 | Bobbin Winder complete, Nos. 200056E, 200161D, 200221D, 201537H, 202470 to 202474, 202477, 202478, 227522, three 200299H and two round head wood screws 1 in., No. 13 ..... |
| 202480  | 12320 | Bobbin Winder Spool Holder Base with 200355H and 202484 .....   |
| 202481  | 12320 | Bobbin Winder Spool Holder Base Spool Pin .....   |
| 202482  | 12319 | Bobbin Winder Spool Holder Tension Disc (lower or upper) ....   |
| 200011E | 12319 | Bobbin Winder Spool Holder Tension Disc Screw .....   |
| 200355H | 12319 | Bobbin Winder Spool Holder Tension Disc Screw Set Screw .....   |
| 202483  | 12319 | Bobbin Winder Spool Holder Tension Disc Spring (brass) .....  |
| 202484  | 12319 | Bobbin Winder Spool Holder Tension Disc Thread Guide .....  |
| 202485  | 12320 | Bobbin Winder Spool Holder complete, Nos. 200011E, 202480, 202481, 202483, two 202482 and one wood screw 1 in., No. 13 ....   |
| 227524  | —     | Bobbin Winder and Spool Holder complete, Nos. 202485 and 227523   |

## KNEE LIFTER

|         |       |   |
|---------|-------|---|
| 227781  | 11125 | Knee Lifter Rock Lever with 200522c and 200529c .....         |
| 227782  | —     | Knee Lifter Rock Lever 227781 with two each 202451 and 202452 |
| 227783  | 11125 | Knee Lifter Rock Lever 227782 with 202985 and 227784 .....    |
| 202453  | 11125 | Knee Lifter Rock Lever Knee Plate with 200526c .....          |
| 202985  | —     | Knee Lifter Rock Lever Knee Plate 202453 with 202455 .....    |
| 202455  | 11125 | Knee Lifter Rock Lever Knee Plate Arm (short) .....           |
| 200522c | 12319 | Knee Lifter Rock Lever Knee Plate Arm Set Screw .....         |

| No.     | Plate | Name   |
|---------|-------|--|
| 200526c | 12319 | Knee Lifter Rock Lever Knee Plate Set Screw .....                          |
| 202451  | 11125 | Knee Lifter Rock Lever Lug with two wood screws $\frac{3}{4}$ in., No. 13H |
| 202452  | 12319 | Knee Lifter Rock Lever Lug Hinge Pin .....                                 |
| 227784  | 11125 | Knee Lifter Rock Lever Rod, 3 in. long, with 227785 .....                  |
| *227785 | —     | Knee Lifter Rock Lever Rod Cap or Oil Guard .....                          |
| 200529c | 12319 | Knee Lifter Rock Lever Rod Set Screw .....                                 |

(Other Knee Lifter parts are listed with parts of machine head).

## FOR MACHINE No. 21w162

Same as for No. 21w52 with the following exceptions:

|        |   |  |
|--------|---|--|
| 225181 | — | Drip Pan with four wood screws $\frac{1}{2}$ in., No. 5, in place of 225191 .... |
|--------|---|--|

## KNEE LIFTER

|         |       |  |
|---------|-------|--|
| 227781  | 11125 | Knee Lifter Rock Lever with 200522c and 200529c .....                          |
| 227782  | —     | Knee Lifter Rock Lever 227781 with two each 202451 and 202452 ....             |
| 227787  | —     | Knee Lifter Rock Lever 227782 with 202203 and 227784, in place of 227783 ..... |
| 202453  | 11125 | Knee Lifter Rock Lever Knee Plate with 200526c .....                           |
| 202203  | —     | Knee Lifter Rock Lever Knee Plate 202453 with 202454 .....                     |
| 202454  | 11125 | Knee Lifter Rock Lever Knee Plate Arm (long) .....                             |
| 200522c | 12319 | Knee Lifter Rock Lever Knee Plate Arm Set Screw .....                          |
| 200526c | 12319 | Knee Lifter Rock Lever Knee Plate Set Screw .....                              |
| 202451  | 11125 | Knee Lifter Rock Lever Lug with two wood screws $\frac{3}{4}$ in., No. 13H...  |
| 202452  | 12319 | Knee Lifter Rock Lever Lug Hinge Pin .....                                     |
| 227784  | 11125 | Knee Lifter Rock Lever Rod, 3 in. long, with 227785 .....                      |

| No.     | Plate | Name  |
|---------|-------|---|
| *227785 | —     | Knee Lifter Rock Lever Rod Cap or Oil Guard ..... |
| 200529c | 12319 | Knee Lifter Rock Lever Rod Set Screw .....        |

(Other Knee Lifter parts are listed with parts of machine head).

## PRESSER FEET

|        |       |   |
|--------|-------|---|
| 202616 | 13047 | Presser Foot, for shoe lining, used in place of Roller Presser .....              |
| 202803 | 13047 | Presser Foot, used in place of Roller Presser .....                               |
| 229088 | 13047 | Presser Foot, for beading or top stitching, used in place of Roller Presser ..... |
| 229089 | 13047 | Presser Foot (auxiliary), used in place of Roller Presser .....                   |

## ROLLER PRESSERS

| No.    | Plate | Name  |
|--------|-------|---|
| 201900 | 10169 | Roller Presser, 1 $\frac{3}{4}$ in. diam., $\frac{1}{8}$ in. face (fine), with 200551F and 201534H .....  |
| 201901 | 10169 | Roller Presser, 1 $\frac{3}{4}$ in. diam., $\frac{3}{32}$ in. face (fine), with 200551F and 201534H ..... |
| 201902 | 10169 | Roller Presser, 1 $\frac{1}{2}$ in. diam., $\frac{1}{8}$ in. face (fine), with 200548F and 201534H .....  |
| 201903 | 10169 | Roller Presser, 1 $\frac{1}{2}$ in. diam., $\frac{3}{32}$ in. face (fine), with 200548F and 201534H ..... |
| 201904 | 10169 | Roller Presser, 1 $\frac{1}{4}$ in. diam., $\frac{5}{16}$ in. face (fine), with 200548F and 201534H ..... |
| 201905 | 10169 | Roller Presser, 1 $\frac{1}{4}$ in. diam., $\frac{1}{4}$ in. face (fine), with 200548F and 201534H .....  |
| 201906 | 10169 | Roller Presser, 1 $\frac{1}{4}$ in. diam., $\frac{3}{16}$ in. face (fine), with 200548F and 201534H ..... |
| 201907 | 10169 | Roller Presser, 1 $\frac{1}{4}$ in. diam., $\frac{5}{32}$ in. face (fine), with 200548F and 201534H ..... |
| 201908 | 10169 | Roller Presser, 1 $\frac{1}{4}$ in. diam., $\frac{1}{8}$ in. face (fine), with 200548F and 201534H .....  |
| 201909 | 10169 | Roller Presser, $\frac{1}{2}$ in. diam., $\frac{3}{16}$ in. face (coarse), with 200551F and 201534H ..... |
| 201910 | 10169 | Roller Presser, $\frac{1}{2}$ in. diam., $\frac{1}{8}$ in. face (coarse), with 200551F and 201534H .....  |
| 201911 | 10169 | Roller Presser, 1 in. diam., $\frac{1}{8}$ in. face (coarse), with 200551F and 201534H .....              |
| 201912 | 10170 | Roller Presser, 1 $\frac{1}{4}$ in. diam., $\frac{3}{32}$ in. face (fine), with 200548F and 201534H ..... |
| 201913 | 10170 | Roller Presser, 1 $\frac{1}{4}$ in. diam., $\frac{1}{16}$ in. face (fine), with 200548F and 201534H ..... |
| 201914 | 10170 | Roller Presser, $\frac{3}{8}$ in. diam., $\frac{1}{8}$ in. face (coarse), with 200551F and 201534H .....  |



### THROAT PLATES

| No.                                      | Plate | Name   |
|--|-------|--|
| 211334                                   | 13047 | Throat Plate, 53 needle hole, for needle sizes 12 and 13, for 204302                 |
| 211335                                   | 13047 | Throat Plate, 50 needle hole, for needle sizes 14 and 15, for 204302                 |
| Nos. 211336 to 211338 are for glove work |       |  |
| 211336                                   | 12038 | Throat Plate, 56 elongated needle hole, for needle sizes 12 and 13, for 204302 ..... |
| 211337                                   | 12038 | Throat Plate, 53 elongated needle hole, for needle sizes 14 and 15, for 204302 ..... |
| 211338                                   | 12038 | Throat Plate, 50 elongated needle hole, for needle sizes 16 and 18, for 204302 ..... |
| 215905                                   | 13047 | Throat Plate, 46 needle hole, for needle sizes 16 and 18, for 204302                 |

### OBSOLETE PARTS

|         |       |  |
|---------|-------|--|
| *213604 | —     | Feed Driving Cam Fork Lever Slide Block with 200116c .....   |
| *213605 | —     | Feed Driving Cam Fork Lever Slide Block .....  |
| 213606  | 13048 | Feed Driving Cam Fork Lever Slide Block 213604 with 213605..   |
| 213650  | 14514 | Feed Wheel complete, Nos. 200347c, 204313, 204315, 204337, 204338 and 213649 .....                             |
| 204306  | 12237 | Feed Wheel Driver with 204189, 204307 and 204311 .....   |
| 204307  | —     | Feed Wheel Driver Clutch .....   |
| 204313  | 14514 | Feed Wheel Driver and Clutch complete, Nos. 200263F, 200266D, 201528F, 204306, 204308, 204310 and 204312 ..... |

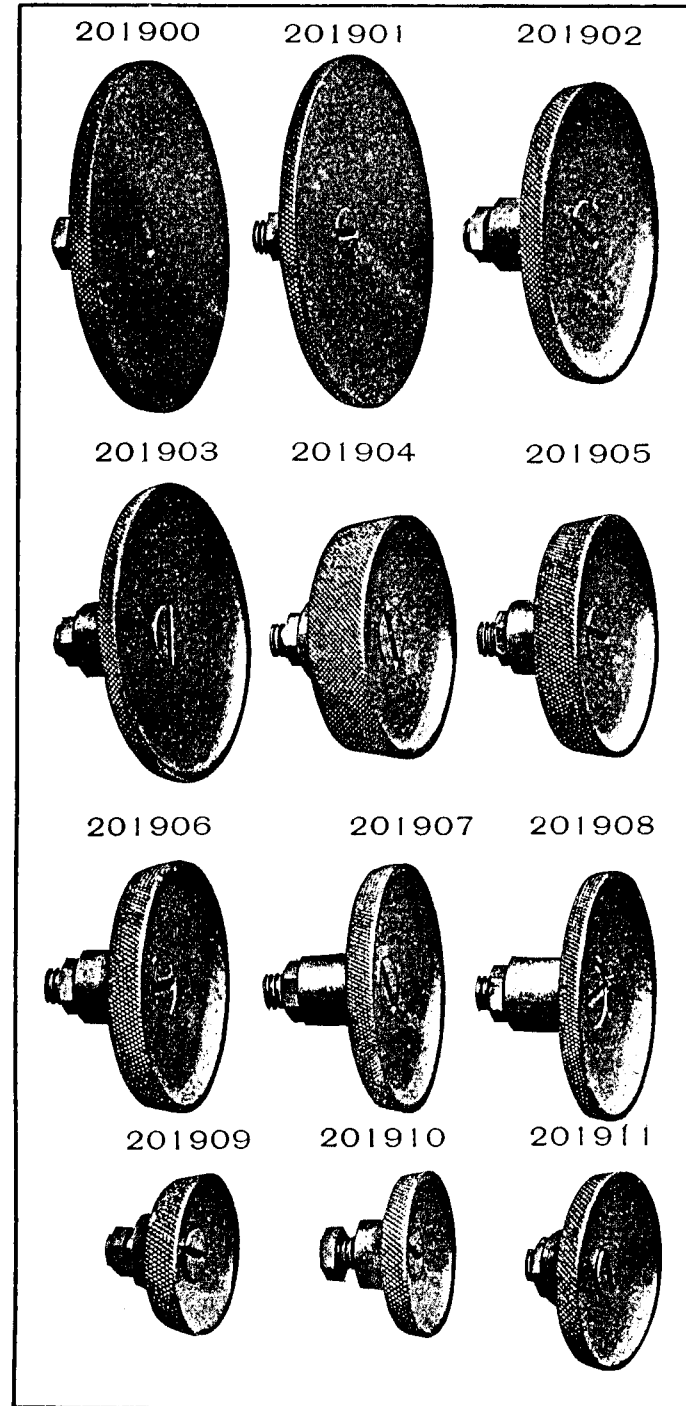
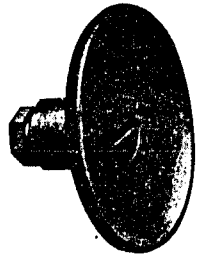
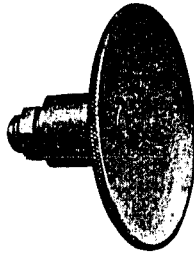


PLATE 10170—FULL SIZE

201912



201913



201914



201915



201916



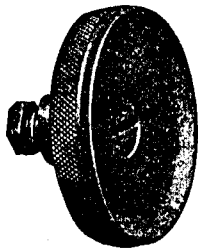
201917



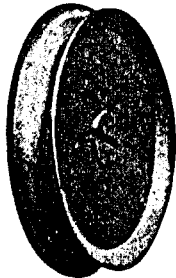
201918



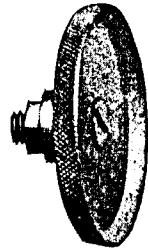
201919



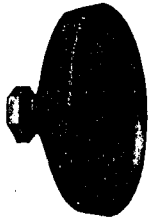
201920



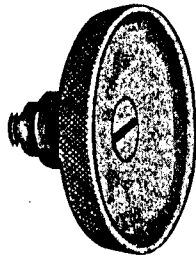
201921



201922



201923



201924

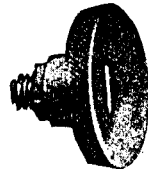
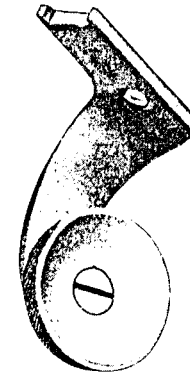


PLATE 10492—FULL SIZE

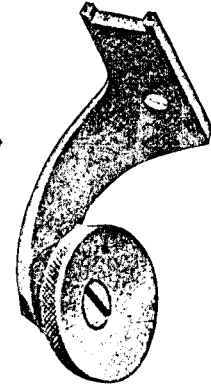
204578



204580



204582



204584



204586



204588

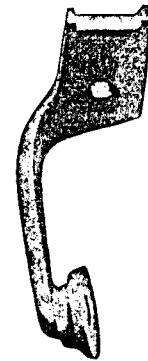


PLATE 11125 - ONE-FOURTH SIZE

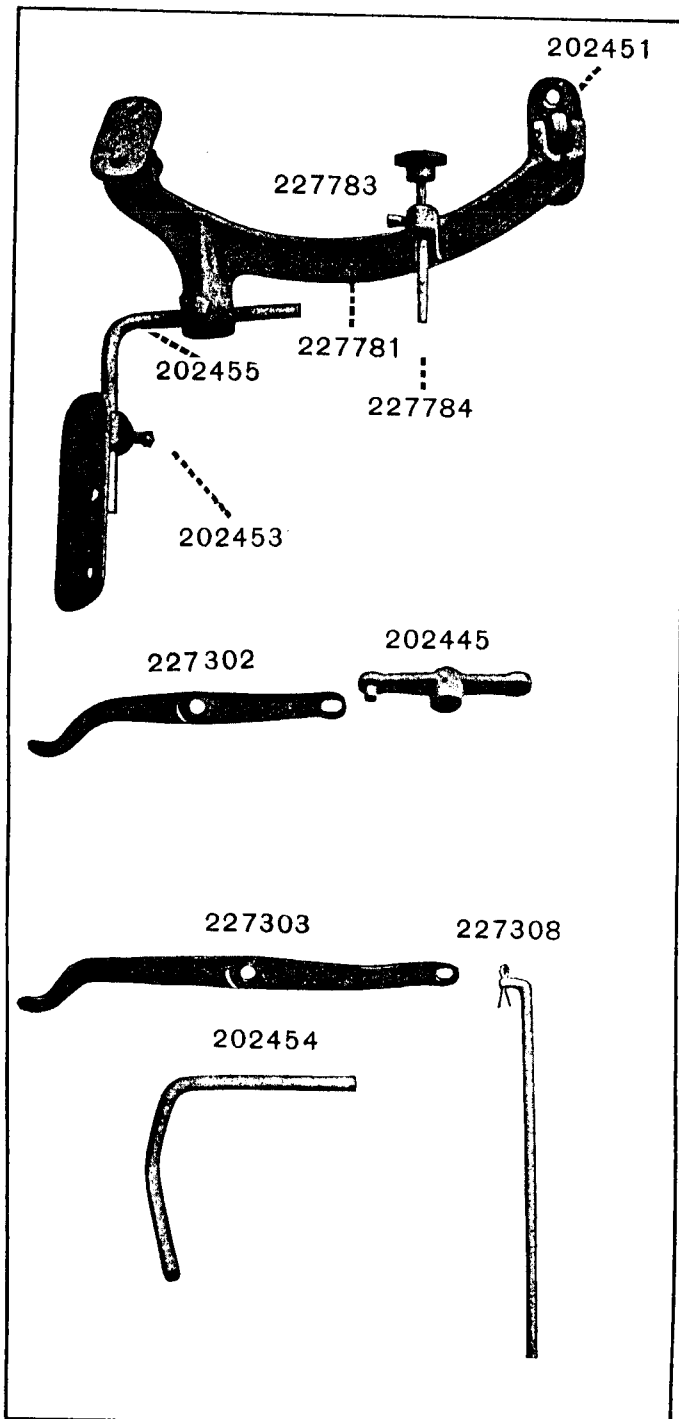


PLATE 12038 - FULL SIZE

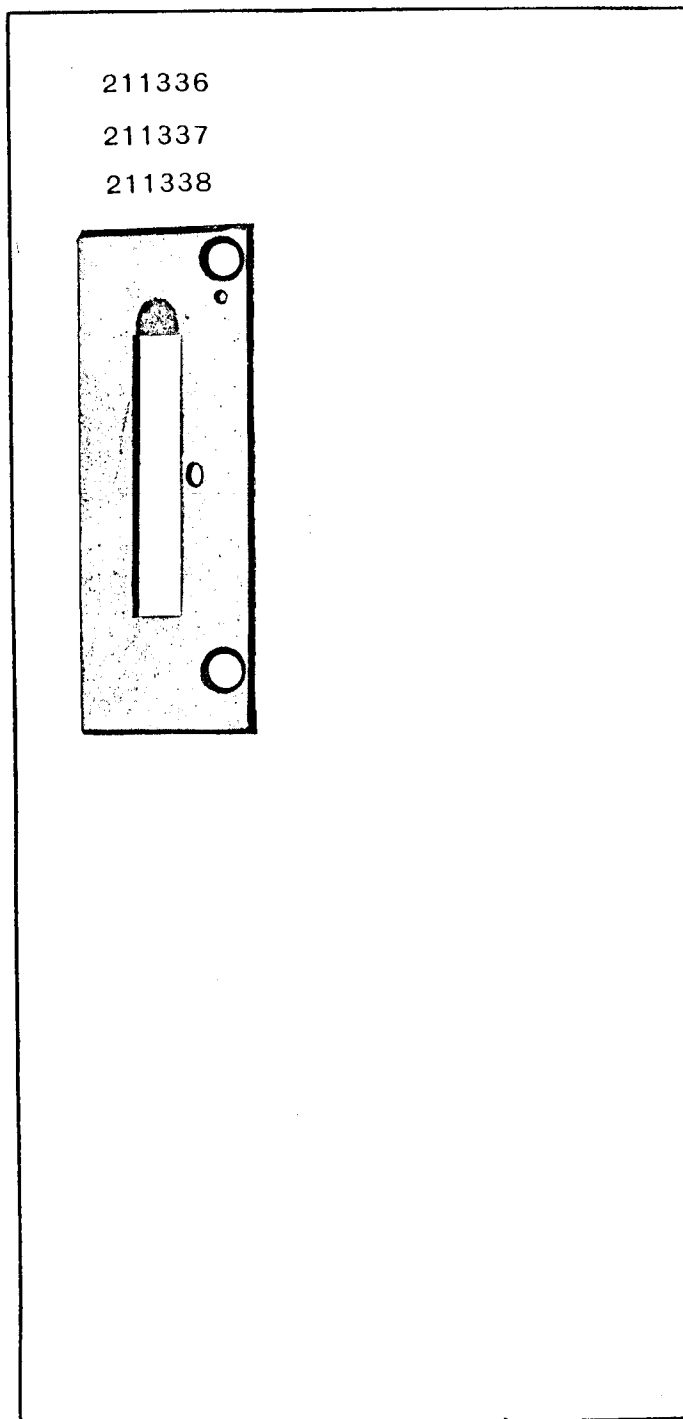


PLATE 12225—FULL SIZE

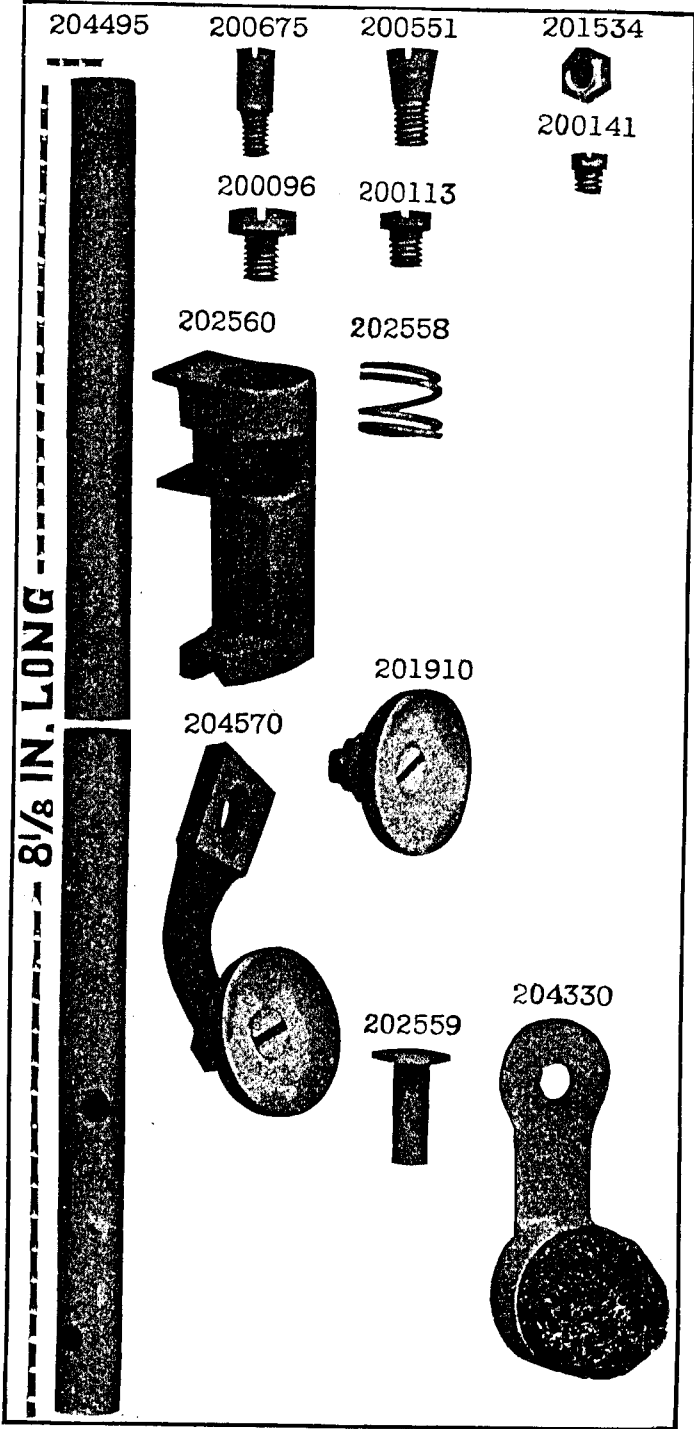


PLATE 12232—FULL SIZE

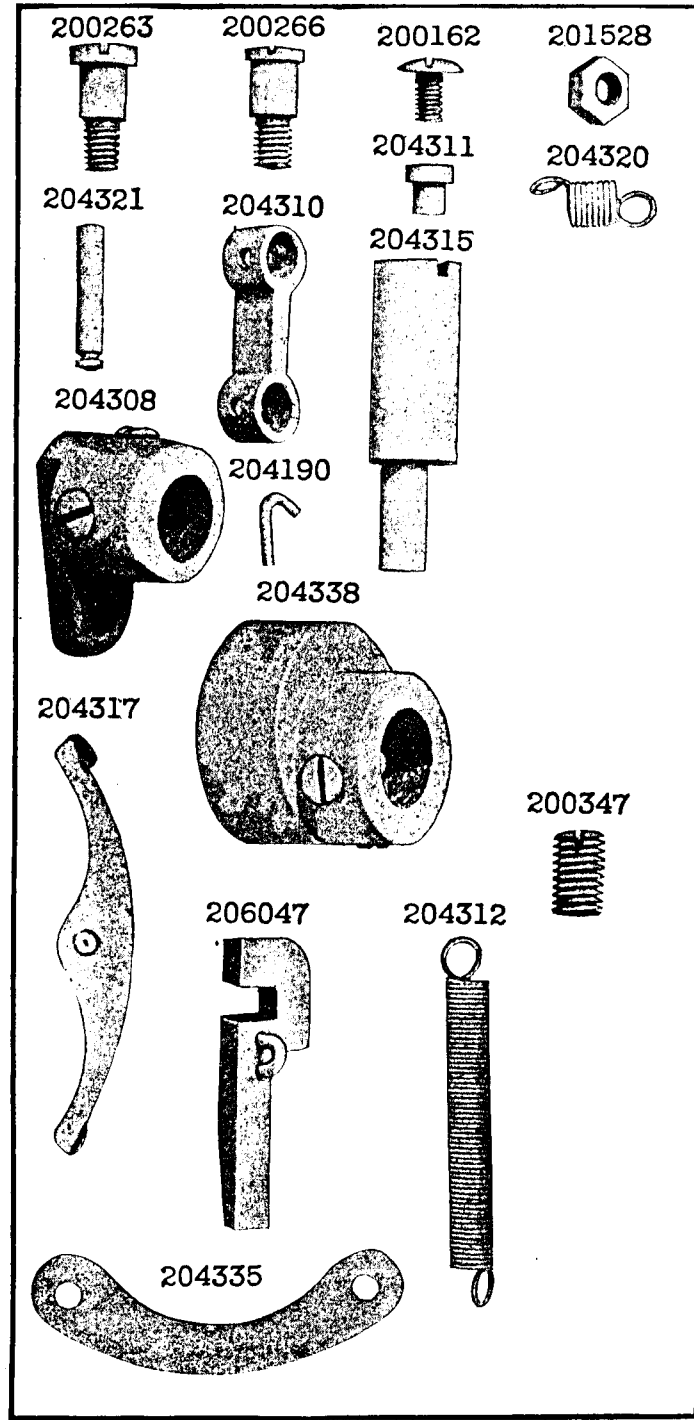


PLATE 12237—ONE-HALF SIZE

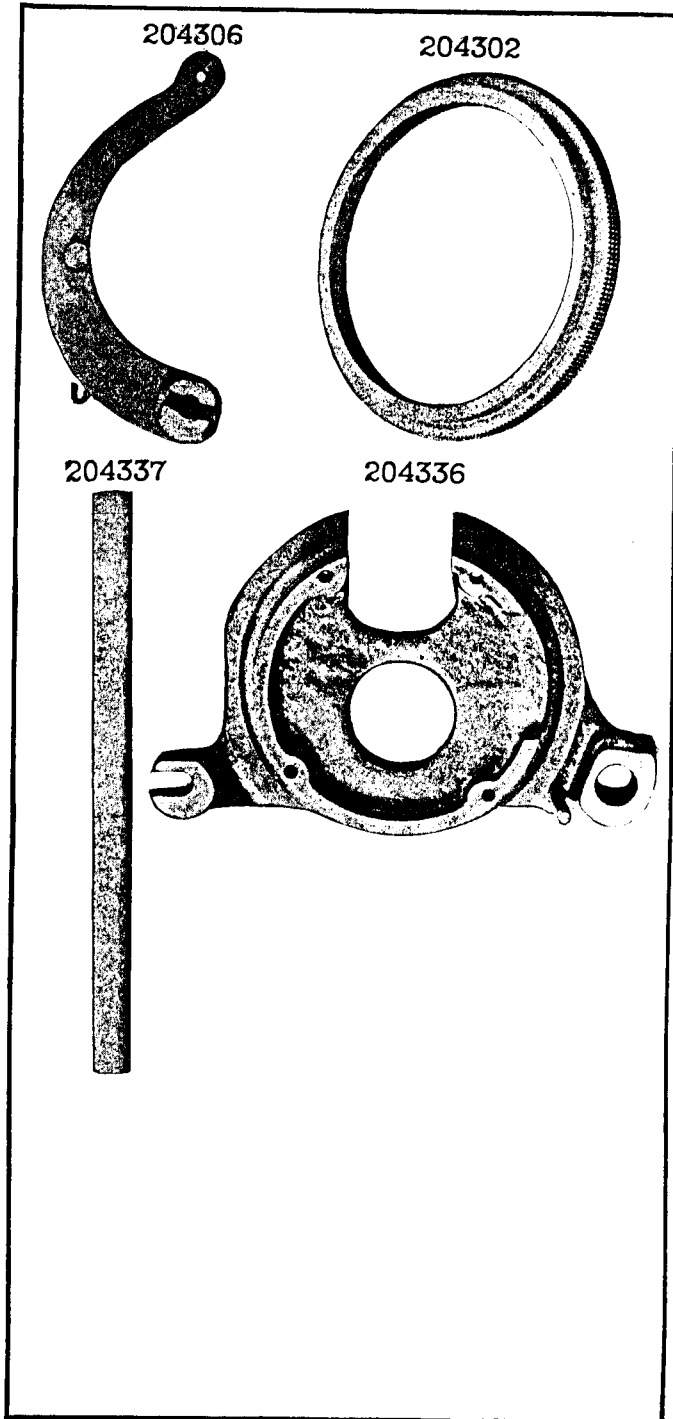


PLATE 12298—ONE-FOURTH SIZE

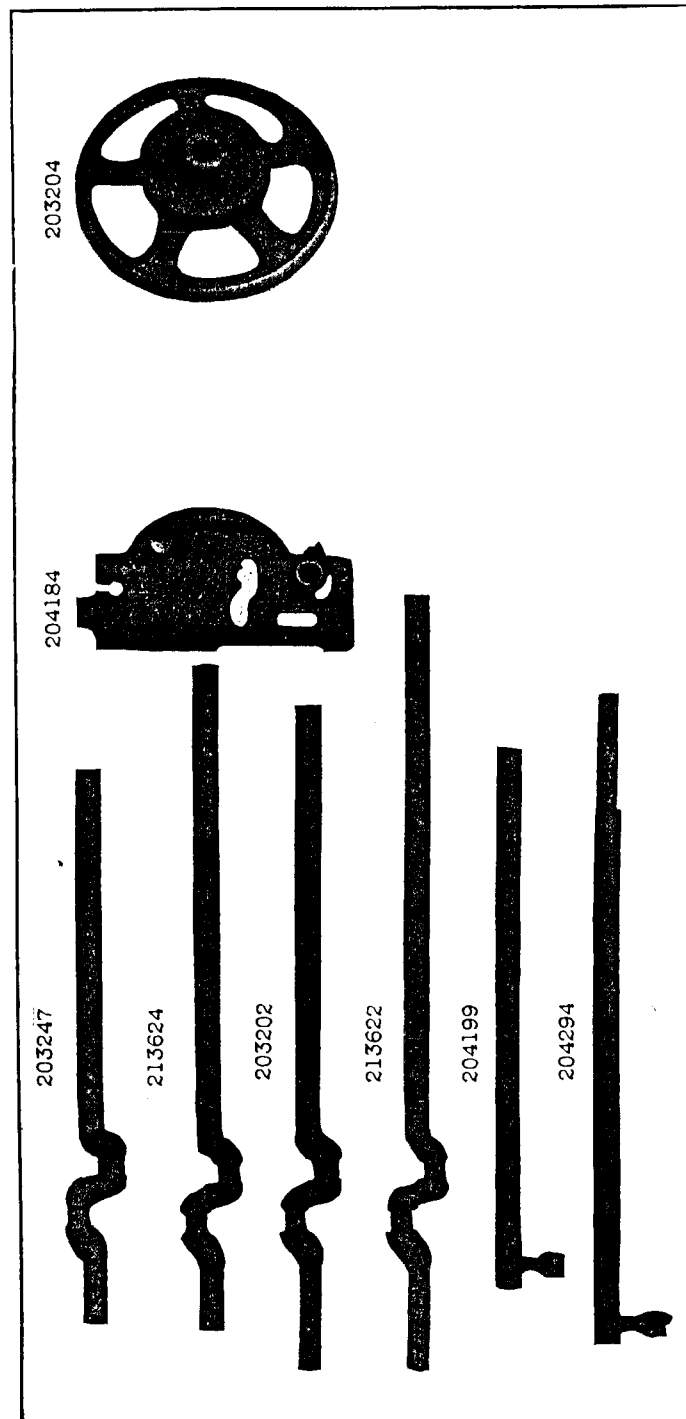




PLATE 12299—ONE-HALF SIZE

204193



203243 204440



203207



PLATE 12304—ONE-HALF SIZE

204247



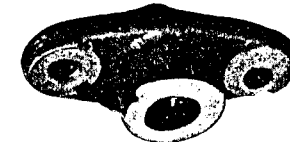
204705



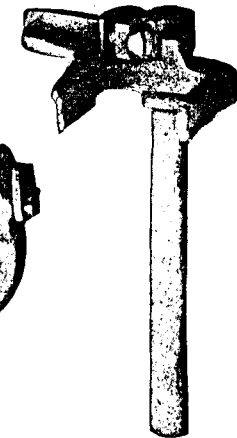
203268



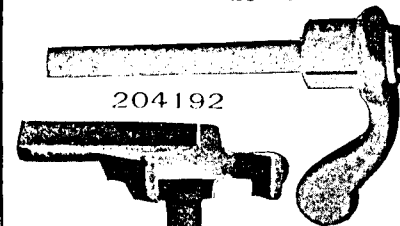
203248



204198



204207



204192

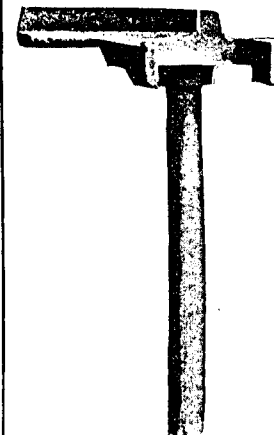


PLATE 12305—FULL SIZE

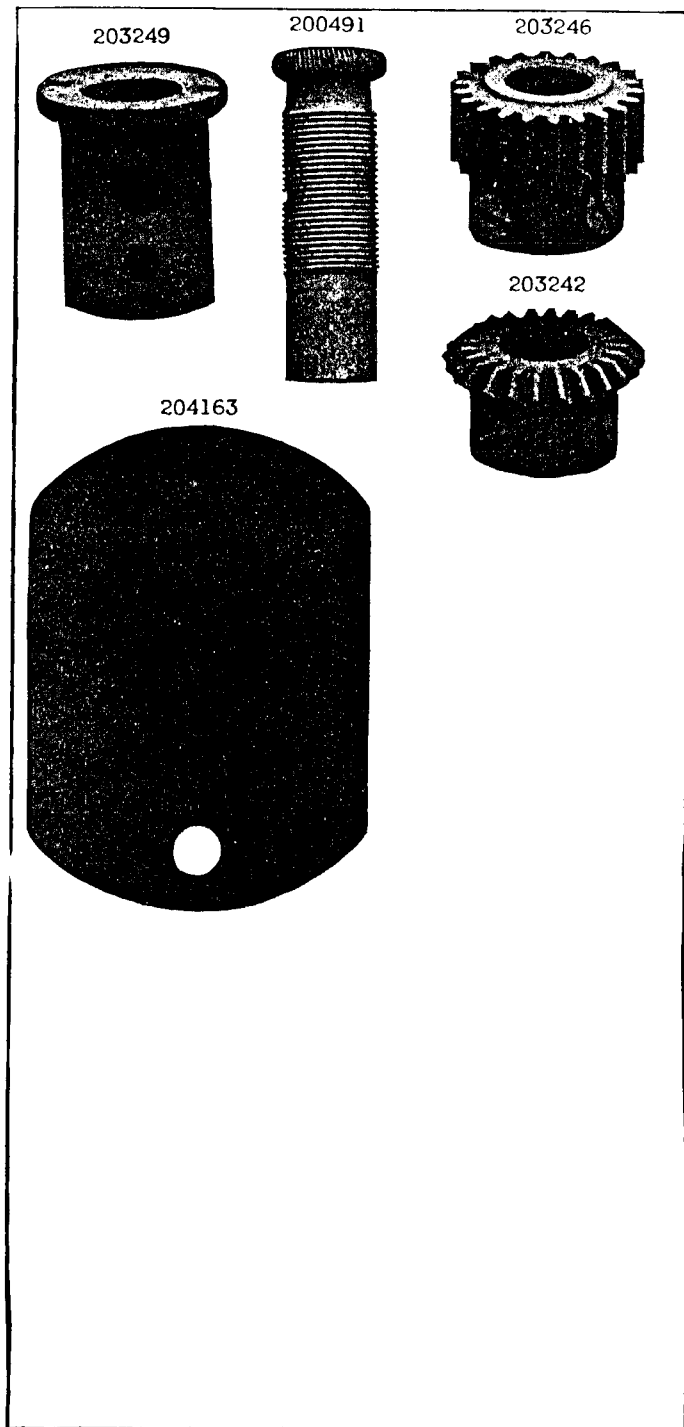


PLATE 12306—FULL SIZE

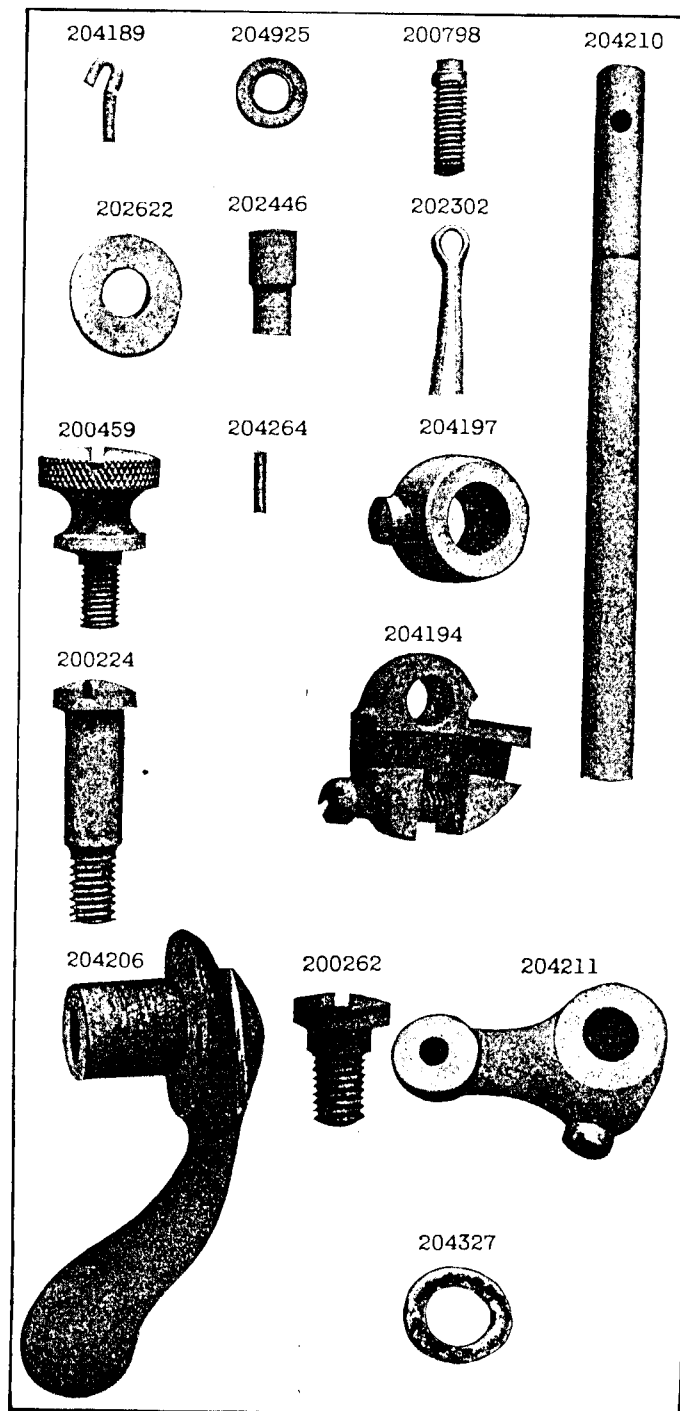


PLATE 12307—FULL SIZE

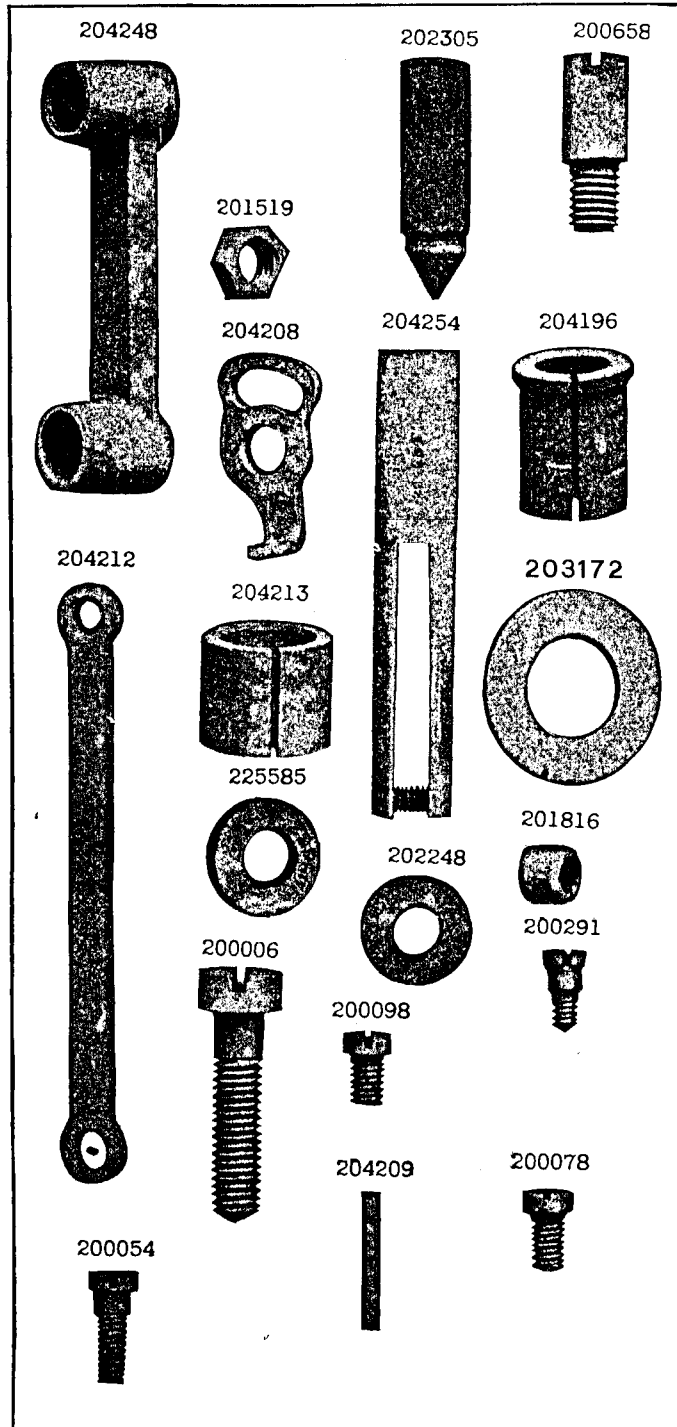


PLATE 12308—FULL SIZE

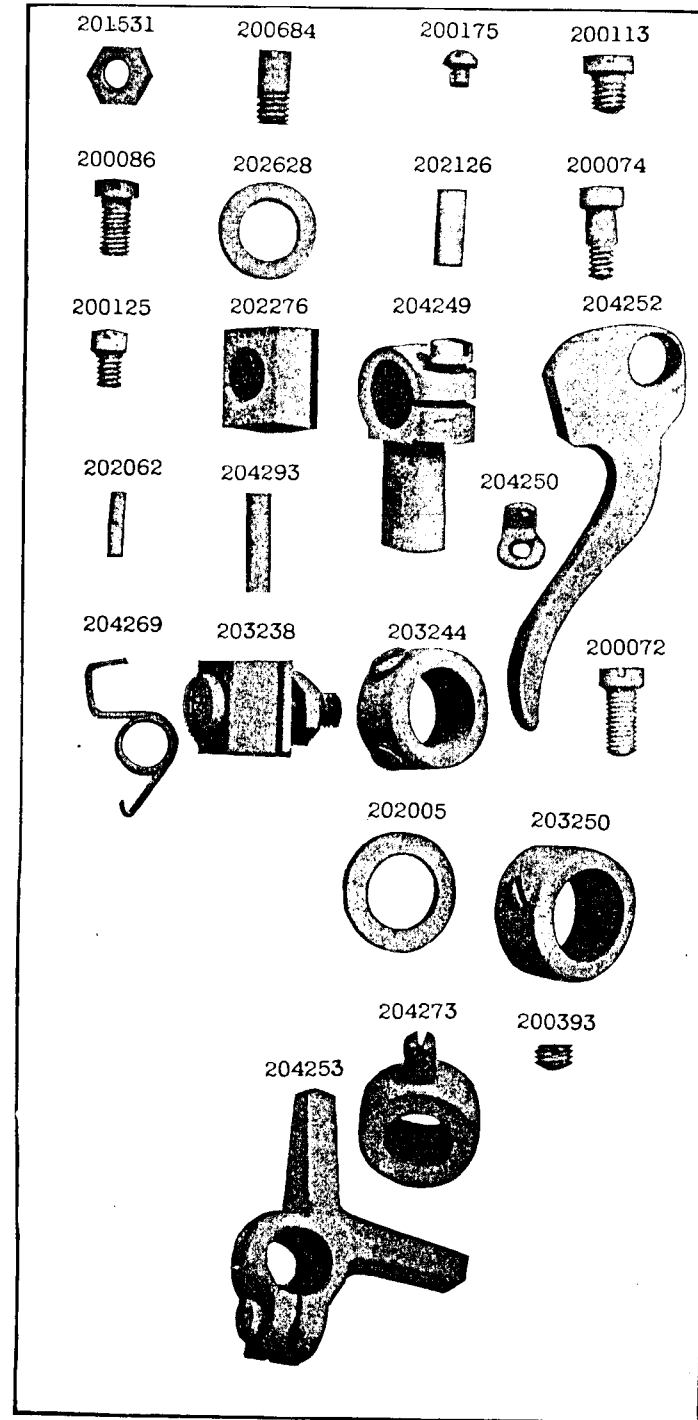


PLATE 12309 -FULL SIZE

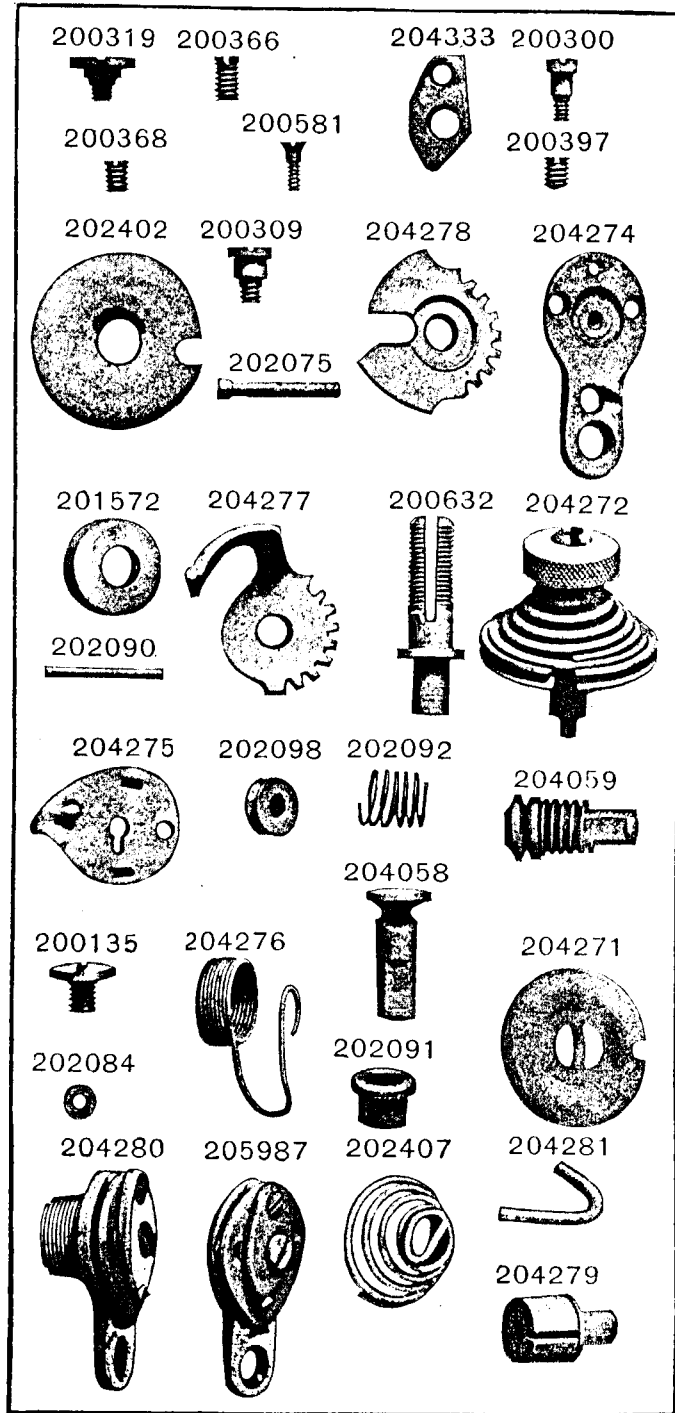


PLATE 12310 -FULL SIZE

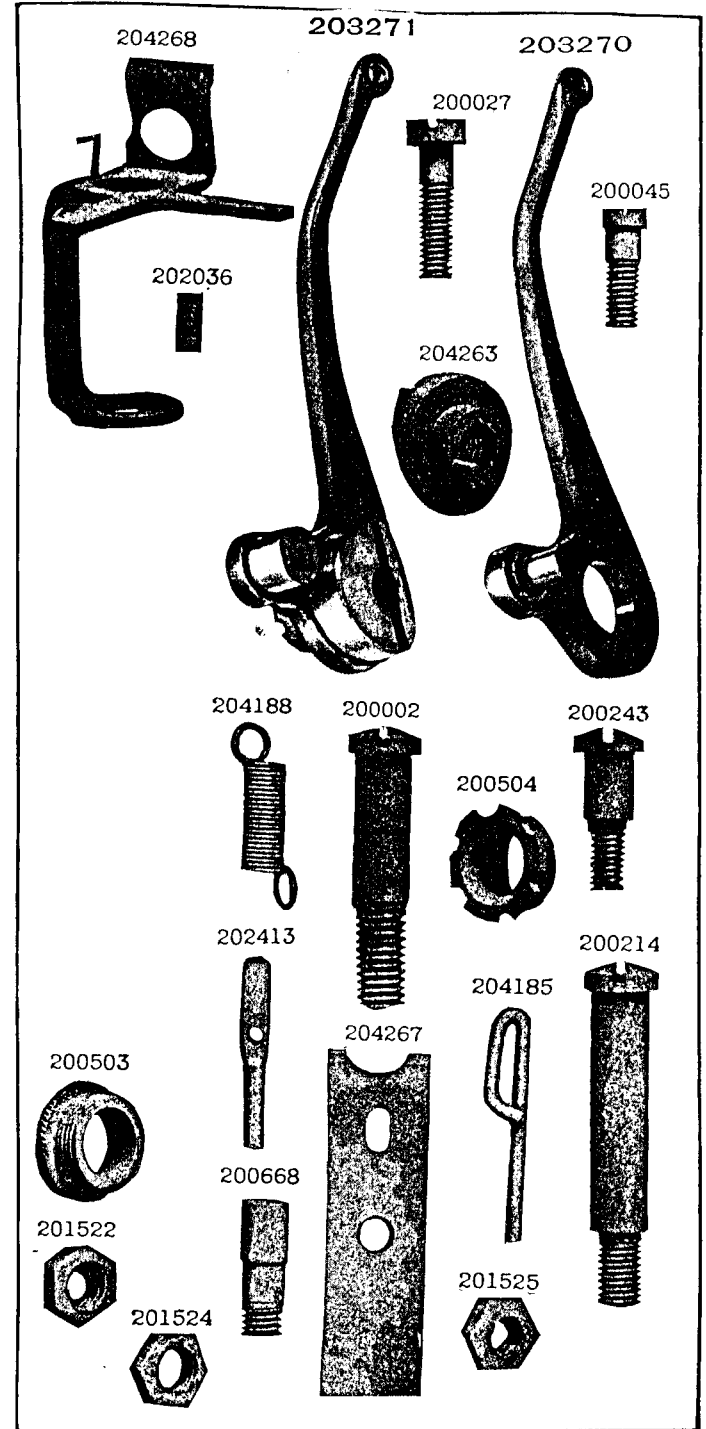


PLATE 12311—FULL SIZE

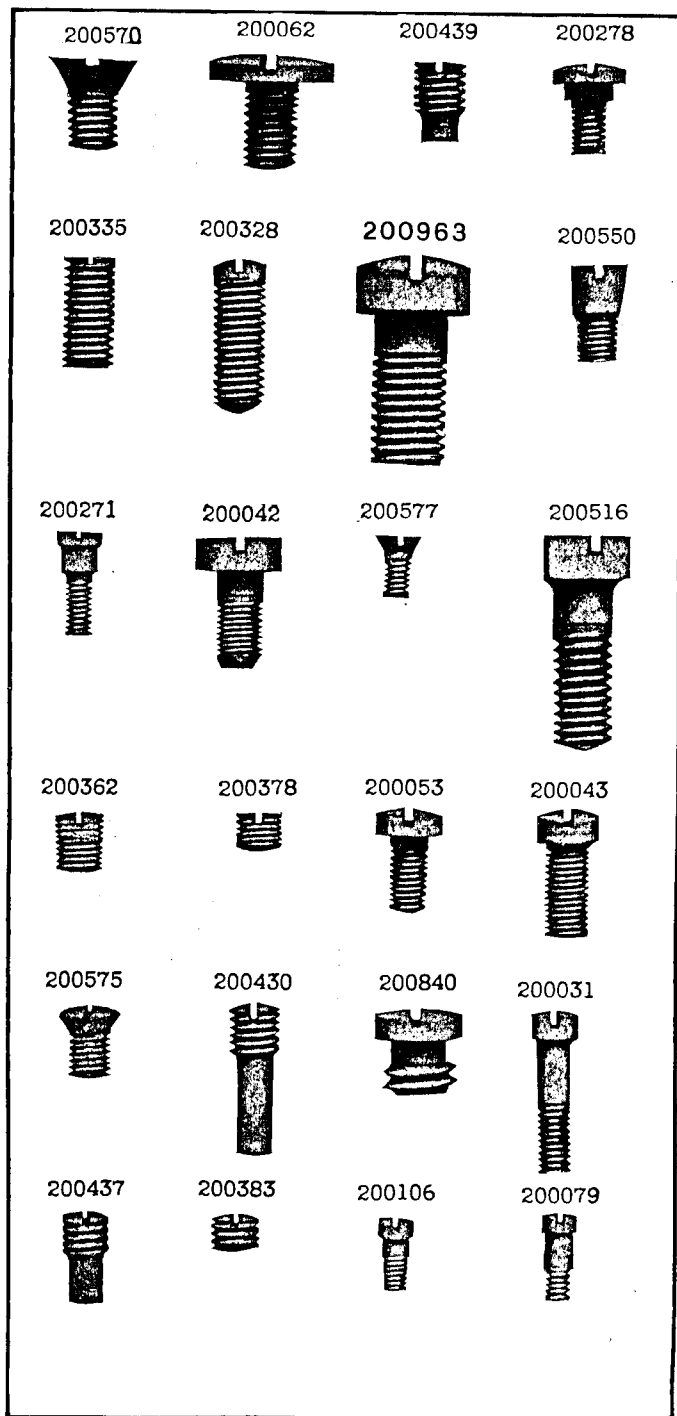


PLATE 12315—ONE-HALF SIZE

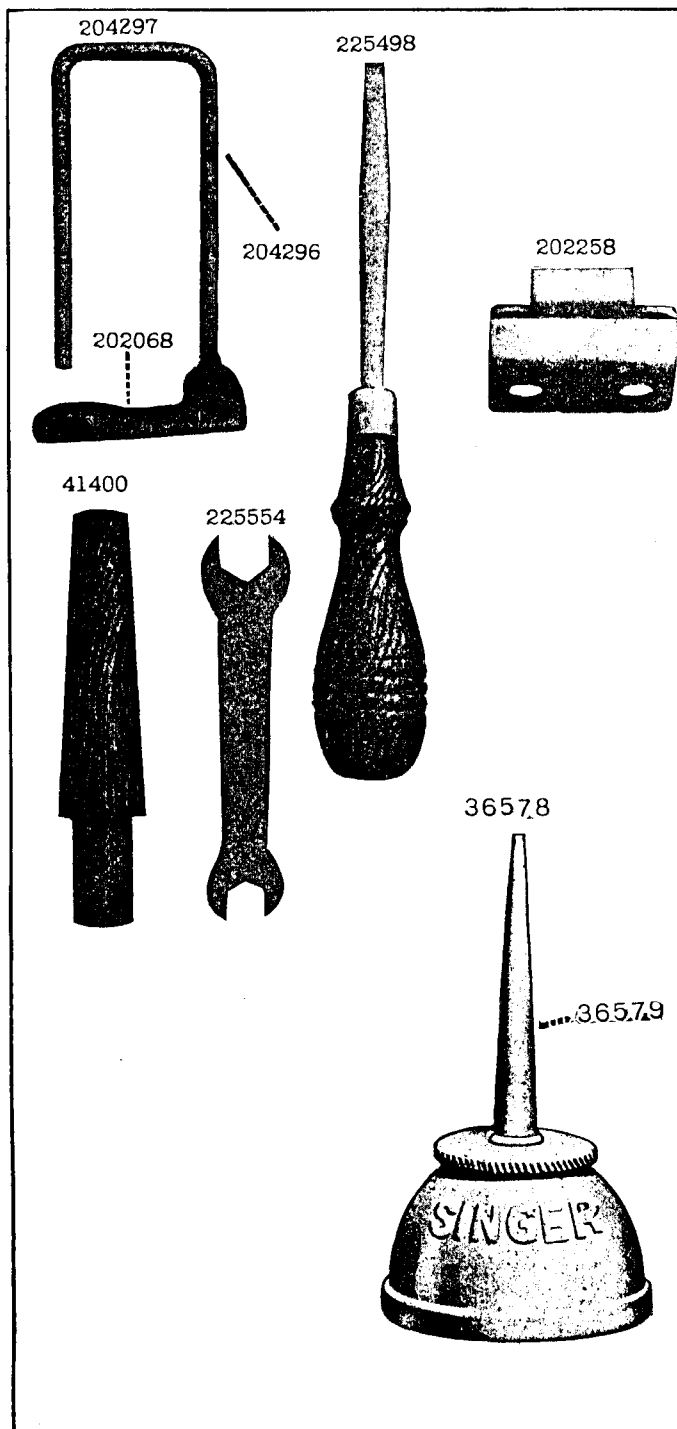


PLATE 12319 - FULL SIZE

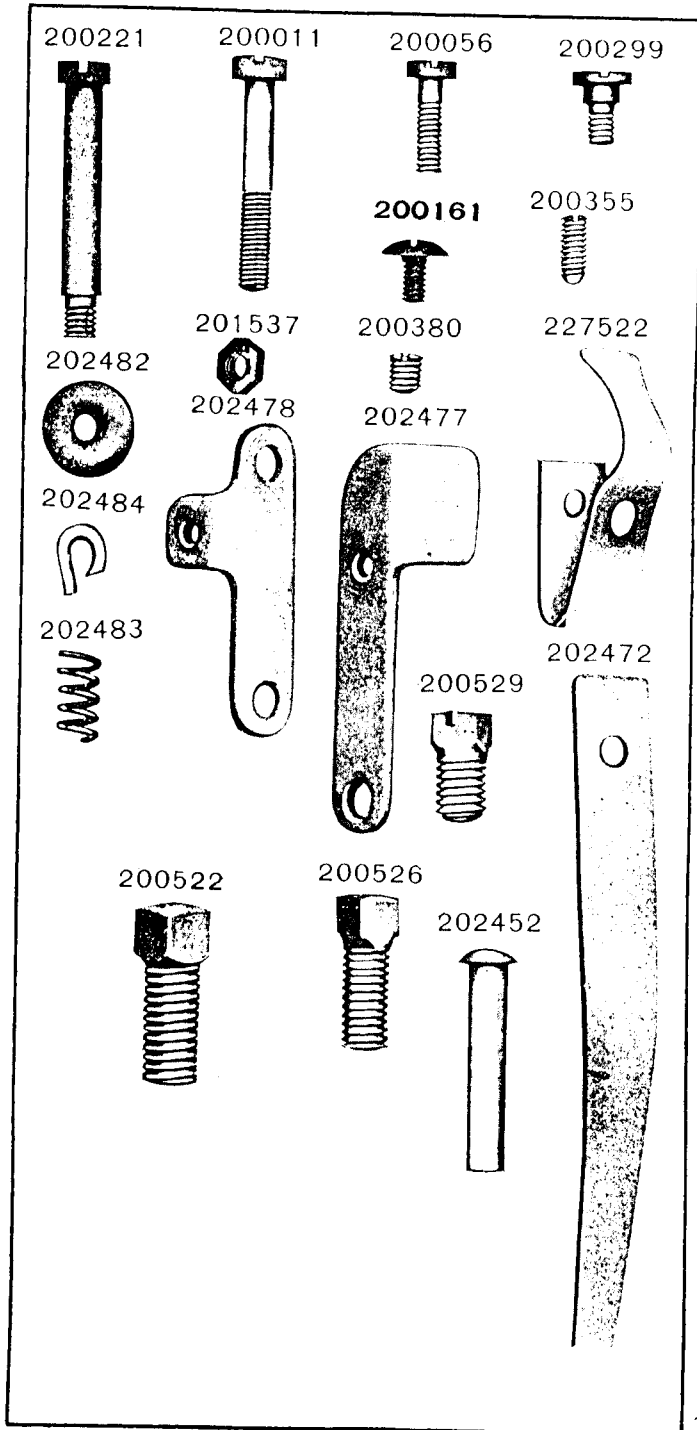


PLATE 12320 - ONE-HALF SIZE

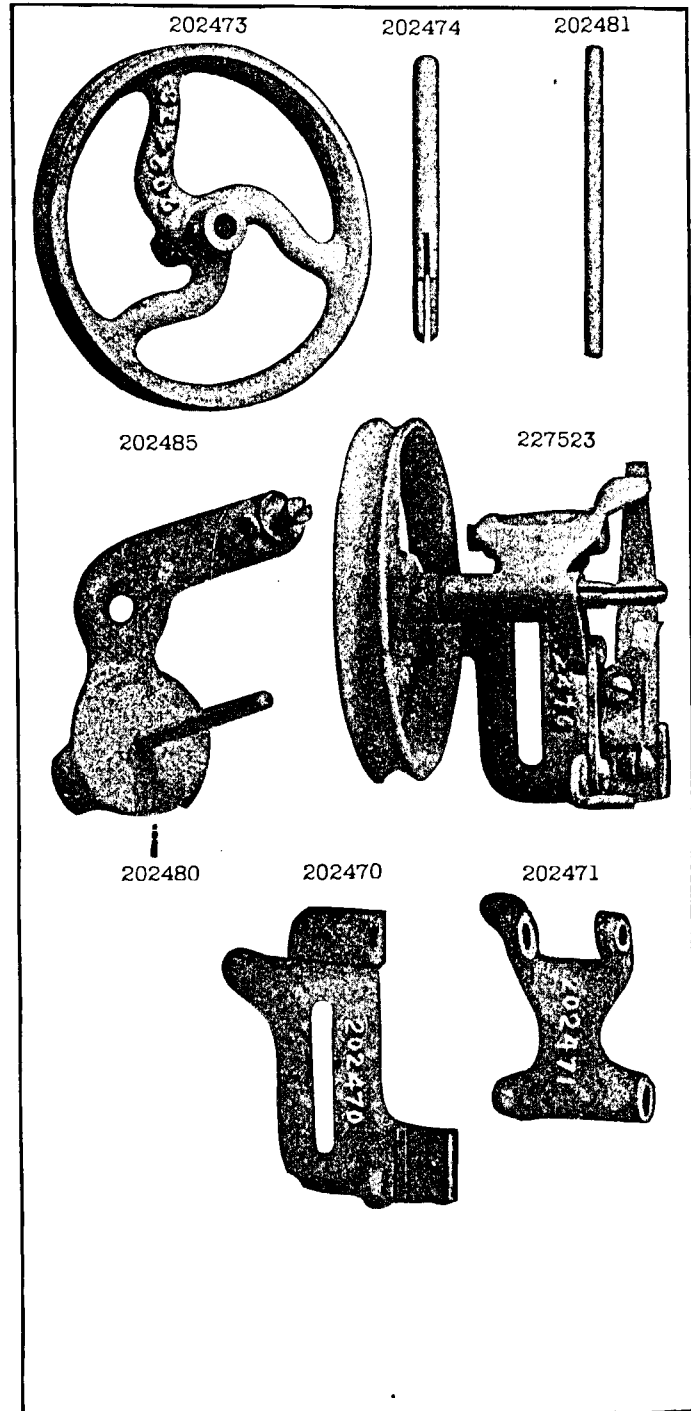


PLATE 12393—FULL SIZE

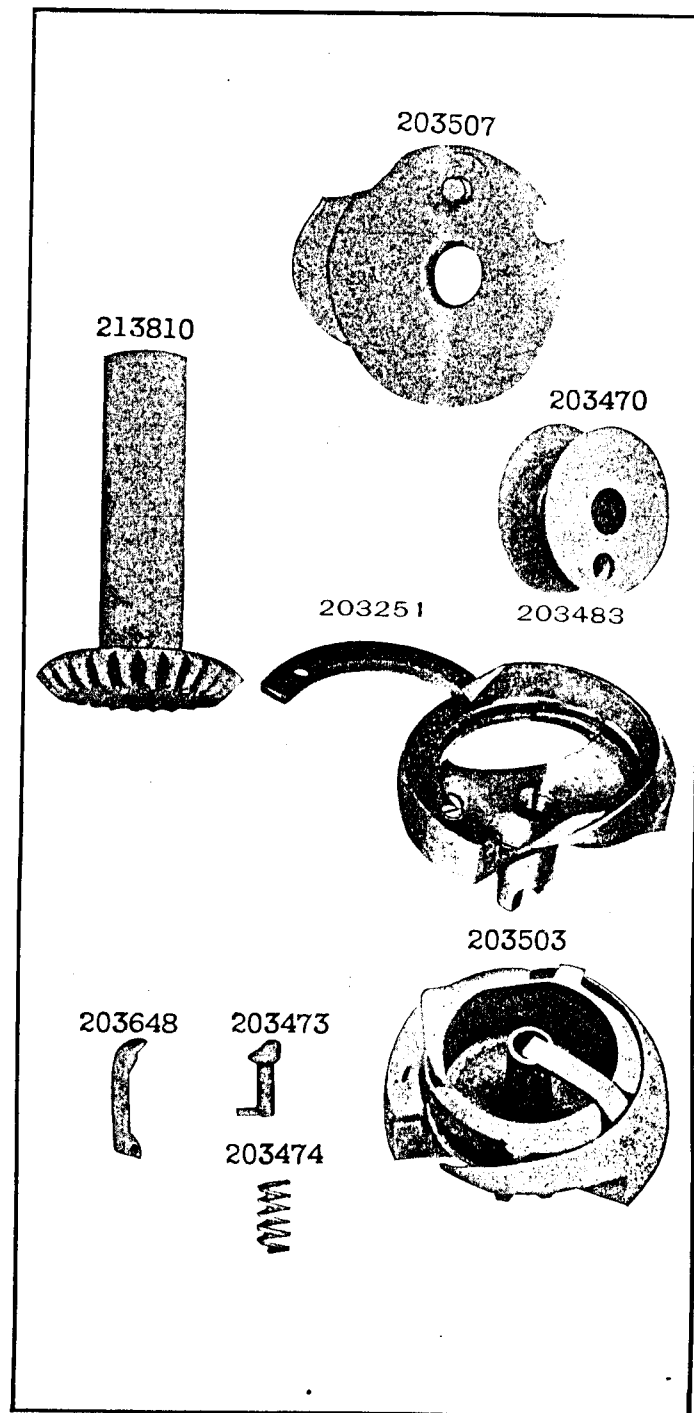


PLATE 12394—FULL SIZE

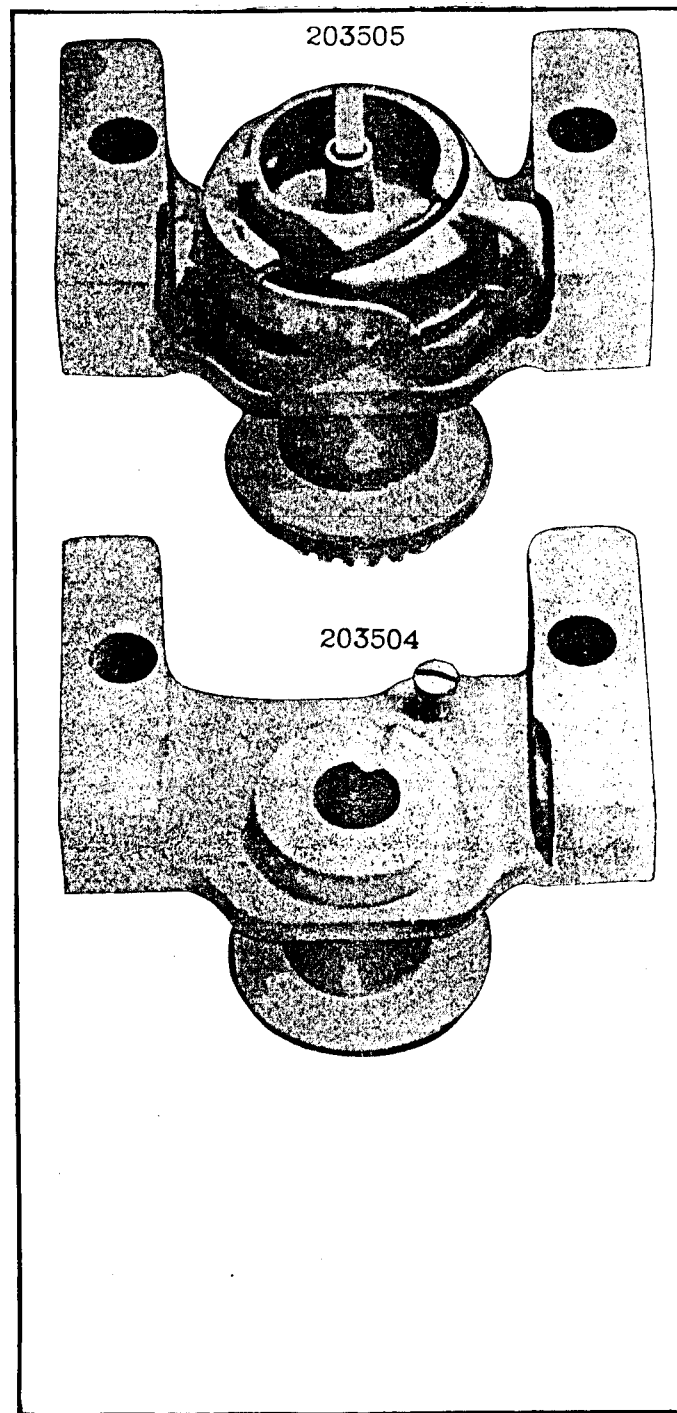
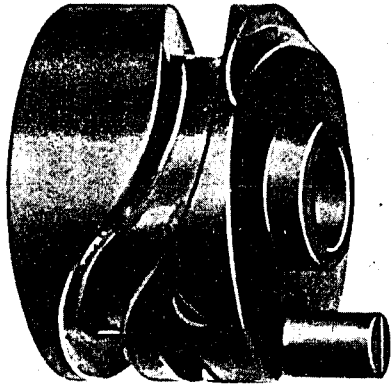


PLATE 13045—FULL SIZE

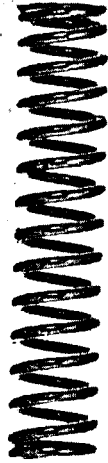
213006



213141



204258



200548



203214



204235



200382



201253



200984



200594

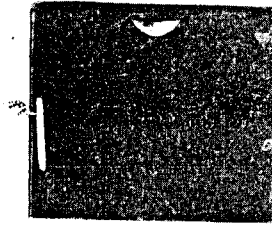


201376



PLATE 13046—ONE-HALF SIZE

203329



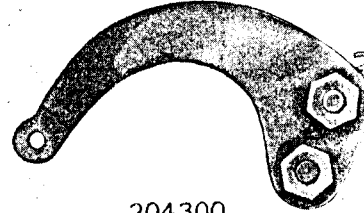
208613



225497



223010



204300

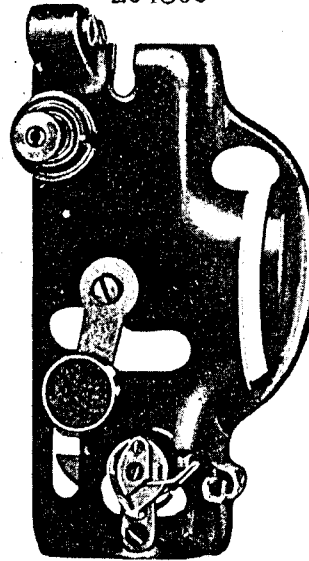
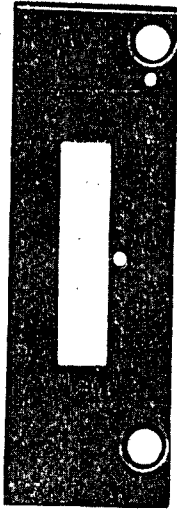




PLATE 13047—FULL SIZE

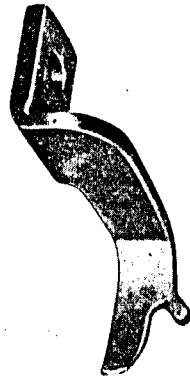
211334  
211335  
215905



229089



229088



202803



202616

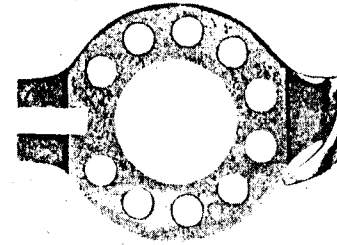


PLATE 13048—FULL SIZE

225487



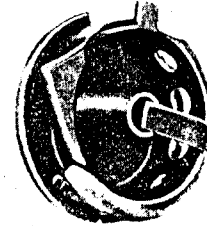
203499



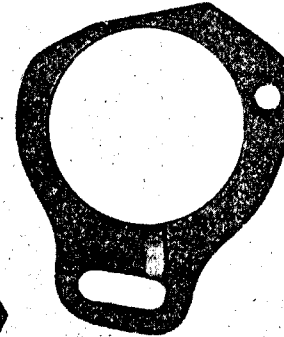
213606



203500



203506



201209



201515



200555



202413



200157



203478



201534



200552



200534



200116

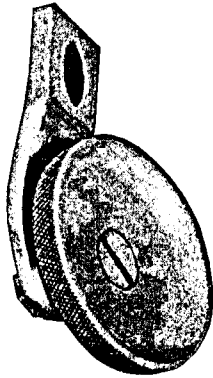


200688

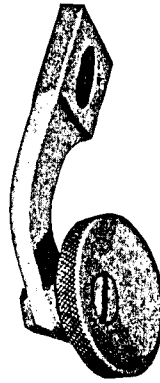


PLATE 14305—FULL SIZE

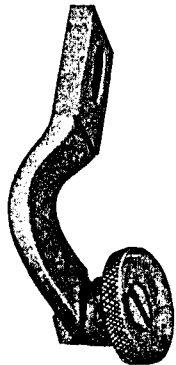
204567



204570



204572



204574



229798

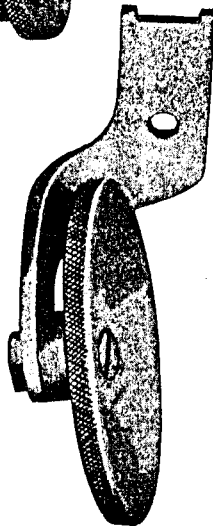
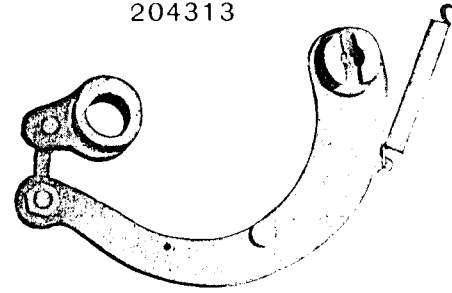


PLATE 14514—ONE-HALF SIZE

204313



204337



204338



213650

213649

