

Form 18147—REVISED  
January, 1933  
PRINTED IN U. S. A.

# LIST OF PARTS

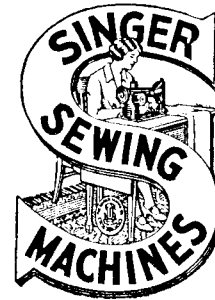

# MACHINES

Nos. 81-9, 81-20 and 81-21

---

THE SINGER MANUFACTURING COMPANY

COPYRIGHT, U. S. A., 1916, 1918, 1922, 1923, 1926 and 1932  
BY THE SINGER MANUFACTURING CO.  
ALL RIGHTS RESERVED FOR ALL COUNTRIES

## INSTRUCTIONS FOR OILING

---

To ensure easy running and prevent unnecessary wear of the parts which are in movable contact, the machine requires oiling and when in continuous use, it should be oiled at least twice each day by applying Singer Cloth and Leather Oil to all oil holes marked "Oil" and to all other oiling places.

Genuine Singer Needles should be used  
in this machine.  
Their containers are marked with the  
Company's Trade Mark "SIMANCO." 1

Needles in Containers marked  
"For Singer Machines"  
are not Singer made needles. 2

## INDEX

---

	PAGE
ACCESSORIES.....	31
FOOT LIFTER PARTS.....	32
GUIDE (HINGED).....	31
KNIFE GRINDER.....	33
KNEE LIFTER PARTS.....	32
MACHINE NO. 81-9.....	7
"    " 81-20.....	15
"    " 81-21.....	23
MACHINE BASE.....	31
NUMERICAL LIST OF PARTS.....	37
OBSOLETE PARTS.....	35
THREAD UNWINDER.....	34

# INSTRUCTIONS FOR ORDERING

In ordering from this list, use ONLY the part NUMBER in the FIRST column.

The number stamped on a Sewing Machine Part is in every case the number of the single part only.

Every combination of parts sent out as such has its specific number, which, although not stamped on the parts, must be used when ordering the combination.

Each number always indicates the SAME PART in whatever list it appears, or for whatever machine.

The letters after some of the numbers indicate the style of finish only, as follows:

- A—Hardened, Polished, Nickel Plated and Buffed
- B—Polished, Nickel Plated and Buffed
- C—Hardened Only
- D—Polished Only
- E—Soft, Not Polished
- F—Hardened and Polished
- H—Blued
- J—Nickel Plated Only
- K—Hardened and Nickel Plated
- L—Brass Plated
- M—Oxidized
- N—Japanned, Dull
- P—Japanned, Bright
- R—Merlized
- T—Copper Plated
- T. A.—Hardened, Polished, Copper and Nickel Plated and Buffed
- T. B.—Copper and Nickel Plated and Polished
- T. J.—Copper and Nickel Plated Only
- T. K.—Hardened, Copper and Nickel Plated
- T. M.—Copper Plated and Oxidized
- T. L.—Copper and Brass Plated
- U—Zinc Plated
- V—Silver Plated
- W—Polished and Nickel Plated
- Y—Black Nickel Plated Only
- Z—Chromium Plated
- Z. B.—Polished, Nickel Plated, Buffed and Chromium Plated
- Z. J.—Nickel and Chromium Plated

These letters MUST BE USED when they appear in the list; and AFTER the number as in the list.

In this series:

- 1 to 1500 and 50001 to 51500 are Screw Numbers
- 1501 to 1800 and 51501 to 51800 are Nut Numbers
- 1801 to 2000 and 51801 to 52000 are Roller Numbers
- 2001 to 50000 and 52001 and upward are numbers of Sewing Machine Parts and Electrical Parts.

The figures in the second column refer only to the plates, illustrating the parts, and are NOT TO BE USED in ordering.

Parts marked with an asterisk (\*) are furnished only when repairs are made at factory.

# LIST OF PARTS COMPLETE FOR

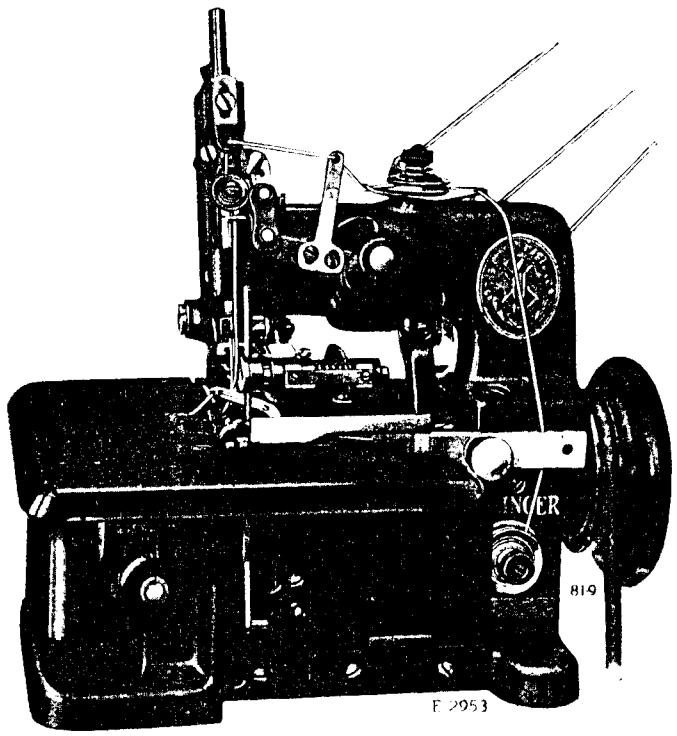

## MACHINE No. 81-9

FOR SEAMING AND INSERTING SLEEVES AND HEMMING THE BOTTOMS AND CUFFS OF LIGHT AND MEDIUM SWEATERS. HAS TRIMMER AND AUXILIARY FEED TO PREVENT FULLING OR "BELLING" THE EDGE WHILE STITCHING. HIGH LIFT. FOOT LIFTER.

NO.	PLATE	NAME
*42485	---	Arm with two each 462c, 624c, 42253 and 42487.....
4389	5585	Arm Dowel Pin.....
949E	5587	" Screw.....
42001	5576	Balance Wheel, 2 3/4 in. pulley, with 424c and 4354c.....

NO.	PLATE	NAME
1354c	5587	Balance Wheel Position Screw.....
424c	5587	" " Set Screw.....
42002	5526	Cloth Plate.....
42401	—	Cloth Plate complete, Nos. 42002, 42005, 42108, 42294, two 236c and five 229E...
42294	5598	Cloth Plate Extension (lower).....
229E	5587	" " " " Screw....
42108	5577	" " " (upper).....
229E	5587	" " " " Screw....
1437D	5587	" " Hinge Screw.....
1655J	5587	" " " " Nut.....
42005	5526	" " Lock Spring.....
236c	5587	" " " " Screw.....
42147	7376	Feed (back) Bar.....
61c	7376	" " " Hinge Screw.....
42148	7376	" " Connecting Link.....
1132c	7376	" " " " Hinge Screw
42149	7397	" " Dog, 3 teeth (16 teeth to the inch).....
203c	5587	Feed (back) Dog Screw.....
42150	5557	" " Regulator.....
1132c	5557	" " " Hinge Screw....
190r	5557	" " " Set Screw.....
1444c	5557	" " " Thumb Screw....
42151	5557	" (front) Bar with 1253c.....
42007	5529	" " " Hinge Pin.....
1253c	5587	" " " " Set Screw...
42008	5529	" " Connecting Rod with 42009 and two 1057E.....
*42009	—	Feed (front) Connecting Rod Cap.....
1057E	5529	" " " " " Screw
1373c	5529	" " " " H i n g e Screw.....
1520c	5529	Feed (front) Connecting Rod Hinge Screw Nut.....
42402	7397	Feed (front) Dog, 17 teeth (16 teeth to the inch).....
190J	5557	Feed (front) Dog Screw.....
42011	5529	" " Eccentric with two 453c....
42298	7375	" " " Cover.....
207F	5529	" " " " Screw.....
453c	5529	" " " Set Screw.....
42208	7376	" " Lifting Eccentric with two 462c.....
42013	5529	Feed (front) Lifting Eccentric Connection
462c	5544	" " " " Set Screw..
1374c	5530	" " Regulating Screw Stud....

NO.	PLATE	NAME
1680c	5530	Feed (front) Regulating Screw Stud Nut
42290	5530	" " " " " "
		Washer.....
42014	5530	Feed (front) Regulator with 233J and two 1259c.....
42015	5529	Feed (front) Regulator Connection with 1012E.....
1012E	5529	Feed (front) Regulator Connection Ad- justing Screw.....
1373c	5529	Feed (front) Regulator Connection Hinge Screw.....
1520c	5529	Feed (front) Regulator Connection Hinge Screw Nut.....
42016	5530	Feed (front) Regulator Hinge Stud.....
42017	5529	" " " Indicator.....
42018	5530	" " " " Plate....
337J	5530	" " " " " Screw
207F	5587	" " " " " Screw...
1259c	5530	" " " Set Screw.....
233J	5530	" " " Stop Screw.....
42154	7376	" " Rock Shaft.....
42155	—	Feed (front) Rock Shaft complete, Nos. 42021 and 42154.....
42021	5530	Feed (front) Rock Shaft Crank with 157E
157E	5530	" " " " " Clamping Screw.....
42098	5530	Feed (front) Rock Shaft Hinge Pin.....
42079	5530	" " " " " Bush- ing.....
1036c	5530	Feed (front) Rock Shaft Hinge Pin Bush- ing Set Screw.....
*42209	—	Frame.....
42266	7375	" Rotary Shaft.....
42024	5576	" " " Bushing (front)....
1036c	5530	" " " " " Set Screw.....
42211	7380	Frame Rotary Shaft Crank with 1036c and 1375c.....
1375c	5553	Frame Rotary Shaft Crank Position Screw.....
1036c	5530	Frame Rotary Shaft Crank Set Screw...
42026	5576	" " " Flanged Bushing (back) with 54967.....
54967	5585	Frame Rotary Shaft Flanged Bushing (back) Oil Pad (braided cotton).....
1036c	5530	Frame Rotary Shaft Flanged Bushing (back) Set Screw.....

NO.	PLATE	NAME
42367	5585	Frame Rotary Shaft Front Bearing Oil Pad (braided cotton).....
42027	7375	Frame Side Cover (left) with 19045.....
19045	5585	" " " " Handle.....
330w	5587	" " " " Screw.....
42028	5526	" " " " (right) hinged.....
42101	5543	" " " " Lock Spring.....
330w	5587	" " " " Screw.....
42029	5576	" Top Cover.....
42212	7376	" " " Extension.....
42102	5543	" " " " Holder.....
*42319	—	Frame Top Cover Extension Holder 42102 with 42101, 42212, 42298 and two each 176J and 207E.....
283w	5543	Frame Top Cover Extension Holder Thumb Screw.....
2749	5543	Frame Top Cover Extension Holder Thumb Screw Washer.....
176J	7376	Frame Top Cover Extension Screw.....
742F	5587	" " " " Screw.....
42213	7398	Knife (movable).....
NOTE: Two No. 42213 are sent with this machine.		
42214	7398	Knife (movable) Gib.....
42035	5542	" " Holder.....
42215	—	" " " " 42035 with 133E, 42040, 42214, 42216 and two 40E.....
42216	7398	Knife (movable) Holder Cap.....
404E	5542	" " " " " Screw.....
42038	5542	" " " " Guide with 336F.....
42039	5542	" " " " Plate.....
621D	5542	" " " " " Screw.....
336F	5542	" " " " " Set Screw.....
133F	5542	" " " " " Screw.....
42040	5542	" " " " " Extension Pin.....
42041	5542	Knife (movable) Holder Spring.....
42042	5542	" " " " Lever.....
42043	5542	" " " " " Connection with 42044 and two 175E.....
*42044	—	Knife (movable) Lever Connection Cap
175E	5542	" " " " " " " Screw.....
1373c	5542	Knife (movable) Lever Connection Hinge Screw.....
1520c	5542	Knife (movable) Lever Connection Hinge Screw Nut.....

NO.	PLATE	NAME
42045	5542	Knife (movable) Lever Hinge Stud.....
1229c	5542	" " " " " " " Set Screw.....
42046	5513	Knife (stationary) with 42049.....
NOTE: Two No. 42046 are sent with this machine.		
42048	5543	Knife (stationary) Clamping Stud.....
1534D	5543	" " " " " " " Thumb Nut.....
42156	5545	Knife (stationary) Holder.....
1376c	5543	" " " " " " " Regulating Thumb Screw.....
1101c	5543	Knife (stationary) Holder Screw.....
440F	5543	" " " " " " " Stop Screw.....
1547J	5543	" " " " " " " Nut.....
42049	5543	" " " " " " " Stud.....
42219	7380	Looper (left hand).....
42051	5553	" " " " " " " Lever with 209H.....
42052	5553	" " " " " " " Connecting Link.....
50562c	7396	Looper (left hand) Lever Connecting Link Hinge Screw.....
1520c	5529	Looper (left hand) Lever Connecting Link Hinge Screw Nut.....
42053	5553	Looper (left hand) Lever Hinge Stud.....
1036c	5553	" " " " " " " " Set Screw.....
209H	5553	Looper (left hand) Set Screw.....
42220	7380	" (right hand).....
42073	5553	" " " " " " " and Spreader Lever with 1259c.....
42221	7380	Looper (right hand) and Spreader Lever Ball Stud.....
1259c	5553	Looper (right hand) and Spreader Lever Ball Stud Set Screw.....
42075	5553	Looper (right hand) and Spreader Lever Connection with 42059, 42076 and four 896E.....
*42076	—	Looper (right hand) and Spreader Lever Connection Cap (lower).....
896E	7396	Looper (right hand) and Spreader Lever Connection Cap (lower) Screw.....
*42059	—	Looper (right hand) and Spreader Lever Connection Cap (upper).....
896E	7396	Looper (right hand) and Spreader Lever Connection Cap (upper) Screw.....

NO.	PLATE	NAME
42077	5584	Looper (right hand) and Spreader Lever Connection Guide.....
171E	5544	Looper (right hand) and Spreader Lever Connection Guide Screw.....
42403	7398	Looper (right hand) and Spreader Lever Connection Oil Tube and Bracket with 29599.....
29599	5584	Looper (right hand) and Spreader Lever Connection Oil Tube Packing (felt)...
42078	5584	Looper (right hand) and Spreader Lever Hinge Pin.....
42079	5530	Looper (right hand) and Spreader Lever Hinge Pin Bushing.....
1259c	5553	Looper (right hand) and Spreader Lever Hinge Pin Bushing Set Screw.....
197J	5553	Looper (right hand) Screw.....
38534	7380	Needle Bar (hollow).....
42253	5544	" " Bushing.....
462c	5544	" " " Set Screw.....
42291	7380	" " Connecting Bracket with 223F and 1057E.....
1057E	5553	Needle Bar Connecting Bracket Clamping Screw.....
42055	5544	Needle Bar Connecting Link.....
40247	5544	" " " " Hinge Pin
223F	5544	" " " " " "
		Set Screw for 42291.....
904c	5544	Needle Bar Connecting Link Hinge Pin Set Screw for 42104.....
42057	5544	Needle Bar Connecting Rod with 42059, 42076 and four 896E.....
*42076	—	Needle Bar Connecting Rod Cap (lower)
896E	7396	" " " " " "
		Screw.....
*42059	—	Needle Bar Connecting Rod Cap (upper)
896E	7396	" " " " " "
		Screw.....
42077	5584	Needle Bar Connecting Rod Guide.....
171F	5544	" " " " " Screw
42103	5544	" " Crank (back) with 1258c and two 1259c.....
42074	5553	Needle Bar Crank (back) Ball Stud.....
1259c	5553	" " " " " " Set Screw.....
1259c	5553	Needle Bar Crank (back) Position Screw
1258c	5544	" " " " Set Screw.....
42104	5544	" " " (front) with 904c, 1258c and 1259c.....

NO.	PLATE	NAME
1259c	5553	Needle Bar Crank (front) Position Screw.....
1258c	5544	Needle Bar Crank (front) Set Screw.....
42105	5544	" " " Shaft.....
42487	7396	" " " " Bushing.....
624c	7396	" " " " Set Screw
42115	5544	" " Thread Retainer Bracket....
228J	5544	" " " " " Screw
42483	7396	" " " " Disc.....
93c	5544	" " " " Screw.....
10107	5544	" " " " Spring.....
1728c	7380	" Clamping Nut.....
42066	5544	" Guard.....
171F	5544	" " Screw.....
42157	—	Presser Foot Body.....
42404	7397	" " Chaining-off Finger for 42406.....
42500	—	Presser Foot Chaining-off Finger for 132663.....
233J	5530	Presser Foot Chaining-off Finger Screw
9320	5585	" " Hinge Pin.....
42405	—	" " Plate.....
14058	5585	" " Spring.....
42160	5585	" " " Adjusting Pin.....
464c	5587	" " " " " Set Screw.....
42406	7397	Presser Foot (spring hinged) complete, Nos. 233J, 464c, 9320, 14058, 42157, 42160, 42404 and 42405.....
132663	—	Presser Foot (spring hinged) complete, Nos. 233J, 464c, 9320, 14058, 42157, 42160, 42405 and 42500.....
1324c	5545	Presser Foot Screw.....
39541	5545	" " " Washer.....
42227	7375	" Lever.....
42377	—	" " 42227 with 42045.....
42045	5545	" " Hinge Stud.....
1120c	5545	" " " " Set Screw.....
42070	5584	" " Lifter.....
85D	5584	" " " Hinge Screw.....
1377c	5584	" " Screw Stud (eccentric)....
1547J	5584	" " " Nut.....
42071	5584	" " Spring.....
1378D	5584	Pressure Regulating Thumb Screw.....
42250	7380	Spreader.....
197J	5553	" Screw.....
2102	5585	Tension (looper, left hand) Disc.....

NO.	PLATE	NAME
1560c	5585	Tension (looper, left hand) Regulating Thumb Nut.....
828c	5585	Tension (looper, left hand) Screw Stud
42418	—	“ “ “ “ “ “
		828c with 1560c.....
42121	7380	Tension (looper left hand) Spring.....
2102	5585	“ “ right hand) Disc.....
1560c	5585	“ “ “ “ Regulating Thumb Nut.....
828c	5585	Tension (looper, right hand) Screw Stud
42418	—	“ “ “ “ “ “
		828c with 1560c.....
10148	5585	Tension (looper, right hand) Spring.....
17547	5585	“ “ “ “ Thread Guide
2102	5585	“ (needle thread) Disc.....
1560c	5585	“ “ “ “ Regulating Thumb Nut.....
916c	5585	Tension (needle thread) Screw Stud.....
41209	—	“ “ “ “ “ “ 916c with 1560c.....
2103	7380	Tension (needle thread) Spring.....
42082	5585	“ “ “ “ Thread Guide...
42242	7396	Thread (looper, left hand) Eyelet.....
233j	5530	“ “ “ “ “ Screw.
42122	7380	“ “ “ “ Nipper Spring (lower).....
42123	7380	Thread (looper, left hand) Nipper Spring (upper).....
176j	7376	Thread (looper, left hand) Nipper Spring Screw.....
42124	7380	Thread (looper, left hand) Pull-off.....
42125	7380	“ “ “ “ “ Eyelet
233j	5530	“ “ “ “ “ Screw.
42084	5585	“ “ “ “ Tube.....
462c	5544	“ “ “ “ “ Set Screw
42126	7380	“ (looper, right hand) Pull-off.....
42093	5585	“ “ “ “ Staple.....
190j	5557	“ “ “ “ “ Screw
42127	5585	“ “ “ “ “ Take-up....
197F	5553	“ “ “ “ “ Screw
42096	5585	“ (needle) Eyelet.....
217F	5585	“ “ “ “ Screw.....
42128	7398	“ “ “ “ Take-up.....
197F	5553	“ “ “ “ “ Screw.....
42407	7397	Throat Plate for 42149 and 42402.....
742F	5587	“ “ “ “ “ Screw.....

## LIST OF PARTS COMPLETE FOR

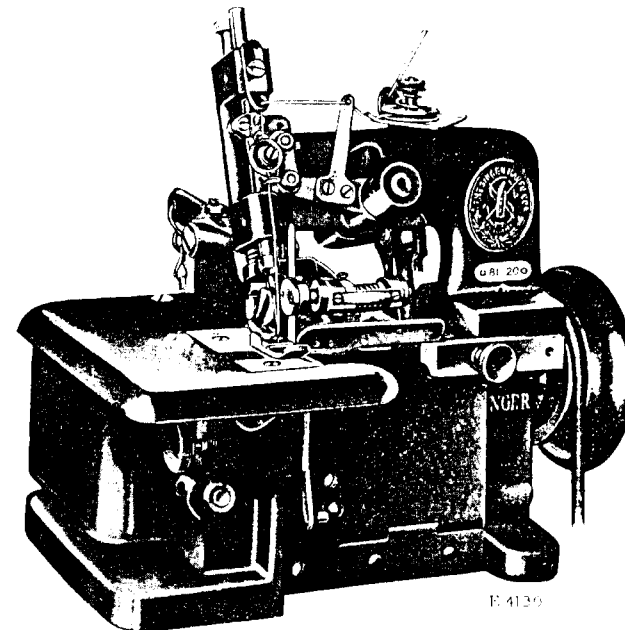

## MACHINE No. 81-20

FOR TRIMMING, OVEREDGING AND CLOSING SEAMS IN FINE STOCKINGS AND UNDERWEAR MADE OF SILK, LISLE THREAD, ETC. HAS AUXILIARY FEED TO PREVENT FULLING THE EDGES WHILE STITCHING. BIGHT ADJUSTABLE FROM  $\frac{1}{16}$  IN. TO  $\frac{1}{8}$  IN. TWO-THREAD STITCH. FOOT LIFTER.

NO.	PLATE	NAME
*42484	—	Arm with two each 462c, 624c, 12253 and 12487.....
4389	5585	Arm Dowel Pin.....
949E	5587	“ “ Screw.....
42001	5576	Balance Wheel, $2\frac{1}{8}$ in. pulley, with 424c and 1354c.....
1354c	5587	Balance Wheel Position Screw.....
424c	5587	“ “ “ “ Set Screw.....



NO.	PLATE	NAME
*42145	5577	Cloth Plate.....
42146	—	Cloth Plate complete, Nos. 42003, 42005, 42108, 42145, two 236c and five 229E..
42003	5577	Cloth Plate Extension (lower).....
229E	5587	" " " " Screw....
42108	5577	" " " (upper).....
229E	5587	" " " " Screw....
1437D	5587	" " Hinge Screw.....
1655J	5587	" " " Nut.....
42005	5526	" " Lock Spring.....
236c	5587	" " " " Screw.....
42147	7376	Feed (back) Bar.....
61c	7376	" " " Hinge Screw.....
42148	7376	" " Connecting Link.....
1132c	7376	" " " Hinge Screw
42421	7399	" " Dog, fine teeth, for silk work
203c	5587	" " " Screw.....
42150	5557	" " Regulator.....
1132c	5557	" " " Hinge Screw....
190J	5557	" " " Set Screw.....
1444c	5557	" " " Thumb Screw....
42151	5557	" (front) Bar with 1253c.....
42007	5529	" " " Hinge Pin.....
1253c	5587	" " " " " Set Screw...
42008	5529	" " Connecting Rod with 42009 and two 1057E.....
*42009	—	Feed (front) Connecting Rod Cap.....
1057E	5529	" " " " " Screw
1373c	5529	" " " " " Hinge Cap
1520c	5529	" " " " " " "
		Nut.....
42422	7399	Feed (front) Dog, fine teeth, for silk work.....
190J	5557	Feed (front) Dog Screw.....
42011	5529	" " Eccentric with two 453c....
42153	5577	" " " Cover.....
207F	5529	" " " " Screw.....
453c	5529	" " " Set Screw.....
42012	5529	" " Lifting Eccentric with two 462c.....
42013	5529	Feed (front) Lifting Eccentric Con- nection.....
462c	5544	Feed (front) Lifting Eccentric Set Screw
1374c	5530	" " Regulating Screw Stud....
1680c	5530	" " " " " Nut
42290	5530	" " " " " "
		Washer.....

NO.	PLATE	NAME
42014	5530	Feed (front) Regulator with 233J and two 1259c.....
42015	5529	Feed (front) Regulator Connection with 1012E.....
1012E	5529	Feed (front) Regulator Connection Ad- justing Screw.....
1373c	5529	Feed (front) Regulator Connection Hinge Screw.....
1520c	5529	Feed (front) Regulator Connection Hinge Screw Nut.....
42016	5530	Feed (front) Regulator Hinge Stud.....
42017	5529	" " " Indicator.....
42018	5530	" " " " " Plate
337J	5530	" " " " " "
		Screw.....
207F	5587	Feed (front) Regulator Indicator Screw..
1259c	5530	" " " Set Screw.....
233J	5530	" " " Stop Screw.....
42154	7376	" " Rock Shaft.....
42155	—	Feed (front) Rock Shaft complete, Nos. 42021 and 42154.....
42021	5530	Feed (front) Rock Shaft Crank with 157E.....
157E	5530	Feed (front) Rock Shaft Crank Clamp- ing Screw.....
42098	5530	Feed (front) Rock Shaft Hinge Pin.....
42079	5530	" " " " " " Bush- ing.....
1036c	5530	Feed (front) Rock Shaft Hinge Pin Bush- ing Set Screw.....
*42022	—	Frame.....
42023	5576	" Rotary Shaft.....
42024	5576	" " " Bushing (front)....
1036c	5530	" " " " " Set Screw.....
42110	7396	Frame Rotary Shaft Crank with 1036c and 1375c.....
1375c	5553	Frame Rotary Shaft Crank Position Screw.....
1036c	5530	Frame Rotary Shaft Crank Set Screw...
42026	5576	" " " Flanged Bushing (back) with 54967.....
54967	5585	Frame Rotary Shaft Flanged Bushing (back) Oil Pad (braided cotton).....
1036c	5530	Frame Rotary Shaft Flanged Bushing (back) Set Screw.....

NO.	PLATE	NAME
42367	5585	Frame Rotary Shaft Front Bearing Oil Pad (braided cotton).....
42027	7375	Frame Side Cover (left) with 19045.....
19045	5585	" " " " Handle.....
330w	5587	" " " " Screw.....
42028	5526	" " " (right) hinged.....
42101	5543	" " " " Lock Spring...
330w	5587	" " " " Screw.....
42029	5576	" Top Cover.....
42459	7398	" " " Extension.....
42102	5543	" " " " Holder.....
*42324	—	" " " " " 42102 with 42101, 42153, 42459 and two each 176J and 207F.....
283w	5543	Frame Top Cover Extension Holder Thumb Screw.....
2749	5543	Frame Top Cover Extension Holder Thumb Screw Washer.....
176J	7376	Frame Top Cover Extension Screw.....
742F	5587	" " " Screw.....
42111	5542	Knife (movable).....
NOTE: Two No. 42111 are sent with this machine.		
42112	5542	Knife (movable) Gib.....
42035	5542	" " Holder.....
42113	—	" " " 42035 with 133F, 42037, 42040, 42112 and two 404E....
42037	5542	Knife (movable) Holder Cap.....
404E	5542	" " " " Screw.....
42038	5542	" " " Guide with 336F.....
42039	5542	" " " " Plate....
621D	5542	" " " " " Screw
336F	5542	" " " " " Set Screw
133F	5542	" " " " " Screw.....
42040	5542	" " " " " Extension Pin.....
42041	5542	Knife (movable) Holder Spring.....
42042	5542	" " Lever.....
42043	5542	" " " Connection with 42044 and two 175E.....
*42044	—	Knife (movable) Lever Connection Cap
175E	5542	" " " " " " Screw.....
1373c	5542	Knife (movable) Lever Connection Hinge Screw.....
1520c	5542	Knife (movable) Lever Connection Hinge Screw Nut.....

NO.	PLATE	NAME
42045	5542	Knife (movable) Lever Hinge Stud.....
1229c	5542	" " " " " " Set Screw.....
42046	5543	Knife (stationary) with 42049.....
NOTE: Two No. 42046 are sent with this machine.		
42048	5543	Knife (stationary) Clamping Stud.....
1534D	5543	" " " " " Thumb Nut.....
42156	5545	Knife (stationary) Holder.....
1376c	5543	" " " " " Regulating Thumb Screw.....
1101c	5543	Knife (stationary) Holder Screw.....
440F	5543	" " " " " Stop Screw...
1547J	5543	" " " " " " Nut
42049	5543	" " Stud.....
42050	5553	Looper (left hand).....
42051	5553	" " " Lever with 209H.....
42052	5553	" " " " " Connecting Link
50562c	7396	" " " " " " " Hinge Screw.....
1520c	5529	Looper (left hand) Lever Connecting Link Hinge Screw Nut.....
42053	5553	Looper (left hand) Lever Hinge Stud
1036c	5553	" " " " " " " " Set Screw.....
209H	5553	Looper (left hand) Set Screw.....
42166	5553	" (right hand).....
42073	5553	" " " and Spreader Lever with 1259c.....
42074	5553	Looper (right hand) and Spreader Lever Ball Stud.....
1259c	5553	Looper (right hand) and Spreader Lever Ball Stud Set Screw.....
42075	5553	Looper (right hand) and Spreader Lever Connection with 42059, 42076 and four 896E.....
*42076	—	Looper (right hand) and Spreader Lever Connection Cap (lower).....
896E	7396	Looper (right hand) and Spreader Lever Connection Cap (lower) Screw.....
*42059	—	Looper (right hand) and Spreader Lever Connection Cap (upper).....
896E	7396	Looper (right hand) and Spreader Lever Connection Cap (upper) Screw.....
42077	5584	Looper (right hand) and Spreader Lever Connection Guide.....

NO.	PLATE	NAME
171E	5544	Looper (right hand) and Spreader Lever Connection Guide Screw.....
42106	5584	Looper (right hand) and Spreader Lever Connection Oil Tube and Bracket with 29599.....
29599	5584	Looper (right hand) and Spreader Lever Connection Oil Tube Packing (felt)...
42078	5584	Looper (right hand) and Spreader Lever Hinge Pin.....
42079	5530	Looper (right hand) and Spreader Lever Hinge Pin Bushing.....
1259c	5553	Looper (right hand) and Spreader Lever Hinge Pin Bushing Set Screw.....
197J	5553	Looper (right hand) Screw.....
42054	5544	Needle Bar.....
42253	5544	" " Bushing.....
462c	5544	" " " " Set Screw.....
42061	5544	" " Connecting Bracket with 187E and 223F.....
187E	5544	Needle Bar Connecting Bracket Clamping Screw.....
42055	5544	Needle Bar Connecting Link.....
40247	5544	" " " " Hinge Pin
223F	5544	" " " " " " " " Set Screw for 42061.....
904c	5544	Needle Bar Connecting Link Hinge Pin Set Screw for 42104.....
42057	5544	Needle Bar Connecting Rod with 42059, 42076 and four 896E.....
*42076	—	Needle Bar Connecting Rod Cap (lower)
896E	7396	" " " " " " " " Screw.....
*42059	—	Needle Bar Connecting Rod Cap (upper)
896E	7396	" " " " " " " " Screw.....
42077	5584	Needle Bar Connecting Rod Guide.....
171F	5544	" " " " " " Screw
42103	5544	" " Crank (back) with 1258c and two 1259c.....
42074	5553	Needle Bar Crank (back) Ball Stud.....
1259c	5553	" " " " " " " " Set Screw.....
1259c	5553	Needle Bar Crank (back) Position Screw
1258c	5544	" " " " " " Set Screw.....
42104	5544	" " " " (front) with 904c, 1258c and 1259c.....

NO.	PLATE	NAME
1259c	5553	Needle Bar Crank (front) Position Screw
1258c	5544	" " " " " " Set Screw.....
42105	5544	" " " " " " Shaft.....
42487	7396	" " " " " " Bushing.....
624c	7396	" " " " " " Set Screw
42115	5544	" " " " " " Thread Retainer Bracket...
228J	5544	" " " " " " " " Screw
42483	7396	" " " " " " Disc.....
93c	5544	" " " " " " Screw.....
10107	5544	" " " " " " Spring.....
1728c	7380	" Clamping Nut.....
42066	5544	" Guard.....
171F	5544	" " " " " " Screw.....
42288	7397	Presser Foot Chaining-off Finger.....
233J	5530	" " " " " " Screw..
42405	—	" " " " " " Plate (back).....
9320	5585	" " " " " " Hinge Pin....
14058	5585	" " " " " " Spring.....
42160	5585	" " " " " " Adjusting Pin.....
464c	5587	Presser Foot Plate (back) Spring Adjusting Pin Set Screw.....
42263	—	Presser Foot Plate (front).....
42461	7397	" " " " " " Hinge Pin....
42264	—	" " " " " " Shank.....
42420	7397	Presser Foot (spring hinged) complete, Nos. 233J, 464c, 9320, 14058, 42160, 42263, 42264, 42288, 42405 and 42461..
1324c	5545	Presser Foot Screw.....
39541	5545	" " " " " " Washer.....
42069	5545	" " " " " " Lever.....
42376	—	" " " " " " 42069 with 42045.....
42045	5545	" " " " " " Hinge Stud.....
1120c	5545	" " " " " " Set Screw.....
42070	5584	" " " " " " Lifter.....
85D	5584	" " " " " " Hinge Screw.....
1377c	5584	" " " " " " Screw Stud (eccentric)....
1547J	5584	" " " " " " Nut.....
42071	5584	" " " " " " Spring.....
1378D	5584	Pressure Regulating Thumb Screw.....
42427	7398	Spreader.....
197J	5553	" " " " " " Screw.....
2102	5585	Tension (looper, left hand) Disc.....
1560c	5585	" " " " " " Regulating Thumb Nut.....

NO.	PLATE	NAME
828c	5585	Tension (looper, left hand) Screw Stud
42418	—	“ “ “ “ “ “
		828c with 1560c.....
42121	7380	Tension (looper, left hand) Spring.....
2102	5585	“ (looper, right hand) Disc.....
1560c	5585	“ “ “ “ Regulating
		Thumb Nut.....
828c	5585	Tension (looper, right hand) Screw Stud
42418	—	“ “ “ “ “ “
		828c with 1560c.....
10148	5585	Tension (looper, right hand) Spring.....
17547	5585	“ “ “ “ Thread
		Guide.....
2102	5585	Tension (needle thread) Disc.....
1560c	5585	“ “ “ “ Regulating
		Thumb Nut.....
916c	5585	Tension (needle thread) Screw Stud.....
44209	—	“ “ “ “ “ 916c
		with 1560c.....
10148	5585	Tension (needle thread) Spring.....
42082	5585	“ “ “ Thread Guide...
42242	7396	Thread (looper, left hand) Eyelet.....
233J	5530	“ “ “ “ “ Screw.
42081	5585	“ “ “ “ Tube.....
462c	5544	“ “ “ “ “ Set Screw
42126	7380	“ (looper, right hand) Pull-off.....
42093	5585	“ “ “ “ Staple.....
190J	5557	“ “ “ “ “ Screw
42127	5585	“ “ “ “ Take-up....
197F	5553	“ “ “ “ “ Screw
42096	5585	“ (needle) Eyelet.....
217F	5585	“ “ “ Screw.....
42128	7398	“ “ Take-up.....
197F	5553	“ “ “ Screw.....
42415	7399	Throat Plate for 42421 and 42422.....
742F	5587	“ “ “ Screw.....

**Genuine Singer Needles should be used  
in this machine.  
Their containers are marked with the  
Company's Trade Mark "SIMANCO." 1**

**Needles in Containers marked  
"For Singer Machines"  
are not Singer made needles. 2**

## LIST OF PARTS COMPLETE FOR

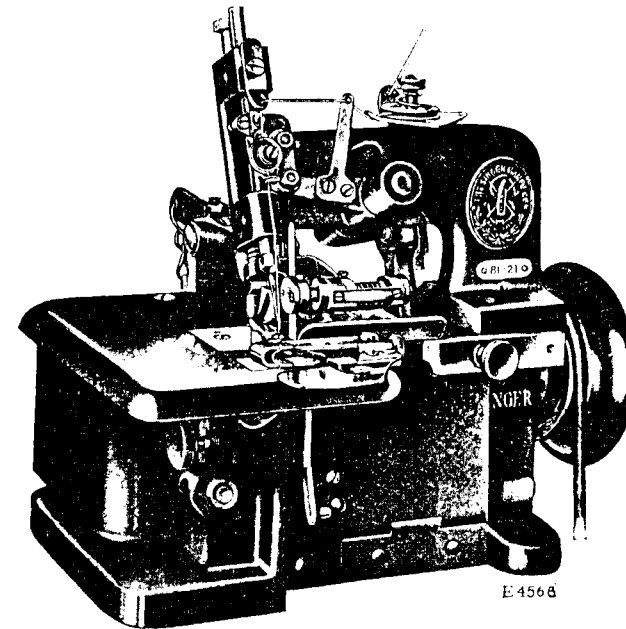

## MACHINE No. 81-21

**FOR TRIMMING, OVEREDGING AND BLIND STITCH HEMMING  
OR WELTING ON UNDERWEAR MADE OF SILK, LISLE  
THREAD, ETC. HAS AUXILIARY FEED TO PREVENT  
FULLING THE EDGES WHILE STITCHING. BIGHT  $\frac{1}{16}$  INCH.  
TWO-THREAD STITCH. FOOT LIFTER.**

NO.	PLATE	NAME
*42484	—	Arm with two each 462c, 624c, 42253 and 42487.....
4389	5585	Arm Dowel Pin.....
949E	5587	“ Screw.....
42001	5576	Balance Wheel, 2 $\frac{3}{16}$ in. pulley, with 424c and 1354c.....
1354c	5587	Balance Wheel Position Screw.....
424c	5587	“ “ Set Screw.....
*42145	5577	Cloth Plate.....

NO.	PLATE	NAME
42146	—	Cloth Plate complete, Nos. 42003, 42005, 42108, 42145, two 236c and five 229E..
42003	5577	Cloth Plate Extension (lower).....
229E	5587	" " " " Screw....
42108	5577	" " " (upper).....
229E	5587	" " " " Screw....
1437D	5587	" " Hinge Screw.....
1655J	5587	" " " " Nut.....
42005	5526	" " Lock Spring.....
236c	5587	" " " " Screw.....
42147	7376	Feed (back) Bar.....
61c	7376	" " " Hinge Screw.....
42148	7376	" " Connecting Link.....
1132c	7376	" " " " Hinge Screw
42421	7399	" " Dog, fine teeth, for silk work
203c	5587	" " " Screw.....
42150	5557	" " Regulator.....
1132c	5557	" " " Hinge Screw.....
190J	5557	" " " Set Screw.....
1444c	5557	" " " Thumb Screw....
42151	5557	" (front) Bar with 1253c.....
42007	5529	" " " Hinge Pin.....
1253c	5587	" " " " " Set Screw...
42008	5529	" " Connecting Rod with 42009 and two 1057E.....
*42009	—	Feed (front) Connecting Rod Cap.....
1057E	5529	" " " " " Screw
1373c	5529	" " " " " H i n g e Screw.....
1520c	5529	Feed (front) Connecting Rod Hinge Screw Nut.....
42422	7399	Feed (front) Dog, fine teeth, for silk work.....
190J	5557	Feed (front) Dog Screw.....
42011	5529	" " Eccentric with two 453c....
42153	5577	" " " Cover.....
207F	5529	" " " " Screw.....
453c	5529	" " " Set Screw.....
42012	5529	" " Lifting Eccentric with two 462c.....
42013	5529	Feed (front) Lifting Eccentric Connection.....
462c	5544	Feed (front) Lifting Eccentric Set Screw.
1374c	5530	" " Regulating Screw Stud....
1680c	5530	" " " " " Nut
42290	5530	" " " " " Washer.....

NO.	PLATE	NAME
42014	5530	Feed (front) Regulator with 233J and two 1259c.....
42015	5529	Feed (front) Regulator Connection with 1012E.....
1012E	5529	Feed (front) Regulator Connection Adjusting Screw.....
1373c	5529	Feed (front) Regulator Connection Hinge Screw.....
1520c	5529	Feed (front) Regulator Connection Hinge Screw Nut.....
42016	5530	Feed (front) Regulator Hinge Stud.....
42017	5529	" " " " Indicator.....
42018	5530	" " " " " Plate
337J	5530	" " " " " " Screw.....
207F	5587	Feed (front) Regulator Indicator Screw..
1259c	5530	" " " " Set Screw.....
233J	5530	" " " " Stop Screw.....
42154	7376	" " Rock Shaft.....
42155	—	Feed (front) Rock Shaft complete, Nos. 42021 and 42154.....
42021	5530	Feed (front) Rock Shaft Crank with 157E.....
157E	5530	Feed (front) Rock Shaft Crank Clamping Screw.....
42098	5530	Feed (front) Rock Shaft Hinge Pin.....
42079	5530	" " " " " " Bushing.....
1036c	5530	Feed (front) Rock Shaft Hinge Pin Bushing Set Screw.....
*42022	—	Frame.....
42023	5576	" Rotary Shaft.....
42024	5576	" " " Bushing (front)....
1036c	5530	" " " " " Set Screw.....
42025	5553	Frame Rotary Shaft Crank with 1259c and 1375c.....
1375c	5553	Frame Rotary Shaft Crank Position Screw.....
1259c	5553	Frame Rotary Shaft Crank Set Screw...
42026	5576	" " " Flanged Bushing (back) with 54967.....
54967	5585	Frame Rotary Shaft Flanged Bushing (back) Oil Pad (braided cotton).....
1036c	5530	Frame Rotary Shaft Flanged Bushing (back) Set Screw.....



NO.	PLATE	NAME
171E	5544	Looper (right hand) and Spreader Lever Connection Guide Screw.....
42106	5584	Looper (right hand) and Spreader Lever Connection Oil Tube and Bracket with 29599.....
29599	5584	Looper (right hand) and Spreader Lever Connection Oil Tube Packing (felt)...
42078	5584	Looper (right hand) and Spreader Lever Hinge Pin.....
42079	5530	Looper (right hand) and Spreader Lever Hinge Pin Bushing.....
1259c	5553	Looper (right hand) and Spreader Lever Hinge Pin Bushing Set Screw.....
197J	5553	Looper (right hand) Screw.....
42054	5544	Needle Bar.....
42253	5544	" " Bushing.....
462c	5544	" " " Set Screw.....
42061	5544	" " Connecting Bracket with 187E and 223F.....
187E	5544	Needle Bar Connecting Bracket Clamping Screw.....
42055	5544	Needle Bar Connecting Link.....
40247	5544	" " " " Hinge Pin
223F	5544	" " " " " "
		Set Screw for 42061.....
904c	5544	Needle Bar Connecting Link Hinge Pin Set Screw for 42104.....
42057	5544	Needle Bar Connecting Rod with 42059, 42076 and four 896E.....
*42076	---	Needle Bar Connecting Rod Cap (lower)
896E	7396	" " " " " "
		Screw.....
*42059	---	Needle Bar Connecting Rod Cap (upper)
896E	7396	" " " " " "
		Screw.....
42077	5584	Needle Bar Connecting Rod Guide.....
171F	5544	" " " " " Screw
42103	5544	Needle Bar Crank (back) with 1258c and two 1259c.....
42074	5553	Needle Bar Crank (back) Ball Stud.....
1259c	5553	" " " " " " Set
		Screw.....
1259c	5553	Needle Bar Crank (back) Position Screw
1258c	5544	" " " " Set Screw.....
42104	5544	" " " (front) with 904c, 1258c and 1259c.....
1259c	5553	Needle Bar Crank (front) Position Screw

NO.	PLATE	NAME
1258c	5544	Needle Bar Crank (front) Set Screw.....
42105	5544	" " " Shaft.....
42487	7396	" " " " Bushing.....
624c	7396	" " " " " Set Screw
42115	5544	" " Thread Retainer Bracket....
228J	5544	" " " " " Screw
42483	7396	" " " " Disc.....
93c	5544	" " " " Screw.....
10107	5544	" " " " Spring.....
1728c	7380	" Clamping Nut.....
42066	5544	" Guard.....
171F	5544	" " Screw.....
42449	7402	Presser Foot Chaining-off Finger.....
233J	5530	" " " " " Screw..
42405	---	" " Plate (back).....
9320	5585	" " " " Hinge Pin....
14058	5585	" " " " Spring.....
42160	5585	" " " " " Adjust-
		ing Pin.....
464c	5587	Presser Foot Plate (back) Spring Adjust-
		ing Pin Set Screw.....
42450	---	Presser Foot Plate (front).....
42461	7397	" " " " Hinge Pin....
42264	---	" " Shank.....
42451	7402	Presser Foot (spring hinged) complete, Nos. 233J, 464c, 9320, 14058, 42160, 42264, 42405, 42449, 42450 and 42461
1324c	5545	Presser Foot Screw.....
39541	5545	" " " Washer.....
42069	5545	" Lever.....
42376	---	" " 42069 with 42045.....
42045	5545	" " Hinge Stud.....
1120c	5545	" " " " Set Screw.....
42070	5584	" " Lifter.....
85D	5584	" " " Hinge Screw.....
1377c	5584	" " Screw Stud (eccentric)....
1547J	5584	" " " " Nut.....
42071	5584	" " Spring.....
1378D	5584	Pressure Regulating Thumb Screw.....
42427	7398	Spreader.....
197J	5553	" Screw.....
2102	5585	Tension (looper, left hand) Disc.....
1560c	5585	" " " " Regulating
		Thumb Nut.....
828c	5585	Tension (looper, left hand) Screw Stud
42418	---	" " " " " "
		828c with 1560c.....

NO.	PLATE	NAME
42121	7380	Tension (looper, left hand) Spring.....
2102	5585	" (looper, right hand) Disc.....
1560c	5585	" " " " Regulating Thumb Nut.....
828c	5585	Tension (looper, right hand) Screw Stud
42418	-----	" " " " " "
		828c with 1560c.....
10148	5585	Tension (looper, right hand) Spring.....
17547	5585	" " " " Thread Guide
2102	5585	" (needle thread) Disc.....
1560c	5585	" " " " Regulating Thumb Nut.....
916c	5585	Tension (needle thread) Screw Stud.....
44209	-----	" " " " " " 916c with 1560c.....
10148	5585	Tension (needle thread) Spring.....
42082	5585	" " " " Thread Guide...
42242	7396	Thread (looper, left hand) Eyelet.....
233J	5530	" " " " " " Screw
42084	5585	" " " " " " Tube.....
462c	5544	" " " " " " Set Screw
42093	5585	" (looper, right hand) Staple.....
190J	5557	" " " " " " Screw
42127	5585	" " " " " " Take-up....
197F	5553	" " " " " " Screw
42096	5585	" (needle) Eyelet.....
217F	5585	" " " " " " Screw.....
42126	7380	" " " " " " Pull-off.....
42128	7398	" " " " " " Take-up.....
197F	5553	" " " " " " Screw.....
42468	7399	Throat Plate for 42421 and 42422.....
742F	5587	" " " " " " Screw.....
42488	7396	Welt Guide (solid).....
42441	-----	" " " " " " 42488 with 42440.....
42440	7400	" " " " " " Adjusting Slide.....
42442	7400	" " " " " " Holder.....
42443	-----	" " " " " " 42442 with 217B, 1117B, 1209c and 19044.....
42444	7400	Welt Guide Holder Extension with 42445
42445	7400	" " " " " " Stud.....
228B	5544	" " " " " " Screw.....
1209c	7400	" " " " " " Screw.....
19044	7400	" " " " " " Washer.....
1117B	7400	" " " " " " Regulating Thumb Screw...
217B	5585	" " " " " " Screw.....
42446	-----	Welt Guide complete, adjustable, from ½ in. to 1 in., Nos. 42441, 42443, 42444 and two 228B.....

## MACHINE BASE

NO.	PLATE	NAME
42086	5564	Machine Base with three wood screws 1¼ in. No. 12 and four each 935E, 4718, 42088 and 66707.....
4718	5586	Machine Base Cushion (felt).....
42088	5586	" " Cushion (felt).....
935E	5586	" " " " " " Screw.....
66707	7398	" " " " " " Washer.....

## ACCESSORIES

NO.	PLATE	NAME
1407E	5563	Machine Base Thumb Screw, for 3 in. table.....
1408E	5563	Machine Base Thumb Screw, for 2 in. table.....
14063	5586	Machine Base Thumb Screw Spring.....
9842	5586	" " " " " " Washer
120344	5566	Oiler (copper plated) with 120345.....
120345	5566	" Spout, 5 in. long.....
120440	5566	Screw Driver.....
42090	5566	Threading Wire.....
120341	5566	Tweezers (curved).....
68547	7396	Wrench for 1324, 1374, 1629 and 1728...
8908	5566	" " " " 1520 and 1655.....
4822	5566	" " " " 1547.....

## GUIDE (Hinged)

### FOR 81-20 MACHINE

NO.	PLATE	NAME
42434	7400	Guide with 19045.....
19045	5585	" Handle.....
42435	7400	" Holder.....
1425J	7400	" Hinge Screw.....
42436	7400	" " " " Friction Washer.....
42437	-----	Guide (hinged) complete, Nos. 1425J and 42434 to 42436.....
42288	7397	Presser Foot Chaining-off Finger.....
233J	5530	" " " " " " Screw..
42405	-----	" " " " " " Plate (back).....
9320	5585	" " " " " " Hinge Pin....
14058	5585	" " " " " " Spring.....
42160	5585	" " " " " " Adjust- ing Pin.....



NO.	PLATE	NAME
464c	5587	Presser Foot Plate (back) Spring Adjusting Pin Set Screw.....
42438	—	Presser Foot Plate (front).....
42461	7397	" " " " Hinge Pin....
42264	—	" " Shank.....
42439	7402	Presser Foot (spring hinged) complete for 42437, Nos. 233J, 464c, 9320, 14058, 42160, 42264, 42288, 42405, 42438 and 42461.....

## FOOT LIFTER PARTS

NO.	PLATE	NAME
6439	—	Chain, 36 in. to 45 in., with 56864 and 56865.....

NOTE: When ordering No. 6439, state length required.

4879	5566	Chain Connecting Link.....
56864	5566	" Hook (large).....
56865	7396	" " (small).....
42130	5586	Lifting Lever.....
42131	5586	" " Bracket.....
1229c	5586	" " " Screw.....
1301D	5586	" " Hinge Screw.....
42132	5586	" " Spring.....
1148F	5586	" " Stop Screw.....
1547J	5543	" " " " Nut.....
4881	5564	Treadle.....
4882	5566	" Shaft.....
4883	5566	" Spring.....
4884	5564	" Stand.....
4885	5564	Treadle complete, Nos. 4879, 4881 to 4884 and two wood screws 1 in. No. 10
42133	—	Foot Lifter complete, Nos. 1301D, 4885, 6439, 42130 to 42132 and two each 1148F, 1229c and 1547J.....

## KNEE LIFTER PARTS

NO.	PLATE	NAME
42130	5586	Lifting Lever.....
42131	5586	" " Bracket.....
1229c	5586	" " " Screw.....
42142	5564	" " Connecting Rod.....
1301D	5586	" " Hinge Screw.....
42132	5586	" " Spring.....

NO.	PLATE	NAME
1148F	5586	Lifting Lever Stop Screw.....
1547J	5543	" " " " Nut.....
2763	5564	Rock Shaft.....
12242	5564	" " Hanger with two wood screws 1 in. No. 10.....
2765	5564	Rock Shaft Knee Arm.....
2766	5564	" " " " Hub with 356c...
356c	5587	" " " " " Set Screw...
2768	—	Rock Shaft Knee Arm complete, Nos. 2765 to 2767.....
2767	5564	Rock Shaft Knee Plate with 356c.....
356c	5587	" " " " Set Screw.....
6337	5564	" " Lifting Bracket with two 356c.....
7125	5564	Rock Shaft Lifting Bracket Hook.....
356c	5587	" " " " " Set Screw
356c	5587	" " " " Set Screw...
2770	5564	" " Stop Dog with 356c.....
356c	5587	" " " " Set Screw.....
42143	5564	Rock Shaft complete, Nos. 2763, 2768, 6337, 7125 and two each 2770 and 12242.....
42144	—	Knee Lifter complete, Nos. 1301D, 42130 to 42132, 42142, 42143 and two each 1148F, 1229c and 1547J.....

## KNIFE GRINDER

NO.	PLATE	NAME
41326	5568	Emery Wheel.....
1508c	5569	" " Clamping Nut.....
41327	5568	" " Shaft.....
41328	5568	" " " Pulley with 1036c...
1036c	5569	" " " " Set Screw...
41513	5569	" " Washer.....
41329	5567	Frame with 1036c.....
878D	5569	" Oil Hole Stop Screw.....
41330	5568	Knife Holder with two 14222.....
150209	—	" " 41330 with 970D, 41331, 41332 and two each 313c, 771D, 1519J, 41333 and 41334.....
41331	5568	Knife Holder Bracket with 157E.....
157E	5569	" " " Clamping Screw...
42065	5569	" " " Hinge Stud.....
1036c	5569	" " " " " Set Screw.....

NO.	PLATE	NAME
717c	5569	Knife Holder Bracket Stop Screw.....
1520j	5569	" " " " " Nut...
41333	5569	" " Clamp.....
41334	5569	" " " Spring.....
14222	5569	" " " Steady Pin.....
771D	5569	" " " Thumb Screw.....
970D	5569	" " Regulating Thumb Screw..
313c	5569	" " Screw Center.....
1519j	5569	" " " " Nut.....
41332	5569	" " Spring.....
41335	---	Knife Grinder complete, Nos. 717c, 1508c, 1520j, 41326 to 41329, 42065, 150209, two each 878D, 41513 and three wood screws 1¼ in. No. 12.....

## THREAD UNWINDER

### FOR THREE SPOOLS

NO.	PLATE	NAME
225259	20778	Spool Rest (for one spool) with 201018c.
225257	20778	" " (for two spools) with 201018c
150203	---	" " Cushion (felt).....
225388	20778	" " Rod.....
200383c	7396	" " " Set Screw.....
201018c	7396	" " Set Screw.....
203490	20778	" Stand with 200383c.....
225391	20778	Thread Guide.....
201696j	7396	" " Lock Nut.....
225326	7396	" " Position Cup.....
225324	20778	" " Rod with 208E and 225322
208E	7396	" " " Screw.....
225322	7396	" " " Washer.....
*150057	---	" Separator.....
150058	20778	" " 150057 with 150059...
*150059	---	" " Bracket.....
150060	20778	" " " Arm with 164j and 9525.....
164j	---	Thread Separator Bracket Arm Clamping Screw.....
9525	---	Thread Separator Bracket Arm Clamping Screw Washer.....
164j	---	Thread Separator Bracket Screw.....
9525	---	" " " " Washer
150061	---	Thread Separator complete, Nos. 164j, 9525, 150058 and 150060.....

NO.	PLATE	NAME
150178	20778	Thread Unwinder complete, Nos. 150061, 201696j, 202490, 225257, 225259, 225324, 225326, 225388 and three each 150203, 225391 and wood screws 7/8 in. No. 12.
27739	7234	Thread Cone (wood) for large cones.....
225390	7234	" " Holder, for inverted cones.

NOTE: Nos. 27739 and 225390 are used with,  
but not included in 150178

## OBSOLETE PARTS

NO.	PLATE	NAME
*42251	---	Arm with two each 462c and 42253, for 81-20 and 81-21 Machines.....
*42252	---	Arm with two each 462c and 42253, for 81-9 Machine.....
42030	5543	Frame Top Cover Extension for 81-20 and 81-21 Machines.....
10106	5544	Needle Bar Thread Retainer Disc, super- seded by 42483.....
1629c	---	Needle Clamping Nut, superseded by 1728.....
42083	5553	Thread (looper, left hand) Eyelet, super- seded by 42242.....

Genuine Singer Needles should be used  
in this machine.  
Their containers are marked with the  
Company's Trade Mark "SIMANCO." 1

Needles in Containers marked  
"For Singer Machines"  
are not Singer made needles. 2

**Nos. 81-9, 81-20 and 81-21**  
**MACHINES**  
**FOR**  
**NUMERICAL LIST OF PARTS**

## NUMERICAL LIST OF PARTS

NO.	PLATE	NAME
61C	7376	Feed (back) Bar Hinge Screw.....
85D	5584	Presser Lever Lifter Hinge Screw.....
93C	5544	Needle Bar Thread Retainer Screw.....
133F	5542	Knife (movable) Holder Screw for 42113 and 42215.....
157E	5530	Feed (front) Rock Shaft Crank Clamp- ing Screw for 42021.....
157E	5569	Knife Grinder Knife Holder Bracket Clamping Screw for 41331.....
164J	----	Thread Unwinder Thread Separator Bracket Arm Clamping Screw for 150060.....
164J	----	Thread Unwinder Thread Separator Bracket Screw for 150061.....
171E	5544	Looper (right hand) and Spreader Lever Connection Guide Screw.....
171F	5544	Needle Bar Connecting Rod Guide Screw
171F	5544	" Guard Screw.....
175E	5542	Knife (movable) Lever Connection Cap Screw for 42043.....
176J	7376	Frame Top Cover Extension Screw for 42319 and 42324.....
176J	7376	Thread (looper, left hand) Nipper Spring Screw for 81-9 Machine.....
187E	5544	Needle Bar Connecting Bracket Clamp- ing Screw for 42061.....
190J	5557	Feed (back) Regulator Set Screw.....
190J	5557	" (front) Dog Screw.....
190J	5557	Thread (looper, right hand) Staple Screw
197J	5553	Looper (right hand) Screw.....
197J	5553	Spreader Screw.....
197F	5553	Thread (looper, right hand) Take-up Screw.....
197F	5553	Thread (needle) Take-up Screw.....
203C	5587	Feed (back) Dog Screw.....
207F	5529	" (front) Eccentric Cover Screw for 42319 and 42324.....
207F	5587	Feed (front) Regulator Indicator Screw..
208E	7396	Thread Unwinder Thread Guide Rod Screw for 225324.....
200H	5553	Looper (left hand) Set Screw for 42051..
217F	5585	Thread (needle) Eyelet Screw.....
217B	5585	Welt Guide Screw for 42443.....

NO.	PLATE	NAME
223F	5544	Needle Bar Connecting Link Hinge Pin Set Screw for 42061 and 42291.....
228J	5544	Needle Bar Thread Retainer Bracket Screw.....
228B	5544	Welt Guide Holder Extension Screw for 42446.....
229E	5587	Cloth Plate Extension (lower) Screw for 42146 and 42401.....
229E	5587	Cloth Plate Extension (upper) Screw for 42146 and 42401.....
233J	5530	Feed (front) Regulator Stop Screw for 42014.....
233J	5530	Presser Foot Chaining-off Finger Screw for 42406, 42420, 42439, 42451 and 132663.....
233J	5530	Thread (looper, left hand) Eyelet Screw.
233J	5530	“ “ “ “ Pull-off Screw for 81-9 Machine.....
236c	5587	Cloth Plate Lock Spring Screw for 42146 and 42401.....
283w	5543	Frame Top Cover Extension Holder Thumb Screw.....
313c	5569	Knife Grinder Knife Holder Screw Center for 150209.....
330w	5587	Frame Side Cover (left) Screw.....
330w	5587	“ “ “ (right) Screw.....
336F	5542	Knife (movable) Holder Guide Set Screw for 42038.....
337J	5530	Feed (front) Regulator Indicator Plate Screw.....
356c	5587	Rock Shaft Knee Arm Hub Set Screw for 2766.....
356c	5587	Rock Shaft Knee Plate Set Screw for 2767.....
356c	5587	Rock Shaft Lifting Bracket Hook Set Screw for 6337.....
356c	5587	Rock Shaft Lifting Bracket Set Screw for 6337.....
356c	5587	Rock Shaft Stop Dog Set Screw for 2770
404E	5542	Knife (movable) Holder Cap Screw for 42113 and 42215.....
424c	5587	Balance Wheel Set Screw for 42001.....
440F	5543	Knife (stationary) Holder Stop Screw..
453c	5529	Feed (front) Eccentric Set Screw for 42011.....
462c	5544	Feed (front) Lifting Eccentric Set Screw for 42012 and 42208.....

NO.	PLATE	NAME
462c	5544	Thread (looper, left hand) Tube Set Screw.....
462c	5544	Needle Bar Bushing Set Screw for 42251, 42252, 42484 and 42485.....
464c	5587	Presser Foot Spring Adjusting Pin Set Screw for 42406 and 132663.....
464c	5587	Presser Foot Plate (back) Spring Adjusting Pin Set Screw for 42420, 42439 and 42451.....
621D	5512	Knife (movable) Holder Guide Plate Screw.....
624c	7396	Needle Bar Crank Shaft Bushing Set Screw for 42484 and 42485.....
717c	5569	Knife Grinder Knife Holder Bracket Stop Screw for 41335.....
742F	5587	Frame Top Cover Screw.....
742F	5587	Throat Plate Screw.....
771D	5569	Knife Grinder Knife Holder Clamp Thumb Screw for 150209.....
828c	5585	Tension (looper, left hand) Screw Stud for 42418.....
828c	5585	Tension (looper, right hand) Screw Stud for 42418.....
878D	5569	Knife Grinder Frame Oil Hole Stop Screw for 41335.....
896E	7396	Looper (right hand) and Spreader Lever Connection Cap (lower) Screw for 42075.....
896E	7396	Looper (right hand) and Spreader Lever Connection Cap (upper) Screw for 42075.....
896E	7396	Needle Bar Connecting Rod Cap (lower) Screw for 42057.....
896E	7396	Needle Bar Connecting Rod Cap (upper) Screw for 42057.....
904c	5514	Needle Bar Connecting Link Hinge Pin Set Screw for 42104.....
916c	5585	Tension (needle thread) Screw Stud for 44209.....
935E	5586	Machine Cushion Screw for 42086.....
919E	5587	Arm Screw.....
970D	5569	Knife Grinder Knife Holder Regulating Thumb Screw for 150209.....
1012E	5529	Feed (front) Regulator Connection Adjusting Screw for 42015.....
1036c	5530	Feed (front) Rock Shaft Hinge Pin Bushing Set Screw.....

NO.	PLATE	NAME
1036c	5530	Frame Rotary Shaft Bushing (front) Set Screw.....
1036c	5530	Frame Rotary Shaft Crank Set Screw for 42110 and 42211.....
1036c	5530	Frame Rotary Shaft Flanged Bushing (back) Set Screw.....
1036c	5569	Knife Grinder Emery Wheel Shaft Pulley Set Screw for 41328.....
1036c	5569	Knife Grinder Knife Holder Bracket Hinge Stud Set Screw for 41329.....
1036c	5553	Looper (left hand) Lever Hinge Stud Set Screw.....
1057E	5529	Feed (front) Connecting Rod Cap Screw for 42008.....
1057E	5553	Needle Bar Connecting Bracket Clamping Screw for 42291.....
1101c	5543	Knife (stationary) Holder Screw.....
1117B	7400	Welt Guide Regulating Thumb Screw for 42443.....
1120c	5545	Presser Lever Hinge Stud Set Screw.....
1132c	7376	Feed (back) Connecting Link Hinge Screw.....
1132c	5557	Feed (back) Regulator Hinge Screw.....
1148F	5586	Lifting Lever Stop Screw for 42133 and 42144.....
1209c	7400	Welt Guide Holder Screw for 42443.....
1229c	5542	Knife (movable) Lever Hinge Stud Set Screw.....
1229c	5586	Lifting Lever Bracket Screw for 42133 and 42144.....
1253c	5587	Feed (front) Bar Hinge Pin Set Screw for 42151.....
1258c	5544	Needle Bar Crank (back) Set Screw for 42103.....
1258c	5544	Needle Bar Crank (front) Set Screw for 42104.....
1259c	5530	Feed (front) Regulator Set Screw for 42014.....
1259c	5553	Frame Rotary Shaft Crank Set Screw for 42025.....
1259c	5553	Looper (right hand) and Spreader Lever Ball Stud Set Screw for 42073.....
1259c	5553	Looper (right hand) and Spreader Lever Hinge Pin Bushing Set Screw.....
1259c	5553	Needle Bar Crank (back) Ball Stud Set Screw for 42103.....

NO.	PLATE	NAME
1259c	5553	Needle Bar Crank (back) Position Screw for 42103.....
1259c	5553	Needle Bar Crank (front) Position Screw for 42104.....
1301D	5586	Lifting Lever Hinge Screw for 42133 and 42144.....
1324c	5545	Presser Foot Screw.....
1354c	5587	Balance Wheel Position Screw for 42001
1373c	5529	Feed (front) Connecting Rod Hinge Screw.....
1373c	5529	Feed (front) Regulator Connection Hinge Screw.....
1373c	5542	Knife (movable) Lever Connection Hinge Screw.....
1374c	5530	Feed (front) Regulating Screw Stud.....
1375c	5553	Frame Rotary Shaft Crank Position Screw for 42025, 42110 and 42211.....
1376c	5543	Knife (stationary) Holder Regulating Thumb Screw.....
1377c	5584	Presser Lever Screw Stud (eccentric).....
1378D	5584	Pressure Regulating Thumb Screw.....
1407E	5563	Machine Base Thumb Screw, for 3 in. table (Accessories).....
1408E	5563	Machine Base Thumb Screw, for 2 in. table (Accessories).....
1425J	7400	Guide Hinge Screw for 42437.....
1437D	5587	Cloth Plate Hinge Screw.....
1444c	5557	Feed (back) Regulator Thumb Screw.....
1508c	5569	Knife Grinder Emery Wheel Clamping Nut for 41335.....
1519J	5569	Knife Grinder Holder Screw Center Nut for 150209.....
1520c	5529	Feed (front) Connecting Rod Hinge Screw Nut.....
1520c	5529	Feed (front) Regulator Connection Hinge Screw Nut.....
1520J	5569	Knife Grinder Knife Holder Bracket Stop Screw Nut for 41335.....
1520c	5542	Knife (movable) Lever Connection Hinge Screw Nut.....
1520c	5529	Looper (left hand) Lever Connecting Link Hinge Screw Nut.....
1534D	5543	Knife (stationary) Clamping Stud Thumb Nut.....
1547J	5543	Knife (stationary) Holder Stop Screw Nut.....

NO.	PLATE	NAME
1547J	5543	Lifting Lever Stop Screw Nut for 42133 and 42144.....
1547J	5584	Presser Lever Screw Stud Nut.....
1560c	5585	Tension (looper, left hand) Regulating Thumb Nut for 42418.....
1560c	5585	Tension (looper, right hand) Regulating Thumb Nut for 42418.....
1560c	5585	Tension (needle thread) Regulating Thumb Nut for 44209.....
1629c	—	Needle Clamping Nut, obsolete, superseded by 1728.....
1655J	5587	Cloth Plate Hinge Screw Nut.....
1680c	5530	Feed (front) Regulating Screw Stud Nut.....
1728c	7380	Needle Clamping Nut.....
2102	5585	Tension (looper, left hand) Disc.....
2102	5585	" (looper, right hand) Disc.....
2102	5585	" (needle thread) Disc.....
2103	7380	" " " Spring for 81-9 Machine.....
2749	5543	Frame Top Cover Extension Holder Thumb Screw Washer.....
2763	5564	Rock Shaft for 42143.....
Nos. 2765 TO 2767 FOR 2768		
2765	5564	Rock Shaft Knee Arm.....
2766	5564	" " " Hub with 356c....
2767	5564	" " " Plate with 356c.....
2768	—	Rock Shaft Knee Arm complete for 42143 Nos. 2765 to 2767.....
2770	5564	Rock Shaft Stop Dog with 356c, for 42143
4389	5585	Arm Dowel Pin.....
4718	5586	Machine Base Cushion (felt) for 42086..
4822	5566	Wrench for 1547 (Accessories).....
4879	5566	Chain Connecting Link for 4885.....
Nos. 4881 TO 4884 FOR 4885		
4881	5564	Treadle.....
4882	5566	" Shaft.....
4883	5566	" Spring.....
4884	5564	" Stand.....
4885	5564	Treadle complete for 42133, Nos. 4879, 4881 to 4884 and two wood screws 1 in. No. 16.....
6337	5564	Rock Shaft Lifting Bracket with two 356c, for 42143.....
6439	—	Chain, 36 in. to 45 in., with 56864 and 56865, for 42133.....

NO.	PLATE	NAME
7125	5564	Rock Shaft Lifting Bracket Hook for 42143.....
8908	5566	Wrench for 1520 and 1655 (Accessories)
9320	5585	Presser Foot Hinge Pin for 42406 and 132663.....
9320	5585	Presser Foot Plate (back) Hinge Pin for 42420, 42439 and 42451.....
9525	—	Thread Unwinder Thread Separator Bracket Arm Clamping Screw Washer for 150061.....
9525	—	Thread Unwinder Thread Separator Bracket Screw Washer for 150061.....
9842	5586	Machine Base Thumb Screw Spring Washer (Accessories).....
10106	5544	Needle Bar Thread Retainer Disc, obsolete, superseded by 42483.....
10107	5544	Needle Bar Thread Retainer Spring.....
10148	5585	Tension (looper, right hand) Spring.....
10148	5585	Tension (needle thread) Spring for 81-20 and 81-24 Machines.....
12242	5564	Rock Shaft Hanger with two wood screws 1 in. No. 10, for 42143.....
14058	5585	Presser Foot Spring for 42406 and 132663
14058	5585	" " Plate (back) Spring for 42420, 42439 and 42451.....
14063	5586	Machine Base Thumb Screw Spring (Accessories).....
14222	5569	Knife Grinder Knife Holder Clamp Steady Pin for 41330.....
17547	5585	Tension (looper, right hand) Thread Guide.....
19044	7400	Welt Guide Holder Screw Washer for 42143.....
19045	5585	Frame Side Cover (left) Handle for 42027
19045	5585	Guide Handle for 42134.....
27739	7234	Thread Unwinder Thread Cone (wood) for large cones, for 225397.....
29599	5584	Looper (right hand) and Spreader Lever Connection Oil Tube Packing (felt) for 42106 and 42403.....
38534	7380	Needle Bar (hollow) for 81-9 Machine...
39541	5545	Presser Foot Screw Washer.....
40247	5544	Needle Bar Connecting Link Hinge Pin..
Nos. 41326 TO 41329 FOR 41335		
41326	5568	Knife Grinder Emery Wheel.....
41327	5568	" " " " Shaft.....

NO.	PLATE	NAME
41328	5568	Knife Grinder Emery Wheel Shaft Pulley with 1036c.....
41329	5567	Knife Grinder Frame with 1036c.....
		Nos. 41330 to 41334 FOR 150209
41330	5568	Knife Grinder Knife Holder with two 14222.....
41331	5568	Knife Grinder Knife Holder Bracket with 157E.....
41332	5569	Knife Grinder Knife Holder Spring.....
41333	5569	" " " " Clamp.....
41334	5569	" " " " " Spring
41335	—	Knife Grinder complete, Nos. 717c, 1508c, 1520r, 41326 to 41329, 42065, 150209, two each 878b, 41513 and three wood screws 1¼ in. No. 12.....
41513	5569	Knife Grinder Emery Wheel Washer for 41335.....
42001	5576	Balance Wheel, 2 1/8 in. pulley, with 424c and 1354c.....
42002	5526	Cloth Plate for 42401.....
42003	5577	" " Extension (lower) for 42146.
42005	5526	" " Lock Spring for 42146 and 42401.....
42007	5529	Feed (front) Bar Hinge Pin.....
42008	5529	" " Connecting Rod with 42009 and two 1057E.....
*42009	—	Feed (front) Connecting Rod Cap for 42008.....
42011	5529	Feed (front) Eccentric with two 453c....
42012	5529	" " Lifting Eccentric with two 462c, for 81-20 and 81-21 Machines....
42013	5529	Feed (front) Lifting Eccentric Connection
42014	5530	" " Regulator with 233r and two 1259c.....
42015	5529	Feed (front) Regulator Connection with 1012E.....
42016	5530	Feed (front) Regulator Hinge Stud.....
42017	5529	" " " " Indicator.....
42018	5530	" " " " " Plate...
42021	5530	" " Rock Shaft Crank with 157E, for 42155.....
*42022	—	Frame for 81-20 and 81-21 Machines....
42023	5576	" Rotary Shaft for 81-20 and 81-21 Machines.....
42024	5576	Frame Rotary Shaft Bushing (front) ..
42025	5553	" " " " Crank with 1259c and 1375c, for 81-21 Machine.....

NO.	PLATE	NAME
42026	5576	Frame Rotary Shaft Flanged Bushing (back) with 54967.....
42027	7375	Frame Side Cover (left) with 19045.....
42028	5526	" " " (right) hinged.....
42029	5576	" Top Cover.....
42030	5543	" " " Extension for 81-20 and 81-21 Machines, obsolete.....
42035	5542	Knife (movable) Holder for 42113 and 42215.....
42037	5542	Knife (movable) Holder Cap for 42113..
42038	5542	" " " Guide with 336F
42039	5542	" " " " Plate.....
42040	5542	" " " Screw Extension Pin for 42113 and 42215.....
42041	5542	Knife (movable) Holder Spring.....
42042	5542	" " Lever.....
42043	5542	" " " Connection with 42044 and two 175E.....
*42044	—	Knife (movable) Lever Connection Cap for 42043.....
42045	5542	Knife (movable) Lever Hinge Stud.....
42045	5545	Presser Lever Hinge Stud for 42376 and 42377.....
42046	5543	Knife (stationary) with 42049.....
42048	5543	" " Clamping Stud.....
42049	5543	" " Stud for 42046.....
42050	5553	Looper (left hand) for 81-20 and 81-21 Machines.....
42051	5553	Looper (left hand) Lever with 209H....
42052	5553	" " " " Connecting Link.....
42053	5553	Looper (left hand) Lever Hinge Stud....
42054	5544	Needle Bar for 81-20 and 81-21 Machines.....
42055	5544	Needle Bar Connecting Link.....
42057	5544	" " " Rod with 42059, 42076 and four 896E.....
*42059	—	Looper (right hand) and Spreader Lever Connection Cap (upper) for 42075....
*42059	—	Needle Bar Connecting Rod Cap (upper) for 42057.....
42061	5544	Needle Bar Connecting Bracket with 187E and 223F, for 81-20 and 81-21 Machines.....
42065	5569	Knife Grinder Knife Holder Bracket Hinge Stud for 41335.....
42066	5544	Needle Guard.....

NO.	PLATE	NAME
42069	5545	Presser Lever for 42376.....
42070	5584	“ “ Lifter.....
42071	5584	“ “ Spring.....
42073	5553	Looper (right hand) and Spreader Lever with 1259c.....
42074	5553	Looper (right hand) and Spreader Lever Ball Stud for 81-20 and 81-21 Machines.....
42074	5553	Needle Bar Crank (back) Ball Stud.....
42075	5553	Looper (right hand) and Spreader Lever Connection with 42059, 42076 and four 896E.....
*42076	—	Looper (right hand) and Spreader Lever Connection Cap (lower) for 42075.....
*42076	—	Needle Bar Connecting Rod Cap (lower) for 42057.....
42077	5584	Looper (right hand) and Spreader Lever Connection Guide.....
42077	5584	Needle Bar Connecting Rod Guide.....
42078	5584	Looper (right hand) and Spreader Lever Hinge Pin.....
42079	5530	Feed (front) Rock Shaft Hinge Pin Bushing.....
42079	5530	Looper (right hand) and Spreader Lever Hinge Pin Bushing.....
42082	5585	Tension (needle thread) Thread Guide.....
42083	5553	Thread (looper, left hand) Eyelet, obsolete, superseded by 42242.....
42084	5585	Thread (looper, left hand) Tube.....
42086	5564	Machine Base with three wood screws 1¼ in. No. 12 and four each 935E, 4718, 42088 and 66707.....
42088	5586	Machine Cushion (felt) for 42086.....
42090	5566	Threading Wire (Accessories).....
42093	5585	Thread (looper, right hand) Staple.....
42096	5585	“ (needle) Eyelet.....
42098	5530	Feed (front) Rock Shaft Hinge Pin.....
42101	5543	Frame Side Cover (right) Lock Spring for 42319 and 42324.....
42102	5543	Frame Top Cover Extension Holder for 42319 and 42324.....
42103	5544	Needle Bar Crank (back) with 1258c and two 1259c.....
42104	5544	Needle Bar Crank (front) with 904c, 1258c and 1259c.....
42105	5544	Needle Bar Crank Shaft.....

NO.	PLATE	NAME
42106	5584	Looper (right hand) and Spreader Lever Connection Oil Tube and Bracket with 29599, for 81-20 and 81-21 Machines.....
42108	5577	Cloth Plate Extension (upper) for 42146 and 42401.....
42110	7396	Frame Rotary Shaft Crank with 1036c and 1375c, for 81-20 Machine.....
42111	5542	Knife (movable) for 81-20 and 81-21 Machines.....
42112	5542	Knife (movable) Gib for 42113.....
42113	—	“ “ Holder 42035 with 133E, 42037, 42040, 42112 and two 404E, for 81-20 and 81-21 Machines.....
42115	5544	Needle Bar Thread Retainer Bracket.....
42121	7380	Tension (looper, left hand) Spring.....
Nos. 42122 TO 42125 FOR 81-9 MACHINE		
42122	7380	Thread (looper, left hand) Nipper Spring (lower).....
42123	7380	Thread (looper, left hand) Nipper Spring (upper).....
42124	7380	Thread (looper, left hand) Pull-off.....
42125	7380	“ “ “ “ Eyelet.....
42126	7380	“ (looper, right hand) Pull-off for 81-9 and 81-20 Machines.....
42126	7380	Thread (needle) Pull-off for 81-21 Machine.....
42127	5585	Thread (looper, right hand) Take-up.....
42128	7398	“ (needle) Take-up.....
Nos. 42130 TO 42132 FOR 42133 AND 42144		
42130	5586	Lifting Lever.....
42131	5586	“ “ Bracket.....
42132	5586	“ “ Spring.....
42133	—	Foot Lifter complete, Nos. 1301D, 4885, 6439, 42130 to 42132 and two each 1148F, 1229c and 1547J.....
42142	5564	Lifting Lever Connecting Rod for 42144
42143	5564	Rock Shaft complete for 42144, Nos. 2763, 2768, 6337, 7125 and two each 2770 and 12242.....
42144	—	Knee Lifter complete, Nos. 1301D, 42130 to 42132, 42142, 42143 and two each 1148F, 1229c and 1547J.....
*42145	5577	Cloth Plate for 42146.....



NO.	PLATE	NAME
42146	—	Cloth Plate complete for 81-20 and 81-21 Machines, Nos. 42003, 42005, 42108, 42145, two 236c and five 229E.....
42147	7376	Feed (back) Bar.....
42148	7376	" " Connecting Link.....
42149	7397	" " Dog, 3 teeth (16 teeth to the inch) for 42407, for 81-9 Machine.....
42150	5557	Feed (back) Regulator.....
42151	5557	" (front) Bar with 1253c.....
42153	5577	" " Eccentric Cover for 42324..
42154	7376	" " Rock Shaft for 42155.....
42155	—	Feed (front) Rock Shaft complete, Nos. 42021 and 42154.....
42156	5545	Knife (stationary) Holder.....
42157	—	Presser Foot Body for 42406 and 132663
42160	5585	" " Plate (back) Spring Adjusting Pin for 42420, 42439 and 42451
42160	5585	Presser Foot Spring Adjusting Pin for 42406 and 132663 .....
42166	5553	Looper (right hand) for 81-20 and 81-21 Machines.....
42208	7376	Feed (front) Lifting Eccentric with two 462c, for 81-9 Machine.....
*42209	—	Frame for 81-9 Machine.....
42211	7380	" Rotary Shaft Crank with 1036c and 1375c, for 81-9 Machine.....
42212	7376	Frame Top Cover Extension for 42319..
42213	7398	Knife (movable) for 81-9 Machine.....
42214	7398	" " Gib for 42215.....
42215	—	" " Holder 42035 with 133E, 42040, 42214, 42216 and two 404E, for 81-9 Machine.....
42216	7398	Knife (movable) Holder Cap for 42215..
42219	7380	Looper (left hand) for 81-9 Machine....
42220	7380	" (right hand) for 81-9 Machine...
42221	7380	" " " and Spreader Lever Ball Stud for 81-9 Machine.....
42227	7375	Presser Lever for 42377.....
42242	7396	Thread (looper, left hand) Eyelet.....
42250	7380	Spreader for 81-9 Machine.....
*42251	—	Arm with two each 462c and 42253, for 81-20 and 81-21 Machines, obsolete..
*42252	—	Arm with two each 462c and 42253, for 81-9 Machine, obsolete.....
42253	5544	Needle Bar Bushing for 42251, 42252, 42484 and 42485.....

NO.	PLATE	NAME
42263	—	Presser Foot Plate (front) for 42420.....
42264	—	" " Shank for 42420, 42439 and 42451.....
42266	7375	Frame Rotary Shaft for 81-9 Machine
42288	7397	Presser Foot Chaining-off Finger for 42420 and 42439.....
42290	5530	Feed (front) Regulating Screw Stud Nut Washer.....
42291	7380	Needle Bar Connecting Bracket with 223F and 1057E, for 81-9 Machine.....
42294	5598	Cloth Plate Extension (lower) for 42401
42298	7375	Feed (front) Eccentric Cover for 42319
*42319	—	Frame Top Cover Extension Holder 42102 with 42101, 42212, 42298 and two each 176J and 207E, for 81-9 Machine.....
*42324	—	Frame Top Cover Extension Holder 42102 with 42101, 42153, 42459 and two each 176J and 207E, for 81-20 and 81-21 Machines.....
42367	5585	Frame Rotary Shaft Front Bearing Oil Pad (braided cotton).....
42376	—	Presser Lever 42069 with 42045, for 81-20 and 81-21 Machines.....
42377	—	Presser Lever 42227 with 42045, for 81-9 Machine.....
42401	—	Cloth Plate complete for 81-9 Machine, Nos. 42002, 42005, 42108, 42294, two 236c and five 229E.....
42402	7397	Feed (front) Dog, 17 teeth (16 teeth to the inch) for 42407, for 81-9 Machine
42403	7398	Looper (right hand) and Spreader Lever Connection Oil Tube and Bracket with 29599, for 81-9 Machine.....
42404	7397	Presser Foot Chaining-off Finger for 42406.....
42405	—	Presser Foot Plate for 42406 and 132663
42405	—	" " " (back) for 42420, 42439 and 42451.....
42406	7397	Presser Foot (spring hinged) complete for 81-9 Machine, Nos. 233I, 464c, 9320, 14058, 42157, 42160, 42404 and 42405.....
42407	7397	Throat Plate for 42149 and 42402, for 81-9 Machine.....
42415	7399	Throat Plate for 42421 and 42422, for 81-20 Machine.....

NO.	PLATE	NAME
42418	—	Tension (looper, left hand) Screw Stud 828c with 1560c.....
42418	—	Tension (looper, right hand) Screw Stud 828c with 1560c.....
42420	7397	Presser Foot (spring hinged) complete for 81-20 Machine, Nos. 233j, 464c, 9320, 14058, 42160, 42263, 42264, 42288, 42405 and 42461.....
42421	7399	Feed (back) Dog, fine teeth, for silk work, for 42415 for 81-20 Machine, and for 42468 for 81-21 Machine.....
42422	7399	Feed (front) Dog, fine teeth, for silk work, for 42415 for 81-20 Machine, and for 42468 for 81-21 Machine.....
42427	7398	Spreader for 81-20 and 81-21 Machines..
Nos. 42434 to 42436 FOR 42437		
42434	7400	Guide with 19045.....
42435	7400	“ Holder.....
42436	7400	“ Hinge Screw Friction Washer....
42437	—	Guide (hinged) complete, for 81-20 Machine, Nos. 1425j and 42434 to 42436..
42438	—	Presser Foot Plate (front) for 42439.....
42439	7402	Presser Foot (spring hinged) complete for 42437, Nos. 233j, 464c, 9320, 14058, 42160, 42264, 42288, 42405, 42438 and 42461.....
42440	7400	Welt Guide Adjusting Slide for 42441....
42441	—	“ “ 42488 with 42440, for 42446.
42442	7400	“ “ Holder for 42443.....
42443	—	“ “ “ 42442 with 217b, 1117b, 1209c and 19044, for 42446....
42444	7400	Welt Guide Holder Extension with 42445, for 42446.....
42445	7400	Welt Guide Holder Extension Stud for 42444.....
42446	—	Welt Guide complete, adjustable from ½ to 1 in., for 81-21 Machine, Nos. 42441, 42443, 42444 and two 228b....
42449	7402	Presser Foot Chaining-off Finger for 42451.....
42450	—	Presser Foot Plate (front) for 42451.....
42451	7402	Presser Foot (spring hinged) complete for 81-21 Machine, Nos. 233j, 464c, 9320, 14058, 42160, 42264, 42405, 42449, 42450 and 42461.....
42459	7398	Frame Top Cover Extension for 42324...

NO.	PLATE	NAME
42461	7397	Presser Foot Plate (front) Hinge Pin for 42420, 42439 and 42451.....
42468	7399	Throat Plate for 42421 and 42422, for 81-21 Machine.....
42483	7396	Needle Bar Thread Retainer Disc.....
*42484	—	Arm with two each 462c, 624c, 42253 and 42487, for 81-20 and 81-21 Machines..
*42485	—	Arm with two each 462c, 624c, 42253 and 42487, for 81-9 Machine.....
42487	7396	Needle Bar Crank Shaft Bushing for 42484 and 42485.....
42488	7396	Welt Guide (solid) for 42441.....
42500	—	Presser Foot Chaining-off Finger for 132663.....
44209	—	Tension (needle thread) Screw Stud 916c with 1560c.....
50562c	7396	Looper (left hand) Lever Connecting Link Hinge Screw.....
54967	5585	Frame Rotary Shaft Flanged Bushing (back) Oil Pad (braided cotton) for 42026.....
56864	5566	Chain Hook (large) for 6439.....
56865	7396	“ “ (small) for 6439.....
66707	7398	Machine Cushion Screw Washer for 42086.....
68547	7396	Wrench for 1324, 1374, 1629 and 1728 (Accessories).....
120341	5566	Tweezers (curved) Accessories.....
120344	5566	Oiler (copper plated) with 120345 (Accessories).....
120345	5566	Oiler Spout, 5 in. long, for 120344.....
120440	5566	Screw Driver (Accessories).....
132663	—	Presser Foot (spring hinged) complete, Nos. 233j, 464c, 9320, 14058, 42157, 42160, 42405 and 42500.....
*150057	—	Thread Unwinder Thread Separator for 150058.....
150058	20778	Thread Unwinder Thread Separator 150057 with 150059, for 150061.....
*150059	—	Thread Unwinder Thread Separator Bracket for 150058.....
150060	20778	Thread Unwinder Thread Separator Bracket Arm with 164j and 9525, for 150061.....
150061	20778	Thread Unwinder Thread Separator complete for 150178, Nos. 164j, 9525, 150058 and 150060.....

## NUMERICAL LIST OF PARTS

NO.	PLATE	NAME
150178	20778	Thread Unwinder complete, for three spools, Nos. 150061, 201696a, 202490, 225257, 225259, 225324, 225326, 225388 and three each 150203, 225391 and wood screws $\frac{7}{8}$ in. No. 12.....
150203	—	Thread Unwinder Spool Rest Cushion (felt) for 150178.....
150209	—	Knife Grinder Knife Holder 41330 with 970b, 41331, 41332 and two each 313c, 771b, 1519a, 41333 and 41334, for 41335.....
200383c	7396	Thread Unwinder Spool Rest Rod Set Screw for 202490.....
201018c	7396	Thread Unwinder Spool Rest Set Screw for 225257 and 225259.....
201696a	7396	Thread Unwinder Thread Guide Lock Nut for 150178.....
202490	20778	Thread Unwinder Spool Stand with 200383c, for 150178.....
225257	20778	Thread Unwinder Spool Rest (for two spools) with 201018c, for 150178.....
225259	20778	Thread Unwinder Spool Rest (for one spool) with 201018c, for 150178.....
225322	7396	Thread Unwinder Thread Guide Rod Washer for 225324.....
225324	20778	Thread Unwinder Thread Guide Rod with 208e and 225322, for 150178.....
225326	7396	Thread Unwinder Thread Guide Position Cup for 150178.....
225388	20778	Thread Unwinder Spool Rest Rod for 150178.....
225390	7234	Thread Unwinder Thread Cone Holder, for inverted cones, for 150178.....
225391	20778	Thread Unwinder Thread Guide for 150178.....

Genuine Singer Needles should be used  
in this machine.

Their containers are marked with the  
Company's Trade Mark "SIMANCO." 1

Needles in Containers marked  
"For Singer Machines"  
are not Singer made needles. 2

21 24 1900 21 24 1900 21 24 1900

201

23 24 1900 1

21 24 1900 21 24 1900 21 24 1900

**ILLUSTRATIONS OF PARTS  
FOR  
MACHINES  
Nos. 81-9, 81-20 and 81-21**

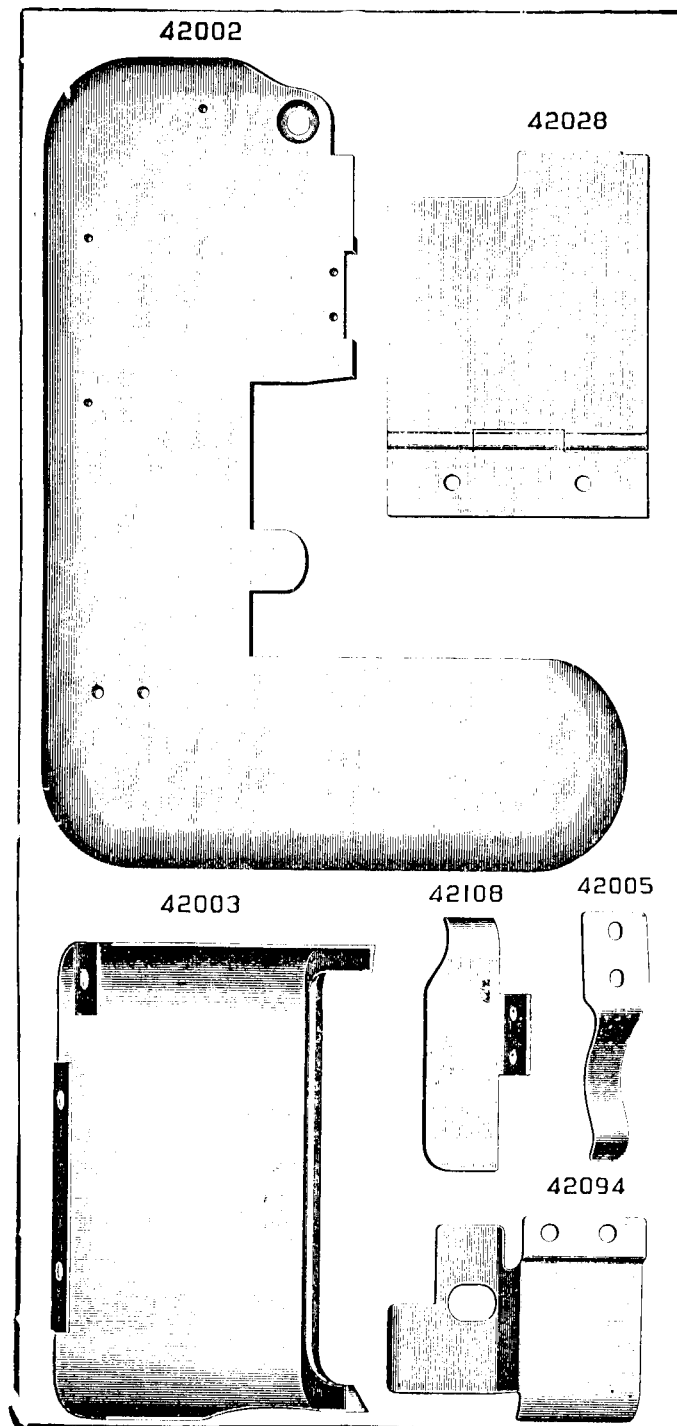

PLATE 5529—FULL SIZE

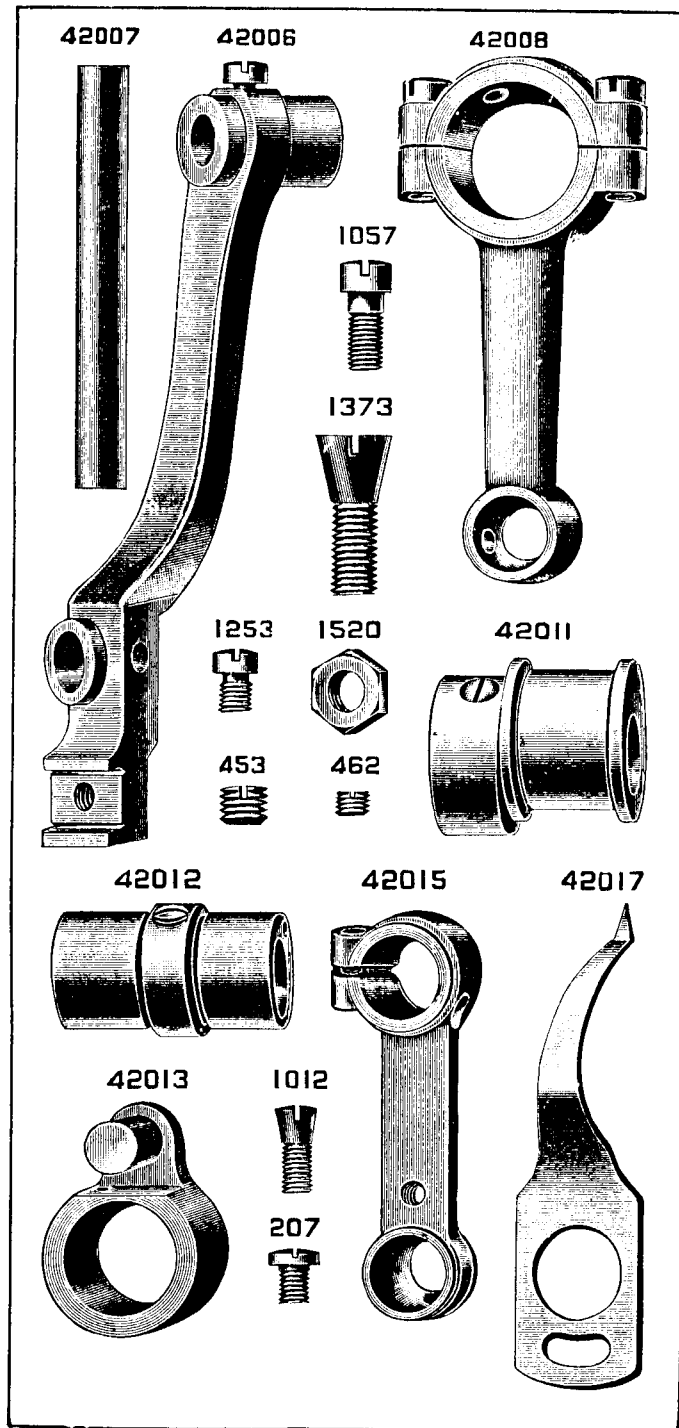

PLATE 5530—FULL SIZE

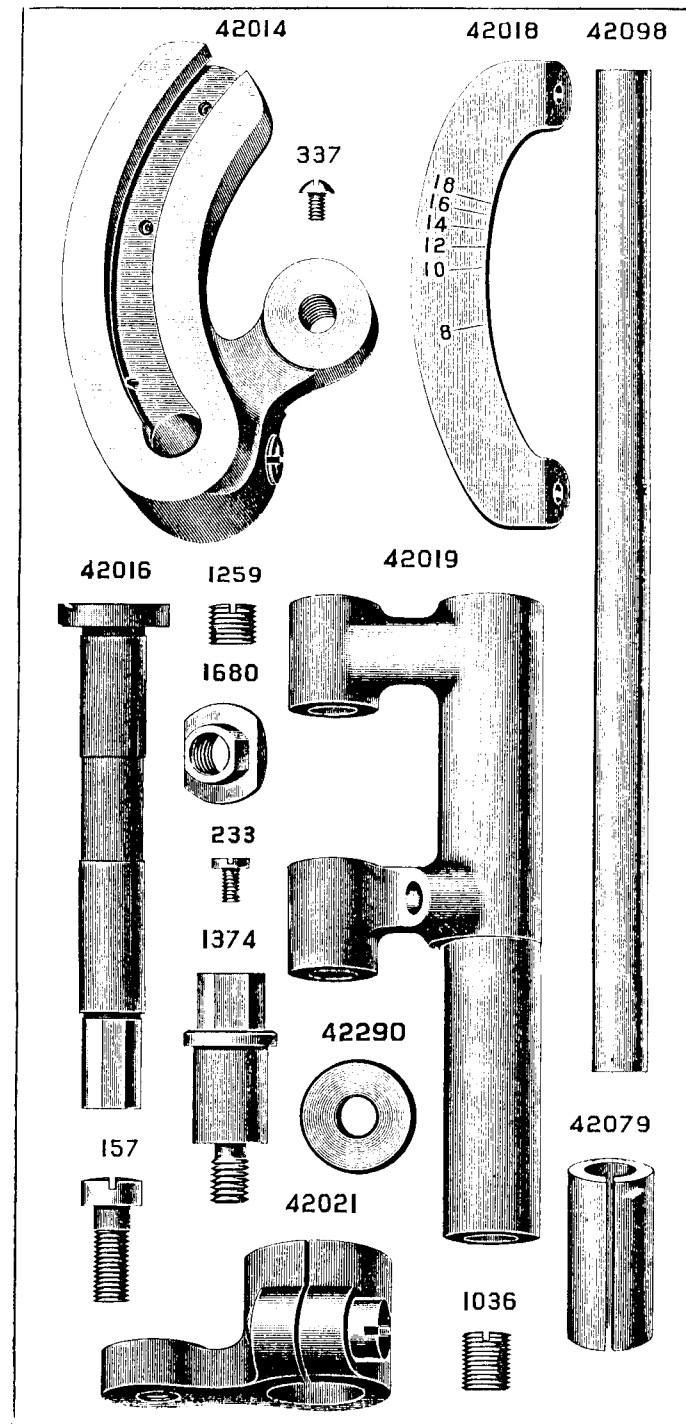

PLATE 5542—FULL SIZE

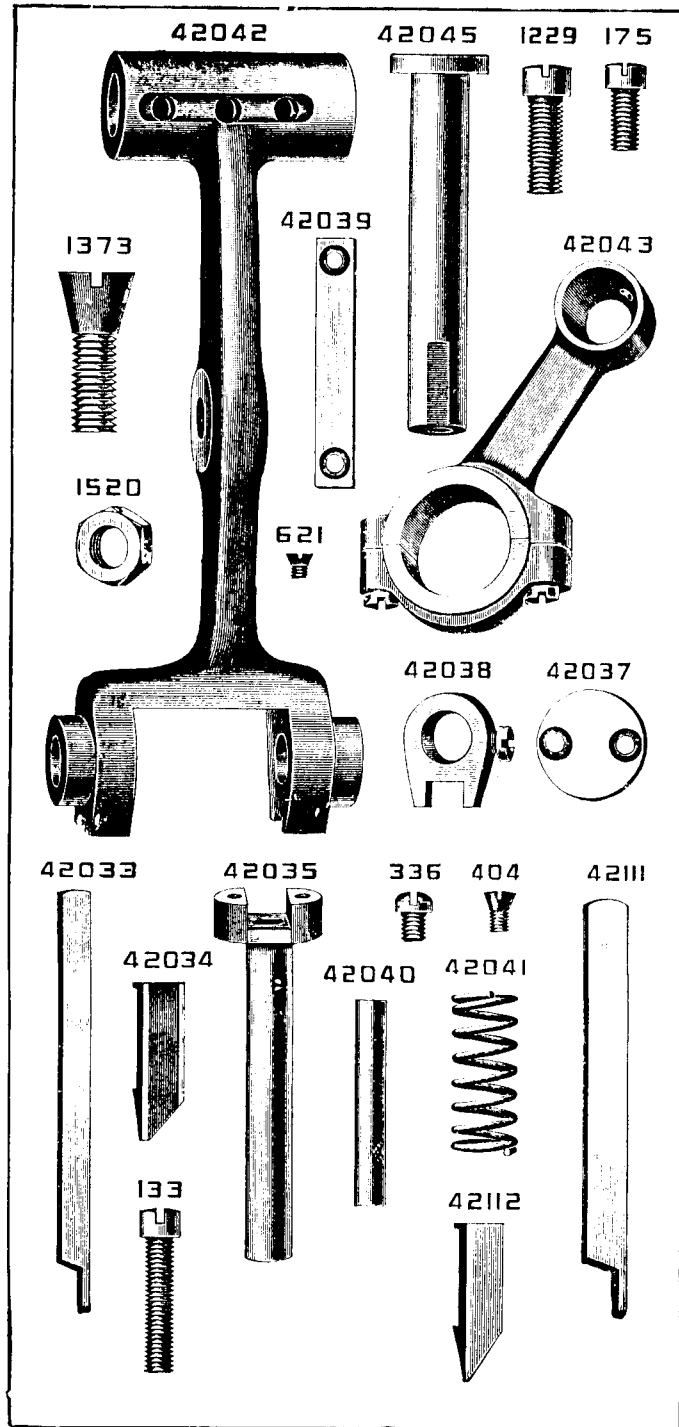

PLATE 5543—FULL SIZE

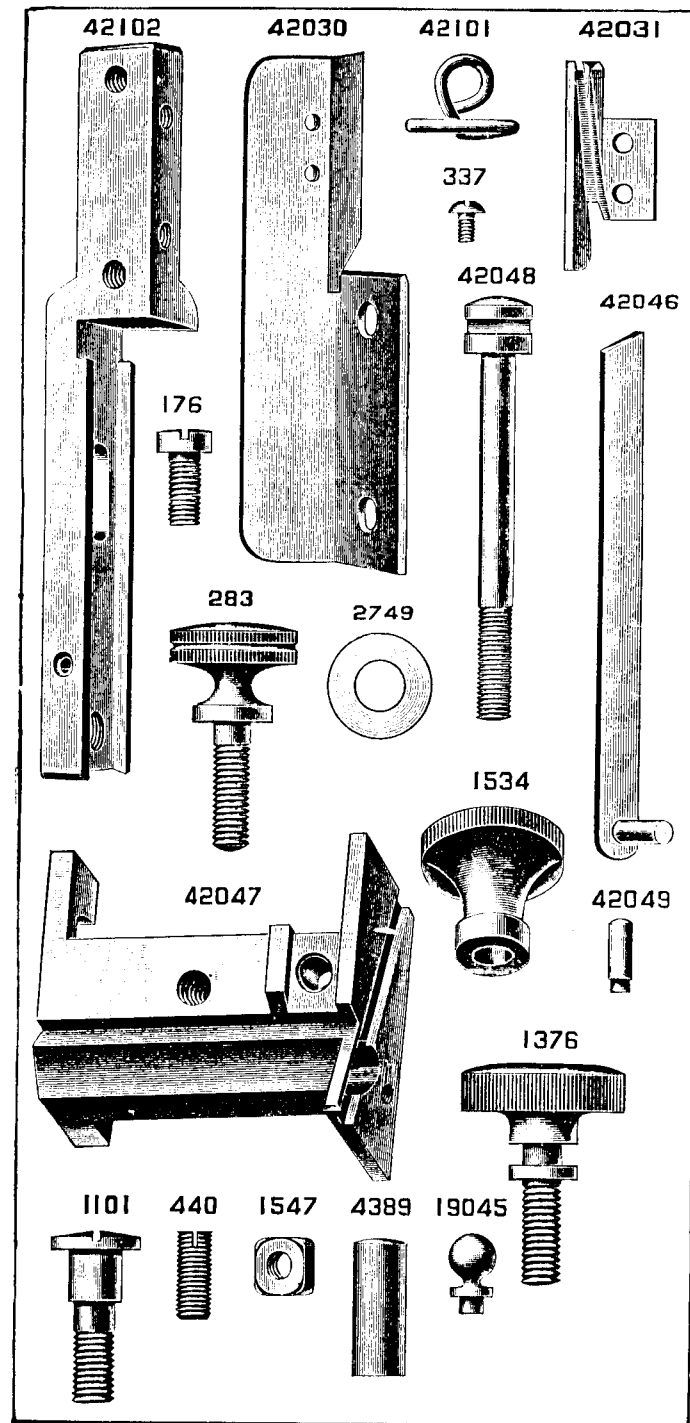

PLATE 5544—FULL SIZE

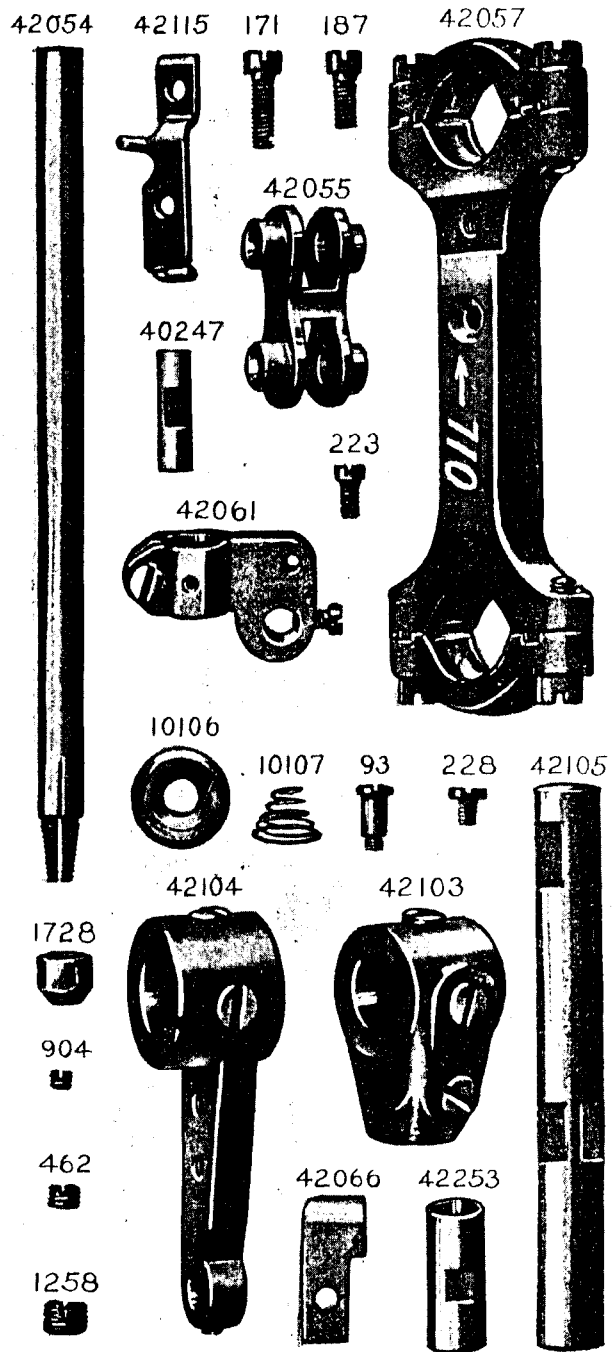

PLATE 5545--FULL SIZE

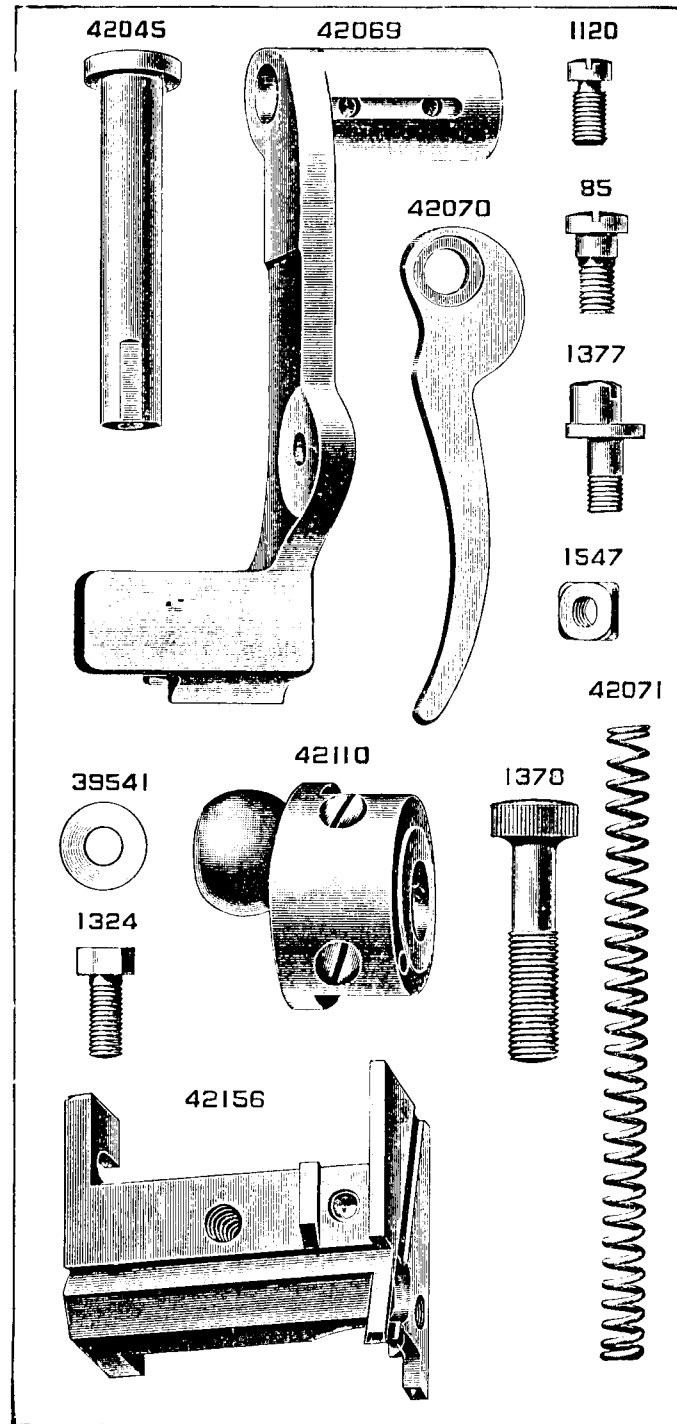

PLATE 5563—FULL SIZE

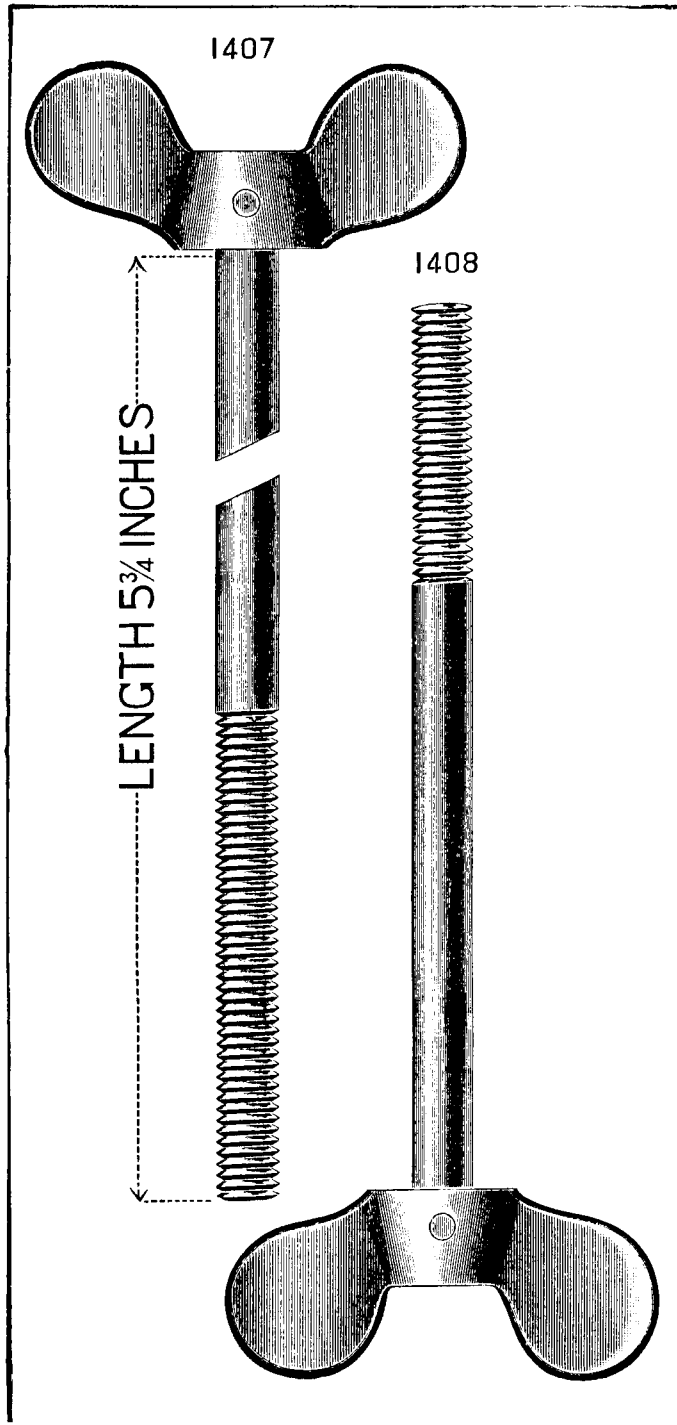

PLATE 5564—ONE-FOURTH SIZE

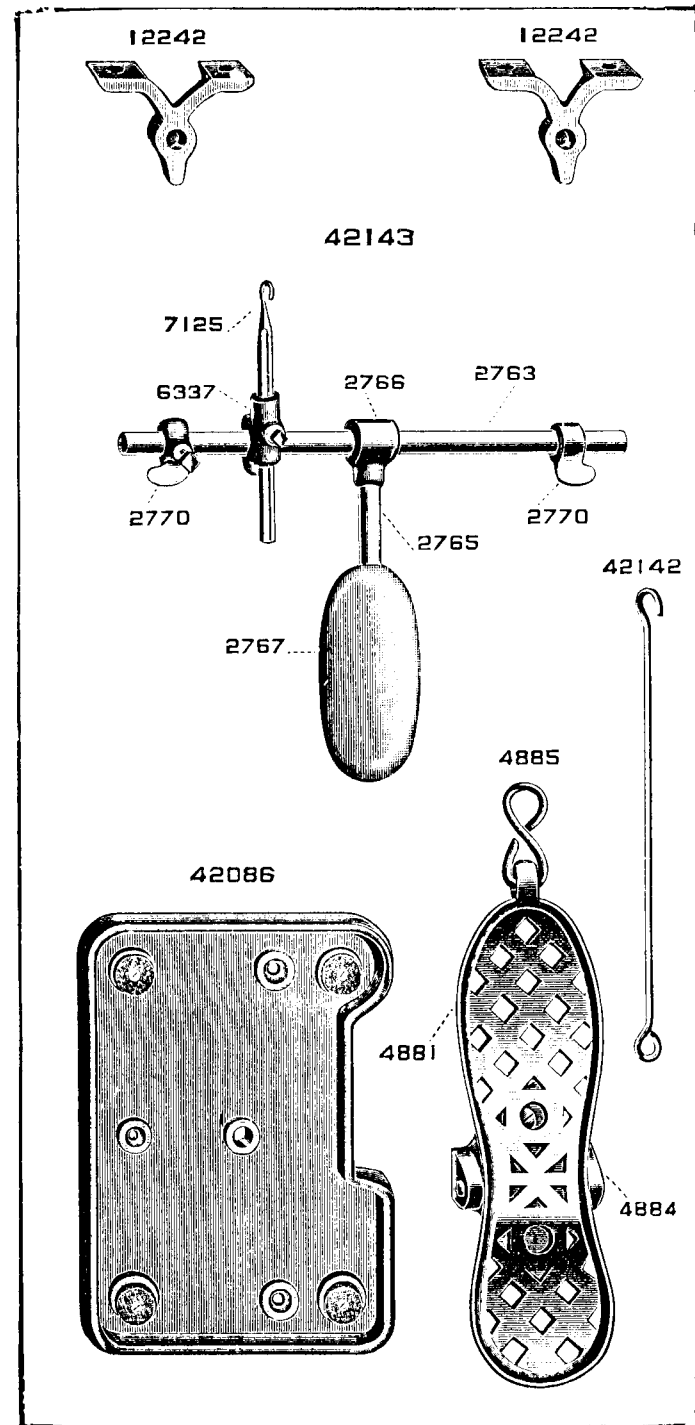
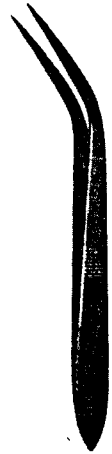

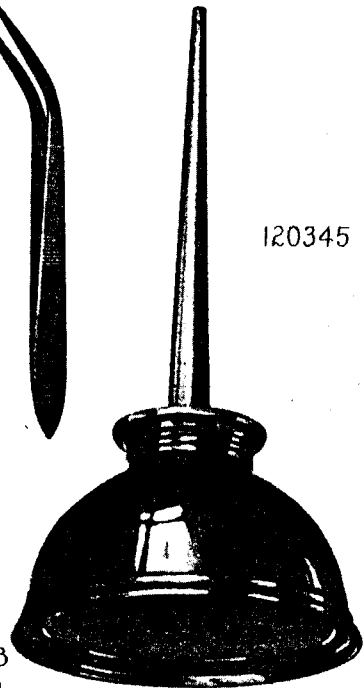

PLATE 5566--ONE-HALF SIZE

120341



120344



120345

120440 42090



8908



42089



4822



4883

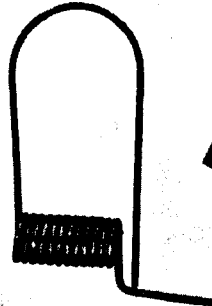

4882



4879



56864



PLATE 5567--ONE-HALF SIZE

41329

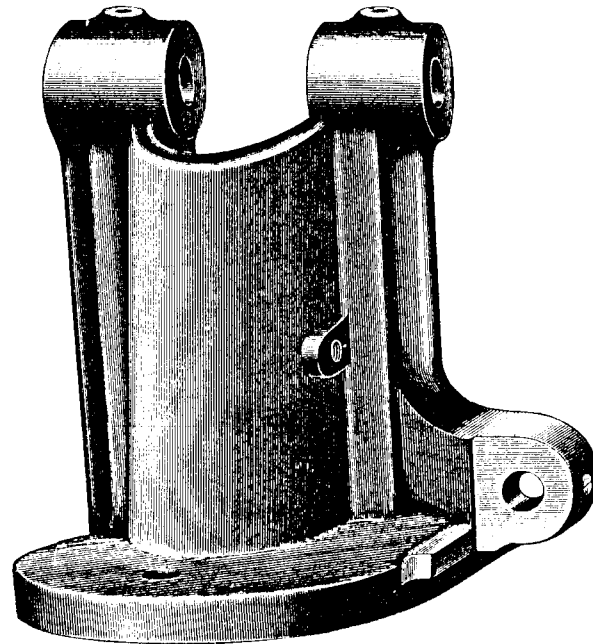

PLATE 5568—ONE-HALF SIZE

41327



41326



41328

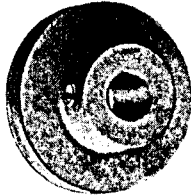

41330

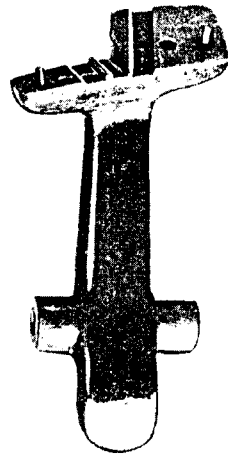

41818

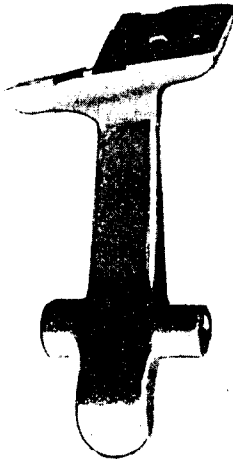

41331

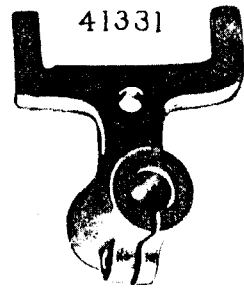
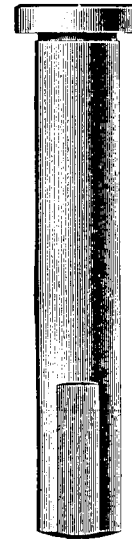
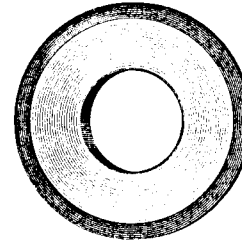

PLATE 5569—FULL SIZE

42065



41513



1508

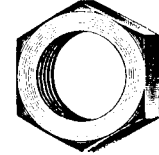

157

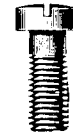

878



1036



1520



1519



14222



970

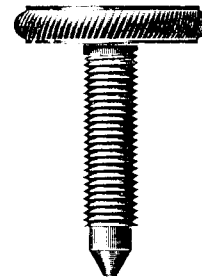

771

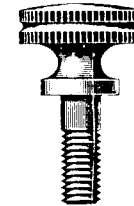

717



313

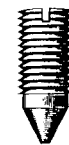

41333

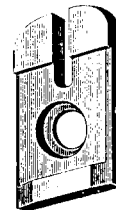

41334



41332

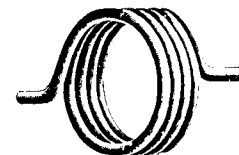
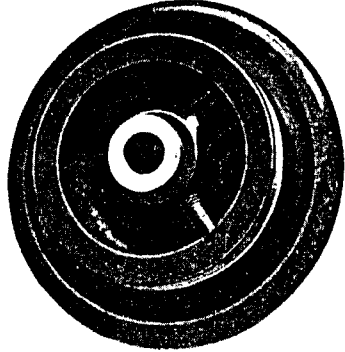

PLATE 5576—ONE-HALF SIZE

42023



42001



42069

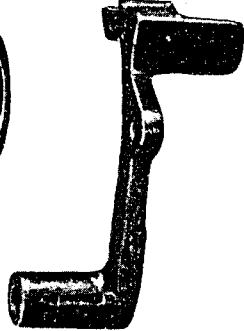

42026

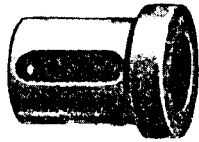

42024



42029

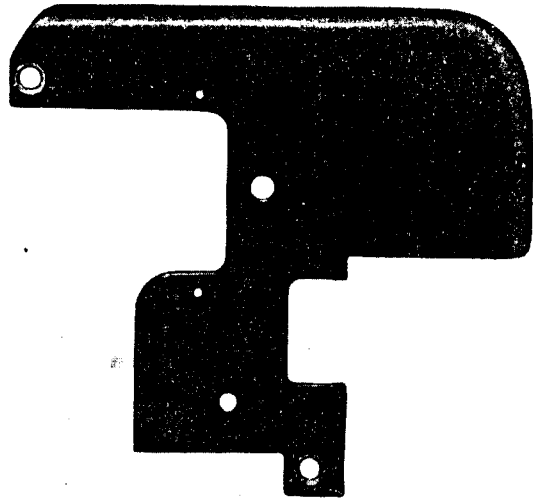
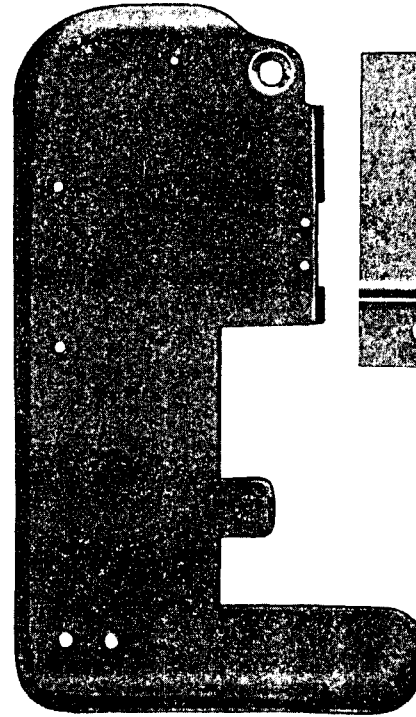
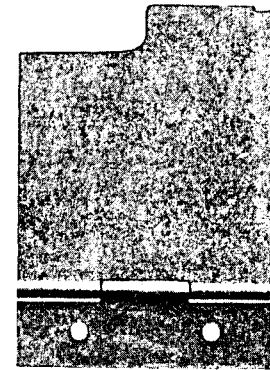

PLATE 5577—ONE-HALF SIZE

42145



42028



42027

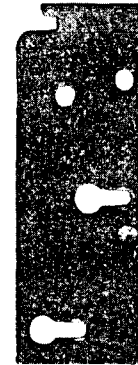

42003

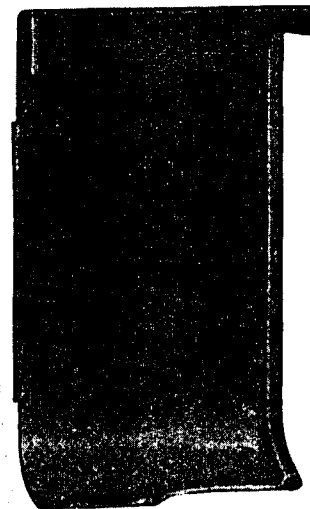

42108



42005



42153

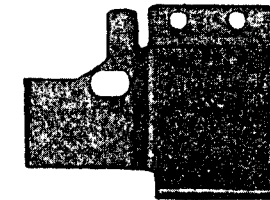

PLATE 5584—FULL SIZE

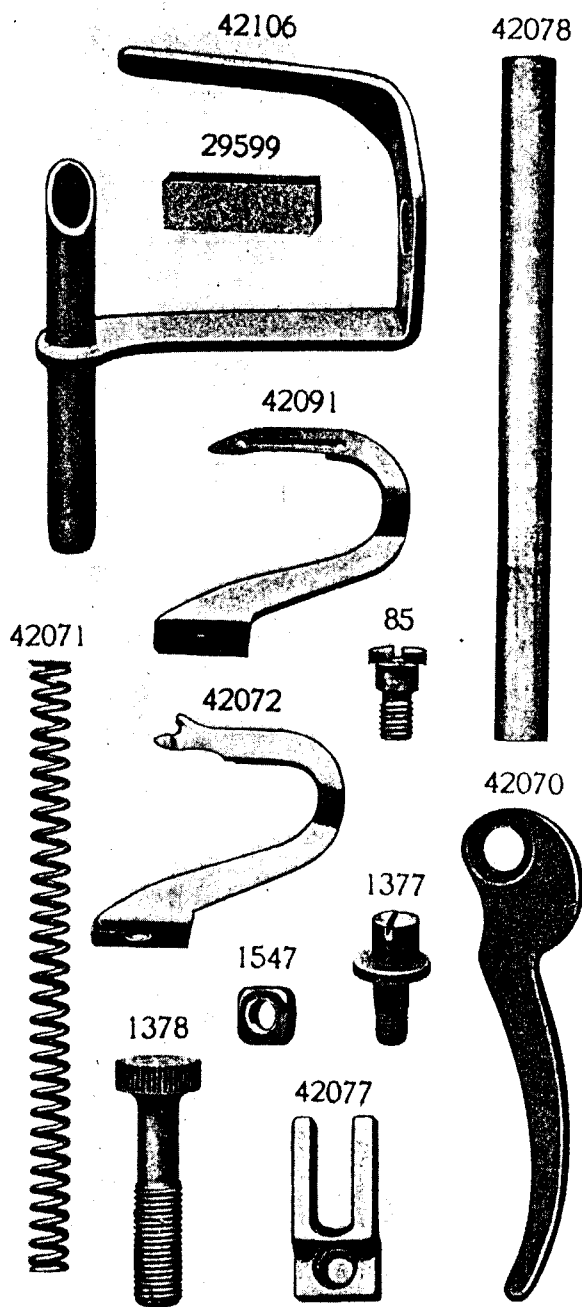

PLATE 5585—FULL SIZE

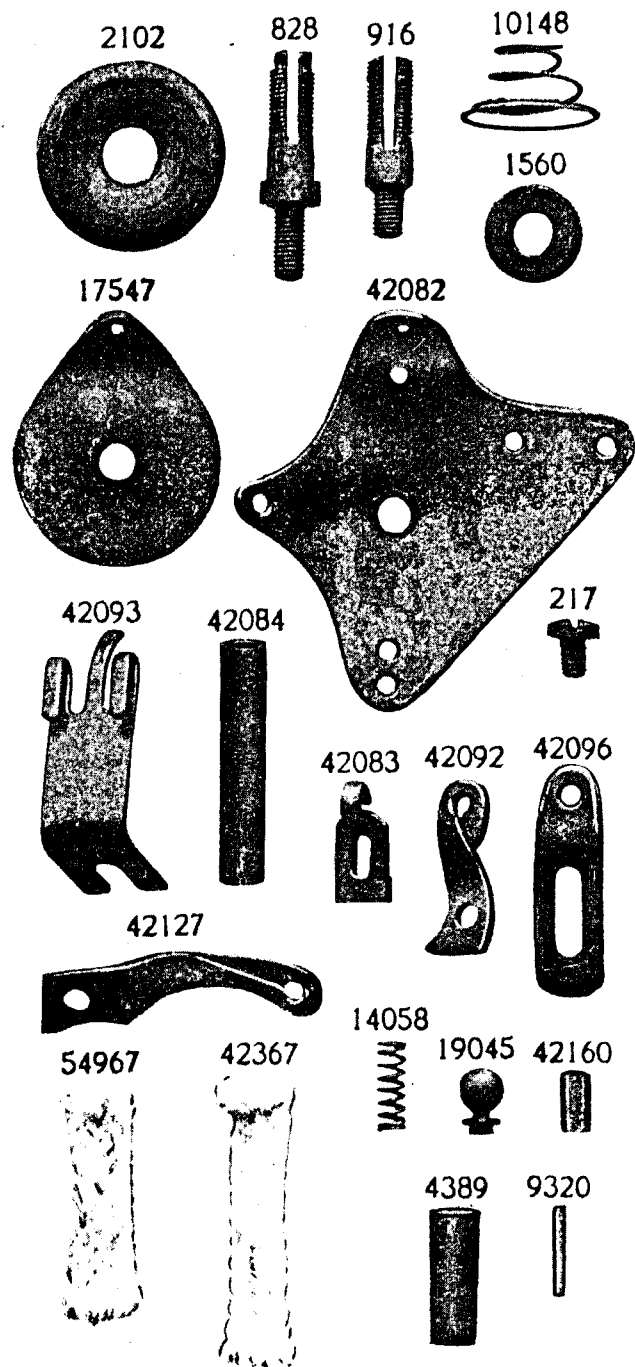

PLATE 5586—FULL SIZE

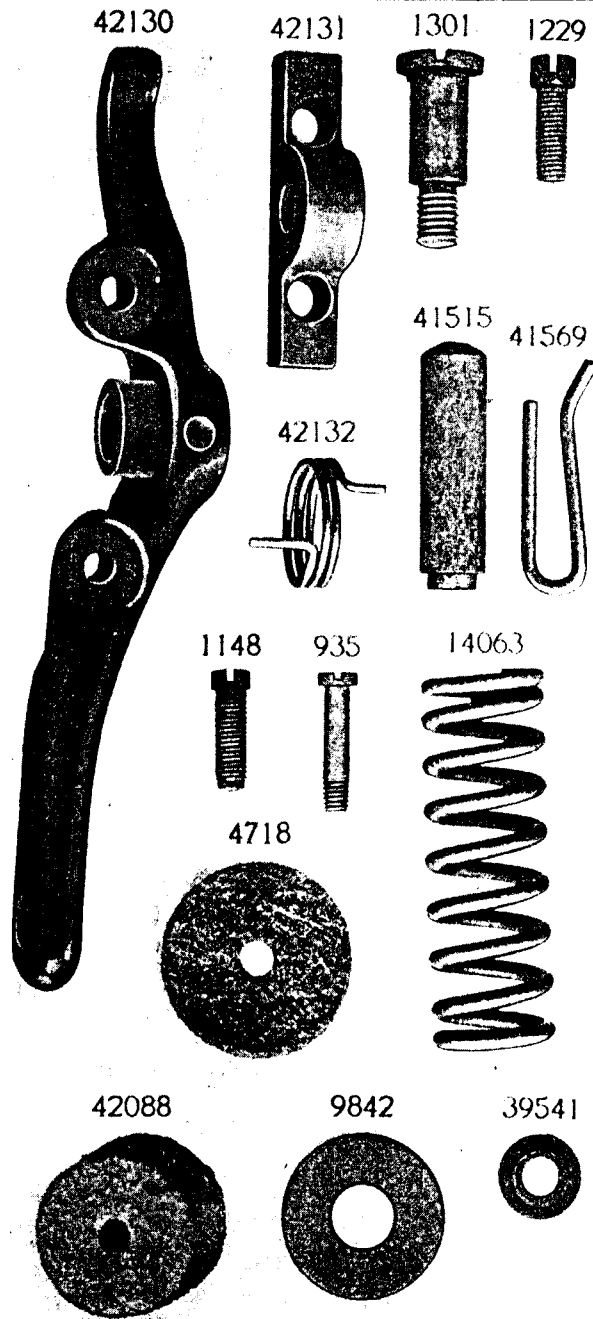

PLATE 5587—FULL SIZE

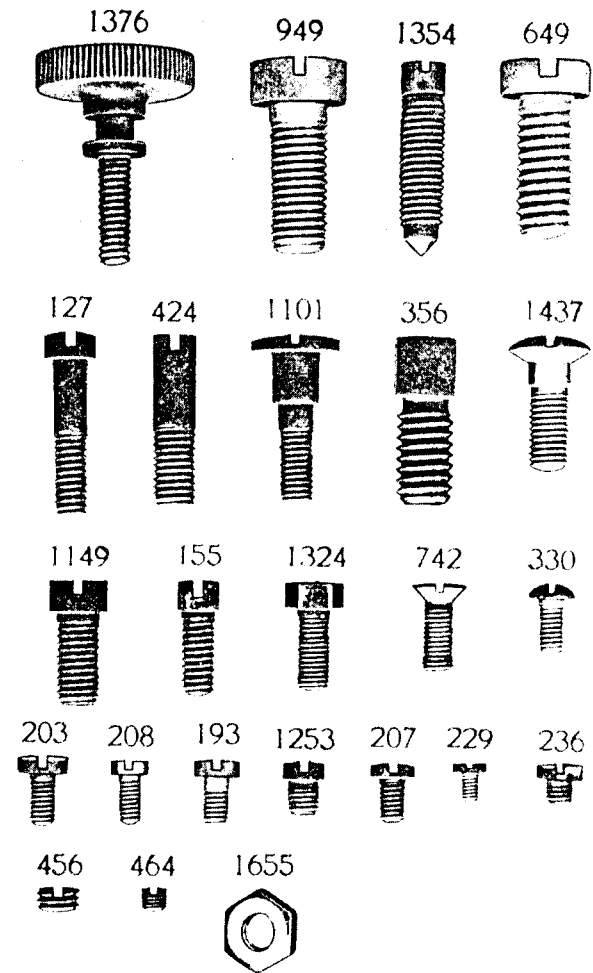

PLATE 5598—ONE-HALF SIZE

42294

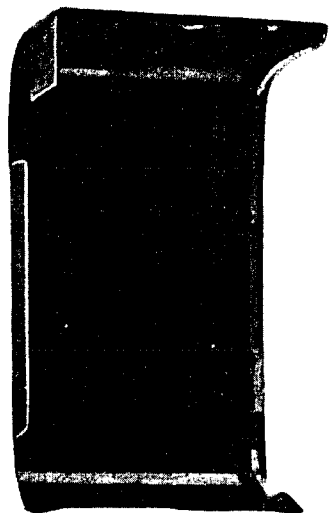
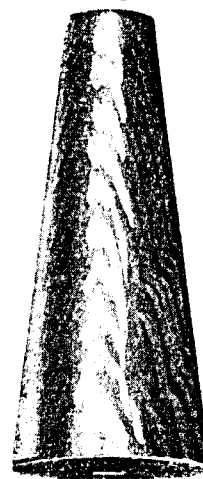

PLATE 7234—ONE-HALF SIZE

27739



225390

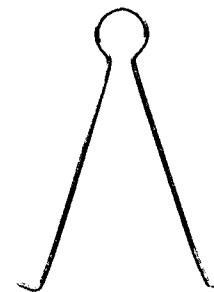

PLATE 7375—ONE-HALF SIZE

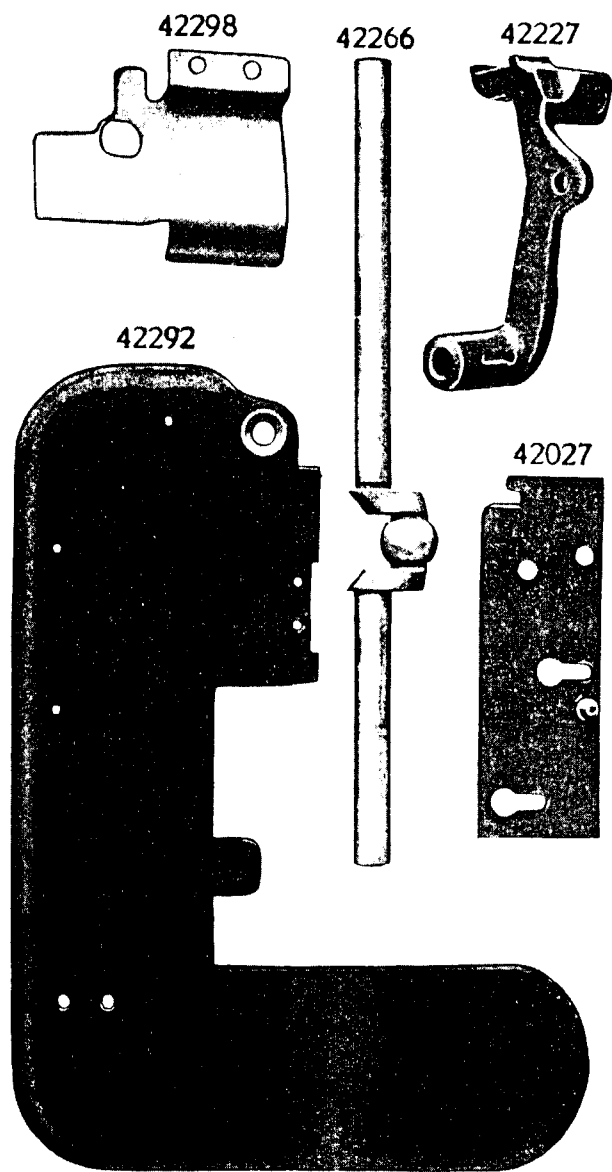

PLATE 7376—FULL SIZE

