PFAFF[®] 1296-706/35

Unterklassen-Ausstattung
Subclass parts
Composition des sous-classes
Composición de las subclases

Unterklassen-Ausstattung¹⁾

Subclass organization¹⁾

Equipement des sous-classes¹⁾

Dotación de las subclases¹⁾

Unterklasse Subclass Sous-classe Subclase	Ausführung Model Version Tipo de máquina	Nadelabstand in mm Needle gauge in mm Ecartement des aiguilles en mm Distancias entre agujas en mm	Nadelhalter ^[102] Needle holder Pince-aiguille Portaagujas	Stoffschieber ^[4] ^[101] ^[102] Feed dog Griffe Transportador inferior	Sichplatte ^[4] ^[101] ^[102] Needle plate Plaque à aiguille Placa de aguja	Nähfuß ^[1] ^[102] Presser foot Pied presseur Pie prensateelas	Stoffschleber ^[4] ^[102] Vibrating presser Pied entraîneur Transportador superior
-6/01	BN	3,2-20,0		91-047 814-04 ^[10] = 3,2-4,4mm	91-058 406-04		
	CN	3,2-20,0	91-710 004-93	91-040 447-04 ^[10] = 4,8-8,0mm	91-484 344-04		
	DN	4,0-20,0		91-047 814-04 ^[10] = 9,2mm	91-058 406-04	91-040 429-04	01-040 430-93
				91-040 447-04 ^[10] = 9,6-14,0mm	91-484 344-04		
				91-047 814-04 ^[10] = 15,2-16,0mm	91-058 406-04		
			91-040 447-04 ^[10] = 17,2-20,0mm	91-484 344-04			
-6/01 -900/56	BN	3,2-16,0	91-710 004-93	91-059 175-04	91-158 056-04	91-040 429-04	91-040 430-93
	CN						
-57/01	CN	4,0-20,0	91-710 004-93	91-047 814-04 ^[10] = 4,0-4,4mm	91-058 406-04		
				91-040 447-04 ^[10] = 4,8-8,0mm	91-484 344-04		
				91-047 814-04 ^[10] = 9,2mm	91-058 406-04	91-040 429-04	91-040 430-93
				91-040 447-04 ^[10] = 9,6-14,0mm	91-484 344-04		
				91-047 814-04 ^[10] = 15,2-16,0mm	91-058 406-04		
			91-040 447-04 ^[10] = 17,2-20,0mm	91-484 344-04			
-57/01 -900/56	CN	4,0-16,0	91-710 004-93	91-059 175-04	91-158 056-04	91-040 429-04	91-040 430-93
-58/01	CN	4,0-20,0	91-710 004-93	91-047 814-04 ^[10] = 4,0-4,4mm	91-058 406-04		
				91-040 447-04 ^[10] = 4,8-8,0mm	91-484 344-04		
				91-047 814-04 ^[10] = 9,2mm	91-058 406-04	91-040 429-04	91-040 430-93
				91-040 447-04 ^[10] = 9,6-14,0mm	91-484 344-04		
				91-047 814-04 ^[10] = 15,2-16,0mm	91-058 406-04		
			91-040 447-04 ^[10] = 17,2-20,0mm	91-484 344-04			
-58/01 -900/56	CN	4,0-16,0	91-710 004-93	91-059 175-04	91-158 056-04	91-040 429-04	91-040 430-93
-61/02	CN	3,2-20,0	91-710 004-93	91-047 814-04 ^[10] = 3,2-4,4mm	91-058 406-04		
				91-040 447-04 ^[10] = 4,8-8,0mm	91-484 344-04		
				91-047 814-04 ^[10] = 9,2mm	91-058 406-04	91-040 429-04	91-040 430-93
				91-040 447-04 ^[10] = 9,6-14,0mm	91-484 344-04		
				91-047 814-04 ^[10] = 15,2-16,0mm	91-058 406-04		
			91-040 447-04 ^[10] = 17,2-20,0mm	91-484 344-04			
-61/02 -900/56	CN	3,2-16,0	91-710 004-93	91-059 175-04	91-158 056-04	91-040 429-04	91-040 430-93
-63/13	CN	4,0-11,2	91-710 004-93	91-047 814-04 ^[10] = 4,0-4,4mm	91-058 406-04		
				91-040 447-04 ^[10] = 4,8-8,0mm	91-484 344-04	91-049 560-04	91-049 060-93
				91-047 814-04 ^[10] = 9,2mm	91-058 406-04		
				91-040 447-04 ^[10] = 9,6-11,2mm	91-484 344-04		
-63/13 -900/56	CN	4,0-11,2	91-710 004-93	91-059 175-04	91-158 056-04	91-049 560-04	91-049 060-93
-82/14	B, C	3,2-3,6	91-710 004-93	91-047 814-04 ^[10] = 3,2-3,6mm	91-058 406-04	91-040 429-04	91-049 464-93
	C	4,0-6,4		91-042 492-04 ^[10] = 4,0-6,4mm	91-491 608-04		91-049 211-04
-237/06	BN	8,0-20,0	91-710 004-93	91-059 017-04	91-158 551-04	91-049 503-04 ^[5]	91-049 144-93 ^[5]
-237/06 -900/56	BN	8,0-16,0	91-710 004-93	91-059 246-04	91-158 198-04	91-049 503-04 ^[5]	91-049 144-93 ^[5]

1) Die Liste enthält nur Nähwerkzeuge und Apparate. Beim Umbau in eine andere Unterklasse oder Ausführung sind auch noch Maschinenteile erforderlich. Geben Sie also bei Bestellungen die genaue Bezeichnung der vorhandenen und der gewünschten Ausführung bekannt.

1) This list contains sewing parts and attachments only. When converting to another subclass or version, machine parts are also necessary. When ordering please therefore indicate exactly the existing version and the one required.

1) Cette liste ne contient que les organes de couture et les guides. En cas de transformation en une sous-classe ou variante différente, il faut utiliser aussi certaines pièces de machine supplémentaires. En cas de commande, prière de toujours indiquer par conséquent les variantes disponibles et souhaitées.

1) Esta lista sólo contiene elementos de costura y aparatos. Siempre que haya que transformar la máquina en otro tipo o subclase, se necesitarán también piezas de máquina, por lo que deberá indicarse en los pedidos el tipo exacto de que se dispone y el deseado.

Equipement des sous-classes¹⁾

Dotación de las subclases¹⁾

Unterklassen-Ausstattung¹⁾

Subclass organization¹⁾

Unterklasse Subclass Sous-classe Subclase	Ausführung Model Version Tipo de máquina	Appareil ⁵⁾ Attachement Appareil Aparato	Träger Bracket Support Soporte	Kopfplatte Face plate Plaque frontale Placa frontal	Bandrommel Tape reel Tambour-dérouleur Tambor portacintas	Bandführung Tape guide Guide-ruban Guiacintas	Fingerschutz Finger guard Protège-doigts Salvatedos
-6/01	BN CN DN						91-057 741-91 ¹⁰ = 3,2-4,4mm 91-057 806-91 ¹⁰ = 4,8-15,2mm 91-057 809-91 ¹⁰ = 16,0-20,0mm
-5/01 -900/56	BN CN						91-057 741-91 ¹⁰ = 3,2-4,4mm 91-057 806-91 ¹⁰ = 4,8-15,2mm 91-057 809-91 ¹⁰ = 16,0mm
-57/01	CN	91-040 275-93 ¹⁰ = 4,0-10,0mm 91-040 844-24 ¹⁰ = 11,2-20,0mm	91-040 166-21				91-057 741-91 ¹⁰ = 4,0-4,4mm 91-057 806-91 ¹⁰ = 4,8-15,2mm 91-057 809-91 ¹⁰ = 16,0-20,0mm
-57/01 -900/56	CN	91-040 275-93 ¹⁰ = 4,0-10,0mm 91-040 844-24 ¹⁰ = 11,2-16,0mm	91-040 166-21				91-057 741-91 ¹⁰ = 4,0-4,4mm 91-057 806-91 ¹⁰ = 4,8-15,2mm 91-057 809-91 ¹⁰ = 16,0mm
-58/01	CN	91-040 273-93 ¹⁰ = 4,0-10,0mm 91-042 070-24 ¹⁰ = 11,2-20,0mm	91-040 166-21				91-057 741-91 ¹⁰ = 4,0-4,4mm 91-057 806-91 ¹⁰ = 4,8-15,2mm 91-057 809-91 ¹⁰ = 16,0-20,0mm
-58/01 -900/56	CN	91-040 273-93 ¹⁰ = 4,0-10,0mm 91-042 070-24 ¹⁰ = 11,2-16,0mm	91-040 166-21				91-057 741-91 ¹⁰ = 4,0-4,4mm 91-057 806-91 ¹⁰ = 4,8-15,2mm 91-057 809-91 ¹⁰ = 16,0mm
-61/02	CN	91-043 408-23	91-040 862-90	91-140 383-91	91-040 207-91		91-057 741-91 ¹⁰ = 3,2-4,4mm 91-057 806-91 ¹⁰ = 4,8-15,2mm 91-057 809-91 ¹⁰ = 16,0-20,0mm
-61/02 -900/56	CN	91-043 408-23	91-040 862-90	91-140 383-91	91-040 207-91		91-057 741-91 ¹⁰ = 3,2-4,4mm 91-057 806-91 ¹⁰ = 4,8-15,2mm 91-057 809-91 ¹⁰ = 16,0mm
-63/13	CN	91-053 560-91 91-053 567-93			91-041 644-91	91-044 419-25	91-057 741-91 ¹⁰ = 4,0-4,4mm 91-057 806-91 ¹⁰ = 4,8-11,2mm
-63/13 -900/56	CN	91-053 560-91 91-053 567-93			91-041 644-91	91-044 419-25	91-057 741-91 ¹⁰ = 4,0-4,4mm 91-057 806-91 ¹⁰ = 4,8-11,2mm
-82/14	B, C C	91-056 442-93			91-043 938-91		
-237/06	BN	91-056 026-93 91-056 031-15 91-056 033-93		91-140 386-91			
-237/06 -900/56	BN	91-056 026-93 91-056 031-15 91-056 033-93		91-140 386-91			

⁴⁾ = Ausführung angeben
= Indicate model
= Préciser la version
= Indiquese el tipo de máquina

¹⁰⁾ = Nadelabstand
= Needle gauge
= Ecartement des aiguilles
= Distancias entre agujas

^{10/1)} = je nach Nadelabstand ändert sich die Form (z.B. beim Stoffschieber die Anzahl der Zahnreihen)
= Certain design features change according to the needle gauge (e.g. the number of tooth rows on the feed dog)
= La forme est fonction de l'écartement des aiguilles (par ex. le nombre des rangées de dents de la griffe)
= La forma varía de acuerdo con la distancia entre agujas (p.e. el número de hileras de dientes en el transportador)

^{10/2)} = Nadelabstand bei Bestellung angeben
= State needle gauge on order
= indiquer écartement des aiguilles à la commande
= Indiquese la distancia entre agujas en los pedidos

⁵⁾ = Nähmuster einsenden
= Submit sewing sample
= Joindre échantillons de couture
= Enviase muestra de costura

Unterklassen-Ausstattung¹⁾











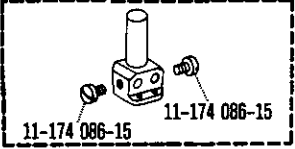





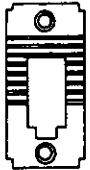

Subclass organization¹⁾

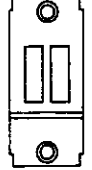
Equipement des sous-classes¹⁾



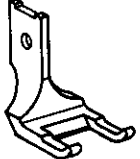
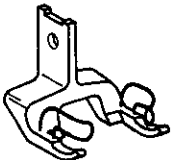

Dotación de las subclases¹⁾

Unterklasse Subclass Sous-classe Subclase	Ausführung Model Version Tipo de máquina	Winkel Angle bracket Equerre Pieza angular	Lüfterhebel Lifting lever Lever récepteur Palanca alzapiensateñas	Boizen + Platte Stud + plate Boulon + plaque Perno + placa	Seilzug Puit-cable Transmission par câble Cable de mando	Auflage Plate Appui Placa de apoyo	Fadenabschneider Thread trimmer Coupe-fils Cortafilios
-6/01	BN CN DN						
-6/01 -900/56	BN CN						
-57/01	CN						
-57/01 -900/56	CN						
-58/01	CN						
-58/01 -900/56	CN						
-61/02	CN						
-61/02 -900/56	CN						
-63/13	CN						
-63/13 -900/56	CN						
-82/14	B.C C						
-237/06	BN	91-050924-15	91-140592-41 91-010796-15	91-108594-05 91-140595-15	91-027387-91	91-056436-21	91-053768-91
-237/06 -900/56	BN	91-050924-15	91-140592-41 91-010796-15	91-108594-05 91-140595-15	91-027387-91	91-056436-21	

Unterklassen-Übersicht/ Table of subclasses/ Table des sous-classes/ Tabla de subclasses

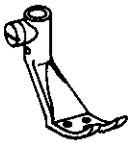
<p>91-710 004-93 10/2</p>  <p>11-174 086-15 11-174 086-15</p>	<p>91-040 447-04 4 10/1 10/2</p> <p>10 = 4,8 - 8,0 mm - 9,6 - 14,0 mm - 17,2 - 20,0 mm</p>  <p>-6/01 -57/01 -58/01 -61/02 -63/13</p>	<p>91-047 814-04 4 10/2</p> <p>10 = 3,2 - 4,4 mm</p> 	<p>91-047 814-04 4 10/1 10/2</p> <p>10 = 9,2 mm - 15,2 - 16,0 mm</p>  <p>-6/01 -57/01 -58/01 -61/02 -63/13 -82/14</p>	
<p>-6/01 -6/01-900/56 -57/01 -57/01-900/56 -58/01 -58/01-900/56 -61/02 -61/02-900/56 -63/13 -63/13-900/56 -82/14 -237/06 -237/06-900/56</p>	<p>91-042 492-04 4 10/1 10/2</p> <p>10 = 6,4 mm</p>  <p>-82/14</p>	<p>91-059 175-04 4 10/2</p> <p>10 = 3,2 mm</p> 	<p>91-059 175-04 4 10/1 10/2</p> <p>10 = 4,0 - 16,0 mm</p>  <p>-6/01-900/56 -57/01-900/56 -58/01-900/56 -61/02-900/56 -63/13-900/56</p>	
<p>91-059 246-04 4 10/1 10/2</p>  <p>-237/06-900/56</p>	<p>91-059 017-04 4 10/1 10/2</p>  <p>-237/06</p>	<p>91-058 406-04 4 10/2</p> <p>10 = 3,2 - 4,4 mm</p> 	<p>91-058 406-04 4 10/1 10/2</p> <p>10 = 9,2 mm = 15,2 - 16,0 mm</p>  <p>-6/01 -57/01 -58/01 -61/02 -63/13 -82/14</p>	<p>91-491 608-04 4 10/1 10/2</p> <p>10 = 6,4 mm</p>  <p>-82/14</p>
<p>91-158 056-04 4 10/2</p> <p>10 = 3,2 mm</p> 	<p>91-158 056-04 4 10/1 10/2</p> <p>10 = 4,0 - 16,0 mm</p>  <p>-6/01-900/56 -57/01-900/56 -58/01-900/56 -61/02-900/56 -63/13-900/56</p>	<p>91-158 198-04 4 10/1 10/2</p>  <p>-237/06-900/56</p>	<p>91-158 551-04 4 10/1 10/2</p>  <p>-237/06</p>	<p>91-484 344-04 4 10/1 10/2</p> <p>10 = 4,8 - 8,0 mm - 9,6 - 14,0 mm - 17,2 - 20,0 mm</p>  <p>-6/01 -57/01 -58/01 -61/02 -63/13</p>
<p>91-040 429-04 4 10/2</p>  <p>-6/01 -6/01-900/56 -57/01 -57/01-900/56</p> <p>-58/01 -58/01-900/56 -61/02 -61/02-900/56 -82/14</p>	<p>91-049 503-03 4 5 10/2</p>  <p>-237/06 -237/06-900/56</p>	<p>91-049 560-04 4 10/2</p>  <p>-63/13 -63/13-900/56</p>	<p>91-040 430-93 4 10/2</p>  <p>-6/01 -6/01-900/56 -57/01 -57/01-900/56 -58/01 -58/01-900/56 -61/02 -61/02-900/56</p>	

Unterklassen-Ubersicht/ Table of subclasses/ Table des sous-classes/ Tabla de subclasses

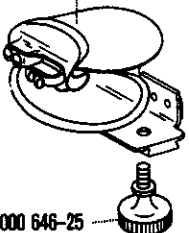
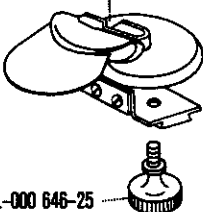
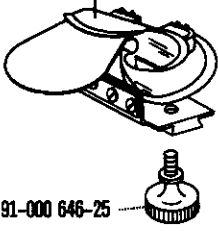
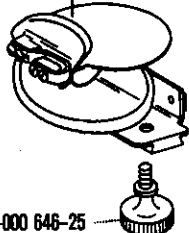
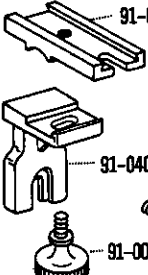
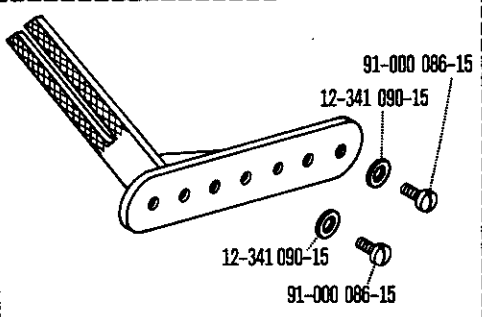
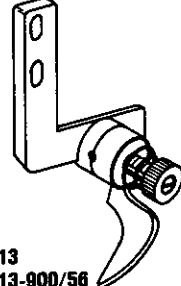
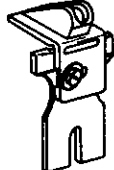
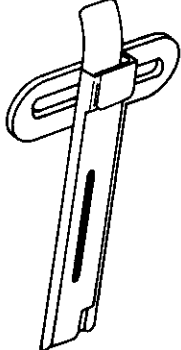
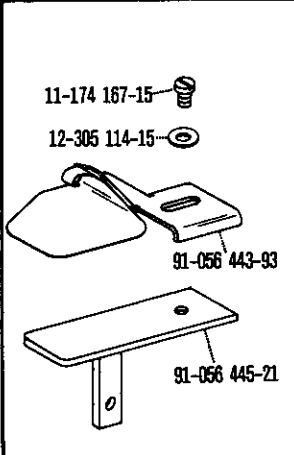
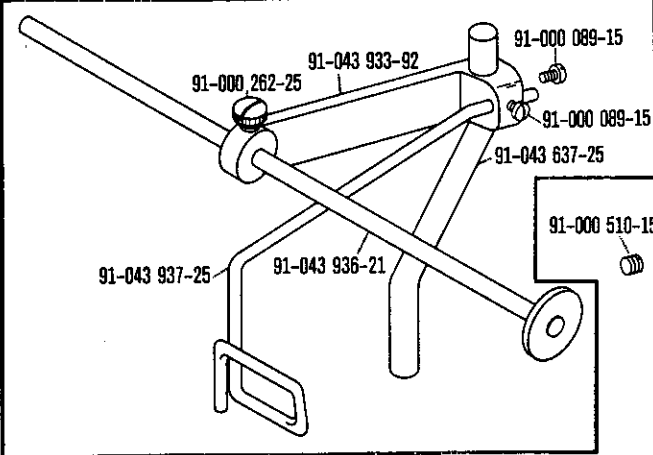
<p>91-049 060-93 [4] [10/2]</p>  <p>-63/13 -63/13-900/56</p>	<p>91-049 464-93 [4] [10/2]</p>  <p>-82/14</p>	<p>91-049 211-93 [4] [9] [10/2]</p>  <p>-82/14</p>	<p>91-049 144-03 [4] [9] [10/2]</p>  <p>-237/06 -237/06-900/56</p>	<p>91-040 273-93 [5]</p>  <p>91-000 646-25 -58/01 -58/01-900/56</p>
<p>91-040 275-93 [5]</p>  <p>91-000 646-25 -57/01 -57/01-900/56</p>	<p>91-040 844-24 [5]</p>  <p>91-000 646-25 -57/01 -57/01-900/56</p>	<p>91-042 070-24 [5]</p>  <p>91-000 646-25 -58/01 -58/01-900/56</p>	<p>91-040 166-21</p>  <p>91-040 180-25 91-040 466-25 91-000 412-25 91-000 646-25 -57/01 -57/01-900/56 -58/01 -58/01-900/56</p>	
<p>91-040 862-90</p>  <p>91-000 086-15 12-341 090-15 12-341 090-15 91-000 086-15</p> <p>-61/02 -61/02-900/56</p>			<p>91-053 560-91 [5]</p>  <p>-63/13 -63/13-900/56</p>	<p>91-053 567-93 [5]</p>  <p>-63/13 -63/13-900/56</p>
<p>91-043 408-23 [3]</p>  <p>-61/02 -61/02-900/56</p>	<p>91-056 442-93</p>  <p>11-174 167-15 12-305 114-15 91-056 443-93 91-056 445-21</p> <p>-82/14</p>		<p>91-043 938-91</p>  <p>91-000 262-25 91-043 933-92 91-000 089-15 91-000 089-15 91-043 637-25 91-043 937-25 91-043 936-21 91-000 510-15</p> <p>-82/14</p>	

Unterklassen-Übersicht/Table of subclasses/Table des sous-classes/Tabla de subclasses

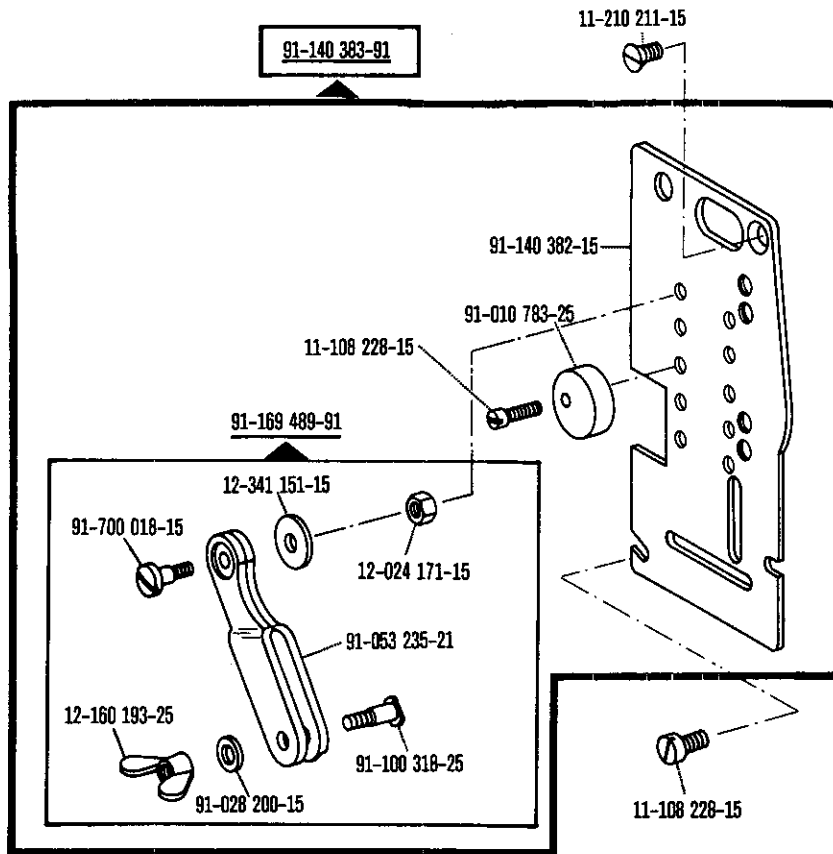

-81/02
-81/02-900/56

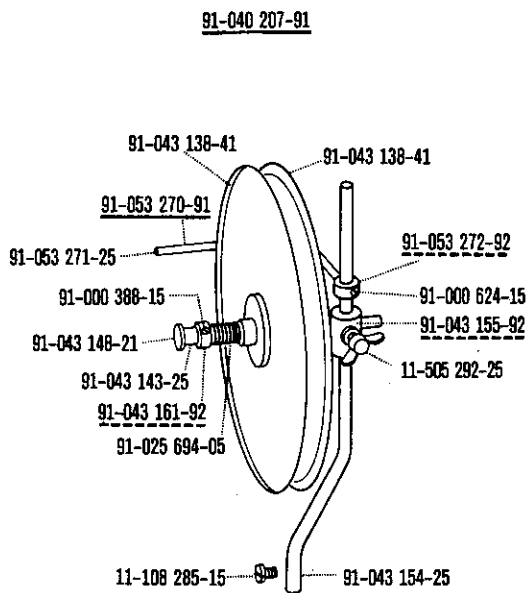

-81/02
-81/02-900/56

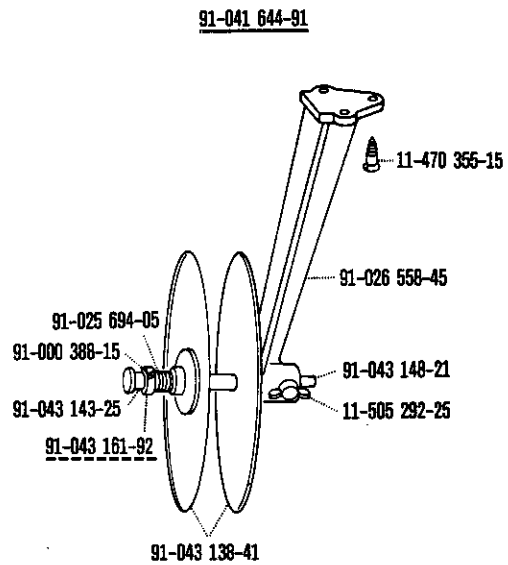

-83/13
-83/13-900/56

Unterklassen-Übersicht/ Table of subclasses/ Table des sous-classes/ Tabla de subclases

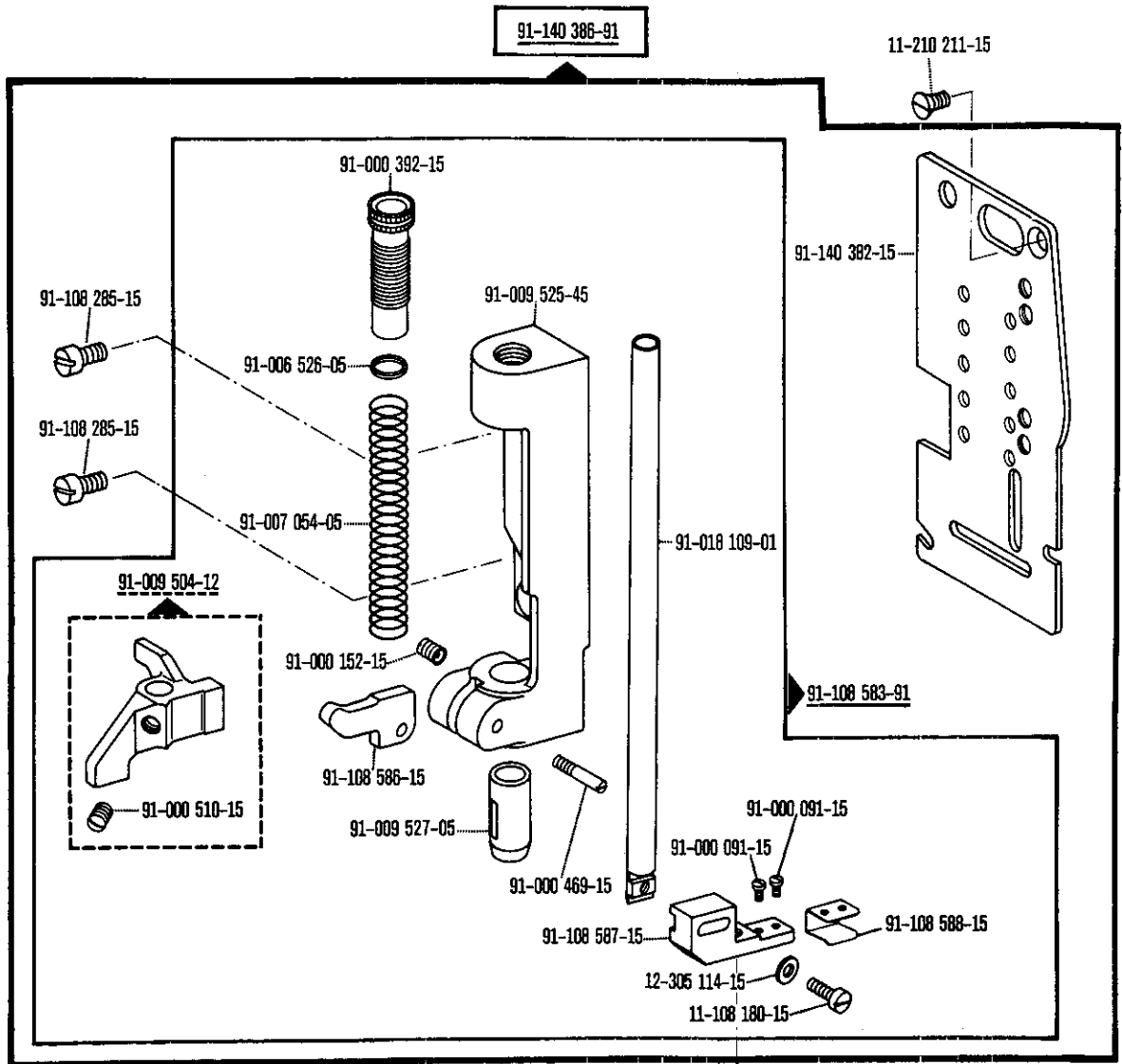

-237/06
-237/06-900/56

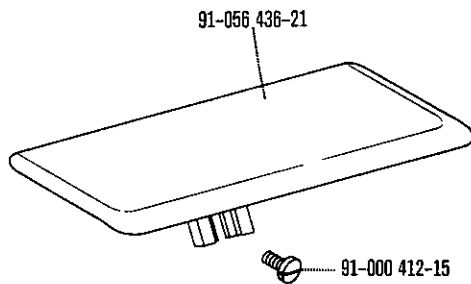

-237/06
-237/06-900/56

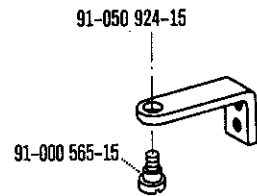

-237/06
-237/06-900/56

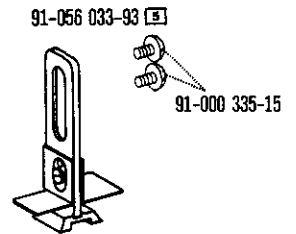

-237/06
-237/06-900/56

91-056 031-15



-237/06
-237/06-900/56

91-056 026-93



-237/06
-237/06-900/56

Unterklassen-Übersicht/Table of subclasses/Table des sous-classes/Tabla de subclasses

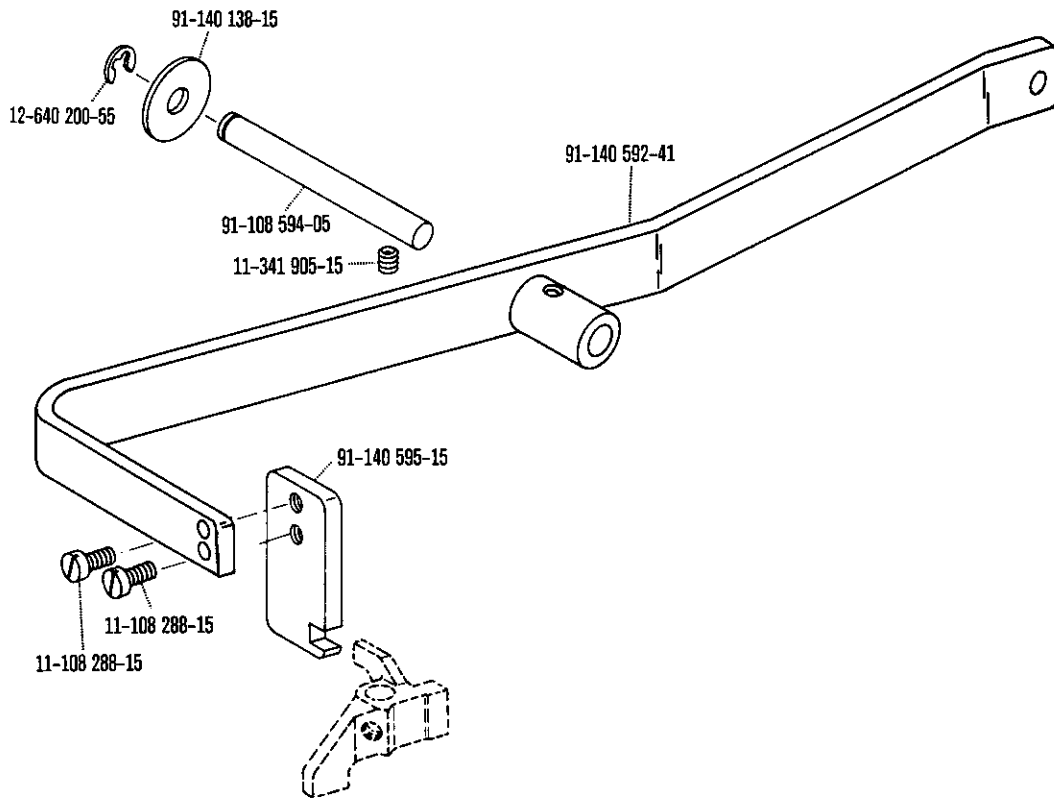

-237/06
-237/06-900/56

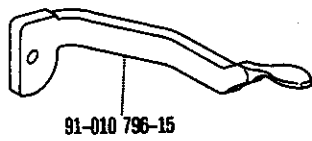

-237/06
-237/06-900/56

99-053 768-91

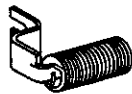

-237/06

91-027 387-91

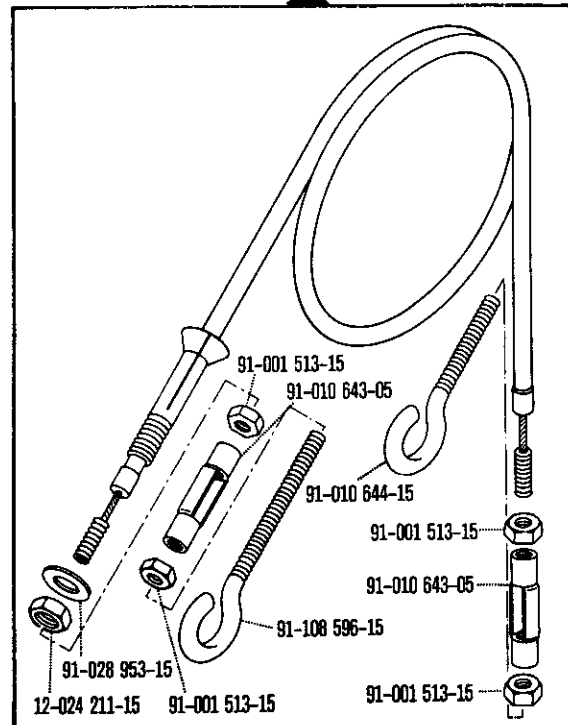

-237/06
-237/06-900/56

Unterklassen-Übersicht/ Table of subclasses/ Table des sous-classes/ Tabla de subclases

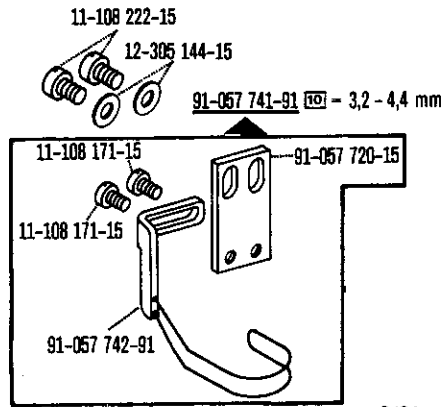

-6/01
-6/01-900/56
-57/01
-57/01-900/56
-58/01
-58/01-900/56
-61/02
-61/02-900/56
-63/13
-63/13-900/56

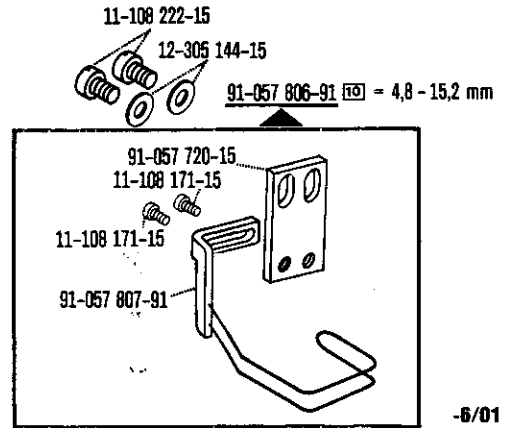

-6/01
-6/01-900/56
-57/01
-57/01-900/56
-58/01
-58/01-900/56
-61/02
-61/02-900/56
-63/13
-63/13-900/56

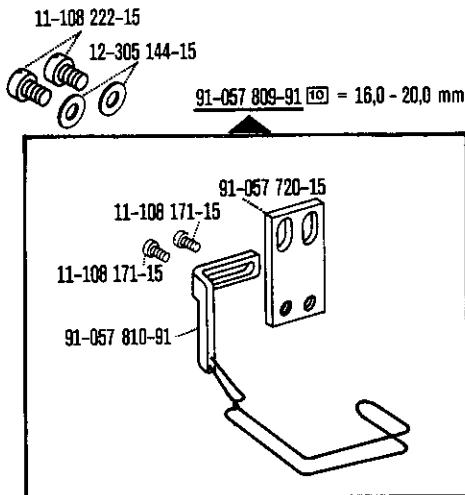

-6/01
-6/01-900/56
-57/01
-57/01-900/56
-58/01
-58/01-900/56
-61/02
-61/02-900/56

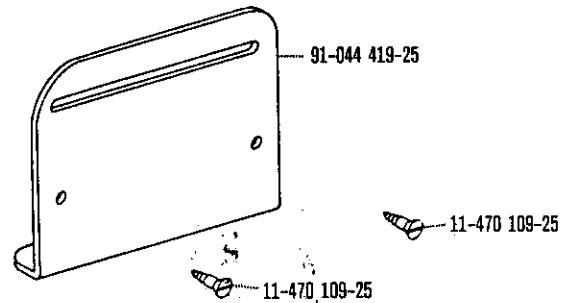

-63/13
-63/13-900/56

Pfaff, D 6750 Kaiserslautern, Postfach 3020/3040, Telefon (0631) 200-0, Telex: 45753, Telefax (0631) 17202