

PFAFF

483-G

Unterklassen-Ausstattung

Subclass parts

Composition des sous-classes

Composición de las subclases

22.03





Unterklassen-Übersicht

Table of subclasses





Table de sous-classes



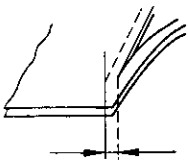
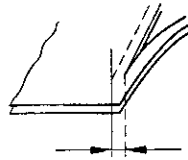







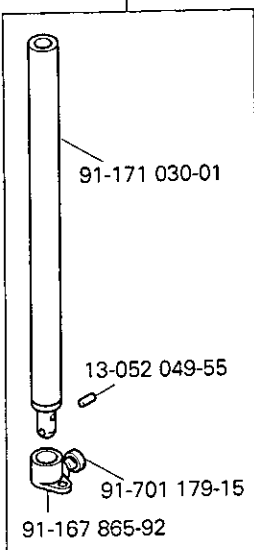

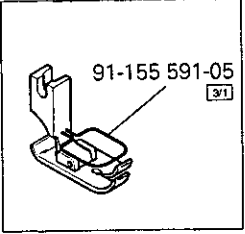

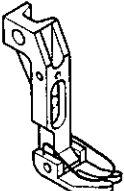

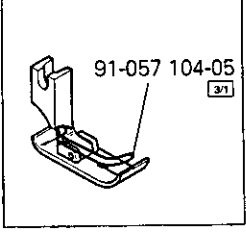
Tabla de subclases

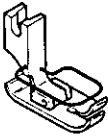
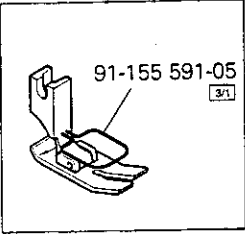
PFAFF 483-G

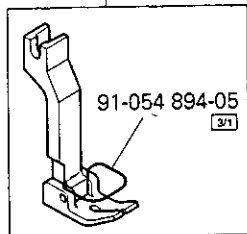
Unterklasse Subclass Sous-classe Subclase	-6/01 (-900/51; /99)	-8/01 (-900/51; /99)	-8/01 (-900/97)	-34/01 (-900/51; /99)
Arbeitsgang Operation Opération Opéracion	Für allgemeine Näharbeiten. Standardform des Teilesatzes. For ordinary sewing operations. Standard part set. Travaux d'utilité courante. Jeu de pièces standard. Para trabajos de costura en general. Juego de piezas estándar.	Universalteilesatz, zum Nähen mittlerer Materialien. Universal part set for sewing medium-weight materials. Jeu de pièces universel, pour matières moyennes. Juego de piezas universal para coser géneros semipesados.	Universalteilesatz, zum Nähen mittlerer Materialien. Universal part set for sewing medium-weight materials. Jeu de pièces universel, pour matières moyennes. Juego de piezas universal para coser géneros semipesados.	Zum Nähen feiner Materialien. Standardform des Teilesatzes. For sewing light fabrics. Standard-size part set. Pour la couture de matières fines. Jeu de pièces standard. Para coser materiales finos. Juego de piezas estándar.
Ausführung Model Version Tipo de máquina	CN	B	B	AN 3,5
Schneidabstand in mm Trimming margin in mm Distance de coupe en mm Margen de corte en mm				
Nadelstange Needle bar Barre à aiguille Barra de aguja	91-171 018-91	91-171 018-91	91-171 018-91	91-171 018-91
Nähfuß  Presser foot Pied presseur Pie prensatelas	91-155 547-03	91-155 589-21	91-155 589-21	91-051 742-23
Rollfuß  Roller presser Pied à roulette Pie rodante				
Stichplatte  Needle plate Plaque à aiguille Placa de aguja	91-058 410-24	91-158 960-25	91-150 498-25	91-150 438-25
Stoffschieber  Feed dog Griffe Transportador inferior	91-047 816-04	91-059 392-05	91-059 479-05	91-059 872-05
Messer  Knife Couteau Cuchilla			91-165 642-15	

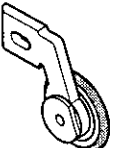
Unterklasse Subclass Sous-classe Subclase	-34/01-900/97	731/11 (/12) -6/01 (-900/51; /99)	731/11 (/12) -6/01 (-900/51; /99)	-748/.. -8/01 (-900/51; /99)
Arbeitsgang Operation Opération Operación	Zum Nähen feiner Materialien. Standardform des Teilesatzes. For sewing light fabrics. Standard-size part set. Pour la couture de matières fines. Jeu de pièces standard. Para coser materiales finos. Juego de piezas estándar.			Universalteilesatz, zum Nähen mittlerer Materialien. Die Maschine ist mit Walzen-transport-Einrichtung ausgestattet. Universal part set for sewing medium-weight materials. The machine is equipped with puller feed. Jeu de pièces universel, pour matières moyennes. La machine est équipée d'un puller. Juego de piezas universal para coser géneros semipesados. La máquina va equipada con un puller.
Ausführung Model Version Tipo de máquina	AN 3,5	B	B	B
Schneidabstand in mm Trimming margin in mm Distance de coupe en mm Margen de corte en mm		2,5 - 3,5	4,0 - 12,0	
Nadelstange Needle bar Barre à aiguille Barra de aguja	91-171 018-91	91-171 663-92	91-171 663-92	91-171 663-92
Nähfuß ⁴ Presser foot Pied presseur Pie prensatelas	91-051 742-23	91-054 338-03 ^{9/2}	91-054 338-03 ^{9/2}	91-154 490-21
Rollfuß ⁴ Roller presser Pied à roulette Pie rodante				
Stichplatte ⁴ Needle plate Plaque à aiguille Placa de aguja	91-150 516-25	91-158 499-93	91-159 503-93	91-158 960-25
Stoffschieber ⁴ Feed dog Griffe Transportador inferior	91-059 480-05	91-059 644-04	91-059 644-04	91-059 392-05
Messer ^{9/2} Knife Couteau Cuchilla	91-165 642-15	91-169 395-04 x 7 ⁹ = 2,5 - 3,5 mm	91-169 395-04 x 7 ⁹ = 2,5 - 3,5 mm 91-170 560-04 x 9 ⁹ = 6,0 - 12,0 mm	

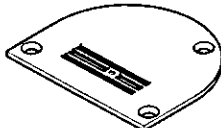
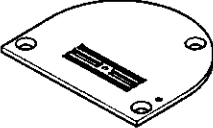
Unterklasse Subclass Sous-classe Subclase	-748/26 -34/01 (-900/51; /99)	-944/07 (-900/51; /99)	-944/07 (-900/51; /99)
Arbeitsgang Operation Opération Opération	Universalteilesatz, zum Nähen mittlerer Materialien. Die Maschine ist mit Walzentransport-Einrichtung ausgestattet. Universal part set for sewing medium-weight materials. The machine is equipped with puller feed. Jeu de pièces universel, pour matières moyennes. La machine est équipée d'un puller. Juego de piezas universal para coser géneros semipesados. La máquina va equipada con un puller.	Für Stepparbeiten an Schuhschäften und sonstigen Lederwaren mittels Rollfuß (verkleinerter Teilesatz). For sewing operations on shoe uppers and other leather articles; machine equipped with roller presser and small-size parts set. Pour les piqûres sur tiges de chaussures et sur d'autres articles en cuir. Comprend un pied à roulette (pièces plus petites). Para trabajos de aparado en cortes de calzado y demás artículos de cuero mediante pie rodante. (Juego de piezas reducido).	Für Stepparbeiten an Schuhschäften und sonstigen Lederwaren mittels Rollfuß (verkleinerter Teilesatz). For sewing operations on shoe uppers and other leather articles; machine equipped with roller presser and small-size parts set. Pour les piqûres sur tiges de chaussures et sur d'autres articles en cuir. Comprend un pied à roulette (pièces plus petites). Para trabajos de aparado en cortes de calzado y demás artículos de cuero mediante pie rodante. (Juego de piezas reducido).
Ausführung Model Version Tipo de máquina	AN 3,5	B	CN
Schneidabstand in mm Trimming margin in mm Distance de coupe en mm Margen de corte en mm			
Nadelstange Needle bar Barre à aiguille Barra de aguja	91-171 663-92	91-171 663-92	91-171 663-92
Nähfuß  Presser foot Pied presseur Pie prensatelas	91-157 866-03		
Rollfuß  Roller presser Pied à roulette Pie rodante		91-051 155-93	91-051 155-93
Stichplatte  Needle plate Plaque à aiguille Placa de aguja	91-150 438-25	91-158 156-04	91-158 156-04
Stoffschieber  Feed dog Griffe Transportador inferior	91-059 872-05	91-059 209-04	91-059 209-04
Messer  Knife Couteau Cuchilla			

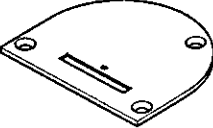

<p>91-171 018-91</p>  <p>91-171 030-01</p> <p>13-052 049-55</p> <p>91-701 179-15</p> <p>91-167 865-92</p> <p>-6/01 (-900/..) -8/01 (-900/..) -34/01 (-900/..)</p>	<p>91-171 663-92</p>  <p>11-330 085-15</p> <p>-731/11-6/01 (-900/..) -731/12-6/01 (-900/..) -748/26-8/01 (-900/..) -748/27-8/01 (-900/..) -748/26-34/01 (-900/..) -944/07 (-900/..)</p>	<p>91-051 742-23 </p>  <p>91-155 591-05 </p> <p>-34/01 (-900/..)</p> <p>91-154 490-21 </p>  <p>-748/26-8/01 (-900/51; /99) -748/27-8/01 (-900/51; /99)</p>	<p>91-054 338-03  </p>  <p>91-057 104-05 </p> <p>-731/11-6/01 (-900/51; /99) -731/12-6/01 (-900/51; /99)</p> <p>91-155 547-03 </p>  <p>-6/01 (-900/..)</p>
<p>91-155 599-21</p>  <p>91-155 591-05 </p> <p>-8/01 (-900/..)</p>	<p>91-157 866-03 </p>  <p>91-054 894-05 </p> <p>-748/26-34/01 (-900/..)</p>	<p>91-051 155-93 </p>  <p>-944/07 (-900/..)</p>	<p>91-058 410-24 </p>  <p>-6/01 (-900/..)</p>
<p>91-150 438-25</p>  <p>-34/01 (-900/51; /99) -748/26-34/01 (-900/51; /99)</p>	<p>91-150 498-25</p>  <p>-8/01-900/97</p>	<p>91-150 516-25</p>  <p>-34/01-900/97</p>	<p>91-158 156-04 </p>  <p>-944/07(-900/..)</p>

22.04

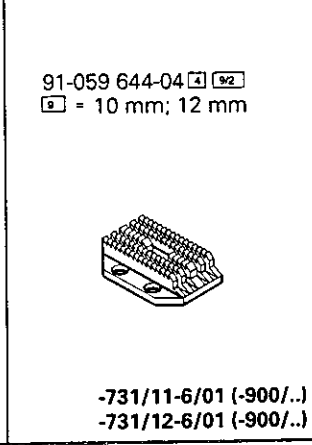
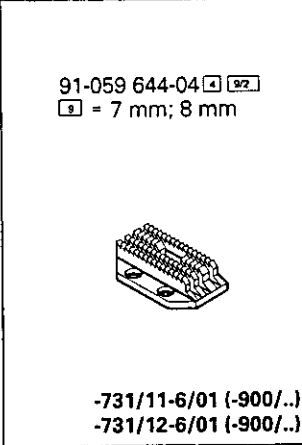
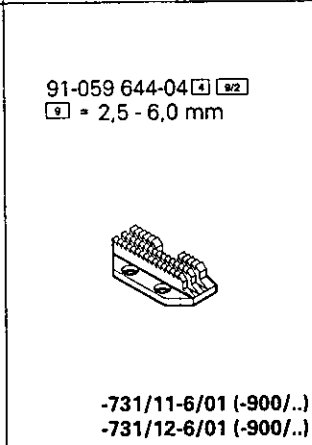
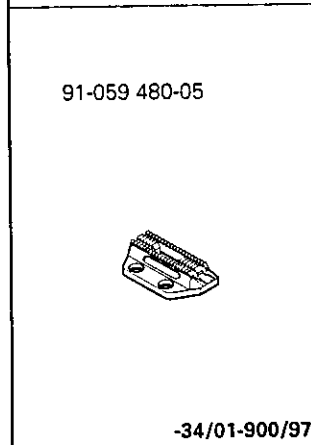
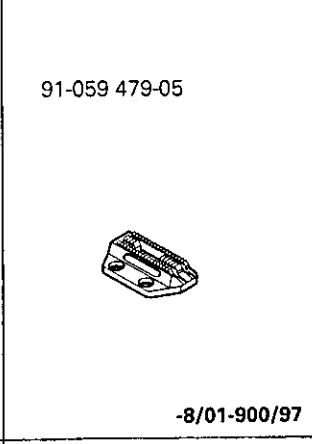
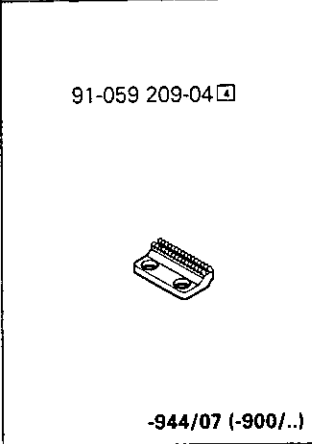
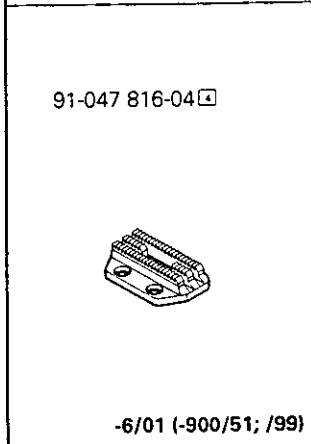
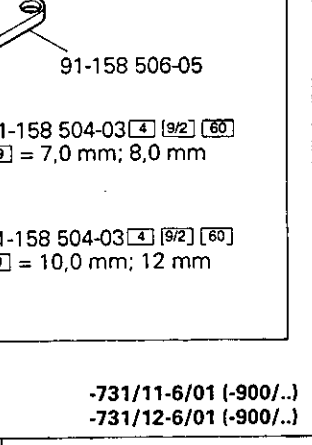
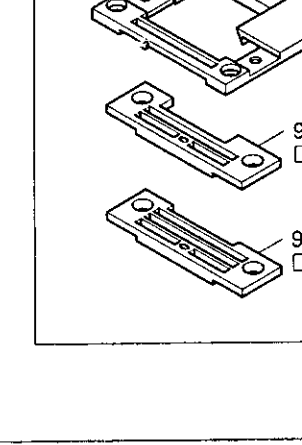
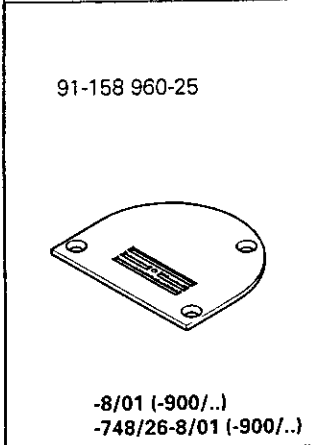
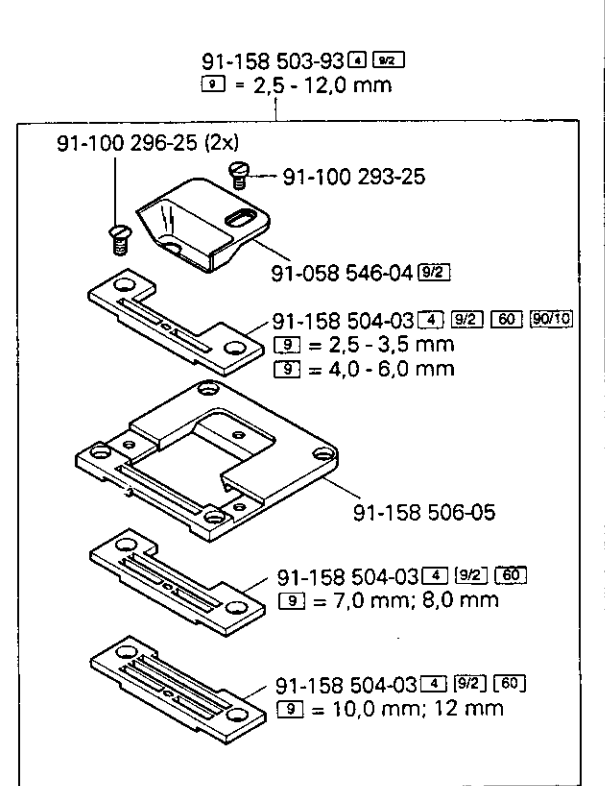
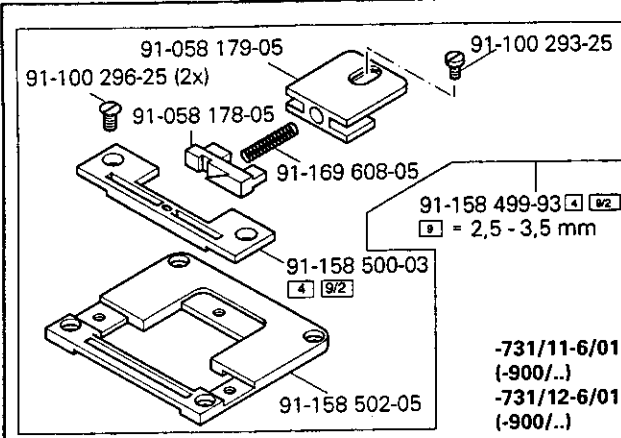
Nähwerkzeuge
Gauge parts
Organes de couture
Organos de costura PFAFF 483-G

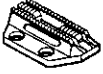
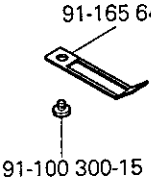

☐ siehe Kapitel 2 Erläuterung der Schlüsselzeichen
see chapter 2 Explanation of key markings
voir le chap. 2 Explication des symboles

<p>91-059 872-05</p>  <p>-34/01 (-900/51; /99) -748/26-34/01 (-900/51; /99)</p>	<p>91-165 642-15</p>  <p>91-100 300-15</p> <p>-8/01-900/97 -34/01-900/97</p>	<p>91-169 395-04 x 7 9/2 9 = 2,5 - 5,0 mm</p>  <p>-731/11-6/01 (-900..) -731/12-6/01 (-900..)</p>	<p>91-170 560-04 x 9 9/2 9 = 6,0 - 12,0 mm</p>  <p>-731/11-6/01 (-900..) -731/12-6/01 (-900..)</p>
---	--	--	---

PFAFF