

FORM 20854

(1157)

Printed in U.S.A.

SINGER^{*}

246-15

THE SINGER COMPANY

* A Trademark of THE SINGER COMPANY

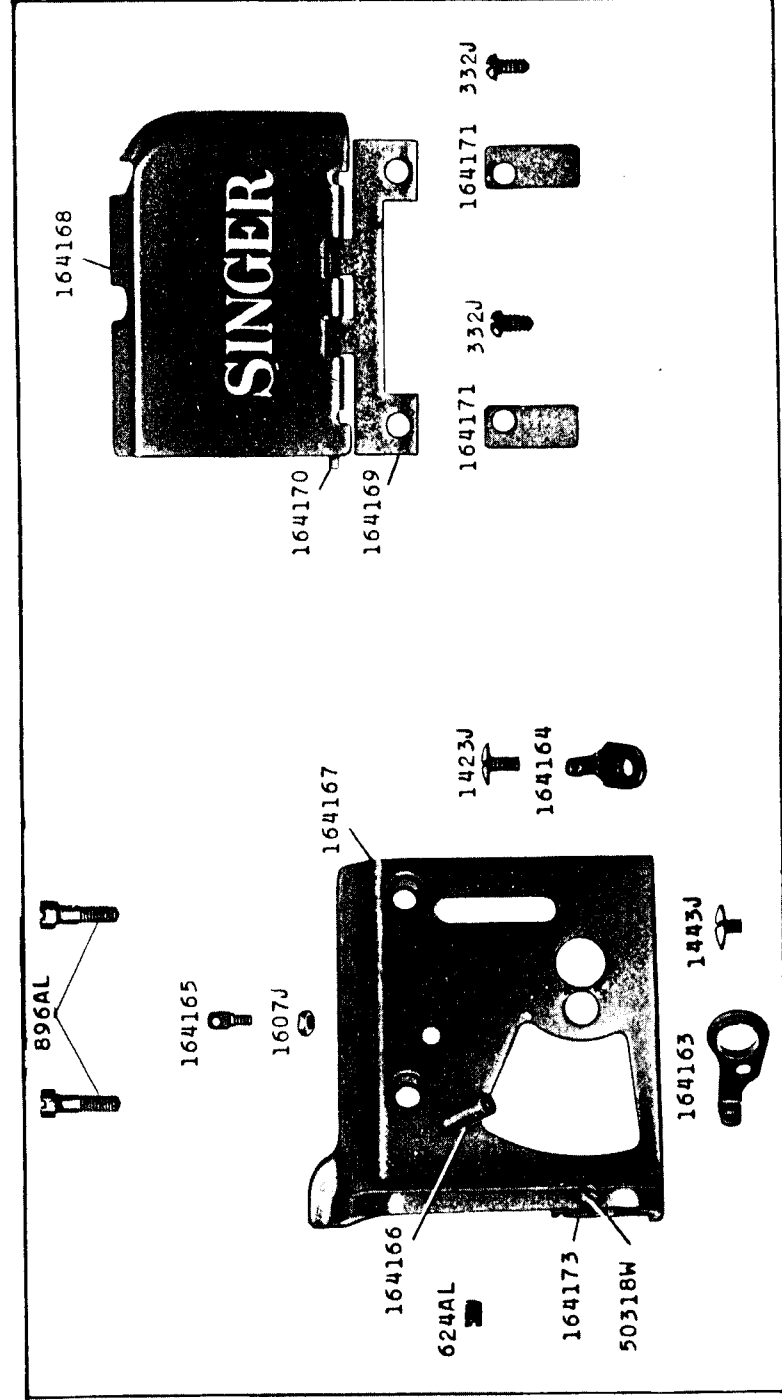

24764 - 1/6

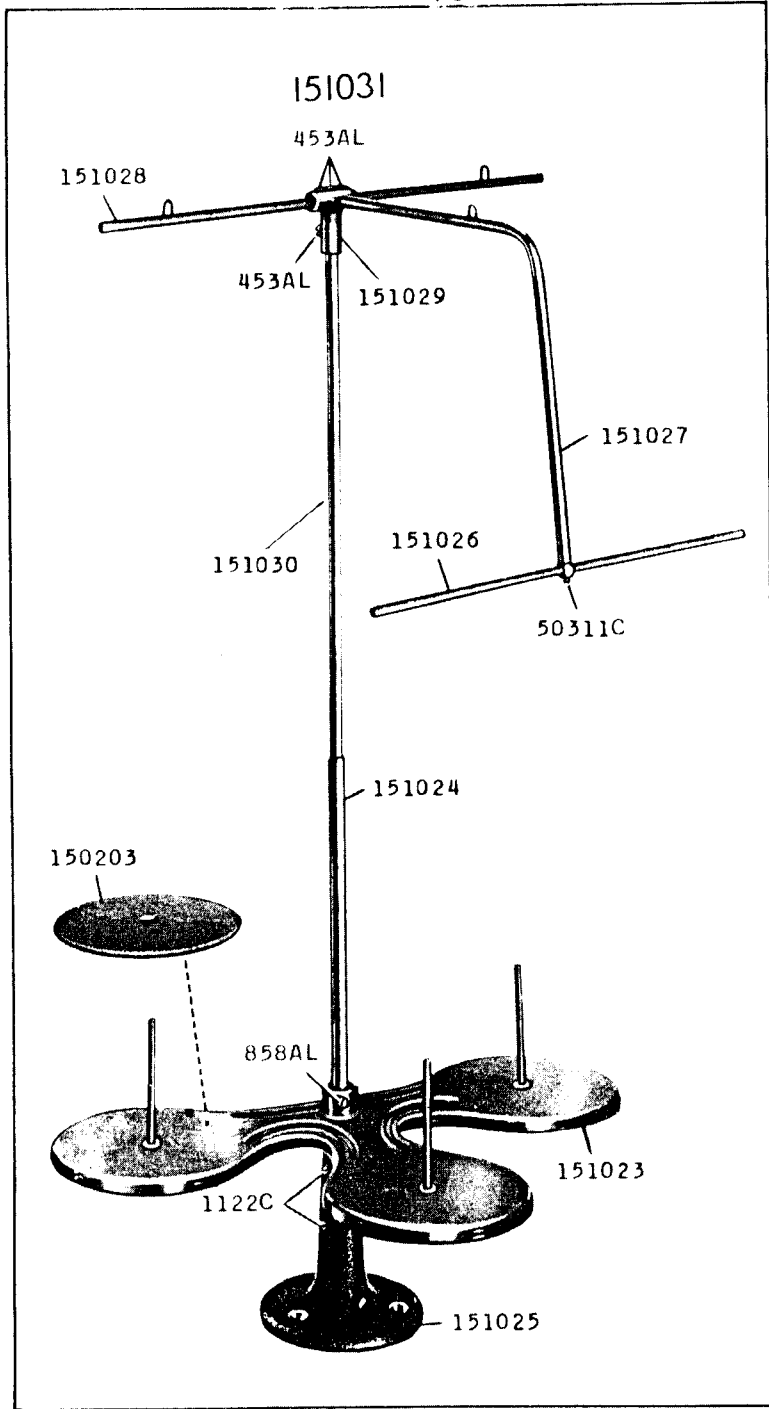

24772 - 1/3

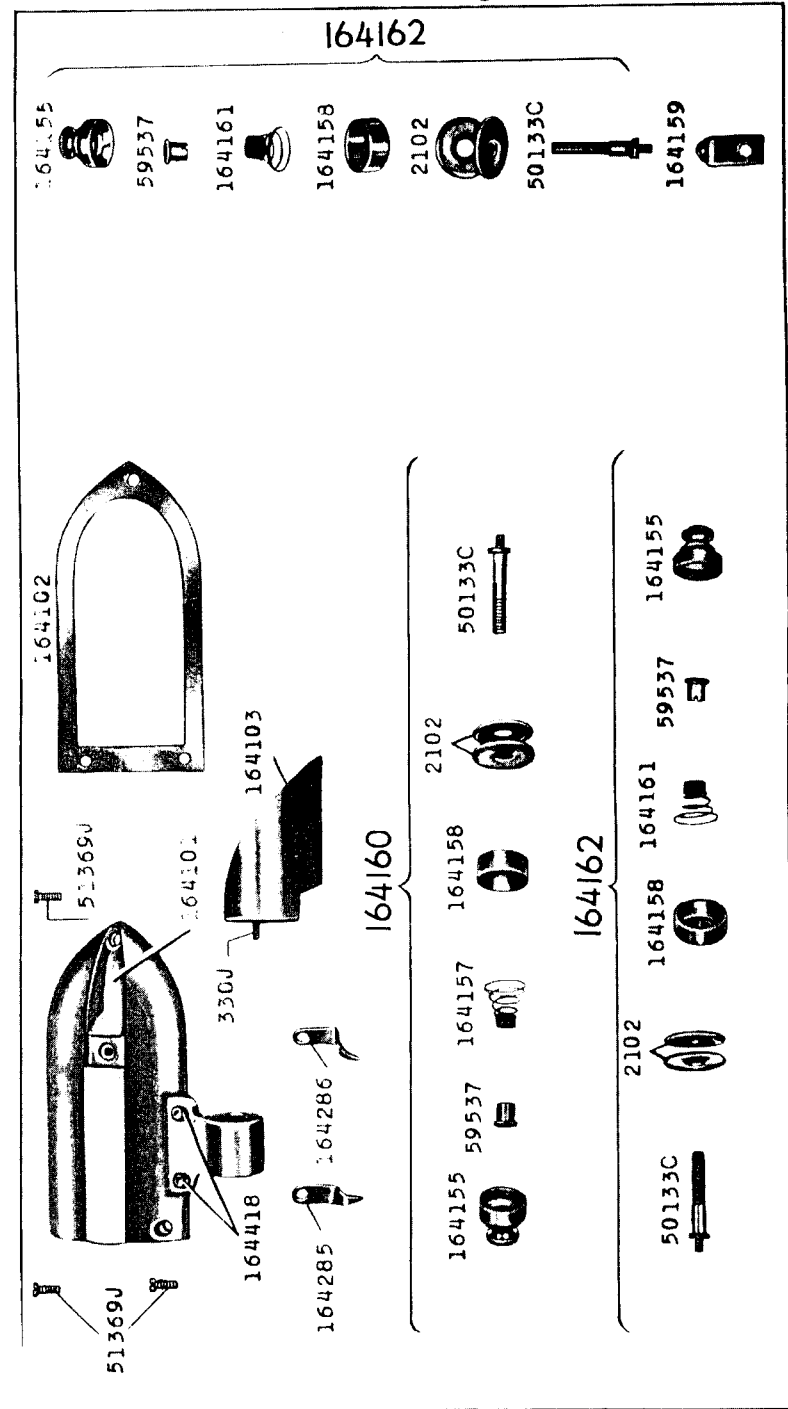

24813-1/3

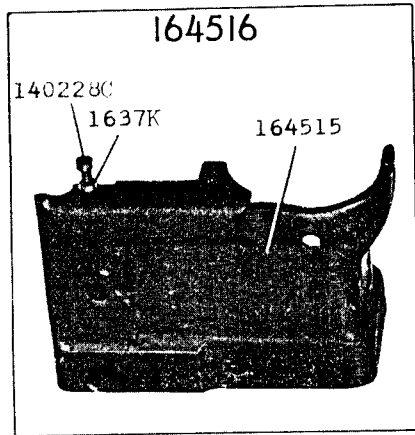
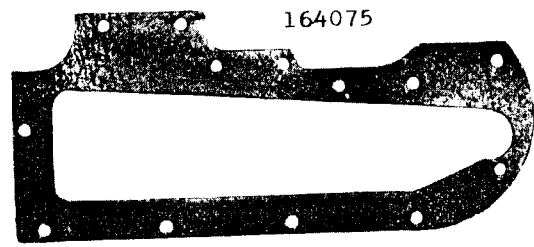
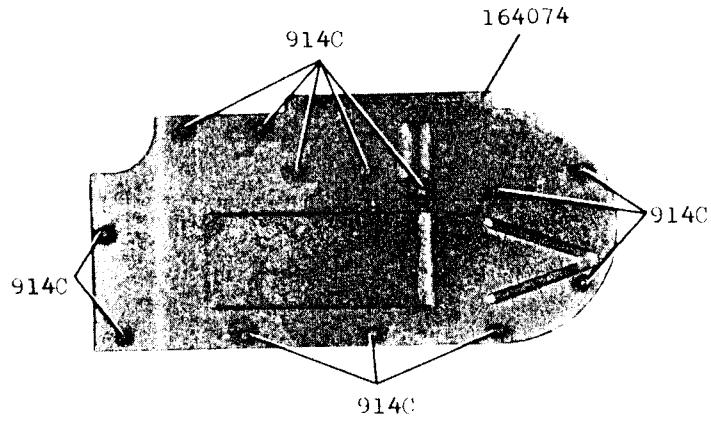

140228C
1637K

164515

914J

50571J

24829-1/2

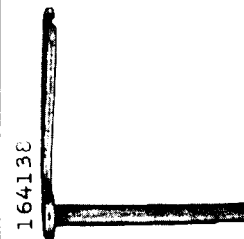

164139

164137 462AL

624AL

51846

164142

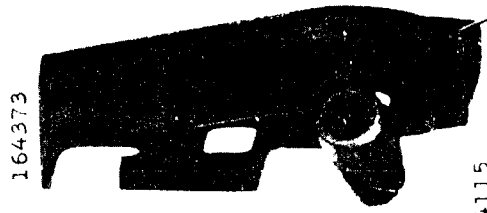
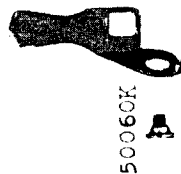

1259AL

50073J

50073J



51023W

164144 164194



164143



164115

140596AL

164118

164112

164117

1083C

51720C

164114

164109

452AL

164113

164110

164111

24855-1/2

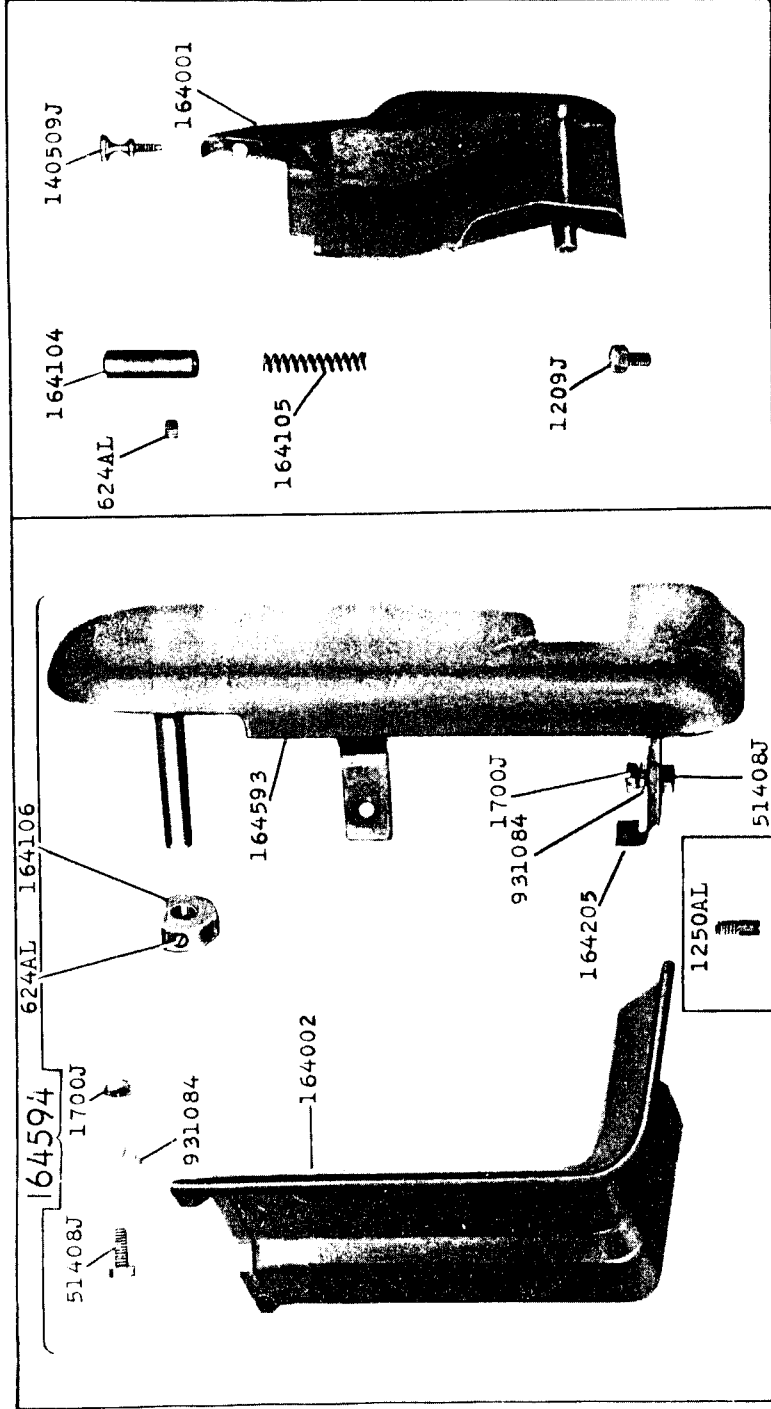

24856-1/2

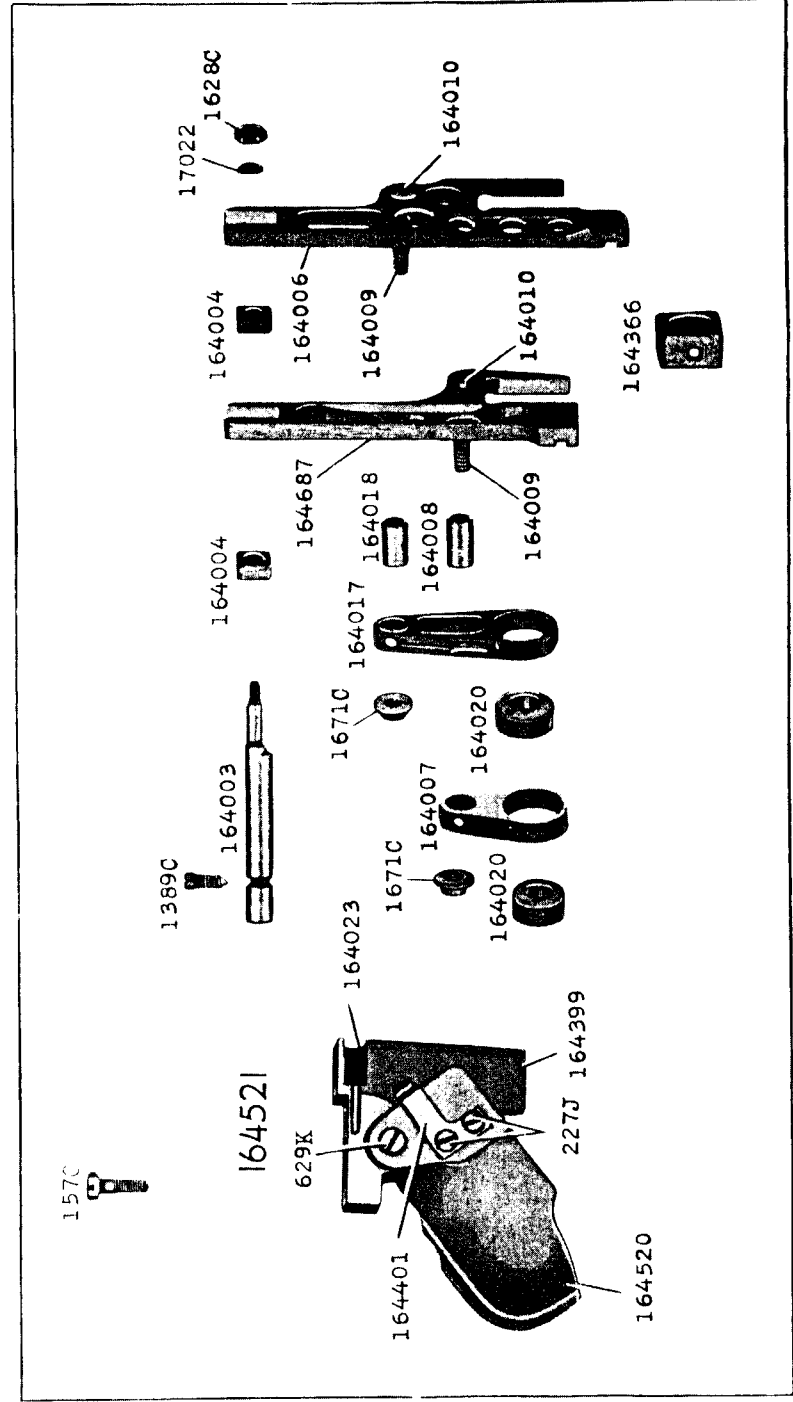

24861-2/3

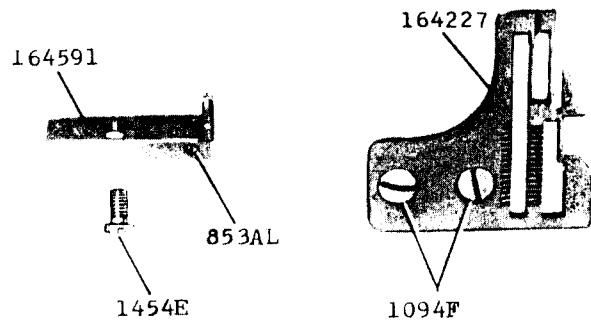
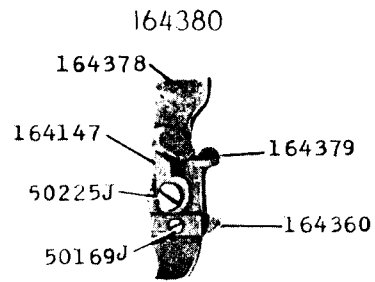
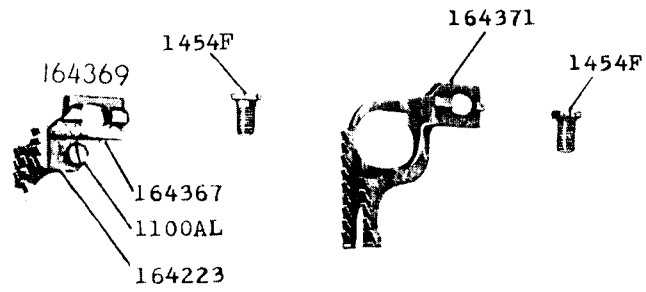

24862-2/3

164391

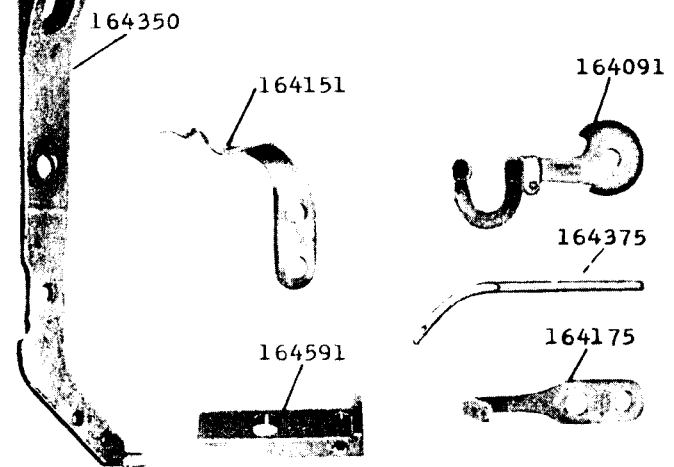
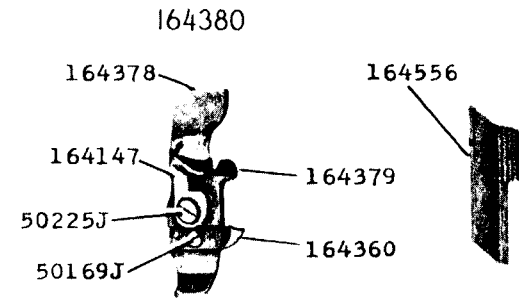
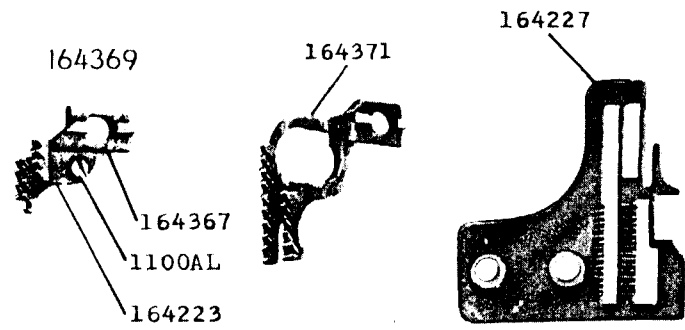

24863-1/2

164445

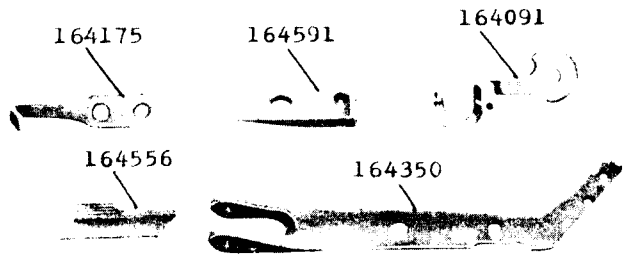
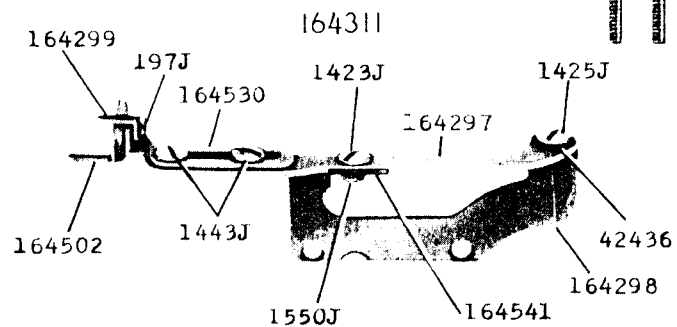
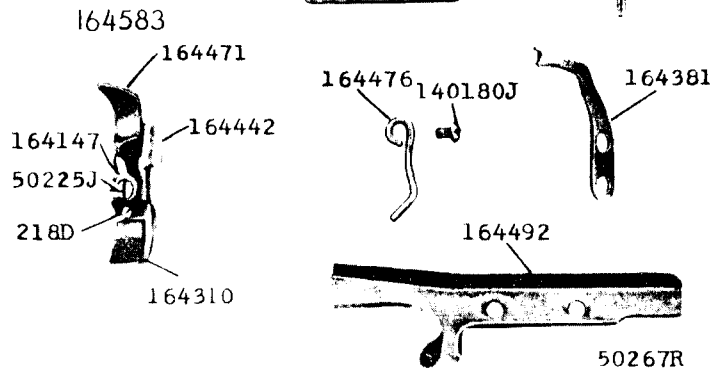
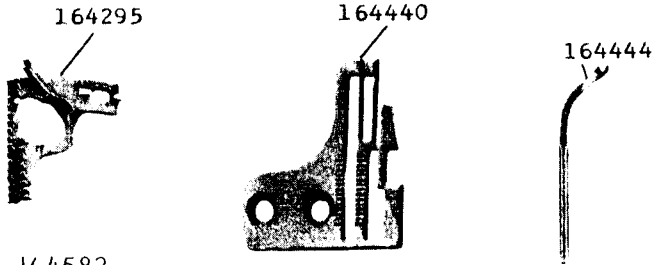

24864-1/2

164542

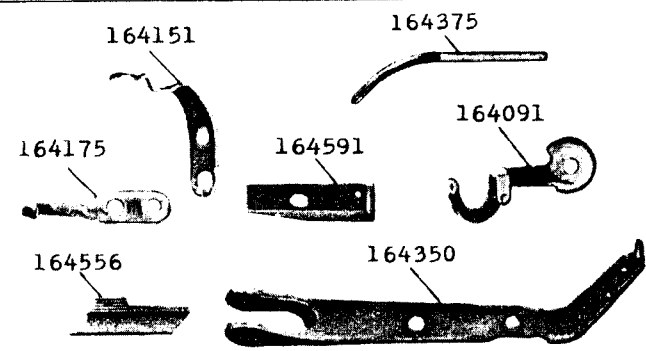
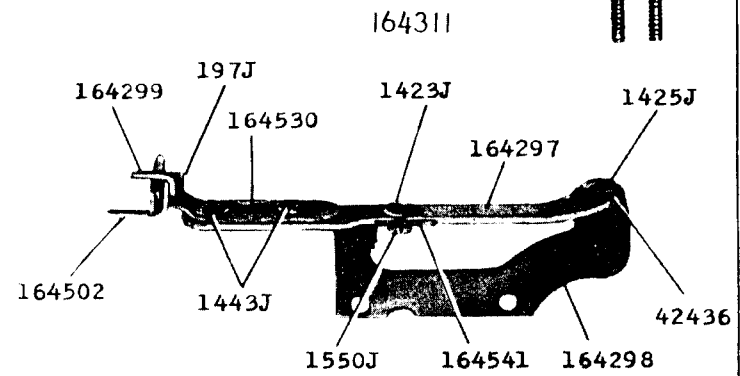
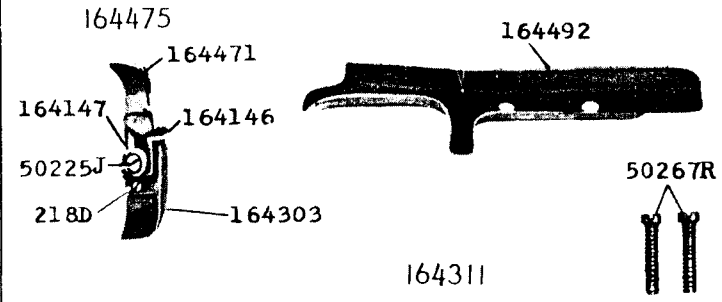
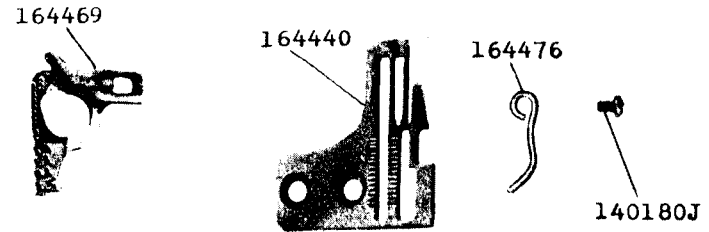

24865-1/2

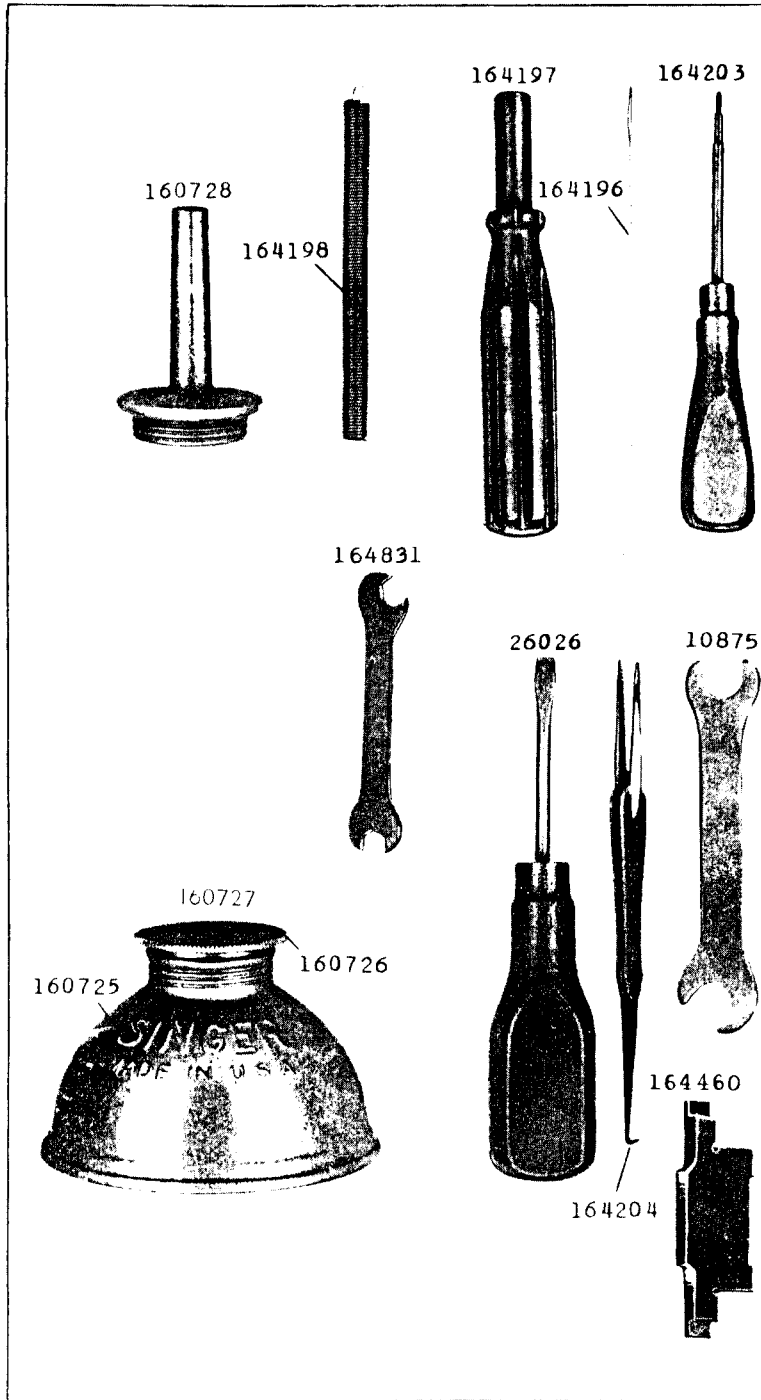

24866 - 1/4

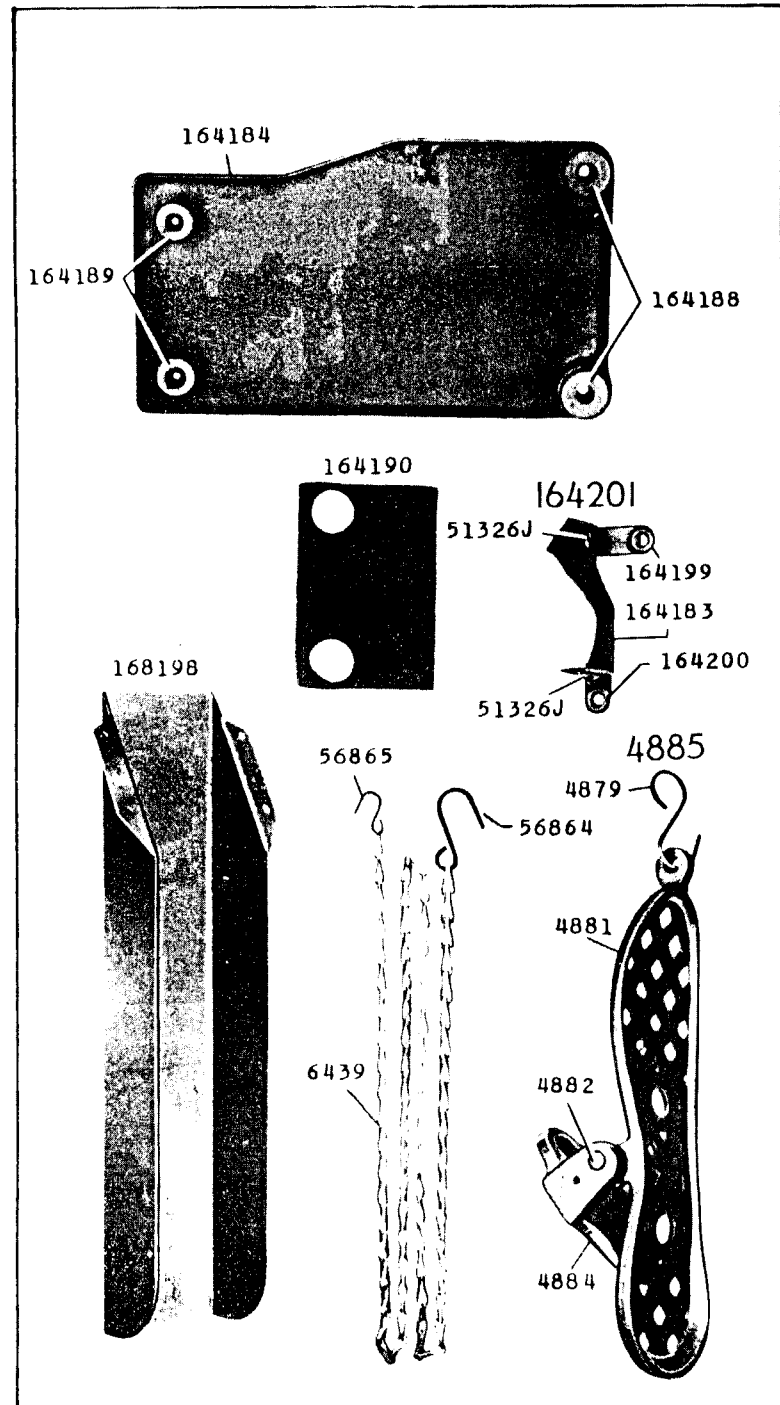

24867 - 1/6

