

SINGER
28K,127K,128K

Form K5778
(Supersedes K1110)

ILLUSTRATED LIST OF PARTS

FOR

28K, 127K and 128K MACHINES

VIBRATING SHUTTLE MACHINES
FOR FAMILY USE

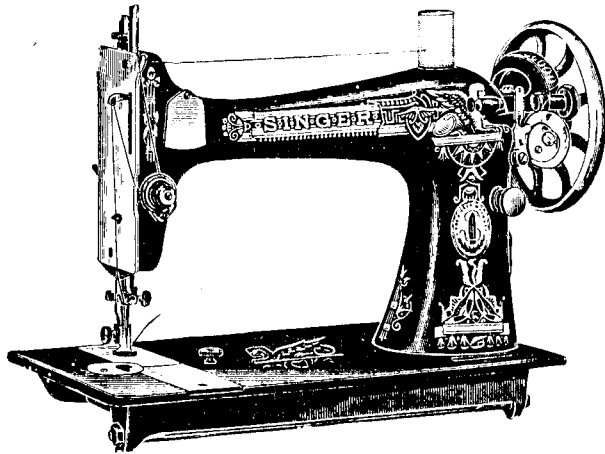

**A Trade Mark of
THE SINGER MANUFACTURING CO.

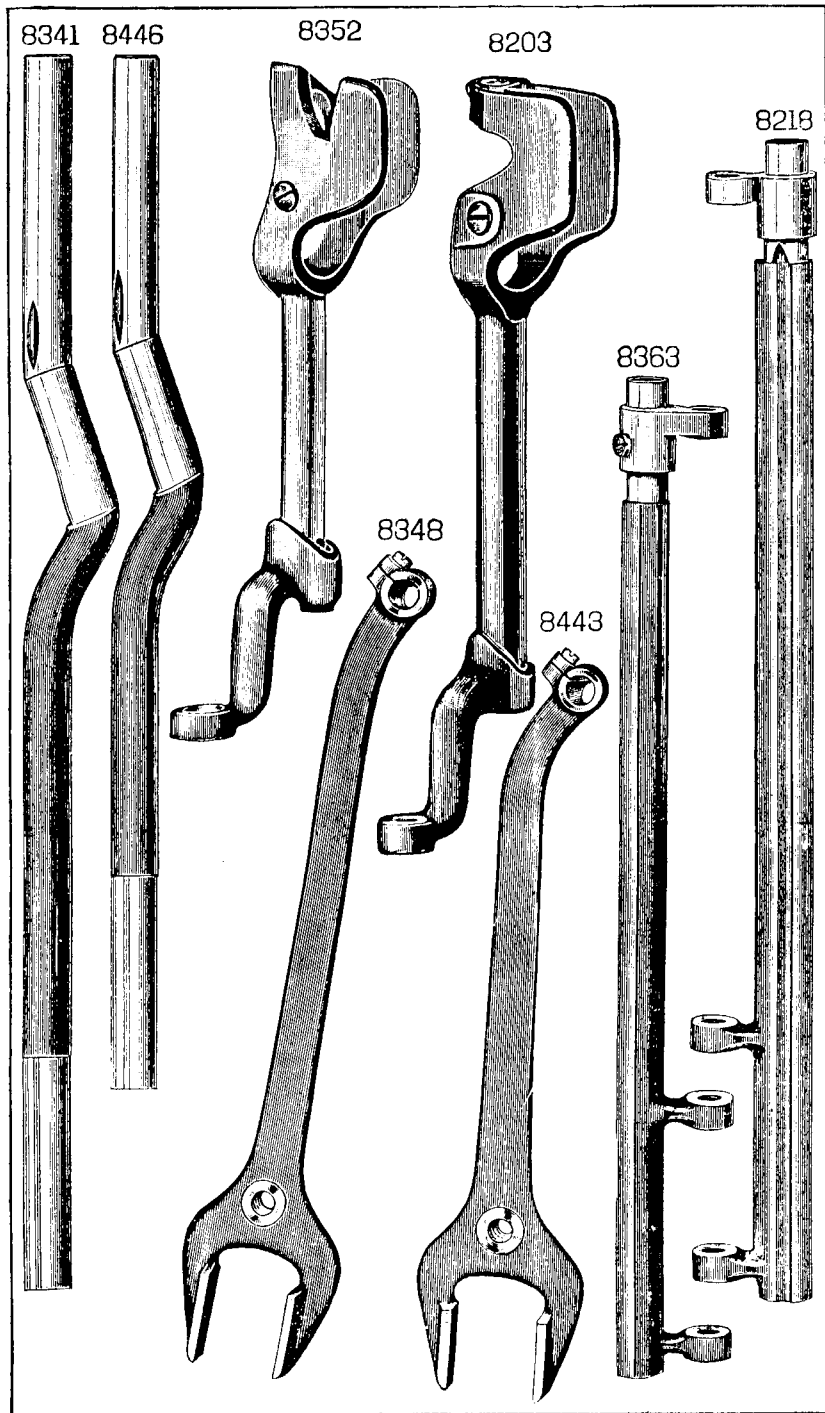

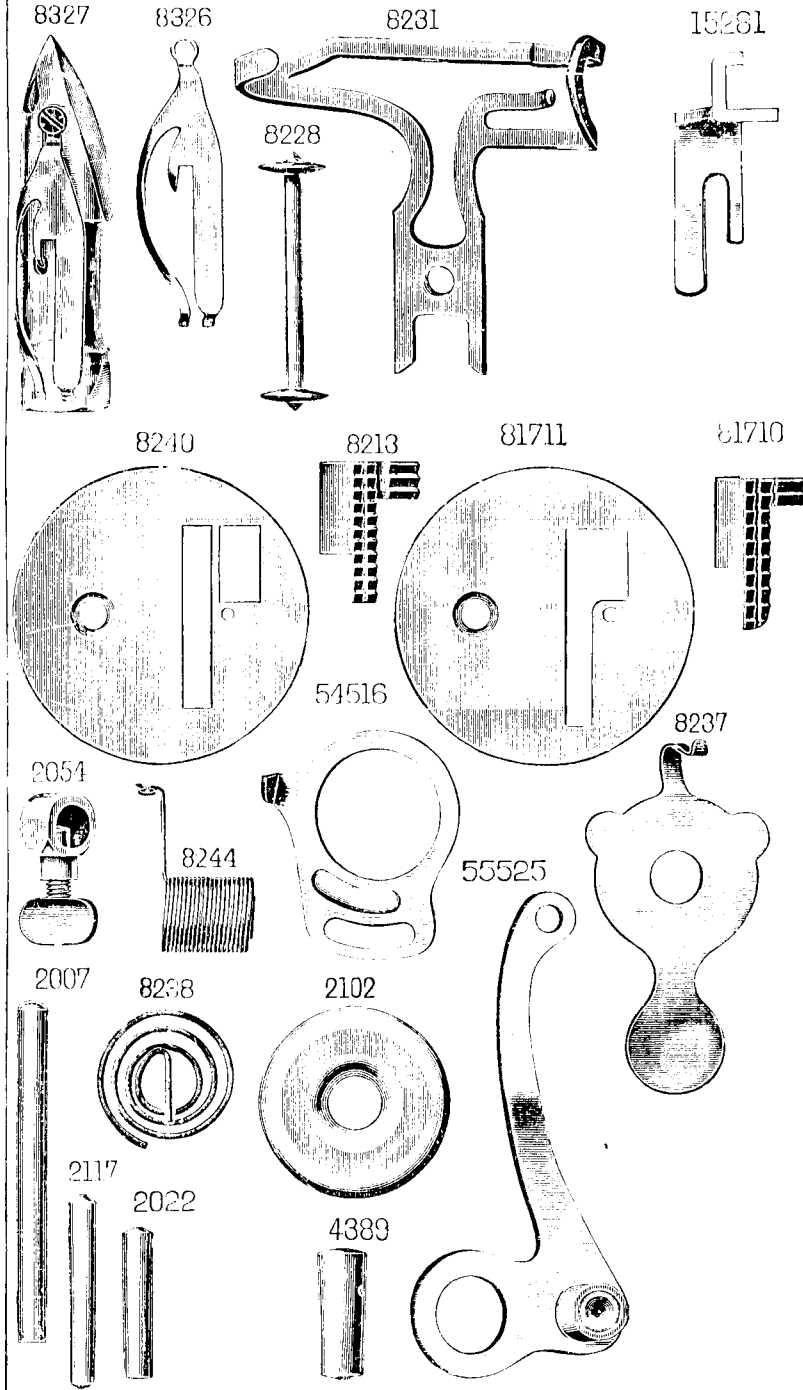
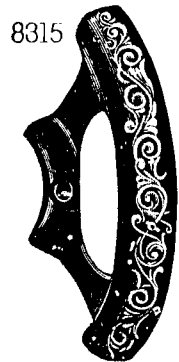
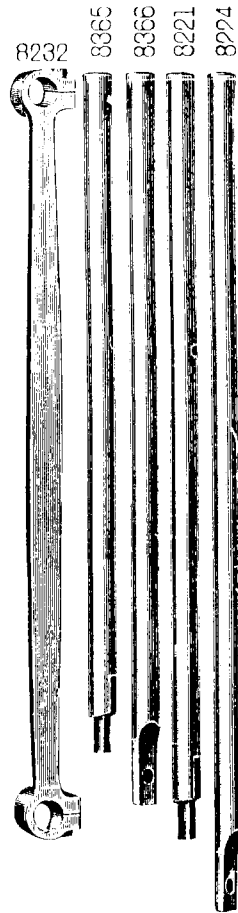
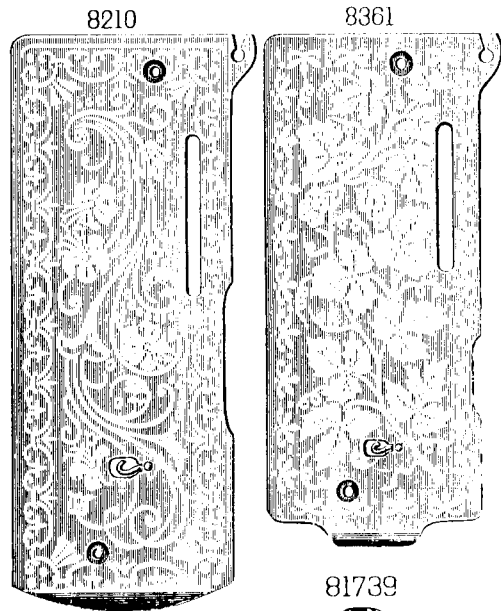

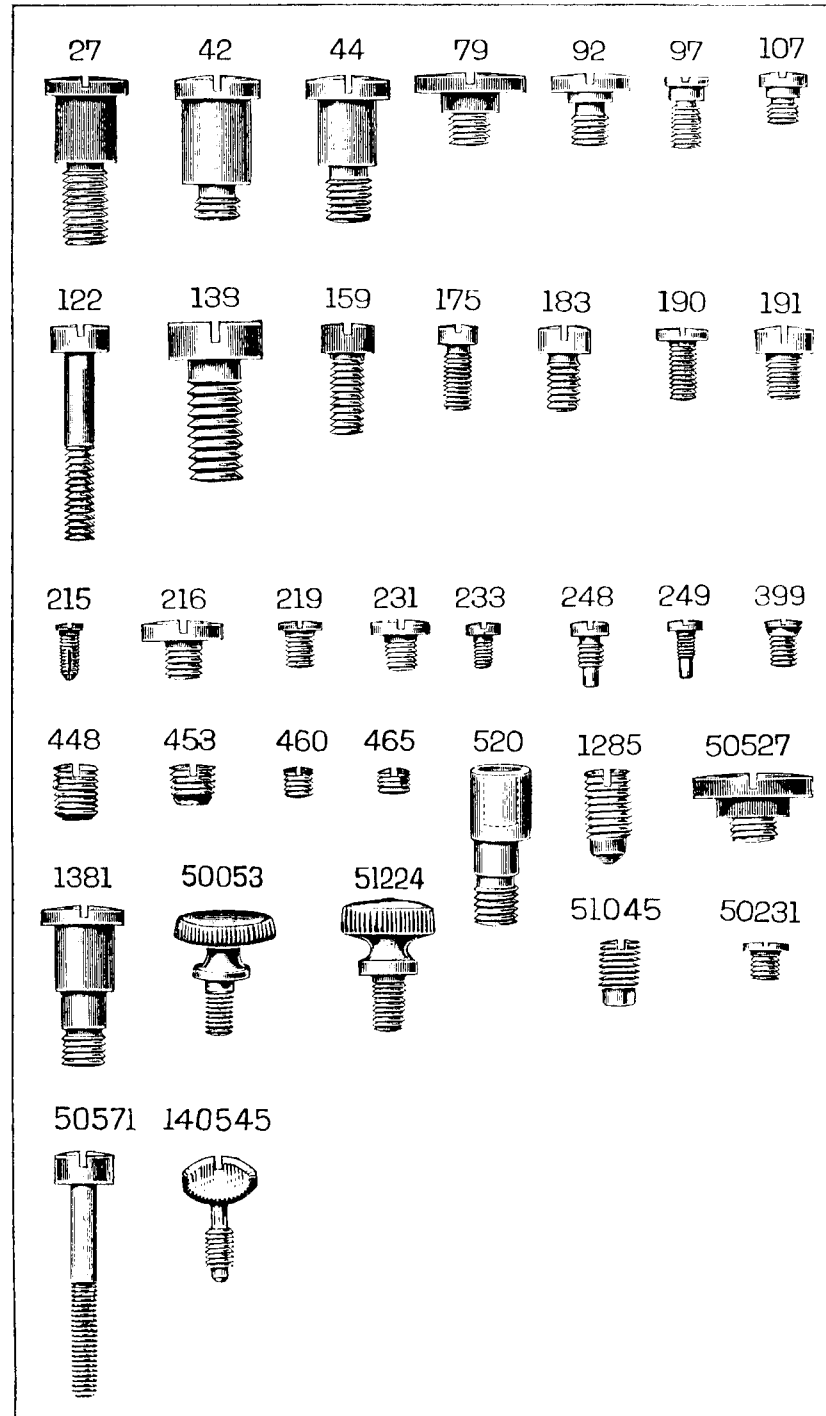
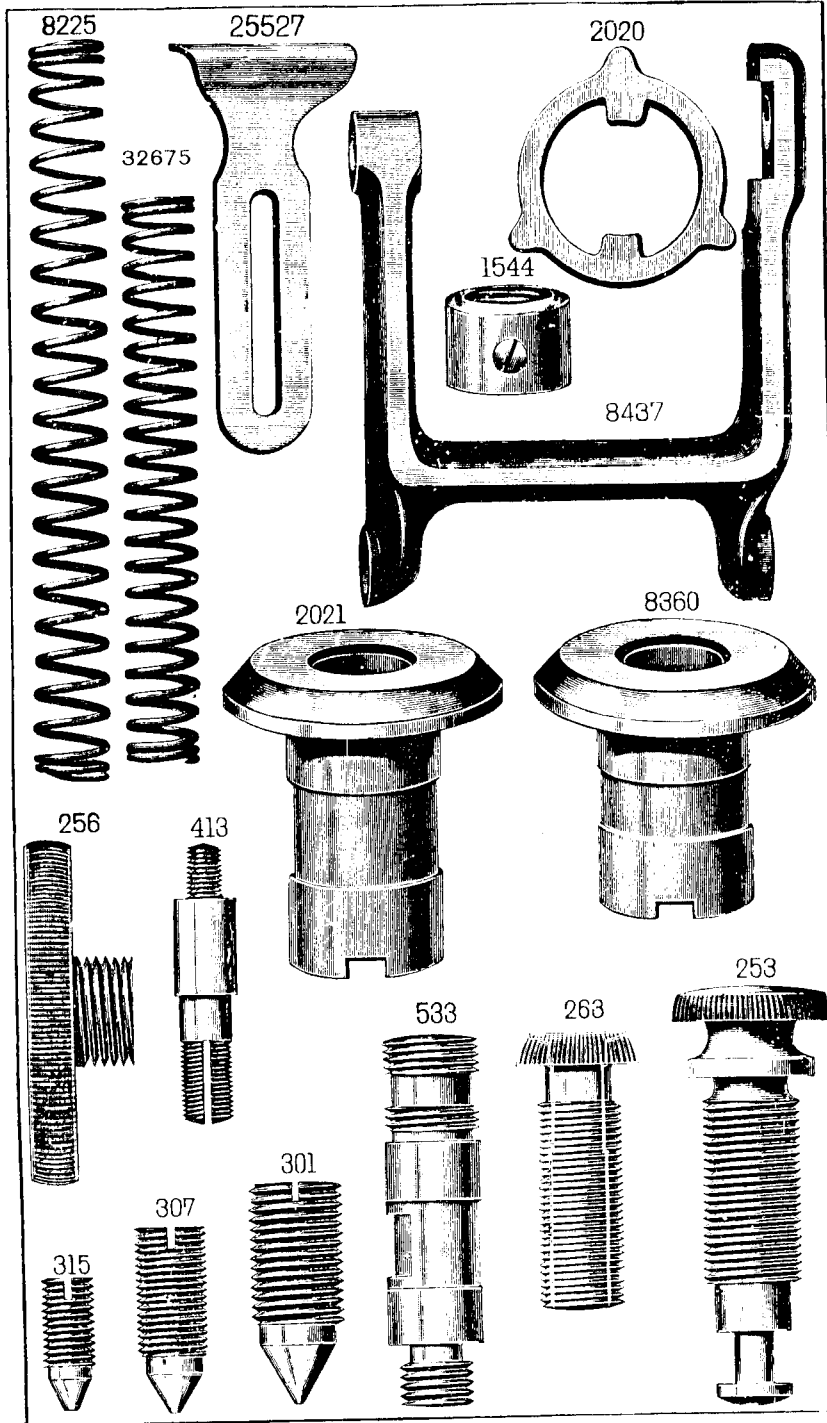

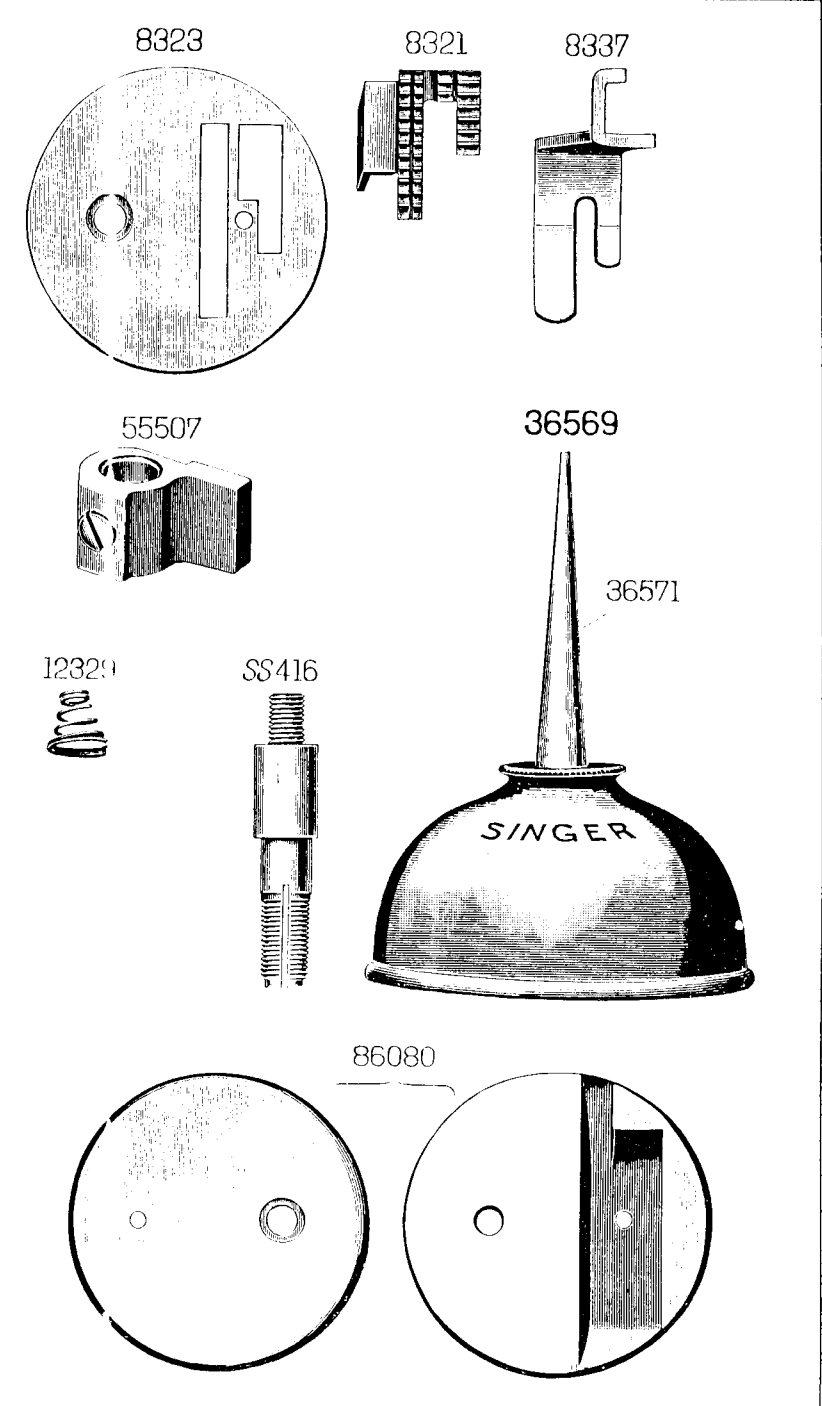
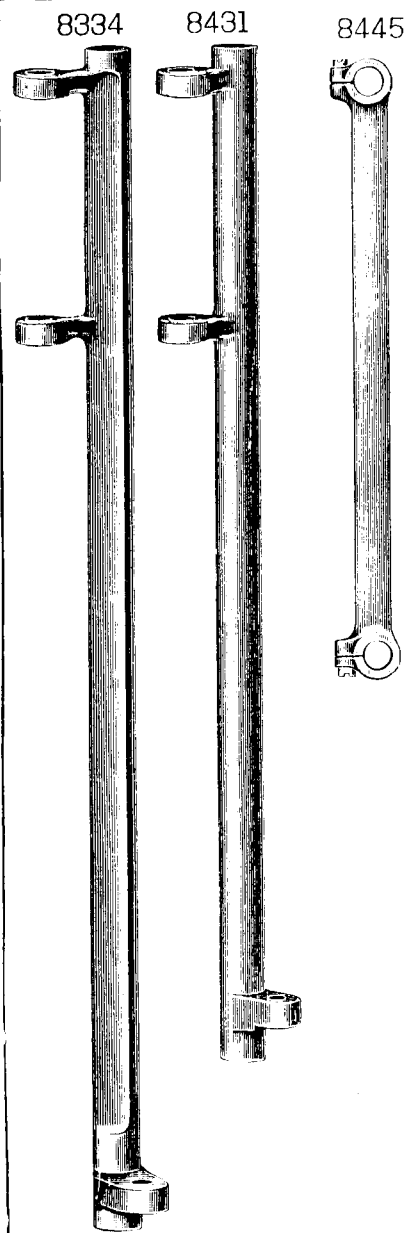

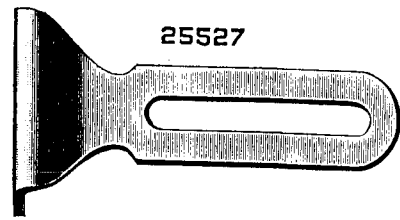

25537

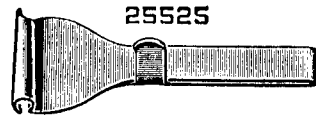
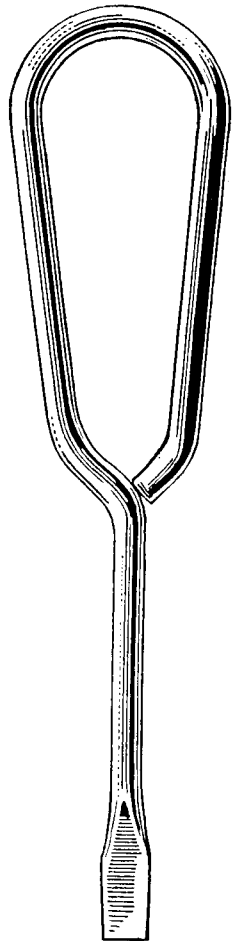

25539

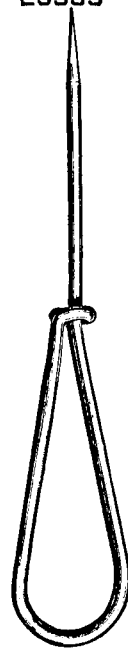

120378



35934

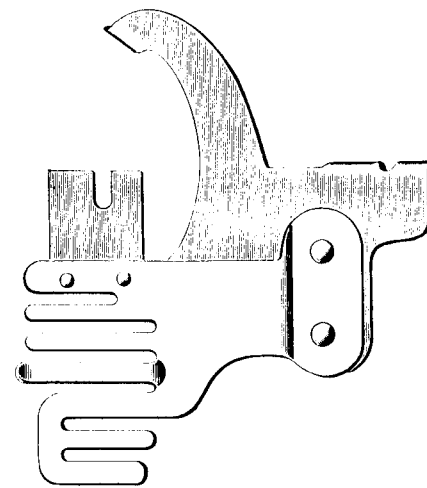

35937

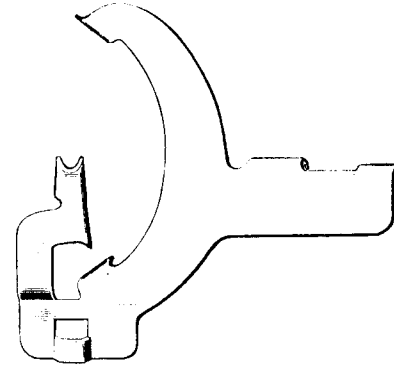

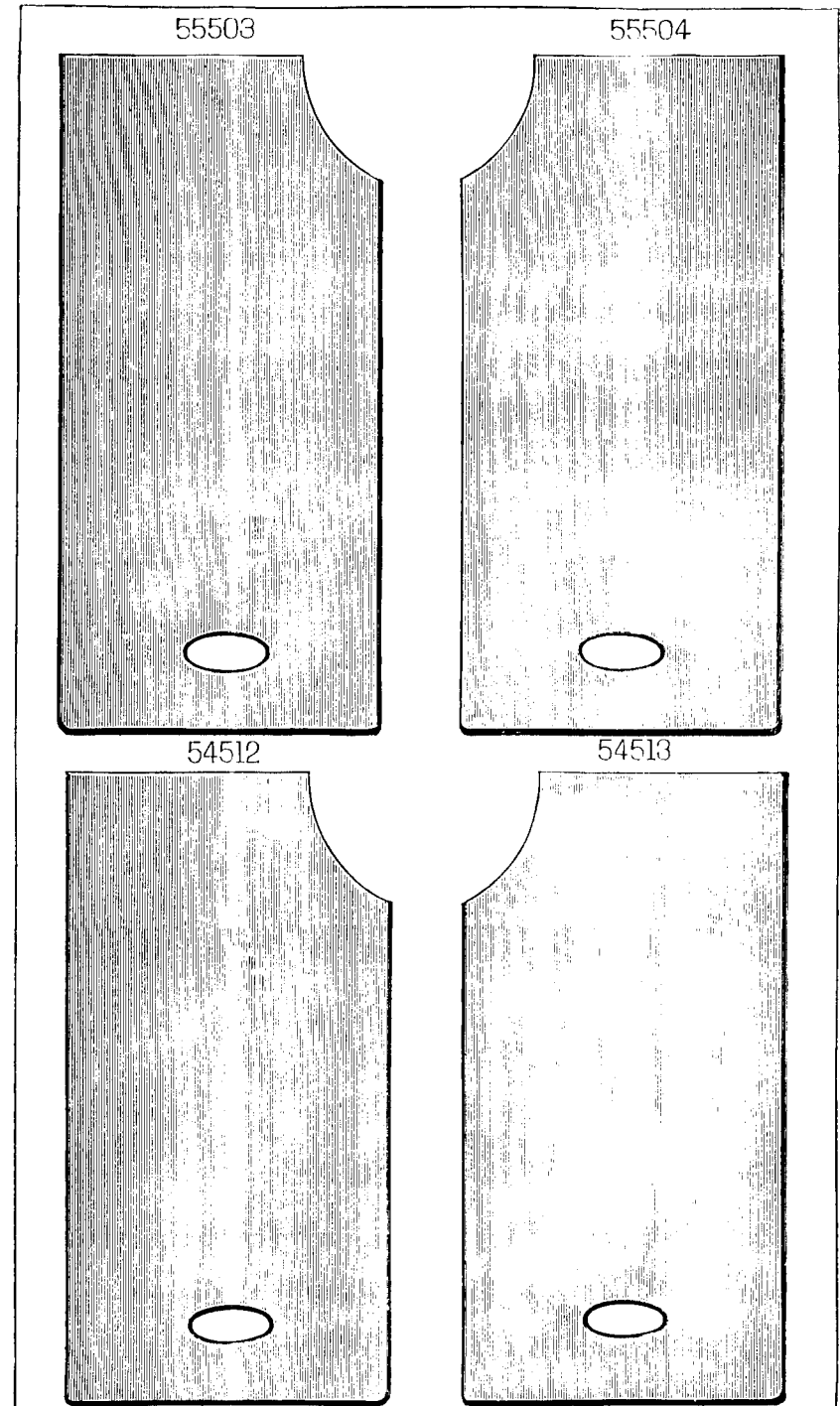
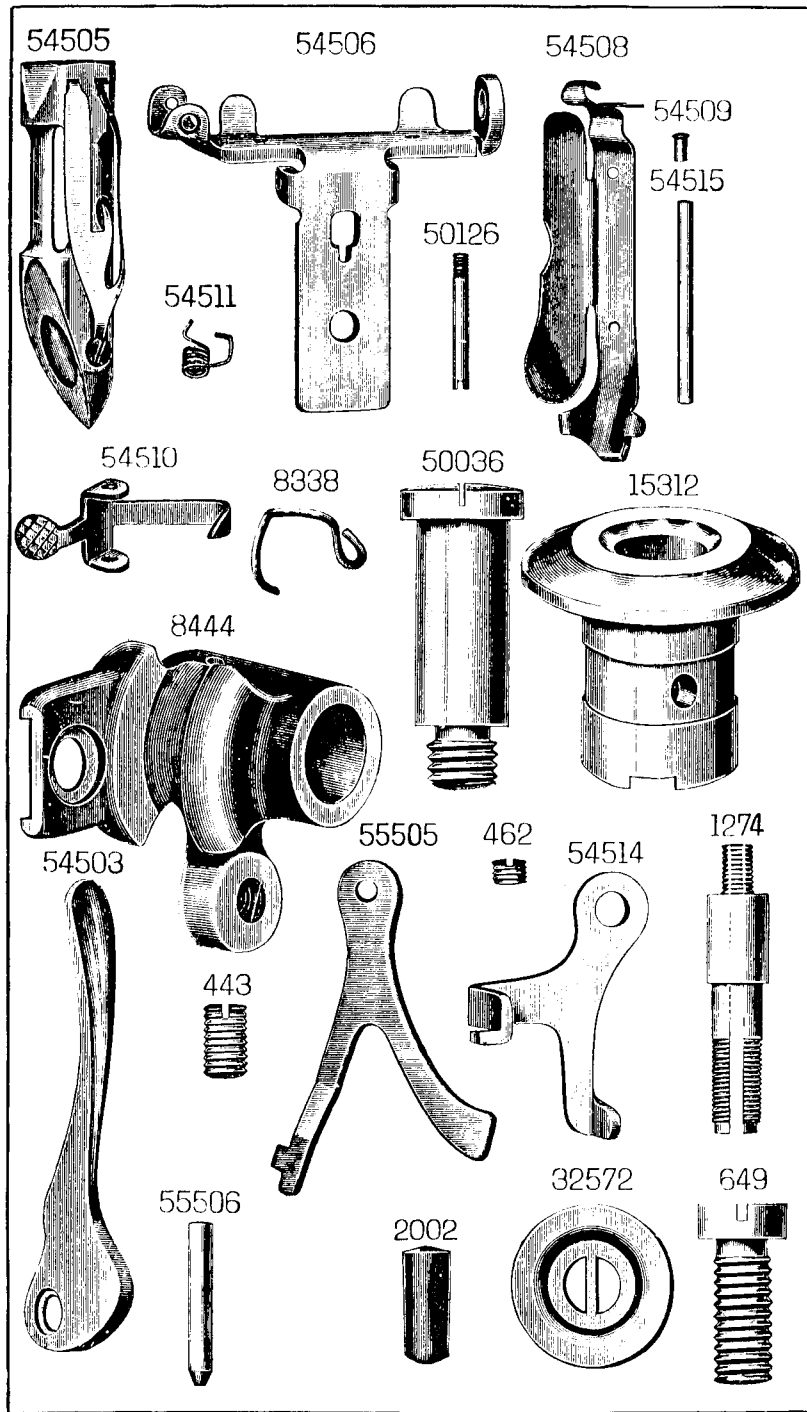

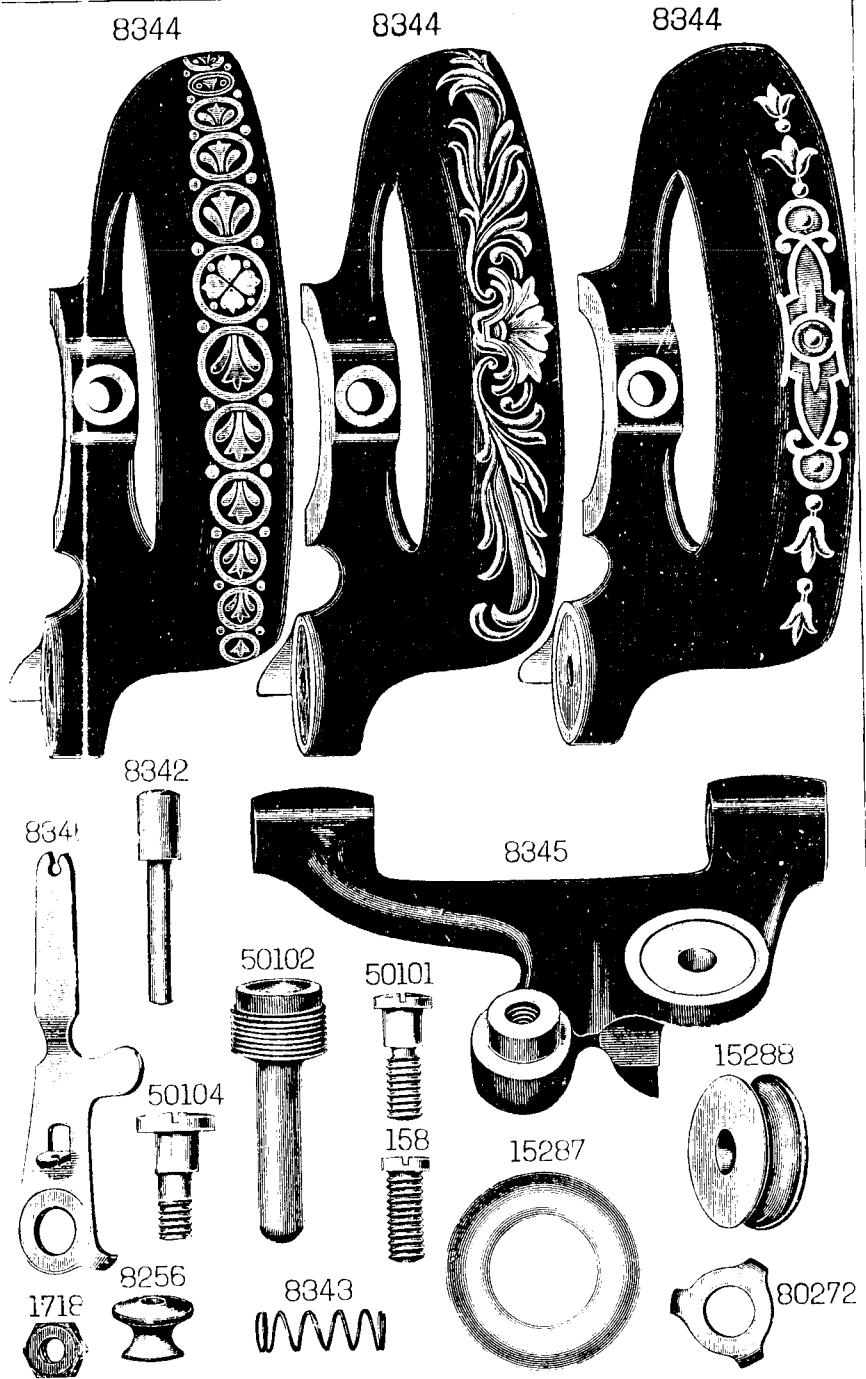
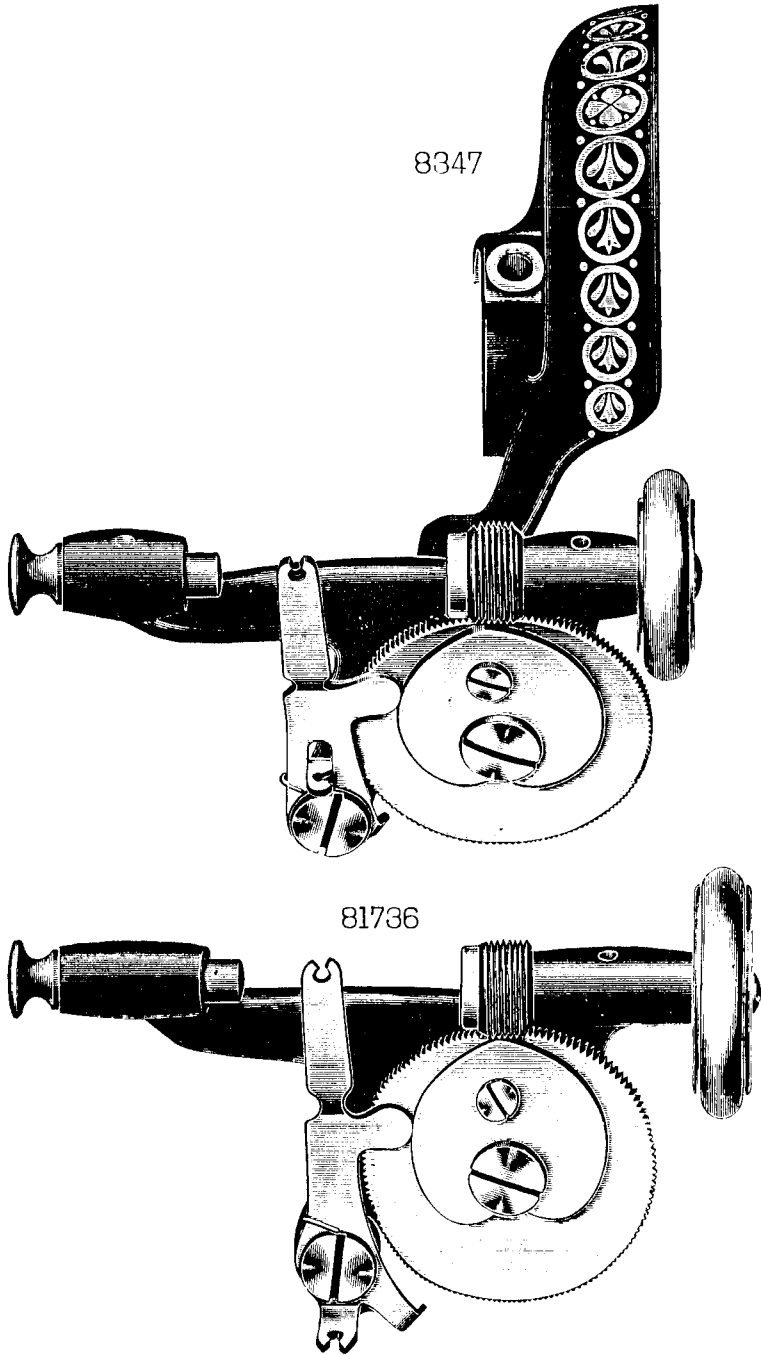

120290

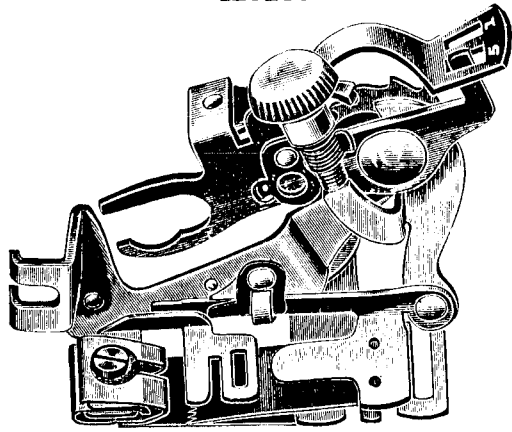

121464

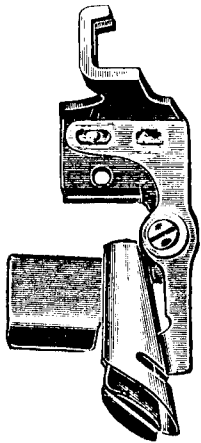

35931

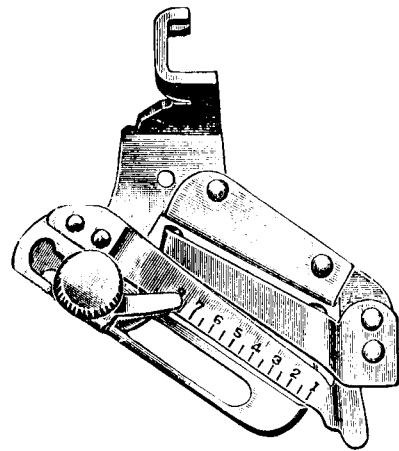

35932

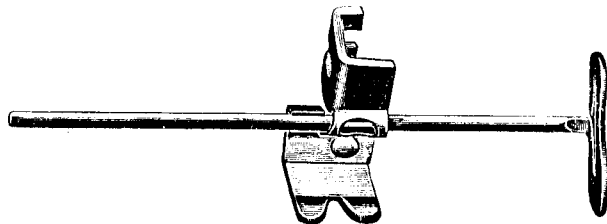

35985

35984

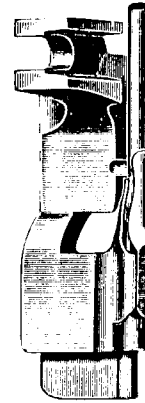

25539

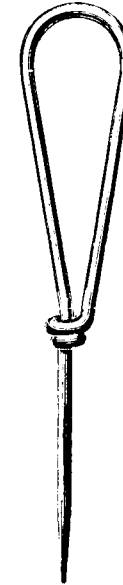

35983



120842



15429



85893



120687

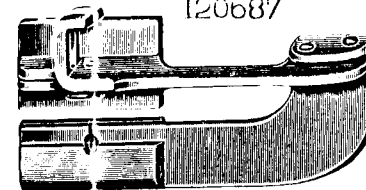

15282

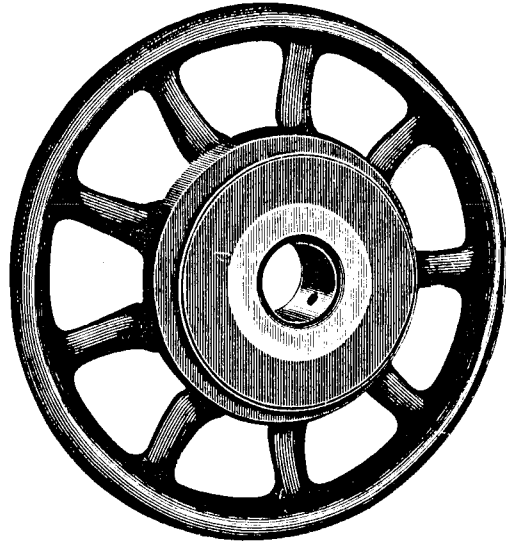

86496

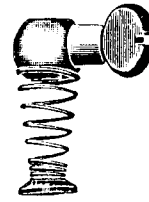

86493



86494



86495



36583

140545

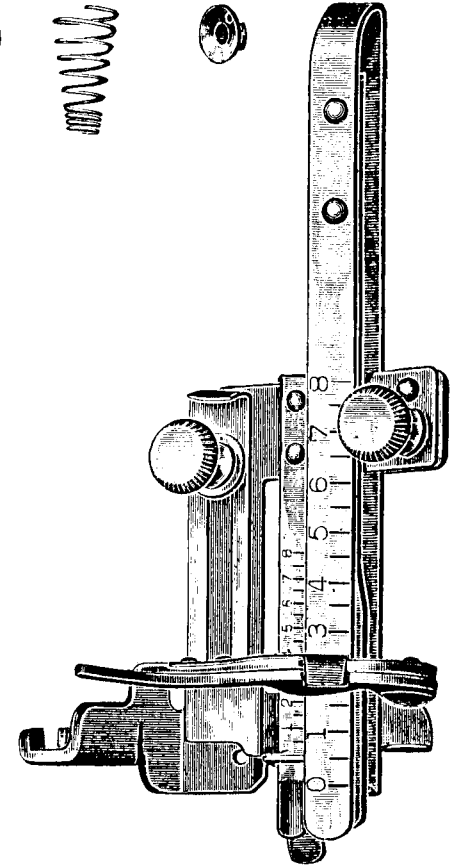

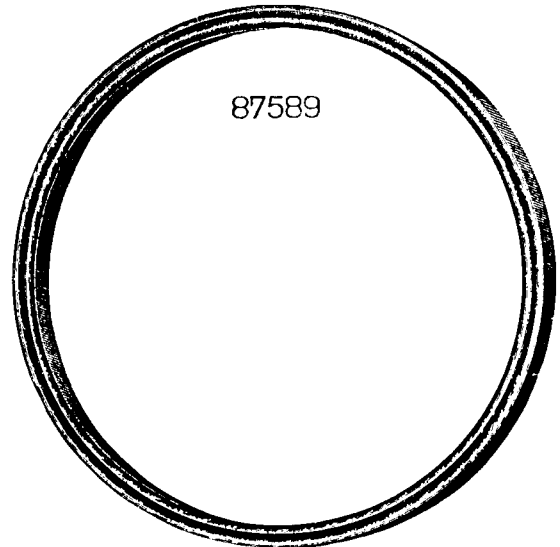

87589

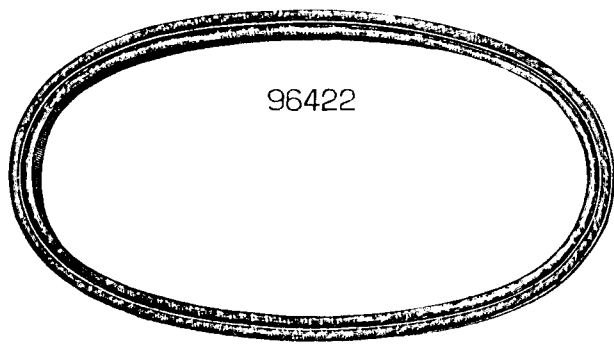

96422

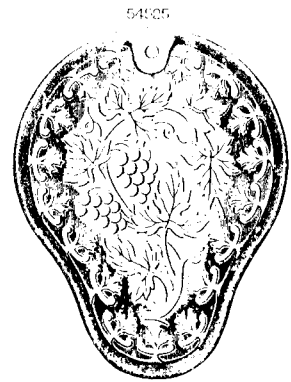

54305



80307



125425

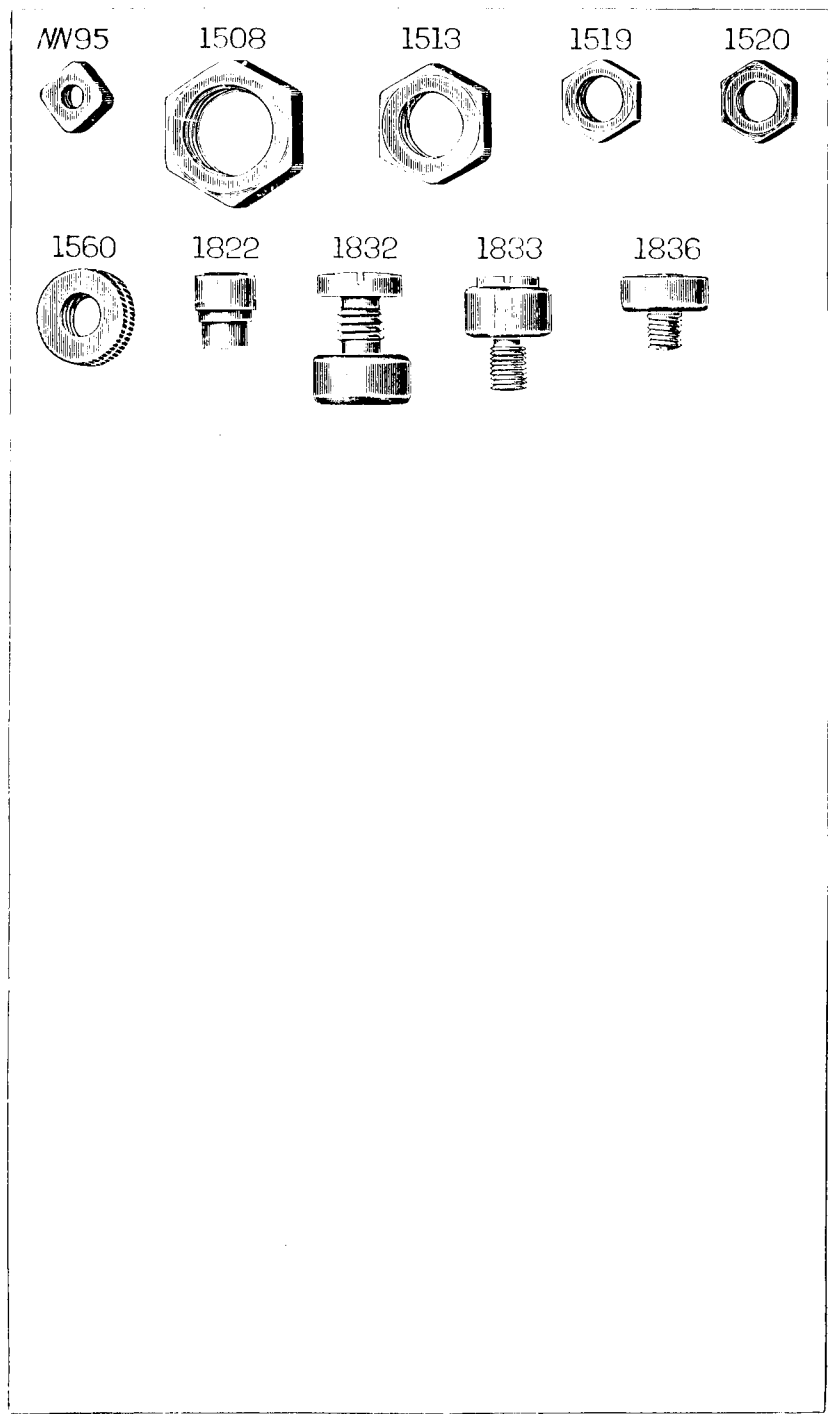
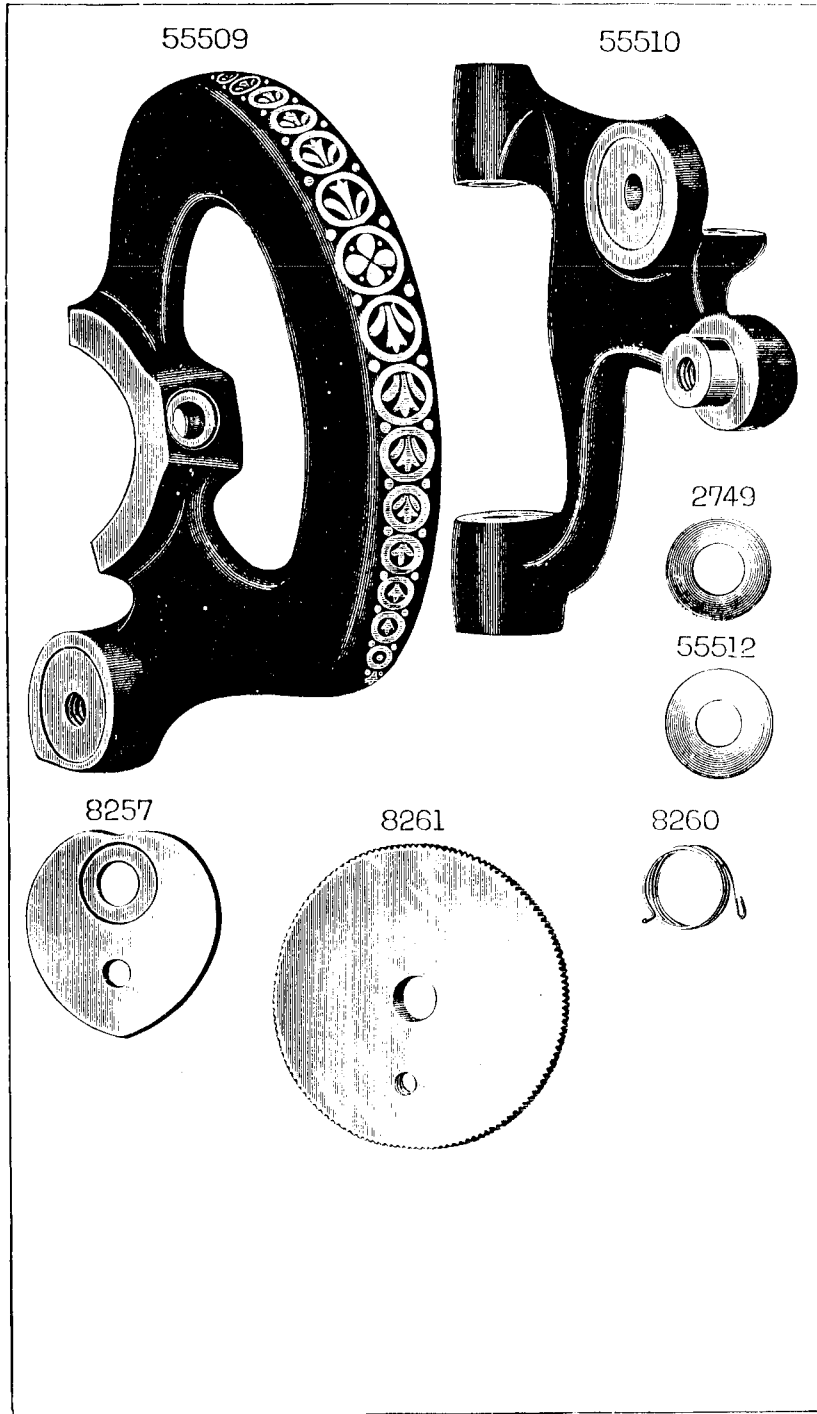

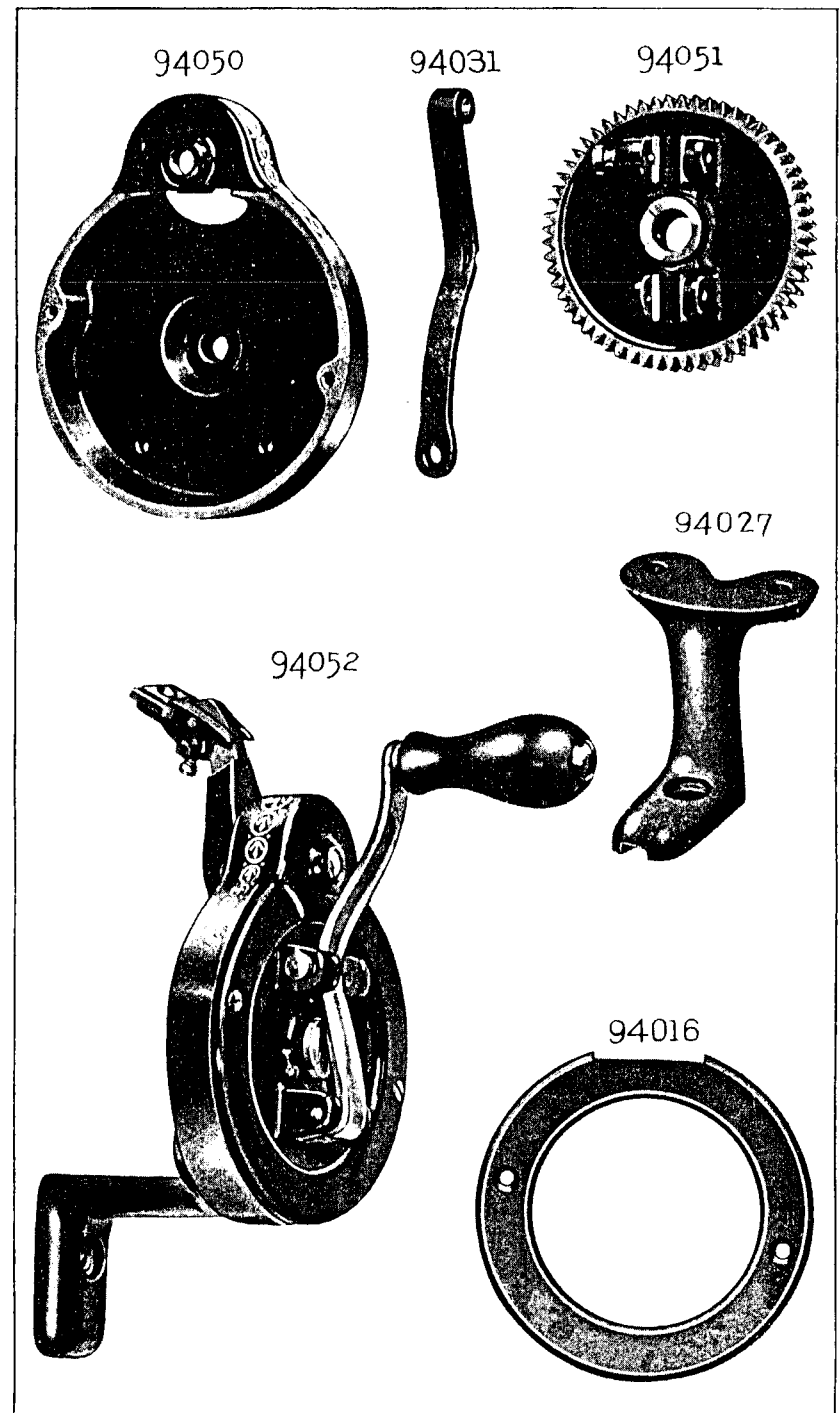
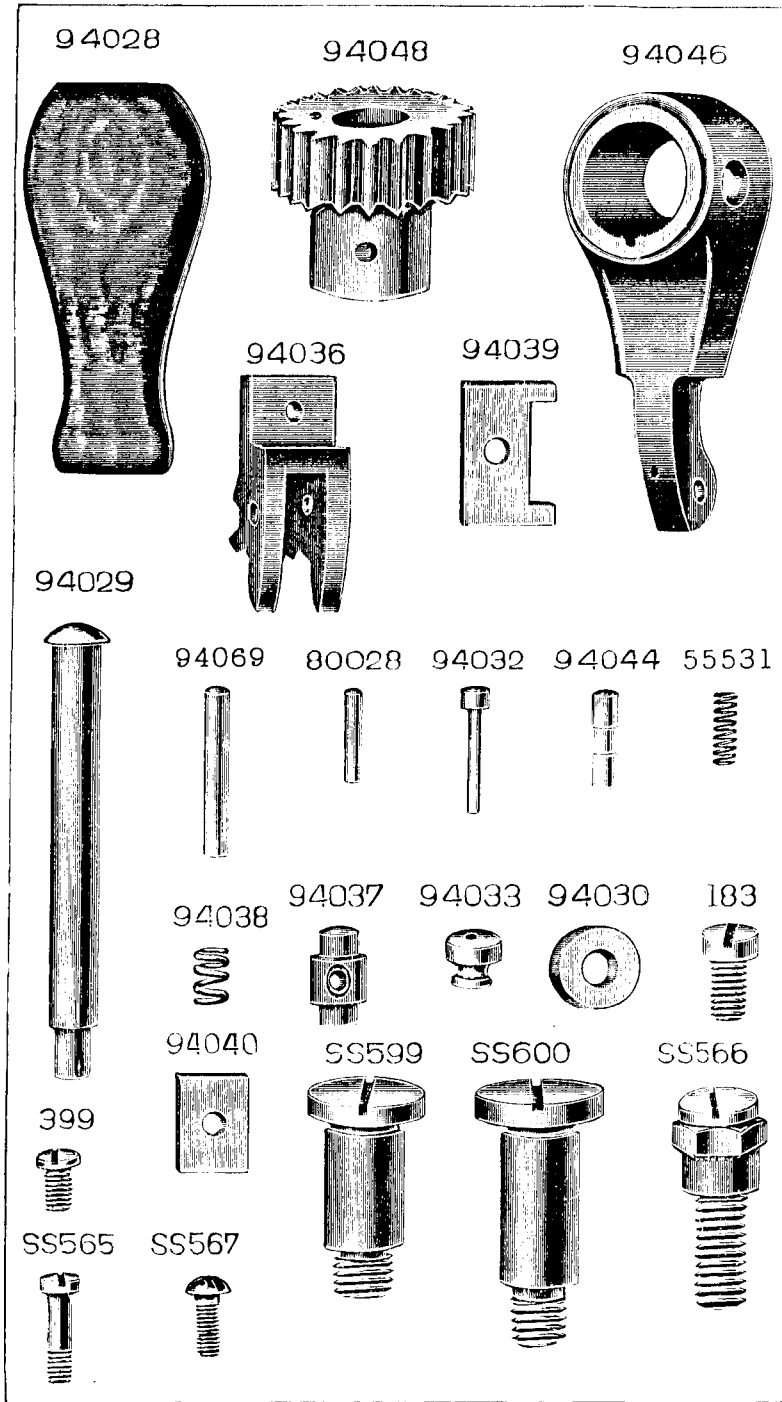

SS 528



96425



96426



96844

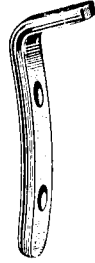

96427



96845



NW95



8229

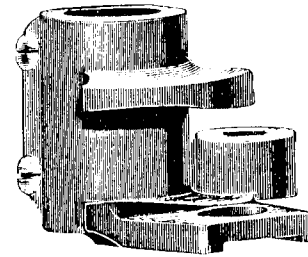

8206

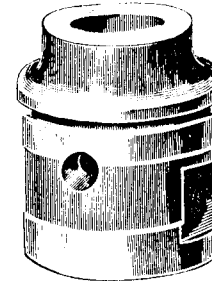

32562

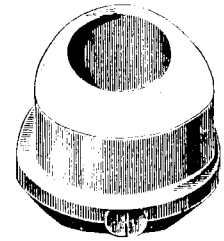

55521

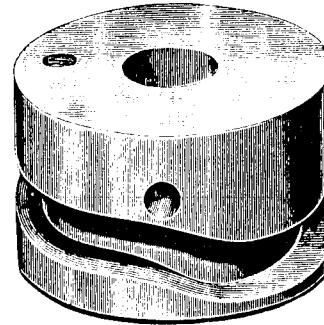

8216

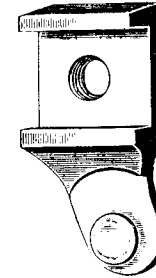

8220

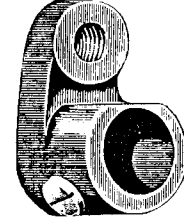

55515



54530

8243

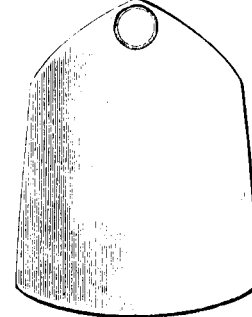

8222

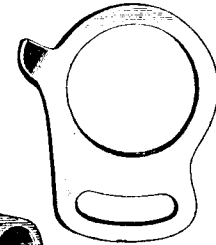
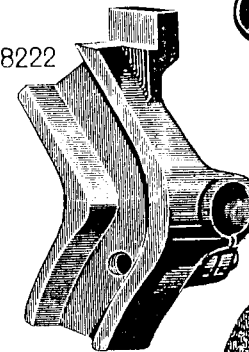

8879

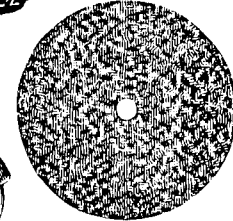

8396



8204



26075



8217

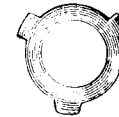

39443

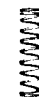

125423



2070



125422

125424



ILLUSTRATED LIST OF PARTS

FOR

28K, 127K and 128K MACHINES

CONTENTS

	Page
Parts Complete for 28K Machines	37
" " " 127K Machines	41
" " " 128K Machines	45
Accessories and Attachments	51
Bobbin Winders	50
Hand Attachment	54
Obsolete Parts	55
Numerical List of Parts	59

INSTRUCTIONS FOR ORDERING

In ordering from this List, the prefix and affix letters with the part number **MUST BE** quoted exactly as they are shown in the first column.

A number always indicates the same part in whatever List it may appear, or for whatever machine.

The affix letters (where shown) indicate the style of finish, as follows:—

- A. Hardened, Polished, Nickel Plated and Buffed.
- A.A. Buffed and Chromium Plated.
- A.B. Hardened, Polished, Buffed and Chromium Plated.
- A.C. Brown Baking Enamel Finish.
- A.D. Grey Baking Enamel Finish.
- A.E. Hardened, Bright Rumbled and Nickel Plated.
- A.F. Hardened, Bright Rumbled and Nickel Plated, Bright Rumbled and Chromium Plated.
- A.J. Polished, Nickel Plated and Chromium Plated.
- A.K. Hardened, Polished, Nickel Plated and Chromium Plated.
- A.L. Heat Treated for Toughness.
- B. Polished, Nickel Plated and Buffed.
- C. Hardened only.
- C.R. Hardened and Merlized.
- D. Polished only.
- E. Soft, not Polished.
- F. Hardened and Polished.
- F.J. Hardened, Polished and Nickel Plated.
- G. Bright Rumbled and Nickel Plated.
- H. Blue.
- J. Nickel Plated only.
- K. Hardened and Nickel Plated.
- L. Brass Plated.
- M. Oxidized.
- N. Japanned, Dull.
- P. Japanned, Bright.
- P.P. Wrinkle Finish.
- R. Merlized.
- S. Cadmium Plated.
- T. Copper Plated.
- T.A. Hardened, Polished, Copper and Nickel Plated and Buffed.
- T.B. Copper and Nickel Plated and Polished.
- T.J. Copper and Nickel Plated only.
- T.K. Hardened, Copper and Nickel Plated.
- T.L. Copper and Brass Plated.
- T.M. Copper Plated and Oxidized.
- U. Zinc Plated.
- V. Silver Plated.
- W. Polished and Nickel Plated.
- X. Black Oxide for Iron and Steel.
- X.C. Hardened and Black Oxide for Iron and Steel.
- Y. Black Nickel Plated only.
- Z. Chromium Plated.
- Z.A. Hardened, Polished, Nickel Plated, Buffed and Chromium Plated.
- Z.B. Polished, Nickel Plated, Buffed and Chromium Plated.
- Z.C. Hardened and Chromium Plated.
- Z.D. Polished and Chromium Plated.
- Z.G. Bright Rumbled, Nickel Plated, Bright Rumbled and Chromium Plated.
- Z.J. Nickel and Chromium Plated.
- Z.T. Copper and Chromium Plated.

Parts marked with an asterisk (*) are furnished only when the repairs are made at Factory.

PARTS COMPLETE FOR CLASS 28K MACHINES

(Nos. 28K1 to 28K4).

For Family Use.

Vibrating Shuttle.

No.	Plate						
*8447	--	Arm with 443c, 8206, 15404 and two 15405
NOTE. In ordering it is necessary to state the Class and Variety number of machine.							
2002	926	Arm Dowel Pin (2)
4389	46	" " " (for repairs only)
8352	43	Arm Rock Shaft with 50571c
50571c	53	" " " Adjusting Screw
8396	2520	" " " Centre (upper)
301c	47	" " " Screw Centre (lower)
1508j	1693	" " " " " Nut
138c	53	Arm Screw (3)
8446	43	Arm Shaft
8206	2520	" " Bushing
443c	926	" " " Set Screw
54525b	1690	Arm Side Cover
81715p	---	" " " (plain)
51224b	53	" " " Thumb Screw
51224d	53	" " " " " "
2007	46	" Spool Pin
8879	2520	" " " Washer (cloth)
15282b	1152	Balance Wheel, 2 1/4" Pulley
15282p	1152	" " " 2 1/4" "
*81728	---	Bed
55515	2520	" Oil Hole (shuttle) Packing (braided cotton)
NOTE. In ordering No. 81728 it is necessary to state the Class and Variety number of machine.							
256b	47	Clamp Stop Motion Clamp Screw
256d	47	" " " " " "
248a	53	" " " " " Stop Screw

No.	Plate	
248f	53	Clamp Stop Motion Clamp Stop Screw ...
2020	47	" " " " Washer ...
*15312	926	" " " Flanged Bushing ...
15313	—	" " " " " with two 462al ...
2022	46	" " " " " Pin ...
462al -	926	" " " " " Set Screw ...
15314	—	Clamp Stop Motion, complete, Nos. 248f, 256d, 2020 and 15313
15314b	—	Clamp Stop Motion, complete, Nos. 248a, 256b, 2020 and 15313
*54529	—	Face Plate ...
*54529b	—	" " ...
*54529p	—	" " ...
8361	44	" " 54529 with 125423 ...
8361b	44	" " 54529b " 125423b ...
8361p	44	" " 54529p " 125423b ...
219a	53	" " Screw (2) ...
219f	53	" " " (2) ...
125422	2520	" " Thread Guard ...
125422b	2520	" " " " ...
125423	2520	" " " " 125422 with 125424 ...
125423b	2520	" " " " 125422b with 125424b ...
125424	2520	" " " " Rivet ...
125424b	2520	" " " " " ...
32562	2520	Feed Cam with 1285c ...
1285c	53	" " Set Screw ...
8321	813	Feed Dog, four teeth at right of needle (square corners) ...
8437	47	" " Carrier ...
1833	1693	" " " Roller and Screw Stud ...
315c	47	" " " Screw Centre (2) ...
1519j	1693	" " " " " Nut (2) ...
191k	53	" " Screw ...
8443	43	Feed Forked Connection with 175j ...
175j	53	" " " Adjusting Screw ...
1381c	53	" " " Hinge Screw (eccentric) ...
1520j	1693	" " " " " Nut ...
1832	1693	" " " Roller with 1085e ...
1085e	—	" " " " Screw Stud ...
253b	47	Feed Regulating Thumb Screw ...
253d	47	" " " " " ...
8216	2520	Feed Regulator ...
8217	2520	" " Friction Washer ...
42e	53	" " Hinge Screw ...

No.	Plate	
8431	811	Feed Rock Shaft ...
307c	47	" " " Screw Centre (2) ...
1513j	1693	" " " " " Nut (2) ...
51045c	53	Machine Hinge Connection Set Screw (2) ...
8365	44	Needle Bar ...
*8222	2520	" " Cam with 175e ...
175e	53	" " " Clamping Screw ...
233d	53	" " " Position Screw ...
1836	1693	" " " Roller and Screw Stud ...
8338	926	" " Thread Guard ...
8338b	926	" " " " " ...
249a	53	" " " " and Needle Stop Screw ...
249f	53	" " " " " " " " " " " " ...
2054	46	Needle Clamp with 140545c ...
140545c	53	" " Thumb Screw ...
8366	44	Presser Bar ...
54503	926	" " Lifter ...
54503b	926	" " " ...
97e	53	" " " Screw ...
32675	47	" " Spring ...
55507	813	" " " Bracket with 453c ...
453c	53	" " " " Set Screw ...
2070	2520	" " " Washer ...
8337	813	Presser Foot ...
8337b	813	" " ...
51224b	53	" " Thumb Screw ...
51224d	53	" " " " ...
263j	47	Pressure Regulating Thumb Screw ...
263d	47	" " " " " ...
8444	926	Shuttle Bell Crank ...
50036b	926	" " " Hinge Screw ...
8228	46	Shuttle Bobbin ...
*8301	—	" Body ...
8326	46	" Tension Spring ...
215h	53	" " Regulating Screw ...
8327	46	Shuttle, complete, Nos. 215h, 8228, 8301 and 8326 ...
8231	46	Shuttle Carrier ...
231k	53	" " Screw ...

No.	Plate						
8445	811	Shuttle Pitman	with two 175j
175j	53	"	"	Adjusting Screw
44c	53	"	"	Screw Stud
520c	53	"	"	"	"	(eccentric)	...
1520j	1693	"	"	"	"	(") Nut	...
216c	53	"	"	"	"	(") Screw	...
54513	927	Shuttle Slide	(front)
54513b	927	"	"	(")
54512	927	"	"	(back)
54512b	927	"	"	(")
2102	46	Tension Disc	(2)
1560g	1693	"		Regulating Thumb Nut
1560d	1693	"	"	"	"	"	...
8237	46	"		Releaser
8237b	46	"	"	"
SS416b	813	"		Screw Stud
SS416d	813	"	"	"
8238h	46	"		Spring
81729	—	Tension ,	complete, Nos. SS416, 1560, 8237, 8238 and two 2102
26075	2520	Thread Cutter and Holder
*55523	—	Thread Take-up Cam
55521	2520	"	"	"	55523 with 448c
2117	46	"	"	"	Pin
448c	53	"	"	"	Set Screw
*55525	46	Thread Take-up Lever	with 1822
*55525b	46	"	"	"	"	1822	...
55526	—	"	"	"	55525 with 50527c
55526b	—	"	"	"	55525b with 50527c
8243	2520	"	"	"	Cover
8243b	2520	"	"	"	"
8243p	2520	"	"	"	"
107b	53	"	"	"	"	Hinge Screw	...
107d	53	"	"	"	"	"	...
50527c	53	"	"	"	"	Hinge Screw	...
1822	1693	"	"	"	"	Roller and Stud	...
8244	46	"	"	"	"	Spring	...
54516	46	"	"	"	"	Regulator Plate	...
233b	53	"	"	"	"	"	Adjusting Screw
233d	53	"	"	"	"	"	"
8323	813	Throat Plate
8323b	813	"	"	"	"	"	"
219a	53	"	"	"	"	Screw	...
219f	53	"	"	"	"	"	"
*15404	—	Trade Mark
15405	—	"	"	"	"	Rivet	...
81742	—	Drip Pan

PARTS COMPLETE
FOR
CLASS 127K MACHINES
(Nos. 127K3 and 127K4).

For Family Use. Vibrating Shuttle with Shuttle Ejector.

No.	Plate						
*55501	—	Arm	with 443c, 8206, 15404 and two 15405
2002	926	"	Dowel Pin (2)
4389	46	"	"	"	(for repairs only)
8203	43	Arm Rock Shaft	with two 50571e
8204 50571e	53	"	"	"	Adjusting Screw
8204	2520	"	"	"	Centre (upper)
301c	47	"	"	"	Screw Centre (lower)
1508j	1693	"	"	"	"	"	Nut
649e	926	Arm Screw	(3)
8341	43	Arm Shaft
8206	2520	"	"	"	Bushing
443c	926	"	"	"	"	Set Screw	...
125425b	1690	Arm Side Cover
80307p	1690	"	"	"	(plain)
51224b	53	"	"	"	Thumb Screw
51224d	53	"	"	"	"	"	"
2007	46	"	"	"	Spool Pin
8879	2520	"	"	"	"	Washer (cloth)	...
15282b	1152	Balance Wheel ,	2 1/2" Pulley
15282p	1152	"	"	"	2 1/2" "
*8328	—	Bed
55515	2520	"	Oil Hole (shuttle) Packing	(braided cotton)
256b	47	Clamp Stop Motion Clamp Screw
248a	53	"	"	"	"	Stop Screw	...
2020	47	"	"	"	"	Washer	...

No.	Plate	
*15312	926	Clamp Stop Motion Flanged Bushing
15313	—	" " " " " with two 462al
2022	46	" " " " " Pin
462al	926	" " " " " Set Screw
15314b	—	Clamp Stop Motion , complete, Nos. 248a, 256b, 2020 and 15313
*55529b	—	Face Plate
*55529p	—	" "
8210b	44	" " 55529b with 125423b
8210p	44	" " 55529p " 125423b
219a	53	" " Screw (2)
125422b	2520	" " Thread Guard
125423b	2520	" " " " 125422b with 125424b
125424b	2520	" " " " Rivet
32562	2520	Feed Cam with 1285c
1285c	53	" " Set Screw
8321	813	Feed Dog , four teeth at right of needle (square corners)
8437	47	" " Carrier
1833	1693	" " " Roller and Screw Stud
315c	47	" " " Screw Centre (2)
1519j	1693	" " " " " Nut (2)
191k	53	" " Screw
8348	43	Feed Forked Connection with 175j
175j	53	" " " Adjusting Screw
1381c	53	" " " Hinge Screw (eccentric)
1520j	1693	" " " " " Nut
1832	1693	" " " Roller with 1085e
1085e	—	" " " Screw Stud
253b	47	Feed Regulating Thumb Screw
8216	2520	Feed Regulator
8217	2520	" " Friction Washer
42e	53	" " Hinge Screw
8334	811	Feed Rock Shaft
307c	47	" " " Screw Centre (2)
1513j	1693	" " " " " Nut (2)
51045c	53	Machine Hinge Connection Set Screw (2)
8221	44	Needle Bar
*8222	2520	" " Cam with 175c
175c	53	" " " Clamping Screw
233d	53	" " " Position Screw
1836	1693	" " " Roller and Screw Stud
8338b	926	" " Thread Guard
249a	53	" " " " and Needle Stop Screw

No.	Plate	
2054	46	Needle Clamp with 140545c
140545c	53	" " Thumb Screw
8224	44	Presser Bar
54503b	926	" " Lifter
97c	53	" " " Screw
8225	47	" " Spring
55507	813	" " " Bracket with 453c
453c	53	" " " " Set Screw
2070	2520	" " " Washer
8337b	813	Presser Foot
51224b	53	" " Thumb Screw
263j	47	Pressure Regulating Thumb Screw
8441	926	Shuttle Bell Crank
50036b	926	" " " Hinge Screw
8228	46	Shuttle Bobbin
*54504	—	" Body
215h	53	" Tension Regulating Screw
8326	46	" " Spring
54505	926	Shuttle , complete, Nos. 215h, 8228, 8326 and 54504
*54506	926	Shuttle Carrier
54527	—	" " 54506 with 54508 and two 54509
*54508	926	" " Cushion Spring
*54509	926	" " " " Rivet
231k	53	" " Screw
54510	926	" Ejector
50126e	926	" " Hinge Screw
54511	926	" " Spring
54507	—	Shuttle Carrier , complete, Nos. 50126e, 54510, 54511 and 54527
8232	44	Shuttle Pitman with two 175j
175j	53	" " Adjusting Screw
44c	53	" " Screw Stud
520c	53	" " " " (eccentric)
1520j	1693	" " " " (") Nut
216c	53	" " " " (") Screw
55503b	927	Shuttle Slide (back)
55504b	927	" " (front)

No.	Plate						
2102	46	Tension Disc (2)
1560g	1693	"	Regulating Thumb Nut
1274j	926	"	Screw Stud
8238h	46	"	Spring
32572	926	"	Releasing Disc
55505	926	"	" Lever
55506	926	"	" Hinge Pin
12329	813	"	" Spring
54515	926	"	" Pin
55520	—	Tension, complete, Nos. 1274j, 1560g, 8238h, 8244, 32572, 54515 and two 2102
26075	2520	Thread Cutter and Holder
*55523	—	Thread Take-up Cam
55521	2520	"	" " 55523 with 448c
2117	46	"	" " Pin
448c	53	"	" " Set Screw
*55525b	46	Thread Take-up Lever with 1822
55526b	—	"	" " 55525b with 50527c
8243b	2520	"	" " Cover
8243p	2520	"	" " " "
107b	53	"	" " Hinge Screw
107d	53	"	" " " " " "
50527c	53	"	" " Hinge Screw
1822	1693	"	" " Roller and Stud
8244	46	"	" " Spring
54530	2520	"	" " Regulator Plate
233b	53	"	" " Adjusting Screw
8323b	813	Throat Plate
219a	53	"	" " Screw
*15404	—	Trade Mark
15405	—	"	" " Rivet
87321	—	Drip Pan

PARTS COMPLETE FOR CLASS 128K MACHINES

(Nos. 128K3 and 128K4).

For Family Use. Vibrating Shuttle with Shuttle Ejector.

No.	Plate						
*54501	—	Arm	with 443c, 8206, 15401 and two 15405
<i>NOTE:—In ordering it is necessary to state whether "Gilt" or "Coloured" ornamentation is required.</i>							
2002	926	Arm Dowel Pin (2)
4389	46	"	" " (for repairs only)
8352	43	Arm Rock Shaft	with 50571e
50571e	53	"	" " Adjusting Screw
8396	2520	"	" " Centre (upper)
301c	47	"	" " Screw Centre (lower)
1508j	1693	"	" " " " Nut
138e	53	Arm Screw (3)
8446	43	Arm Shaft
8206	2520	"	" " Bushing
443c	926	"	" " Set Screw
54525b	1690	Arm Side Cover
81715p	—	"	" " (plain)
51224b	53	"	" " Thumb Screw
51224d	53	"	" " " " " "
2007	46	"	" Spool Pin
8879	2520	"	" " Washer (cloth)
15282b	1152	Balance Wheel, 2½" Pulley
15282p	1152	"	" " 2½" "
*8450	—	Bed
55515	2520	"	" Oil Hole (shuttle) Packing (braided cotton)

NOTE:—In ordering No. 8450 it is necessary to state whether "Gilt" or "Coloured" ornamentation is required.

256b	47	Clamp Stop Motion Clamp Screw
248a	53	"	" " " Stop Screw
2020	47	"	" " " Washer
*15312	926	"	" " " Flanged Bushing
15313	—	"	" " " with two 462al
2022	46	"	" " " Pin
462al	926	"	" " " Set Screw

No.	Plate	
15314b	—	Clamp Stop Motion , complete, Nos. 248a, 256b, 2020 and 15313
*54529b	—	Face Plate
*54529p	—	" "
8361b	44	" " 54529b with 125423b
8361p	44	" " 54529p " 125423b
219a	53	" " Screw (2)
125422b	2520	" " Thread Guard
125423b	2520	" " " " 125422b with 125424b
125424b	2520	" " " " Rivet
32562	2520	Feed Cam with 1285c
1285c	53	" " Set Screw
8321	813	Feed Dog , four teeth at right of needle (square corners)
8437	47	" " Carrier
1833	1693	" " " Roller and Screw Stud
315c	47	" " " Screw Centre (2)
1519j	1693	" " " " " Nut (2)
191k	53	" " Screw
8443	43	Feed Forked Connection with 175j
175j	53	" " " Adjusting Screw
1381c	53	" " " Hinge Screw (eccentric)
1520j	1693	" " " " " Nut
1832	1693	" " " Roller with 1085e
1085e	—	" " " " Screw Stud
253b	47	Feed Regulating Thumb Screw
8216	2520	Feed Regulator
8217	2520	" " Friction Washer
42e	53	" " Hinge Screw
8431	811	Feed Rock Shaft
307c	47	" " " Screw Centre (2)
1513j	1693	" " " " " Nut (2)
51045c	53	Machine Hinge Connection Set Screw (2)
8365	44	Needle Bar
*8222	2520	" " Cam with 175e
175e	53	" " " Clamping Screw
233d	53	" " " Position Screw
1836	1693	" " " Roller and Screw Stud
8338b	926	" " Thread Guard
249a	53	" " " " and Needle Stop Screw

No.	Plate	
2054	46	Needle Clamp with 140545c
140545c	53	" " Thumb Screw
8366	44	Presser Bar
54503b	926	" " Lifter
97e	53	" " " Screw
32675	47	" " Spring
55507	813	" " " Bracket with 453c
453c	53	" " " " Set Screw
2070	2520	" " " Washer
8337b	813	Presser Foot
51224b	53	" " Thumb Screw
263j	47	Pressure Regulating Thumb Screw
8444	926	Shuttle Bell Crank
50036b	926	" " " Hinge Screw
8228	46	Shuttle Bobbin
*54504	—	" Body
215h	53	" Tension Regulating Screw
8326	46	" " Spring
54505	926	Shuttle , complete, Nos. 215h, 8228, 8326 and 54504
*54506	926	Shuttle Carrier
54527	—	" " 54506 with 54508 and two 54509
*54508	926	" " Cushion Spring
*54509	926	" " " " Rivet
231k	53	" " Screw
54510	926	" Ejector
50126e	926	" " Hinge Screw
54511	926	" " Spring
54507	—	Shuttle Carrier , complete, Nos. 50126e, 54510, 54511 and 54527
8445	811	Shuttle Pitman with two 175j
175j	53	" " Adjusting Screw
44c	53	" " Screw Stud
520c	53	" " " " (eccentric)
1520j	1693	" " " " (") Nut
216c	53	" " " " (") Screw
54512b	926	Shuttle Slide (back)
54513b	926	" " (front)

128K MACHINE PARTS

No.	Plate							
2102	46	Tension Disc (2)
1560g	1693	"	Regulating Thumb Nut
1274j	926	"	Screw Stud
8238h	46	"	Spring
32572	926	"	Releasing Disc
54514	926	"	"	Lever
97e	53	"	"	"	Hinge Screw
39443	2520	"	"	"	Spring
54515	926	"	"	Pin
55520	—	Tension, complete, Nos. 1274j, 1560g, 8238h, 8244, 32572, 54515 and two 2102
26075	2520	Thread Cutter and Holder
*55523	—	Thread Take-up Cam
55521	2520	"	"	"	55523 with 448c
2117	46	"	"	"	Pin
448c	53	"	"	"	Set Screw
*55525b	46	"	"	"	Lever with 1822
55526b	—	"	"	"	55525b with 50527c
8243b	2520	"	"	"	Cover
8243p	2520	"	"	"	"
107b	53	"	"	"	"	Hinge Screw
107d	53	"	"	"	"	"
50527c	53	"	"	"	"	Hinge Screw
1822	1693	"	"	"	Roller and Stud
8244	46	"	"	"	Spring
54530	2520	"	"	"	Regulator Plate
233b	53	"	"	"	"	"	Adjusting Screw	...
8323b	813	Throat Plate
219a	53	"	"	"	Screw
*15404	—	Trade Mark
15405	—	"	"	"	Rivet
81742	—	Drip Pan

BOBBIN WINDERS (Automatic) FOR 28K, 127K and 128K MACHINES

No.	Plate	
8342	929	Back Centre
8256	929	" " Head
8256b	929	" " "
8343	929	" " Spring
‡55509	1692	Bracket (belt cover)
158b	929	" " Screw
*8257	1692	Cam
*8257b	1692	"
50231a	53	" Screw
50231f	53	" "
55510	1692	Frame
55512	1692	" Friction Washer
50101b	929	" Hinge Screw
50101d	929	" " "
1718h	929	" " " Nut
15287	929	Friction Ring (rubber)
50102f	929	Spindle
15288	929	" Pulley
15288b	929	" "
8346	929	Thread Guide
8346b	929	" "
92b	53	" " Hinge Screw
92d	53	" " " "
8260	1692	" " Spring
8261	1692	Worm Wheel
8261b	1692	" "
55514	—	" " 8261 with 8257 and 50231f
55514b	—	" " 8261b with 8257b and 50231a
2749	1692	" " Friction Washer
50104b	929	" " Screw Stud (eccentric)
50104d	929	" " " " (")
1718h	929	" " " " Nut
55511	—	Bobbin Winder (automatic) , complete, Nos. 92d, 2749, 8256, 8260, 8342, 8343, 8346, 15287, 15288, 50101d, 50102f, 50104d, 55509, 55510, 55512, 55514 and two 1718h for 28K1 and 28K2 Machines
‡55511b	—	Bobbin Winder (automatic) , complete, Nos. 92b, 2749, 8256b, 8260, 8342, 8343, 8346b, 15287, 15288b, 50101b, 50102f, 50104b, 55509, 55510, 55512, 55514b and two 1718h, for 28K3, 28K4, 127K and 128K Machines

‡ In ordering it is necessary to state the class of machine and when for 128K Machine to state also whether "Gilt" or "Coloured" Ornamentation is required.

Attachment Set

No.	Plate	
121464	930	Binder
25527b	905	Cloth Guide
50053b	53	" " Thumb Screw
35931	930	Hemmer (adjustable)
120842	1151	" (foot) $\frac{3}{4}$ " Hem
15 × 1	—	Needles (6)
25537	905	Screw Driver (machine)
120378	905	" " (shuttle tension)
8228	46	Shuttle Bobbin
120862	—	Fin of Oil (1 $\frac{1}{3}$ oz.)
36583	1160	Tucker
86502	—	Set , complete, Nos. 25527b, 25537, 35931, 36583, 50053b, 120378, 120842, 120862, 121464, three 8228 and six needles
25525	905	Bias Gauge
121441	—	Gathering Foot (double toe)
35932	930	Quilter
120290	930	Ruffler
35934	910	" Shirring Plate
120291	—	" 120290 with 35934
25539	905	Stiletto
35937	910	Under Braider

Art Work and Darning

No.	Plate	
85893	1151	Embroidery Foot (for art work)
86080	813	Feed Cover Plate

Cording Foot

No.	Plate	
15429	1151	Presser Foot for Stitching on Edge and Inserting Cord

Darning Presser

No.	Plate	
86493	1160	Needle Clamp with 140545k
140545k	1160	" " Screw
86494	1160	" " Stripper Spring
86495	1160	" " " " Eyelet
86496	1160	Darning Presser , complete, Nos. 86493 to 86495

Imitation Hemstitching Attachment

No.	Plate	
120687	1151	with Yielding Presser Plate

Tubular Trimming Attachment

For making $\frac{3}{8}$ " , $\frac{1}{8}$ " and $\frac{3}{16}$ " Trimmings.

No.	Plate	
35984	1151	Presser Foot (strip folding) with Tube
25539	1151	Stiletto
35983	1151	Strip Wire

NOTE.—When ordering 35983 state size of attachment with which it is to be used.

35985	1151	Tubular Trimming Attachment , complete, Nos. 25539, 35983 and 35984
-------	------	--	-----	-----	-----	-----

NOTE.—When ordering 35985 state size required.

Embroidery Hoops (Plain)

(BIRCH)

No.	Plate	
87586	---	Round, $5\frac{3}{8}$ " diam. \times $7\frac{m}{m}$ high
96416	---	" 7" " \times $7\frac{m}{m}$ "
87589	1221	" 8" " \times $7\frac{m}{m}$ "
87593	---	" 10" " \times $7\frac{1}{16}$ " "
87595	---	" 12" " \times $\frac{1}{2}$ " "
96422	1221	Oval, $9" \times 4\frac{1}{2}" \times 7\frac{m}{m}$ high
87597	---	" $12" \times 5\frac{1}{2}" \times 7\frac{m}{m}$ "

Embroidery Hoops (with Clamp)

(BIRCH)

No.	Plate	
96417	---	Round, $5\frac{3}{8}$ " diam. \times $7\frac{m}{m}$ high, with SS528j, NN95j, two	96425 and	four	96427	
96418	---	" 7" " \times $7\frac{m}{m}$ " " SS528j, NN95j, two	96426 and	four	96427	
96419	---	" 8" " \times $7\frac{m}{m}$ " " SS528j, NN95j, two	96426 and	four	96427	
96420	---	" 10" " \times $7\frac{1}{16}$ " " " SS528j, NN95j, two	96426 and	four	96427	
96421	---	" 12" " \times $\frac{1}{2}$ " " " SS528j, NN95j, two	96844 and	four	96845	
96423	---	Oval, $9" \times 4\frac{1}{2}" \times 7\frac{m}{m}$ high, with SS528j, NN95j,	96425, 96426 and	four	96427	
96424	---	" $12" \times 5\frac{1}{2}" \times 7\frac{m}{m}$ " " SS528j, NN95j,	96425, 96426 and	four	96427	
96425	2399	Clamping Bracket for 96417, 96423 and 96424
96426	2399	" " " 96418 to 96420, 96423 and 96424
96844	2399	" " " 96421
96427	2399	" " Rivet for 96417 to 96420, 96423 and 96424
96845	2399	" " " 96421
SS528j	2399	" " Screw
NN95j	2399	" " Nut

Hand Attachment

No.	Plate	
†94050	2284	Body
94027	2284	" Bracket
183e	2114	" " Screw
94028	2114	Crank Handle (wood)
94029b	2114	" " Spindle
94030b	2114	" " " Flange (loose)
94069	2114	" Hinge Pin
94031a	2284	" Lever
94032	2114	" " Lock Pin
94033b	2114	" " " " Head
55531	2114	" " " " Spring
94034b	---	Crank, complete, Nos. 94028, 94029b, 94030b and 94031a
94046	2114	Driver
94070	---	" 94046 with 80028 and 94048
94036	2114	" Finger
94039	2114	" " Driving Pad (raw-hide)
94040	2114	" " " " Plate
SS567e	2114	" " " " and Plate Binding Screw
94041	---	" " 94036 with SS567e, 94039 and 94040
94044	2114	" " Hinge Pin
94037	2114	" " Latch
SS565e	2114	" " " Screw Stud
94038	2114	" " " Spring
94051b	2284	Gear with 55531, 94032 and 94033b
94016	2284	" Cover
399a	2114	" " Screw
SS599f	2114	" Screw Stud
94048	2114	Pinion
80028	2114	" Dowel Pin
SS600f	2114	" Screw Stud (eccentric)
†94052b	2284	Hand Attachment , complete, Nos. SS565e, SS566e, SS599f, SS600f, 94016, 94027, 94034b, 94037, 94038, 94041, 94044, 94050, 94051b, 94069, 94070, two each 183e and 399a
SS566e	2114	Hand Attachment Screw

†In ordering it is necessary to state Class of Machine.

Obsolete Parts

No.	Plate	
*81704	---	Arm , with 443c and 8206 for 80150 for 27K Machines
*81709	---	" " 443c " 8206 " 81712 " 27K Machines
*8426	---	" " 443c " 8206 " 28K Machines
<i>NOTE. In ordering 8426 it is necessary to state the Class and Variety number of machine.</i>		
8205	---	Arm Shaft for 27K Machines
8333	---	" " " 27K "
8353	---	" " " 28K "
8430	---	" " " 28K "
80002	---	Balance Wheel for 27K1 and 27K2 Machines
80002b	---	" " " 27K3 " 27K4 "
8355	---	" " " 28K1 " 28K2 "
8355b	---	" " " 28K3 " 28K4 "
8315	44	Belt Cover for 27K Machines
159a	53	" " Screw
81739	44	" " for 28K Machines
190a	53	" " Screw
190f	53	" " "
*2021	47	Clamp Stop Motion Flanged Bushing for 15152
15152	---	" " " " " 2021, with two 462a1 for 27K Machines
*8360	47	" " " " " " for 8423
8423	---	" " " " " " 8360, with two 462a1 for 8359 and 8359b
8359	---	Clamp Stop Motion , complete, Nos. 248f, 256d, 2020 and 8423 for 28K1 and 28K2 Machines
8359b	---	Clamp Stop Motion , complete, Nos. 248a, 256b, 2020 and 8423 for 28K3 and 28K4 Machines
81710	46	Feed Dog , without teeth at right of needle, for 27K and 28K Machines
8213	46	Feed Dog (for export) for 27K and 28K Machines
27c	53	Feed Forked Connection Hinge Screw for 27K and 28K Machines
8219	---	Feed Rock Shaft for 8218
8218	43	" " " 8219 with 8220 for 27K Machines
8220	2520	" " " Crank with 460c for 8218 and 8363
460c	53	" " " " Set Screw for 8220
8364	---	" " " for 8363
8363	43	" " " 8364 with 8220 for 28K Machines
15281	46	Presser Foot for 27K and 28K Machines

No.	Plate	
8229b	2520	Shuttle Bell Crank with two 175e for 27K and 28K Machines
175e	53	" " " Adjusting Screw for 8229b ...
533b	47	" " " Stud for 27K and 28K Machines ...
533d	47	" " " " " 27K and 28K Machines ...
1544b	47	" " " " " Collar with 465a ^{al} for 27K and 28K Machines
465a ^{al}	53	" " " " " Set Screw for 1544b ...
413b	47	Tension Screw Stud for 28K3 and 28K4 Machines ...
413d	47	" " " " " 28K1 " 28K2 " ...
8241	—	Thread Take-up Cam with 448c ...
*8242	—	" " " Lever with 1822 for 28K Machines ...
*8242b	—	" " " " " 1822 ...
79c	53	" " " " " Hinge Screw ...
81711	46	Throat Plate for 81710 ...
8240	46	" " " " 8213 (for export) ...

BOBBIN WINDERS (Automatic)

FOR

28K, 127K and 128K MACHINES

No.	Plate	
8342	929	Back Centre ...
8256	929	" " " Head ...
8256b	929	" " " " ...
8343	929	" " " Spring ...
†8344	929	Bracket (belt cover) ...
158b	929	" " " Screw ...
*8257	1692	Cam ...
*8257b	1692	" " " " ...
50231a	53	" " " Screw ...
50231f	53	" " " " ...
8345	929	Frame ...
80272	929	" " " Friction Washer ...
50101b	929	" " " Hinge Screw ...
50101d	929	" " " " " ...
1718h	929	" " " " " Nut ...
15287	929	Friction Ring (rubber) ...
50102f	929	Spindle ...
15288	929	" " " Pulley ...
15288b	929	" " " " ...
8346	929	Thread Guide ...
8346b	929	" " " " ...
92b	53	" " " Hinge Screw ...
92d	53	" " " " " " ...
8260	1692	" " " Spring ...
8261	1692	Worm Wheel ...
8261b	1692	" " " " ...
55514	—	" " " 8261 with 8257 and 50231f ...
55514b	—	" " " 8261b with 8257b and 50231a ...
2749	1692	" " " Friction Washer ...
50104b	929	" " " Screw Stud (eccentric) ...
50104d	929	" " " " " (") ...
1718h	929	" " " " " Nut ...
8347	928	Bobbin Winder (automatic) , complete, Nos. 92d, 2749, 8256, 8260, 8342 to 8346, 15287, 15288, 50101d, 50102f, 50104d, 55514, 80272 and two 1718h, for 28K1 and 28K2 Machines
†8347b	928	Bobbin Winder (automatic) , complete, Nos. 92b, 2749, 8256b, 8260, 8342 to 8346b, 15287, 15288b, 50101b, 50102f, 50104b, 55514b, 80272 and two 1718h, for 28K3, 28K4, 127K and 128K Machines

†In ordering, it is necessary to state the class of machine, and when for 128K Machine to state also whether "Gilt" or "Coloured" Ornamentation is required.

Numerical List of Parts

No.	Plate	
27c	53	Feed Forked Connection Hinge Screw for 27K and 28K Machines (Obsolete)
42e	53	Feed Regulator Hinge Screw
44c	53	Shuttle Pitman Screw Stud
79c	53	Thread Take-up Lever Hinge Screw (Obsolete)
92b	53	Bobbin Winder Thread Guide Hinge Screw for 8347b and 55511b
92d	53	Bobbin Winder Thread Guide Hinge Screw for 8347 and 55511
NN95j	2399	Embroidery Hoop Clamping Bracket Screw Nut for 96417 to 96421, 96423 and 96424
97e	53	Presser Bar Lifter Screw
97e	53	Tension Releasing Lever Hinge Screw for 128K Machines
107b	53	Thread Take-up Lever Cover Hinge Screw ...
107d	53	Thread Take-up Lever Cover Hinge Screw ...
50571c	122 53	Arm Rock Shaft Adjusting Screw for 8203
138e	53	Arm Screw for 28K and 128K Machines ...
158b	929	Bobbin Winder Bracket Screw for 8347, 8347b, 55511 and 55511b
159a	53	Belt Cover Screw for 27K Machine (Obsolete)
175e	53	Needle Bar Cam Clamping Screw for 8222 ...
175e	53	Shuttle Bell Crank Adjusting Screw for 8229b (Obsolete)
175j	53	Feed Forked Connection Adjusting Screw for 8348 and 8443
175j	53	Shuttle Pitman Adjusting Screw for 8232 and 8445
183c	53	Hand Attachment Body Bracket Screw for 94052b
190a	53	Belt Cover Screw for 28K Machine (Obsolete)
190f	53	Belt Cover Screw for 28K Machine (Obsolete)
191k	53	Feed Dog Screw
215h	53	Shuttle Tension Regulating Screw for 8327 and 54505
216c	53	Shuttle Pitman Screw Stud (eccentric) Screw
219a	53	Face Plate Screw
219a	53	Throat Plate Screw
219f	53	Face Plate Screw for 28K Machines ...
219f	53	Throat Plate Screw for 28K Machines ...
231k	53	Shuttle Carrier Screw
233b	53	Thread Take-up Spring Regulator Plate Adjusting Screw

No.	Plate	
233d	53	Thread Take-up Spring Regulator Plate Adjusting Screw for 28K Machines ...
233d	53	Needle Bar Cam Position Screw ...
248a	53	Clamp Stop Motion Clamp Stop Screw for 8359b and 15314b ...
248f	53	Clamp Stop Motion Clamp Stop Screw for 8359 and 15314 ...
249a	53	Needle Bar Thread Guard and Needle Stop Screw ...
249f	53	Needle Bar Thread Guard and Needle Stop Screw for 28K Machines ...
253b	47	Feed Regulating Thumb Screw ...
253d	47	Feed Regulating Thumb Screw for 28K Machines ...
256b	47	Clamp Stop Motion Clamp Screw for 8359b and 15314b ...
256d	47	Clamp Stop Motion Clamp Screw for 8359 and 15314 ...
263d	47	Pressure Regulating Thumb Screw for 28K Machines ...
263j	47	Pressure Regulating Thumb Screw ...
301c	47	Arm Rock Shaft Screw Centre (lower) ...
307c	47	Feed Rock Shaft Screw Centre ...
315c	47	Feed Dog Carrier Screw Centre ...
399a	53	Hand Attachment Gear Cover Screw for 94052b ...
413b	47	Tension Screw Stud for 28K3 and 28K4 Machines ... (Obsolete)
413d	47	Tension Screw Stud for 28K1 and 28K2 Machines ... (Obsolete)
SS416b	813	Tension Screw Stud for 81729 ...
SS416d	813	Tension Screw Stud for 81729 ...
443c	926	Arm Shaft Bushing Set Screw for 8426, 8447, 54501, 55501, 81704 and 81709 ...
448c	53	Thread Take-up Cam Set Screw for 8241 and 55521 ...
453c	53	Presser Bar Spring Bracket Set Screw for 55507 ...
460c	53	Feed Rock Shaft Crank Set Screw for 8220 (Obsolete)
462a1	926	Clamp Stop Motion Flanged Bushing Set Screw for 8423, 15152 and 15313 ...
465c	53	Shuttle Bell Crank Stud Collar Set Screw for 1544b ... (Obsolete)
520c	53	Shuttle Pitman Screw Stud (eccentric) ...
SS528j	2399	Embroidery Hoop Clamping Bracket Screw for 96417 to 96421, 96423 and 96424 ...

No.	Plate	
533b	47	Shuttle Bell Crank Stud for 27K and 28K Machines ... (Obsolete)
533d	47	Shuttle Bell Crank Stud for 27K and 28K Machines ... (Obsolete)
SS565e	2114	Hand Attachment Driver Finger Latch Screw Stud for 94052b ...
SS566e	2114	Hand Attachment Screw for 94052b ...
SS567e	2114	Hand Attachment Driver Finger Driving Pad and Plate Binding Screw for 94041 ...
SS599f	2114	Hand Attachment Gear Screw Stud for 94052b ...
SS600f	2114	Hand Attachment Pinion Screw Stud (eccentric, for 94052b) ...
649e	926	Arm Screw for 127K Machines ...
1085e	—	Feed Forked Connection Roller Screw Stud for 1832 ...
1274j	926	Tension Screw Stud for 55520 ...
1285e	53	Feed Cam Set Screw for 32562 ...
1381c	53	Feed Forked Connection Hinge Screw (eccentric)
1508j	1693	Arm Rock Shaft Screw Centre Nut ...
1513j	1693	Feed Rock Shaft Screw Centre Nut ...
1519j	1693	Feed Dog Carrier Screw Centre Nut ...
1520j	1693	Feed Forked Connection Hinge Screw Nut ...
1520j	1693	Shuttle Pitman Screw Stud (eccentric) Nut
1544b	47	Shuttle Bell Crank Stud Collar with 465c for 27K and 28K Machines (Obsolete)
1560g	1693	Tension Regulating Thumb Nut for 55520 ...
1560d	1693	Tension Regulating Thumb Nut for 81729 ...
1718h	929	Bobbin Winder Frame Hinge Screw Nut for 8347, 8347b, 55511 and 55511b ...
1718b	929	Bobbin Winder Worm Wheel Screw Stud Nut for 8347, 8347b, 55511 and 55511b ...
1822	1693	Thread Take-up Lever Roller and Stud for 8242, 8242b, 55525 and 55525b ...
1832	1693	Feed Forked Connection Roller with 1085e ...
1833	1693	Feed Dog Carrier Roller and Screw Stud ...
1836	1693	Needle Bar Cam Roller and Screw Stud ...
2002	926	Arm Dowel Pin ...
2007	46	Arm Spool Pin ...
2020	47	Clamp Stop Motion Clamp Washer for 8359, 8359b, 15314 and 15314b ...
*2021	47	Clamp Stop Motion Flanged Bushing for 15152 ... (Obsolete)

No.	Plate	
2022	46	Clamp Stop Motion Flanged Bushing Pin ...
2054	46	Needle Clamp with 140545c ...
2070	2520	Presser Bar Spring Washer ...
2102	46	Tension Disc for 55520 and 81729 ...
2117	46	Thread Take-up Cam Pin ...
2749	1692	Bobbin Winder Worm Wheel Friction Washer for 8347, 8347b, 55511 and 55511b ...
4389	46	Arm Dowel Pin (for repairs only) ...
8203	43	Arm Rock Shaft with 122e for 127K Machines
8204	2520	Arm Rock Shaft Centre (upper) for 127K Machines ...
8205	—	Arm Shaft for 27K Machines (Obsolete)
8206	2520	Arm Shaft Bushing for 8426, 8447, 54501, 55501, 81704 and 81709 ...
8210b	44	Face Plate 55529b with 125423b for 127K Machines ...
8210p	44	Face Plate 55529p with 125423b for 127K Machines ...
8213	46	Feed Dog (for export) for 27K and 28K Machines ... (Obsolete)
8216	2520	Feed Regulator ...
8217	2520	Feed Regulator Friction Washer ...
8218	43	Feed Rock Shaft 8219 with 8220 for 27K Machines ... (Obsolete)
8219	—	Feed Rock Shaft for 8218 (Obsolete)
8220	2520	Feed Rock Shaft Crank with 460c for 8218 and 8363 ... (Obsolete)
8221	44	Needle Bar for 127K Machines ...
*8222	2520	Needle Bar Cam with 175e ...
8224	44	Presser Bar for 127K Machines ...
8225	47	Presser Bar Spring for 127K Machines ...
8228	46	Shuttle Bobbin for 8327, 54505 and 86502 ...
8229b	2520	Shuttle Bell Crank with two 175e for 27K and 28K Machines ... (Obsolete)
8231	46	Shuttle Carrier for 28K Machines ...
8232	44	Shuttle Pitman with two 175j for 127K Machines ...
8237	46	Tension Releaser 81729 ...
8237b	46	Tension Releaser 81729 ...
8238h	46	Tension Spring for 55520 and 81729 ...
8240	46	Throat Plate for 8213 (for export) (Obsolete)
8241	—	Thread Take-up Cam with 448c (Obsolete)
*8242	—	Thread Take-up Lever with 1822 for 28K Machines ... (Obsolete)
*8242b	—	Thread Take-up Lever with 1822 (Obsolete)

No.	Plate	
8243	2520	Thread Take-up Lever Cover for 28K Machines
8243b	2520	Thread Take-up Lever Cover ...
8243p	2520	Thread Take-up Lever Cover ...
8244	46	Thread Take-up Spring for 55520 ...
8256	929	Bobbin Winder Back Centre Head for 8347 and 55511 ...
8256b	929	Bobbin Winder Back Centre Head for 8347b and 55511b ...
*8257	1692	Bobbin Winder Cam for 55514 ...
*8257b	1692	Bobbin Winder Cam for 55514b ...
8260	1692	Bobbin Winder Thread Guide Spring for 8347, 8347b, 55511 and 55511b ...
8261	1692	Bobbin Winder Worm Wheel for 55514 ...
8261b	1692	Bobbin Winder Worm Wheel for 55514b ...
*8301	—	Shuttle Body for 8327 ...
8315	44	Belt Cover for 27K Machines (Obsolete)
8321	813	Feed Dog, four teeth at right of needle (square corners) ...
8323	813	Throat Plate for 8321 for 28K Machines ...
8323b	813	Throat Plate for 8321 ...
8326	46	Shuttle Tension Spring for 8327 and 54505 ...
8327	46	Shuttle, complete, Nos. 215h, 8228, 8301 and 8326, for 28K Machines ...
*8328	—	Bed for 127K Machines ...
8333	—	Arm Shaft for 27K Machines (Obsolete)
8334	811	Feed Rock Shaft for 127K Machines ...
8337	813	Presser Foot for 28K Machines ...
8337b	813	Presser Foot ...
8338	926	Needle Bar Thread Guard for 28K Machines
8338b	926	Needle Bar Thread Guard ...
8341	43	Arm Shaft for 127K Machines ...
8342	929	Bobbin Winder Back Centre for 8347, 8347b, 55511 and 55511b ...
8343	929	Bobbin Winder Back Centre Spring for 8347, 8347b, 55511 and 55511b ...
8344	929	Bobbin Winder Bracket (belt cover) for 8347 and 8347b ... (Obsolete)
8345	929	Bobbin Winder Frame for 8347 and 8347b (Obsolete)
8346	929	Bobbin Winder Thread Guide for 8347 and 55511 ...
8346b	929	Bobbin Winder Thread Guide for 8347b and 55511b ...

No.	Plate	
8347	928	Bobbin Winder (automatic), complete, Nos. 92d, 2749, 8256, 8260, 8342 to 8346, 15287, 15288, 50101d, 50102f, 50104d, 55514, 80272 and two 1718h for 28K1 and 28K2 Machines ... (Obsolete)
8347b	928	Bobbin Winder (automatic), complete, Nos. 92b, 2749, 8256b, 8260, 8342 to 8346b, 15287, 15288b, 50101b, 50102f, 50104b, 55514b, 80272 and two 1718h, for 28K3, 28K4, 127K and 128K Machines (Obsolete)
8348	43	Feed Forked Connection with 175j for 127K Machines ...
8352	43	Arm Rock Shaft with 50571e for 28K and 128K Machines ...
8353	—	Arm Shaft for 28K Machines (Obsolete)
8355	—	Balance Wheel for 28K1 and 28K2 Machines (Obsolete)
8355b	—	Balance Wheel for 28K3 and 28K4 Machines (Obsolete)
8359	—	Clamp Stop Motion, complete, Nos. 248f, 256d, 2020 and 8423, for 28K1 and 28K2 Machines ... (Obsolete)
8359b	—	Clamp Stop Motion, complete, Nos. 248a, 256b, 2020 and 8423 for 28K3 and 28K4 Machines ... (Obsolete)
*8360	47	Clamp Stop Motion Flanged Bushing for 8423 ... (Obsolete)
8361	44	Face Plate 54529 with 125423 for 28K Machines ...
8361b	44	Face Plate 54529b with 125423b for 28K and 128K Machines ...
8361p	44	Face Plate 54529p with 125423b for 28K and 128K Machines ...
8363	43	Feed Rock Shaft 8364 with 8220 for 28K Machines ... (Obsolete)
8364	—	Feed Rock Shaft for 8363 (Obsolete)
8365	44	Needle Bar for 28K and 128K Machines ...
8366	44	Presser Bar for 28K and 128K Machines ...
8396	2520	Arm Rock Shaft Centre (upper) for 28K and 128K Machines ...
8423	—	Clamp Stop Motion Flanged Bushing 8360 with two 462a for 8359 and 8359b (Obsolete)
*8426	—	Arm with 443c and 8206 for 28K Machines (Obsolete)

No.	Plate	
8430	—	Arm Shaft for 28K Machines (Obsolete)
8431	811	Feed Rock Shaft for 28K and 128K Machines
8437	47	Feed Dog Carrier ...
8443	43	Feed Forked Connection with 175j for 28K and 128K Machines ...
8444	926	Shuttle Bell Crank ...
8445	811	Shuttle Pitman with two 175j for 28K and 128K Machines ...
8446	43	Arm Shaft for 28K and 128K Machines ...
*8447	—	Arm with 443c, 8206, 15404 and two 15405 for 28K Machines ...
*8450	—	Bed for 128K Machines ...
8879	2520	Arm Spool Pin Washer (cloth) ...
12329	813	Tension Releasing Lever Spring for 127K Machines ...
15152	—	Clamp Stop Motion Flanged Bushing 2021 with two 462a for 27K Machines (Obsolete)
15281	46	Presser Foot for 27K and 28K Machines (Obsolete)
15282b	1152	Balance Wheel 2 1/2" Pulley ...
15282p	1152	Balance Wheel 2 1/4" Pulley ...
15287	929	Bobbin Winder Friction Ring (rubber) for 8347, 8347b, 55511 and 55511b ...
15288	929	Bobbin Winder Spindle Pulley for 8347 and 55511 ...
15288b	929	Bobbin Winder Spindle Pulley for 8347b and 55511b ...
*15312	926	Clamp Stop Motion Flanged Bushing ...
15313	—	Clamp Stop Motion Flanged Bushing with two 462a for 15314 and 15314b ...
15314	—	Clamp Stop Motion, complete, Nos. 248f, 256d, 2020 and 15313 for 28K Machines ...
15314b	—	Clamp Stop Motion, complete, Nos. 248a, 256b, 2020 and 15313 ...
*15404	—	Trade Mark for 8447, 54501 and 55501 ...
15405	—	Trade Mark Rivet for 8447, 54501 and 55501 ...
15429	1151	Presser Foot for stitching on edge and inserting cord ...
25525	905	Bias Gauge ...
25527b	905	Cloth Guide for 86502 ... (Attachments)
25537	905	Screw Driver (machine) for 86502 ...
25539	905	Stiletto for 35985 ...
26075	2520	Thread Cutter and Holder ...
32562	2520	Feed Cam with 1285c ...
32572	926	Tension Releasing Disc for 55520 ...

No.	Plate	
32675	47	Presser Bar Spring for 28K and 128K Machines
35931	930	Hemmer (adjustable) for 86502 (Attachments)
35932	930	Quilter
35934	910	Ruffler Shirring Plate for 120291
35937	910	Under Braider
35983	1151	Tubular Trimming Attachment Strip Wire for 35985
35984	1151	Tubular Trimming Attachment Presser Foot (strip folding), with tube, for 35985
35985	1151	Tubular Trimming Attachment, complete, for making 3/8", 1/2" and 5/8" trimmings, Nos. 25539, 35983 and 35984
36583	1160	Tucker for 86502 (Attachments)
39443	2520	Tension Releasing Lever Spring for 128K Machines
50036b	926	Shuttle Bell Crank Hinge Screw
50053b	53	Cloth Guide Thumb Screw for 86502 (Attachments)
50101b	929	Bobbin Winder Frame Hinge Screw for 8347b and 55511b
50101d	929	Bobbin Winder Frame Hinge Screw for 8347 and 55511
50102f	929	Bobbin Winder Spindle for 8347, 8347b, 55511 and 55511b
50104b	929	Bobbin Winder Worm Wheel Screw Stud (eccentric) for 8347b and 55511b
50104d	929	Bobbin Winder Worm Wheel Screw Stud (eccentric) for 8347 and 55511
50126e	926	Shuttle Ejector Hinge Screw for 54507
50231a	53	Bobbin Winder Cam Screw for 55514b
50231f	53	Bobbin Winder Cam Screw for 55514
50527c	53	Thread Take-up Lever Hinge Screw for 55526 and 55526b
50571e	53	Arm Rock Shaft Adjusting Screw for 8352 8203
51045c	53	Machine Hinge Connection Set Screw
51224b	53	Arm Side Cover Thumb Screw
51224b	53	Presser Foot Thumb Screw
51224d	53	Arm Side Cover Thumb Screw
51224d	53	Presser Foot Thumb Screw for 28K Machines
*54501	—	Arm with 443c, 8206, 15404 and two 15405, for 128K Machine
54503	926	Presser Bar Lifter for 28K Machines
54503b	926	Presser Bar Lifter
*54504	—	Shuttle Body for 54505

No.	Plate	
54505	926	Shuttle, complete, Nos. 215h, 8228, 8326 and 54504 for 127K and 128K Machines
*54506	926	Shuttle Carrier for 54527
54507	—	Shuttle Carrier, complete, Nos. 50126e, 54510, 54511 and 54527 for 127K and 128K Machines
*54508	926	Shuttle Carrier Cushion Spring for 54527
*54509	926	Shuttle Carrier Cushion Spring Rivet for 54527
54510	926	Shuttle Ejector for 54507
54511	926	Shuttle Ejector Spring for 54507
54512	927	Shuttle Slide (back) for 28K Machines
54512b	927	Shuttle Slide (back) for 28K and 128K Machines
54513	927	Shuttle Slide (front) for 28K Machines
54513b	927	Shuttle Slide (front) for 28K and 128K Machines
54514	926	Tension Releasing Lever for 128K Machines
54515	926	Tension Releasing Pin for 55520
54516	46	Thread Take-up Spring Regulator Plate for 28K Machines
54525b	1690	Arm Side Cover for 28K and 128K Machines
54527	—	Shuttle Carrier 54506 with 54508 and two 54509 for 54507
*54529	—	Face Plate for 8361
*54529b	—	Face Plate for 8361b
*54529p	—	Face Plate for 8361p
54530	2520	Thread Take-up Spring Regulator Plate for 127K and 128K Machines
*55501	—	Arm with 443c, 8206, 15404 and two 15405, for 127K Machines
55503b	927	Shuttle Slide (back) for 127K Machines
55504b	927	Shuttle Slide (front) for 127K Machines
55505	926	Tension Releasing Lever for 127K Machines
55506	926	Tension Releasing Lever Hinge Pin for 127K Machines
55507	813	Presser Bar Spring Bracket with 453c
55509	1692	Bobbin Winder Bracket (belt cover) for 55511 and 55511b
55510	1692	Bobbin Winder Frame for 55511 and 55511b
55511	—	Bobbin Winder (automatic), complete, Nos. 92d, 2749, 8256, 8260, 8342, 8343, 8346, 15287, 15288, 50101d, 50102f, 50104d, 55509, 55510, 55512, 55514 and two 1718h, for 28K1 and 28K2 Machines

No.	Plate	
55511b	---	Bobbin Winder (automatic), complete, Nos. 92b, 2749, 8256b, 8260, 8342, 8343, 8346b, 15287, 15288b, 50101b, 50102f, 50104b, 55509, 55510, 55512, 55514b and two 1718h, for 28K3, 28K4, 127K and 128K Machines
55512	1692	Bobbin Winder Frame Friction Washer for 55511 and 55511b
55514	---	Bobbin Winder Worm Wheel 8261 with 8257 and 50231f for 8347 and 55511
55514b	---	Bobbin Winder Worm Wheel 8261b with 8257b and 50231a for 8347b and 55511b
55515	2520	Bed Oil Hole (shuttle) Packing (braided cotton)
55520	---	Tension, complete, Nos. 1274j, 1560g, 8238h, 8244, 32572, 54515 and two 2102, for 127K and 128K Machines
55521	2520	Thread Take-up Cam 55523 with 448c
*55523	---	Thread Take-up Cam for 55521
*55525	46	Thread Take-up Lever with 1822 for 55526
*55525b	46	Thread Take-up Lever with 1822 for 55526b
55526	---	Thread Take-up Lever 55525 with 50527c for 28K Machine
55526b	---	Thread Take-up Lever 55525b with 50527c
*55529b	---	Face Plate for 8210b
*55529p	---	Face Plate for 8210p
55531	2114	Hand Attachment Crank Lever Lock Pin Spring for 94051b

No.	Plate	
80002	-	Balance Wheel for 27K1 and 27K2 Machines (Obsolete)
80002b	-	Balance Wheel for 27K3 and 27K4 Machines (Obsolete)
80028	2114	Hand Attachment Pinion Dowel Pin for 94070
80272	929	Bobbin Winder Frame Friction Washer for 8347 and 8347b ... (Obsolete)
80307p	1690	Arm Side Cover (plain) for 127K Machines ...
*81704	-	Arm with 443c and 8206 for 80150 for 27K1 and 27K2 Machines ... (Obsolete)
*81709	-	Arm with 443c and 8206 for 81712 for 27K1 and 27K2 Machines ... (Obsolete)
81710	46	Feed Dog, without teeth at right of needle, for 27K and 28K Machines (Obsolete)
81711	46	Throat Plate for 81710 ... (Obsolete)
81715p	-	Arm Side Cover (plain) for 28K and 128K Machines
*81728	-	Bed for 28K Machines
81729	-	Tension, complete, Nos. SS416, 1560, 8237, 8238 and two 2102, for 28K Machines ...
81739	41	Belt Cover for 28K Machines (Obsolete)
81742	-	Drip Pan for 28K and 128K Machines ...
85893	1151	Embroidery Foot (for art work)
86080	813	Feed Cover Plate
86493	1160	Darning Presser Needle Clamp with 140545k for 86496
86494	1160	Darning Presser Needle Clamp Stripper Spring for 86496
86495	1160	Darning Presser Needle Clamp Stripper Spring Eyelet for 86496
86496	1160	Darning Presser, complete, Nos. 86493 to 86495
86502	-	Attachment Set, complete, Nos. 25527b, 25537, 35931, 36583, 50053b, 120378, 120842, 120862, 121464, three 8228 and six needles
87321	-	Drip Pan for 127K Machines
87586	-	Embroidery Hoop (round, birch) 5 $\frac{1}{4}$ " diam. \times 7 $\frac{m}{8}$ " high
87589	1221	Embroidery Hoop (round, birch) 8" diam. \times 7 $\frac{m}{8}$ " high
87593	-	Embroidery Hoop (round, birch) 10" diam. \times 7 $\frac{m}{8}$ " high
87595	-	Embroidery Hoop (round, birch) 12" diam. \times 7 $\frac{m}{8}$ " high
87597	-	Embroidery Hoop (oval, birch) 12" \times 5 $\frac{1}{2}$ " \times 7 $\frac{m}{8}$ " high

No.	Plate	
94016	2284	Hand Attachment Gear Cover for 94052b ...
94027	2284	Hand Attachment Body Bracket for 94052b
94028	2114	Hand Attachment Crank Handle (wood) for 94034b
94029b	2114	Hand Attachment Crank Handle Spindle for 94034b
94030b	2114	Hand Attachment Crank Handle Spindle Flange (loose) for 94034b
94031a	2284	Hand Attachment Crank Lever for 94034b ...
94032	2114	Hand Attachment Crank Lever Lock Pin for 94051b
94033b	2114	Hand Attachment Crank Lever Lock Pin Head for 94051b
94034b	—	Hand Attachment Crank, complete, Nos. 94028, 94029b, 94030b and 94031a, for 94052b
94036	2114	Hand Attachment Driver Finger for 94041 ...
94037	2114	Hand Attachment Driver Finger Latch for 94052b
94038	2114	Hand Attachment Driver Finger Latch Spring for 94052b
94039	2114	Hand Attachment Driver Finger Driving Pad (raw-hide) for 94041
94040	2114	Hand Attachment Driver Finger Driving Pad Plate for 94041
94041	—	Hand Attachment Driver Finger 94036 with SS567e, 94039 and 94040 for 94052b ...
94044	2114	Hand Attachment Driver Finger Hinge Pin for 94052b
94046	2114	Hand Attachment Driver for 94070 ...
94048	2114	Hand Attachment Pinion for 94070 ...
94050	2284	Hand Attachment Body for 94052b ...
94051b	2284	Hand Attachment Gear with SS531, 94032 and 94033b, for 94052b
94052b	2284	Hand Attachment, complete, Nos. SS565e, SS566e, SS599f, SS800f, 94016, 94027, 94034b, 94037, 94038, 94041, 94044, 94050, 94051b, 94069, 94070, two each 183e and 399a
94069	2114	Hand Attachment Crank Hinge Pin for 94052b
94070	—	Hand Attachment Driver 94046 with 80028 and 94048, for 94052b
96416	—	Embroidery Hoop (round, birch) 7" diam. × 7 ^m / _m high

No.	Plate	
96417	—	Embroidery Hoop (round, birch) 5 ⁵ / ₈ " diam. × 7 ^m / _m high with SS528j, NN95j, two 96425 and four 96427
96418	—	Embroidery Hoop (round, birch) 7" diam. × 7 ^m / _m high with SS528j, NN95j, two 96426 and four 96427
96419	—	Embroidery Hoop (round, birch) 8" diam. × 7 ^m / _m high with SS528j, NN95j, two 96426 and four 96427
96420	—	Embroidery Hoop (round, birch) 10" diam. × 7 ^m / ₆ " high with SS528j, NN95j, two 96426 and four 96427
96421	—	Embroidery Hoop (round, birch) 12" diam. × 7 ^m / ₆ " high with SS528j, NN95j, two 96844 and four 96845
96422	1221	Embroidery Hoop (oval, birch) 9" × 4 ¹ / ₂ " × 7 ^m / _m high
96423	—	Embroidery Hoop (oval, birch) 9" × 4 ¹ / ₂ " × 7 ^m / _m high with SS528j, NN95j, 96425, 96426 and four 96427
96424	—	Embroidery Hoop (oval, birch) 12" × 5 ¹ / ₂ " × 7 ^m / _m high with SS528j, NN95j, 96425, 96426 and four 96427
96425	2399	Embroidery Hoop Clamping Bracket for 96417, 96423 and 96424
96426	2399	Embroidery Hoop Clamping Bracket for 96418 to 96420, 96423 and 96424 ...
96427	2399	Embroidery Hoop Clamping Bracket Rivet for 96417 to 96420, 96423 and 96424 ...
96844	2399	Embroidery Hoop Clamping Bracket for 96421
96845	2399	Embroidery Hoop Clamping Bracket Rivet for 96421

NUMERICAL LIST OF PARTS

No.	Plate		
120290	930	Ruffler for 120291	...
120291	—	Ruffler 120290 with 35934	...
120378	905	Screw Driver (shuttle tension) for 86502	...
120687	1151	Imitation Hemstitching Attachment with Yielding Presser Plate	...
120842	1151	Hemmer (foot), $\frac{3}{8}$ " hem, for 86502 (Attachments)	...
120862	—	Tin of Oil ($1\frac{1}{2}$ oz.), for 86502	...
121441	—	Gathering Foot (double toe)	...
121464	930	Binder for 86502	...
125422	2520	Face Plate Thread Guard for 125423	...
125422b	2520	Face Plate Thread Guard for 125423b	...
125423	2520	Face Plate Thread Guard 125422 with 125424 for 8361	...
125423b	2520	Face Plate Thread Guard 125422b with 125424b, for 8210b, 8210p, 8361b and 8361p	...
125424	2520	Face Plate Thread Guard Rivet for 125423	...
125424b	2520	Face Plate Thread Guard Rivet for 125423b	...
125425b	1690	Arm Side Cover for 127K Machines	...
140545c	53	Needle Clamp Thumb Screw for 2054	...
140545k	1160	Darning Presser Needle Clamp Screw for 86493	...