

SINGER
96K40,K45,K49,K51

Form K5990
(Supersedes K5793)

ILLUSTRATED LIST OF PARTS

FOR

Nos. 96K40 to 96K45,

96K49 and 96K51

MACHINES

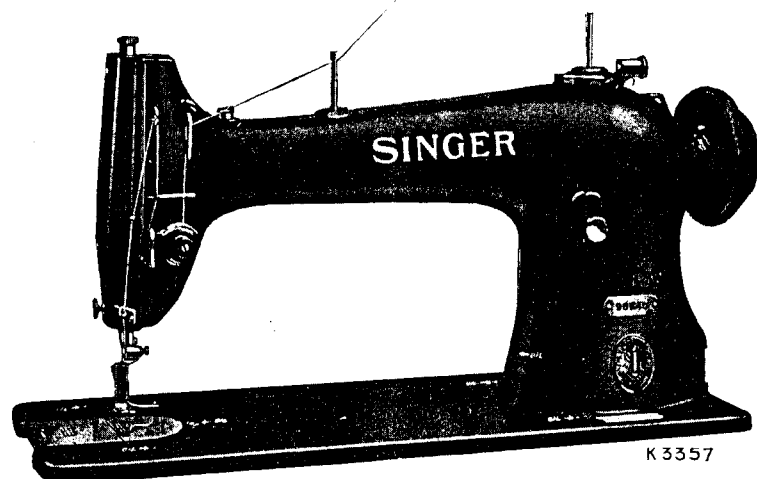

No. 96K51 Machine

** A Trade Mark of
THE SINGER MANUFACTURING COMPANY

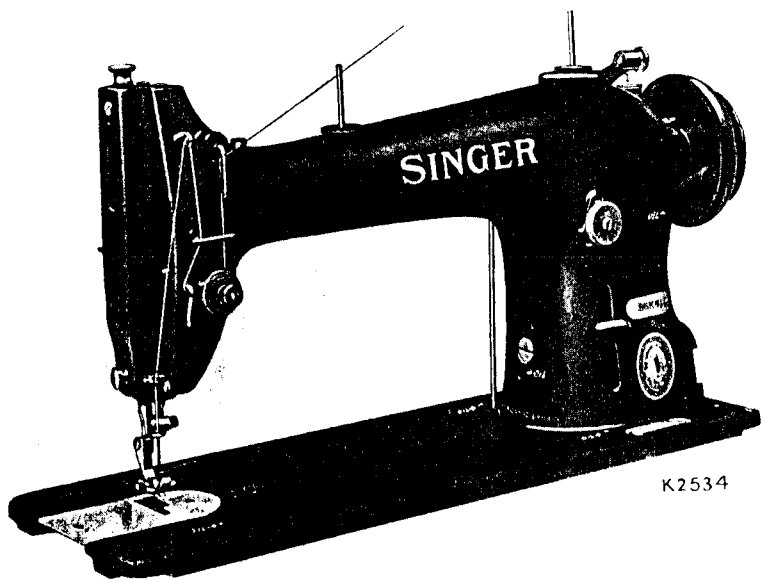

K2534

No. 96K41 Machine

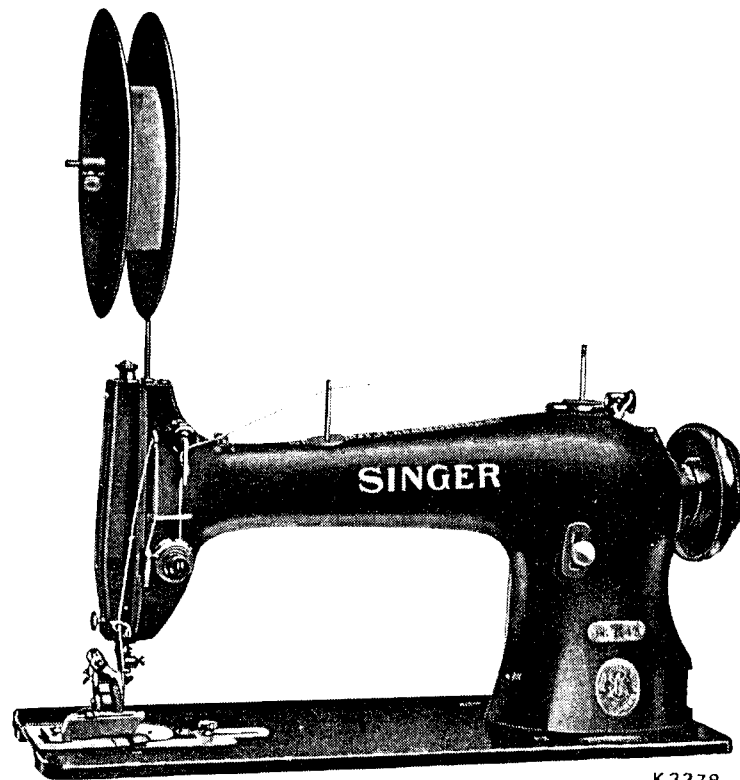

K3378

No. 96K43 Machine

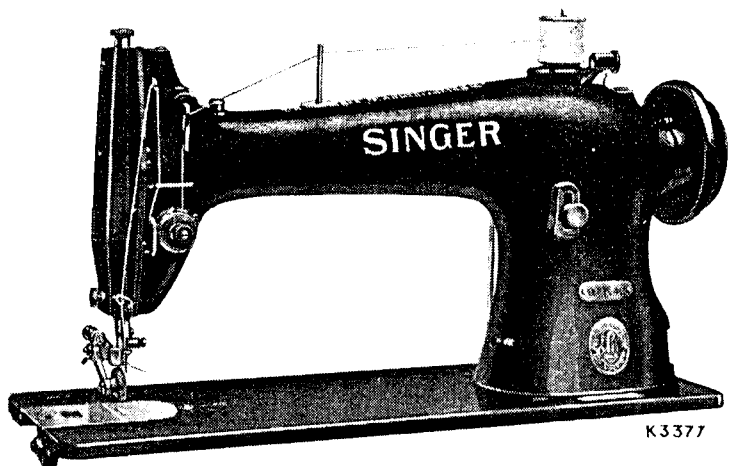

K3377

No. 96K42 Machine

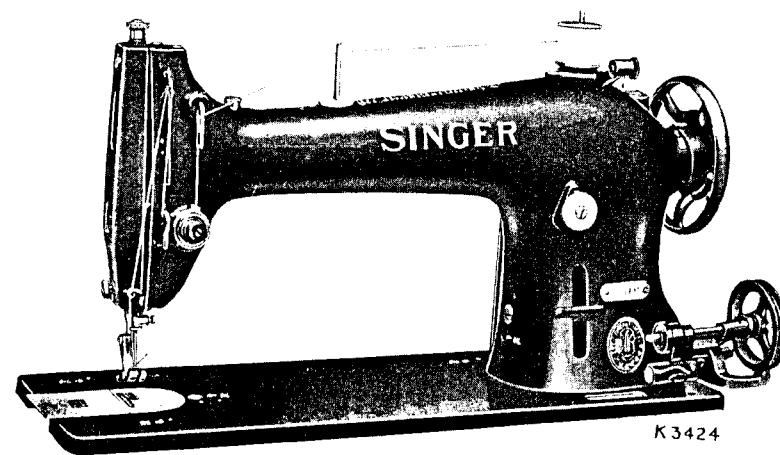

K3424

No. 96K44 Machine

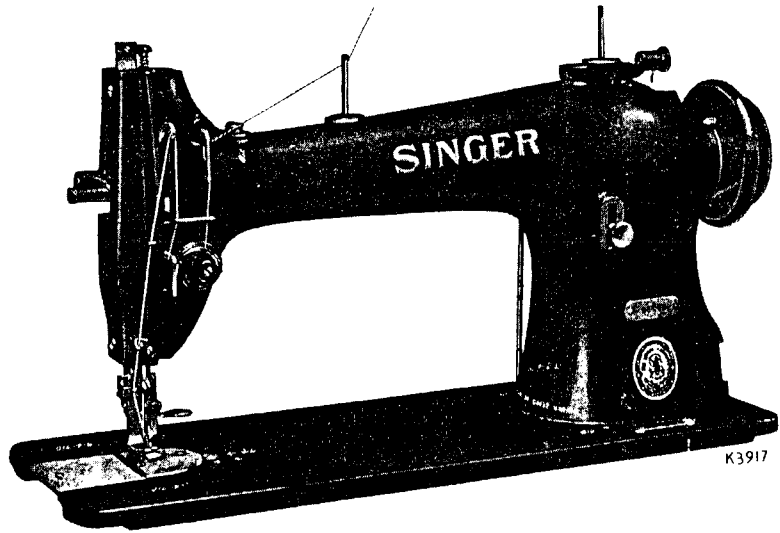

No. 96K45 Machine

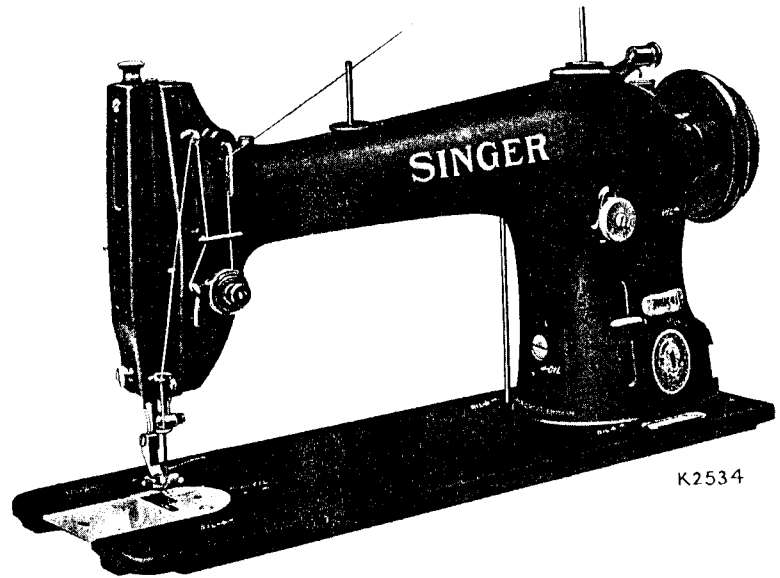

No. 96K49 Machine

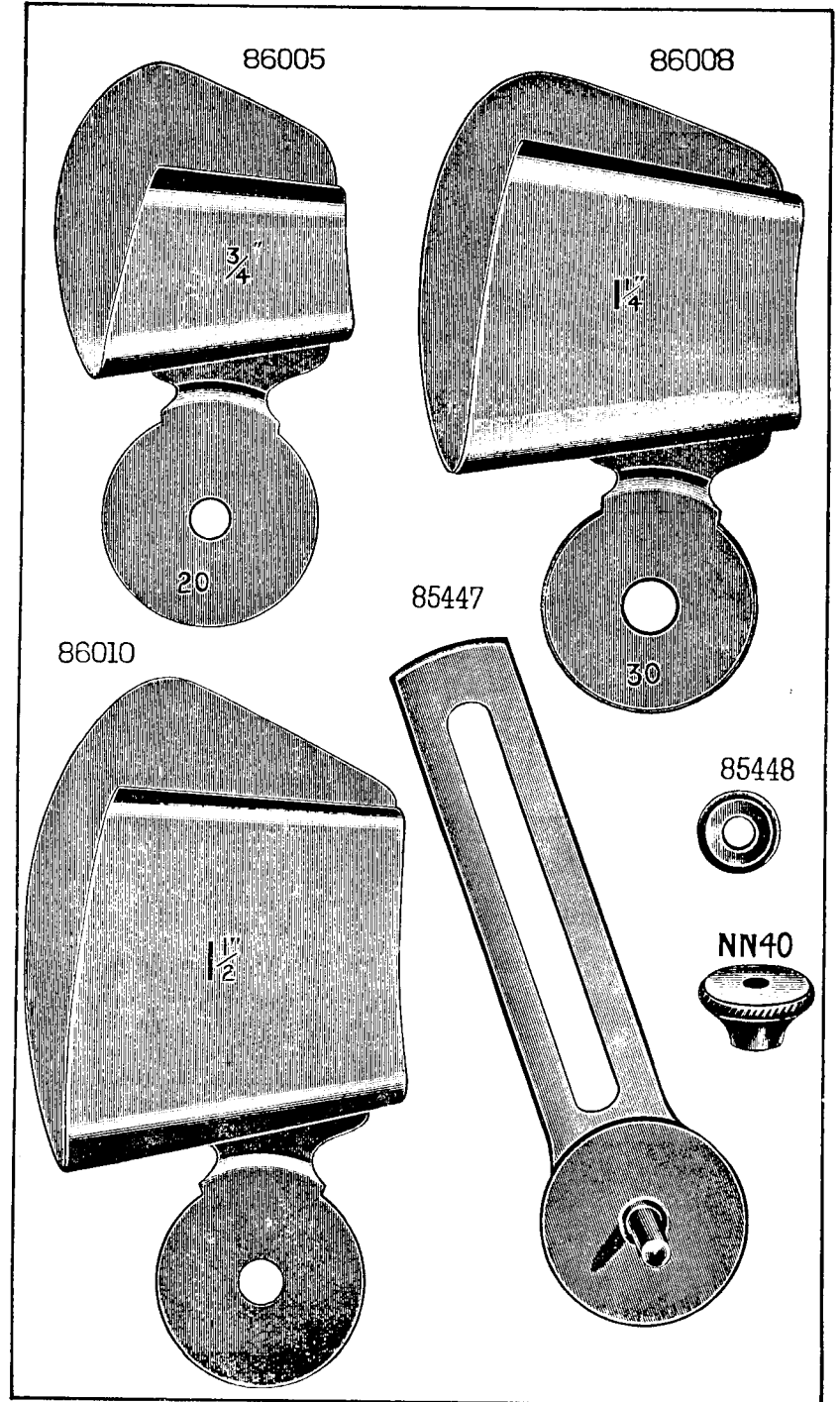

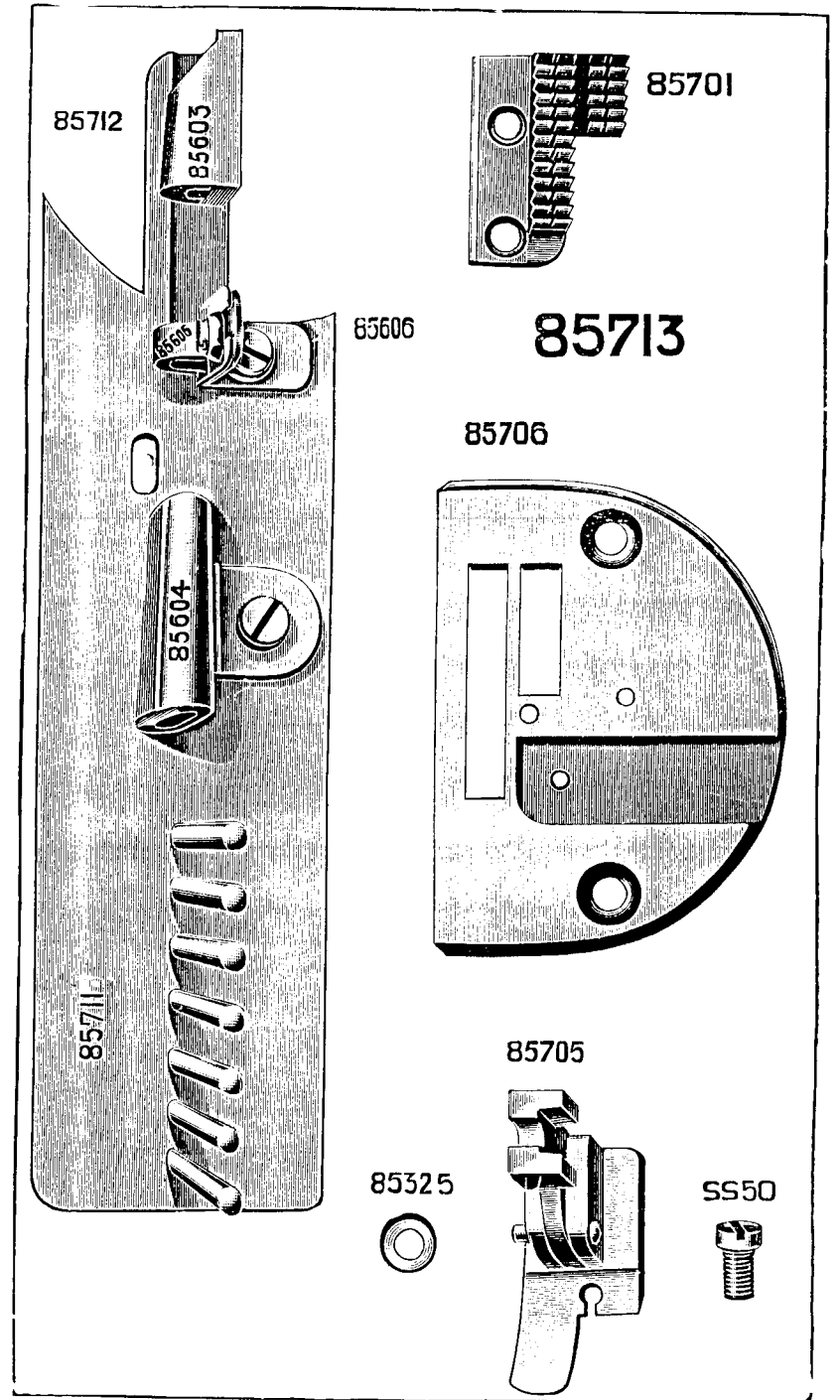
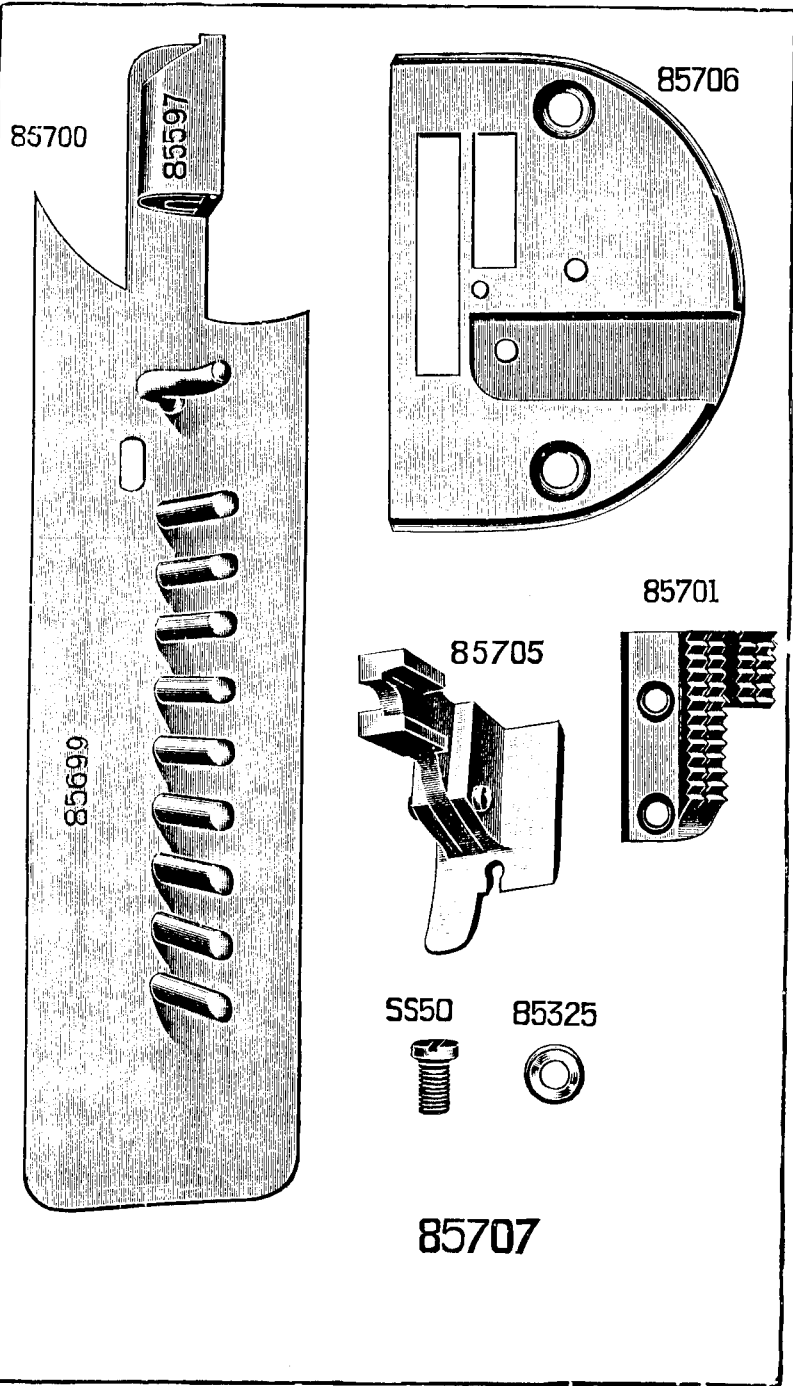

85869

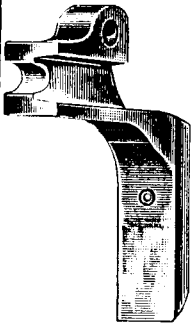

85868

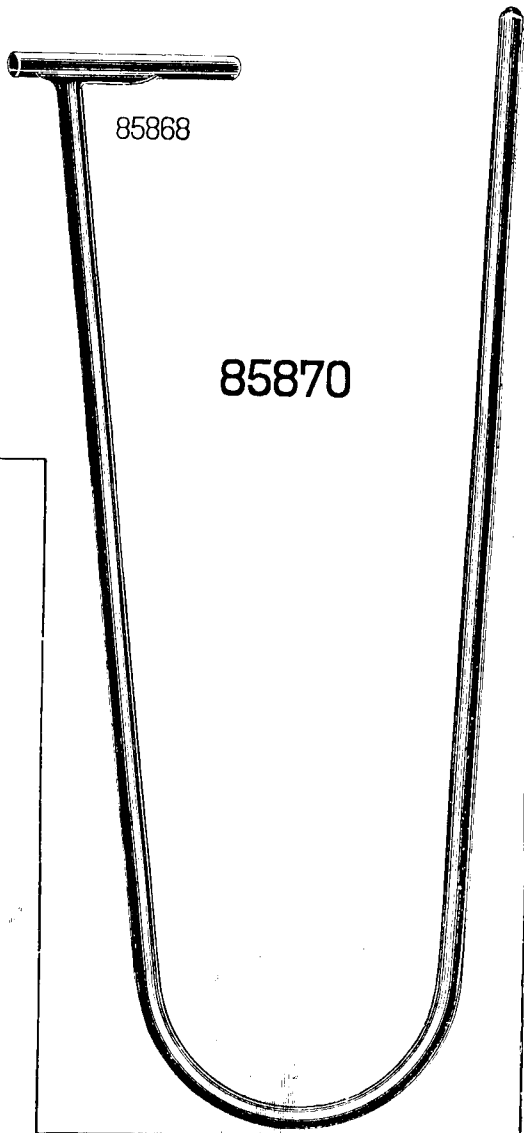

85870

85896

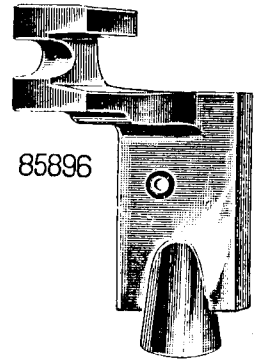

85697

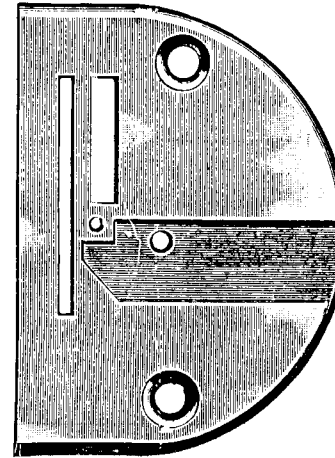

85698

85693

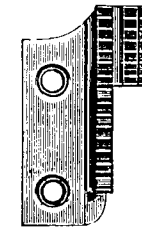

85696



8850



85321

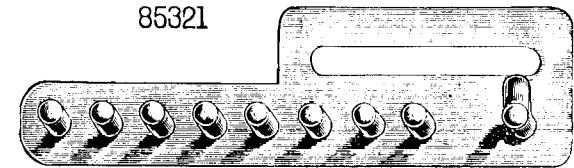

85884

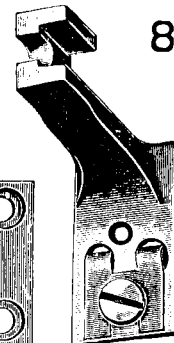

85886

85882

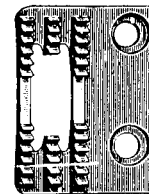

85885

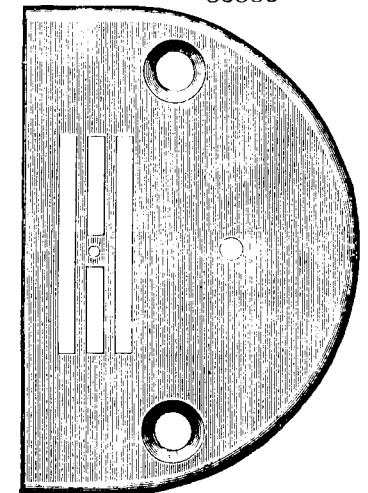

85691

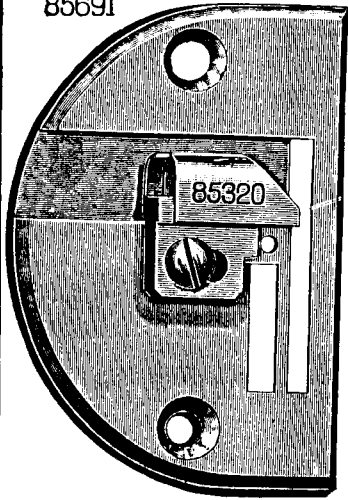

85686

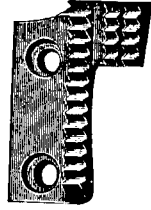

85321

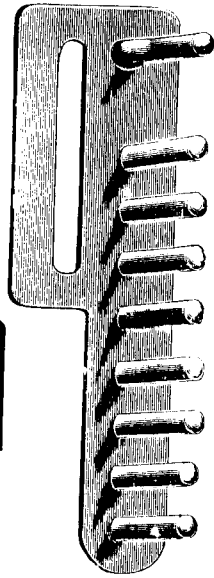

85692

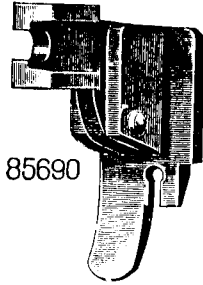

85690

85684

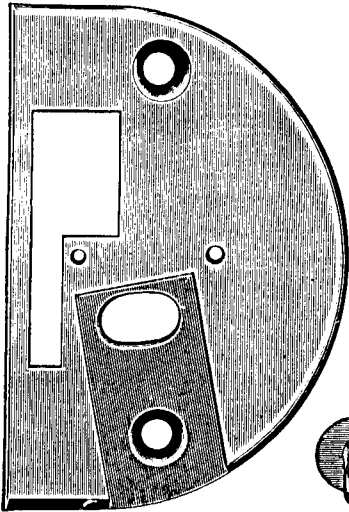

85685

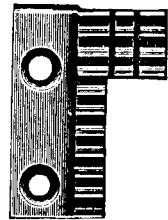

85682

85683



85339

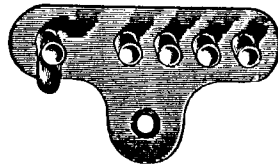

85325



207

85680

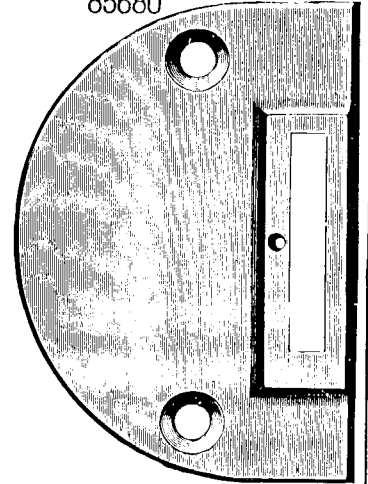

85681

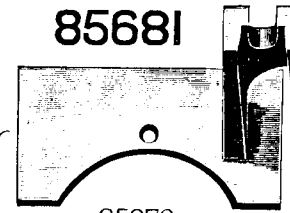

85678



85679

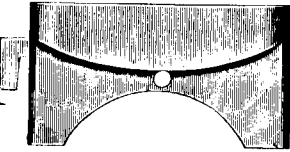

85458

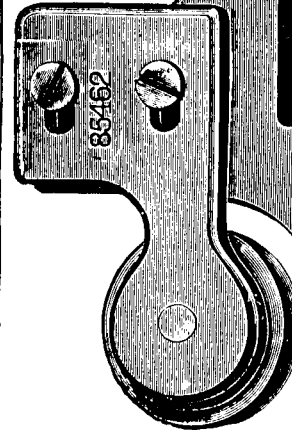

85459

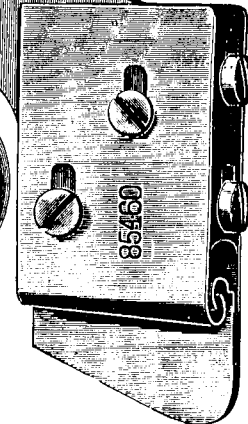

176



85325



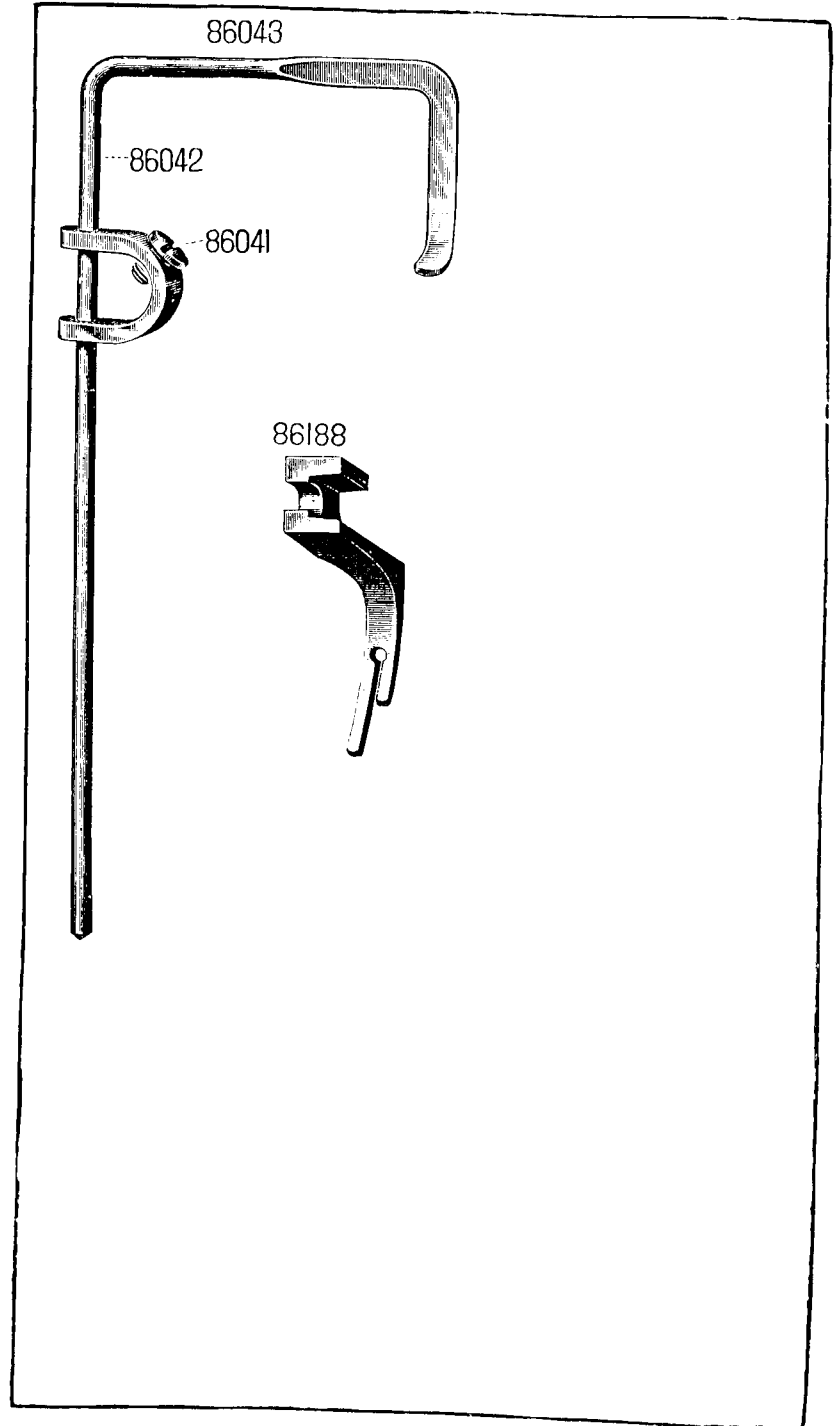
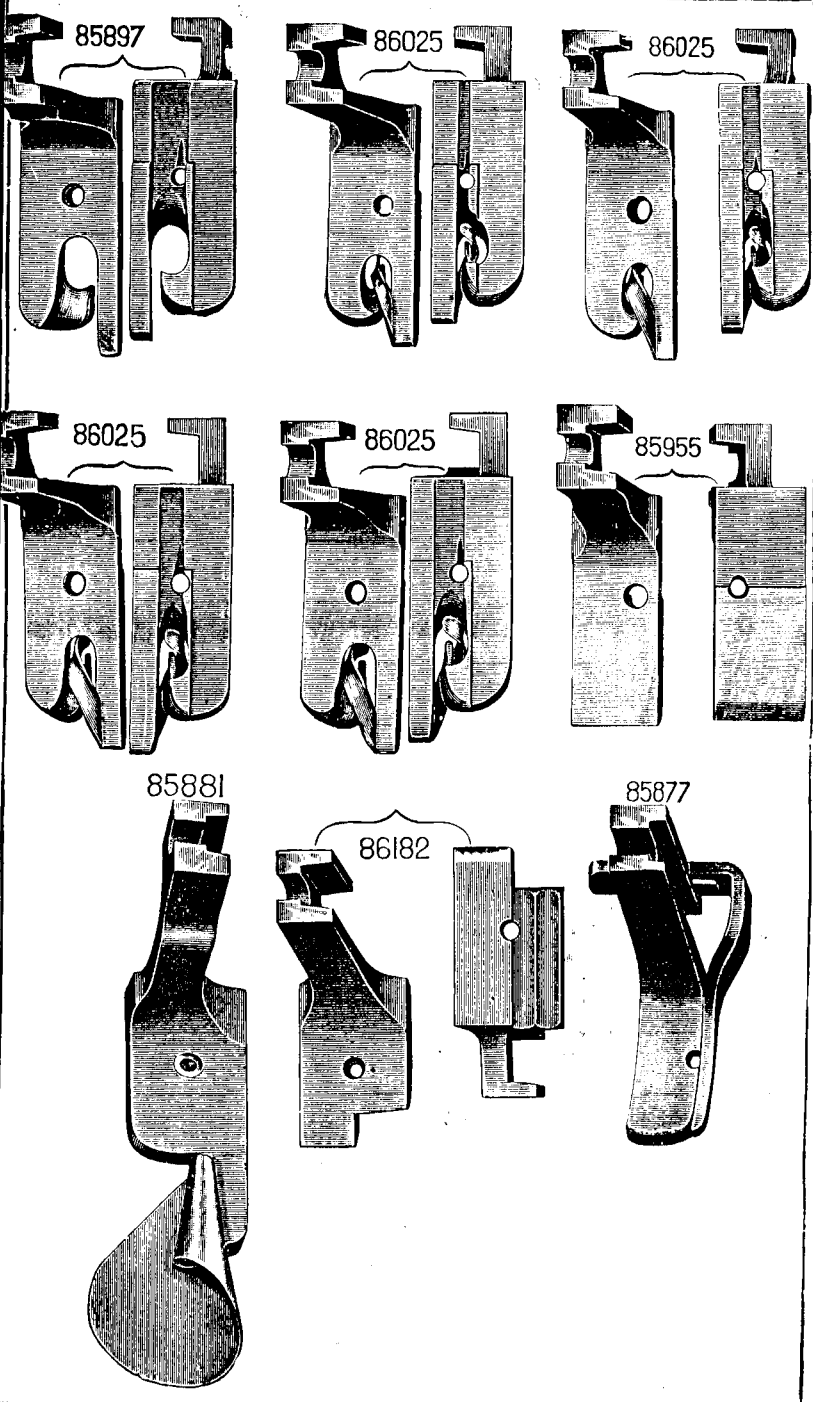

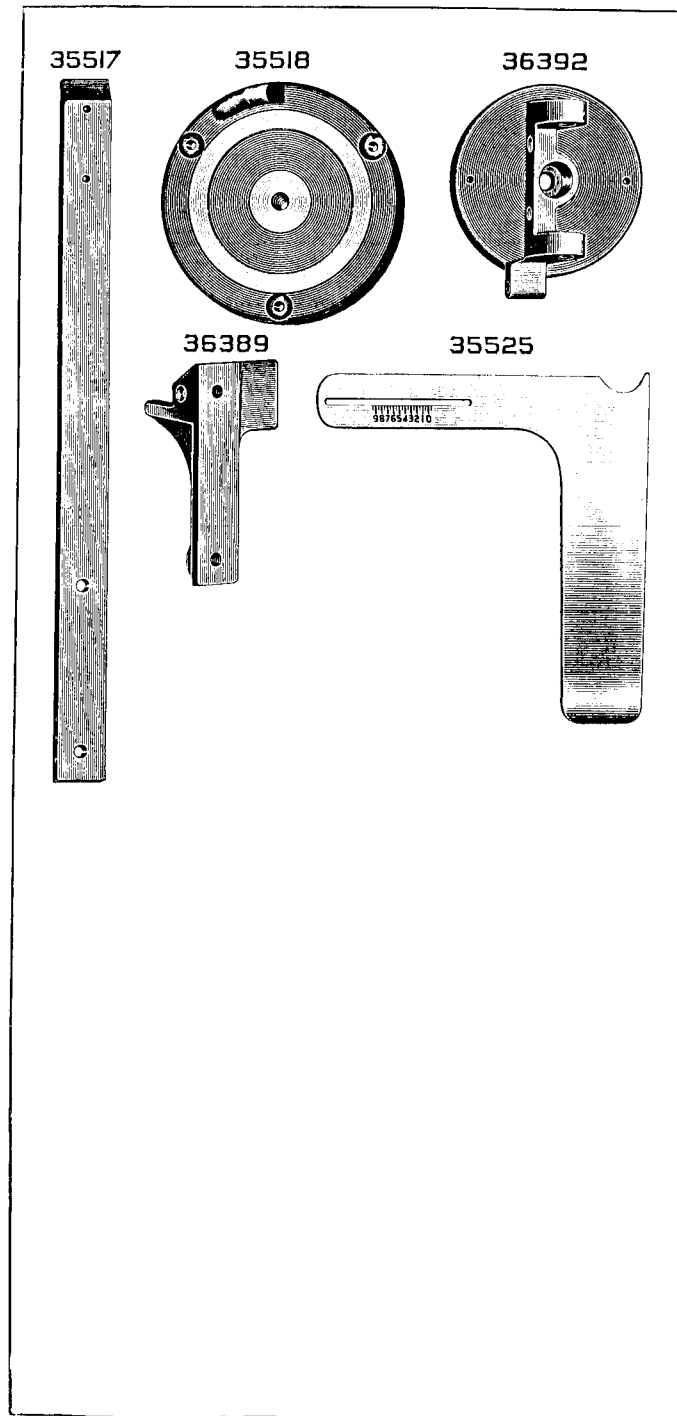
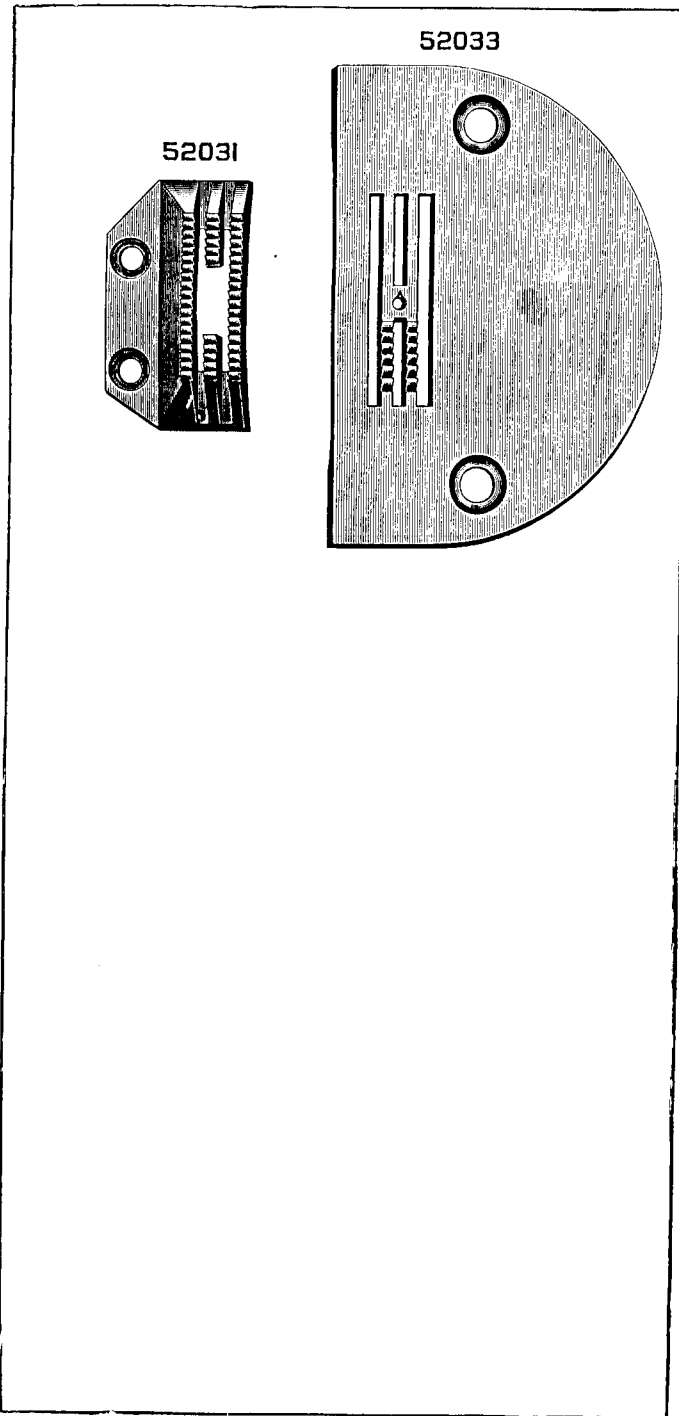

36387

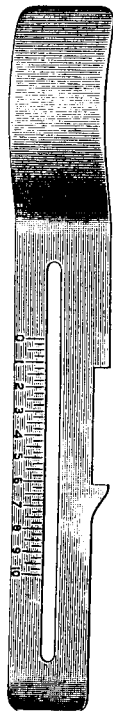

35510

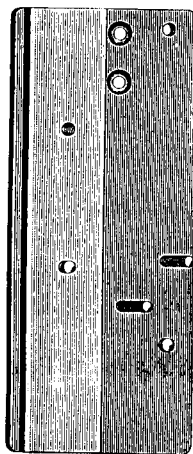

36391

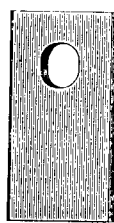

52338

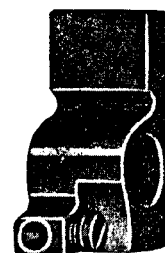

12329



12398



43944

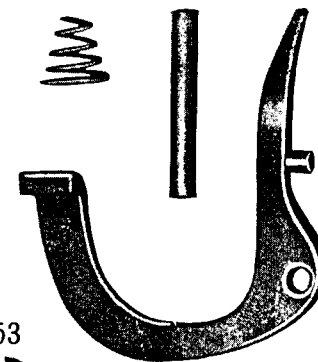

12327

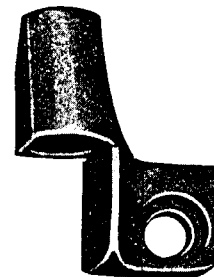

453



41593



41594



41595



223



52337

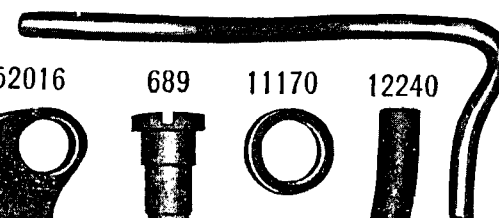

52016



689



11170



12240



1520



12241



12416



8879

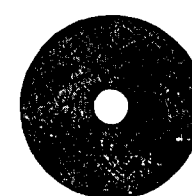

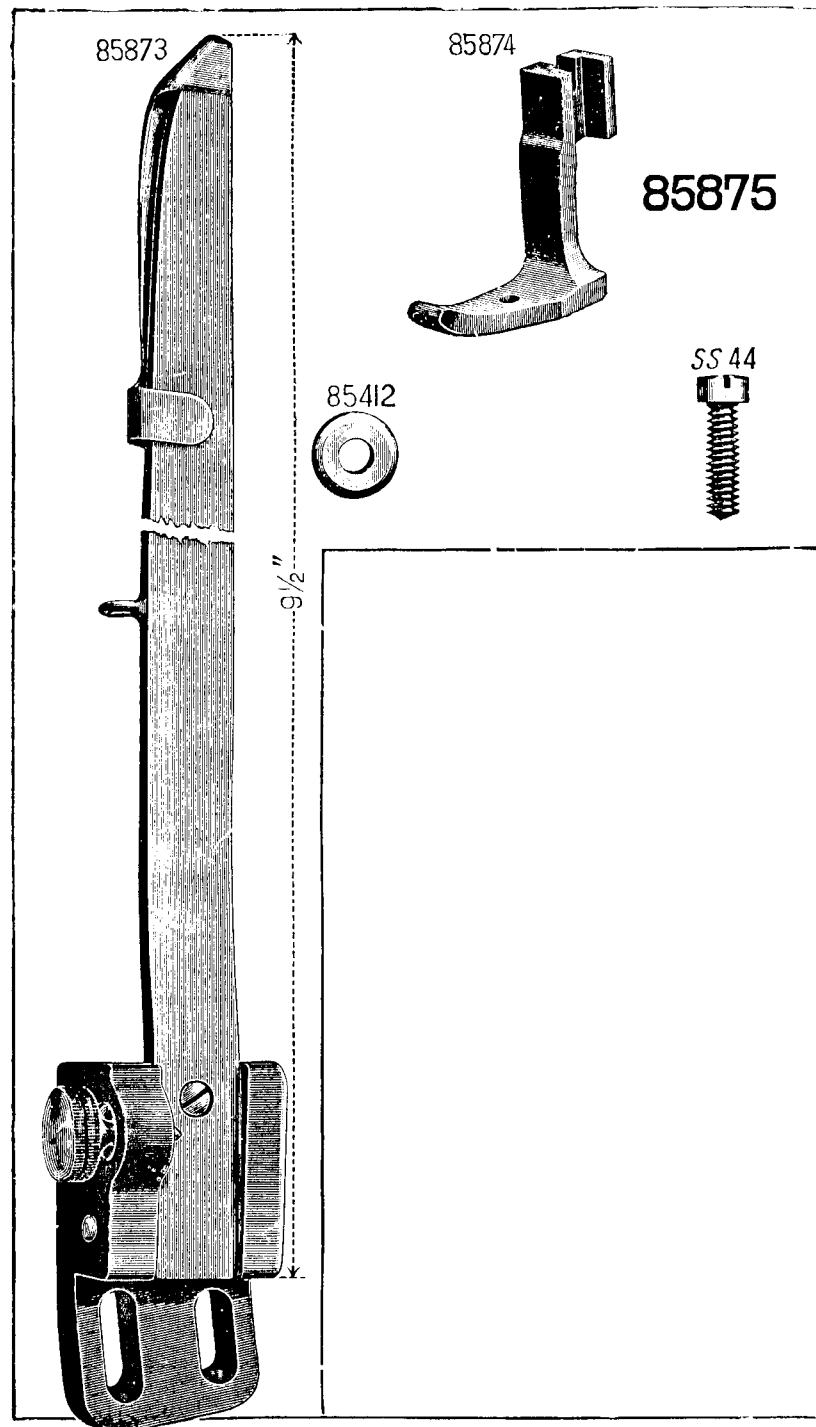
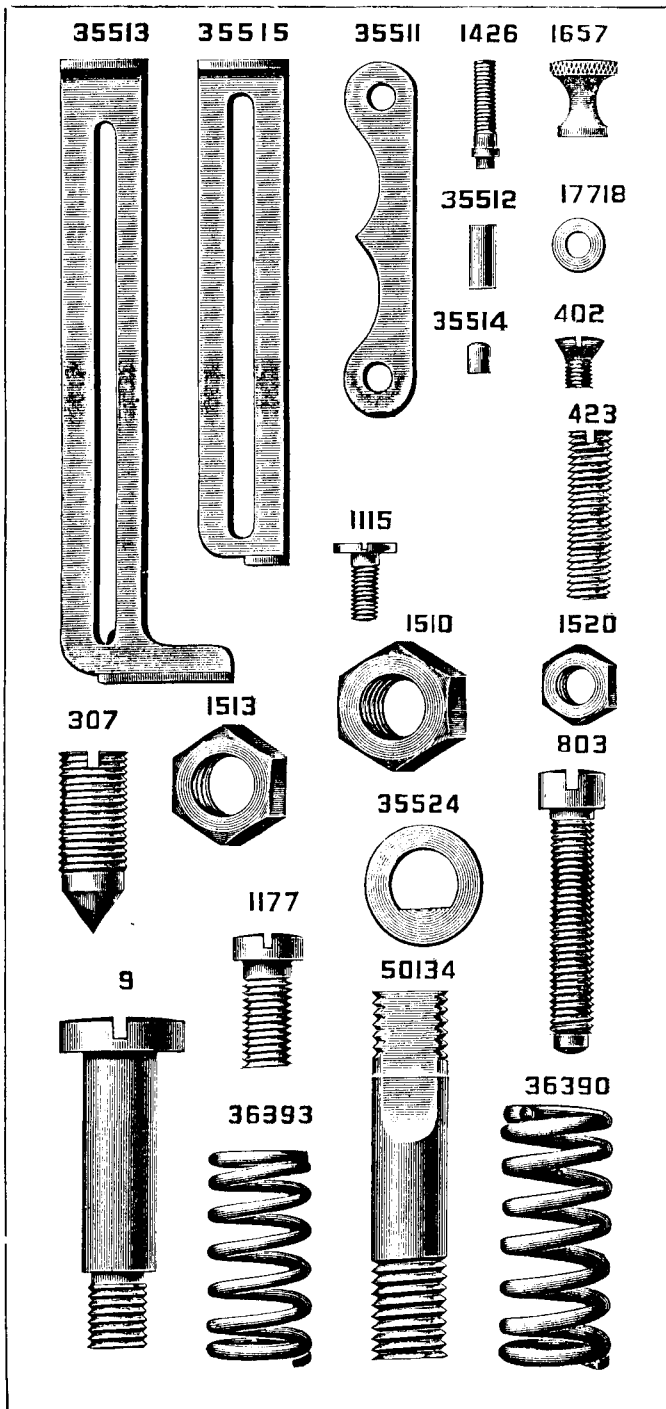

SS28 SS54 SS65

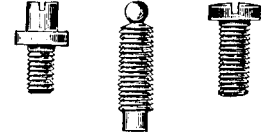

76



102



116



121



144

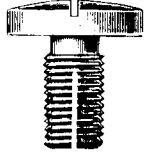

157



158



171



178



185



190



210



219



226



228



233



313



316



356



375



432



435



446



448



457



460



591



592



688

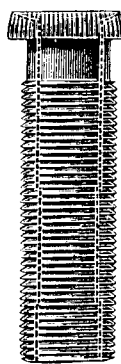

691



701



704



725



759



766



52409

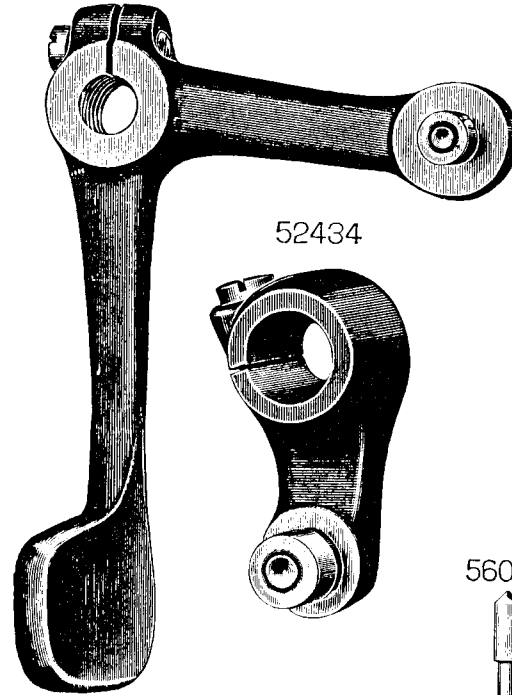

56032

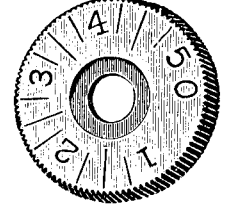

52434

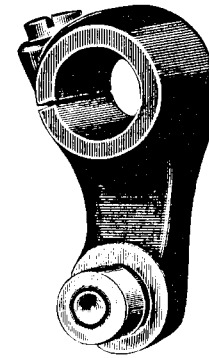

52410



52439

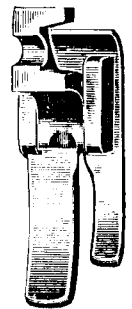

56034



52408

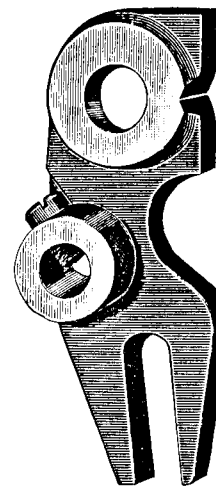

26605

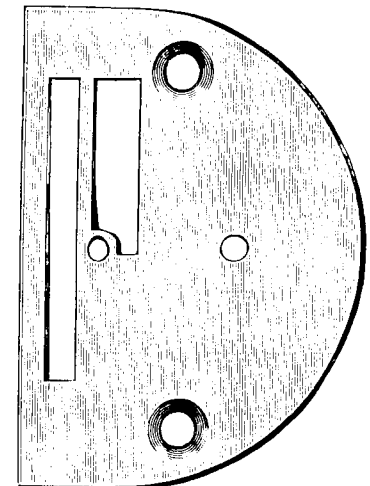

56035



228692 52448

5990

52445

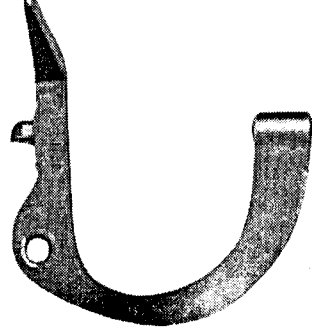
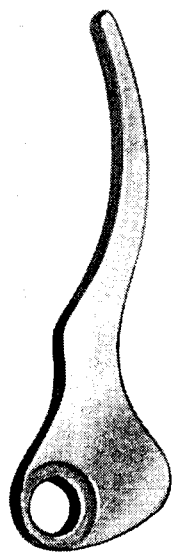
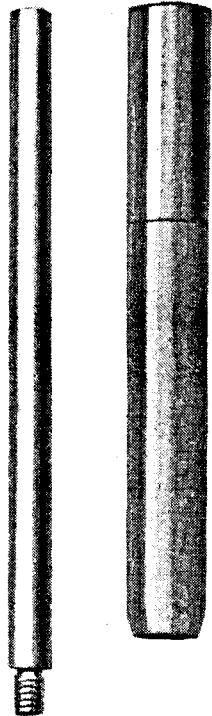

52210

52211



56033



52022

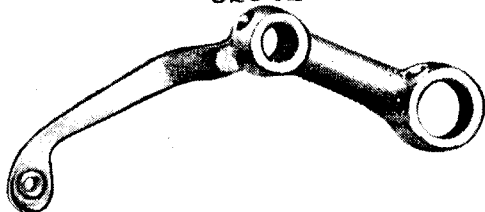

82538

201528



44137

44136

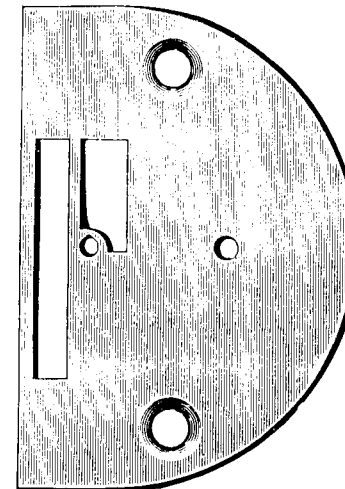
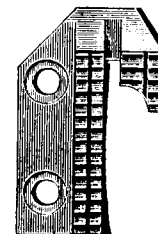

86479

40322

35528

36654

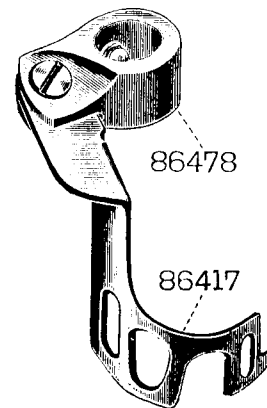

86478

86417

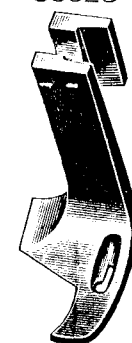

20067

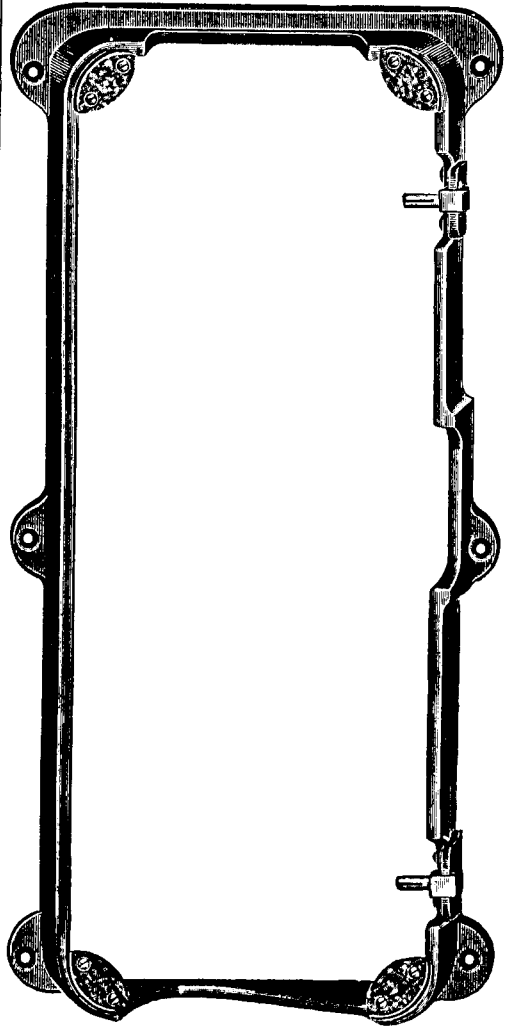

26603

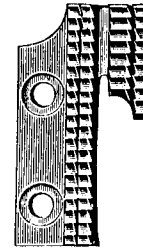

28360

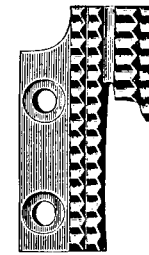

20356

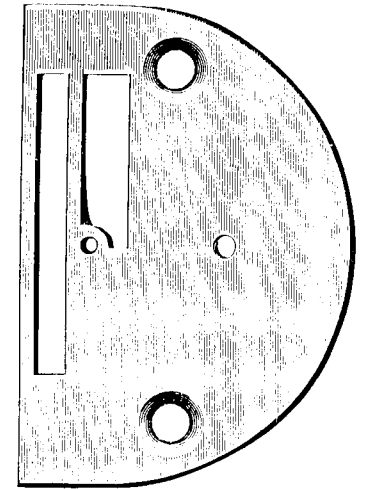

52427

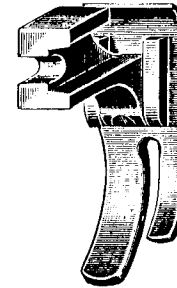

52401

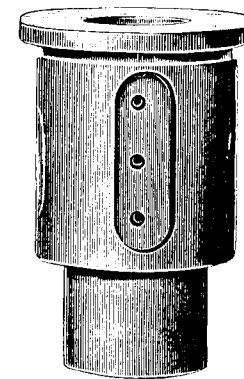

52404

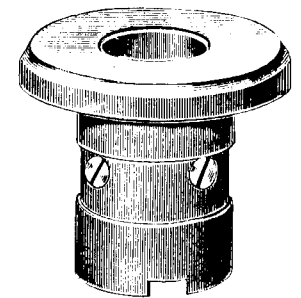

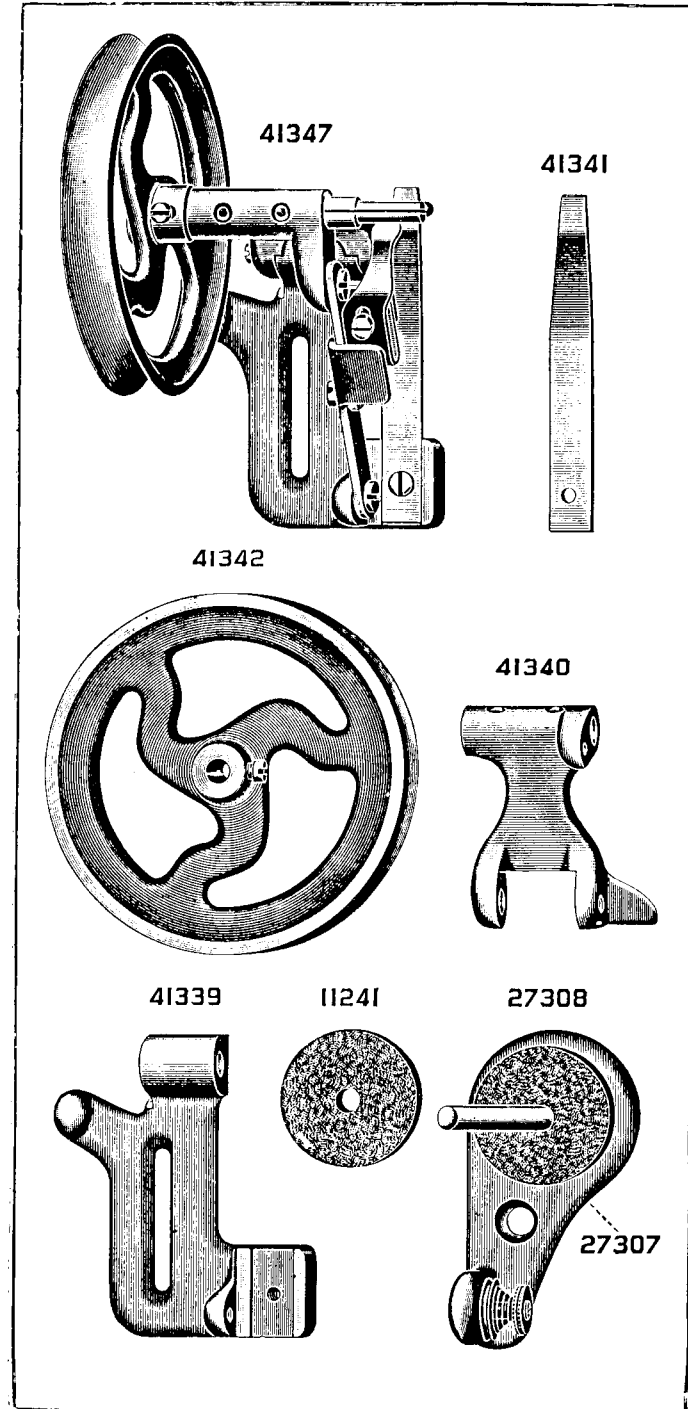
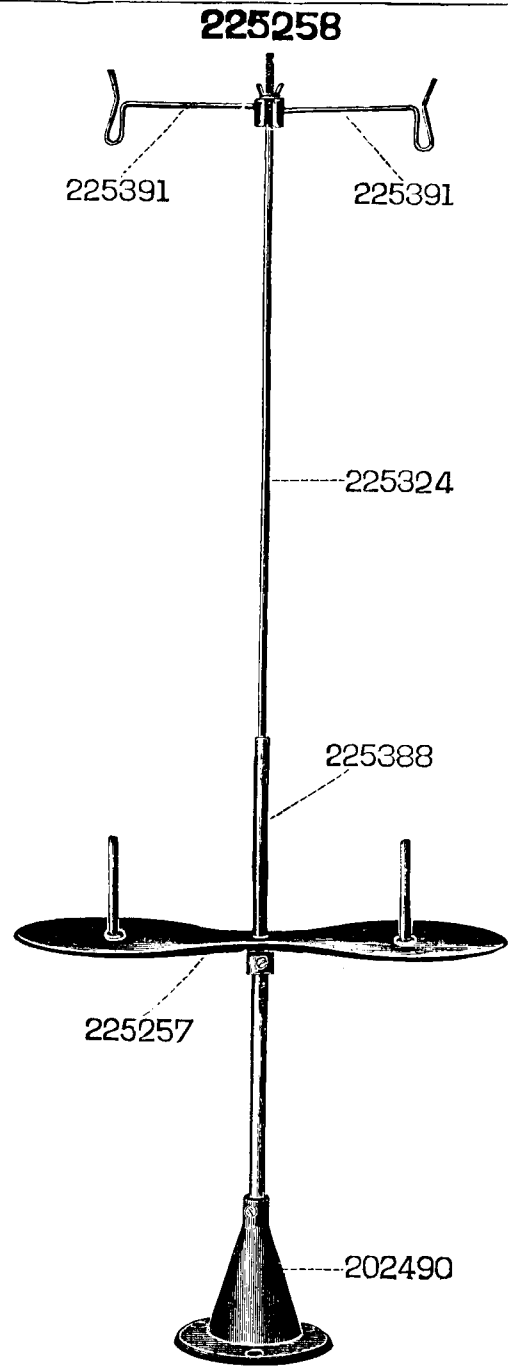

27306



41343



9331



41346

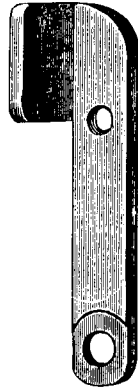

41344

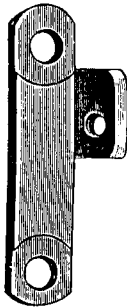

41345

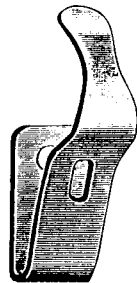

1429



207



1430



152

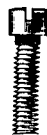

200



1550



2106



418



2455



10141



1562



127047



97502

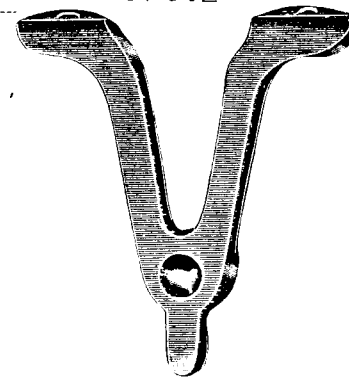

52047

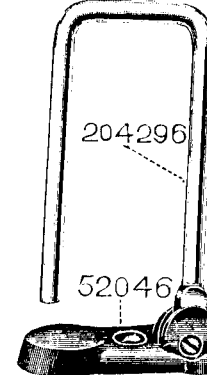

204296

52046

86546

86539

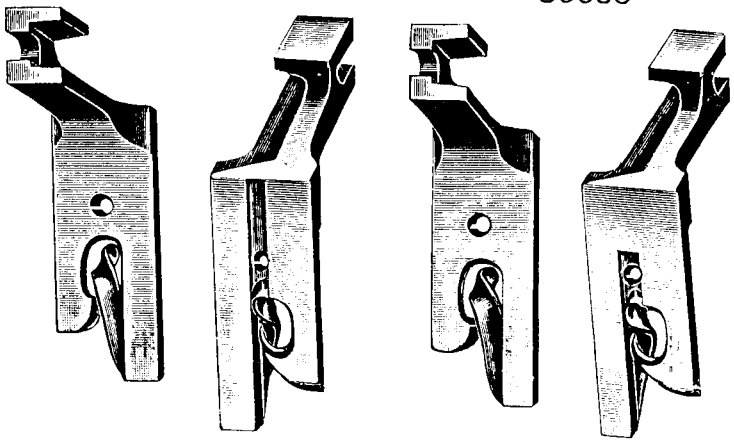

41587

60845

41585

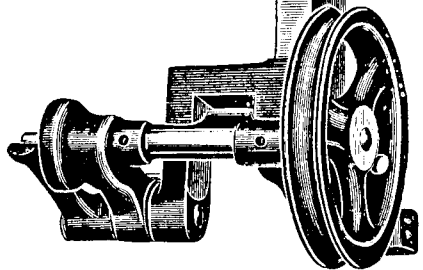
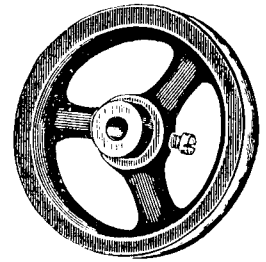
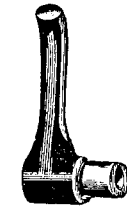

41588



41913

41586

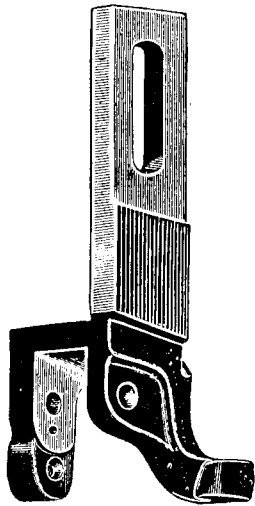

41583

41914



34105



42614



52052

52452

127058

12391

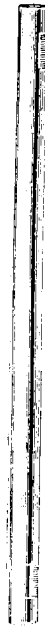
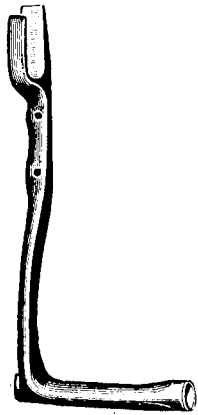
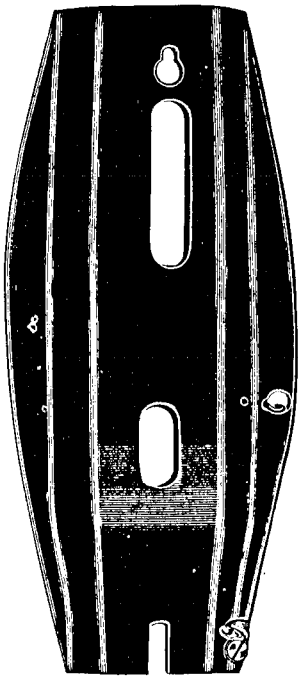

127079

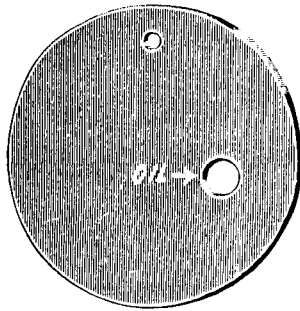

12432

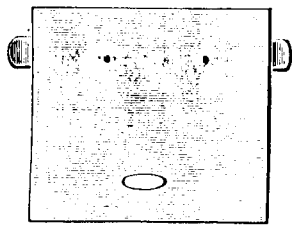

4307

5596

5599

5598

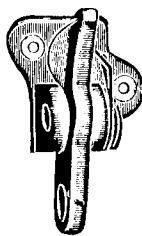
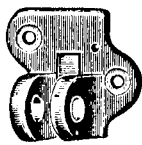
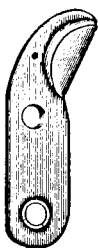

20284

52407

52384

52386

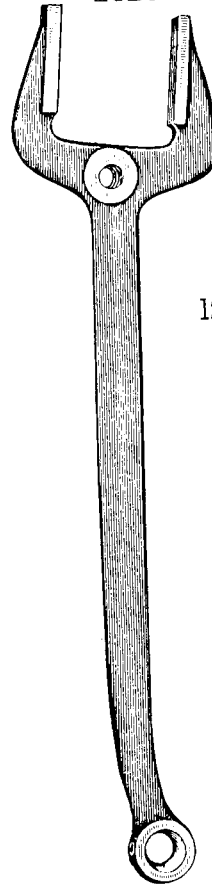

127108



52028



52063

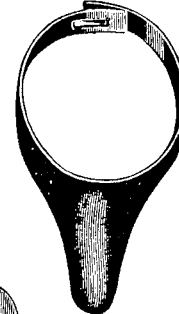

127070

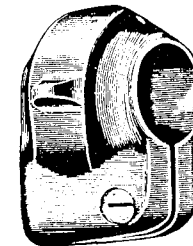

127007

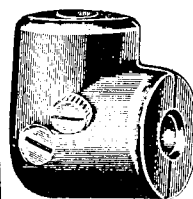

14 3/6"



14"



56017

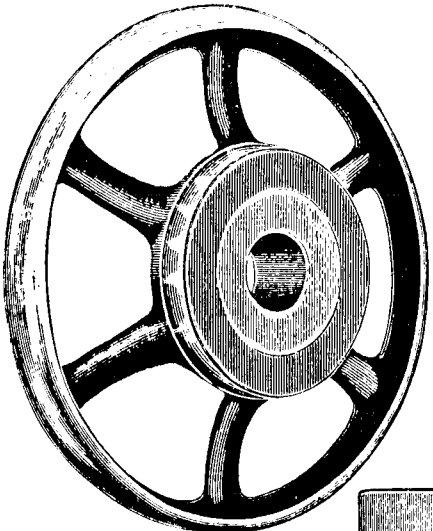

12142

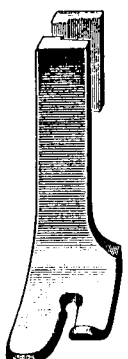

12260



52418

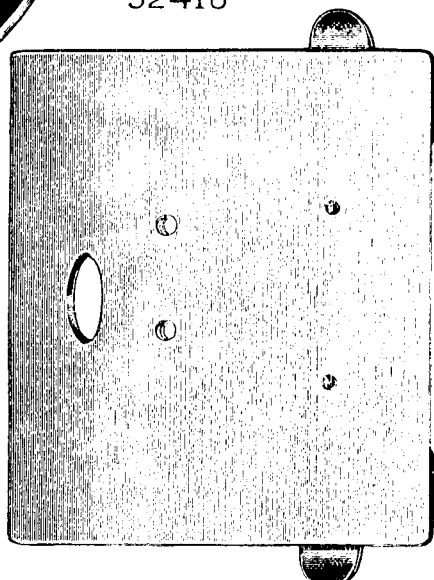

19336

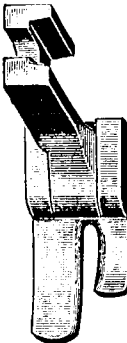

12474

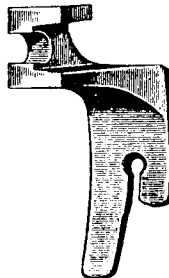

20458



20158

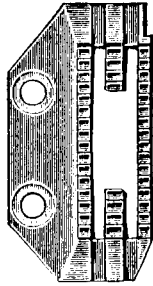

52454

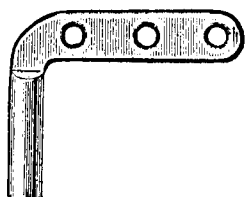

52053



36569

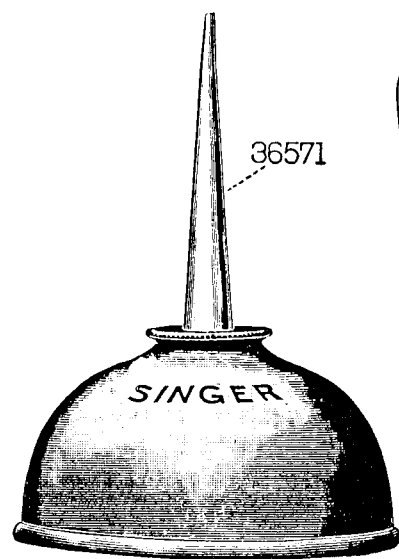

36571

SINGER

25866

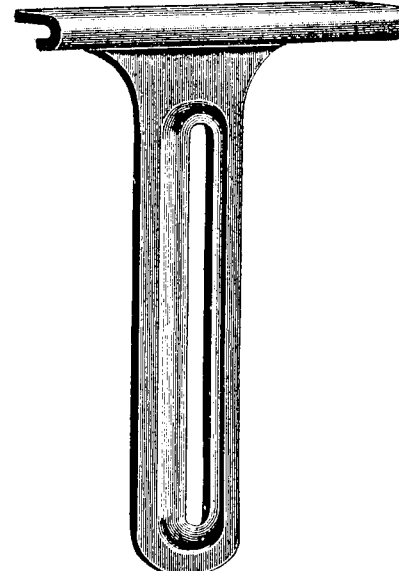

25537

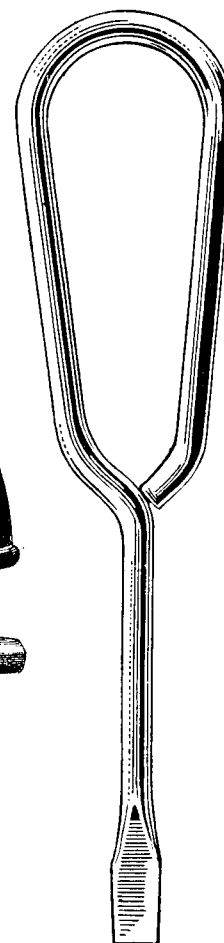

120378



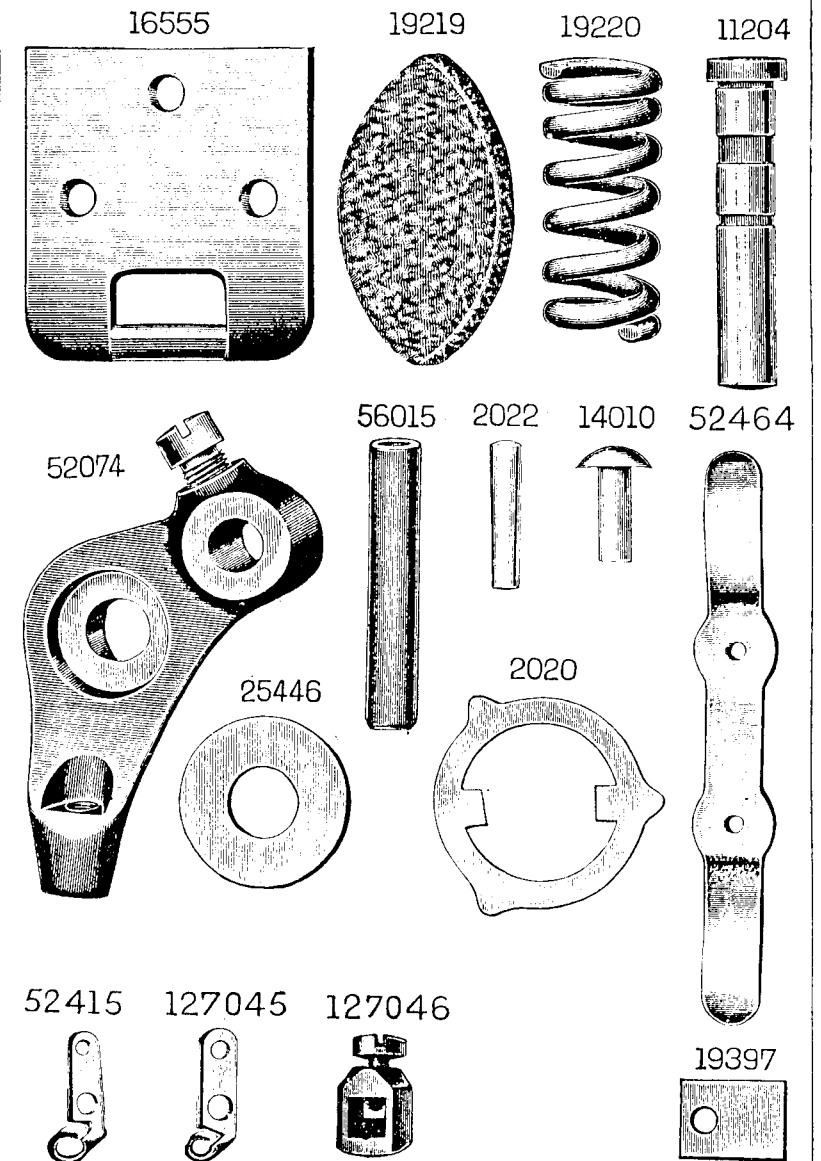
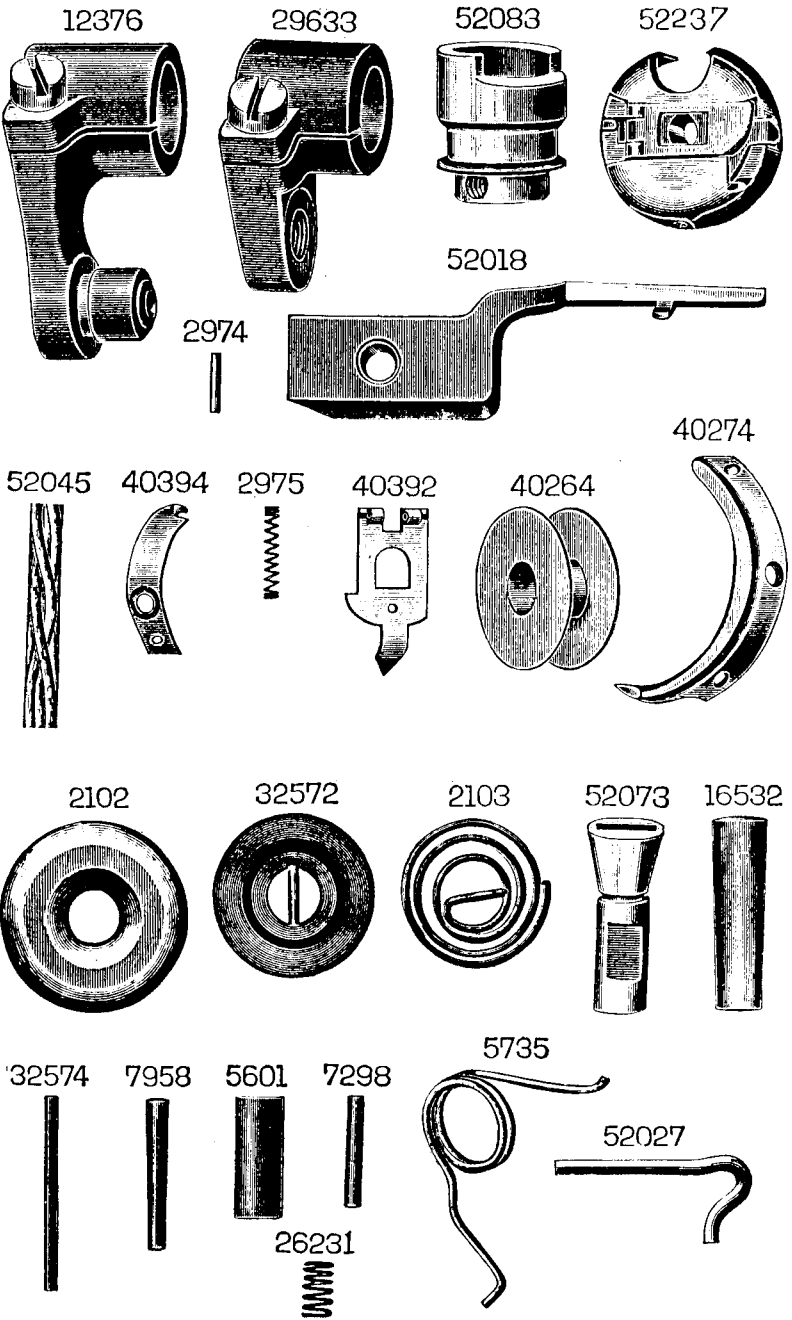

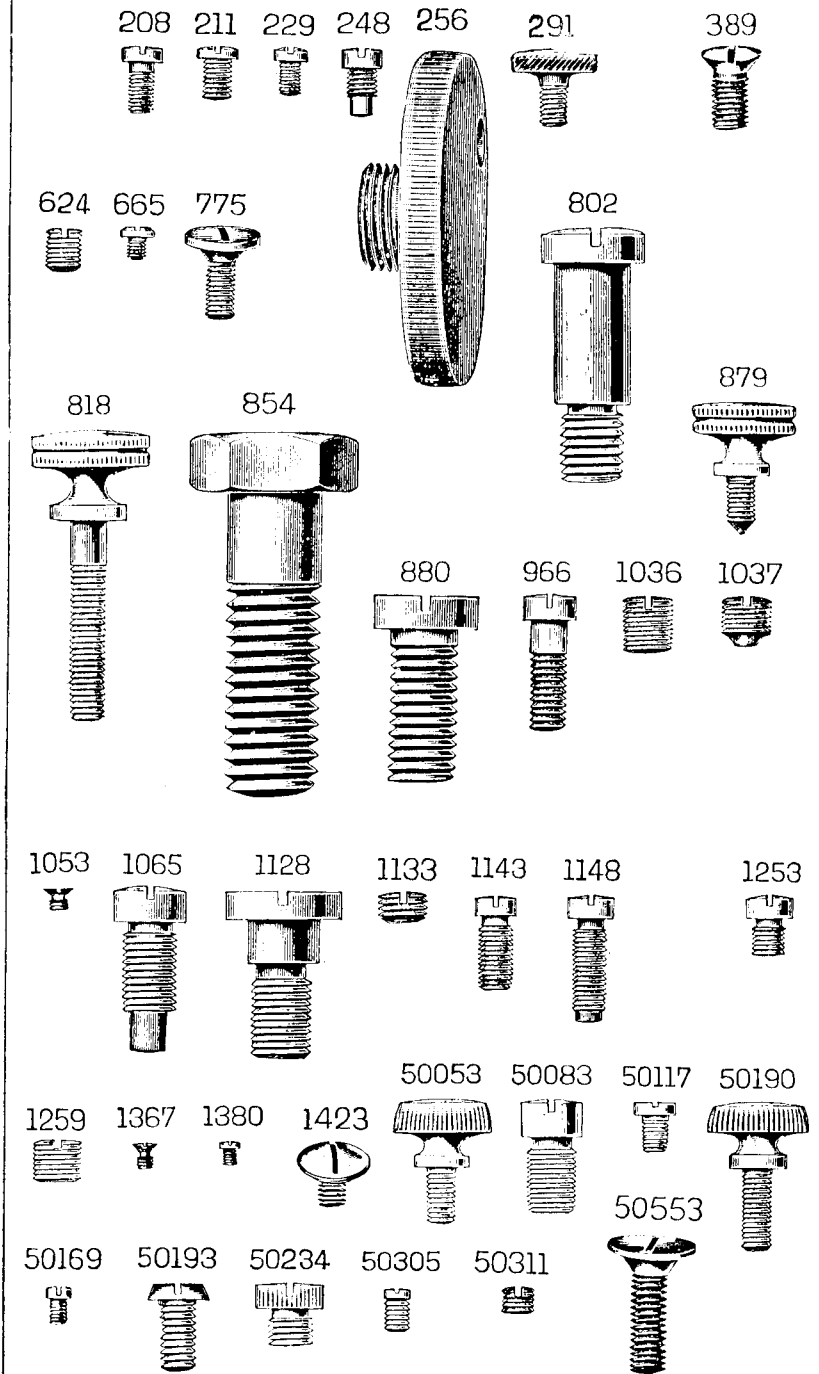
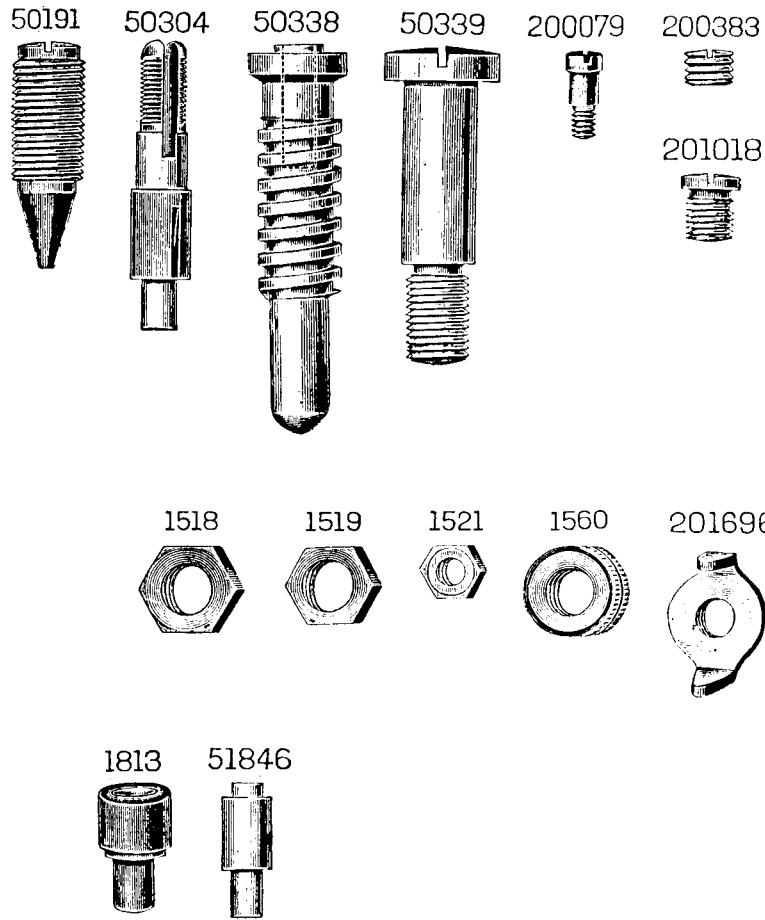

19409

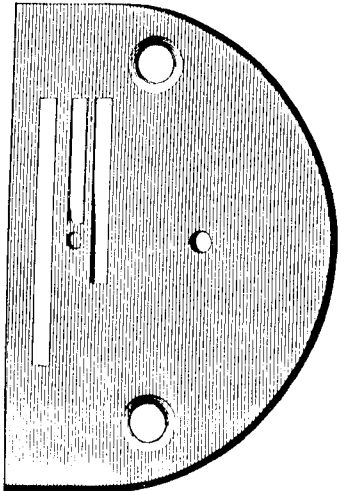

12411

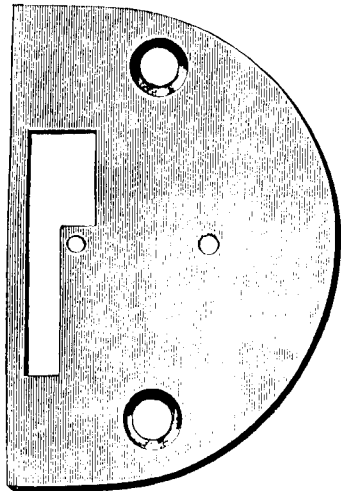

19410

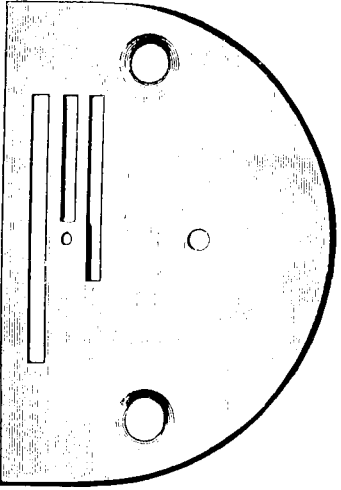

12483

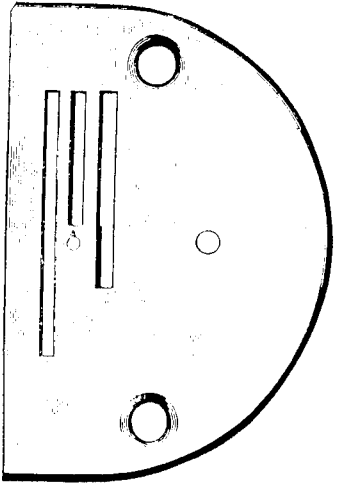

12457

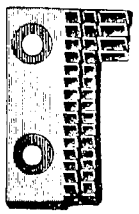

12481

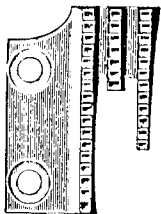

12450

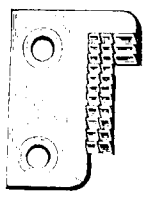

20162

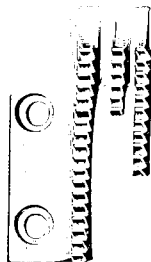

52493



127004



127005



52492



127073

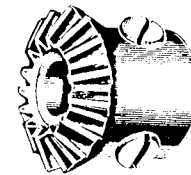

127074

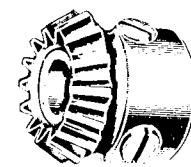

127072

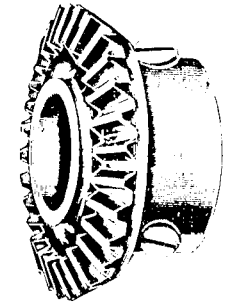

68350



127095

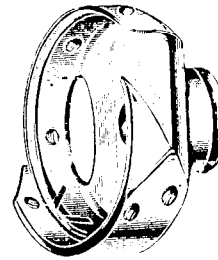

127102

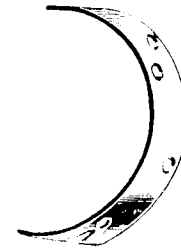

52150



52014

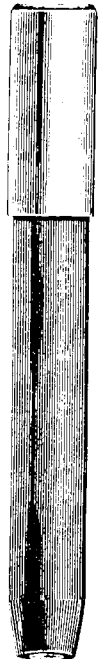

52023



52307



52394

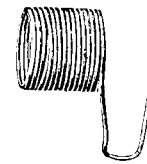

12361

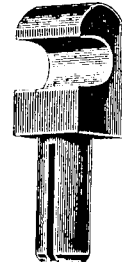

19226



52024

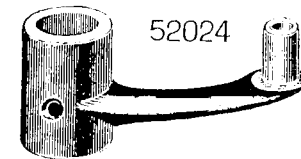

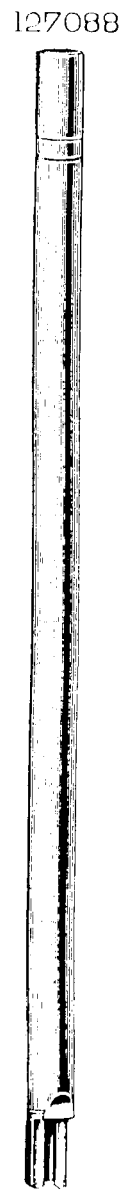
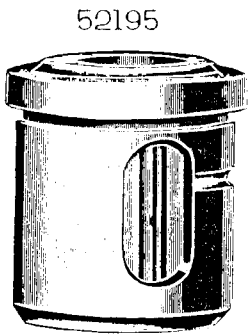
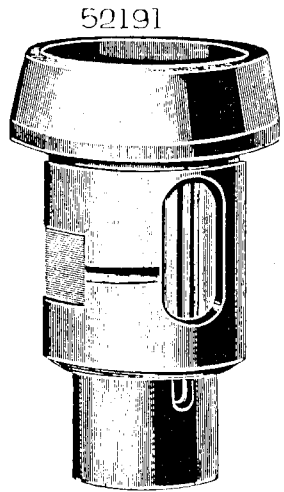

1299



127091

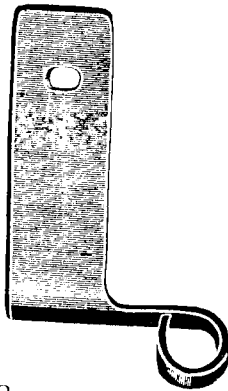

52193

52203

127187

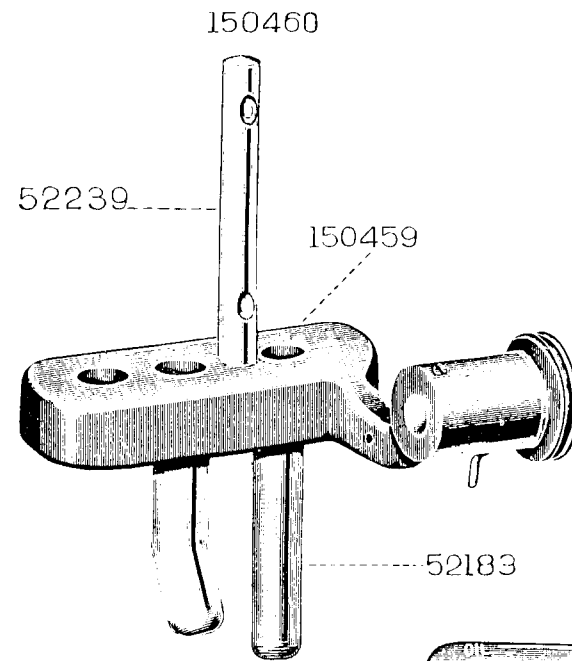
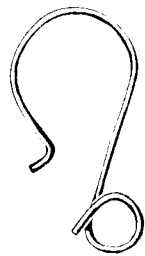

127193

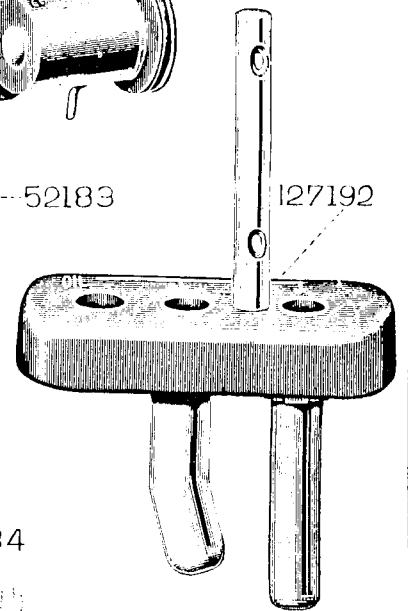

52202

52201

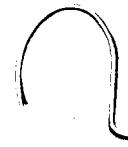

52184



52194

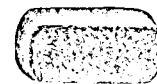

42367

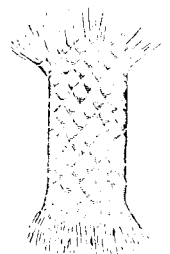

127059

127156

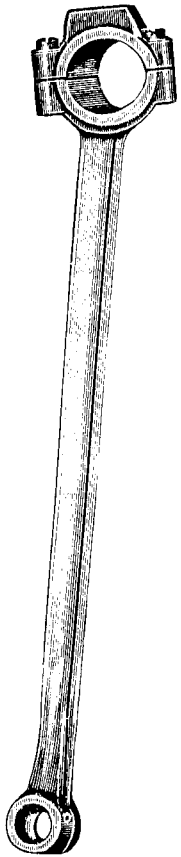

52187

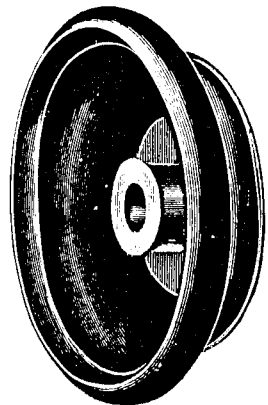

127146

127152

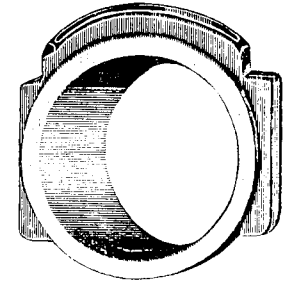
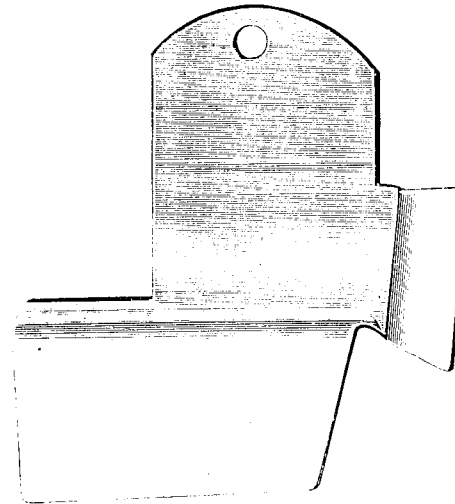

52205

52165

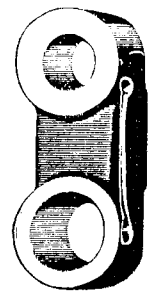
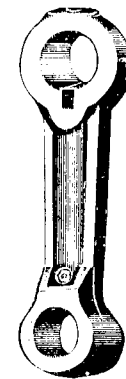

52185



52180

52182



24041

125320



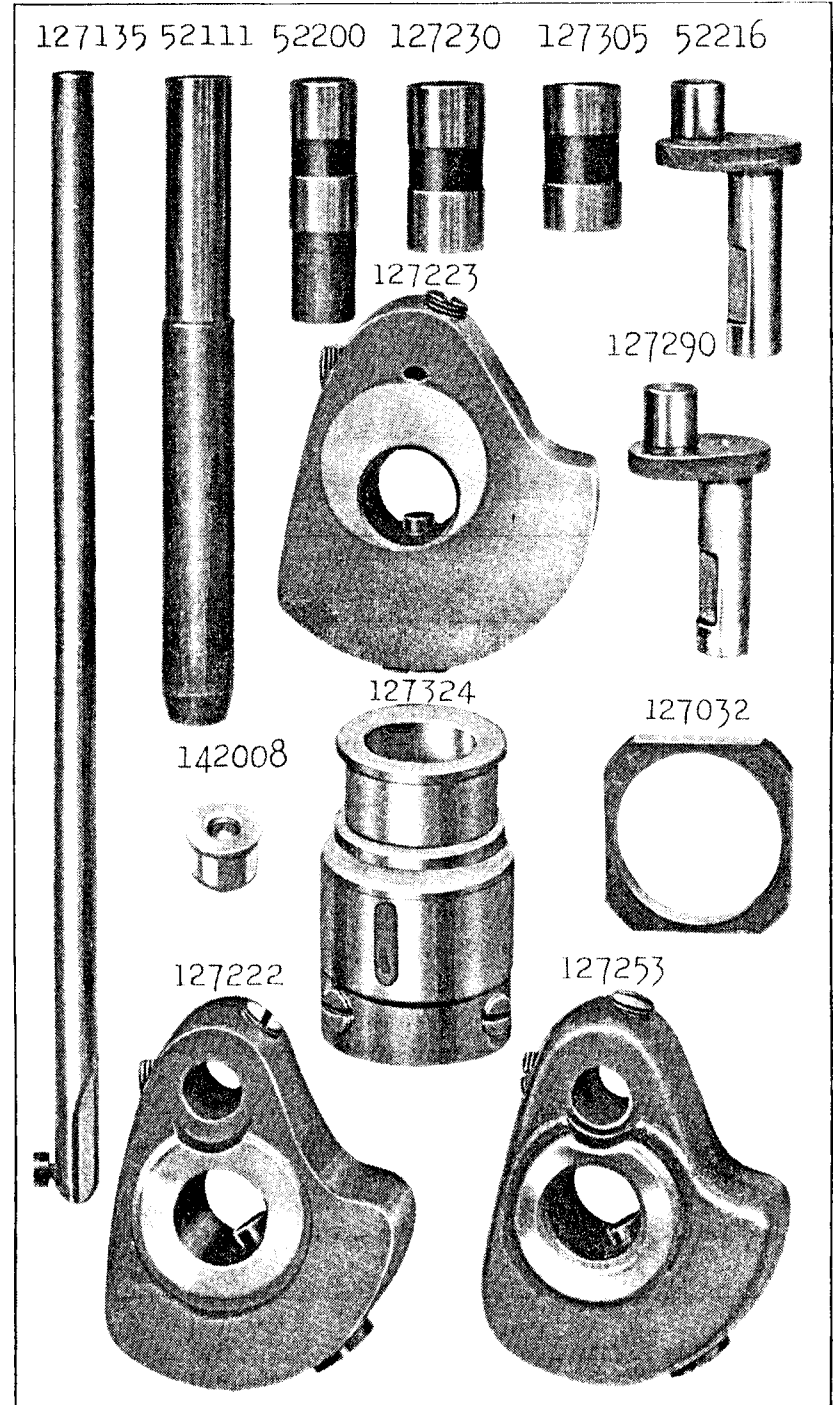
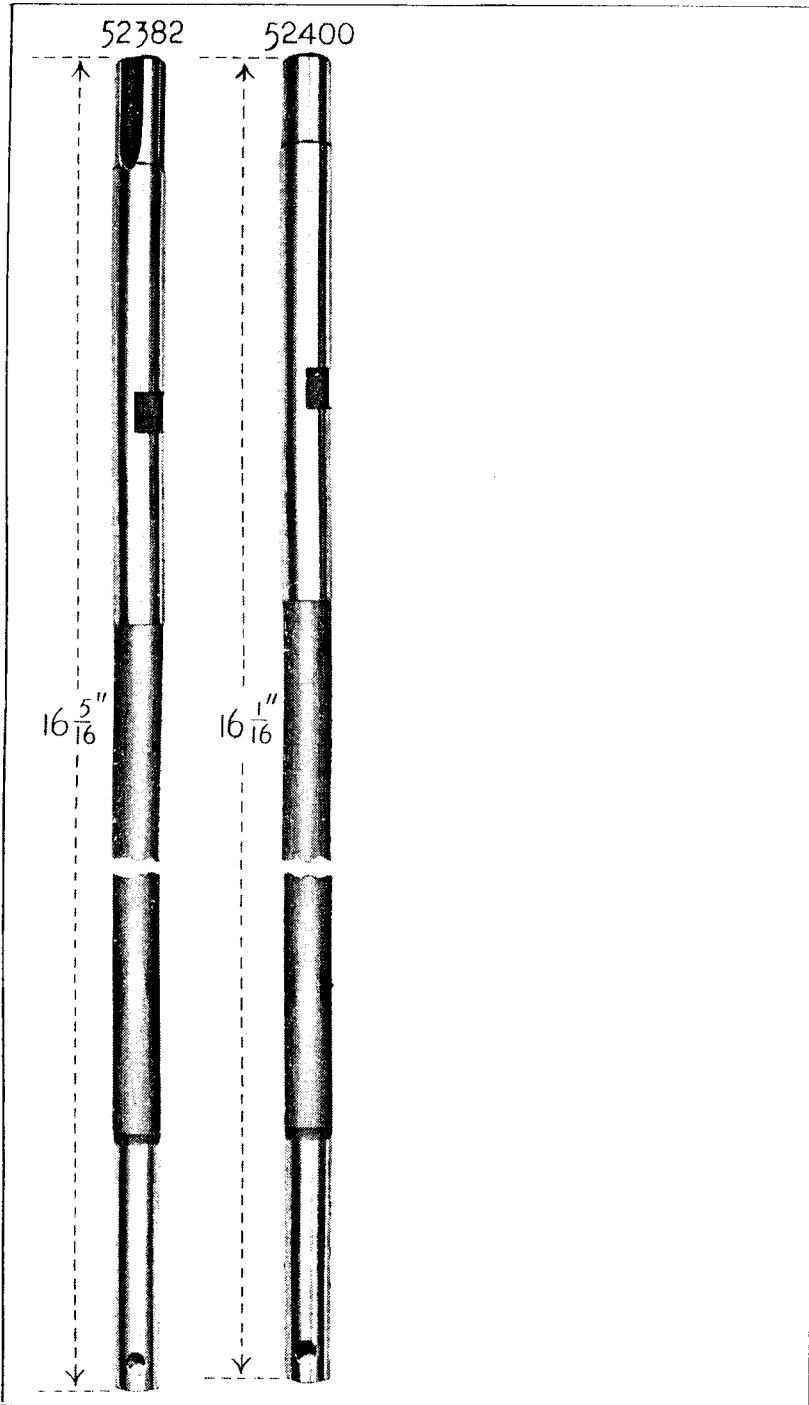

127024

52104

52102

16 3/8"

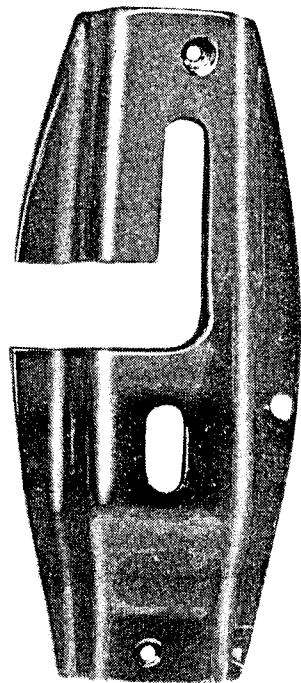
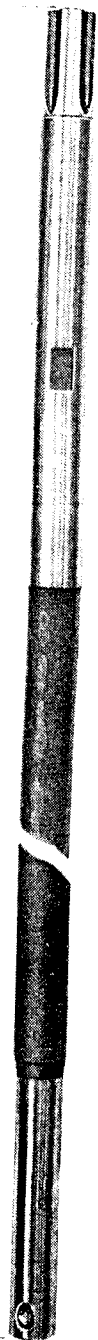

127272

62863

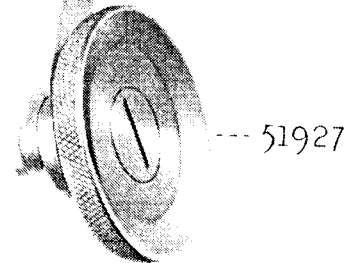
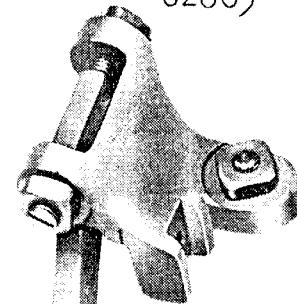
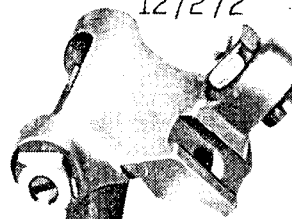

51927

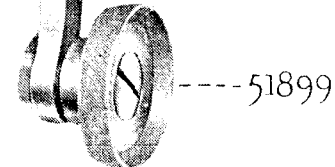

51899

80297



127271

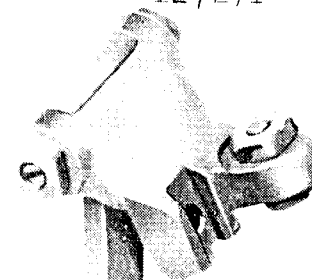

62867

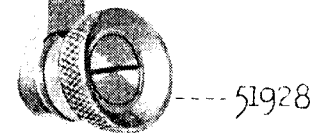
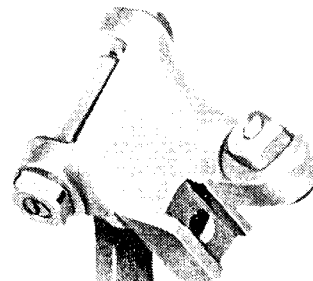

51928

51903



142032



52131

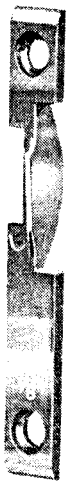

127040

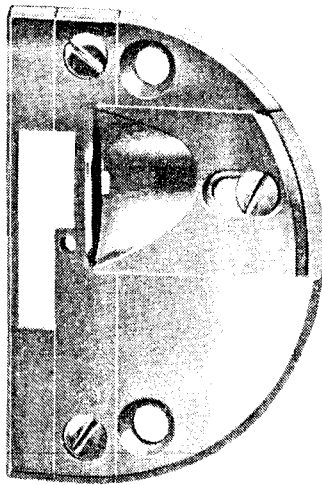

127034

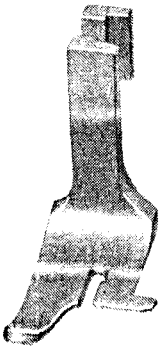

127033

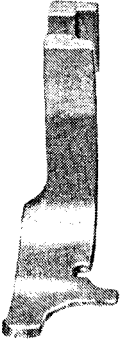

127036

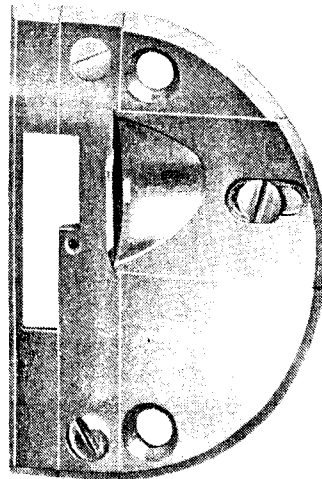

121446



127025

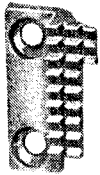

127035

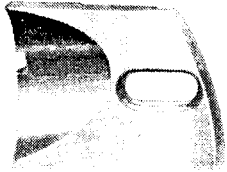

578



127028

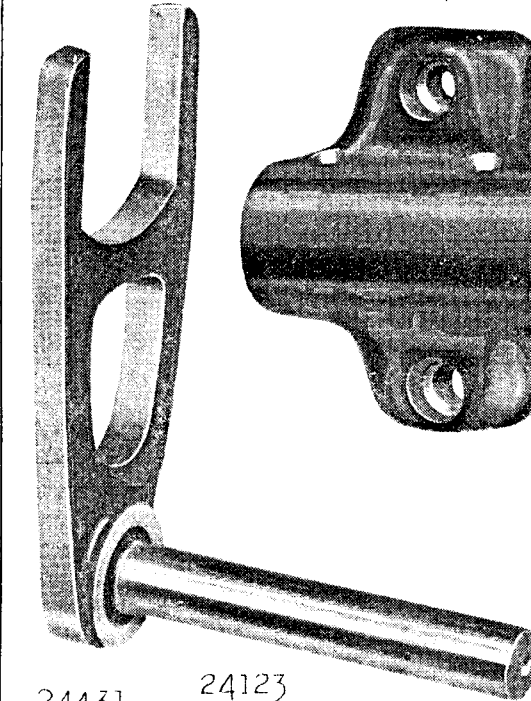

16564

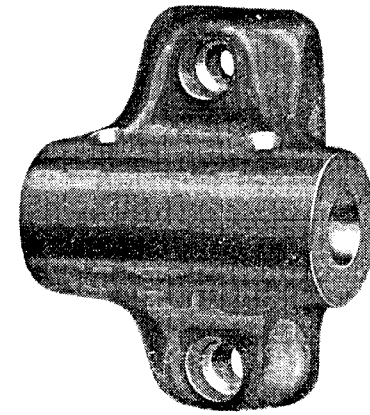

24122



24431

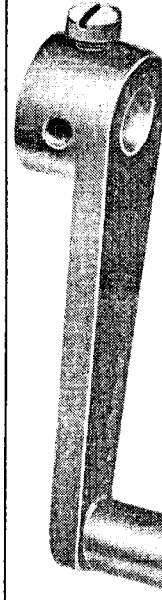

24123

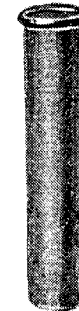

52108

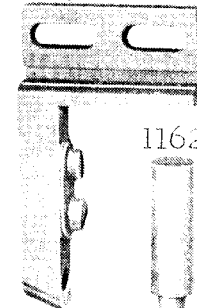

24109 127026



647

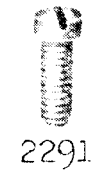

127027



1162

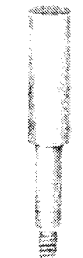

2291



24906



1564 2301 2523 621 620 2297



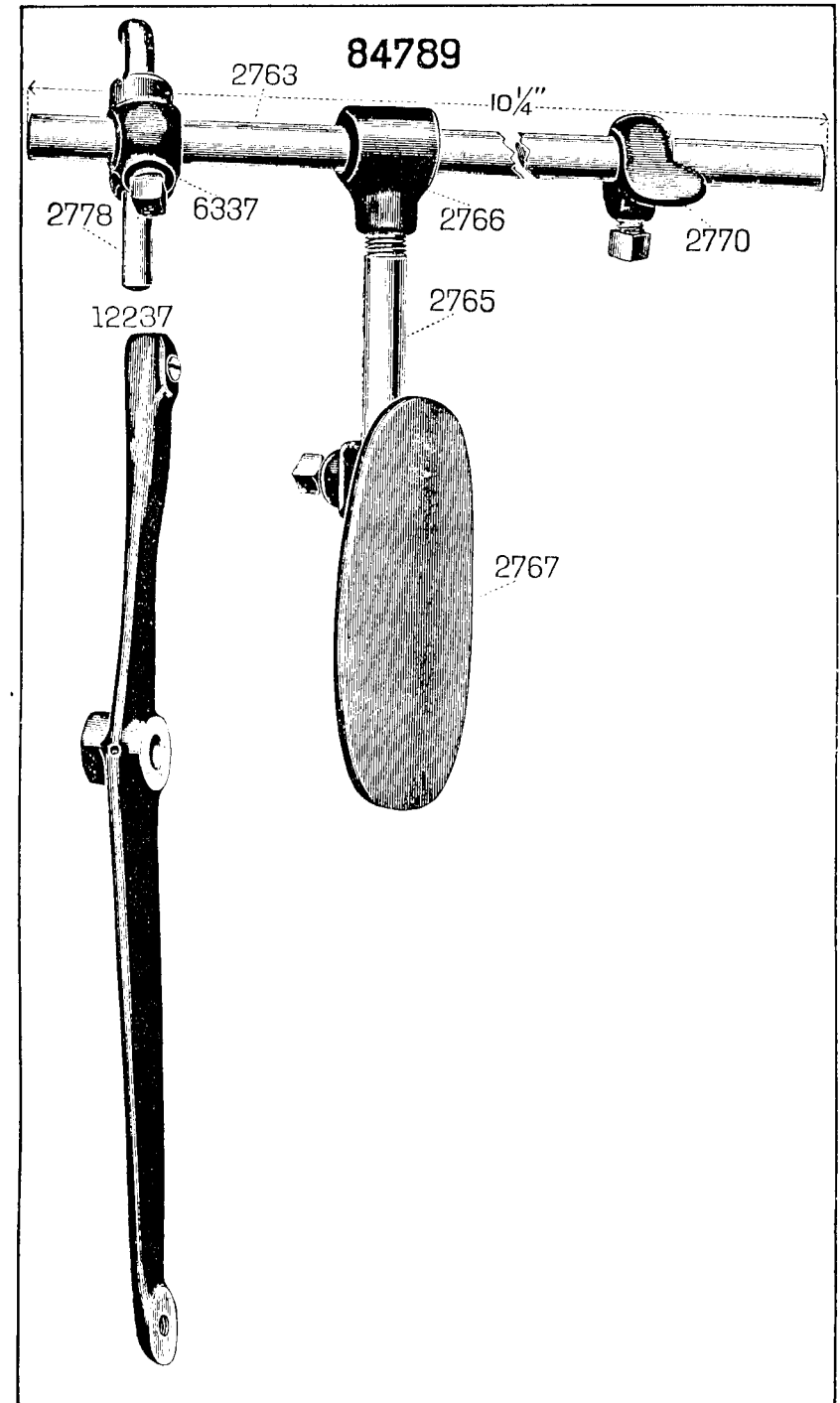
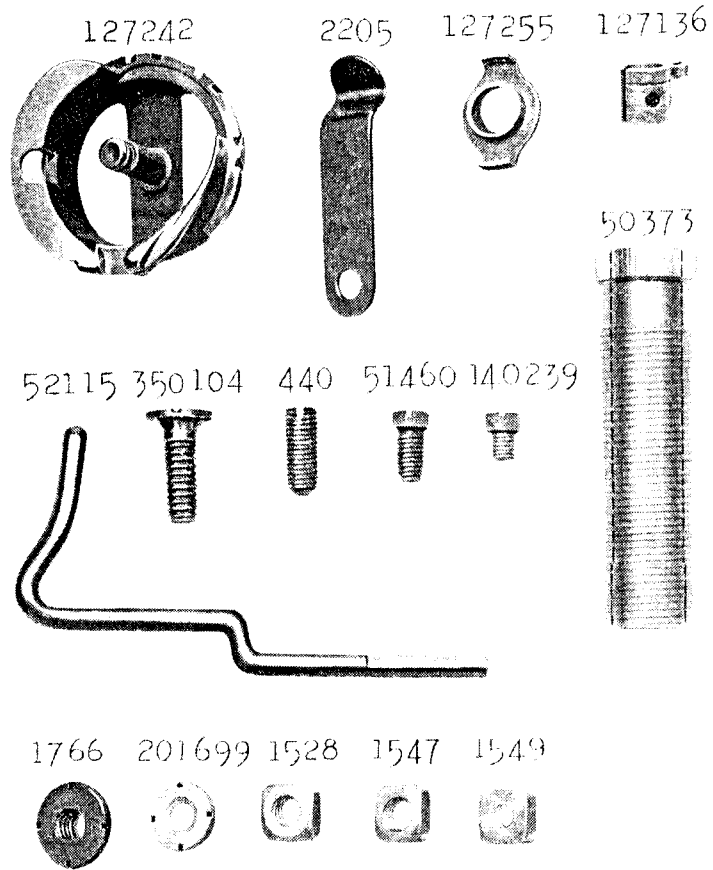

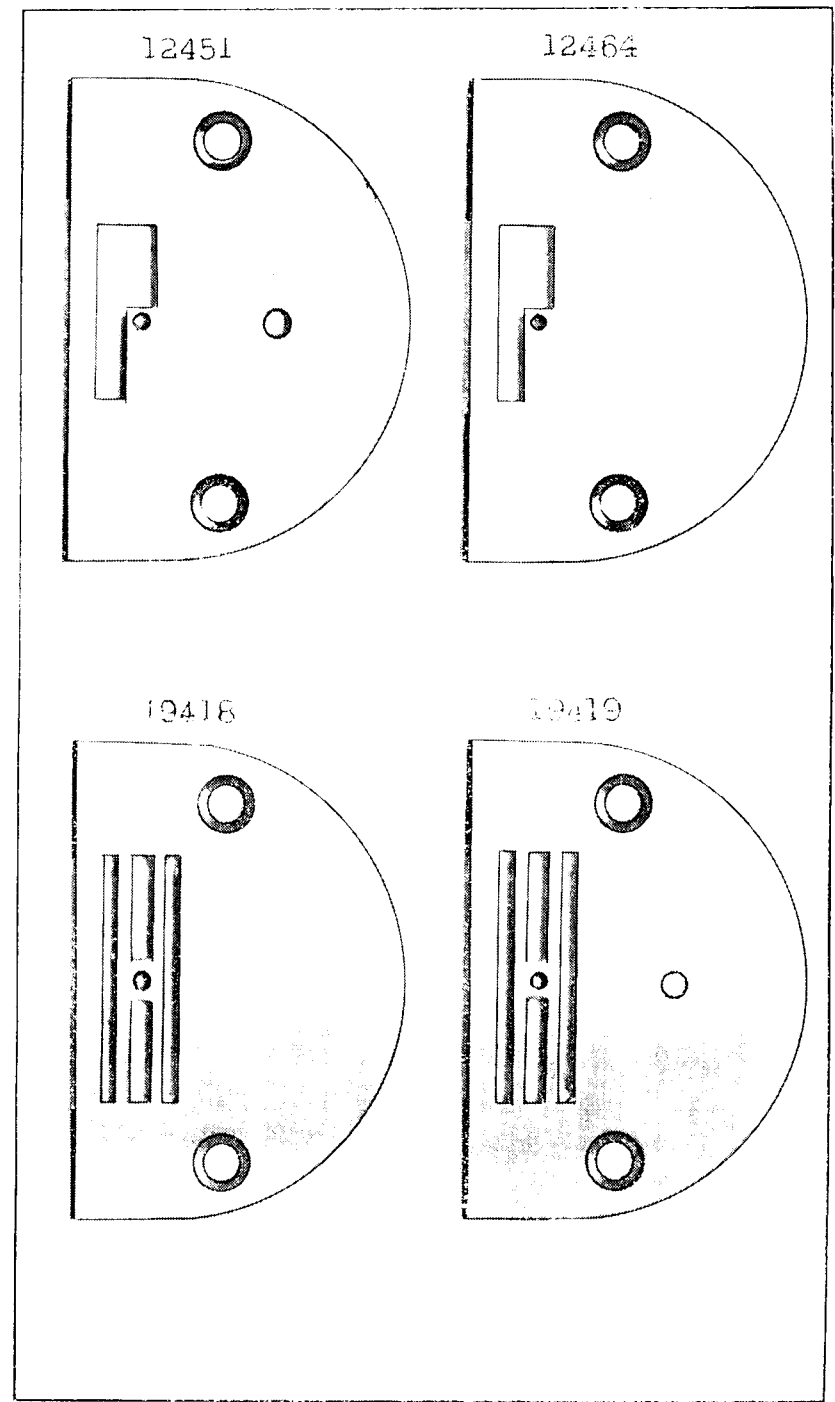
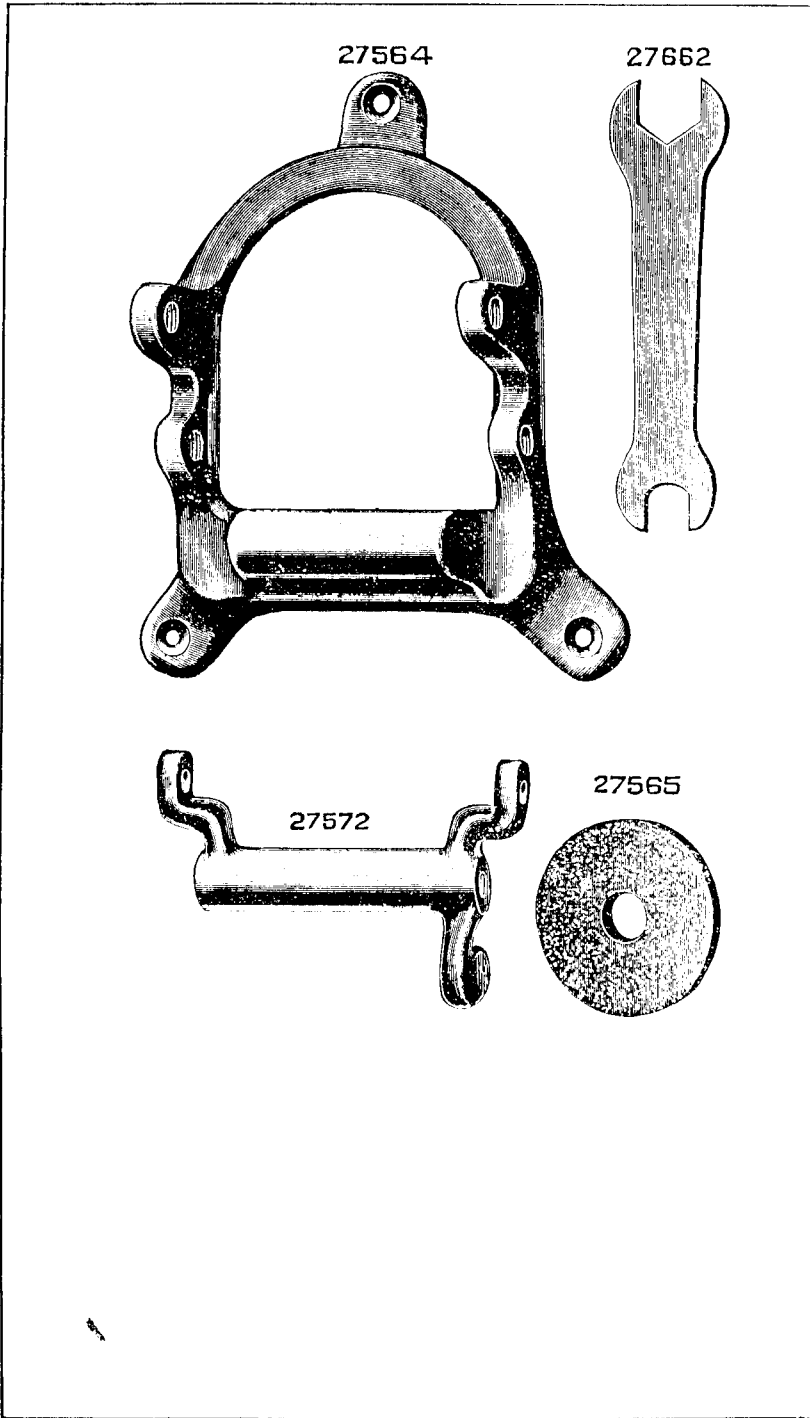

88621



106058



88622

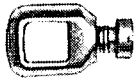

SS648



52171



142069

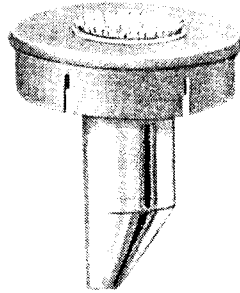

86193

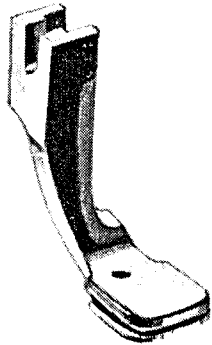

20340



12415



139623



16586



62920



PLATE 7699—FULL SIZE

24443

12436

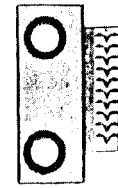

12435

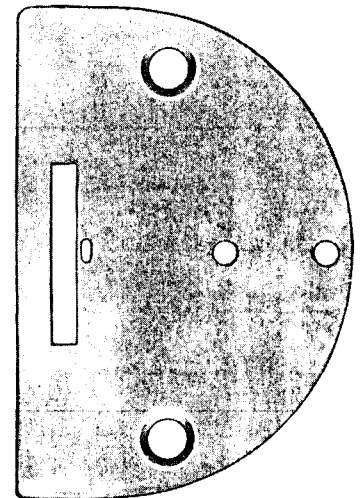
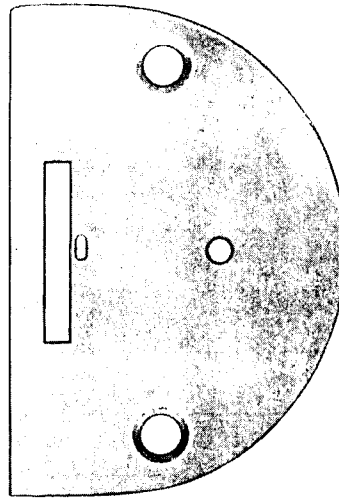

PLATE 7703—FULL SIZE

120063

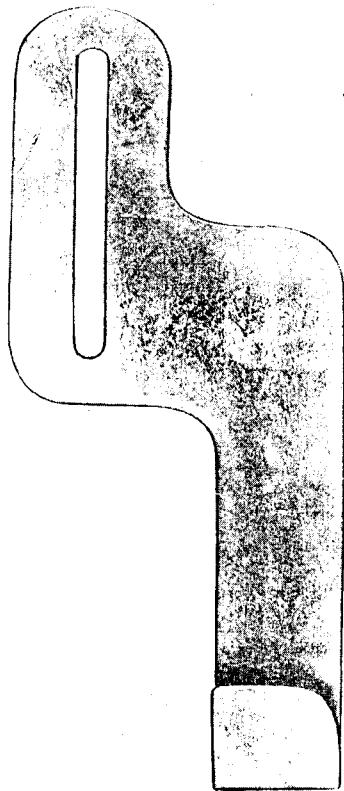
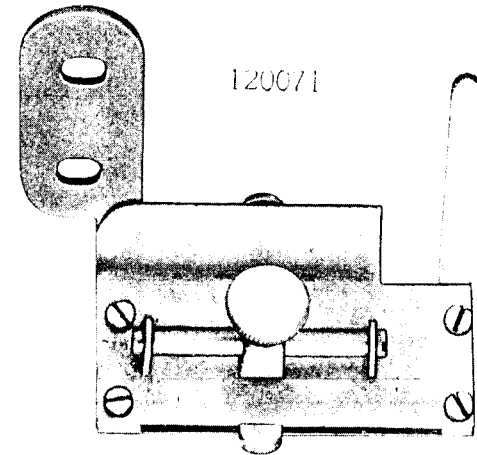

PLATE 7704—FULL SIZE



120071

120067

120068

120069

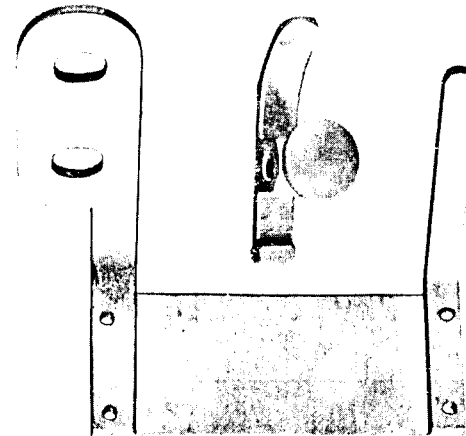

120070

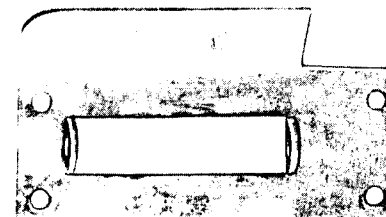

1423



50169



PLATE 7708—ONE-HALF SIZE

26063

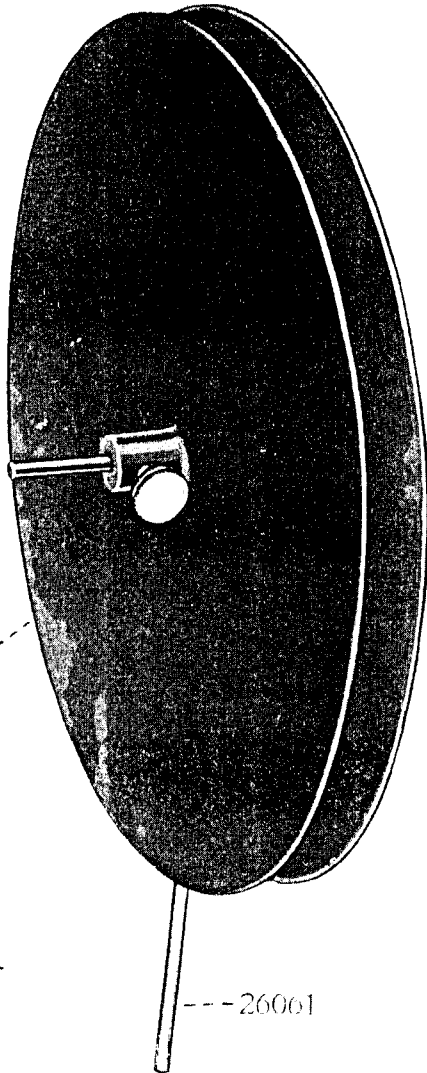

26062

26061

225461

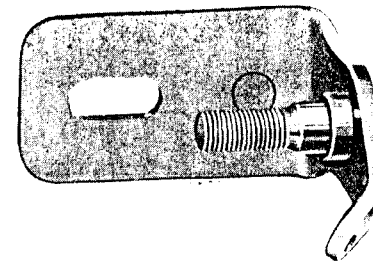

225462

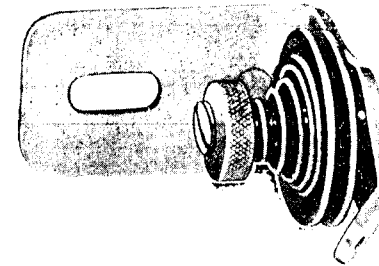

200082



202104



2102

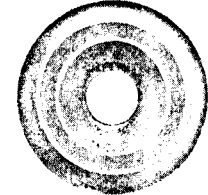

202407



201499



201572



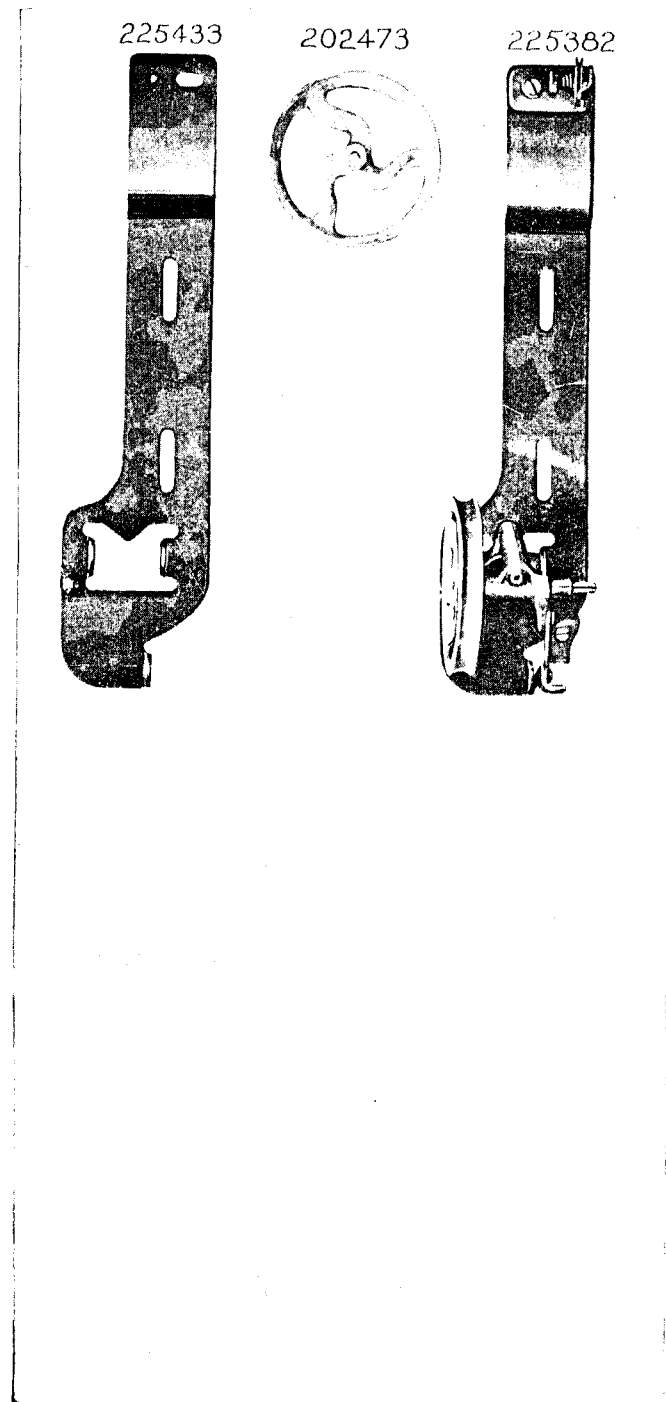
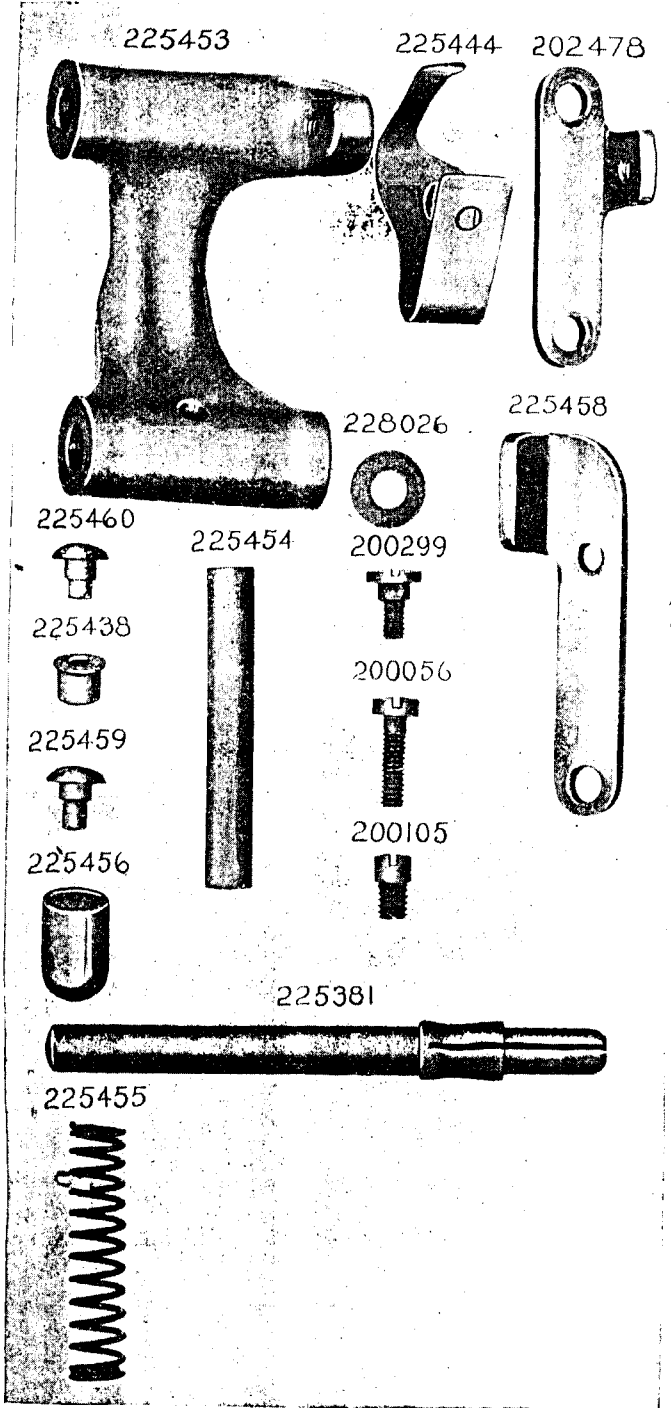

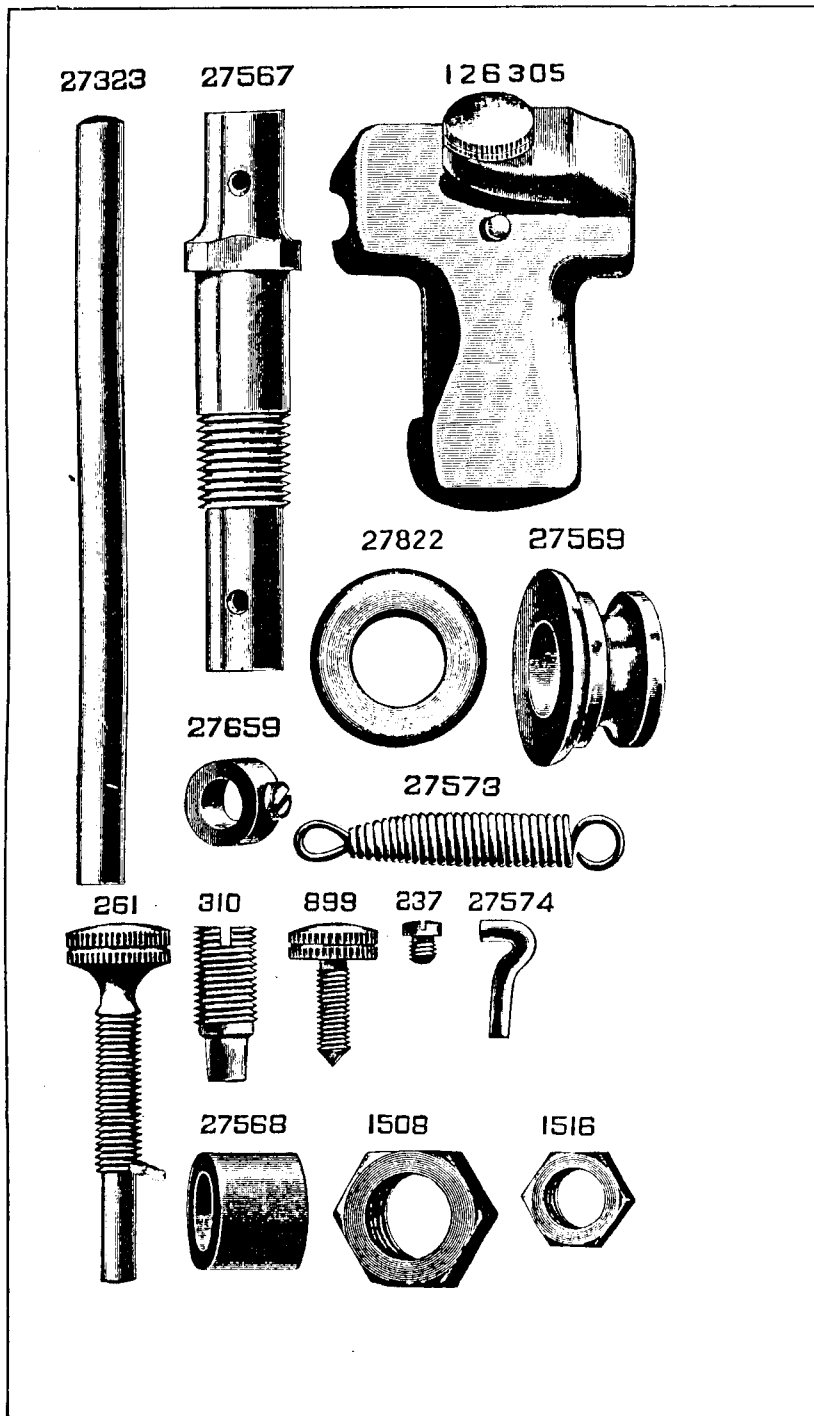

ILLUSTRATED
LIST OF PARTS

FOR

Nos. 96K40 to 96K45,
96K49 and 96K51 MACHINES

CONTENTS

	Page
Parts, complete, for 96K40 Machine (obsolete)	73
" " " 96K41 " (")	81
" " " 96K42 "	89
" " " 96K43 "	97
" " " 96K44 "	105
" " " 96K45 "	113
" Special to 96K49 Machine	88
" " " 96K51 "	80
Accessories	125
Attachments	129
Bobbin Winders	126
Iron Base	125
Knee Lifter	137
Knife Grinder	139
Numerical List of Parts	141
Tape Holder	125
Thread Unwinder	140

INSTRUCTIONS FOR ORDERING

In ordering from this List, the prefix and affix letters with the part number **MUST BE** quoted exactly as they are shown in the first column.

A number always indicates the same part in whatever List it may appear, or for whatever machine.

The affix letters (where shown) indicate the style of finish, as follows:—

- A. Hardened, Polished, Nickel Plated and Buffed.
- A.A. Buffed and Chromium Plated.
- A.B. Hardened, Polished, Buffed and Chromium Plated.
- A.C. Brown Baking Enamel Finish.
- A.D. Grey Baking Enamel Finish.
- A.E. Hardened, Bright Rumbled and Nickel Plated.
- A.F. Hardened, Bright Rumbled and Nickel Plated, Bright Rumbled and Chromium Plated.
- A.J. Polished, Nickel Plated and Chromium Plated.
- A.K. Hardened, Polished, Nickel Plated and Chromium Plated.
- A.L. Heat Treated for Toughness.
 - B. Polished, Nickel Plated and Buffed.
 - C. Hardened only.
- C.R. Hardened and Merlized.
 - D. Polished only.
 - E. Soft, not Polished.
 - F. Hardened and Polished.
- F.J. Hardened, Polished and Nickel Plated.
- G. Bright Rumbled and Nickel Plated.
- H. Blued.
- J. Nickel Plated only.
- K. Hardened and Nickel Plated.
- L. Brass Plated.
- M. Oxidized.
- N. Japanned, Dull.
- P. Japanned, Bright.
- P.P. Wrinkle Finish.
- R. Merlized.
- S. Cadmium Plated.
- T. Copper Plated.
- T.A. Hardened, Polished, Copper and Nickel Plated and Buffed.
- T.B. Copper and Nickel Plated and Polished.
- T.J. Copper and Nickel Plated only.
- T.K. Hardened, Copper and Nickel Plated.
- T.L. Copper and Brass Plated.
- T.M. Copper Plated and Oxidized.
 - U. Zinc Plated.
 - V. Silver Plated.
- W. Polished and Nickel Plated.
- X. Black Oxide for Iron and Steel.
- X.C. Hardened and Black Oxide for Iron and Steel.
- Y. Black Nickel Plated only.
- Z. Chromium Plated.
 - Z.A. Hardened, Polished, Nickel Plated, Buffed and Chromium Plated.
 - Z.B. Polished, Nickel Plated, Buffed and Chromium Plated.
 - Z.C. Hardened and Chromium Plated.
 - Z.D. Polished and Chromium Plated.
 - Z.G. Bright Rumbled, Nickel Plated, Bright Rumbled and Chromium Plated.
- Z.J. Nickel and Chromium Plated.
- Z.T. Copper and Chromium Plated.

Parts marked with an asterisk (*) are furnished only when the repairs are made at Factory.

PARTS COMPLETE

FOR

No. 96K40 MACHINE (obsolete)

For Cloaks, Clothing and other work in Cloth. Maximum Stitch 5 to the inch Drop Feed. Knee Lifter.

No.	Plate				
*127328	—	Arm with two 50015
<i>NOTE:— Due to the accuracy required for gear alignment, Arm cannot be supplied separately and can only be sent out as a unit, Arm and Bed assembled.</i>					
16532	2032	Arm Dowel Pin (2)
52182	2066	" Oil Tube with 52184, for oiling 52205
52183	2064	" " " " 52184, " " 52024
52180	2066	" " " (long) with 52184, for oiling 52022
52185	2066	" " " (short) " 42367, " " 52022
142087	—	" " " with Hole Cover and Holder
142069	2545	" " " 142087 with 52150, for oiling 127072 and 127074
50015	2033	" " " for oiling 127058 (2)
52150	2039	" " " Packing (braided cotton) for 142069
42367	2064	" " " " (" ") " 52185
52184	2064	" " " " (cotton wick) for 52180, 52182, 52183, and 127191
116e	1324	" Screw (back) (2)
854e	2035	" " (front) (2)
127047	1815	Arm Shaft (horizontal)
88615	—	" " (") 127047 with 127253
127072	2039	" " (") Bevel Gear with two 1036c
127070	2029	" " (") " " Case (two pieces) with 121e
121e	1324	" " (") " " " Screw
1036c	2035	" " (") " " Set Screw
52191	2040	" " (") Flanged Bushing (back)
52192	—	" " (") " " (") 52191 with 52193 and 52194
52193	2040	" " (") " " (") Oil Pad (braided cotton)
52194	2064	" " (") " " (") Oil Pad (felt)
446c	1324	" " (") " " (") Set Screw
52195	2040	" " (") " " (front)
52196	—	" " (") " " (") 52195 with 52193 and 52194

No.	Plate	
52194	2064	Arm Shaft (horizontal) Flanged Bushing (front) Oil Pad (felt)
52193	2040	" " (") " " (") " "
		(braided cotton)
435c	1324	" " (") " " (") Set Screw ...
68350	2039	" " (") Front Bezing Oil Cup (spring lid) ...
144d	1324	" " (") Screw ...
127058	2028	" " (upright) ...
127073	2039	" " (") Bevel Gear (lower) with two 1259c ...
1259c	2035	" " (") " " (") Set Screw ...
127074	2039	" " (") " " (upper) with two 1259c ...
1259c	2035	" " (") " " (") Set Screw ...
52492	2039	" " (") Bushing (lower) ...
432c	1324	" " (") " (") Set Screw ...
52493	2039	" " (") " (upper) ...
435c	1324	" " (") " (") Set Screw ...
127146	2066	" Side Cap ...
219d	1324	" " " Screw ...
127079	2028	" " Cover ...
50053d	2035	" " " Thumb Screw ...
52239	2064	" Spool Pin and Thread Eyelet ...
8879	1316	" " " Washer (cloth) ...
127192	2064	Arm Top Cover ...
127193	2064	" " " 127192 with 52183, 52239, 127187 and 127255 ...
52183	2064	" " " Oil Tube with 52184 ...
52184	2064	" " " " " Packing (cotton wick) ...
127187	2040	" " " " " (bent) with 42367 ...
42367	2064	" " " " " Packing (braided cotton) ...
127255	2378	" " " Positioning Disc ...
158j	1324	" " " Screw ...
150459	2064	" " " Tension Bracket with 460c ...
52183	2064	" " " " " Oil Tube with 52184 ...
52184	2064	" " " " " " " Packing (cotton wick) ...
127187	2040	" " " " " (bent) with 42367 ...
42367	2046	" " " " " Packing (braided cotton) ...
158j	1324	" " " " " Screw ...
52239	2064	" " " " " Spool Pin ...
8879	1316	" " " " " Washer (cloth) ...
2455	1688	" " " " " Disc ...
41593	1316	" " " " " Spring ...
41594	1316	" " " " " Stud ...
460c	1324	" " " " " Set Screw ...
41595	1316	" " " " " Thread Guide ...

No.	Plate	
150460	2064	Arm Top Cover Tension Bracket , complete, Nos. 41593 to 41595, 52183, 52239, 127187, 127255, 150459 and two 2455
		<i>NOTE.</i> —No. 150460 is supplied with this machine unless No. 427493 is specified on order. 150460
142033		
52487	2065	Balance Wheel (power, disc), 2 $\frac{3}{16}$ " pulley, with two 448c ...
52081		" " (stand, heavy rim) 2 $\frac{1}{16}$ " pulley, with two 448c ...
52063	2029	" " Oil Cover ...
2100	1324	" " " " Screw ...
448c	1324	" " " Set Screw ...
		<i>NOTE.</i> —No. 52487 is supplied with this machine unless otherwise specified on order.
*52383		Bed ...
		<i>NOTE.</i> —Due to the accuracy required for gear alignment, Bed cannot be supplied separately and can only be sent out as a unit, Arm and Bed assembled.
12431		Bed Slide ...
12432	2028	" " complete, Nos. 4307, 12431 and two 725c ...
4307	2028	" " Spring ...
725e	1324	" " " Screw ...
52051		Face Plate ...
176d	559	" " Screw ...
52053	2030	" " Thread Guard (lower) ...
226d	1324	" " " " (") Screw ...
52170		" " " " (upper) ...
226d	1324	" " " " (") Screw ...
50190d	2035	" " Thumb Screw ...
52052	2028	Face Plate , complete, Nos. 52051, 52053, 52170 and two 226d ...
52452	2028	Feed Bar ...
313c	1324	" " Screw Centre (2) ...
1519c	2034	" " " " Nut (2) ...
52165	2066	" Connecting Link ...
375c	1324	" " " Hinge Screw ...
1518c	2034	" " " " Nut ...
52073	2032	" " " Stud ...
50083c	2035	" " " " Set Screw ...
44136	1510	Feed Dog for tailor work ...
12457	2036	" " " cloth, 16 teeth (16 teeth to the inch) ...
12450	2036	" " " " 11 " (18 " " " ") ...
20158	2030	" " " shirt work, 17 teeth (16 teeth to the inch) ...
20162	2036	" " " " bevelled for hemmer, 17 teeth (16 teeth to the inch) ...
12481	2036	" " " general work, 18 teeth (16 teeth to the inch) ...
50117c	2035	" " Screw (2) ...
		<i>NOTE.</i> —Feed Dog No. 44136 is sent with this machine unless otherwise specified on order.

No.	Plate	
127202	—	Feed and Feed Lifting Eccentric with 448c, 1299c, 52210 and 52211
127225	—	" " " " " 127202 with 127152
52210	1503	" " " " " Lubricating Pad (wood, long)
52211	1503	" " " " " " " (" short)
1299c	2040	" " " " " Position Screw
448c	1324	" " " " " Set Screw
127152	2066	" " " " " Sleeve
20284	2029	Feed Forked Connection
52393	—	" " " " 20284 with 375c, 1518e and 52165
375c	1324	" " " " Hinge Screw
1518e	2034	" " " " " " Nut
52384	2029	Feed Lifting Rock Shaft
127156	2065	" " " " " Connecting Rod with 127157 and two 966e
*127157	—	" " " " " " " Cap
966e	2035	" " " " " " " Screw
375c	1324	" " " " " " " Hinge Screw
1518e	2034	" " " " " " " " Nut
12376	2032	" " " " " Crank with 157c and 1813
157c	1324	" " " " " " Clamping Screw
1813	2034	" " " " " " Roller and Stud
50191c	2034	" " " " " " Screw Centre (2)
1513j	1317	" " " " " " " Nut (2)
52385	—	Feed Lifting Rock Shaft, complete, Nos. 12376 and 52384
52074	2033	Feed Regulator with 50083c
52118	—	" " " 52074 with 52073
52093	—	" " " 52118 with 818d
1128e	2035	" " " Hinge Screw
818d	2035	" " " Thumb Screw
52384	2029	Feed Rock Shaft
29633	2032	" " " " Crank with 157c
157c	1324	" " " " " Clamping Screw
50191c	2034	" " " " " Screw Centre (2)
1513j	1317	" " " " " " Nut (2)
142033	—	Machine Pulley (disc) "V" belt groove (outside diam. of belt groove 2.9"), with two 435al
52081	—	Machine Pulley (stand, heavy rim), 2 1/8" pulley, with two 448c
52063	2029	Machine Pulley Oil Cover
210d	1324	" " " " " Screw
448c	1324	" " " " " Set Screw for 52081
435al	1324	" " " " " " 142033

Note—No. 142033 is supplied with machine unless otherwise specified on order

No.	Plate	
1133c	2035	Needle Bar Bushing (lower) Set Screw
52014	2039	" " " (upper)
1133c	2035	" " " (") Set Screw
52205	2066	" " " Connecting Link with 52207
52206	—	" " " " 52205 with 24041
775c	2035	" " " " " Cap Screw
52207	—	" " " " " Lubricating Pad (wood)
24041	2066	" " " " " Stud with 207 1/2
207 1/2	1688	" " " " " Clamping Screw
127253	2373	" " " Crank with 1036al, 1037al and 1065al
1065al	2035	" " " " " Position Screw
127323	—	" " " Thread Guard
229d	2035	" " " " " Screw
52307	2039	" " " Clamp with 51460f
51460f	2378	" " " " " Screw
*52201	2064	Oil Absorbent Wick
52202	2064	" " " " 52201, with 52203, for lower cavity in head of arm
*52203	2040	" " " " " Wire
127191	—	Oil Tube, with 52184
127091	2040	" " " Bracket
127092	—	" " " " 127091, with 127191, for oiling 52165
52184	2064	" " " Packing (cotton wick)
12391	2028	Presser Bar (hollow)
52338	1316	" " " Guide Bracket with 223c and 453c
453c	1316	" " " " " Set Screw
52016	1316	" " " " " Lifter
689c	1316	" " " " " Screw
1520r	1317	" " " " " " Nut
12327	1316	" " " " " Lifting and Releasing Lever Bracket
127108	2029	" " " " " Spring
11170	1316	" " " " " Washer
7298	2032	Presser Foot Hinge Pin
19334	—	" " " " " Plate
19335	—	" " " " " Shank
19336	2030	Presser Foot (hinged), complete, Nos. 7298, 19334 and 19335 for 44136
20458	2030	" " " " " for 44136
12142	2030	" " " " " 20158
12260	2030	" " " " " 12450
12474	2030	" " " " " 20162
190d	1324	" " " " " Screw

NOTE.—Presser Foot No. 20458 is sent with this machine unless otherwise specified on order.

No.	Plate	
688j	1324	Pressure Regulating Thumb Screw
127095	2039	Rotating Hook with three 1253c
127096	"	" " 127095 with 127102 and four 1053e
127239	"	" " 127096 " 40274, 127242 and three 1367d
127097	"	" " 127096 " 40274 and three 1367d (for agents only)
127240	"	" " 127239 " 52237
40264	2032	" " Bobbin
52235	"	" " Case
52236	"	" " " " 52235 with 591f, 1380d and 40394
40393	"	" " " " Hinge, Nos. 2974, 40392 and 125320
127242	"	" " " " Holder
52018	2032	" " " " " Position Bracket
704j	1324	" " " " " " Screw
40392	2032	" " " " " Latch
125320	2066	" " Bobbin Case Latch Lever
2974	2032	" " " " " Fulcrum Pin
2975	2032	" " " " " Spring
592e	1324	" " " " " Stop Screw
591f	1324	" " " " " Tension Regulating Screw
40394	2032	" " " " " Spring
1380d	2035	" " " " " " Screw
52237	2032	" " " " " complete, Nos. 592e, 2975, 40393 and 52236
127241	"	" " " " " 52237 with 127242 (for agents only)
40274	2032	" " Section
1367d	2035	" " " Screw
1253c	2035	" " Set Screw
127059	2065	" " Shaft
127073	2039	" " " Bevel Gear with two 1259c
127007	2029	" " " " " Case (two pieces) with 121e and 50234d
50234d	2035	" " " " " Plug Screw
121e	1324	" " " " " Screw
1259c	2035	" " " " " Set Screw
127004	2039	" " Bushing (back)
127043	"	" " " (") 127004 with 52045
52045	2032	" " " (") Packing (cotton)
1143c	2035	" " " (") Set Screw
127005	2039	" " " (front)
127044	"	" " " (") 127005 with 52045
142008	2373	" " " (")
144828	—	Rotating Hook with three 1253c (ton)
144829	—	Rotating Hook 144828 with 270083 and four 1053e
144830	—	Rotating Hook 144829 with 40274, 143346 and three 1367e
144832	—	Rotating Hook 144830 with 52237
144831	—	Rotating Hook 144829 with 40274 and three 1367e (for agents only)

No.	Plate	
52337	1316	Slack Thread Regulator
223c	1316	" " " Set Screw
2102	2032	Tension Disc
1560c	2034	" Regulating Thumb Nut
32572	2032	" Releasing Disc
43944	1316	" " Lever
12398	1316	" " " Hinge Pin
12329	1316	" " " Spring
32574	2032	" " Pin
2103	2032	" Spring
*50304c	2034	" Stud
52098	—	" Stud 50304c with 1560c
50305c	2035	" " Set Screw
52397	—	Tension , complete, Nos. 2103, 32572, 32574, 52083, 52098, 52394 and two 2102
52027	2032	Thread Guard (side of arm)
52454	2030	" Retainer
624c	2035	" " Set Screw
52215	—	Thread Take-up , complete, Nos. 11204, 52025 and 52217
52216	2373	Thread Take-up Crank
52217	—	" " " 52216 with 775c and 52206
1037al	2035	" " " Position Screw
1036al	2035	" " " Set Screw
52022	1503	Thread Take-up Lever with 52130
52023	2039	" " " Hinge Pin
52024	2039	" " " Link
11204	2033	" " " " Hinge Pin
435c	1324	" " " " " Set Screw
52130	—	" " " Thread Eyelet Bushing
52025	—	Thread Take-up Lever , complete, Nos. 52022 to 52024
52394	2039	Thread Take-up Spring
52083	2032	" " " Regulator with 50305c
448c	1324	" " " " Set Screw
44137	1510	Throat Plate , large needle hole, for 44136
12411	2036	" " " " " " 12457
19409	2036	" " " " " " 20162
19410	2036	" " small " " " 20162
12482	—	" " large " " " 12481
12483	2036	" " small " " " 12481
12464	2544	" " large " " " 12450

No.	Plate	
12451	2544	Throat Plate, small needle hole, for 12450 ...
19418	2544	" " large " " " 20158 ...
19419	2544	" " small " " " 20158 ...
691f	1324	" " Screw (2) ...

NOTE.—Throat Plate No. 44137 is sent with this machine unless otherwise specified on order.

139622	—	Drip Pan with four $\frac{3}{4}$ " wire nails ...
--------	---	---

PARTS SPECIAL TO No. 96K51 MACHINE

For Cloaks, Clothing and other work in Cloth. Maximum Stitch 5 to the inch. Drop Feed. Knee Lifter.

This machine is the same as No. 96K40 with the following exceptions:—

No.	Plate	
88621	2545	Needle Bar (hollow) ...
106058	2545	" " Bushing (lower) ...
88622	2545	" Clamp with SS648c ...
SS648c	2545	" " Screw ...
19336	2030	Presser Foot (hinged), complete, Nos. 7298, 19334 and 19335, for 44136 ...
7171	2545	Thread Eyelet ...

PARTS COMPLETE

FOR

No. 96K41 MACHINE (obsolete)

For Cloaks, Clothing, Overalls and other work in Cloth. Maximum Stitch 5 to the inch. Reversible Feed. Knee Lifter.

No.	Plate	
*127329	—	Arm with two 56015 ...

NOTE.—Due to the accuracy required for gear alignment, Arm cannot be supplied separately and can only be sent out as a unit, Arm and Bed assembled.

16532	2032	Arm Dowel Pin (2) ...
52182	2066	" Oil Tube, with 52184, for oiling 52205 ...
52183	2064	" " " " 52184, " " 52024 ...
52180	2066	" " " (long), with 52184, for oiling 52022 ...
52185	2066	" " " (short), with 42367, for oiling 52022 ...
142087	—	" " " with Hole Cover and Holder ...
142069	2545	" " " 142087, with 52150, for oiling 127072 and 127074 ...
56015	2033	" " " for oiling 127058 (2) ...
52150	2039	" " " Packing (braided cotton) for 142069 ...
42367	2064	" " " " (" ") " 52185 ...
52184	2064	" " " " (cotton wick) for 52180, 52182, 52183, and 127191 ...
116e	1324	" Screw (back) (2) ...
854e	2035	" " (front) (2) ...

52382	2372	Arm Shaft (horizontal) ...
88616	—	" " (") 52382 with 127253 for 52081 and 52187 ...

NOTE.—No. 88616 is supplied with this machine unless otherwise specified on order.

52400	2372	Arm Shaft (horizontal) ...
88617	—	" " (") 52400 with 127253 for 56017 ...
127072	2039	" " (") Bevel Gear with two 1036c ...
127070	2029	" " (") " " Case (two pieces) with 121e ...
121e	1324	" " (") " " " Screw ...
1036c	2035	" " (") " " Set Screw ...
52191	2040	" " (") Flanged Bushing (back) ...
52192	—	" " (") " " (") 52191 with 52193 and 52194 ...

No.	Plate	
52401	1529	Arm Shaft (horizontal) Flanged Bushing (back) for 52405 ...
52193	2040	" " (") " " (") Oil Pad ... (braided cotton)
52194	2064	" " (") " " (") Oil Pad (felt)
446c	1324	" " (") " " (") Set Screw ...
52195	2040	" " (") " " (front) ...
52196	—	" " (") " " (") 52195 with 52193 and 52194
52193	2040	" " (") " " (") Oil Pad (braided cotton)
52194	2064	" " (") " " (") Oil Pad (felt)
435c	1324	" " (") " " (") Set Screw ...
68350	2039	" " (") Front Bearing Oil Cup (spring lid) ...
144d	1324	" " (") Screw ...
127058	2028	" " (upright) ...
127073	2039	" " (") Bevel Gear (lower) with two 1259c ...
1259c	2035	" " (") " " (") Set Screw ...
127074	2039	" " (") " " (upper) with two 1259c ...
1259c	2035	" " (") " " (") Set Screw ...
52492	2039	" " (") Bushing (lower) ...
432c	1324	" " (") " " (") Set Screw ...
52493	2039	" " (") " " (upper) ...
435c	1324	" " (") " " (") Set Screw ...
127146	2066	" Side Cap ...
219d	1324	" " " Screw ...
127079	2028	" " Cover ...
50053d	2035	" " " Thumb Screw ...
52239	2064	" Spool Pin and Thread Eyelet ...
8879	1316	" " " Washer (cloth) ...
127192	2064	Arm Top Cover ...
127193	2064	" " " 127192 with 52183, 52239, 127187 and 127255
52183	2064	" " " Oil Tube with 52184 ...
52184	2064	" " " " " Packing (cotton wick) ...
127187	2040	" " " " " (bent) with 42367 ...
42367	2064	" " " " " Packing (braided cotton) ...
127255	2378	" " " Positioning Disc ...
158j	1324	" " " Screw ...
150459	2064	" " " Tension Bracket with 460c ...
52183	2064	" " " " " Oil Tube with 52184 ...
52184	2064	" " " " " " " Packing (cotton wick)
127187	2040	" " " " " " " (bent) with 42367 ...
42367	2064	" " " " " " " Packing (braided cotton)
158j	1324	" " " " " " Screw ...
52239	2064	" " " " " " Spool Pin ...
8879	1316	" " " " " " " Washer (cloth) ...

No.	Plate	
2455	1688	Arm Top Cover Tension Disc ...
41593	1316	" " " " Spring ...
41594	1316	" " " " Stud ...
460c	1324	" " " " " Set Screw ...
41595	1316	" " " " Thread Guide ...
150460	2064	Arm Top Cover Tension Bracket , complete, Nos. 41593 to 41595, 52183, 52239, 127187, 127255, 150459 and two 2455

NOTE:—No. ~~150460~~ is supplied with this machine unless No. ~~127193~~ is specified on order. 150460

~~142033~~

52187	2065	Balance Wheel (power, disc) $2\frac{3}{8}$ " pulley, with two 448c
52081	—	" " (stand, heavy rim) $2\frac{1}{8}$ " pulley, with two 448c
56017	2030	" " $2\frac{1}{4}$ " pulley for 52405 ...
52063	2029	" " Oil Cover ...
2104	1324	" " " " Screw ...
448c	1324	" " " " Set Screw ...

NOTE:—No. ~~52187~~ is supplied with this machine unless otherwise specified on order.

*52383	—	Bed ...
--------	---	----------------

NOTE:—Due to the accuracy required for gear alignment, Bed cannot be supplied separately and can only be sent out as a unit, Arm and Bed assembled.

12431	—	Bed Slide ...
12432	2028	" " complete, Nos. 4307, 12431 and two 725c ...
4307	2028	" " Spring ...
725c	1324	" " " Screw ...
256w	2035	Clamp Stop Motion Clamp Screw ...
248a	2035	" " " " Stop Screw ...
2020	2033	" " " " Washer ...
*52403	—	" " " Flanged Bushing ...
52404	1529	" " " " " 52403 with two 50311al
2022	2033	" " " " " Pin ...
50311al	2035	" " " " " Set Screw ...
52405	—	Clamp Stop Motion , complete, Nos. 248a, 256w, 2020 and 52404, for 56017 ...
52051	—	Face Plate ...
176d	559	" " Screw ...
52053	2030	" " Thread Guard (lower) ...
226d	1324	" " " " (") Screw ...
52170	—	" " " " (upper) ...
226d	1324	" " " " (") Screw ...
50190d	2035	" " Thumb Screw ...
52052	2028	Face Plate , complete, Nos. 52051, 52053, 52170 and two 226d ...

No.	Plate						
52452	2028	Feed Bar
313c	1324	"	"	Screw Centre (2)
1519e	2034	"	"	"	Nut (2)
52165	2066	"		Connecting Link
375c	1324	"	"	"	Hinge Screw
1518e	2034	"	"	"	"	Nut	...
52073	2032	"	"	"	"	Stud	...
50083c	2035	"	"	"	"	Set Screw	...
26603	1529	Feed Dog
28360	1529	"	"	(15 conical teeth)
121446	2376	"	"	(spiked teeth)
50117c	2035	"	"	Screw (2)
<i>NOTE.—Feed Dog No. 26603 is sent with this machine unless otherwise specified on order.</i>							
127324	2373	Feed and Feed Lifting Eccentric	with 52210, 52211 and two	448al			
127325	—	"	"	"	"	127324 with 127152	...
52210	1503	"	"	"	"	Lubricating Pad (wood, long)	...
52211	1503	"	"	"	"	" (" short)	...
448al	1324	"	"	"	"	Set Screw	...
127152	2066	"	"	"	"	Sleeve	...
52407	2029	Feed Forked Connection
52451	—	"	"	"	52407 with 375c, 1518e and 52165
375c	1324	"	"	"	Hinge Screw
1518e	2034	"	"	"	"	Nut	...
52384	2029	Feed Lifting Rock Shaft
127156	2065	"	"	"	Connecting Rod with 127157 and two	966e	...
*127157	—	"	"	"	"	Cap	...
966e	2035	"	"	"	"	"	Screw
375c	1324	"	"	"	"	Hinge Screw	...
1518e	2034	"	"	"	"	"	Nut
12376	2032	"	"	"	Crank with 157c and 1813
157c	1324	"	"	"	"	Clamping Screw	...
1813	2034	"	"	"	"	Roller and Stud	...
50191c	2034	"	"	"	Screw Centre (2)
1513j	1317	"	"	"	"	Nut (2)	...
52385	—	Feed Lifting Rock Shaft, complete	Nos. 12376 and 52384
50338e	2034	Feed Regulating Screw Stud
56032	1502	"	"	"	Head with 56033
50193j	2035	"	"	"	"	Cap Screw	...
56033	1503	"	"	"	"	Stop Pin	...
56034	1502	"	"	"	"	Lock Pin	...
56035	1502	"	"	"	"	Spring	...

No.	Plate						
52408	1502	Feed Regulator	with 50083c
52411	—	"	"	52408 with 52073
1128e	2035	"	"	Hinge Screw
52409	1502	Feed Reverse Lever	with 158e and 51846
50339d	2034	"	"	"	Hinge Screw
158e	1324	"	"	"	"	Clamping Screw	...
52410	1502	"	"	"	"	Friction Washer	...
51846	2034	"	"	"	"	Roller and Stud	...
52386	2029	Feed Rock Shaft
29633	2032	"	"	"	Crank with 157c
157e	1324	"	"	"	"	Clamping Screw	...
50191c	2034	"	"	"	Screw Centre (2)
1513j	1317	"	"	"	"	Nut (2)	...
52387	—	Feed Rock Shaft, complete	Nos. 29633 and 52386
25866	2031	Guide
50190b	2035	"	Thumb Screw
127088	2040	Needle Bar	(hollow)
127322	—	"	"	127088 with 229d, 52307 and 127323
127230	2373	"	"	Bushing (lower)
1133c	2035	"	"	"	(") Set Screw
52014	2039	"	"	"	(upper)
1133c	2035	"	"	"	(") Set Screw
52205	2066	"	"	"	Connecting Link with 52207
52206	—	"	"	"	52205 with 24041
775e	2035	"	"	"	"	Cap Screw	...
52207	—	"	"	"	"	Lubricating Pad (wood)	...
24041	2066	"	"	"	Stud with 207f
207f	F1688	"	"	"	"	Clamping Screw	...
127253	2373	"	"	"	Crank with 1036al, 1037al and 1065al
1065al	2035	"	"	"	"	Position Screw	...
127323	—	"	"	"	"	Thread Guard	...
229d	2035	"	"	"	"	Screw	...
52307	2039	"	"	"	Clamp with 51460f
51460f	2378	"	"	"	"	Screw	...
*52201	2064	Oil Absorbent Wick
52201	—		with 52203, for lower cavity in head
142033	—	Machine Pulley (disc)	" V " belt groove (outside diam. of belt groove 2.9"), with two 435al	of arm
52081	—	Machine Pulley (stand, heavy rim), 2 1/8" pulley, with two 448c
56017	2030	Machine Pulley 2 1/4" pulley, for 52405	52165	...
52063	2029	"	"	Oil Cover
210d	1324	"	"	"	"	Screw	...
448c	1324	"	"	"	"	Set Screw	...

Note—No. 142033 is supplied with machine unless otherwise specified on order

No.	Plate	
12391	2028	Presser Bar (hollow)
52338	1316	" " Guide Bracket with 223c and 453c
453c	1316	" " " " Set Screw
52016	1316	" " Lifter
689c	1316	" " " " Screw
1520r	1317	" " " " Nut
12327	1316	" " Lifting and Releasing Lever Bracket
127108	2029	" " Spring
11170	1316	" " " " Washer
7298	2032	Presser Foot Hinge Pin
52426	—	" " Plate
52390	—	" " Shank
26231	2032	" " Spring
52427	1529	Presser Foot (spring hinged), complete, Nos. 7298, 26231, 52390 and 52426
190d	1324	" " Screw
688j	1324	Pressure Regulating Thumb Screw
127095	2039	Rotating Hook with three 1253c
127096	—	" " 127095 with 127102 and four 1053e
127239	—	" " 127096 with 40274, 127242 and three 1367d
127097	—	" " 127096 with 40274 and three 1367d (for agents only)
127240	—	" " 127239 with 52237
40264	2032	" " Bobbin
52235	—	" " " " Case
52236	—	" " " " 52235 with 591f, 1380d and 40394
40293	—	" " " " Hinge Nos. 2974, 40392 and 125320
127242	—	" " " " Holder
52018	2032	" " " " " " Position Bracket
704j	1324	" " " " " " " " Screw
40392	2032	" " " " " " Latch
125320	2066	" " " " " " Lever
2974	2032	" " " " " " Fulerum Pin
2975	2032	" " " " " " Spring
592e	1324	" " " " " " Stop Screw
591f	1324	" " " " " " Tension Regulating Screw
40394	2032	" " " " " " Spring
1380d	2035	" " " " " " Screw
52237	2032	" " " " " " complete, Nos. 592e, 2975, 40393 and 52236
144828	—	Rotating Hook with three 1253c agents only)
144829	—	Rotating Hook 144828 with 270083 and four 1053e
144830	—	Rotating Hook 144829 with 40274, 143346 and three 1367e
144832	—	Rotating Hook 144830 with 52237
144831	—	Rotating Hook 144829 with 40274 and three 1367e (for agents only)

No.	Plate	
1253c	2035	Rotating Hook Set Screw
127059	2065	" " Shaft
127073	2039	" " " " Bevel Gear with two 1259c
127007	2029	" " " " " " Case (two pieces) with 121e and 50234d
50234d	2035	" " " " " " Plug Screw
121e	1324	" " " " " " Screw
1259c	2035	" " " " " " Set Screw
127004	2039	" " " " " " Bushing (back)
127043	—	" " " " " " (") 127004 with 52045
52045	2032	" " " " " " (") Packing (cotton)
1143c	2035	" " " " " " (") Set Screw
127005	2039	" " " " " " (front)
127044	—	" " " " " " (") 127005 with 52045
142008	2373	" " " " " " (") Oil Cup
52045	2032	" " " " " " (") Packing (cotton)
1148c	2035	" " " " " " (") Set Screw
27083 127102	2039	" " " " Thread Guard
1053c	2035	" " " " " " Screw
52337	1316	Slack Thread Regulator
223c	1316	" " " " Set Screw
2102	2032	Tension Disc
1560c	2034	" Regulating Thumb Nut
32572	2032	" Releasing Disc
43944	1316	" " Lever
12398	1316	" " " Hinge Pin
12329	1316	" " " Spring
32574	2032	" " Pin
2103	2032	" Spring
*50304c	2034	" Stud
52098	—	" " 50304c with 1560c
50305c	2035	" " Set Screw
52397	—	Tension , complete, Nos. 2103, 32572, 32574, 52083, 52098, 52394 and two 2102
52027	2032	Thread Guard (side of arm)
52454	2030	" Retainer
624c	2035	" " Set Screw
52215	—	Thread Take-up , complete, Nos. 11204, 52025 and 52217
52216	2373	Thread Take-up Crank
52217	—	" " " 52216 with 775c and 52206
1037a1	2035	" " " Position Screw
1036a1	2035	" " " Set Screw

No.	Plate	
52195	2040	Arm Shaft (horizontal) Flanged Bushing (front)
52196	—	" " (") " " (") 52195 with 52193 and 52194
52193	2040	" " (") " " (") Oil Pad (braided cotton)
52194	2064	" " (") " " (") Oil Pad (felt)
435c	1324	" " (") " " (") Set Screw ...
68350	2039	" " (") Front Bearing Oil Cup (spring lid) ...
144d	1324	" " (") Screw
127058	2028	" " (upright)
127073	2039	" " (") Bevel Gear (lower) with two 1259c ...
1259c	2035	" " (") " " (") Set Screw
127074	2039	" " (") " " (upper) with two 1259c ...
1259c	2035	" " (") " " (") Set Screw
52492	2039	" " (") Bushing (lower)
432c	1324	" " (") " " (") Set Screw
52493	2039	" " (") " " (upper)
435c	1324	" " (") " " (") Set Screw
127146	2066	" Side Cap
219d	1324	" " " Screw
127079	2028	" " Cover
50053d	2035	" " " Thumb Screw
52239	2064	" Spool Pin and Thread Eyelet
8879	1316	" " " Washer (cloth)
127192	2064	Arm Top Cover
127493	2064	" " " 127192 with 52183, 52239, 127187 and 127255
52183	2064	" " " Oil Tube with 52184
52184	2064	" " " " " Packing (cotton wick)
127187	2040	" " " " " (bent) with 42367
42367	2064	" " " " " Packing (braided cotton)
127255	2378	" " " Positioning Disc
158j	1324	" " " Screw
150459	2064	" " " Tension Bracket with 460c
52183	2064	" " " " " Oil Tube with 52184
52184	2064	" " " " " Packing (cotton wick)
127187	2040	" " " " " (bent) with 42367
42367	2064	" " " " " Packing (braided cotton)
158j	1324	" " " " " Screw
52239	2064	" " " " " Spool Pin
8879	1316	" " " " " Washer (cloth)
2455	1688	" " " " " Disc

No.	Plate	
41593	1316	Arm Top Cover Tension Spring
41594	1316	" " " " Stud
460c	1324	" " " " " Set Screw
41595	1316	" " " " " Thread Guide
150460	2064	Arm Top Cover Tension Bracket , complete, Nos. 41593 to 41595, 52183, 52239, 127187, 127255, 150459 and two 2455

NOTE.—No. ~~150460~~ is supplied with this machine unless No. ~~127193~~ is specified on order. ~~150460~~

14233 52187	2065	Balance Wheel (power, disc) 2 $\frac{3}{16}$ " pulley, with two 448c ...
52081	"	" " (stand, heavy rim) 2 $\frac{11}{16}$ " pulley, with two 448c
52063	2029	" " Oil Cover
246d	1324	" " " " Screw
448c	1324	" " " Set Screw

NOTE.—No. ~~52187~~ is supplied with this machine unless otherwise specified on order.

*52383	—	Bed
--------	---	-------------------

NOTE.—Due to the accuracy required for gear alignment, Bed cannot be supplied separately and can only be sent out as a unit, Arm and Bed assembled.

12431	—	Bed Slide
12432	2028	" " complete, Nos. 4307, 12431 and two 725e ...
4307	2028	" " Spring
725e	1324	" " " Screw

52051	—	Face Plate
176d	559	" " Screw
52053	2030	" " Thread Guard (lower)
226d	1324	" " " " (") Screw
52170	—	" " " " (upper)
226d	1324	" " " " (") Screw
50190d	2035	" " " Thumb Screw
52052	2028	Face Plate , complete, Nos. 52051, 52053, 52170 and two 226d ...

52452	2028	Feed Bar
313c	1324	" " Screw Centre (2)
1519c	2034	" " " " Nut (2)
52165	2066	" Connecting Link
375c	1324	" " " Hinge Screw
1518c	2034	" " " " Nut
52073	2032	" " " Stud
50083c	2035	" " " " Set Screw

12436	7699	Feed Dog
50117c	2035	" " Screw (2)

No.	Plate	
127202	—	Feed and Feed Lifting Eccentric with 448c, 1299c, 52210 and 52211
127225	—	" " " " " 127202 with 127152
52210	1503	" " " " " " Lubricating Pad (wood, long)
52211	1503	" " " " " " " " (" " short)
1299c	2040	" " " " " " Position Screw
448c	1324	" " " " " " Set Screw
127152	2066	" " " " " " Sleeve
20284	2029	Feed Forked Connection
52393	—	" " " " 20284 with 375c, 1518c and 52165
375c	1324	" " " " " Hinge Screw
1518c	2034	" " " " " " Nut
52384	2029	Feed Lifting Rock Shaft
127156	2065	" " " " " Connecting Rod with 127157 and two 966e
*127157	—	" " " " " " " Cap
966e	2035	" " " " " " " " Screw
375c	1324	" " " " " " " Hinge Screw
1518c	2034	" " " " " " " " " Nut
12376	2032	" " " " " " Crank with 157c and 1813
157c	1324	" " " " " " " Clamping Screw
1813	2034	" " " " " " " Roller and Stud
50191c	2034	" " " " " " " Screw Centre (2)
1513j	1317	" " " " " " " Nut (2)
52385	—	Feed Lifting Rock Shaft, complete, Nos. 12376 and 52384
52074	2033	Feed Regulator with 50083c
52118	—	" " " " 52074 with 52073
52093	—	" " " " 52118 with 818d
1128c	2035	" " " " " Hinge Screw
818d	2035	" " " " " Thumb Screw
52386	2029	Feed Rock Shaft
29633	2032	" " " " " Crank with 157c
157c	1324	" " " " " " Clamping Screw
50191c	2034	" " " " " " Screw Centre (2)
1513j	1317	" " " " " " " Nut (2)
142033	—	Machine Pulley (disc) "V" belt groove (outside diam. of belt groove 2.9"), with two 435al
52081	—	Machine Pulley (stand, heavy rim), 2 1/8" pulley, with two 448c
52063	2029	Machine Pulley Oil Cover
210d	1324	" " " " " " Screw
448c	1324	" " " " " " Set Screw for 52081
435al	1324	" " " " " " " 142033

No.	Plate	
127088	2040	Needle Bar (hollow)
127131	—	" " " 127088 with 229d, 127045 and 127046
127230	2373	" " " Bushing (lower)
1133c	2035	" " " " (") Set Screw
52044	2039	" " " " " (upper)
1133c	2035	" " " " " (") Set Screw
52205	2066	" " " Connecting Link with 52207
52206	—	" " " " " 52205 with 24041
775c	2035	" " " " " Cap Screw
52207	—	" " " " " Lubricating Pad (wood)
24041	2066	" " " " " Stud with 207q
207q	1688	" " " " " Clamping Screw
127253	2373	" " " Crank with 1036al, 1037al, and 1065al
1065al	2035	" " " " " Position Screw
127045	2033	" " " Thread Guard
229d	2035	" " " " " Screw
127046	2033	" " " Clamp with 51460f
51460f	2378	" " " " " Screw
*52201	2064	Oil Absorbent Wick
52202	2064	" " " " 52201, with 52203, for lower cavity in head of arm
*52203	2010	" " " " " Wire
127191	—	Oil Tube, with 52184
127091	2040	" " " Bracket
127092	—	" " " " 127091, with 127191, for oiling 52165
52184	2064	" " " Packing (cotton wick)
12391	2028	Presser Bar (hollow)
52338	1316	" " " Guide Bracket with 223c and 453c
453c	1316	" " " " " Set Screw
52016	1316	" " " Lifter
689c	1316	" " " " " Screw
1520f	1317	" " " " " Nut
12327	1316	" " " Lifting and Releasing Lever Bracket
127108	2029	" " " Spring
11170	1316	" " " " " Washer
688j	1324	Pressure Regulating Thumb Screw
51928	2375	Roller (ball-bearing) 3/8" diam., 3/16" face, coarse, complete, Nos. 1528d, 201699f, 350104f and twenty-eight 206417, for 127271
51903	2375	Roller (ball-bearing), 3/8" diam., 3/16" face, fine, complete, Nos. 1528d, 201699f, 350104f and twenty-eight 206417, for 62867
51899	2375	Roller (ball-bearing), 5/8" diam., 3/16" face, fine, complete, Nos. 1528d, 201699f, 350104f and twenty-eight 206417, for 62863

No.	Plate	
127273	—	Roller Arm for 127271
62897	—	" " " 62867
62856	—	" " " 62863
440f	2378	" " Adjusting Screw
1547j	2378	" " " " Nut
80297	2375	" " Bracket
316f	1324	" " " Screw Centre
1547j	2378	" " " " Nut
2205	2378	" " Lock Spring
176d	559	" " " " Screw
1549j	2378	" " " " Nut
206417	—	" Ball, $\frac{1}{16}$ " diam.
201699f	2378	" Retaining Nut
350104f	2378	" Screw
1528d	2378	" Nut
127271	2375	Roller Presser (ball-bearing), $\frac{3}{8}$ " diam., $\frac{3}{16}$ " face, coarse, complete. Nos. 176d, 440f, 1549j, 2205, 51928, 80297, 127273, two 316f and three 1547j
62867	2375	Roller Presser (ball-bearing), $\frac{3}{8}$ " diam., $\frac{3}{16}$ " face, fine, complete. Nos. 176d, 440f, 1549j, 2205, 51903, 62897, 80297, two 316f and three 1547j
62863	2375	Roller Presser (ball-bearing), $\frac{3}{8}$ " diam., $\frac{3}{16}$ " face, fine, complete. Nos. 176d, 440f, 1549j, 2205, 51899, 62856, 80297, two 316f and three 1547j
176d	559	Roller Presser Screw
127095	2039	Rotating Hook with three 1253c
127096	2039	" " 127095 with 127102 and four 1053e
127239	2039	" " 127096 " 40274, 127242 and three 1367d
127097	2039	" " 127096 " 40274 and three 1367d (for agents only)
127240	2032	" " 127239 " 52237
10264	2032	" " Bobbin
52235	—	" " " Case
52236	—	" " " " 52235 with 591f, 1380d and 40394
40393	—	" " " Hinge, Nos. 2974, 40392 and 125320
127242	2032	" " " Holder
52048	2032	" " " " Position Bracket
704j	1324	" " " " " Screw
40392	2032	" " " " Latch
125320	2066	" " " " Lever
2974	2032	" " " " Fulcrum Pin
2975	2032	" " " " Spring
144828	—	Rotating Hook with three 1253c
144829	—	Rotating Hook 144828 with 270083 and four 1053e
144830	—	Rotating Hook 144829 with 40274, 143346 and three 1367e
144832	—	Rotating Hook 144830 with 52237
144831	—	Rotating Hook 144829 with 40274 and three 1367e (for agents only)

Handwritten notes on the left margin of page 94, including numbers like 104828, 144829, 144830, 144831, and 144832, along with a vertical line and other markings.

No.	Plate	
40394	2032	Rotating Hook Bobbin Case Tension Spring
1380d	2035	" " " " " Screw
52237	2032	" " " " complete, Nos. 592c, 2975, 40393 and 52236
127244	—	" " " " 52237 with 127242 (for agents only)
40274	2032	" " Section
1367d	2035	" " " Screw
1253c	2035	" " Set Screw
127059	2065	" " Shaft
127073	2039	" " " Bevel Gear with two 1259c
127007	2029	" " " " Case (two pieces) with 121e and 50234d
50234d	2035	" " " " Plug Screw
121e	1324	" " " " Screw
1259c	2035	" " " " Set Screw
127004	2039	" " " Bushing (back)
127043	—	" " " " (") 127004 with 52045
52045	2032	" " " " (") Packing (cotton)
1143c	2035	" " " " (") Set Screw
127005	2039	" " " " (front)
127044	—	" " " " (") 127005 with 52045
142008	2373	" " " " (") Oil Cup
52045	2032	" " " " (") Packing (cotton)
1148c	2035	" " " " (") Set Screw
127102	2039	" " Thread Guard
1053e	2035	" " " " Screw
52337	1316	Slack Thread Regulator
223c	1316	" " " Set Screw
52046	1815	Spool Holder Base
389d	2035	" " " Screw
204296	1815	" " " Wire
200079h	2034	" " " Hinge Screw
52047	1815	Spool Holder , complete, Nos. 52046, 200079h and 204296
2102	2032	Tension Disc
1560c	2034	" Regulating Thumb Nut
32572	2032	" Releasing Disc
43944	1316	" " Lever
12398	1316	" " " Hinge Pin
12329	1316	" " " Spring
32571	2032	" " Pin
2103	2032	" Spring
*50304c	2034	" Stud
52098	—	" " 50304c with 1560c
50305c	2035	" " Set Screw

Handwritten note '270083' on page 95, next to the entry for 127102.

No.	Plate	
52397	—	Tension , complete, Nos. 2103, 32572, 32574, 52083, 52098, 52394 and two 2102
52027	2032	Thread Guard (side of arm)
52454	2030	" Retainer
624c	2035	" " Set Screw
52215	—	Thread Take-up , complete, Nos. 11201, 52025 and 52217
52216	2373	Thread Take-up Crank
52217	—	" " " 52216 with 775e and 52206
1037al	2035	" " " Position Screw
1036al	2035	" " " Set Screw
52022	1503	Thread Take-up Lever with 52130
52023	2039	" " " Hinge Pin
52024	2039	" " " Link
11204	2033	" " " Hinge Pin
435c	1324	" " " " " " Set Screw
52130	—	" " " Thread Eyelet Bushing
52025	—	Thread Take-up Lever , complete, Nos. 52022 to 52024
52394	2039	Thread Take-up Spring
52083	2032	" " " Regulator with 50305e
448c	1324	" " " " " " Set Screw
2444	—	Throat Plate , large oblong needle hole, for 12436
24443	7699	" " small " " " " 12436
691f	1324	" " " Screw (2)

NOTE: Throat Plate No. 2444 is sent with this machine unless otherwise specified on order.

139622 — **Drip Pan** with four $\frac{3}{4}$ " wire nails

PARTS COMPLETE

FOR

No. 96K43 MACHINE

For Stitching Top Facings to Shoe Lining, also for Side and Back Stays. Maximum Stitch 7 to the inch. Drop Feed. Roller Presser. Knee Lifter.

No.	Plate	
*127330	—	Arm with two 56015

NOTE: Due to the accuracy required for gear alignment, Arm cannot be supplied separately and can only be sent out as a unit, Arm and Bed assembled.

16532	2032	Arm Dowel Pin (2)
52182	2066	" Oil Tube, with 52184, for oiling 52205
52183	2064	" " " " 52184, " " 52024
52180	2066	" " " (long) with 52184, for oiling 52022
52185	2066	" " " (short) " 12367, " " 52022
142087	—	" " " with Hole Cover and Holder
142069	2545	" " " 142087, with 52150, for oiling 127072 and 127074
56015	2033	" " " for oiling 127058 (2)
52150	2039	" " " Packing (braided cotton) for 142069
42367	2064	" " " " (" ") " 52185
52184	2064	" " " " (cotton wick) for 52180, 52182, 52183, and 127191
116e	1324	" Screw (back) (2)
854e	2035	" " (front) (2)
127017	1815	Arm Shaft (horizontal)
88615	—	" " (") 127017 with 127253
127072	2039	" " (") Bevel Gear with two 1036e
127070	2029	" " (") " " Case (two pieces) with 121e
121e	1324	" " (") " " " Screw
1036e	2035	" " (") " " " Set Screw
52191	2040	" " (") Flanged Bushing (back)
52192	—	" " (") " " (") 52191, with 52193 and 52194
52193	2040	" " (") " " (") Oil Pad (braided cotton)
52194	2064	" " (") " " (") Oil Pad (felt)
446e	1324	" " (") " " (") Set Screw
52195	2040	" " (") " " (front)
52196	—	" " (") 52195 with 52193 and 52194

No.	Plate				
52193	2040	Arm Shaft (horizontal) Flanged Bushing (front) Oil Pad			
		(braided cotton)			
52194	2064	" " (") " " (") Oil Pad (left)			
435c	1324	" " (") " " (") Set Screw ...			
68350	2039	" " (") Front Bearing Oil Cup (spring lid) ...			
144d	1324	" " (") Screw ...			
127058	2028	" " (upright) ...			
127073	2039	" " (") Bevel Gear (lower) with two 1259c ...			
1259c	2035	" " (") " " (") Set Screw ...			
127074	2039	" " (") " " (upper) with two 1259c ...			
1259c	2035	" " (") " " (") Set Screw ...			
52492	2039	" " (") Bushing (lower) ...			
432c	1324	" " (") " " (") Set Screw ...			
52493	2039	" " (") " " (upper) ...			
435c	1324	" " (") " " (") Set Screw ...			
127146	2066	" Side Cap ...			
219d	1324	" " " Screw ...			
127079	2028	" " Cover ...			
50053d	2035	" " " Thumb Screw ...			
52239	2064	" Spool Pin and Thread Eyelet ...			
8879	1316	" " " Washer (cloth) ...			
127192	2064	Arm Top Cover ...			
127193	2064	" " " 127192 with 52183, 52239, 127187 and 127255			
52183	2064	" " " Oil Tube with 52184 ...			
52184	2064	" " " " " Packing (cotton wick) ...			
127187	2040	" " " " " (bent) with 42367 ...			
42367	2064	" " " " " Packing (braided cotton) ...			
127255	2378	" " " Positioning Disc ...			
158j	1324	" " " Screw ...			
150459	2064	" " " Tension Bracket with 460c ...			
52183	2064	" " " " " Oil Tube with 52184 ...			
52184	2064	" " " " " Packing (cotton wick) ...			
127187	2040	" " " " " (bent) with 42367 ...			
42367	2064	" " " " " Packing (braided cotton) ...			
158j	1324	" " " " " Screw ...			
52239	2064	" " " " " Spool Pin ...			
8879	1316	" " " " " Washer (cloth) ...			
2455	1688	" " " " " Disc ...			
41593	1316	" " " " " Spring ...			
41594	1316	" " " " " Stud ...			
460c	1324	" " " " " Set Screw ...			
41595	1316	" " " " " Thread Guide ...			

No.	Plate				
150460	2064	Arm Top Cover Tension Bracket , complete, Nos. 41593 to 41595, 52183, 52239, 127187, 127255, 150459 and two 2455			
		<i>NOTE: No. 150460 is supplied with this machine unless No. 127193 is specified on order.</i>			
142033					
52487	2065	Balance Wheel (power, disc) 2 $\frac{3}{16}$ " pulley, with two 448c ...			
52081		" " (stand, heavy rim) 2 $\frac{3}{16}$ " pulley, with two 448c ...			
52068	2029	" " Oil Cover ...			
240d	1324	" " " " " Screw ...			
448c	1324	" " " " " Set Screw ...			
		<i>NOTE: No. 52487 is supplied with this machine unless otherwise specified on order.</i>			
*52383		Bed ...			
		<i>NOTE: Due to the accuracy required for gear alignment, Bed cannot be supplied separately and can only be sent out as a unit, Arm and Bed assembled.</i>			
52417		Bed Slide ...			
52418	2030	" " complete, Nos. 52417, 52464 and two 665c ...			
52464	2033	" " Spring ...			
665c	2035	" " " " " Screw ...			
120063	7703	Edge Guide ...			
50190b	2035	" " " Thumb Screw ...			
52051		Face Plate ...			
176d	559	" " " Screw ...			
52053	2030	" " " Thread Guard (lower) ...			
226d	1324	" " " " " (") Screw ...			
52170		" " " " " (upper) ...			
226d	1324	" " " " " (") Screw ...			
50190d	2035	" " " " " Thumb Screw ...			
52052	2028	Face Plate , complete, Nos. 52051, 52053, 52170 and two 226d ...			
52452	2028	Feed Bar ...			
313c	1324	" " " Screw Centre (2) ...			
1519c	2034	" " " " " Nut (2) ...			
52165	2066	" " " Connecting Link ...			
375c	1324	" " " " " Hinge Screw ...			
1518c	2034	" " " " " " Nut ...			
52073	2032	" " " " " Stud ...			
50083c	2035	" " " " " " Set Screw ...			
12436	7699	Feed Dog ...			
50117c	2035	" " " Screw (2) ...			
127202		Feed and Feed Lifting Eccentric with 448c, 1299c, 52210 and 52211			
127225		" " " " " 127202 with 127152 ...			
52210	1503	" " " " " " Lubricating Pad (wood, long)			
52211	1503	" " " " " " " " (" short)			

No.	Plate					
1299c	2040	Feed and Feed Lifting Eccentric	Position Screw
448c	1324	" " " "	" Set Screw
127152	2066	" " " "	" Sleeve
20284	2029	Feed Forked Connection
52393	—	" " " "	20284 with 375c, 1518c and 52165
375c	1324	" " " "	" Hinge Screw
1518c	2034	" " " "	" " Nut
52384	2029	Feed Lifting Rock Shaft
127156	2065	" " " "	Connecting Rod with 127157 and two 966e
*127157	—	" " " "	" " Cap
966e	2035	" " " "	" " Screw
375c	1324	" " " "	" " Hinge Screw
1518c	2034	" " " "	" " Nut
12376	2032	" " " "	Crank with 157c and 1813
157c	1324	" " " "	" Clamping Screw
1813	2034	" " " "	" Roller and Stud
50191c	2034	" " " "	" Screw Centre (2)
1513j	1317	" " " "	" " Nut (2)
52385	—	Feed Lifting Rock Shaft , complete, Nos. 12376 and 52384
52674	2033	Feed Regulator with 50083c
52118	—	" " 52074 with 52073
52093	—	" " 52118 with 818d
1128c	2035	" " Hinge Screw
818d	2035	" " Thumb Screw
52386	2029	Feed Rock Shaft
29633	2032	" " " "	Crank with 157c
157c	1324	" " " "	" Clamping Screw
50191c	2034	" " " "	" Screw Centre (2)
1513j	1317	" " " "	" " Nut (2)
52387	—	Feed Rock Shaft , complete, Nos. 29633 and 52386
127088	2040	Needle Bar (hollow)
127132	—	" " 127088 with 229d, 52307 and 52415
127230	2373	" " " "
142033	—	Machine Pulley (disc) "V" belt groove (outside diam. of belt groove 2-9"), with two 435al
52081	—	Machine Pulley (stand, heavy rim), 2 $\frac{11}{16}$ " pulley, with two 448c
52063	2029	Machine Pulley Oil Cover
210d	1324	" " " " Screw
448c	1324	" " Set Screw for 52081
435al	1324	" " " " 142033

Note—No. 142033 is supplied with machine unless otherwise specified on order

No.	Plate					
24041	2066	Needle Bar Connecting Stud with 207a ^f
207c ^f	1688	" " " " Clamping Screw
127253	2373	" " Crank with 1036al, 1037al, and 1065al
1065al	2035	" " " " Position Screw
52415	2033	" " Thread Guard
229d	2035	" " " " Screw
52307	2039	" Clamp with 51460f
51460f	2378	" " Screw
*52201	2064	Oil Absorbent Wick
52202	2064	" " " 52201, with 52203, for lower cavity in head of arm
*52203	2040	" " " Wire
127191	—	Oil Tube , with 52184
127091	2040	" " Bracket
127092	—	" " " 127091, with 127191, for oiling 52165
52184	2064	" " Packing (cotton wick)
12391	2028	Presser Bar (hollow)
52338	1316	" " Guide Bracket with 223c and 453c
453c	1316	" " " " Set Screw
52016	1316	" " Lifter
689c	1316	" " " Screw
1520r	1317	" " " Nut
12327	1316	" " Lifting and Releasing Lever Bracket
127108	2029	" " Spring
11170	1316	" " " Washer
688j	1324	Pressure Regulating Thumb Screw
51928	2375	Roller (ball-bearing), $\frac{3}{8}$ " diam., $\frac{3}{16}$ " face, coarse, complete, Nos. 1528d, 201699f, 350104f and twenty eight 206417, for 127271
51903	2375	Roller (ball-bearing), $\frac{7}{8}$ " diam., $\frac{3}{16}$ " face, fine, complete, Nos. 1528d, 201699f, 350104f and twenty eight 206417, for 62867
51927	2375	Roller (ball-bearing), $1\frac{1}{4}$ " diam., $\frac{11}{16}$ " face, coarse, complete, Nos. 1528d, 1766c, 50553c and twenty-four 16232, for 127272
127273	—	Roller Arm for 127271
62897	—	" " " 62867
127274	—	" " " 127272
440f	2378	" " Adjusting Screw
1517j	2378	" " " " Nut
80297	2375	" " Bracket
316f	1324	" " " Screw Centre
1517j	2378	" " " " Nut
2205	2378	" " Lock Spring
176d	559	" " " " Screw
1519j	2378	" " " " Nut

No.	Plate	
206417		Roller Ball , $\frac{1}{16}$ " diam., for 51903 and 51928
16232		" " $\frac{3}{32}$ " diam., for 51927
201699f	2378	" " Retaining Nut for 51903 and 51928
1766c	2378	" " " " " 51927
350104f	2378	" Screw for 51903 and 51928
50553c	2035	" " " 51927
1528d	2378	" " Nut
127271	2375	Roller Presser (ball-bearing), $\frac{5}{8}$ " diam., $\frac{5}{16}$ " face, coarse, complete, Nos. 176d, 440f, 1549j, 2205, 51928, 80297, 127273, two 316f and three 1547j
62867	2375	Roller Presser (ball-bearing), $\frac{7}{8}$ " diam., $\frac{9}{16}$ " face, fine, complete, Nos. 176d, 440f, 1549j, 2205, 51903, 62897, 80297, two 316f and three 1547j
127272	2375	Roller Presser (ball-bearing), $1\frac{1}{8}$ " diam., $\frac{1}{4}$ " face, coarse, complete, Nos. 176d, 440f, 1549j, 2205, 51927, 80297, 127274, two 316f and three 1547j
176d	559	Roller Presser Screw
127095	2039	Rotating Hook with three 1253c
127096	2039	" " 127095 with 127102 and four 1053c
127097	2039	" " 127096 " 40274, 127242 and three 1367d
127097	2039	" " 127096 " 40274, and three 1367d (for agents only)
127240	2032	" " 127239 with 52237
40264	2032	" " Bobbin
52235	2032	" " Case
52236	2032	" " " 52235 with 591f, 1380d and 40394
40393	2032	" " " " Hinge, Nos. 2974, 40392 and 125320
14334k	2032	" " " " Holder
127242	2032	" " " " " Position Bracket
52018	1324	" " " " " " Screw
704j	1324	" " " " " " " Screw
40392	2032	" " " " " Latch
125320	2066	" " " " " Lever
2974	2032	" " " " " Fulcrum Pin
2975	2032	" " " " " Spring
592c	1324	" " " " " Stop Screw
591f	1324	" " " " " Tension Regulating Screw
40394	2032	" " " " " Spring
1380d	2035	" " " " " Screw
52237	2032	" " " " " complete, Nos. 592c, 2975, 40393 and 52236
14334s	2032	" " " " " 52237 with 127242 (for agents only)
127244	2032	" " " " " 52237 with 127242 (for agents only)
144828	—	Rotating Hook with three 1253c
144829	—	Rotating Hook 144828 with 270083 and four 1053c
144830	—	Rotating Hook 144829 with 40274, 143346 and three 1367c
144832	—	Rotating Hook 144830 with 52237
144831	—	Rotating Hook 144829 with 40274 and three 1367c (for agents only)

No.	Plate	
1253c	2035	Rotating Hook Set Screw
127059	2065	" " Shaft
127073	2039	" " " Bevel Gear with two 1259c
127007	2029	" " " " " Case (two pieces) with 121e and 50231d
50231d	2035	" " " " " Plug Screw
121e	1324	" " " " " Screw
1259c	2035	" " " " " Set Screw
127004	2039	" " " " Bushing (back)
127043	2032	" " " " (") 127004 with 52045
52045	2032	" " " " (") Packing (cotton)
1143c	2035	" " " " (") Set Screw
127005	2039	" " " " (front)
127044	2032	" " " " (") 127005 with 52045
112008	2373	" " " " (") Oil Cup
52045	2032	" " " " (") Packing (cotton)
1148c	2035	" " " " (") Set Screw
270083 127102	2039	" " " Thread Guard
1053c	2035	" " " " Screw
52337	1316	Slack Thread Regulator
223c	1316	" " " Set Screw
52046	1815	Spool Holder Base
389d	2035	" " " Screw
204296	1815	" " " Wire
200079h	2034	" " " " Hinge Screw
52047	1815	Spool Holder , complete, Nos. 52046, 200079h and 204296
120067	7704	Strip Guide
120068	7704	" " (adjustable) with 291f
120069	7704	" " (") Bar
120070	7704	" " (") " Plate
50169d	7704	" " (") " " Screw
50169d	7704	" " (") " Screw
291f	7704	" " (") Thumb Screw
120071	7704	Strip Guide (adjustable), complete, Nos. 120067 to 120070 and six 50169d
1423d	7704	" " " Screw
2102	2032	Tension Disc
1560c	2034	" Regulating Thumb Nut
32572	2032	" Releasing Disc
43944	1316	" " Lever
12398	1316	" " " Hinge Pin
12329	1316	" " " Spring

No.	Plate						
32574	2032	Tension Releasing Pin					
2103	2032	" Spring					
*50304c	2034	" Stud					
52098	—	" " 50304c with 1560c					
50305c	2035	" " Set Screw					
52397	—	Tension, complete, Nos. 2103, 32572, 32574, 52083, 52098, 52394 and two 2102					
52027	2032	Thread Guard (side of arm)					
52454	2030	" Retainer					
624c	2035	" " Set Screw					
52215	—	Thread Take-up, complete, Nos. 11204, 52025 and 52217					
52216	2373	Thread Take-up Crank					
52217	—	" " " 52216 with 775c and 52206					
1037ad	2035	" " " Position Screw					
1036ad	2035	" " " Set Screw					
52022	1503	Thread Take-up Lever with 52130					
52023	2039	" " " Hinge Pin					
52024	2039	" " " Link					
11204	2033	" " " Hinge Pin					
435c	1324	" " " " " Set Screw					
52130	—	" " " Thread Eyelet Bushing					
52025	—	Thread Take-up Lever, complete, Nos. 52022 to 52024					
52394	2039	Thread Take-up Spring					
52083	2032	" " " Regulator with 50305c					
448c	1324	" " " " " Set Screw					
12438	7699	Throat Plate, large oblong needle hole, for 12436					
20192	—	" " small " " " " 12436					
691f	1324	" " " Screw (2)					

NOTE. Throat Plate No. 12438 is sent with this machine unless otherwise specified on order.

*15404	—	Trade Mark					
15405	—	" " Rivet					
139622	—	Drip Pan with four 3/4" wire nails					

PARTS COMPLETE FOR No. 96K44 MACHINE

For Overalls, Heavy Overcoats, Khaki and other heavy materials. Maximum Stitch 5 to the inch. Reversible Feed. Lift of Presser Foot $\frac{5}{16}$ ". Knee Lifter.

No.	Plate						
*127329	—	Arm with two 56015					
<i>NOTE. Due to the accuracy required for gear alignment, Arm cannot be supplied separately and can only be sent out as a unit, Arm and Bed assembled.</i>							
16532	2032	Arm Dowel Pin (2)					
52182	2066	" Oil Tube, with 52184, for oiling 52205					
52183	2064	" " " " 52184, " " 52024					
52180	2066	" " " (long), with 52184, for oiling 52022					
52185	2066	" " " (short), " 42367, " " 52022					
142087	—	" " " with Hole Cover and Holder					
142069	2545	" " " 142087, with 52150, for oiling 127072 and 127974					
52015	2033	" " " for oiling 127058 (2)					
52150	2039	" " " Packing (braided cotton) for 142069					
42367	2064	" " " " (" ") " 52185					
52184	2064	" " " " (cotton wick) for 52180, 52182, 52183, and 127191					
116e	1324	" Screw (back) (2)					
854e	2035	" " (front) (2)					
52382	2372	Arm Shaft (horizontal)					
88618	—	" " (") 52382 with 127222					
127072	2039	" " (") Bevel Gear with two 1036c					
127070	2029	" " (") " " Case (two pieces) with 121e					
121e	1324	" " (") " " " Screw					
1036c	2035	" " (") " " " Set Screw					
52191	2040	" " (") Flanged Bushing (back)					
52192	—	" " (") " " (") 52191 with 52193 and 52194					
52193	2040	" " (") " " (") Oil Pad (braided cotton)					
52194	2064	" " (") " " (") Oil Pad (felt)					
446c	1324	" " (") " " (") Set Screw					
52195	2040	" " (") " " (front)					

No.	Plate	
52196	—	Arm Shaft (horizontal) Flanged Bushing (front) 52195 with 52193 and 52191
52193	2040	" " (") " " (") Oil Pad (braided cotton)
52194	2064	" " (") " " (") Oil Pad (felt)
435c	1324	" " (") " " (") Set Screw ...
68350	2039	" " (") Front Bearing Oil Cup (spring lid) ...
141d	1324	" " (") Screw ...
127058	2028	" " (upright) ...
127073	2039	" " (") Bevel Gear (lower) with two 1259c ...
1259c	2035	" " (") " " (") Set Screw ...
127074	2039	" " (") " " (upper) with two 1259c ...
1259c	2035	" " (") " " (") Set Screw ...
52492	2039	" " (") Bushing (lower) ...
432c	1324	" " (") " " (") Set Screw ...
52493	2039	" " (") " " (upper) ...
435c	1324	" " (") " " (") Set Screw ...
127146	2066	" Side Cap ...
219d	1324	" " " Screw ...
127079	2028	" " Cover ...
50053d	2035	" " " Thumb Screw ...
52239	2064	" Spool Pin and Thread Eyelet ...
8879	1316	" " " Washer (cloth) ...
127192	2064	Arm Top Cover ...
127193	2064	" " " 127192 with 52183, 52239, 127187 and 127255
52183	2064	" " " Oil Tube with 52181 ...
52184	2064	" " " " " Packing (cotton wick) ...
127187	2040	" " " " " (bent) with 42367 ...
12367	2064	" " " " " Packing (braided cotton) ...
127255	2378	" " " Positioning Disc ...
158j	1324	" " " Screw ...
150459	2064	" " " Tension Bracket with 460c ...
52183	2064	" " " " " Oil Tube with 52181 ...
52184	2064	" " " " " " " Packing (cotton wick)
127187	2040	" " " " " (bent) with 42367
42367	2064	" " " " " " " Packing (braided cotton)
158j	1324	" " " " " Screw ...
52239	2064	" " " " " Spool Pin ...
8879	1316	" " " " " " " Washer (cloth) ...
2455	1688	" " " " " Disc ...
41593	1316	" " " " " Spring ...
41594	1316	" " " " " Stud ...
460c	1324	" " " " " Set Screw ...
41595	1316	" " " " " Thread Guide ...

No.	Plate	
150460	2061	Arm Top Cover Tension Bracket , complete, Nos. 41593 to 41595, 52183, 52239, 127187, 127255, 150459 and two 2455
NOTE. No. 150460 is supplied with this machine unless No. 127193 ¹⁵⁰⁴⁶⁰ is specified on order.		
142033		
52187	2065	Balance Wheel (power, disc) 2 $\frac{3}{16}$ " pulley, with two 418c ...
5208T		" " (stand, heavy rim), 2 $\frac{1}{16}$ " pulley, with two 418c ...
52003	2029	" " Oil Cover ...
2404	1324	" " " " " Screw ...
448	1324	" " Set Screw ...
NOTE. No. 52187 is supplied with this machine unless otherwise specified on order.		
*52383		Bed ...
NOTE. Due to the accuracy required for gear alignment, Bed cannot be supplied separately and can only be sent out as a unit, Arm and Bed assembled.		
12431		Bed Slide ...
12432	2028	" " complete, Nos. 4307, 12431 and two 725c ...
4307	2028	" " Spring ...
725c	1324	" " " " " Screw ...
52051		Face Plate ...
176d	559	" " Screw ...
52053	2030	" " Thread Guard (lower) ...
226d	1324	" " " " " (") Screw ...
52170		" " " " " (upper) ...
226d	1324	" " " " " (") Screw ...
50190d	2035	" " Thumb Screw ...
52052	2028	Face Plate , complete, Nos. 52051, 52053, 52170 and two 226d ...
52452	2028	Feed Bar ...
313c	1324	" " Screw Centre (2) ...
1519c	2034	" " " " " Nut (2) ...
52165	2066	" Connecting Link ...
375c	1324	" " " " " Hinge Screw ...
1518c	2034	" " " " " " " Nut ...
52073	2032	" " " " " Stud ...
50083c	2035	" " " " " Set Screw ...
121416	2376	Feed Dog (spiked teeth) ...
50117c	2035	" " Screw (2) ...
127324	2373	Feed and Feed Lifting Eccentric with 52210, 52211 and two 418al
127325		" " " " " 127324 with 127152 ...
52210	1503	" " " " " Lubricating Pad (wood, long)
52211	1503	" " " " " " " (" short)
448al	1324	" " " " " Set Screw ...
127152	2066	" " " " " Sleeve ...

No.	Plate						
52407	2029	Feed Forked Connection
52451	---	"	"	"	52407 with 375c, 1518c and 52165
375c	1324	"	"	"	Hinge Screw
1518c	2034	"	"	"	" " Nut
52384	2029	Feed Lifting Rock Shaft
127156	2065	"	"	"	Connecting Rod with 127157 and two 966c
*127157	---	"	"	"	" " Cap
966c	2035	"	"	"	" " Screw
375c	1324	"	"	"	" " Hinge Screw
1518c	2034	"	"	"	" " " " Nut
52434	1502	"	"	"	Crank with 157c and 1813
157c	1324	"	"	"	" Clamping Screw
1813	2034	"	"	"	" Roller and Stud
50191c	2034	"	"	"	Screw Centre (2)
1513j	1317	"	"	"	" " Nut (2)
52433	---	Feed Lifting Rock Shaft, complete, Nos. 52384 and 52434
50338e	2031	Feed Regulating Screw Stud
56032	1502	"	"	"	Head with 56033
50193j	2035	"	"	"	" Cap Screw
56033	1503	"	"	"	" Stop Pin
56034	1502	"	"	"	" Lock Pin
56035	1502	"	"	"	" " Spring
52408	1502	Feed Regulator with 50083c
52411	---	"	"	"	52408 with 52073
1128e	2035	"	"	"	Hinge Screw
52409	1502	Feed Reverse Lever with 158c and 51846
50339d	2031	"	"	"	Hinge Screw
158c	1324	"	"	"	" Clamping Screw
52410	1502	"	"	"	" Friction Washer
51846	2034	"	"	"	" Roller and Stud
52386	2029	Feed Rock Shaft
29633	2032	"	"	"	Crank with 157c
142033	---	Machine Pulley (disc "V" belt groove (outside diam. of belt groove 2-9"), with two 435al
52081	---	Machine Pulley (stand, heavy rim), 2 $\frac{11}{16}$ " pulley, with two 448c	386	...
52063	2029	Machine Pulley Oil Cover
210d	1324	"	"	"	" " Screw
448c	1324	"	"	"	Set Screw for 52081
435al	1324	"	"	"	" " " " 142033

Note—No. 142033 is supplied with machine unless otherwise specified on order

No.	Plate						
127088	2040	Needle Bar (hollow)
127322	---	"	"	"	127088 with 229d, 52307 and 127323
127305	2373	"	"	"	Bushing (lower)
1133c	2035	"	"	"	" (")
52448	1503	"	"	"	" (upper)
1133c	2035	"	"	"	" (") Set Screw
52205	2066	"	"	"	Connecting Link with 52207
52206	---	"	"	"	" " 52205 with 24041
775c	2035	"	"	"	" Cap Screw
52207	---	"	"	"	" Lubricating Pad (wood)
24041	2066	"	"	"	Stud with 207 $\frac{1}{2}$ " F
207 $\frac{1}{2}$ "	1688	"	"	"	" Clamping Screw
127222	2373	"	"	"	Crank with 1036al, 1037al and 1065al
1065al	2035	"	"	"	" Position Screw
127323	---	"	"	"	Thread Guard
229d	2035	"	"	"	" Screw
52307	2039	"	"	"	Clamp with 51460f
51460f	2378	"	"	"	" Screw
*52201	2064	Oil Absorbent Wick
52202	2064	"	"	"	52201, with 52203, for lower cavity in head of arm
*52203	2040	"	"	"	" Wire
127191	---	Oil Tube, with 52184
127091	2040	"	"	"	Bracket
127092	---	"	"	"	127091, with 127191, for oiling 52165
52184	2064	"	"	"	Packing (cotton wick)
12391	2028	Presser Bar (hollow)
52338	1316	"	"	"	Guide Bracket with 223c and 453c
453c	1316	"	"	"	" Set Screw
5990	1503	"	"	"	Litter
689c	1316	"	"	"	" Screw
1520r	1317	"	"	"	" Nut
12327	1316	"	"	"	Lifting and Releasing Lever Bracket
127108	2029	"	"	"	Spring
11170	1316	"	"	"	" Washer
7298	2032	Presser Foot Hinge Pin
52437	---	"	"	"	Plate
52438	---	"	"	"	Shank
26231	2032	"	"	"	Spring
52439	1502	Presser Foot (spring hinged), complete, Nos. 7298, 26231, 52437 and 52438
190d	1324	"	"	"	" Screw
688j	1324	Pressure Regulating Thumb Screw

No.	Plate			
127095	2039	144828	Rotating Hook with three 1253c	...
127096	2039	144829	" " 127095 with 127102 and four 1053e	...
*127239	2032	144830	" " 127096 with 40274, 127242 and three 1367d	...
127097	2032	144831	" " 127096 with 40274 and three 1367d (for agents only)	...
127240	2032	144832	" " 127239 with 52237	...
40264	2032		Bobbin	...
52235	2032		" Case	...
52236	2032		" " 52235 with 5911, 1380d and 40394	...
40393	2032		" " Hinge, Nos. 2974, 40392 and 125320	...
127242	2378	143346	" " " " Holder	...
52018	2032		" " " " Position Bracket	...
704j	1324		" " " " " Screw	...
40392	2032		" " " " Latch	...
125320	2066		" " " " " Lever	...
2974	2032		" " " " " Fulcrum Pin	...
2975	2032		" " " " " Spring	...
592e	1324		" " " " " Stop Screw	...
5911	1324		" " " " " Tension Regulating Screw	...
40394	2032		" " " " " Spring	...
1380d	2035		" " " " " Screw	...
52237	2032		" " " " " complete, Nos. 592e, 2975, 40393 and 52236	...
127241	2032	143445	" " " " 52237 with 127242 (for agents only)	...
40274	2032		" " Section	...
1367d	2035		" " Screw	...
1253e	2035		" " Set Screw	...
127059	2065		" " Shaft	...
127073	2039		" " Bevel Gear with two 1259e	...
127007	2029		" " " " Case (two pieces) with 121e and 50234d	...
50234d	2035		" " " " Plug Screw	...
121e	1324		" " " " Screw	...
1259e	2035		" " " " Set Screw	...
127004	2039		" " Bushing (back)	...
127043	2032		" " (") 127004 with 52045	...
52045	2032		" " (") Packing (cotton)	...
1143c	2035		" " (") Set Screw	...
127005	2039		" " (front)	...
127044	2032		" " (") 127005 with 52045	...
142008	2373		" " (") Oil Cup	...
52045	2032		" " (") Packing (cotton)	...
1148e	2032		" " (") Set Screw	...
144828	—		Rotating Hook with three 1253c	...
144829	—		Rotating Hook 144828 with 270083 and four 1053e	...
144830	—		Rotating Hook 144829 with 40274, 143346 and three 1367e	...
144832	—		Rotating Hook 144830 with 52237	...
144831	—		Rotating Hook 144829 with 40274 and three 1367e (for agents only)	...

No.	Plate			
52337	1316		Slack Thread Regulator	...
223e	1316		" " " " Set Screw	...
2102	2032		Tension Disc	...
1560c	2034		" Regulating Thumb Nut	...
32572	2032		" Releasing Disc	...
52145	1503		" " Lever	...
12398	1316		" " " Hinge Pin	...
12329	1316		" " " Spring	...
32574	2032		" " " Pin	...
2103	2032		" Spring	...
*50304e	2034		" Stud	...
52098	2035		" " 50304e with 1560c	...
50305e	2035		" " Set Screw	...
52397	—		Tension, complete, Nos. 2103, 32572, 32574, 52083, 52098, 52394 and two 2102	...
52027	2032		Thread Guard (side of arm)	...
52454	2030		" Retainer	...
624e	2035		" " Set Screw	...
127289	—		Thread Take-up, complete, Nos. 11204, 52025 and 127291	...
127290	2373		Thread Take-up Crank	...
127291	2035		" " " 127290 with 775e and 52206	...
1037al	2035		" " " Position Screw	...
1036al	2035		" " " Set Screw	...
52022	1503		Thread Take-up Lever with 52130	...
52023	2039		" " " Hinge Pin	...
52024	2039		" " " Link	...
11204	2033		" " " Hinge Pin	...
435e	1324		" " " " Set Screw	...
52130	2032		" " " Thread Eyelet Bushing	...
52025	2032		Thread Take-up Lever, complete, Nos. 52022 to 52024	...
52394	2039		Thread Take-up Spring	...
52083	2032		" " " Regulator with 50305e	...
448e	1324		" " " " Set Screw	...
26605	1502		Throat Plate, large needle hole, for 121446	...
26606	1502		" " small " " " 121446	...
691f	1324		" " Screw (2)	...
NOTE No. 26605 is sent with this machine unless otherwise specified on order				
139622	—		Drip Pan with four 3/4" wire nails	...

No. Plate

PARTS COMPLETE
FOR
No. 96K45 MACHINE

**For Light, Medium and Heavy Clothing and other work in Cloth. Maximum
Stitch 5½ to the inch. Drop Feed. Vertical Trimmer. Knee Lifter.**

No. Plate
*127331 ~~Arm with two 50015~~

*NOTE -- Due to the accuracy required for gear alignment, Arm cannot be supplied
separately and can only be sent out as a unit, Arm and Bed assembled*

16532	2032	Arm Dowel Pin (2)
52182	2066	" Oil Tube, with 52184, for oiling 52205
52183	2064	" " " " 52184, " " 52024
52180	2066	" " " (long) with 52184, for oiling 52022
52185	2066	" " " (short) " 42367, " " 52022
142087		" " " with Hole Cover and Holder
142069	2545	" " " 142087, with 52150, for oiling 127072 and 127074
50015	2033	" " " for oiling 127058 (2)
52150	2039	" " " Packing (braided cotton) for 142069
42367	2064	" " " " (" ") " 52185
52184	2064	" " " " (cotton wick) for 52180, 52182, 52183, and 127194
116e	1324	" Screw (back) (2)
851e	2035	" " (front) (2)
127024	2374	Arm Shaft (horizontal)
88619		" " (") 127024 with 127223
127072	2039	" " (") Bevel Gear with two 1036c
127070	2029	" " (") " " Case (two pieces) with 121e
121e	1324	" " (") " " " Screw
1036c	2035	" " (") " " Set Screw
52191	2040	" " (") Flanged Bushing (back)
52192		" " (") " " (") 52191 with 52193 and 52194
52193	2040	" " (") " " (") Oil Pad (braided cotton)
52194	2064	" " (") " " (") Oil Pad (left)
446c	1324	" " (") " " (") Set Screw

No.	Plate				
52195	2040	Arm Shaft (horizontal) Flanged Bushing (front) ...			
52196	-	" " (") " " (") 52195 with			
		52193 and 52194			
52193	2040	" " (") " " (") Oil Pad			
		(braided cotton)			
52194	2064	" " (") " " (") Oil Pad (felt)			
435c	1324	" " (") " " (") Set Screw ...			
68350	2039	" " (") Front Bearing Oil Cup (spring lid) ...			
144d	1324	" " (") Screw ...			
127058	2028	" " (upright) ...			
127073	2039	" " (") Bevel Gear (lower) with two 1259e ...			
1259e	2035	" " (") " " (") Set Screw ...			
127074	2039	" " (") " " (upper) with two 1259e ...			
1259e	2035	" " (") " " (") Set Screw ...			
52492	2039	" " (") Bushing (lower) ...			
432c	1324	" " (") " " (") Set Screw ...			
52493	2039	" " (") " " (upper) ...			
435c	1324	" " (") " " (") Set Screw ...			
127146	2066	" Side Cap ...			
219d	1324	" " " Screw ...			
127079	2028	" " Cover ...			
50053d	2035	" " " Thumb Screw ...			
52239	2064	" Spool Pin and Thread Eyelet ...			
8879	1316	" " " Washer (cloth) ...			
127192	2064	Arm Top Cover ...			
127193	2064	" " " 127192 with 52183, 52239, 127187 and 127255			
52183	2064	" " " Oil Tube with 52184 ...			
52184	2064	" " " " " Packing (cotton wick) ...			
127187	2040	" " " " " (bent) with 42367 ...			
42367	2064	" " " Packing (braided cotton)			
127255	2378	" " " Positioning Disc ...			
158j	1324	" " " Screw ...			
150459	2064	" " " Tension Bracket with 460c ...			
52183	2064	" " " " " Oil Tube with 52184 ...			
52184	2064	" " " " " " " " " Packing (cotton wick)			
127187	2040	" " " " " " " " (bent) with 42367			
42367	2064	" " " " " " " " " Packing (braided cotton)			
158j	1324	" " " " " " " " Screw ...			
52239	2064	" " " " " " " " Spool Pin ...			
8879	1316	" " " " " " " " Washer (cloth) ...			
2455	1688	" " " " " " " " Disc ...			
41593	1316	" " " " " " " " Spring ...			
41594	1316	" " " " " " " " Stud ...			
460c	1324	" " " " " " " " Set Screw ...			
41595	1316	" " " " " " " " Thread Guide ...			

No.	Plate				
150460	2064	Arm Top Cover Tension Bracket , complete, Nos. 41593 to 41595, 52183, 52239, 127187, 127255, 150459 and two 2455			

NOTE No ~~150460~~ is supplied with this machine unless No. ~~127193~~ is specified on order ~~150460~~

52187	2065	Balance Wheel (power, disc) 2 3/16" pulley, with two 448c ...			
52063	2024	" " Oil Cover ...			
210d	1324	" " " " " Screw ...			
448c	1324	" " Set Screw ...			

*52383		Bed ...			
--------	--	----------------	--	--	--

NOTE Due to the accuracy required for gear alignment, Bed cannot be supplied separately and can only be sent out as a unit, Arm and Bed assembled

12431		Bed Slide ...			
12432	2028	" " complete, Nos. 4307, 12431 and two 725c ...			
4307	2028	" " Spring ...			
725c	1324	" " " " " Screw ...			

52102	2374	Face Plate ...			
176d	559	" " Screw (2) ...			
52053	2030	" " Thread Guard (lower) ...			
226d	1324	" " " " " (") Screw ...			
52170		" " " " " (upper) ...			
226d	1324	" " " " " (") Screw ...			
52103		Face Plate , complete, Nos. 52053, 52102, 52170 and two 226d ...			

52452	2028	Feed Bar ...			
313c	1324	" " Screw Centre (2) ...			
4519e	2034	" " " " " Nut (2) ...			
52165	2066	" Connecting Link ...			
375c	1324	" " " " " Hinge Screw ...			
4518c	2034	" " " " " " " Nut ...			
52073	2032	" " " " " " " Stud ...			
50083c	2035	" " " " " " " Set Screw ...			

127025	2376	Feed Dog , 9 teeth (12 teeth to the inch) ...			
50117c	2035	" " Screw (2) ...			

127224		Feed and Feed Lifting Eccentric with 448c, 52210 and 52211			
127226		" " " " " " 127224 with 127152 ...			
52210	1503	" " " " " " Lubricating Pad (wood, long)			
52211	1503	" " " " " " " " (" short)			
448c	1324	" " " " " " " Set Screw ...			
127152	2066	" " " " " " " Sleeve ...			

No.	Plate				
20284	2029	Feed Forked Connection			
52393	—	" "	" "	20284 with 375c, 1518e and 52165	...
375c	1324	" "	" "	Hinge Screw	...
1518e	2034	" "	" "	" " Nut	...
52384	2029	Feed Lifting Rock Shaft			
127156	2065	" "	" "	Connecting Rod with 127157 and two 966e	...
*127157	—	" "	" "	" " Cap	...
966e	2035	" "	" "	" " Screw	...
375c	1324	" "	" "	" " Hinge Screw	...
1518e	2034	" "	" "	" " " " Nut	...
12376	2032	" "	" "	Crank with 157c and 1813	...
157c	1324	" "	" "	" Clamping Screw	...
1813	2034	" "	" "	" Roller and Stud	...
50191c	2034	" "	" "	Screw Centre (2)	...
1513j	1317	" "	" "	" " Nut (2)	...
52385	—	Feed Lifting Rock Shaft, complete, Nos. 12376 and 52384			...
52074	2033	Feed Regulator with 50083c			...
52118	—	" "	" "	52074 with 52073	...
52093	—	" "	" "	52118 with 818d	...
1128e	2035	" "	" "	Hinge Screw	...
818d	2035	" "	" "	Thumb Screw	...
52386	2029	Feed Rock Shaft			
29633	2032	" "	" "	Crank with 157c	...
157c	1324	" "	" "	Clamping Screw	...
50191c	2034	" "	" "	Screw Centre (2)	...
1513j	1317	" "	" "	" " Nut (2)	...
52387	—	Feed Rock Shaft, complete, Nos. 29633 and 52386			...
127026	2377	Knife (narrow)			...
127027	2377	" (wide)			...
620c	2377	" Adjusting Screw			...
52104	2374	" Bar with 2301			...
24431	2377	" " Crank with 191c			...
1162c	2377	" " " Coupling Pin			...
1561d	2377	" " " " " Head			...
2297	2377	" " " " " Spring			...
2022	2033	" " " " " Pin			...
191c	—	" " " " " Set Screw			...
24432	—	" " " " " complete, Nos. 1162c, 1561d, 2297 and 24431			...
127028	2377	" " Driving Crank (forked)			...
16564	2377	" " " " " Bracket			...

No.	Plate				
127029	—	Knife Bar Driving Crank Bracket, complete, Nos. 2022, 16564, 24432 and 127028			...
647c	2377	" " " " " " Screw (2)			...
24122	2377	" " Lifting Spring			...
24123	2377	" " " " " Case			...
*24124	—	" " " " " Guide			...
24906	2377	" " " " " 24124 with 2523 and 24125			...
*24125	—	" " " " " Bracket			...
621j	2377	" " " " " " Screw			...
2523	2377	" " " " " " Pin			...
2301	2377	" " Stop Pin			...
52107	—	Knife Bar, complete, Nos. 621j, 24109, 24906, 52104, 52108 and three 50117e			...
52108	2377	" Holder with 620c, 2291 and two 223j			...
24109	2377	" " Handle			...
50117e	2035	" " " " " Screw			...
50117e	2035	" " " " " Screw			...
223j	1316	" " " " " Screw			...
2291	2377	" " Washer			...
127135	2373	Needle Bar (hollow) with 140239al			...
127137	—	" " 127135 with 127136			...
52200	2373	" " Bushing (lower)			...
1133c	2035	" " " (") Set Screw			...
52111	2373	" " " " (upper)			...
1133c	2035	" " " " (") Set Screw			...
52205	2066	" " Connecting Link with 52207			...
52206	—	" " " " " 52205 with 24041			...
775c	2035	" " " " " Cap Screw			...
52207	—	" " " " " Lubricating Pad (wood)			...
24041	2066	" " " " " Stud with 207 $\frac{1}{8}$ F			...
207 $\frac{1}{8}$ F	1688	" " " " " Clamping Screw			...
127223	2373	" " Crank (eccentric) with 1036al, 1037al and 1065al			...
127032	2373	" " " (") Sleeve			...
1065al	2035	" " " " " Position Screw			...
127136	2378	" " Thread Guide			...
140239al	2378	" Set Screw			...
*52201	2064	Oil Absorbent Wick			...
52202	2064	" " " 52201, with 52203, for lower cavity in head of arm			...
*52203	2040	" " " " " Wire			...
142033	—	Machine Pulley (disc) "V" belt groove (outside diam. of belt groove 2-9"), with two 435al			...
52063	2029	Machine Pulley Oil Cover			...
210d	1324	" " " " " " L, for oiling 52165			...
435al	1324	" " " " " " Screw			9
		" " " " " " Set Screw			...

No.	Plate	
12391	2028	Presser Bar (hollow) ...
52338	1316	" " Guide Bracket with 223c and 453c ...
453c	1316	" " " " Set Screw ...
52016	1316	" " Lifter ...
689c	1316	" " " Screw ...
1520r	1317	" " " Nut ...
12327	1316	" " Lifting and Releasing Lever Bracket ...
127108	2029	" " Spring ...
11170	1316	" " " Washer ...

127033	2376	Presser Foot for $\frac{1}{16}$ " to $\frac{1}{4}$ " gauges ...
127034	2376	" " " $\frac{3}{16}$ " gauge and above ...
190d	1324	" " Screw ...

NOTE ---No. 127033, $\frac{1}{16}$ " gauge and No. 127034, $\frac{3}{16}$ " gauge, are sent with machine unless other gauges are specified on order.

50373w	2378	Pressure Regulating Thumb Screw ...
--------	------	--

127095	2039	Rotating Hook with three 1253c ...
127096	2039	" " 127095 with 127102 and four 1053c ...
127239	2039	" " 127096 " 40274, 127242 and three 1367d ...
127097	2039	" " 127096 " 40274 and three 1367d (for agents only)
127240	2032	" " 127239 with 52237 ...
40264	2032	" " Bobbin ...
52235	2032	" " " Case ...
52236	2032	" " " 52235 with 5911, 1380d and 10394 ...
40393	2032	" " " Hinge Nos. 2974, 10392 and 125320 ...
127242	2378	" " " Holder ...
52018	2032	" " " " Position Bracket ...
704j	1324	" " " " " Screw ...
40392	2032	" " " " Latch ...
125320	2066	" " " " Lever ...
2974	2032	" " " " Fulcrum Pin ...
2975	2032	" " " " Spring ...
592c	1324	" " " " Stop Screw ...
591f	1324	" " " " Tension Regulating Screw ...
40394	2032	" " " " Spring ...
1380d	2035	" " " " " Screw ...
52237	2032	" " " " complete, Nos. 592c, 2975, 10393 and 52236 ...
127241	2032	" " " " 52237 with 127242 (for agents only) ...
40274	2032	" " " Section ...
1367d	2035	" " " Screw ...
1253c	2035	" " " Set Screw ...

144828	---	Rotating Hook with
144829	---	Rotating Hook 144
144830	---	Rotating Hook 144 1367e ...
144832	---	Rotating Hook 144
144831	---	Rotating Hook 144 (for agents only)

No.	Plate	
127007	2029	Rotating Hook Shaft Bevel Gear Case (two pieces) with 121e and 50234d ...
50234d	2035	" " " " " " Plug Screw ...
121e	1324	" " " " " " Screw ...
1259c	2035	" " " " " " Set Screw ...
127004	2039	" " " " Bushing (back) ...
127043	2032	" " " " " (") 127004 with 52045 ...
52045	2032	" " " " " (") Packing (cotton) ...
1143c	2035	" " " " " (") Set Screw ...
127005	2039	" " " " " (front) ...
127044	2032	" " " " " (") 127005 with 52045 ...
142008	2373	" " " " " (") Oil Cup ...
52045	2032	" " " " " (") Packing (cotton) ...
1148c	2035	" " " " " (") Set Screw ...
127102	2039	" " " " Thread Guard ...
1053c	2035	" " " " " Screw ...

270013

52115	2378	Slack Thread Regulator ...
223c	1316	" " " " Set Screw ...

2102	2032	Tension Disc ...
1560c	2034	" " Regulating Thumb Nut ...
32572	2032	" " Releasing Disc ...
43944	1316	" " " Lever ...
12398	1316	" " " " Hinge Pin ...
12329	1316	" " " " Spring ...
32574	2032	" " " " Pin ...
2103	2032	" " Spring ...
*50304c	2034	" " Stud ...
52098	2035	" " " 50304c with 1560c ...
50305c	2035	" " " Set Screw ...
52397	2035	Tension, complete, Nos. 2103, 32572, 32574, 52083, 52098, 52394 and two 2102 ...

52027	2032	Thread Guard (side of arm) ...
52454	2030	" " Retainer ...
624c	2035	" " " Set Screw ...
52208	2035	Thread Take-up, complete, Nos. 11204, 52025 and 52209 ...

52021	2035	Thread Take-up Crank ...
52209	2035	" " " 52021 with 775c and 52206 ...
1037ad	2035	" " " " Position Screw ...
1036ad	2035	" " " " Set Screw ...

No. 96K45 MACHINE PARTS

No.	Plate						
52022	1503	Thread Take-up Lever with 52130
52023	2039	" " " Hinge Pin
52024	2039	" " " Link
11204	2033	" " " " Hinge Pin
435c	1324	" " " " " " Set Screw
52130	-	" " " Thread Eyelet Bushing
52025	-	Thread Take-up Lever , complete, Nos. 52022 to 52024
52394	2039	Thread Take-up Spring
52083	2032	" " " Regulator with 50305c
448c	1324	" " " " Set Screw
5729	-	Throat Plate Body
†142032	2376	" " Cutting Bar for 127036
†52131	2376	" " " " " 127040
578d	2376	" " " " Screw
127035	2376	" " Slide
578d	2376	" " " Adjusting Screw
†127036	2376	Throat Plate (small needle hole), complete, Nos. 5729, 127035, 142032 and three 578d, for 127025

NOTE -- No. 127036, $\frac{1}{8}$ " gauge, is sent with this machine unless another gauge is specified on order and an additional Cutting Bar No. 142032, $\frac{3}{16}$ " gauge is also sent with machine.

†127040	2376	Throat Plate (large needle hole), complete, Nos. 5729, 52131, 127035 and three 578d, for 127025
691f	1324	Throat Plate Screw
139622	—	Drip Pan with four $\frac{3}{4}$ " wire nails

†NOTE. When ordering state required distance of trimmed edge from seam.

Iron Base

No.	Plate						
19219	2033	Bed Frame Cushion (leather)
158c	1324	" " " Screw
19220	2033	" " " Spring
19226	2039	" " Hinge Connection
19398		" " " " 19226 with 211f and 19397
19397	2033	" " " " Cap
211f	2035	" " " " Screw
16555	2033	" " " Plate
14010	2033	" " " " Rivet
20067	1513	Bed Frame with two each 16555, 19398, four each 19219, 19220, six each 14010, wood screws $1\frac{1}{4}$ " No. 12, and eight 158c

Tape Holder

(8 IN. DISC)

FOR 96K43 MACHINE

No.	Plate						
26061	7708	Bracket Wire with disc
26062	7708	Disc (adjustable) with 35925 and 50053d
35925		" Hub
50053d	2035	" Thumb Screw
26063	7708	Tape Holder (straight), 8" disc, complete, Nos. 26061 and 26062
190d	1324	" " " Set Screw

Accessories

No.	Plate						
40264	2032	Fobbin (2)
12361	2039	Machine Hinge Connection (2)
36569	2031	Oiler
25537	2031	Screw Driver (large)
120378	2031	" " (small)
8908		Wrench for 96K45 Machine
8909		" " 96K45 "
		Screw (wood), $\frac{1}{2}$ " No. 5, for 96K45 Machine (4)

Bobbin Winders

BOBBIN WINDER (swinging automatic, left hand) for 40264

No.	Plate	
41913	2007	Bracket with 457c
41583	2007	Frame with 457c
34105	2007	" Hinge Pin
457c	1324	" " " Set Screw
41914	2007	" Spring
41585	2007	Pulley with 171d
171d	1324	" Set Screw
41586	2007	Spindle
41587	2007	Stop Latch
42614	2007	" " Hinge Stud
457c	1324	" " " " Set Screw
7958	2032	" " Stop Pin
41588	2007	" " Tripping Arm with 185h
185h	1324	" " " " Clamping Screw
60845	2007	Bobbin Winder, Nos. 7958, 34105, 41583, 41585 to 41588, 41913, 41914 and 42614
41915	—	Bobbin Winder, complete, Nos. 880e, 25446 and 60845
880e	2035	" " Screw
25446	2033	" " Washer

This Bobbin Winder is sent with machine unless otherwise specified on order.

BOBBIN WINDER (swinging automatic, right hand) for use with Individual Motor.

Update 10-55

(Arm Top Cover Tension Bracket No. 127193 is supplied in place of No. 150160 when this Bobbin Winder is fitted to machine.

No.	Plate	
41339	1687	Base
41340	1687	Frame
1429d	1688	" Hinge Screw
41341	1687	" Spring
207d	1688	" " Screw
41342	1687	Pulley with 200f
200f	1688	" Set Screw
41343	1688	Spindle
27306	1688	Spool Pin
27307	1687	" Stand
†27308	1687	" " complete, Nos. 418e, 1562j, 2106, 40141, 41241, 27306, 27307, two each 2455 and wood screws 1" No. 10
41241	1687	Spool Washer (cloth)
41344	1688	Stop Latch
41345	1688	" " Finger
152f	1688	" " " Screw
1430d	1688	" " Hinge Screw
1550h	1688	" " " " Nut
41346	1688	" " Lever
1430d	1688	" " " Hinge Screw
2455	1688	Tension Disc
1562j	1688	" Regulating Thumb Nut
418e	1688	" Screw Stud
10141	1688	" Spring
2106	1688	" Thread Guide
60456	—	Bobbin Winder, Nos. 152f, 207d, 1429d, 1550h, 41339 to 41346, and three 1430d
41347	1687	Bobbin Winder, 60456, with two each 9331 and wood screws 1" No. 10 R.H.B.
41348	—	Bobbin Winder (swinging automatic, right hand), complete, Nos. 27308 and 41347
—	—	Bobbin Winder Screw (wood) 1" No. 10 R.H.B.
9331	1688	" " " Washer

†As No. 27308 can be supplied either Plated or Japanned, it is necessary, when ordering, to state which is required.

BOBBIN WINDER (swinging automatic, right hand)

for machines when used on Power Table.

Date 10-55

(Arm Top Cover Tension Bracket No. 127193 is supplied in place of No. 150160 when this Bobbin Winder is fitted to machine.)

No.	Plate	
225433	10885	Bobbin Winder and Tension Bracket Base
225453	10884	Frame with 202277 and 259660
225454	10884	" Hinge Pin
202277	"	" Oil Packing (wick)
259660	"	" " Well Washer
225455	10884	" Spring
225456	10884	" " Plunger
202473	10885	Pulley with 200380c
200380c	"	" Set Screw
225381	10884	Spindle
225444	10884	Stop Latch
200056e	10884	" " Screw
225458	10884	" " Thumb Lever
225459	10884	" " " " Hinge Stud
225459	10884	" " " " Joint Stud
202478	10884	" " Trip Lever
200299h	10884	" " " " Hinge Screw
225461	10881	Tension Bracket with 201499j
200082d	10881	" " Screw
228026	10884	" " " Washer
2102	2032	" Disc
13710	"	" Spring
201499j	10881	" Stud
201572j	10881	" " Thumb Nut
225462	10881	Tension Bracket, complete, Nos. 13710, 201572j, 225461 and two 2102
225382	10885	Bobbin Winder , complete, Nos. 200056e, 200082d, 200299h, 202473, 202478, 225381, 225433, 225444, 225453 to 225456, 225458, 225462, 228026, two each 225459 and wood screw $\frac{3}{4}$ " No. 12 R.H.B.

Attachments

When ordering Binders send sample of the binding and of the material to be bound.

BINDER for Cap Peak Work

No.	Plate	
85678	559	Feed Dog
85459	559	Folder Base
85460	559	" (top)
207d	1688	" (") Binding Screw
85461	"	" (bottom)
SS50d	186	" (") Binding Screw
85462	559	" Roller Guide, Nos. 701d, 85463 and 85464
SS50d	186	" " " Binding Screw
85463	"	" " " Bracket
85464	"	" " " Roller
701d	1324	" " " " Screw
176d	559	" Screw (to fasten to machine)
85325	186	" " Washer
85458	559	Folder, complete, Nos. 85459 to 85462, two 207d and four SS50d
85679	559	Presser Foot
85680	559	Throat Plate
85681	559	Binder , complete, Nos. 85458, 85678 to 85680, two each 176d and 85325

BINDER for Cardigan Jackets

No.	Plate	
85682	558	Feed Dog
85336	"	Folder Base
85337	"	" Folding Plate (top)
85338	"	" " " (bottom)
233d	1324	" " " Screw for 85337 and 85338
SS50d	186	" Screw
85325	186	" " Washer
85335	"	Folder, complete, Nos. 85336 to 85338 and four 233d

No.	Plate	
85683	558	Presser Foot
85324		Tape Tension Pin (bent)
85323		" " " (straight)
85340		" " Plate
85339	558	" " complete, Nos. 85324, 85340 and four 85323
207d	1688	" " Screw
85325	186	" " " Washer
85684	558	Throat Plate
85685	558	Binder , complete, Nos. SS50d, 207d, 85335, 85339, 85682 to 85684 and two 85325

BINDER, $\frac{1}{2}$ ", for General Work

No.	Plate	
85686	558	Feed Dog
85320	558	Folder
SS50d	186	" Screw
85325	186	" " Washer
85687		Presser Foot Bracket
85688		" " " Hinge Pin
85689		" " Sole
85690	558	" " (hinged), complete, Nos. 85687 to 85689
85324		Tape Tension Pin (bent)
85323		" " " (straight)
85322		" " Plate
85321	557	" " complete, Nos. 85322, 85324 and eight 85323
SS50d	186	" " Screw
85325	186	" " " Washer
85691	558	Throat Plate
85692	558	Binder , complete, Nos. 85320, 85321, 85686, 85690, 85691, two each SS50d and 85325

BINDER, $\frac{1}{2}$ ", for Stay Work

No.	Plate	
85693	557	Feed Dog
85614		Folder
SS65d	1324	" Screw
85694		Presser Foot Bracket
85616		" " " Hinge Pin
85695		" " Sole
85696	557	" " (hinged), complete, Nos. 85616, 85694 and 85695
85324		Tape Tension Pin (bent)
85323		" " " (straight)
85322		" " Plate
85321	557	" " complete, Nos. 85322, 85324 and eight 85323
SS50d	186	" " Screw
85325	186	" " " Washer
85697	557	Throat Plate
85698	557	Binder , complete, Nos. SS50d, SS65d, 85321, 85325, 85614, 85693, 85696 and 85697

BINDER, $\frac{1}{2}$ ", for Stay Work

No.	Plate	
85699	186	Base
85597	186	Binder
85324		Tape Tension Pin (bent)
85323		" " " (straight)
85700	186	Binder and Tension only, complete, Nos. 85324, 85597, 85699 and nine 85323
SS50d	186	" Screw
85325	186	" " Washer
85701	186	Feed Dog
85702		Presser Foot Bracket
85703		" " " Hinge Pin
85704		" " Sole
85705	186	" " (hinged), complete, Nos. 85702 to 85704
85706	186	Throat Plate
85707	186	Binder , complete, Nos. SS50d, 85325, 85700, 85701, 85705 and 85706

ATTACHMENTS

BINDER, $\frac{3}{16}$ " , for Stay Work

No.	Plate								
85711	187	Base
85603	187	Binder
85604	187	Folder
207d	1688	" Screw
85325	186	" " Washer
85605	187	Tape Guide
85606	187	" " Bracket
207d	1688	" " " Screw
85325	186	" " " Washer
207d	1688	" " " Screw
85325	186	" " " Washer
85607	..	" Tension Pin
85712	187	Binder, Folder and Tension only, complete, Nos. 85603 to 85606, 85711, three each 207d, 85325 and seven 85607
SS50d	186	Binder Screw
85325	186	" " Washer
85701	186	Feed Dog
85702	..	Presser Foot Bracket
85703	..	" " " Hinge Pin
85704	..	" " " Sole
85705	186	" " (hinged), complete, Nos. 85702 to 85704
85706	186	Throat Plate
85713	187	Binder , complete, Nos. SS50d, 85325, 85701, 85705, 85706 and 85712

CORDER (bowl), for Top Cording

No.	Plate								
85868	201	Corder Bow
85869	201	Presser Foot
759d	1324	" " Thumb Screw
85870	201	Corder (bowl) , complete, Nos. 759d, 85868 and 85869

ATTACHMENTS

CORDER, for Top Cording

No.	Plate								
85783		Base
85871		Guide Finger with 85411, 85872 and two 85416
SS28b	1324	" " Adjusting Screw
85411		" " Eyelet
85413		" " Hinge Pin
879d	2035	" " Locking Thumb Screw
85872		" " Tip
85416		" " " Rivet
85873	1320	Corder only , complete, Nos. SS28b, 879d, 85413, 85783 and 85871
85874	1320	Presser Foot
85875	1320	Corder , complete, Nos. SS41d, 85412, 85873 and 85874
SS41d	1320	" Screw (to fasten to machine)
85412	1320	" " Washer

CORDER GUIDE (Adjustable)

No.	Plate								
85382		Extension Guide
228d	1324	" " Screw
85876		Presser Foot
85877	562	Corder Guide , complete, Nos. 228d, 85382 and 85876
85881	562	Cording and Hemming Foot
86182	562	Cording Foot (grooved on right side)

CRIMPING SET

No.	Plate								
85882	557	Feed Dog
85883		Presser Foot
85391		" " Spring
219d	1324	" " " Screw
85884	557	" " complete, Nos. 219d, 85391 and 85883
85885	557	Throat Plate
85886	557	Crimping Set , complete, Nos. 85882, 85884 and 85885

FELLING FEET

No.	Plate	
85896	201	Felling Foot, $\frac{3}{16}$ " fell
85897	562	" " (steel), $\frac{3}{16}$ " fell

FINGER GUARD

No.	Plate	
86417	1510	Finger Guard
102d	1324	" " Binding Screw
86478	1510	" " Bracket with 207f
207f	1688	" " " Screw
86479	1510	Finger Guard , complete, Nos. 102d, 86417 and 86478

GATHERING FEET

No.	Plate	
85955	562	Gathering Foot
86193	2545	" " (slotted)

HEMMERS

When ordering Hemmers state width of hem in addition to the part number

No.	Plate	
86005	88	Hemmer ($\frac{3}{16}$ " to $\frac{7}{8}$ ", in grades of $\frac{1}{16}$ ")
86008	88	" (1" to 1 $\frac{1}{4}$ ", in grades of $\frac{1}{4}$ ")
86010	88	" (1 $\frac{3}{8}$ " and 1 $\frac{1}{2}$ ")
85447	88	" Base with SS54e
SS54e	1324	" " Stud Screw
NN40d	88	" " " " Thumb Nut
85448	88	" " " " " Washer
85446		Hemmer Base , complete, Nos. NN40d, 85447 and 85448

HEMMER FEET

No.	Plate	
86025	562	$\frac{1}{16}$ " to $\frac{9}{32}$ " hem, in grades of $\frac{1}{32}$ "
86537		$\frac{1}{16}$ " flat sole
86538		$\frac{3}{32}$ " " " "
86539	1931	$\frac{1}{8}$ " " " "
86540		$\frac{5}{32}$ " " " "
86541		$\frac{3}{16}$ " " " "
86542		$\frac{7}{32}$ " " " "
86543		$\frac{1}{4}$ " " " "

HEMMER FEET—Contd.

No.	Plate	
86544		$\frac{1}{16}$ " flat sole, with groove
86545		$\frac{3}{32}$ " " " " "
86546	1931	$\frac{1}{8}$ " " " " "
86547		$\frac{5}{32}$ " " " " "
86548		$\frac{3}{16}$ " " " " "
86549		$\frac{7}{32}$ " " " " "
86550		$\frac{1}{4}$ " " " " "

PRESSER FOOT

No.	Plate	
86188	958	Presser Foot (narrow) for narrow tucking

QUILTER

No.	Plate	
86041	958	Clamp with 207d
207d	1688	" Screw
86042	958	Rod
86043	958	Quilter , complete, Nos. 86041 and 86042

TUCKERS (long arm)

No.	Plate	
36387	1315	Space Guide
35510	1315	" " Base with 35512, 35514 and two 1426e
102d	1317	" " " Screw
35511	1317	" " Indicator
35512	1317	" " Pin
35513	1317	" " Stop (left)
35514	1317	" " " (") Guide Pin
1426e	1317	" " " (") Screw Stud
1657d	1317	" " " (") Thumb Nut
17718	1317	" " " (") " " Washer
35515	1317	" " " (right)
1126e	1317	" " " (") Screw Stud
1657d	1317	" " " (") Thumb Nut
17718	1317	" " " (") " " Washer
50053d	2035	" " Thumb Screw
36388		Space Guide , complete, Nos. 35510, 35511, 35513, 35515, 36387, 50053d, two each 1657d and 17718

Knee Lifter

1507e — Rock Shaft Knee Plate Arm Bracket Position Nut S

No.	Plate						
5596	2028	Bell Crank
5598	2028	" "	5596 with 5599, 5601 and 5735
5599	2028	" "	Bracket
178e	1324	" "	" Screw
5601	2032	" "	Hinge Pin
5735	2032	" "	Spring

12237	2379	Lifting Lever with 448c
52028	2029	" "	Connecting Rod
12416	1316	" "	" " Joint
76d	1324	" "	" " " Hinge Screw
1521e	2034	" "	" " Lock Nut
802d	2035	" "	Hinge Screw
12241	1316	" "	Link
766d	1324	" "	" Hinge Screw
12240	1316	" "	Pin
448c	1324	" "	" Set Screw

2763	2379	Rock Shaft
97502	1815	" "	Bracket
		" "	" Screw (wood) 1" No. 10
2765	2379	" "	Knee Arm
2768		" "	" " 2765 with 2766 and 2767
2766	2379	" "	" " Hub with 356c
356c	1324	" "	" " Set Screw
2767	2379	" "	" Plate with 356c
356c	1324	" "	" " Set Screw
6337	2379	" "	Lifting Bracket with two 356c
2778	2379	" "	" " Hook
356c	1324	" "	" " Set Screw
356c	1324	" "	" " Set Screw
2770	2379	" "	Stop Dog with 356c
356c	1324	" "	" " Set Screw

84789 2379 **Rock Shaft**, complete, Nos. 2763, 2768, 2770, 2778, 6337, two 97502 and four wood screws 1" No. 10

85246 — **Knee Lifter**, complete, Nos. 76d, 766d, 802d, 1521e, 5598, 12237, 12240, 12241, 12416, 52028, 84789 and two 178e

No.	Plate						
35517	1309	Tuck Guide Arm
1177d	1317	" " Screw
35518	1309	" " Base
50134c	1317	" " Screw Stud
36389	1309	" " Bracket
307c	1317	" " Screw Centre
1513j	1317	" " " Nut
36390	1317	" " Spring
36391	1315	" " Plate
9d	1317	" " Screw
423c	1317	" " Stop Screw
1520r	1317	" " " Nut
36392	1309	" " Frame
36393	1317	" " Spring
1510e	1317	" " " Nut
35524	1317	" " Washer
803c	1317	" " Stop Screw
1520r	1317	" " " Nut
35511	1317	" " Indicator
35525	1309	" " Plate
1115f	1317	" " Screw

36394 Tuck Guide, complete, Nos. 9d, 423c, 803c, 1510e, 35511, 35517, 35518, 35524, 35525, 36389 to 36393, 50134c, two each 307c, 1115f, 1177d, 1513j, 1520r and three wood screws 1 1/4" No. 10

36395 **Tucker** (long arm), complete, 35528, 36388, 36394 and two 402d

52031 967 Feed Dog for shirt work

35528 1510 Presser Foot (wide) for 36395

40322 1510 " " (narrow) for 36395

36654 1510 " " for tucking shirt bosoms, for 36670

52032 Throat Plate, large needle hole, for 52031

52033 967 " " small " " " 52031

36670 **Tucker** (long arm), complete, for tango tucking, Nos. 36388, 36394, 36654 and two 402d

Knife Grinder

FOR 96K45 MACHINE

for Nos. 127026 and 127027

No.	Plate						
27565	2380	Emery Wheel, 2" diam.
1508j	22214	" " Clamping Nut
27822	22214	" " " " Washer
27567	22214	" " Shaft
60934		" " " 27567 with 1508j, 27565, 27569 and 27822
27568	22214	" " " Oil Hole Cover (rubber)
27569	22214	" " " Pulley
310k	22214	" " " Screw Centre
1516j	22214	" " " " " Nut
27564	2380	Frame with 27574
899j	2214	Knife Clamping Screw
126304	—	" Holder Body
126305	22214	Knife Holder, complete, Nos. 899j, 27660 and 126304
27323	22214	" " Guide Bar
27572	2380	" " " " Bracket with 27574
310k	22214	" " " " " Screw Centre
1516j	22214	" " " " " " Nut
27573	22214	" " " " " Spring
27574	22214	" " " " " Hook
27659	22214	" " Stop Collar with 237k
237k	22214	" " " " Set Screw
27660		" Position Pin
261j	22214	" Regulating Thumb Screw
27662	2380	Wrench for 1508 and 1516
60583		Knife Grinder, Nos. 261j, 27323, 27564, 27572, 27573, 27659, 60934, two 27568, four each 310k and 1516j
126306		Knife Grinder, complete, Nos. 27662, 60583, 126305 and three wood screws 1" No. 10

Knee Lifter

FOR 96K45 MACHINE

1507e

No.	Plate	Rock Shaft	Knee Plate	Arm	Bracket	Position	Nut
5596	2028	Bell Crank
62919		" " 5596 with 5601 and 62920
62920	2648	" " Bracket
178e	1324	" " " Screw
5601	2032	" " Hinge Pin
5735	2032	" " Spring
62921		" " complete, Nos. 5735 and 62919
20340	2648	Lifting Lever with 448c
12415	2648	" " Connecting Rod
12416	1316	" " " " " Joint
76d	1324	" " " " " Hinge Screw
1521e	2034	" " " " " Lock Nut
802d	2035	" " Hinge Screw
12241	1316	" " Link
766d	1324	" " " " " Hinge Screw
16586	2648	" " Pin
448c	1324	" " " " " Set Screw
2763	2379	Rock Shaft
139633		" " 2763 with 2770, 6337 and 139623
97502	1815	" " Bracket
2765	2379	" " " " " Screw (wood) 1" No. 10	
2768		" " " " " 2765 with 2766 and 2767	
2766	2379	" " " " " Hub with 356c	
356c	1324	" " " " " " Set Screw	
2767	2379	" " " " " Plate with 356c	
356c	1324	" " " " " " Set Screw	
6337	2379	" " Lifting Bracket with two 356c	
139623	2648	" " " " " Hook	
356c	1324	" " " " " " Set Screw	
356c	1324	" " " " " " Set Screw	
2770	2379	" " Stop Dog with 356c	
356c	1324	" " " " " " Set Screw	
93815		" " complete, Nos. 2768, 139633, two 97502 and four wood screws 1" No. 10	
88620		Knee Lifter, complete, Nos. 76d, 766d, 802d, 1521e, 12241, 12415, 12416, 16586, 20340, 62921, 93815 and two 178e	

Thread Unwinder

FOR TWO SPOOLS OF THREAD

No.	Plate							
228692	1503	Spool Pin
201528h	1503	" " Nut
82538	1503	" " Washer
225257	1621	" Rest with 201018c, two each 82538, 201528h and 228692						
150203		" " Cushion (felt)
225388	1621	" " Rod
200383c	2034	" " " Set Screw
201018c	2034	" " Set Screw
202490	1621	" Stand with 200383c
225391	1621	Thread Guide
201696j	2034	" " Lock Nut
225326		" " Position Cup
225324	1621	" " " Rod with 208e and 225322
208e	2035	" " " Screw
225322		" " " Washer
225258	1621	Thread Unwinder , complete, Nos. 201696j, 202490, 225257, 225324, 225326, 225388, two each 150203, 225391 and three wood screws $\frac{1}{8}$ " No. 12
27739		Thread Cone (wood) for large cones
225390		" " Holder for inverted cones

NOTE: - Nos. 27739 and 225390 are used with, but not included in 225258.