

SINGER
175-60

Form 19235, Revised
(741)
Printed in U. S. A.

LIST OF PARTS



MACHINE No. 175-60

** A TRADE MARK OF
THE SINGER MANUFACTURING COMPANY

INSTRUCTIONS FOR OILING

To ensure easy running and prevent unnecessary wear of the parts which are in movable contact, the machine requires oiling and when in continuous use, "TYPE B" or "TYPE D" OIL, sold only by Singer Sewing Machine Company, should be applied at least twice each day to all oil holes marked "OIL", as instructed in Form 19155.

"TYPE D" OIL is stainless.

INDEX

	Page
Accessories.....	29
Belt and Pulley Guard.....	30
Button Clamps.....	18 to 26
Button Holders.....	27
Feed Plates.....	27
Machine Base.....	30
Machine No. 175-60.....	7
Numerical List of Parts.....	33
Stay Button Holders.....	28
Starting Lever and Foot Lifter Parts.....	31
Table Belt Guide.....	31
Thread Unwinder.....	32
Work Supports.....	29

Copyright, U. S. A., 1935, 1936, 1938 and 1941

by The Singer Manufacturing Co.

All Rights Reserved for all Countries

INSTRUCTIONS FOR ORDERING

In ordering from this list, use ONLY the part NUMBER in the FIRST column.

The number stamped on a Sewing Machine Part is in every case the number of the single part only.

Every combination of parts sent out as such has its specific number, which, although not stamped on the parts, must be used when ordering the combination.

Each number always indicates the SAME PART in whatever list it appears, or for whatever machine.

The letters after some of the numbers indicate the style of finish only, as follows:

- A-Hardened, Polished, Nickel Plated and Buffed
- A.A-Buffed and Chromium Plated
- A.B-Hardened, Polished, Buffed and Chromium Plated
- A.C-Brown Baking Enamel Finish
- A.D-Gray Baking Enamel Finish
- A.E-Hardened, Bright Rumbled and Nickel Plated
- A.F-Hardened, Bright Rumbled, Nickel Plated, Bright Rumbled and Chromium Plated
- A.G-Alumilite, Plain
- A.H-Alumilite, Dyed
- A.J-Polished, Nickel Plated and Chromium Plated
- A.K-Hardened, Polished, Nickel Plated and Chromium Plated
- A.L-Heat Treated for Toughness
 - B-Polished, Nickel Plated and Buffed
 - C-Hardened Only
- C.R-Hardened and Merlized
 - D-Polished Only
 - E-Soft, Not Polished
 - F-Hardened and Polished
- F.J-Hardened, Polished and Nickel Plated
 - G-Bright Rumbled and Nickel Plated
 - H-Blued
 - J-Nickel Plated Only
 - K-Hardened and Nickel Plated
 - L-Brass Plated
 - M-Oxidized
 - N-Japanned, Dull
 - P-Japanned, Bright
- P.P-Wrinkle Finish
 - R-Merlized
 - S-Cadmium Plated
 - T-Copper Plated
- T.A-Hardened, Polished, Copper and Nickel Plated and Buffed
- T.B-Copper and Nickel Plated and Polished
- T.J-Copper and Nickel Plated Only
- T.K-Hardened, Copper and Nickel Plated
- T.L-Copper and Brass Plated
- T.M-Copper Plated and Oxidized

- U-Zinc Plated
- V-Silver Plated
- W-Polished and Nickel Plated
- X-Black Oxide, for Iron and Steel
- X.C-Hardened and Black Oxide, for Iron or Steel
- Y-Black Nickel Plated Only
- Z-Chromium Plated
- Z.A-Hardened, Polished, Nickel Plated, Buffed and Chromium Plated
- Z.B-Polished, Nickel Plated, Buffed and Chromium Plated
- Z.C-Hardened and Chromium Plated
- Z.D-Polished and Chromium Plated
- Z.G-Bright Rumbled, Nickel Plated, Bright Rumbled and Chromium Plated
- Z.J-Nickel and Chromium Plated
- Z.T-Copper and Chromium Plated

These letters MUST BE USED when they appear in the list; and AFTER the number as in the list.

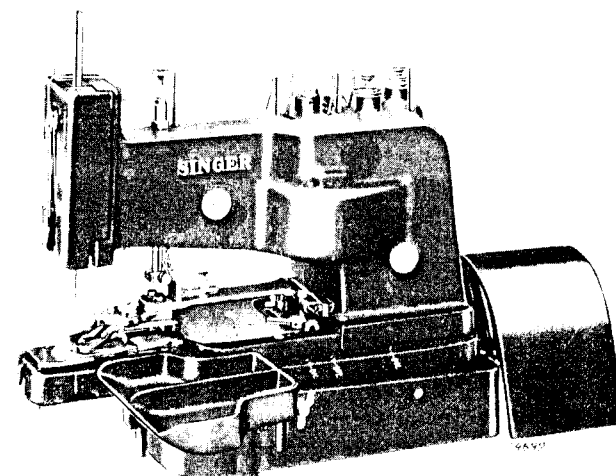
In this series:

- 1 to 1500, 50001 to 51500 and 140001 to 142000 are Screw Numbers
- 1501 to 1800 and 51501 to 51800 are Nut Numbers
- 1801 to 2000 and 51801 to 52000 are Roller Numbers
- 2001 to 50000 and 52001 to 140000 and 142001 to 190000 are Sewing Machine Parts, 190001 and upward are numbers of Electrical Parts.

The figures in the second column refer only to the plates, illustrating the parts, and are NOT TO BE USED in ordering.

Parts marked with an asterisk (*) are furnished only when repairs are made at factory.

LIST OF PARTS COMPLETE
FOR



MACHINE No. 175-60

For Sewing Buttons on Men's and Boys' Clothing. Work Shirts, Pants, Overalls, Sweaters, etc. For sewing medium and large two and four-hole flat buttons, through and through, close to the material. Makes two parallel bars and one right angle cross-over stitch in four-hole buttons. Makes the Dubbilstay stitch in two-hole buttons. Sixteen stitches are made, including the cross-over and knotting stitches. Has needle bar vibration. Clamp moves Up the cylinder Only when sewing four-hole buttons. The machine is regularly fitted with clamp for 20 to 45 ligne. Fitted with thread nipper and automatic and constant tensions; also thread positioning finger. Speed 1000 R. P. M.

No.	Plate	Name
*175001	-----	Arm with 15404 and two 15405.....
8589	23332	" Dowel Pin (2).....
175340	24326	" Rock Shaft and Front Crank.....
175005	21901	" " Crank (back) with 1177E, 1521J and 140016E.....
1177E	21901	Arm Rock Shaft Crank (back) Clamping Screw.....

SINGER Needles should be used
in SINGER Machines
These Needles and their Containers
are marked with the
Company's Trade Mark "SIMANCO.**" 1

Needles in Containers marked
"FOR SINGER MACHINES"
are NOT SINGER made needles. 2

No.	Plate	Name
140016E	21901	Arm Rock Shaft Crank (back) Position Screw.....
1521J	21901	Arm Rock Shaft Crank (back) Position Screw Lock Nut.....
175007	21901	Arm Rock Shaft Crank (front) Pin.....
140017E	21901	" Screw (long) (3).....
670E	21901	" " (short).....
175008	21901	" Side Cover (left).....
230J	21901	" " " " Screw (2).....
175009	-----	" " " (right).....
175010	22100	" " " " Screw Stud (long)..
175011	22100	" " " " " (short)..
51649E	21901	" " " " " Lock Nut (2).....
51650B	21901	Arm Side Cover (right) Screw Stud Thumb Nut (2).....
*175825	-----	Bed.....
175013	22100	" End Cover (bottom).....
175751	-----	" " " " 175013 with 175016
175014	21901	" " " " Hinge Pin (left)..
175015	21901	" " " " " (right)..
175016	21901	" " " " Spring.....
175017	21906	" " " " Hook.....
175018	22100	" Top Cover (back) with two 175019....
175019	21906	" " " " Oil Tube (2).....
140018W	21906	" " " " Screw (2).....
175020	23326	" " " (front).....
140019F	21906	" " " " Screw (4).....
175021	-----	Button Clamp (left) with 175622.....
175022	23326	" " " 175021 with 228J, 140021C and 175026.....
140020C	21906	Button Clamp (left) Hinge Screw.....
1498AL	21906	" " " " Lock Screw
140021C	21906	" " " " Screw Stud.....
175026	21906	" " " " Spring.....
228J	21906	" " " " Screw.....
175622	21906	" " " " Steady Pin...
175027	-----	" " (right) with 175622.....
175028	23326	" " " 175027 with 228J, 140021C and 175030.....
140020C	21906	Button Clamp (right) Hinge Screw.....
1498AL	21906	" " " " Lock Screw.....
140021C	21906	Button Clamp (right) Screw Stud.....
175030	21906	" " " " Spring.....
228J	21906	" " " " Screw.....
175622	21906	" " " " Steady Pin..
175031	22100	" " Adjusting Lever.....
680W	21906	" " " " Thumb Screw
175032	21906	" " " " Washer.....

No.	Plate	Name
175806	23326	Button Clamp Arm.....
175034	23326	" " " Hinge Pin.....
175035	23326	" " " " " Bracket.....
160J	21906	" " " " " " Screw (2).....
175036	23326	Button Clamp Arm Hinge Pin Bracket Shim (.003 in. thick).....
175037	-----	Button Clamp Arm Hinge Pin Bracket Shim (.005 in. thick).....
175038	-----	Button Clamp Arm Hinge Pin Bracket Shim (.007 in. thick).....
175039	-----	Button Clamp Arm Hinge Pin Bracket Shim (.015 in. thick).....
175040	21907	Button Clamp Closing Spring.....
175041	23326	" " Lifting Arm with 190J, 190K and 1259AL.....
1259AL	21906	Button Clamp Lifting Arm Set Screw.....
175812	-----	" " " Chain (4 links) with 175814.....
175813	23326	Button Clamp Lifting Chain 175812 with 51224B.....
175814	23326	Button Clamp Lifting Chain Hook.....
190K	21906	" " " " Screw (upper)
190J	21906	" " " " " " Lock Screw.....
51224B	23326	Button Clamp Lifting Chain Thumb Screw..
175043	23326	" " " and Thread Pull-off Holder Shaft.....
175044	21907	Button Clamp Lifting and Thread Pull-off Holder Shaft Collar with 458C.....
458C	21907	Button Clamp Lifting and Thread Pull-off Holder Shaft Collar Set Screw.....
175045	21907	Button Clamp Lifting and Thread Pull-off Holder Shaft Spring.....
175046	21907	Button Clamp Lifting and Thread Pull-off Holder Shaft Spring Collar with 458C
458C	21907	Button Clamp Lifting and Thread Pull-off Holder Shaft Spring Collar Set Screw
175047	23326	Button Clamp Lifting Rod.....
175048	23326	" " " " Arm with 160E and 50269C.....
160E	21906	Button Clamp Lifting Rod Arm Clamping Screw.....
50269C	21906	Button Clamp Lifting Rod Arm Position Screw.....
175049	21907	Button Clamp Lifting Rod Arm Stop Plate..
160J	21906	" " " " " " " " Screw (2).....
175032	21906	Button Clamp Lifting Rod Arm Stop Plate Screw Washer (2).....

No.	Plate	Name
42830	21907	Button Clamp Lifting Rod Cotter Pin.....
175050	23328	" " " " Spring.....
175051	21907	" " " " " Stop
		Collar with 160C.....
160C	21906	Button Clamp Lifting Rod Spring Stop
		Collar Set Screw.....
175365	23328	Button Clamp Presser Bar.....
175053	21907	" " " " Collar with 458C
458C	21907	" " " " " Set Screw
175054	21903	" " " " Screw Bearing...
175055	23328	" " " " Spring.....
140023W	21903	" " Pressure Regulating Thumb
		Screw.....
1722J	21903	Button Clamp Pressure Regulating Thumb
		Screw Lock Nut.....
175056	23328	Button Clamp Spreader and Button Stop...
175734	-----	" " " " " "
		175056 with 175058 and two 1472J....
175057	23328	Button Clamp Spreader and Button Stop
		Base with two 1498AL.....
140024C	21906	Button Clamp Spreader and Button Stop
		Base Screw (2).....
175032	21906	Button Clamp Spreader and Button Stop
		Base Screw Washer (2).....
140265W	23331	Button Clamp Spreader and Button Stop
		Screw.....
51688J	23331	Button Clamp Spreader and Button Stop
		Screw Nut.....
175058	21903	Button Clamp Spreader Handle.....
1472J	21903	" " " " " Screw (2).
175059	-----	Button Clamp complete, Nos. 51688J,
		140265W, 175022, 175028, 175040, 175057,
		175734 and two 140020C.....
175726	-----	Button Clamp 175059 with 680W, 175031,
		175806, two 140024C and three 175032,
		for 20 to 45 ligne two or four hole
		flat buttons.....
175771	23328	Face Plate with 624AL.....
175772	-----	" " 175771 with 185J, 175062, 175063,
		175065, 175066, 175774, 175776 and
		202098.....
120J	21903	Face Plate Screw (2).....
175062	21903	" " Thread Guide (lower) Plate...
185J	21903	" " " " " "
		Screw.....
175063	21903	Face Plate Thread Guide (lower) Plate
		Screw Spacing Collar.....
202098	21903	Face Plate Thread Guide (lower) Roller..
175065	21903	" " " " " "
		Flu.....

No.	Plate	Name
175066	21903	Face Plate Thread Guide (upper).....
175773	22852	" " " " Retainer Sleeve.....
175774	22852	" " " " Spring.....
175775	22852	" " " " Stud.....
175776	-----	" " " " " 175775
		with 175773.....
624AL	22852	Face Plate Thread Retainer Stud Set
		Screw.....
175293	23328	Feed Cam.....
175294	23328	" " Driving Worm.....
175299	21903	" " " " Pin.....
175295	23328	" " " " Wheel with 175229
		and two 140026C.....
140026C	21903	Feed Cam Driving Worm Wheel Set Screw
		(2).....
175071	22100	Feed Cam Driving Worm Wheel Shaft.....
175780	-----	" " " " " " 175071
		with 175119 and 175805.....
127J	21903	Feed Cam Screw (2).....
175032	21906	" " " Washer (2).....
175685	23328	" Plate with two 175590.....
175073	22853	" " Carrier.....
175074	22853	" " " Driving Arm with 458C
		and 51923.....
175796	22852	Feed Plate Carrier Driving Arm Pin.....
51923	21903	" " " " " Roller and
		Screw Stud.....
458C	21907	Feed Plate Carrier Driving Arm Set Screw
175075	22853	" " " Guide Block (left)...
190J	21906	" " " " " "
		Screw (2).....
175076	22853	Feed Plate Carrier Guide Block (right)...
190J	21906	" " " " " "
		Screw (2).....
51667C	22852	Feed Plate Carrier Regulating Nut with
		175549.....
175548	22852	Feed Plate Carrier Regulating Nut Screw
		Stud.....
175739	-----	Feed Plate Carrier Regulating Nut Screw
		Stud 175548 with 175073.....
175078	22852	Feed Plate Carrier Regulating Nut Screw
		Stud Slide Block.....
175079	22852	Feed Plate Carrier Regulating Nut Screw
		Stud Washer.....
175549	22852	Feed Plate Carrier Regulating Nut Tight-
		ening Handle.....
175081	-----	Feed Plate Carrier Regulator and Shaft
		with 228J.....
175627	22853	Feed Plate Carrier Regulator 175081 with
		175074 and 175796 (for Agents only).

No.	Plate	Name
175083	22853	Feed Plate Carrier Regulator Spring....
160J	21906	" " " " " Screw (bed end).....
228J	21906	Feed Plate Carrier Regulator Spring Screw (regulator end).....
175692	22853	Feed Plate Holder.....
227J	22852	" " " " Screw (2).....
175589	22853	" " Spring.....
175590	22852	" " Stud (2).....
175085	22852	Looper.....
175086	22853	" Driving Shaft.....
175087	22853	" " " Bushing.....
175594	-----	" " " " " 134097 with 175096, 175091 and 175093.....
51183E	22852	Looper Driving Shaft Bushing Clamping Screw.....
175525	22853	Looper Driving Shaft Crank and Connect- ing Link Hinge Stud with 435AL and 1285C.....
175089	22852	Looper Driving Shaft Crank Connecting Link.....
175660	-----	Looper Driving Shaft Crank Connecting Link 175089 with 175525 and 175529..
1285C	22852	Looper Driving Shaft Crank Position Screw.....
435AL	22852	Looper Driving Shaft Crank Set Screw....
175091	22854	" " " " Gear.....
175092	22854	" " " " " Pin.....
458C	21907	" " Set Screw.....
175093	22853	" " Shaft with 458C.....
175529	22853	" " Crank and Stud with two 140027C.....
140027C	22854	Looper Shaft Crank Set Screw (2).....
175096	22854	Machine Rest Stud.....
458C	21907	" " " " Set Screw.....
175396	22100	Needle Bar (hollow) with 200LFF.....
175348	21940	" " Connecting Link.....
140028C	21940	" " " " " Hinge Screw..
1722J	21903	" " " " " " Nut
175810	23331	" " " " " Stud with 160E.....
175811	-----	Needle Bar Connecting Link Hinge Stud 175810 with 1492J, 175100 and 175101
160E	21906	Needle Bar Connecting Link Hinge Stud Clamping Screw.....
175100	21940	Needle Bar Connecting Link Hinge Stud Thread Guide Plate.....
1492J	22854	Needle Bar Connecting Link Hinge Stud Thread Guide Plate Screw.....
175101	21940	Needle Bar Connecting Link Hinge Stud Thread Guide Roller.....

No.	Plate	Name
175349	21940	Needle Bar Connecting Stud (lower).....
1681J	21940	" " " " " Nut..
51652J	21940	" " " " " "
		Lock Nut.....
175103	21940	Needle Bar Connecting Stud (lower) Wash- er.....
175104	21940	Needle Bar Connecting Stud (upper).....
1681J	21940	" " " " " Nut..
51652J	21940	" " " " " "
		Lock Nut.....
175103	21940	Needle Bar Connecting Stud (upper) Wash- er.....
175105	22853	Needle Bar Eccentric with 140027C.....
175106	21919	" " " " Connecting Rod with 1521J, 140024E, 175535 and two 140029E
140029E	21940	Needle Bar Eccentric Connecting Rod Cap Screw (2).....
140024E	21906	Needle Bar Eccentric Connecting Rod Clamping Screw.....
1521J	21901	Needle Bar Eccentric Connecting Rod Clamping Screw Nut.....
140031C	21940	Needle Bar Eccentric Connecting Rod Hinge Screw.....
51653E	21940	Needle Bar Eccentric Connecting Rod Hinge Screw Nut.....
175535	21940	Needle Bar Eccentric Connecting Rod Oil Pad (felt).....
175108	21940	Needle Bar Eccentric Pawl with 175114...
175109	-----	Needle Bar Eccentric Pawl complete, Nos. 175108, 175110 and 175112.....
175110	21940	Needle Bar Eccentric Pawl Bracket with 175111.....
134E	21940	Needle Bar Eccentric Pawl Bracket Screw.
175111	21940	" " " " " Steady Pin.....
175112	22854	Needle Bar Eccentric Pawl Hinge Pin.....
175113	22854	" " " " " Spring.....
175114	22854	" " " " " Stud.
175119	22854	" " " " " Pin.....
140027C	22854	" " " " " Set Screw.....
175805	23329	" " Vibrating Cam with 175185....
175119	22854	" " " " " Pin.....
175120	21919	" " " " " Lever.....
175756	23329	" " " " " Adjusting Bracket with 458C and 1341AL.....
175759	-----	Needle Bar Vibrating Lever Adjusting Bracket 175756 with 175123 and 175770.....
175757	22854	Needle Bar Vibrating Lever Adjusting Bracket Hinge Stud.....

No.	Plate	Name
175770	-----	Needle Bar Vibrating Lever Adjusting Bracket Hinge Stud 175757 with 175758.....
1341AL	22854	Needle Bar Vibrating Lever Adjusting Bracket Hinge Stud Set Screw.....
175758	21941	Needle Bar Vibrating Lever Adjusting Bracket Hinge Stud Slide.....
51654C	21941	Needle Bar Vibrating Lever Adjusting Bracket Lock Nut.....
175123	21941	Needle Bar Vibrating Lever Adjusting Bracket Lock Nut Screw Stud.....
458C	21907	Needle Bar Vibrating Lever Adjusting Bracket Lock Nut Screw Stud Set Screw.....
175125	21941	Needle Bar Vibrating Lever Adjusting Bracket Lock Nut Washer.....
175126	21919	Needle Bar Vibrating Lever Arm with 51923.....
140033C	21922	Needle Bar Vibrating Lever Arm Hinge Screw.....
51923	21903	Needle Bar Vibrating Lever Arm Roller and Screw Stud.....
140024E	21906	Needle Bar Vibrating Lever Arm Screw....
175032	21906	" " " " " " Washer.....
140034C	21941	Needle Bar Vibrating Lever Hinge Screw..
140035C	21941	" " " " " " Lock Screw.....
175127	21941	Needle Bar Vibrating Lever Hinge Screw Slide.....
175546	21920	Needle Guide and Shaft with 175131, 175547 and two 218D.....
175130	21941	Needle Guide Cam with two 1259AL.....
1259AL	21906	" " " Set Screw (2).....
175132	21941	" " Oscillating Crank with 140159E and 175134.....
140159E	21941	Needle Guide Oscillating Crank Clamping Screw.....
175016	21901	Needle Guide Oscillating Crank Spring...
175134	21941	" " " " " Hook (crank end).....
175135	21941	Needle Guide Oscillating Crank Spring Hook (bed end).....
175131	21941	Needle Guide Pin.....
175094	21941	" " Shaft Bushing.....
458C	21907	" " " " Set Screw....
175547	21941	" " Thread Finger.....
218D	21941	" " " " Screw (2)...
175483	23329	" Plate.....
140019F	21906	" " Screw (2).....

No.	Plate	Name
200125F	22854	Needle Set Screw.....
175140	21919	Pulley, 2 3/4 in. diam., with 51655J, 140037C and 175820.....
Note: No. 175140 Pulley is regularly furnished with the Machine.		
175634	-----	Pulley, 3 1/4 in. diam., with 51655J, 140037C and 175820.....
175636	-----	Pulley, 3 3/4 in. diam., with 51655J, 140037C and 175820.....
140037C	21921	Pulley Engaging Screw.....
51655J	21921	" " " Nut.....
175820	23332	" Oil Wick.....
175142	21919	" Shaft.....
175595	-----	" " 175142 with 175069, 175105, 175143, 175144, 175150, 175294 and two 175119.....
175143	22854	Pulley Shaft Gear.....
175144	22854	" " " Pin.....
175145	21921	" Shifter.....
175146	21919	" " Holder with 51649J and 140078AL.....
140078AL	21921	Pulley Shifter Holder Set Screw.....
51649J	21901	" " " " Lock Nut
1178E	21921	" " Screw.....
175148	21919	Starting Crank with 1747J and 140039E...
175630	-----	" " 175148 with 175149 and 175155.....
140039E	21921	Starting Crank Adjusting Screw.....
1747J	21921	" " " " Nut.....
175149	21921	" " Pin.....
175150	21920	Stop Dog.....
175151	21921	" " Cushion Spring.....
175152	21920	" " " " Holder with 50581C, 175151 and two 140040AL....
50581C	21921	Stop Dog Cushion Spring Holder Set Screw
140040AL	21921	" " " " Set Screw (2)..
175119	22854	" " Pin.....
175153	21921	" Motion Retaining Collar.....
160J	21906	" " " " Screw.....
175154	21921	" " " " " Stud
882AL	21921	" " " " " " Set Screw.....
175155	21920	Stop Motion Shaft.....
175156	21920	" " " Spring.....
175157	21920	" " " " Collar with 140041AL.....
140041AL	21921	Stop Motion Shaft Spring Collar Set Screw.....
175158	21920	Stop Motion Trip.....
175159	21920	" " " Block with 882AL and 175154.....

No.	Plate	Name
140042C	21941	Stop Motion Trip Block Hinge Screw.....
51649E	21901	" " " " " Nut..
175113	22854	" " " " Spring.....
175229	21921	" " " Point.....
160J	21906	" " " Screw (2).....
175032	21906	" " " Washer (2).....
175160	21922	Tension (automatic) Disc (2).....
175161	21922	" " " Position Pin....
1560C	21922	" " " Regulating Thumb Nut
175162	21922	" " " Releasing Cam with two 140027C.....
140027C	22854	Tension (automatic) Releasing Cam Set Screw (2).....
175522	21922	Tension (automatic) Releasing Disc.....
175163	21920	" " " Rod.....
1521J	21901	" " " " Adjust- ing Nut.....
1521J	21901	Tension (automatic) Releasing Rod Ad- justing Nut Lock Nut.....
175164	21920	Tension (automatic) Releasing Rod Spring
175165	21922	" " " " Wearing Sleeve.....
140043C	21922	Tension (automatic) Screw Stud.....
175166	-----	" " " " 140043C with 1560C.....
125314	21922	Tension (automatic) Spring.....
175167	21922	" " " Thread Eyelet.....
175168	-----	Tension (automatic) complete, Nos. 125314, 175166, 175522 and two 175160.
175160	21922	Tension (stationary) Disc (2).....
175161	21922	" " " Position Pin.
1560C	21922	" " " Regulating Thumb Nut
140044C	21922	" " " Screw Stud.....
175169	-----	" " " " 140044C with 1560C.....
13710	21922	Tension (stationary) Spring.....
175170	-----	Tension (stationary) complete, Nos. 13710, 175169 and two 175160.....
175171	21922	Thread Eyelet (back).....
175172	21922	" " (front).....
175173	21923	" Nipper Head.....
175174	21923	" " Plate.....
160J	21906	" " " Screw.....
175175	21923	" " " Washer.....
140045K	21923	" " " Releasing Head Screw.....
175176	21923	" " " Lever.....
140046C	21923	" " " Hinge Screw
175177	21923	" " " Rod.....
175178	-----	" " " " 175177 with 175173.....

No.	Plate	Name
175179	21923	Thread Nipper Releasing Rod Spring (lower).....
175190	21923	Thread Nipper Releasing Rod Spring (lower) Washer.....
175181	21923	Thread Nipper Releasing Rod Spring (upper).....
175192	21923	Thread Nipper Releasing Rod Spring Collar with 465C (2).....
465C	21923	Thread Nipper Releasing Rod Spring Collar Set Screw (2).....
175183	21923	Thread Nipper Releasing Screw Stud.....
1722J	21903	" " " " " Nut..
175184	21923	" " " " " " Washer.....
175185	21923	Thread Nipper Releasing Stud.....
175161	21922	" " Thread Guide Pin (3).....
175186	21920	" Pull-off (back).....
175187	22855	" " " Holder with 160C and 1120C.....
160C	21906	Thread Pull-off (back) Holder Set Screw.
1120C	22855	" " " Set Screw.....
175188	21920	" " (front).....
175189	22855	" " " Holder with 1120C and 175190.....
175190	22855	Thread Pull-off (front) Holder Stop Pin.
1120C	22855	" " " Set Screw.....
175191	22855	" " Stop Collar with 160C and 175192.....
160C	21906	Thread Pull-off Stop Collar Set Screw...
175192	22855	" " " Stop Pin....
175197	21922	" " Thread Eyelet (2).....
*15404	-----	Trade Mark.....
15405	-----	" " Rivet (2).....

SINGER Needles should be used
in SINGER Machines.
These Needles and their Containers
are marked with the
Company's Trade Mark "SIMANCO.**" 1

Needles in Containers marked
"FOR SINGER MACHINES"
are NOT **SINGER** made needles. 2

BUTTON CLAMPS

BUTTON CLAMP No. 175725

FOR SEWING 10 TO 24 LIGNE TWO AND FOUR HOLE FLAT
 BUTTONS CLOSE TO THE MATERIAL EITHER WITH
 A THROUGH AND THROUGH STITCH
 OR USING A STAY BUTTON

No.	Plate	Name
175418	-----	Button Clamp (left) with 175622.....
175419	23329	" " " 175419 with 228J, 140021C and 175420.....
140020C	21906	Button Clamp (left) Hinge Screw.....
1498AL	21906	" " " " Lock Screw
140021C	21906	" " " Screw Stud.....
175420	22855	" " " Spring.....
228J	21906	" " " Screw.....
175622	21906	" " " Steady Pin...
175516	-----	" " (right) with 175622.....
175517	23329	" " " 175516 with 228J, 140021C and 175517.....
140020C	21906	Button Clamp (right) Hinge Screw.....
1498AL	21906	" " " " Lock Screw.....
140021C	21906	Button Clamp (right) Screw Stud.....
175518	22855	" " " Spring.....
228J	21906	" " " Screw.....
175622	21906	" " " Steady Pin...
175031	22100	" " Adjusting Lever.....
680W	21906	" " " Thumb Screw
175032	21906	" " " " " Washer.....
175806	23326	Button Clamp Arm.....
175040	21907	" " Closing Spring.....
175056	23328	" " Spreader and Button Stop...
175755	-----	" " " " " 175056 with 175573 and two 1472J....
175057	23328	Button Clamp Spreader and Button Stop Base with two 1498AL.....
140024C	21906	Button Clamp Spreader and Button Stop Base Screw (2).....
175032	21906	Button Clamp Spreader and Button Stop Base Screw Washer (2).....
140265W	23331	Button Clamp Spreader and Button Stop Screw.....
51688J	23331	Button Clamp Spreader and Button Stop Screw Nut.....
175573	21906	Button Clamp Spreader Handle.....

No.	Plate	Name
1472J	21903	Button Clamp Spreader Handle Screw (2).
175397	-----	Button Clamp complete, Nos. 51688J, 140265W, 175040, 175057, 175419, 175517, 175755 and two 140020C.....
175725	-----	Button Clamp 175397 with 680W, 175031, 175806, two 140024C and three 175032

BUTTON CLAMP No. 175852

FOR SEWING 20 TO 45 LIGNE TWO AND FOUR HOLE HEAVY
 FLAT BUTTONS CLOSE TO THE MATERIAL EITHER WITH
 A THROUGH AND THROUGH STITCH
 OR USING A STAY BUTTON

No.	Plate	Name
175021	-----	Button Clamp (left) with 175622.....
175299	23331	" " " 175021 with 228J, 140021C, 175026 and 175299.....
140020C	21906	Button Clamp (left) Hinge Screw.....
1498AL	21906	" " " " Lock Screw
140021C	21906	" " " Screw Stud.....
175026	21906	" " " Spring.....
175299	23331	" " " " Reinforcing Spring.....
228J	21906	Button Clamp (left) Spring Screw.....
175622	21906	" " " " Steady Pin...
175027	-----	" " (right) with 175622.....
175300	23331	" " " 175027 with 228J, 140021C, 175030 and 175299.....
140020C	21906	Button Clamp (right) Hinge Screw.....
1498AL	21906	" " " " Lock Screw.....
140021C	21906	Button Clamp (right) Screw Stud.....
175030	21906	" " " Spring.....
175299	23331	" " " " Reinforcing Spring.....
228J	21906	Button Clamp (right) Spring Screw.....
175622	21906	" " " " Steady Pin...
175031	22100	" " Adjusting Lever.....
680W	21906	" " " " Thumb Screw
175032	21906	" " " " " Washer.....
175806	23326	Button Clamp Arm.....
175303	21907	" " Closing Spring.....
175302	23331	" " Spreader and Button Stop...
175756	-----	" " " " " 175302 with 175058 and two 1472J....

BUTTON CLAMPS

No.	Plate	Name
140152C	22855	Button Clamp (right) Hinge Screw.....
51676J	22855	" " " " " Nut....
175653	22855	" " " " " Spacing Collar.....
140153C	22855	Button Clamp (right) Screw Stud.....
175642	22855	" " " Spring.....
228J	21906	" " " " Screw.....
175622	21906	" " " " Steady Pin..
175644	23329	" " Adjusting Slide.....
140151J	22855	" " " " Guide Screw
51675J	22855	" " " " " " "
		Lock Nut.....
1656J	22857	Button Clamp Adjusting Slide Thumb Nut..
175643	23329	" " Arm.....
175363	23330	" " " Hinge Bracket.....
140072K	22857	" " " Screw (2).....
175032	21906	" " " " Washer (2).....
175647	22857	" " Lifting Chain Bracket with two 190K.....
175648	22857	Button Clamp Lifting Chain Bracket Hold- er.....
190K	21906	Button Clamp Lifting Chain Bracket Set Screw.....
190K	21906	Button Clamp Lifting Chain Screw (lower)
175646	23330	" " Opening Handle.....
223J	22857	" " " " Screw (2)..
175750	23330	" " Presser Bar Seat.....
230J	21901	" " " " " Screw (2)
175649	23330	" " Spreader and Button Stop with Slide and two 175622.....
175622	21906	Button Clamp Spreader and Button Stop Slide Pin (2).....
140154W	22857	Button Clamp Spreader and Button Stop Slide Screw (2).....
175650	23330	Button Clamp Spreader and Button Stop Spring.....
175651	23330	Button Clamp Spreader and Button Stop Spring Guide Screw Stud.....
175652	22857	Button Clamp Spreader and Button Stop Spring Guide Screw Stud Holder.....
1521J	21901	Button Clamp Spreader and Button Stop Spring Guide Screw Stud Holder Nut..
175749	-----	Button Clamp complete, Nos. 1521J, 1656J, 51675J, 140151J, 175363, 175638, 175641, 175643, 175644, 175646 to 175652, 175750, two each 223J, 230J, 51676J, 140072K, 140152C, 140154W, 175032 and 175653.....

BUTTON CLAMP No. 175744

FOR SEWING 20 TO 45 LIGNE TWO AND FOUR HOLE FLAT

BUTTONS AWAY FROM THE MATERIAL EITHER WITH

A THROUGH AND THROUGH STITCH

OR USING A STAY BUTTON

No.	Plate	Name
175021	-----	Button Clamp (left) with 175622.....
175021	23326	" " " 175021 with 228J, 140021C and 175026.....
140021C	21906	Button Clamp (left) Hinge Screw.....
1498AL	21906	" " " " " Lock Screw.....
140021C	21906	Button Clamp (left) Screw Stud.....
175026	21906	" " " Spring.....
228J	21906	" " " " Screw.....
175621	21906	" " " " Steady Pin..
175027	-----	" " (right) with 175622.....
175027	23326	" " " 175027 with 228J, 140021C and 175030.....
140020C	21906	Button Clamp (right) Hinge Screw.....
1498AL	21906	" " " " " Lock Screw.....
140021C	21906	Button Clamp (right) Screw Stud.....
175030	21906	" " " Spring.....
228J	21906	" " " " Screw.....
175622	21906	" " " " Steady Pin..
175031	21906	" " Adjusting Lever.....
690W	21906	" " " " Thumb Screw
175032	21906	" " " " " " " Washer.....
175606	23326	Button Clamp Arm.....
175040	21907	" " Closing Spring.....
175411	23327	" " Shanking Foot (double) (2)
Note: When ordering No. 175411, state height re- quired.		
140067J	23327	Button Clamp Shanking Foot Position Screw.....
140068W	23327	Button Clamp Shanking Foot Thumb Screw..
175056	23328	" " Spreader and Button Stop...
175734	-----	" " " " " " " 175056 with 175058 and two 1472J....
175057	23328	Button Clamp Spreader and Button Stop Base with two 1498AL.....
140024C	21906	Button Clamp Spreader and Button Stop Base Screw (2).....

No.	Plate	Name
175032	21906	Button Clamp Spreader and Button Stop Base Screw Washer (2).....
140065W	23331	Button Clamp Spreader and Button Stop Screw.....
51688J	23331	Button Clamp Spreader and Button Stop Screw Nut.....
175058	21903	Button Clamp Spreader Handle.....
1472J	21903	" " " " Screw (2).
175743	-----	Button Clamp complete, Nos. 51688J, 140067J, 140068W, 140265W, 175022, 175028, 175040, 175057, 175734 and two each 140020C and 175411.....
175744	-----	Button Clamp 175743 with 680W, 175031, 175806, two 140024C and three 175032

BUTTON CLAMP No. 175746

FOR SEWING 20 TO 45 LIGNE TWO AND FOUR HOLE FLAT

BUTTONS AWAY FROM THE MATERIAL

WITH A BLIND STITCH

NOTE: THIS BUTTON CLAMP IS THE SAME AS BUTTON CLAMP

NO. 175744, WITH THE FOLLOWING EXCEPTIONS

No.	Plate	Name
175401	23327	Button Clamp Shanking Foot (single) in place of 175411 (2).....
Note: When ordering No. 175401, state height required.		
175745	-----	Button Clamp complete, Nos. 51688J, 140067J, 140068W, 140265W, 175022, 175028, 175040, 175057, 175734 and two each 140020C and 175401, in place of 175743.....
175746	-----	Button Clamp 175745 with 680W, 175031, 175806, two 140024C and three 175032, in place of 175744.....

BUTTON CLAMP No. 175795

FOR SEWING 40 TO 55 LIGNE TWO AND FOUR HOLE FLAT

BUTTONS AWAY FROM THE MATERIAL WITH

A THROUGH AND THROUGH STITCH

OR USING A STAY BUTTON

No.	Plate	Name
175793	-----	Button Clamp complete, Nos. 51688J, 140067J, 140068W, 140265W, 175057, 175303, 175720, 175723, 175743 and two each 140020C and 175764.....
175794	-----	Button Clamp 175793 with 680W, 175031, 175806, two 140024C and three 175032
Note: Button Clamp No. 175795 is the same as Button Clamp No. 175727, but with the addition of the following parts:		
175764	23330	Button Clamp Shanking Foot (double) (2)
Note: When ordering No. 175764, state height required.		
140067J	23327	Button Clamp Shanking Foot Position Screw.....
140068W	23327	Button Clamp Shanking Foot Thumb Screw..

BUTTON CLAMP No. 175790

FOR SEWING 40 TO 55 LIGNE TWO AND FOUR HOLE FLAT

BUTTONS AWAY FROM THE MATERIAL

WITH A BLIND STITCH

No.	Plate	Name
175793	-----	Button Clamp complete, Nos. 51688J, 140067J, 140068W, 140265W, 175057, 175303, 175720, 175723, 175743 and two each 140020C and 175786.....
175790	-----	Button Clamp 175793 with 680W, 175031, 175806, two 140024C and three 175032
Note: Button Clamp No. 175790 is the same as Button Clamp No. 175727, but with the addition of the following parts:		
175786	23330	Button Clamp Shanking Foot (single) (2)
Note: When ordering No. 175786, state height required.		

No.	Plate	Name
140067J	23327	Button Clamp Shanking Foot Position Screw.....
140068W	23327	Button Clamp Shanking Foot Thumb Screw..

BUTTON CLAMP No. 175684

FOR SEWING METAL EYELET SHANK AND LEATHER SHANK
BUTTONS, ALSO SELF-SHANK BUTTONS SUCH AS METAL,
BONE, PEARL, CLOTH COVERED AND COMPOSITION WITH
EITHER A THROUGH AND THROUGH STITCH, BLIND
STITCH OR USING A STAY BUTTON

No.	Plate	Name
175807	23330	Button Clamp Arm.....
175808	-----	" " " 175807 with 175809 and two each 140072K and 175032.....
175797	23330	Button Clamp Arm Hinge Bracket.....
140024C	21906	" " " Screw (2).....
175032	21906	" " " Washer (2).....
175809	23331	" " Presser Bar Seat.....
140072K	22857	" " " " " Adjusting Screw.....
175032	21906	Button Clamp Presser Bar Seat Adjusting Screw Washer.....
140072K	22857	Button Clamp Presser Bar Seat Screw....
175032	21906	" " " " " Washer
175667	23330	" Finger for small size buttons....
175668	23330	" " for large size buttons....
51696W	23332	" " Adjusting Thumb Nut.....
22436	22857	" " " " " Washer
175669	22857	" " Holder.....
140160K	22857	" " " Screw.....
175670	22857	" " Lever.....
50603J	22857	" " Hinge Screw.....
175672	-----	" " " Post.....
1521J	21901	" " " " Nut.....
175673	22857	" " " Screw Bushing.....
175674	22857	" " " " " Screw Stud.....
175675	22857	Button Finger Lever Screw Bushing Spring
191J	22857	" Holder Screw.....
175684	-----	Button Clamp complete (less button holder) Nos. 191J, 1521J, 22436, 50603J, 51696W, 140160K, 175667 to 175670, 175672 to 175675, 175227, 175808 and two each 140024C and 175032.....

BUTTON HOLDERS

NOTE: THE FOLLOWING BUTTON HOLDERS ARE USED

WITH, BUT NOT INCLUDED IN BUTTON CLAMP

COMPLETE NO. 175684

No.	Plate	Name
175383	22859	Button Holder for leather shank (or imitation of same) buttons.....
175384	-----	Button Holder Spring for 175383.....
175382	22859	" " (7/32 in. hole) for self-shank buttons such as metal, bone, pearl, cloth covered and composition
175393	22859	Button Holder (5/16 in. hole) for self-shank buttons such as metal, bone, pearl, cloth covered and composition
175398	22859	Button Holder (3/8 in. hole) for self-shank buttons such as metal, bone, pearl, cloth covered and composition
175399	22859	Button Holder (15/32 in. hole) for self-shank buttons such as metal, bone, pearl, cloth covered and composition
175676	22859	Button Holder for metal eyelet shank buttons.....
175677	22859	Button Holder for metal eyelet shank buttons (short eyelet).....
175678	22859	Button Holder Spring for 175676 and 175677.....
175681	22859	Button Holder for metal eyelet shank buttons (large eyelet).....
175682	22859	Button Holder for metal eyelet shank buttons (small eyelet).....

FEED PLATES

No.	Plate	Name
175686	22860	Feed Plate with two 175590, for sewing 40 to 80 ligne two and four hole flat buttons close to the material..
175687	22860	Feed Plate with two 175590, for sewing 80 to 120 ligne two and four hole flat buttons close to the material..
175683	-----	Feed Plate with two 175590 and three 5790, for 175682.....

FEED PLATES

No.	Plate	Name
175690	22860	Feed Plate 175753 with 175690 and two 50090J, for sewing 20 to 45 ligne two and four hole flat buttons away from the material with a blind stitch.....
5790	22857	Feed Plate Rivet for 175753 (3).....
175690	22852	" " Stud for 175689, 175697 and 175753 (2).....
175690	22860	Feed Plate Work Support for 175690.....
50090J	22857	" " " " Adjusting Screw for 175689.....
50090J	22857	Feed Plate Work Support Screw for 175689

STAY BUTTON HOLDERS

No.	Plate	Name
175693	22860	Stay Button Holder with two 175690 (18 ligne stay button) for sewing two and four hole flat buttons either close or away from the material.....
175694	-----	Stay Button Holder with two 175690 (19 ligne stay button) for sewing two and four hole flat buttons either close or away from the material.....
175695	-----	Stay Button Holder with two 175690 (20 ligne stay button) for sewing two and four hole flat buttons either close or away from the material.....
175696	-----	Stay Button Holder with two 175690 (22 ligne stay button) for sewing two and four hole flat buttons either close or away from the material.....
175701	22860	Stay Button Holder (18 ligne stay button) for 175709.....
175702	-----	Stay Button Holder (19 ligne stay button) for 175709.....
175703	-----	Stay Button Holder (20 ligne stay button) for 175707.....
175704	-----	Stay Button Holder (21 ligne stay button) for 175709.....
175705	-----	Stay Button Holder 175701 with 228J, 230J and 175709 (19 ligne stay button) for sewing metal eyelet or leather shank buttons.....
175706	-----	Stay Button Holder 175704 with 228J, 230J and 175709 (19 ligne stay button) for sewing metal eyelet or leather shank buttons.....

STAY BUTTON HOLDERS

No.	Plate	Name
175707	-----	Stay Button Holder 175703 with 228J, 230J and 175709 (20 ligne stay button) for sewing metal eyelet or leather shank buttons.....
175708	-----	Stay Button Holder 175704 with 228J, 230J and 175709 (22 ligne stay button) for sewing metal eyelet or leather shank buttons.....
230J	21901	Stay Button Holder Adjusting Screw for 175705 to 175708.....
175709	22860	Stay Button Holder Plate with two 175599, for 175703 to 175708.....
175709	22852	Stay Button Holder Plate Stud for 175709 (2).....
228J	21906	Stay Button Holder Screw for 175705 to 175708.....
175690	22852	Stay Button Holder Stud for 175693 to 175696 (2).....

WORK SUPPORTS

No.	Plate	Name
175713	22860	Work Support for 175715.....
175714	22860	" " for 175716.....
175715	-----	" " 175713 with 228J, 230J and 175709, for sewing metal eyelet or leather shank buttons with a through and through stitch.....
175716	-----	Work Support 175714 with 228J, 230J and 175691, for sewing metal eyelet or self-shank buttons with a blind stitch.....
230J	21901	Work Support Adjusting Screw.....
175709	22860	" " Plate with two 175599, for 175715.....
175691	22860	Work Support Plate with two 175599, for 175716.....
175599	22852	Work Support Plate Stud (2).....
228J	21906	" " Screw.....

ACCESSORIES

No.	Plate	Name
175193	21929	Button Tray with three 175194.....
175194	21929	" " Hinge Screw Stud (3).....
169C	21906	" " " " Set Screw for 175629.....

ACCESSORIES

No.	Plate	Name
120342	21929	Oiler (copper plated) with 120343.....
120343	21929	" Spout, 3 1/2 in. long.....
26026	21929	Screw Driver.....
175197	21929	Wrench for 140026.....
175198	21929	" " 140027.....
175625	21929	" " 140024.....

BELT AND PULLEY GUARD

(HINGED)

No.	Plate	Name
175537	21932	Belt and Pulley Guard.....
175538	21932	" " " " Fill-in Piece (metal) with two wood screws 3/4 in. No. 10 R.H., for Trough Power Table.....
175539	21932	Belt and Pulley Guard Fill-in Piece (wood) with four wood screws 1 1/2 in. No. 12 F.H., for Flat Power Table.....
175540	-----	Belt and Pulley Guard complete, for Individual Motor Table and for 175544, Nos. 42830, 175537, 175543 and two wood screws 1 in. No. 14 F.H.....
175541	21932	Belt and Pulley Guard Hinge Pin.....
175542	21932	" " " " " " Bracket
175543	21932	" " " " " " " 175542 with 175541.....
42830	21907	Belt and Pulley Guard Hinge Pin Cotter Pin.....
175544	-----	Belt and Pulley Guard with Fill-in Pieces complete, Nos. 175538 to 175540.....

MACHINE BASE

No.	Plate	Name
175829	-----	Machine Base with 160C.....
175830	23333	Machine Base complete, Nos. 141C, 933F, 1637J, 140047C, 175425, 175829, 175831, 175832 and four wood screws 7/8 in. No. 14 R.H.....
140047C	23332	Machine Locating Screw Stud.....
175115	23332	" Lock Plate with 175202 and 175206.....

MACHINE BASE

No.	Plate	Name
175202	23332	Machine Lock Plate Position Stud.....
51656J	23332	" " Thumb Nut.....
175206	23332	" " " " Screw Stud.....
175207	23332	" " " " Spring.....
175536	23332	" " " " Washer.....
175425	-----	Machine Lock complete, Nos. 51656J, 175115, 175207 and 175536.....
175831	23332	Machine Starting Lever.....
933F	23332	" " " " Hinge Screw.....
175832	23332	" " " " Spring.....
141C	23332	" " " " Stop Screw.....
1637J	23332	" " " " " " Nut...

STARTING LEVER

AND

FOOT LIFTER PARTS

No.	Plate	Name
175215	-----	Foot Lifter Chain, 37 in. long, with two 56865.....
56865	23327	Foot Lifter Chain Hook (2).....
175216	23333	" " Treadle.....
175217	23333	" " " " Hinge Pin.....
175218	23333	" " " " Stand.....
175219	23333	Foot Lifter Treadle complete, Nos. 175216 to 175218 and two wood screws 1 in. No. 14 F.H.....
175215	-----	Starting Lever Chain, 37 in. long, with two 56865.....
56865	23327	Starting Lever Chain Hook (2).....
175216	23333	" " Treadle.....
175217	23333	" " " " Hinge Pin.....
175218	23333	" " " " Stand.....
175219	23333	Starting Lever Treadle complete, Nos. 175216 to 175218 and two wood screws 1 in. No. 14 F.H.....

TABLE BELT GUIDE

No.	Plate	Name
175220	23333	Belt Guide (left) with 140035C.....
175221	23333	" " (right) with 140035C.....

No.	Plate	Name
140035C	21941	Belt Guide Set Screw (2).....
175222	23333	Pulley (2).....
175223	-----	" Shaft.....
175224	23333	" " 175223 with 1259AL and 175227
175225	23333	" " Bracket with 444C.....
1259AL	21906	" " Oil Plug Screw.....
175227	23333	" " Wick.....
444C	22852	" " Set Screw.....
175228	23333	Table Belt Guide complete, Nos. 175220, 175221, 175224, 175225 and two each 175222 and wood screws 7/8 in. No. 14 R.H.....

THREAD UNWINDER

(FOR ONE SPOOL)

No.	Plate	Name
225259	21933	Spool Rest with 201018C.....
150203	21933	" " Cushion (felt).....
225388	21933	" " Rod.....
200383C	23327	" " " Set Screw.....
201018C	23327	" " Set Screw.....
202490	21933	" Stand with 200383C.....
225391	21933	Thread Guide.....
201696J	23327	" " Lock Nut.....
225326	-----	" " Position Cup.....
225324	21933	" " Rod with 208E and 225322...
208E	23327	" " " Screw.....
225322	23327	" " Washer.....
225260	21933	Thread Unwinder complete, Nos. 150203, 201696J, 202490, 225259, 225324, 225326, 225388, 225391 and three wood screws 7/8 in. No. 12 F.H.....
27739	21933	Thread Cone (wood) for large cones.....
225390	21933	" " Holder, for inverted cones..

Note: Nos. 27739 and 225390 are used with, but not included in 225260.

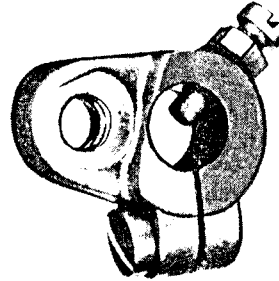
NUMERICAL LIST OF PARTS

No.	Plate	Name
120J	21903	Face Plate Screw (2).....
127J	21903	Feed Cam Screw (2).....
134E	21940	Needle Bar Eccentric Pawl Bracket Screw.
141C	23332	Machine Starting Lever Stop Screw for 175830.....
160J	21906	Button Clamp Arm Hinge Pin Bracket Screw (2).....
160E	21906	Button Clamp Lifting Rod Arm Clamping Screw for 175048.....
160J	21906	Button Clamp Lifting Rod Arm Stop Plate Screw (2).....
160C	21906	Button Clamp Lifting Rod Spring Stop Collar Set Screw for 175051.....
160C	21906	Button Tray Hinge Screw Stud Set Screw for 175829.....
160J	21906	Feed Plate Carrier Regulator Spring Screw (bed end).....
160E	21906	Needle Bar Connecting Link Hinge Stud Clamping Screw for 175810.....
160J	21906	Stop Motion Retaining Collar Screw.....
160J	21906	" " Trip Screw (2).....
160J	21906	Thread Nipper Plate Screw.....
160C	21906	" Pull-off (back) Holder Set Screw for 175187.....
160C	21906	Thread Pull-off Stop Collar Set Screw for 175191.....
185J	21903	Face Plate Thread Guide (lower) Plate Screw for 175772.....
190K	21906	Button Clamp Lifting Chain Bracket Set Screw for 175647.....
190K	21906	Button Clamp Lifting Chain Screw (lower) for 175647.....
190K	21906	Button Clamp Lifting Chain Screw (upper) for 175041.....
190J	21906	Button Clamp Lifting Chain Screw (upper) Lock Screw for 175041.....
190J	21906	Feed Plate Carrier Guide Block (left) Screw (2).....
190J	21906	Feed Plate Carrier Guide Block (right) Screw (2).....
191J	22857	Button Holder Screw for 175684.....
208E	23327	Thread Unwinder Thread Guide Rod Screw for 225324.....
218D	21941	Needle Guide Thread Finger Screw for 175546 (2).....
223J	22857	Button Clamp Opening Handle Screw for 175749 (2).....

No.	Plate	Name
175820	23332	Pulley J11 Wick for 175140, 175634 and 175636.....
*175825	-----	Bed.....
175829	-----	Machine Base with 1600, for 175830.....
175830	23333	Machine Base complete, Nos. 141C, 933F, 1637J, 140047C, 175425, 175829, 175831, 175832 and four wood screws 7/8 in. No. 14 R.H.....
175831	23332	Machine Starting Lever for 175830.....
175832	23332	" " " Spring for 175830.....
175852	-----	Button Clamp 175304 with 680W, 175831, 175806, two 140024C and three 175832, for sewing 20 to 45 ligne two and four hole heavy flat buttons close to the material either with a through and through stitch or using a stay button.....
200125F	22854	Needle Set Screw for 175396.....
200383C	23327	Thread Unwinder Spool Rest Rod Set Screw for 202490.....
201018C	23327	Thread Unwinder Spool Rest Set Screw for 225259.....
201696J	23327	Thread Unwinder Thread Guide Lock Nut for 225260.....
202099	21903	Face Plate Thread Guide (lower) Roller for 175772.....
202490	21933	Thread Unwinder Spool Stand with 200383C, for 225260.....
225259	21933	Thread Unwinder Spool Rest with 201018C, for 225260.....
225260	21933	Thread Unwinder complete, for one spool, Nos. 150203, 201696J, 202490, 225259, 225324, 225326, 225333, 225391 and three wood screws 7/8 in. No. 14 R.H.....
225322	23327	Thread Unwinder Thread Guide Rod Washer for 225324.....
225324	21933	Thread Unwinder Thread Guide Rod with 208E and 225322, for 225260.....
225326	-----	Thread Unwinder Thread Guide Position Cup for 225260.....
225388	21933	Thread Unwinder Spool Rest Rod for 225260.....
225390	21933	Thread Unwinder Thread Cone Holder, for inverted cones, for use with No. 225260.....
225391	21933	Thread Unwinder Thread Guide for 225260.....

PLATE 21901 - FULL SIZE

175005
Page 5



175008
Page 6



1177
Page 5



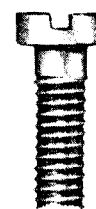
140016
Page 5



140017
Page 6



670
Page 6



175007
Page 6



175002
Page 5



175016
Page 6



230
Page 6



1521
Page 6



51650
Page 6



51649
Page 6



175014
Page 6

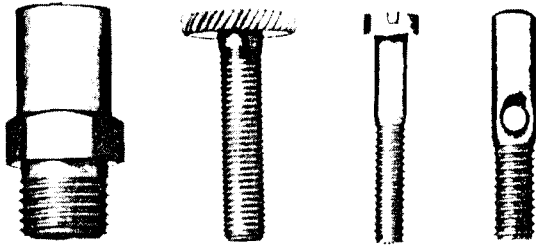


175015
Page 6

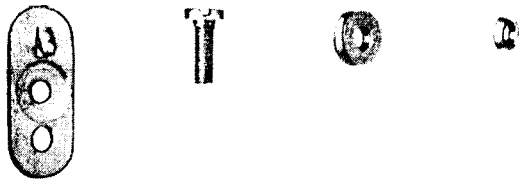


PLATE 21903 - FULL SIZE

175054 140023 120 175066



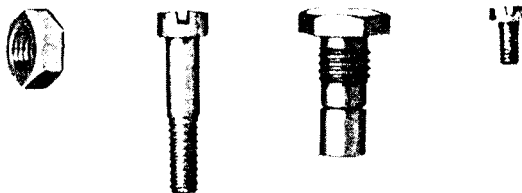
175062 135 202098 175063



175065 1472 140026 175069



1722 127 51923 197



175573

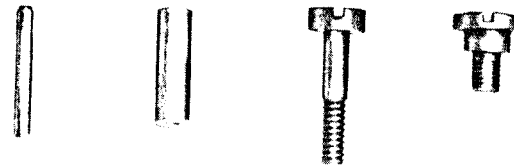


175058

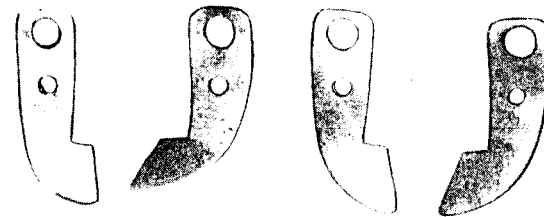


PLATE 21906 - FULL SIZE

175017 175019 140018 140020



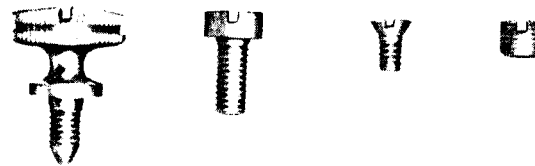
175071 175072 175026 175030



1498 140021 228 175032



680 160 140019 1259



190 50269 140025 140024 175622

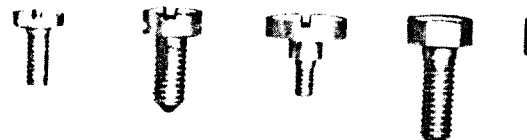
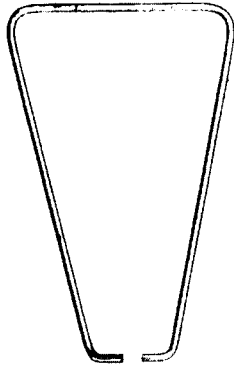
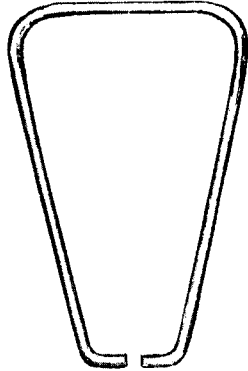


PLATE 21907 - FULL SIZE

175040



175303



175044



175046



175045



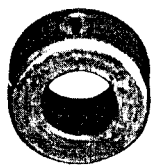
458



42830



175053



175049



175051

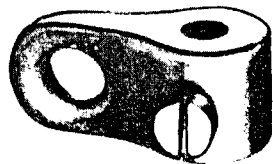
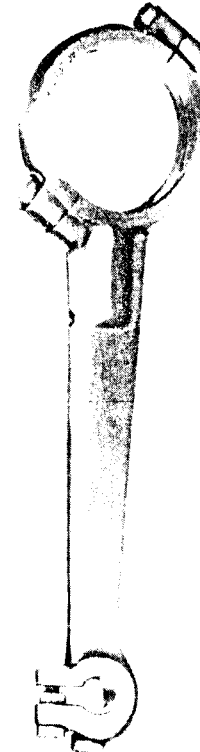


PLATE 21919 - ONE - HALF SIZE

175142



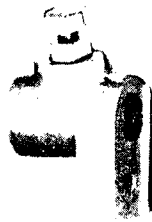
175146



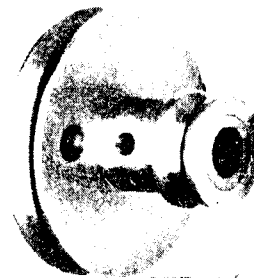
175148



175140



175140



175148

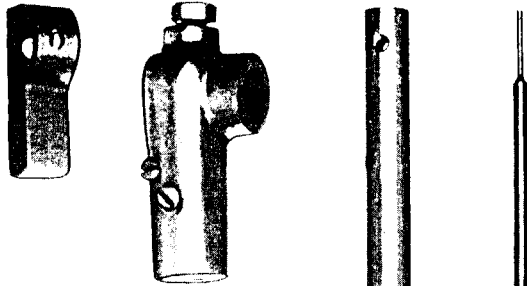


175126

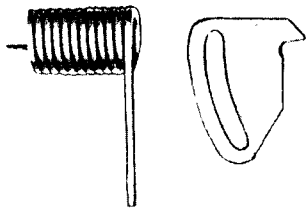


PLATE 21920 - ONE - HALF SIZE

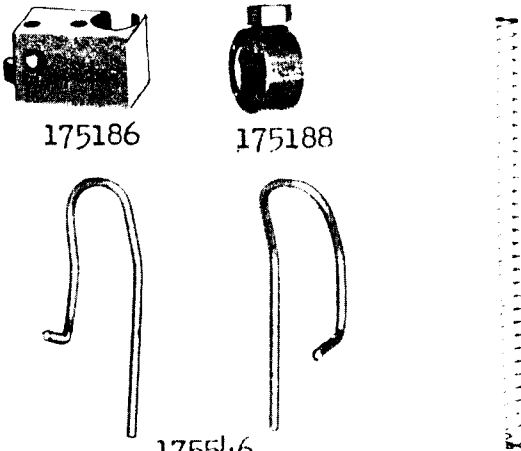
175150 175152 175155 175163



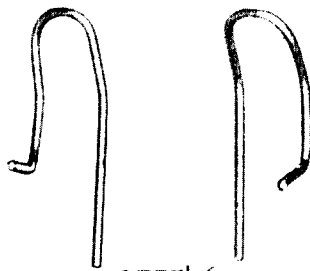
175156 175158



175159 175157 175164



175186 175188

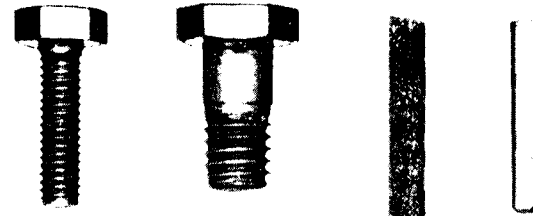


175546

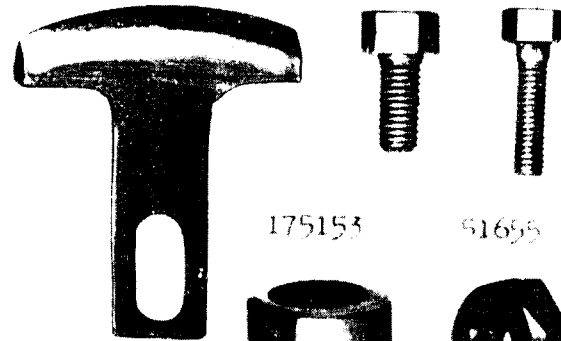


PLATE 21921 - FULL SIZE

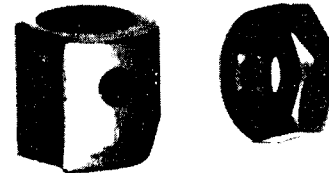
175145 175147 175148 175149



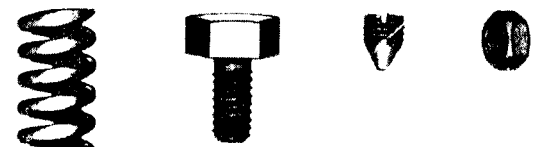
175145 175148 175149



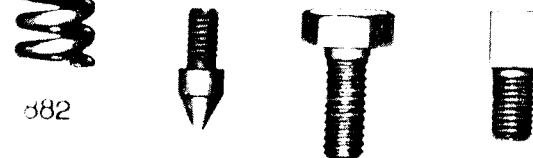
175153 81655



175151 175141 175140 17517



175229 50581 175154



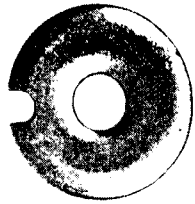
175229

50581

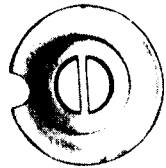
175154

PLATE 21922 - FULL SIZE

175160



175522



1382



175161



175165



140033



175171



175167



175172



140043



140044



125314



13710



175162

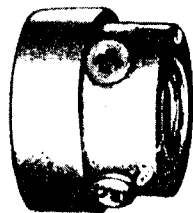


PLATE 21923 - FULL SIZE

175173



175174



175175



140045



175176



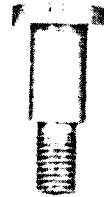
175181



175179



175177



175182



465



175184



175183



175175



175185

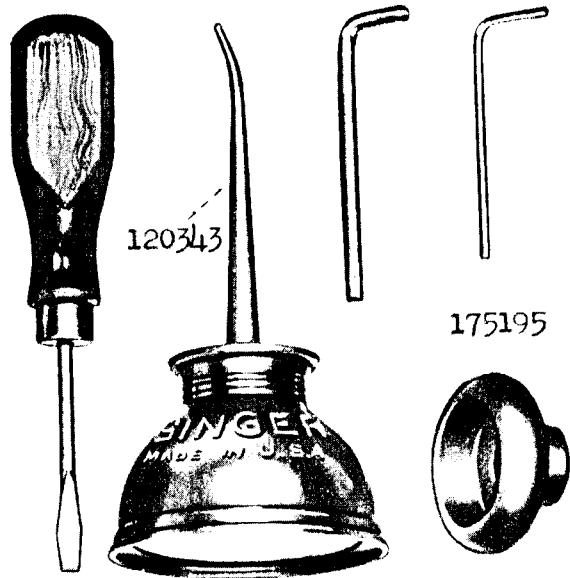


175176



PLATE 21929 - ONE-HALF SIZE

26026 120342 175197 175198



175194

175625



175193

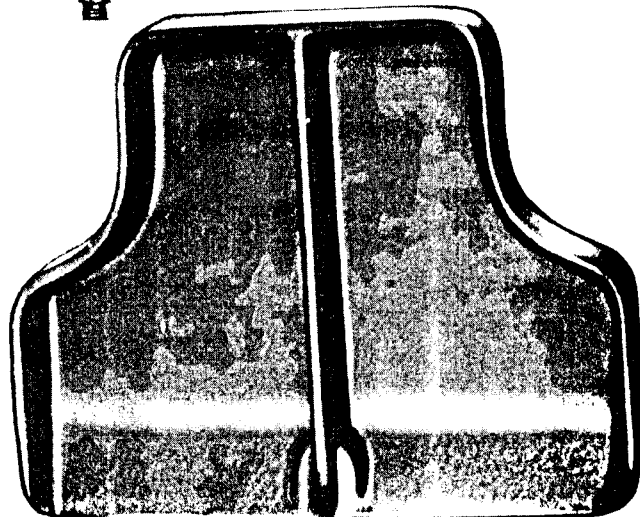
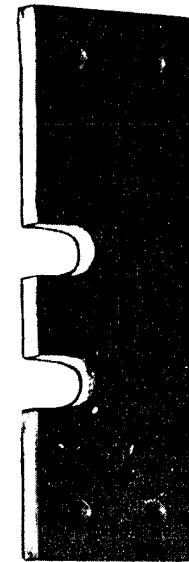
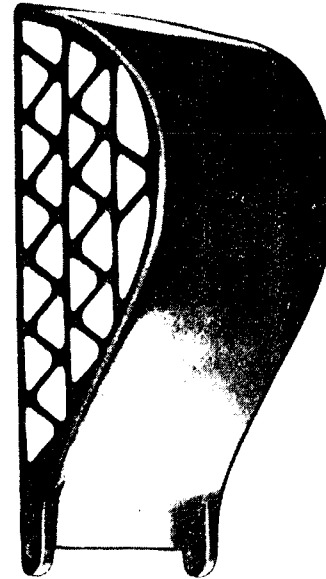


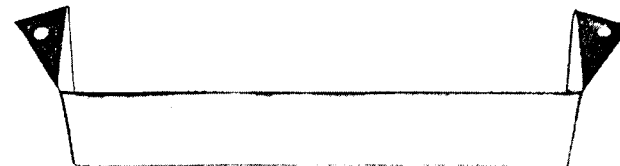
PLATE 21932 - ONE-FOURTH SIZE

175537

175539



175538



175543



175542

175541

PLATE 21933 - ONE-FOURTH SIZE

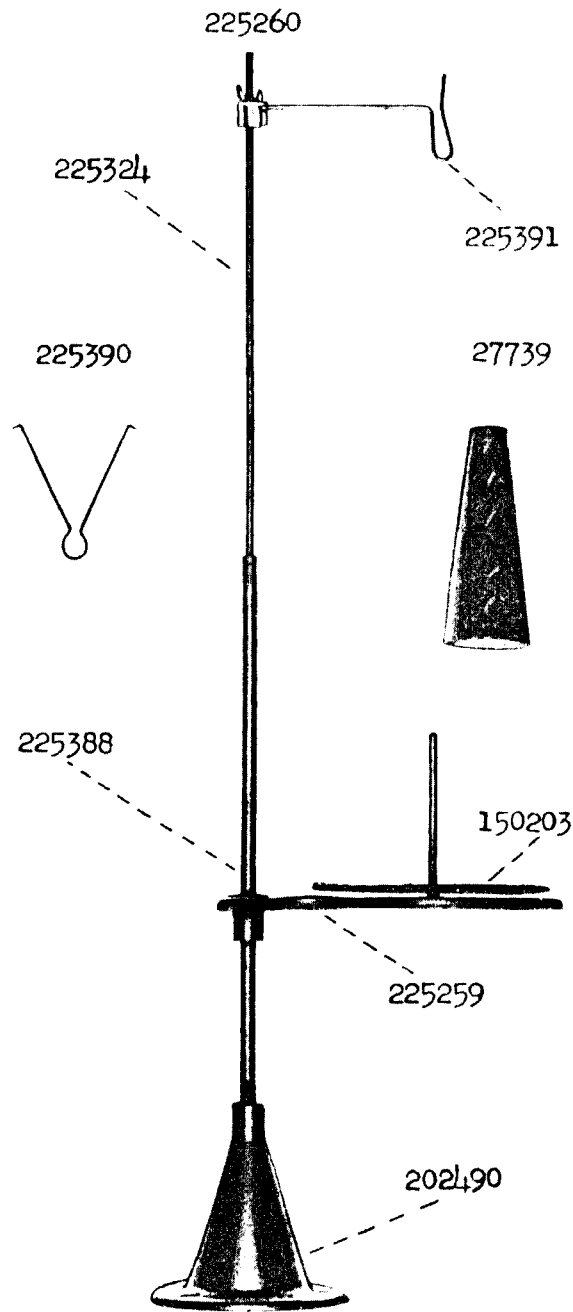


PLATE 21940 - FULL SIZE

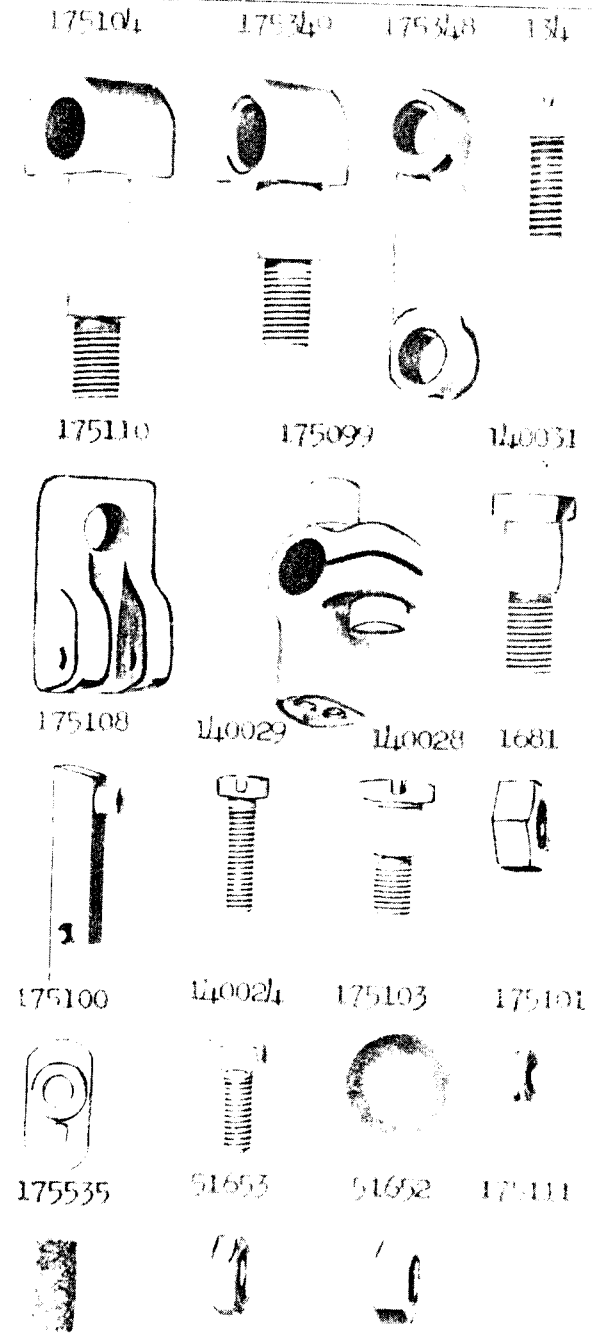


PLATE 21941 - FULL SIZE

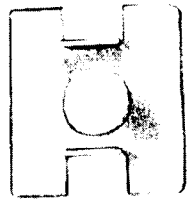
51654



175758



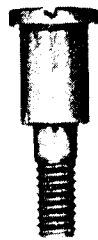
175759



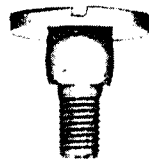
175123



140042



140043



175127



140035



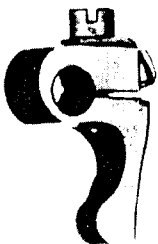
175131



140159



175132



175134



175135



175094



175547



213



175130

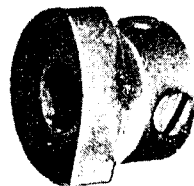


PLATE 22100 - ONE-HALF SIZE

175010 175011 175031

175396 175071



175013



175018

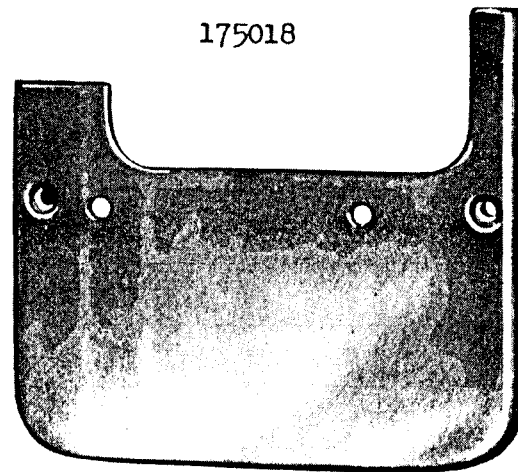
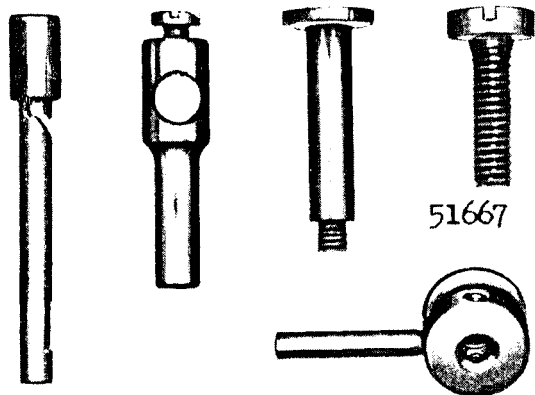
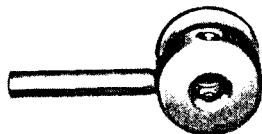


PLATE 22852 - FULL SIZE

175775 175732 175733 51183



51667



175089 175078 175548 175549



175085

175796

624

227



435

1285

203

175590

175079



444

175774

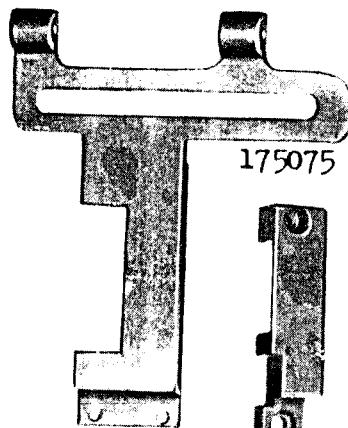
175773



PLATE 22853 - ONE-HALF SIZE

175073

175087



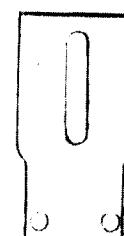
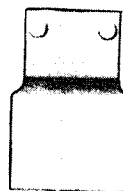
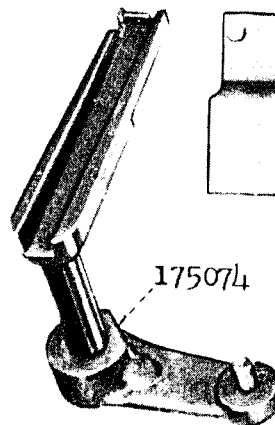
175075

175076

175086



175627 175589 175692 175083 175093



175105

175525

175529

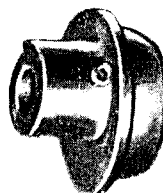
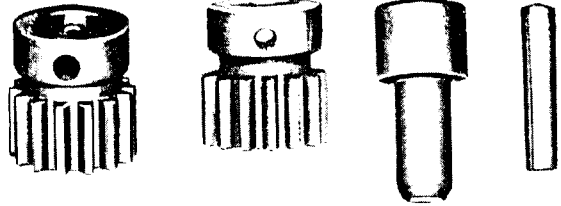
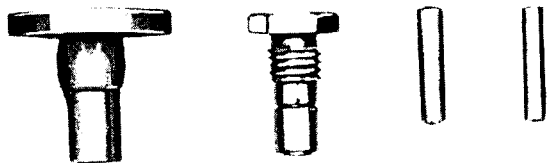


PLATE 22854 - FULL SIZE

175091 175143 175096 175119



175757 51923 175092 175112



175144 1341 175113 175114



1492 200125 140027 1259

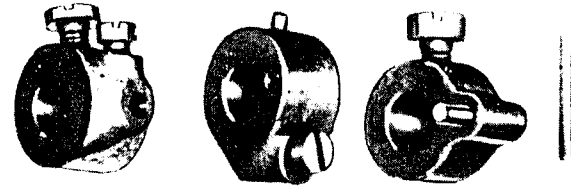


1681 51652 1722 175103

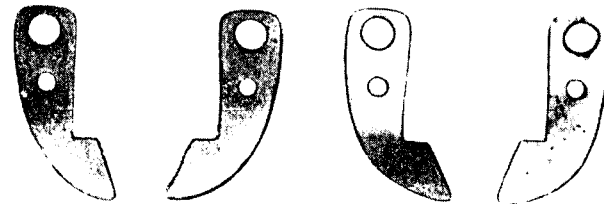


PLATE 22855 - FULL SIZE

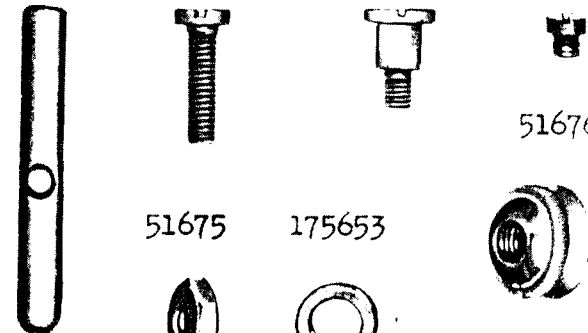
175187 175189 175191 175161



175420 175518 175571 175572

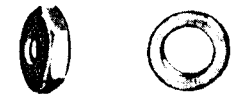


175167 140151 140152 140153



51676

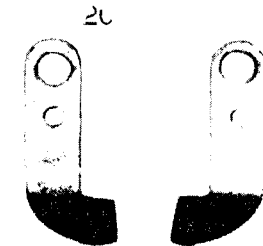
51675 175653



1120

175639

175642



175192



175190

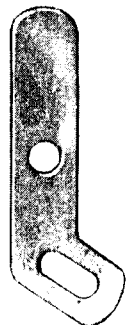


PLATE 22857 - FULL SIZE

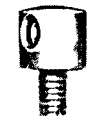
175670 175669 175648 175673



175647



175652



1656



140160



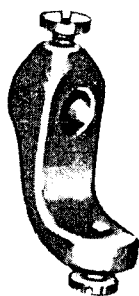
175674



175675



140154



140072

401



5790



191



1562



50603



50090



223



22436



PLATE 22859 - FULL SIZE

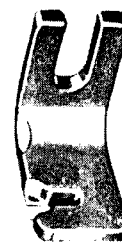
175383 175392 175393



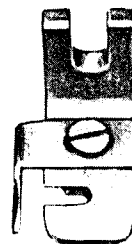
175398



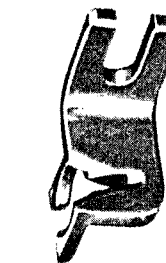
175677



175681



175399



175676



175678



175682

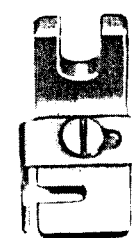
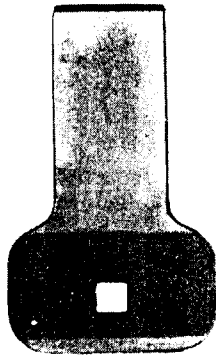


PLATE 22860 - ONE-HALF SIZE

175686



175689



175701



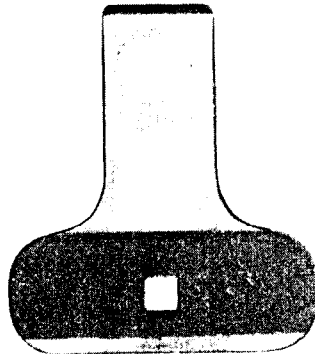
175713



175714



175687



175690



175709



175801

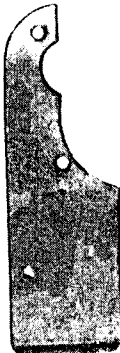
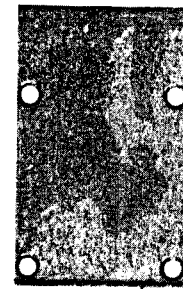


PLATE 23326 - ONE-HALF SIZE

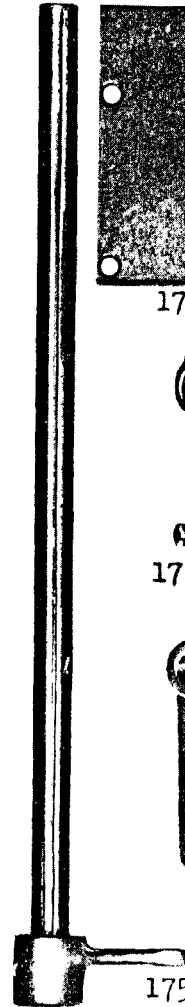
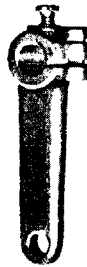
175340 175020 175043 175806 175047



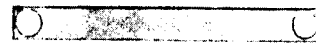
175041



175048



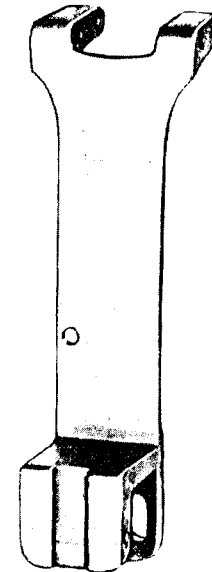
175036



175035



175034



175813



51224

175814

175022

175028

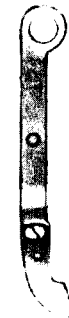
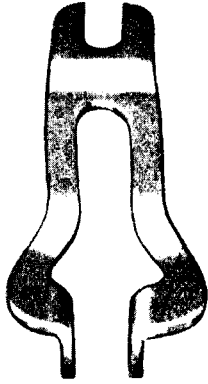


PLATE 23327 - FULL SIZE

175111



56865



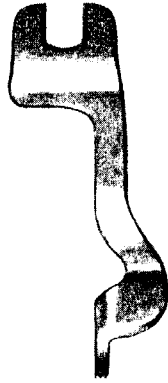
140068



1448



175401



201696



1036



140067 200383



225322



201018



208



PLATE 23328 - ONE-HALF SIZE

175050



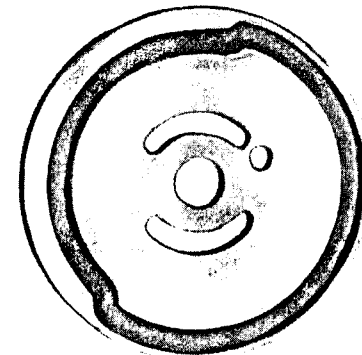
175365



175055



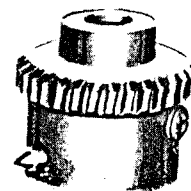
175293



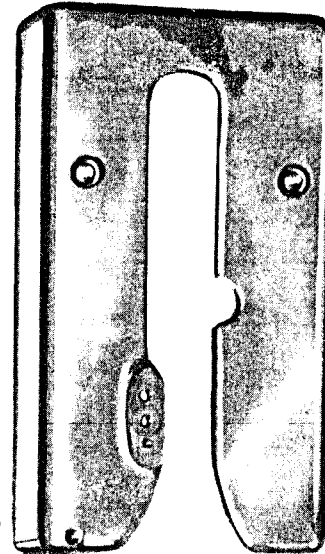
175294



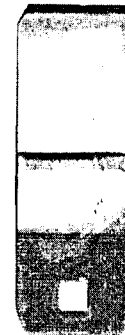
175295



175771



175685



175056

175057

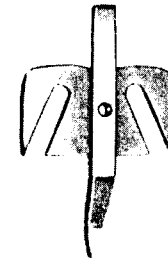
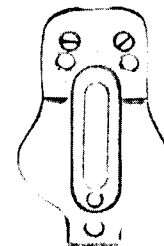
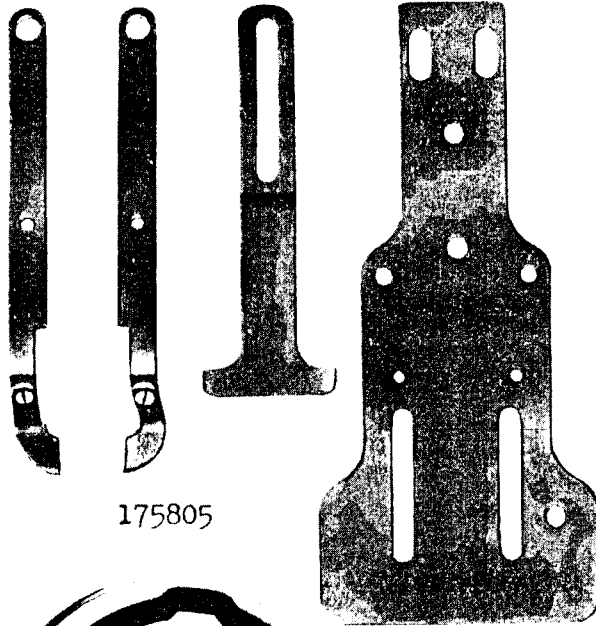
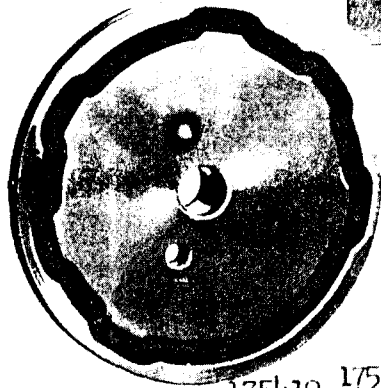


PLATE 23329 - ONE-HALF SIZE

175638 175641 175644 175643

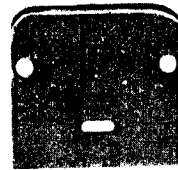


175805



175419 175517 175720 175723

175483



175756

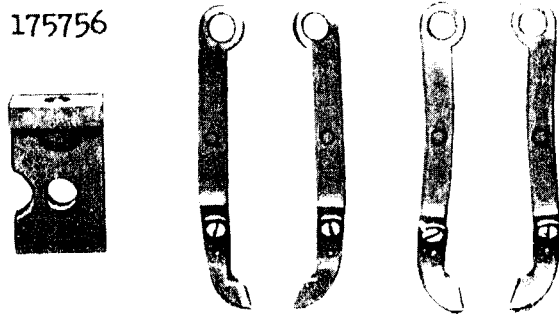
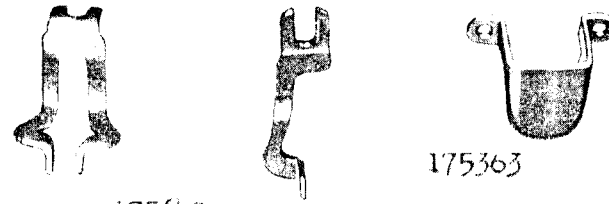


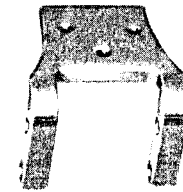
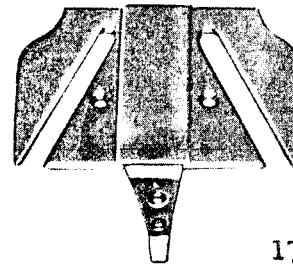
PLATE 23330 - ONE-HALF SIZE

175764 175786 175750



175649

175363

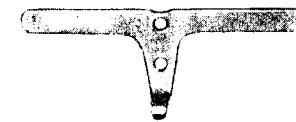


175650

175646

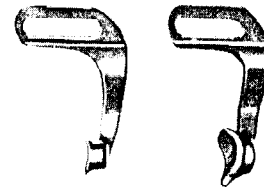
175651

175807



175667

175668



175747



175797

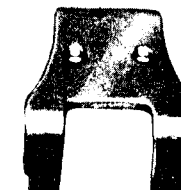
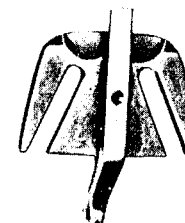
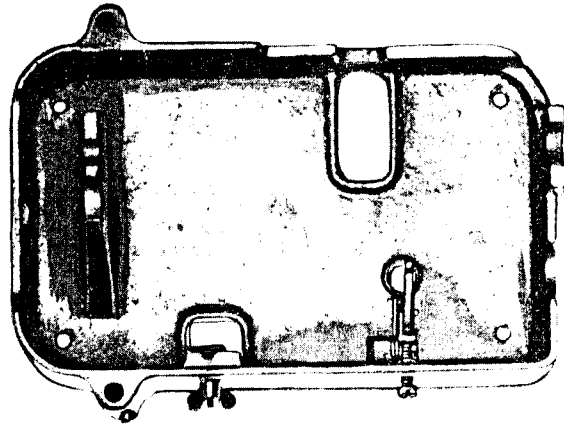


PLATE 23333 - ONE-FOURTH SIZE

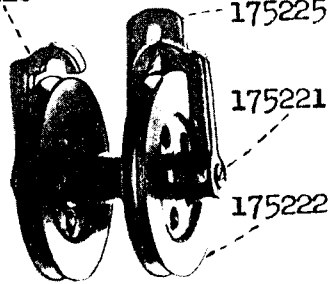
175830



175228

175219

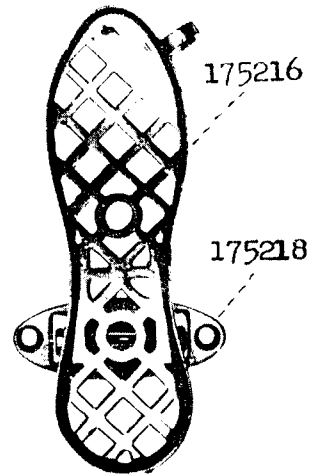
175220



175225

175221

175222



175216

175218

175227



175224

175217